

FCC Radio Test Report

FCC ID: Q78-ZXHNF670E

This report concerns (check one): Original Grant Class I Change Class II Change

Project No. : 1708C103
Equipment : GPON ONT
Test Model : ZXHN F670E
Series Model : N/A
Applicant : ZTE Corporation
Address : ZTE Plaza, Hi-Tech Park, Nanshan District,
Shenzhen, Guangdong, P.R.China

Date of Receipt : Aug. 18, 2017
Date of Test : Aug. 18, 2017 ~ Feb. 28, 2018
Issued Date : Mar. 09, 2018
Tested by : BTL Inc.

Testing Engineer : Paul Li
(Paul Li)

Technical Manager : Shawn Xiao
(Shawn Xiao)

Authorized Signatory : David Mao
(David Mao)

B T L I N C .

No.3, Jinshagang 1st Road, Shixia, Dalang Town, Dongguan,
Guangdong, China.

TEL: +86-769-8318-3000 FAX: +86-769-8319-6000



Declaration

BTL represents to the client that testing is done in accordance with standard procedures as applicable and that test instruments used has been calibrated with standards traceable to international standard(s) and/or national standard(s).

BTL's reports apply only to the specific samples tested under conditions. It is manufacture's responsibility to ensure that additional production units of this model are manufactured with the identical electrical and mechanical components. **BTL** shall have no liability for any declarations, inferences or generalizations drawn by the client or others from **BTL** issued reports.

BTL's report must not be used by the client to claim product certification, approval, or endorsement by NVLAP, NIST, or any agency of the Federal Government.

This report is the confidential property of the client. As a mutual protection to the clients, the public and **BTL-self**, extracts from the test report shall not be reproduced except in full with **BTL's** authorized written approval.

BTL's laboratory quality assurance procedures are in compliance with the **ISO Guide 17025** requirements, and accredited by the conformity assessment authorities listed in this test report.

Limitation

For the use of the authority's logo is limited unless the Test Standard(s)/Scope(s)/Item(s) mentioned in this test report is (are) included in the conformity assessment authorities acceptance respective.

Table of Contents	Page
1 . CERTIFICATION	6
2 . SUMMARY OF TEST RESULTS	7
2.1 TEST FACILITY	8
2.2 MEASUREMENT UNCERTAINTY	8
3 . GENERAL INFORMATION	9
3.1 GENERAL DESCRIPTION OF EUT	9
3.2 DESCRIPTION OF TEST MODES	12
3.3 TABLE OF PARAMETERS OF TEST SOFTWARE SETTING	14
3.4 BLOCK DIAGRAM SHOWING THE CONFIGURATION OF SYSTEM TESTED	15
3.5 DESCRIPTION OF SUPPORT UNITS	15
4 . EMC EMISSION TEST	16
4.1 CONDUCTED EMISSION MEASUREMENT	16
4.1.1 POWER LINE CONDUCTED EMISSION	16
4.1.2 TEST PROCEDURE	16
4.1.3 DEVIATION FROM TEST STANDARD	16
4.1.4 TEST SETUP	17
4.1.5 EUT OPERATING CONDITIONS	17
4.1.6 EUT TEST CONDITIONS	17
4.1.7 TEST RESULTS	17
4.2 RADIATED EMISSION MEASUREMENT	18
4.2.1 RADIATED EMISSION LIMITS	18
4.2.2 TEST PROCEDURE	19
4.2.3 DEVIATION FROM TEST STANDARD	19
4.2.4 TEST SETUP	19
4.2.5 EUT OPERATING CONDITIONS	20
4.2.6 EUT TEST CONDITIONS	20
4.2.7 TEST RESULTS (9K TO 30MHz)	21
4.2.8 TEST RESULTS (BETWEEN 30 TO 1000 MHz)	21
4.2.9 TEST RESULTS (ABOVE 1000 MHz)	21
5 . 26dB SPECTRUM BANDWIDTH	22
5.1 APPLIED PROCEDURES / LIMIT	22
5.1.1 TEST PROCEDURE	22
5.1.2 DEVIATION FROM STANDARD	22
5.1.3 TEST SETUP	22
5.1.4 EUT OPERATION CONDITIONS	22
5.1.5 EUT TEST CONDITIONS	23
5.1.6 TEST RESULTS	23
6 . MAXIMUM CONDUCTED OUTPUT POWER	24

Table of Contents	Page
6.1 APPLIED PROCEDURES / LIMIT	24
6.1.1 TEST PROCEDURE	24
6.1.2 DEVIATION FROM STANDARD	25
6.1.3 TEST SETUP	25
6.1.4 EUT OPERATION CONDITIONS	25
6.1.5 EUT TEST CONDITIONS	25
6.1.6 TEST RESULTS	25
7 . POWER SPECTRAL DENSITY TEST	26
7.1 APPLIED PROCEDURES / LIMIT	26
8.1.1 TEST PROCEDURE	26
7.1.1 DEVIATION FROM STANDARD	27
7.1.2 TEST SETUP	27
7.1.3 EUT OPERATION CONDITIONS	27
7.1.4 EUT TEST CONDITIONS	27
7.1.5 TEST RESULTS	27
8 . FREQUENCY STABILITY MEASUREMENT	28
8.1 APPLIED PROCEDURES / LIMIT	28
8.1.1 TEST PROCEDURE	28
8.1.2 DEVIATION FROM STANDARD	28
8.1.3 TEST SETUP	29
8.1.4 EUT OPERATION CONDITIONS	29
8.1.5 EUT TEST CONDITIONS	29
8.1.6 TEST RESULTS	29
9 . MEASUREMENT INSTRUMENTS LIST	30
10 . EUT TEST PHOTOS	32
APPENDIX A - CONDUCTED EMISSION	40
APPENDIX B - RADIATED EMISSION (9KHZ TO 30MHZ)	53
APPENDIX C - RADIATED EMISSION (30MHZ TO 1000MHZ)	78
APPENDIX D - RADIATED EMISSION (ABOVE 1000MHZ)	151
APPENDIX E - BANDWIDTH	406
APPENDIX F - MAXIMUM OUTPUT POWER	430
APPENDIX G - POWER SPECTRAL DENSITY	443
APPENDIX H - FREQUENCY STABILITY	515

REPORT ISSUED HISTORY

Issued No.	Description	Issued Date
BTL-FCCP-3-1708C103	Original Issue.	Mar. 09, 2018

1. CERTIFICATION

Equipment : GPON ONT
Brand Name : ZTE 中兴, ZTE
Test Model : ZXHN F670E
Series Model : N/A
Applicant : ZTE Corporation
Manufacturer : ZTE Corporation
Address : ZTE Plaza, Hi-Tech Park, Nanshan District, Shenzhen, Guangdong, P.R.China
Factory : ZTE Corporation
Address : ZTE Plaza, Hi-Tech Park, Nanshan District, Shenzhen, Guangdong, P.R.China
Date of Test : Aug. 18, 2017 ~ Feb. 28, 2018
Test Sample : Engineering Sample
Standard(s) : FCC Part15, Subpart E(15.407) / ANSI C63.10-2013

The above equipment has been tested and found compliance with the requirement of the relative standards by BTL Inc.

The test data, data evaluation, and equipment configuration contained in our test report (Ref No. BTL-FCCP-3-1708C103) were obtained utilizing the test procedures, test instruments, test sites that has been accredited by the Authority of NVLAP according to the ISO-17025 quality assessment standard and technical standard(s).

Test results included in this report is only for the UNII-2A and UNII-2C part.

2. SUMMARY OF TEST RESULTS

Test procedures according to the technical standard(s):

FCC Part15, Subpart E(15.407)			
Standard(s) Section	Test Item	Judgment	Remark
15.207	AC Power Line Conducted Emissions	PASS	
15.407(a)	26dB Spectrum Bandwidth	PASS	
15.407(a)	Maximum Conducted Output Power	PASS	
15.407(a)	Power Spectral Density	PASS	
15.407(a)	Radiated Emissions	PASS	
15.407(b)	Band Edge Emissions	PASS	
15.407(g)	Frequency Stability	PASS	
15.203	Antenna Requirements	PASS	

NOTE:

(1) "N/A" denotes test is not applicable in this test report.

2.1 TEST FACILITY

The test facilities used to collect the test data in this report is at the location of No.3,Jinshagang 1st Road, Shixia, Dalang Town, Dongguan, Guangdong, China.

BTL's test firm number for FCC: 854385

BTL's designation number for FCC: CN5020

2.2 MEASUREMENT UNCERTAINTY

The measurement uncertainty figures shall be calculated according the methods described in the ETSI TR 100 028 and shall correspond to an expansion factor (coverage factor) $k=1.96$ or $k=2$ (which provide confidence levels of respectively 90% and 95.45% in the case where the distributions characterizing the actual measurement uncertainties are normal (Gaussian)). Measurement Uncertainty for a Level of Confidence of 95 %, $U=2xUc(y)$.

The BTL measurement uncertainty as below table:

A. Conducted Measurement:

Test Site	Method	Measurement Frequency Range	U, (dB)
DG-C02	CISPR	150 KHz ~ 30MHz	2.32

B. Radiated Measurement:

Test Site	Method	Measurement Frequency Range	Ant. H / V	U, (dB)
DG-CB03	CISPR	9kHz~30MHz	V	3.79
		9kHz~30MHz	H	3.57
		30MHz ~ 200MHz	V	3.82
		30MHz ~ 200MHz	H	3.60
		200MHz ~ 1,000MHz	V	3.86
		200MHz ~ 1,000MHz	H	3.94
		1GHz~18GHz	V	3.12
		1GHz~18GHz	H	3.68
		18GHz~40GHz	V	4.15
		18GHz~40GHz	H	4.14

Note: Unless specifically mentioned, the uncertainty of measurement has not been taken into account to declare the compliance or non-compliance to the specification.

3. GENERAL INFORMATION

3.1 GENERAL DESCRIPTION OF EUT

Equipment	GPON ONT	
Brand Name	ZTE 中兴, ZTE	
Test Model	ZXHN F670E	
Series Model	N/A	
Model Difference	The type of ZXHN F670E has internal antenna model and external antenna model.	
Product Description	Operation Frequency	UNII-2A: 5250-5350MHz UNII-2C: 5470-5725MHz
	Modulation Type	OFDM
	Bit Rate of Transmitter	867Mbps
	Output Power (Max.)for UNII-2A	802.11a: 21.22dBm 802.11n (20M): 22.72dBm 802.11n (40M): 21.93dBm 802.11ac (20M): 22.32dBm 802.11ac (40M): 22.89dBm 802.11ac (80M): 18.34dBm
	Output Power (Max.)for UNII-2C	802.11a: 21.34dBm 802.11n (20M): 22.41dBm 802.11n (40M): 19.42dBm 802.11ac (20M): 22.45dBm 802.11ac (40M): 23.13dBm 802.11ac (80M): 19.59dBm
Power Source	DC Voltage supplied from AC/DC adapter. Model: 1. RD1202000-C55-29MG 2. RD1201500-C55-81MG 3. RD1201500-C55-24MG	
Power Rating	1. I/P: 100-240V~ 50/60Hz 0.6A O/P: 12V---2.0A 2. I/P: 100-240V~ 50/60Hz 0.6A MAX O/P: 12V---1.5A 3. I/P: 100-240V~ 50/60Hz 0.6A MAX O/P: 12V---1.5A	

Note:

1. For a more detailed features description, please refer to the manufacturer's specifications or the user's manual.
2. Channel List:

802.11a 802.11n 20MHz 802.11ac 20MHz		802.11n 40MHz 802.11ac 40MHz		802.11ac 80MHz	
UNII-2A		UNII-2A		UNII-2A	
Channel	Frequency (MHz)	Channel	Frequency (MHz)	Channel	Frequency (MHz)
52	5260	54	5270	58	5290
56	5280	62	5310		
60	5300				
64	5320				

802.11a 802.11n 20MHz 802.11ac 20MHz		802.11n 40MHz 802.11ac 40MHz		802.11ac 80MHz	
UNII-2C		UNII-2C		UNII-2C	
Channel	Frequency (MHz)	Channel	Frequency (MHz)	Channel	Frequency (MHz)
100	5500	102	5510	106	5530
104	5520	110	5550	122	5610
108	5540	118	5590		
112	5560	126	5630		
116	5580	134	5670		
132	5660				
136	5680				
140	5700				

3. Antenna Specification:

External Antenna

Ant.	Manufacturer	Model Name	Antenna Type	Connector	Gain (dBi)
1	N/A	N/A	Dipole	N/A	5
2	N/A	N/A	Dipole	N/A	5
3	N/A	N/A	Dipole	N/A	5

Note:

The EUT incorporates a MIMO function. Physically, the EUT provides three completed transmitters and receivers (3T3R), all transmit signals are completely uncorrelated, then, **Direction gain = G_{ANT}** , that is Directional gain=5.

Internal Antenna

Ant.	Manufacturer	Model Name	Antenna Type	Connector	Gain (dBi)
1	N/A	N/A	PCB	N/A	3
2	N/A	N/A	PCB	N/A	3
3	N/A	N/A	PCB	N/A	3

Note:

The EUT incorporates a MIMO function. Physically, the EUT provides three completed transmitters and receivers (3T3R), all transmit signals are completely uncorrelated, then, **Direction gain = G_{ANT}** , that is Directional gain=3.

4. Operating Mode

TX Mode	1TX	3TX
	802.11a	V (ANT 1)
802.11n (20MHz)	-	V (ANT+1 ANT 2+ANT 3)
802.11n (40MHz)	-	V (ANT+1 ANT 2+ANT 3)
802.11ac (20MHz)	-	V (ANT+1 ANT 2+ANT 3)
802.11ac (40MHz)	-	V (ANT+1 ANT 2+ANT 3)
802.11ac (80MHz)	-	V (ANT+1 ANT 2+ANT 3)

ANT 1 for 1TX was found to be the worst case and recorded

3.2 DESCRIPTION OF TEST MODES

To investigate the maximum EMI emission characteristics generates from EUT, the test system was pre-scanning tested base on the consideration of following EUT operation mode or test configuration mode which possible have effect on EMI emission level. Each of these EUT operation mode(s) or test configuration mode(s) mentioned above was evaluated respectively.

Pretest Mode	Description
Mode 1	TX A Mode / CH52, CH60, CH64 (UNII-2A)
Mode 2	TX N20 Mode / CH52, CH60, CH64 (UNII-2A)
Mode 3	TX N40 Mode / CH54, CH62 (UNII-2A)
Mode 4	TX AC20 Mode / CH52, CH60, CH64 (UNII-2A)
Mode 5	TX AC40 Mode / CH54, CH62 (UNII-2A)
Mode 6	TX AC80 Mode / CH58 (UNII-2A)
Mode 7	TX A Mode / CH100, CH116, CH140 (UNII-2C)
Mode 8	TX N20 Mode / CH100, CH116, CH140 (UNII-2C)
Mode 9	TX N40 Mode / CH102, CH110, CH134 (UNII-2C)
Mode 10	TX AC20 Mode / CH100, CH116, CH140 (UNII-2C)
Mode 11	TX AC40 Mode / CH102, CH110, CH134 (UNII-2C)
Mode 12	TX AC80 Mode / CH106, CH122 (UNII-2C)
Mode 13	TX Mode

The EUT system operated these modes were found to be the worst case during the pre-scanning test as following:

For Conducted Test	
Final Test Mode	Description
Mode 13	TX Mode

For Radiated Test	
Final Test Mode	Description
Mode 1	TX A Mode / CH52, CH60, CH64 (UNII-2A)
Mode 2	TX N20 Mode / CH52, CH60, CH64 (UNII-2A)
Mode 3	TX N40 Mode / CH54, CH62 (UNII-2A)
Mode 4	TX AC20 Mode / CH52, CH60, CH64 (UNII-2A)
Mode 5	TX AC40 Mode / CH54, CH62 (UNII-2A)
Mode 6	TX AC80 Mode / CH58 (UNII-2A)
Mode 7	TX A Mode / CH100, CH116, CH140 (UNII-2C)
Mode 8	TX N20 Mode / CH100, CH116, CH140 (UNII-2C)
Mode 9	TX N40 Mode / CH102, CH110, CH134 (UNII-2C)
Mode 10	TX AC20 Mode / CH100, CH116, CH140 (UNII-2C)
Mode 11	TX AC40 Mode / CH102, CH110, CH134 (UNII-2C)
Mode 12	TX AC80 Mode / CH106, CH122 (UNII-2C)

Note:

(1) For radiated below 1GHz test, the 802.11a mode is found to be the worst case and recorded.

3.3 TABLE OF PARAMETERS OF TEST SOFTWARE SETTING

During testing channel & power controlling software provided by the customer was used to control the operating channel as well as the output power level. The RF output power selection is for the setting of RF output power expected by the customer and is going to be fixed on the firmware of the final end product

UNII-2A			
Test Software Version	CMD		
Frequency (MHz)	5260	5300	5320
A Mode	20	20	19
N20 Mode	16	16	15
Frequency (MHz)	5270	5310	
N40 Mode	16	12	

UNII-2C			
Test Software Version	CMD		
Frequency (MHz)	5500	5580	5700
A Mode	18	20	20
N20 Mode	14	16	13
Frequency (MHz)	5510	5550	5670
N40 Mode	11	16	14

UNII-2A			
Test Software Version	CMD		
Frequency (MHz)	5260	5300	5320
AC20 Mode	16	16	14
Frequency (MHz)	5270	5310	
AC40 Mode	17	13	
Frequency (MHz)	5290		
AC80 Mode	14		

UNII-2C			
Test Software Version	CMD		
Frequency (MHz)	5500	5580	5700
AC20 Mode	14	16	14
Frequency (MHz)	5510	5550	5670
AC40 Mode	13	17	14
Frequency (MHz)	5530	5610	
AC80 Mode	11	16	

3.4 BLOCK DIAGRAM SHOWING THE CONFIGURATION OF SYSTEM TESTED

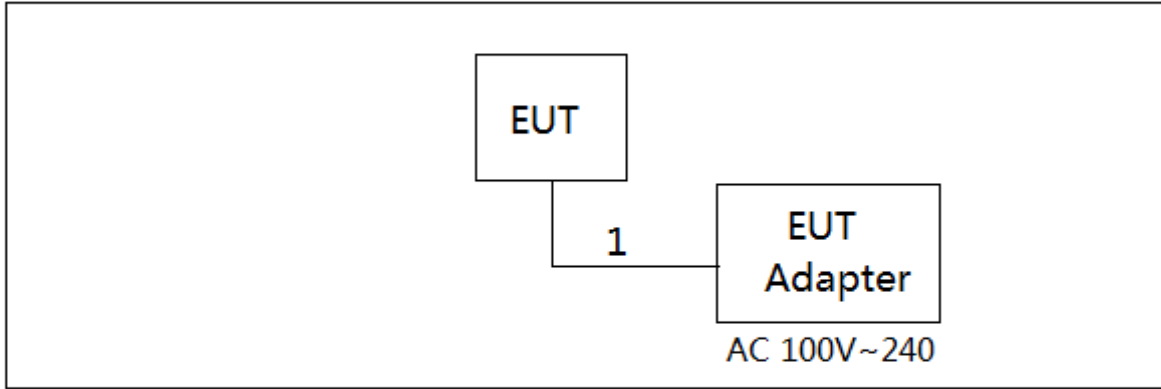

3.5 DESCRIPTION OF SUPPORT UNITS

The EUT has been tested as an independent unit together with other necessary accessories or support units. The following support units or accessories were used to form a representative test configuration during the tests.

Item	Equipment	Mfr/Brand	Model/Type No.	FCC ID	Series No.
-	-	-	-	-	-

Item	Shielded Type	Ferrite Core	Length	Note
1	NO	NO	1.5m	DC Cable

4. EMC EMISSION TEST

4.1 CONDUCTED EMISSION MEASUREMENT

4.1.1 POWER LINE CONDUCTED EMISSION (Frequency Range 150kHz-30MHz)

FREQUENCY (MHz)	Class A (dBuV)		Class B (dBuV)	
	Quasi-peak	Average	Quasi-peak	Average
0.15 -0.5	79.00	66.00	66 - 56 *	56 - 46 *
0.50 -5.0	73.00	60.00	56.00	46.00
5.0 -30.0	73.00	60.00	60.00	50.00

Note:

- (1) The tighter limit applies at the band edges.
- (2) The limit of " * " marked band means the limitation decreases linearly with the logarithm of the frequency in the range.

4.1.2 TEST PROCEDURE

- a. The EUT was placed 0.8 meters from the horizontal ground plane with EUT being connected to the power mains through a line impedance stabilization network (LISN). All other support equipments powered from additional LISN(s). The LISN provide 50 Ohm/ 50uH of coupling impedance for the measuring instrument.
- b. Interconnecting cables that hang closer than 40 cm to the ground plane shall be folded back and forth in the center forming a bundle 30 to 40 cm long.
- c. I/O cables that are not connected to a peripheral shall be bundled in the center. The end of the cable may be terminated, if required, using the correct terminating impedance. The overall length shall not exceed 1 m.
- d. LISN at least 80 cm from nearest part of EUT chassis.
- e. For the actual test configuration, please refer to the related Item –EUT Test Photos.

4.1.3 DEVIATION FROM TEST STANDARD

No deviation

4.1.4 TEST SETUP

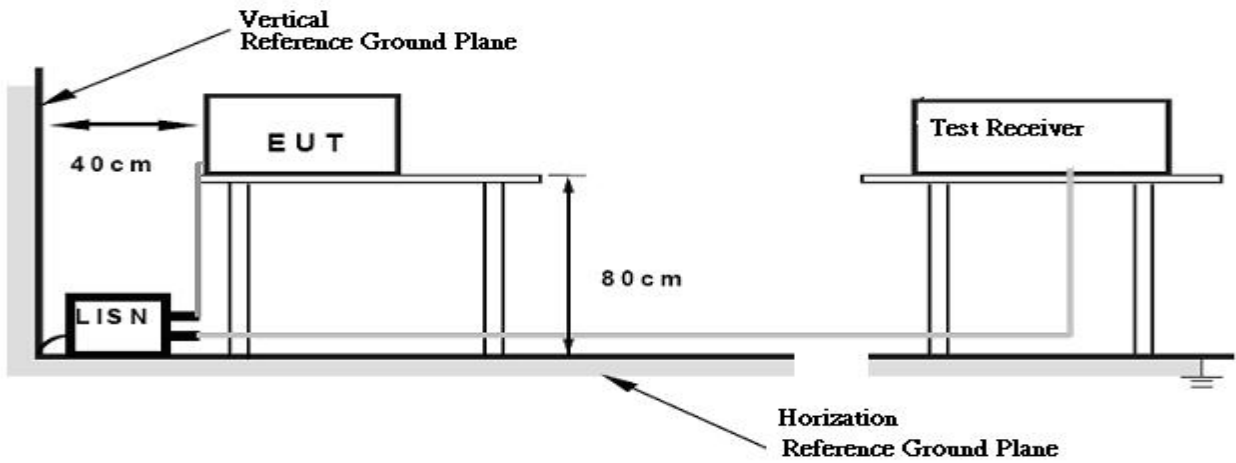

4.1.5 EUT OPERATING CONDITIONS

The EUT was configured for testing in a typical fashion (as a customer would normally use it). The EUT has been programmed to continuously transmit during test. This operating condition was tested and used to collect the included data.

The EUT was programmed to be in continuously transmitting/TX Mode mode.

4.1.6 EUT TEST CONDITIONS

Temperature: 25°C Relative Humidity: 53% Test Voltage: AC 120V/60Hz

4.1.7 TEST RESULTS

Please refer to the Appendix A.

Remark:

- (1) All readings are QP Mode value unless otherwise stated AVG in column of「Note」. If the QP Mode Measured value compliance with the QP Limits and lower than AVG Limits, the EUT shall be deemed to meet both QP & AVG Limits and then only QP Mode was measured, but AVG Mode didn't perform. In this case, a “ * ” marked in AVG Mode column of Interference Voltage Measured.
- (2) Measuring frequency range from 150kHz to 30MHz.

4.2 RADIATED EMISSION MEASUREMENT

4.2.1 RADIATED EMISSION LIMITS

In case the emission fall within the restricted band specified on 15.205(a), then the 15.209(a) limit in the table below has to be followed.

Frequencies (MHz)	Field Strength (microrvolts/meter)	Measurement Distance (meters)
0.009~0.490	2400/F(kHz)	300
0.490~1.705	24000/F(kHz)	30
1.705~30.0	30	30
30~88	100	3
88~216	150	3
216~960	200	3
Above 960	500	3

Frequencies (MHz)	EIRP Limit (dBm)	Equivalent Field Strength at 3m (dBμV/m)
5150-5250	-27	68.3
5250-5350	-27	68.3
5470-5725	-27	68.3
5725-5850	-27(Note 2)	68.3
	10(Note 2)	105.3
	15.6(Note 2)	110.9
	27(Note 2)	122.3

Note:

1. The following formula is used to convert the equipment isotropic radiated power (eirp) to

field strength: $E = \frac{1000000\sqrt{30P}}{3} \mu\text{V/m}$, where P is the eirp (Watts)

2. According to FCC 16-24, All emissions shall be limited to a level of -27 dBm/MHz at 75 MHz or more above or below the band edge increasing linearly to 10 dBm/MHz at 25 MHz above or below the band edge, and from 25MHz above or below the band edge increasing linearly to a level of 15.6 dBm/MHz at 5 MHz above or below the band edge, and from 5 MHz above or below the band edge increasing linearly to a level of 27dBm/MHz at the band edge.

4.2.2 TEST PROCEDURE

- a. The measuring distance of 3 m shall be used for measurements. The EUT was placed on the top of a rotating table 0.8 meter above the ground at a 3 meter semi-anechoic chamber. The table was rotated 360 degrees to determine the position of the highest radiation.(below 1GHz)
- b. The measuring distance of 3 m shall be used for measurements. The EUT was placed on the top of a rotating table 1.5 meter above the ground at a 3 meter semi-anechoic chamber. The table was rotated 360 degrees to determine the position of the highest radiation.(above 1GHz)
- c. The height of the equipment or of the substitution antenna shall be 0.8m or 1.5m; the height of the test antenna shall vary between 1 m to 4 m. Both horizontal and vertical polarizations of the antenna are set to make the measurement.
- d. For each suspected emission, the EUT was arranged to its worst case and then the antenna was tuned to heights find the maximum reading (used Bore sight function).
- e. The receiver system was set to peak and average detect function and specified bandwidth with maximum hold mode when the test frequency is above 1GHz.
- f. The initial step in collecting radiated emission data is a receiver peak detector mode pre-scanning the measurement frequency range. Significant peaks are then marked and then Quasi Peak detector mode re-measured.
- g. All readings are Peak unless otherwise stated QP in column of Note. Peak denotes that the Peak reading compliance with the QP Limits and then QP Mode measurement didn't perform. (below 1GHz)
- h. All readings are Peak Mode value unless otherwise stated AVG in column of Note. If the Peak Mode Measured value compliance with the Peak Limits and lower than AVG Limits, the EUT shall be deemed to meet both Peak & AVG Limits and then only Peak Mode was measured, but AVG Mode didn't perform. (above 1GHz)
- i. For the actual test configuration, please refer to the related Item –EUT Test Photos.

4.2.3 DEVIATION FROM TEST STANDARD

No deviation

4.2.4 TEST SETUP

(A)Radiated Emission Test Set-Up Frequency Below 1GHz

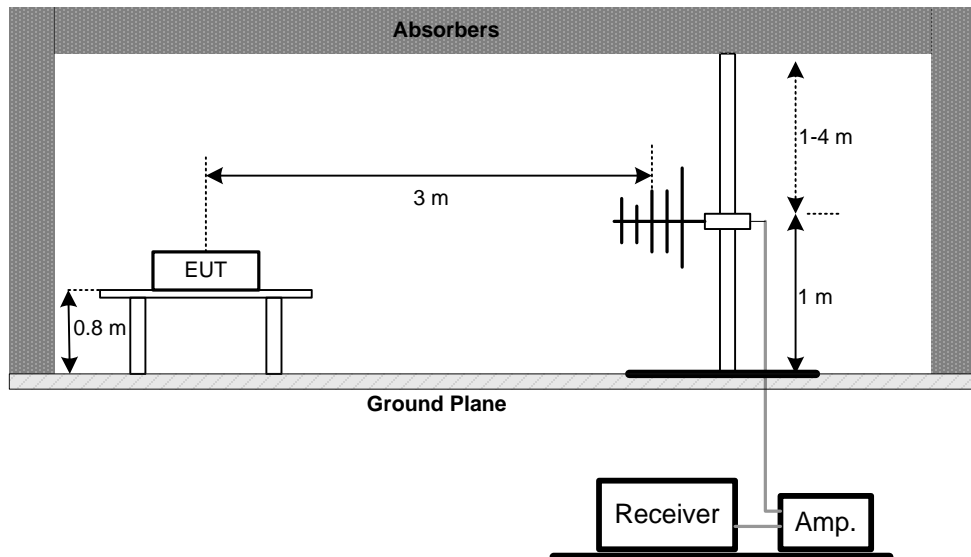

(B) Radiated Emission Test Set-Up Frequency Above 1 GHz

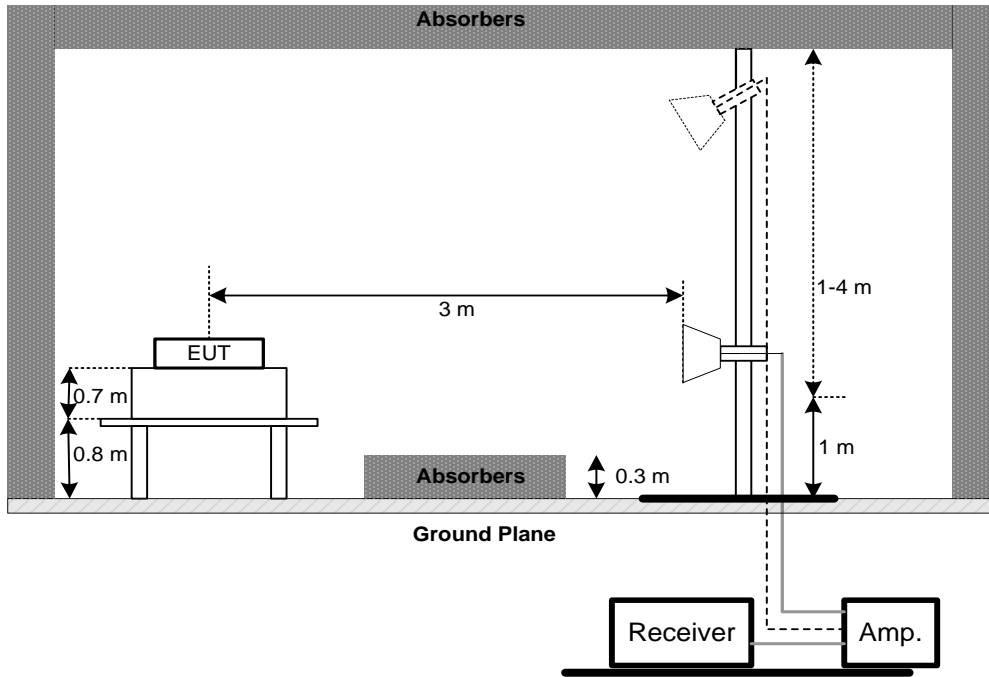

(C) Radiated emissions below 30MHz

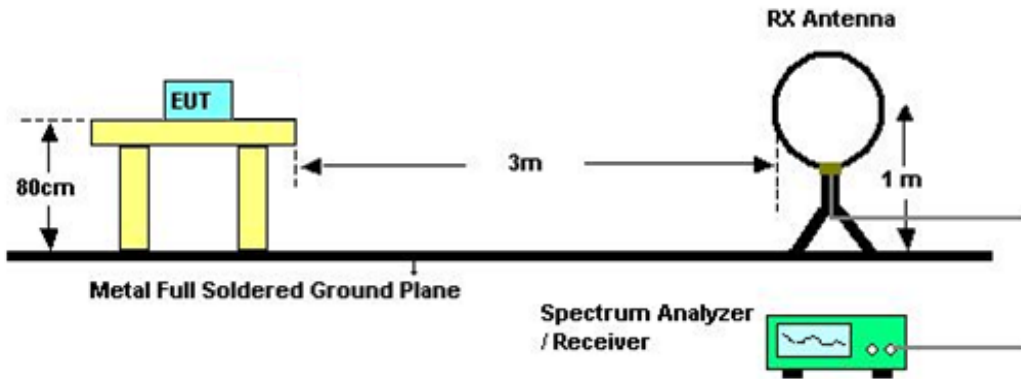

4.2.5 EUT OPERATING CONDITIONS

The EUT tested system was configured as the statements of 4.1.5 unless otherwise a special operating condition is specified in the follows during the testing.

4.2.6 EUT TEST CONDITIONS

Temperature: 25°C Relative Humidity: 60% Test Voltage: AC 120V/60Hz

4.2.7 TEST RESULTS (9K TO 30MHz)

Please refer to the Appendix B

Remark:

- (1) The amplitude of spurious emissions which are attenuated by more than 20 dB below the permissible value has no need to be reported.
- (2) Distance extrapolation factor = $40 \log$ (specific distance / test distance) (dB);
- (3) Limit line = specific limits (dBuV) + distance extrapolation factor.

4.2.8 TEST RESULTS (BETWEEN 30 TO 1000 MHz)

Please refer to the Appendix C.

4.2.9 TEST RESULTS (ABOVE 1000 MHz)

Please refer to the Appendix D.

Remark:

- (1) No limit: This is fundamental signal, the judgment is not applicable.
For fundamental signal judgment was referred to Peak output test.

5. 26dB SPECTRUM BANDWIDTH

5.1 APPLIED PROCEDURES / LIMIT

FCC Part15, Subpart E			
Test Item	Limit	Frequency Range (MHz)	Result
Bandwidth	26 dB Bandwidth	5250-5350	PASS
	26 dB Bandwidth	5470-5725	PASS

5.1.1 TEST PROCEDURE

a. The EUT was directly connected to the spectrum analyzer and antenna output port as show in the block diagram below,

b.

Spectrum Parameters	Setting
Attenuation	Auto
Span Frequency	> 26dB Bandwidth
RBW	300 kHz(Bandwidth 20MHz)
	1MHz(Bandwidth 40MHz and 80MHz)
VBW	1MHz(Bandwidth 20MHz)
	3MHz(Bandwidth 40MHz and 80MHz)
Detector	Peak
Trace	Max Hold
Sweep Time	Auto

c. Measured the spectrum width with power higher than 26dB below carrier

5.1.2 DEVIATION FROM STANDARD

No deviation.

5.1.3 TEST SETUP



5.1.4 EUT OPERATION CONDITIONS

The EUT tested system was configured as the statements of 4.1.5 unless otherwise a special operating condition is specified in the follows during the testing.

5.1.5 EUT TEST CONDITIONS

Temperature: 25°C Relative Humidity: 60% Test Voltage: AC 120V/60Hz

5.1.6 TEST RESULTS

Please refer to the Appendix E.

6. MAXIMUM CONDUCTED OUTPUT POWER

6.1 APPLIED PROCEDURES / LIMIT

FCC Part15, Subpart E			
Test Item	Limit	Frequency Range (MHz)	Result
Conducted Output Power	250mW (24dBm)	5250-5350	PASS
	250mW (24dBm)	5470-5725	PASS

Note: The maximum e.i.r.p at any elevation angle above 30 degrees as measured from the horizon must not exceed 125mW(21dBm)

6.1.1 TEST PROCEDURE

a. The EUT was directly connected to the power meter and antenna output port as show in the block diagram below,

b.

Spectrum Parameter	Setting
Attenuation	Auto
Span Frequency	Encompass the entire emissions bandwidth (EBW) of the signal
RBW	= 1MHz.
VBW	\geq 3MHz.
Detector	RMS
Trace	Max Hold
Sweep Time	auto

c. Test was performed in accordance with method of KDB 789033 D02.

6.1.2 DEVIATION FROM STANDARD

No deviation.

6.1.3 TEST SETUP

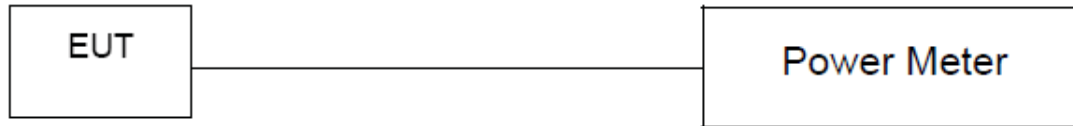

6.1.4 EUT OPERATION CONDITIONS

The EUT tested system was configured as the statements of 4.1.5 unless otherwise a special operating condition is specified in the follows during the testing.

6.1.5 EUT TEST CONDITIONS

Temperature: 25°C Relative Humidity: 60% Test Voltage: AC 120V/60Hz

6.1.6 TEST RESULTS

Please refer to the Appendix F.

7. POWER SPECTRAL DENSITY TEST

7.1 APPLIED PROCEDURES / LIMIT

FCC Part15, Subpart E			
Test Item	Limit	Frequency Range (MHz)	Result
Power Spectral Density	11dBm/MHz	5250-5350	PASS
	11dBm/MHz	5470-5725	PASS

8.1.1 TEST PROCEDURE

a. The EUT was directly connected to the spectrum analyzer and antenna output port as show in the block diagram below,

b.

Spectrum Parameter	Setting
Attenuation	Auto
Span Frequency	Encompass the entire emissions bandwidth (EBW) of the signal
RBW	= 1MHz.
VBW	≥ 3MHz.
Detector	RMS
Trace average	100 trace
Sweep Time	Auto

Note:

- For UNII-3, according to KDB publication 789033 D02 General UNII Test Procedures New Rules v01r02, section II.F.5., it is acceptable to set RBW at 1MHz and VBW at 3MHz if the spectrum analyzer does not have 500kHz RBW.
- The value measured with RBW=1MHz is to be added with $10\log(500\text{kHz}/1\text{MHz})$ which is -3dB. For example, if the measured value is +10dBm using RBW=1MHz (that is

7.1.1 DEVIATION FROM STANDARD

No deviation.

7.1.2 TEST SETUP

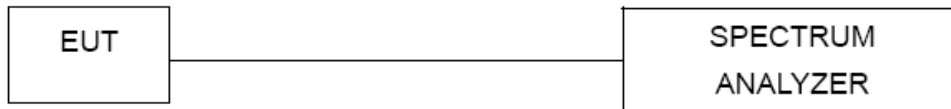

7.1.3 EUT OPERATION CONDITIONS

The EUT tested system was configured as the statements of 4.1.5 unless otherwise a special operating condition is specified in the follows during the testing.

7.1.4 EUT TEST CONDITIONS

Temperature: 25°C Relative Humidity: 60% Test Voltage: AC 120V/60Hz

7.1.5 TEST RESULTS

Please refer to the Appendix H.

8. FREQUENCY STABILITY MEASUREMENT

8.1 APPLIED PROCEDURES / LIMIT

FCC Part15, Subpart E			
Test Item	Limit	Frequency Range (MHz)	Result
Frequency Stability	Specified in the user's manual	5250-5350	PASS
		5470-5725	PASS

8.1.1 TEST PROCEDURE

a. The EUT was directly connected to the spectrum analyzer and antenna output port as show in the block diagram below,

b.

Spectrum Parameter	Setting
Attenuation	Auto
Span Frequency	Entire absence of modulation emissions bandwidth
RBW	10 kHz
VBW	10 kHz
Sweep Time	Auto

c. The test extreme voltage is to change the primary supply voltage from 85 to 115 percent of the nominal value.

d. User manual temperature is -5°C~50°C.

8.1.2 DEVIATION FROM STANDARD

No deviation.

8.1.3 TEST SETUP

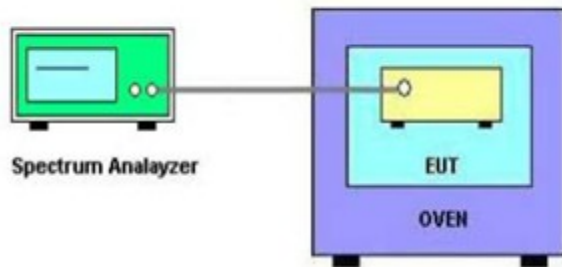

8.1.4 EUT OPERATION CONDITIONS

The EUT tested system was configured as the statements of 4.1.5 unless otherwise a special operating condition is specified in the follows during the testing.

8.1.5 EUT TEST CONDITIONS

Temperature: 25°C Relative Humidity: 55% Test Voltage: AC 120V/60Hz

8.1.6 TEST RESULTS

Please refer to the Appendix I.

9. MEASUREMENT INSTRUMENTS LIST

Conducted Emission					
Item	Kind of Equipment	Manufacturer	Type No.	Serial No.	Calibrated until
1	EMI Test Receiver	R&S	ESCI	100382	Mar. 26, 2018
2	LISN	EMCO	3816/2	52765	Mar. 26, 2018
3	50Ω Terminator	SHX	TF2-3G-A	8122901	Mar. 26, 2018
4	TWO-LINE V-NETWORK	R&S	ENV216	101447	Mar. 26, 2018
5	Measurement Software	Farad	EZ-EMC Ver.NB-03A1-01	N/A	N/A
6	Cable	N/A	RG223	12m	Oct. 19, 2018

Radiated Emission Below 1GHz					
Item	Kind of Equipment	Manufacturer	Type No.	Serial No.	Calibrated until
1	Antenna	Schwarbeck	VULB9160	9160-3232	Mar. 26, 2018
2	Amplifier	HP	8447D	2944A09673	Oct. 19, 2018
3	Receiver	Agilent	N9038A	MY52130039	Aug. 20, 2018
4	Cable	emci	LMR-400(30MHz-1 GHz)(8m+5m)	N/A	Jun. 26, 2018
5	Controller	CT	SC100	N/A	N/A
6	Controller	MF	MF-7802	MF780208416	N/A
7	Measurement Software	Farad	EZ-EMC Ver.NB-03A1-01	N/A	N/A
8	Active Loop Antenna	R&S	HFH2-Z2	830749/020	Aug. 20, 2018

Radiated Emission Above 1GHz					
Item	Kind of Equipment	Manufacturer	Type No.	Serial No.	Calibrated until
1	Double Ridged Guide Antenna	ETS	3115	75789	Mar. 26, 2018
2	Broad-Band Horn Antenna	Schwarzbeck	BBHA 9170	9170319	Jun. 08, 2018
3	Amplifier	Agilent	8449B	3008A02274	May. 16, 2018
4	Microwave Preamplifier With Adaptor	EMC INSTRUMENT	EMC2654045	980039 & HA01	Mar. 26, 2018
5	Receiver	Agilent	N9038A	MY52130039	Aug. 20, 2018
6	Antenna	EM	EM-6876-1	230	Mar. 06, 2018
7	Controller	CT	SC100	N/A	N/A
8	Controller	MF	MF-7802	MF780208416	N/A
9	Cable	emci	EMC104-SM-SM-1 2000(12m)	N/A	Jun. 26, 2018
10	Measurement Software	Farad	EZ-EMC Ver.NB-03A1-01	N/A	N/A

Spectrum Bandwidth Measurement					
Item	Kind of Equipment	Manufacturer	Type No.	Serial No.	Calibrated until
1	Spectrum Analyzer	R&S	FSP40	100185	Aug. 20, 2018

Maximum Conducted Output Power Measurement					
Item	Kind of Equipment	Manufacturer	Type No.	Serial No.	Calibrated until
1	Power Meter	ANRITSU	ML2495A	1128009	Mar. 26, 2018
2	Pulse Power Sensor	ANRITSU	MA 2411B	1027500	Mar. 26, 2018

Power Spectral Density Measurement					
Item	Kind of Equipment	Manufacturer	Type No.	Serial No.	Calibrated until
1	Spectrum Analyzer	R&S	FSP40	100185	Aug. 20, 2018

Frequency Stability Measurement					
Item	Kind of Equipment	Manufacturer	Type No.	Serial No.	Calibrated until
1	Spectrum Analyzer	R&S	FSP40	100185	Aug. 20, 2018
2	Precision Oven Tester	Bell	BTH-50C	20170306001	Mar. 26, 2018

Remark: "N/A" denotes no model name, serial no. or calibration specified.
 All calibration period of equipment list is one year.

10. EUT TEST PHOTOS

Conducted Measurement Photos_ External Antenna



Conducted Measurement Photos_ Internal Antenna



Radiated Measurement Photos_ External Antenna

9kHz to 30MHz



Radiated Measurement Photos_ Internal Antenna

9kHz to 30MHz



Radiated Measurement Photos_ External Antenna

30MHz to 1000MHz

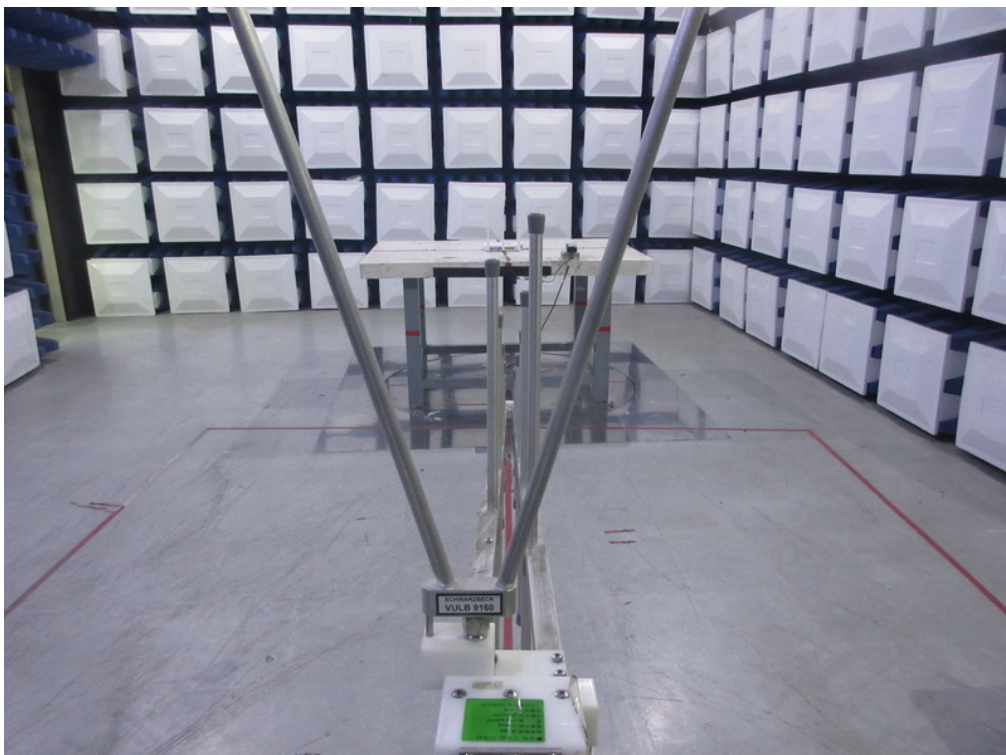

Radiated Measurement Photos_ Internal Antenna

30MHz to 1000MHz

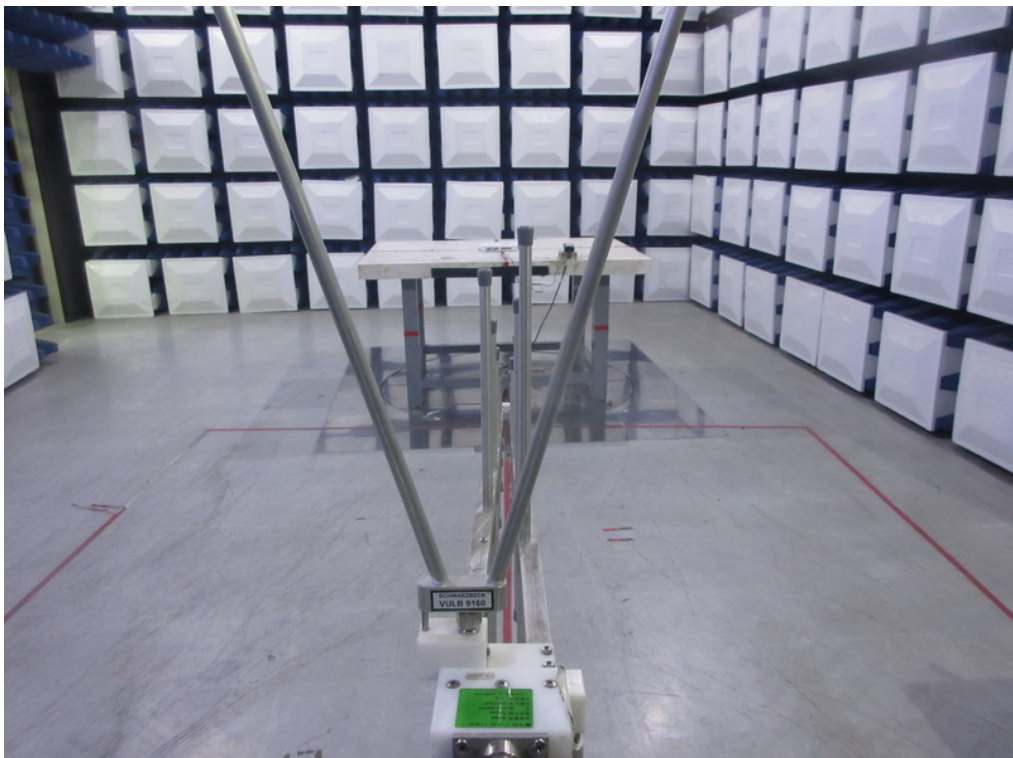
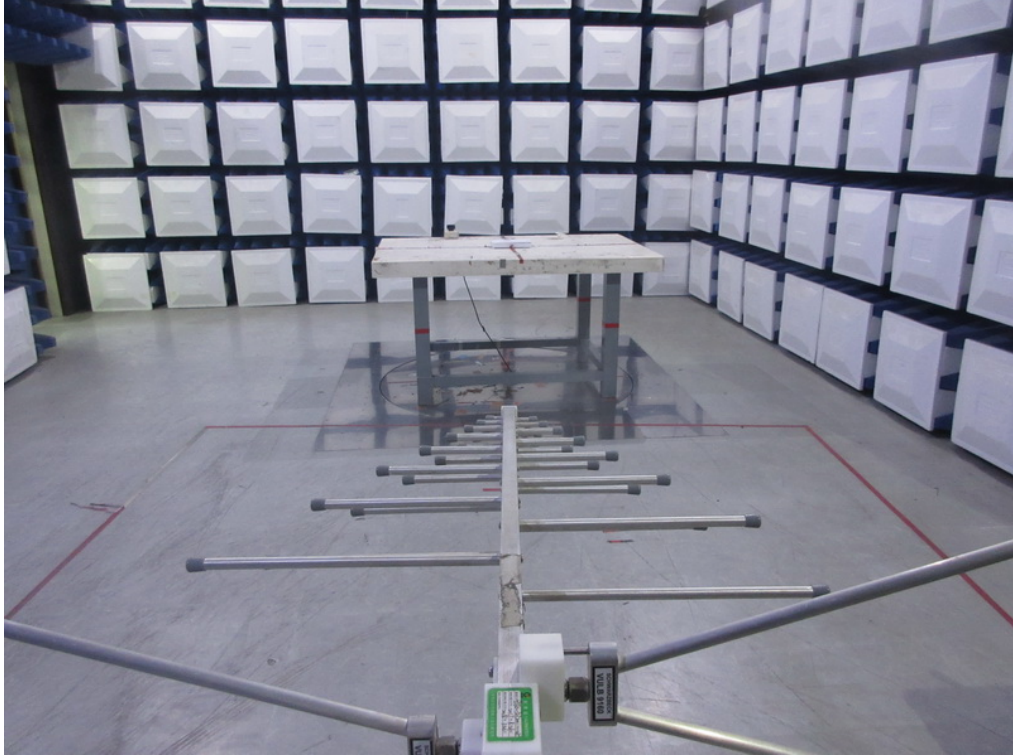

Radiated Measurement Photos_ External Antenna

Above 1000MHz

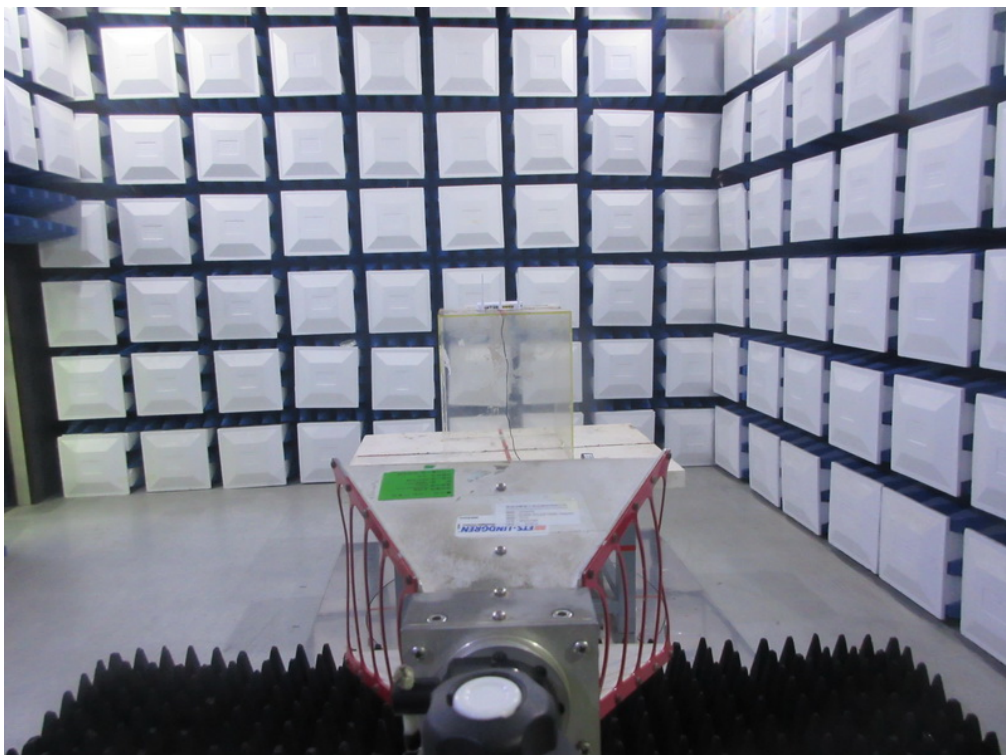

Radiated Measurement Photos_ Internal Antenna

Above 1000MHz

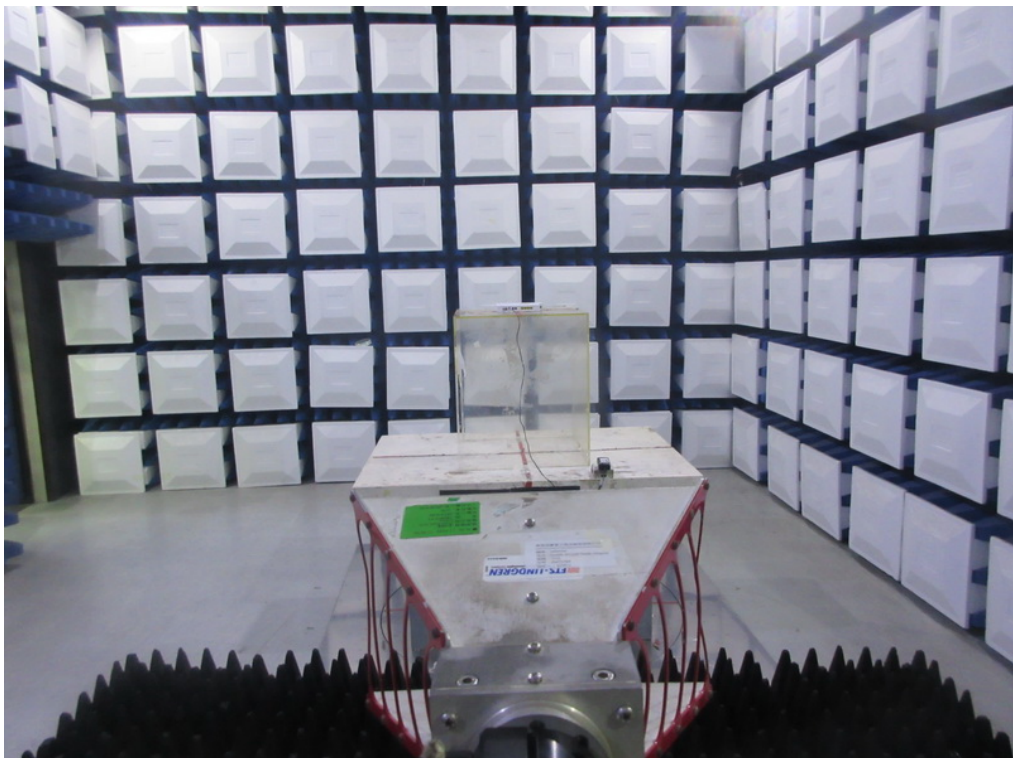
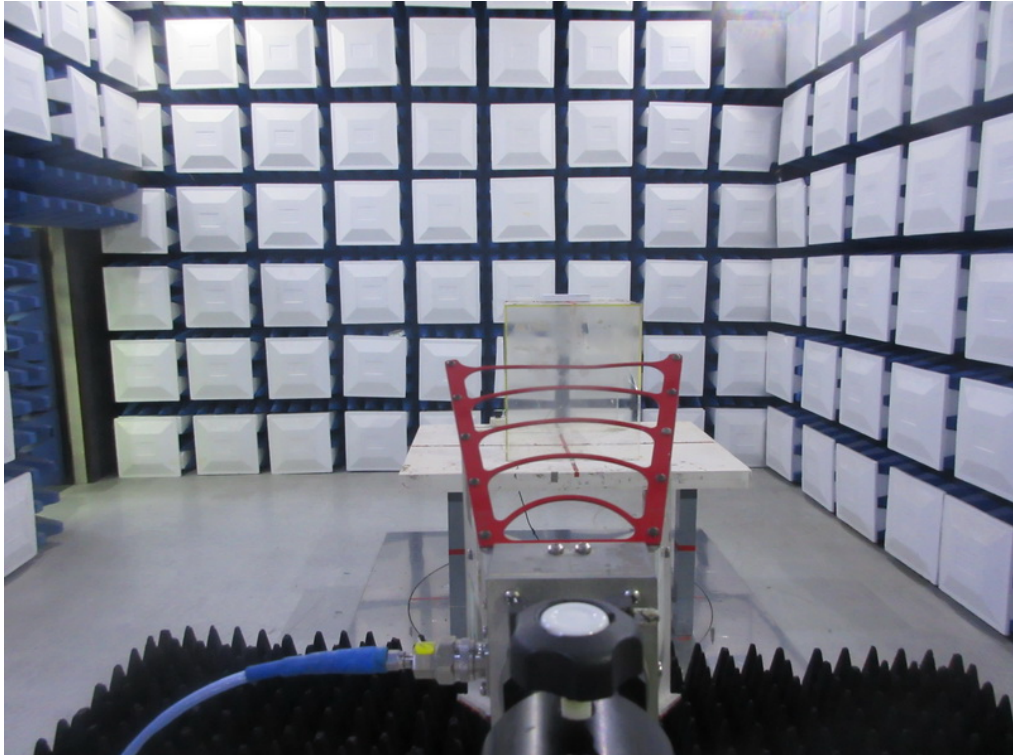

APPENDIX A - CONDUCTED EMISSION

External Antenna

Test Mode: TX MODE_Adapter: RD1201500-C55-81MG

Line

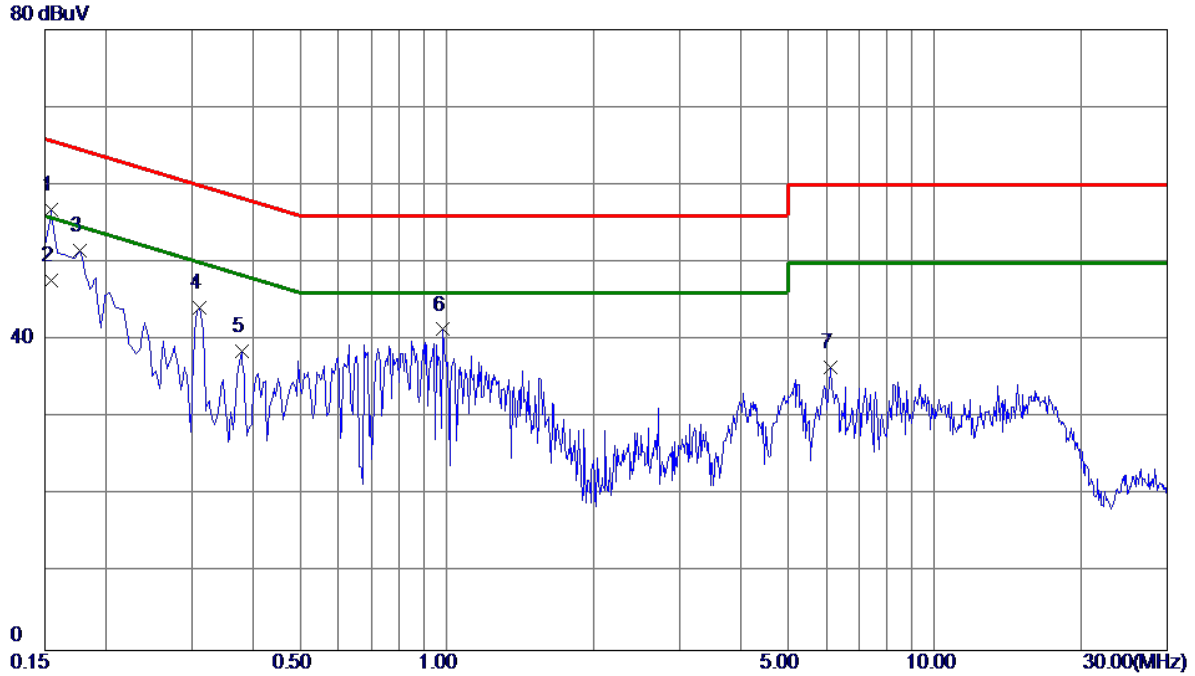

No.	Freq. MHz	Reading Level dBuV	Correct Factor dB	Measure ment dBuV	Limit dBuV	Margin dB	Detector	Comment
1	0.1545	46.98	9.75	56.73	65.75	-9.02	Peak	
2 *	0.1545	38.00	9.75	47.75	55.75	-8.00	AVG	
3	0.1770	41.81	9.74	51.55	64.63	-13.08	Peak	
4	0.3120	34.44	9.72	44.16	59.92	-15.76	Peak	
5	0.3795	28.75	9.75	38.50	58.29	-19.79	Peak	
6	0.9825	31.59	9.77	41.36	56.00	-14.64	Peak	
7	6.1260	26.54	9.95	36.49	60.00	-23.51	Peak	

Note : The test result has included the cable loss.

Test Mode: TX MODE_Adapter: RD1201500-C55-81MG

Neutral

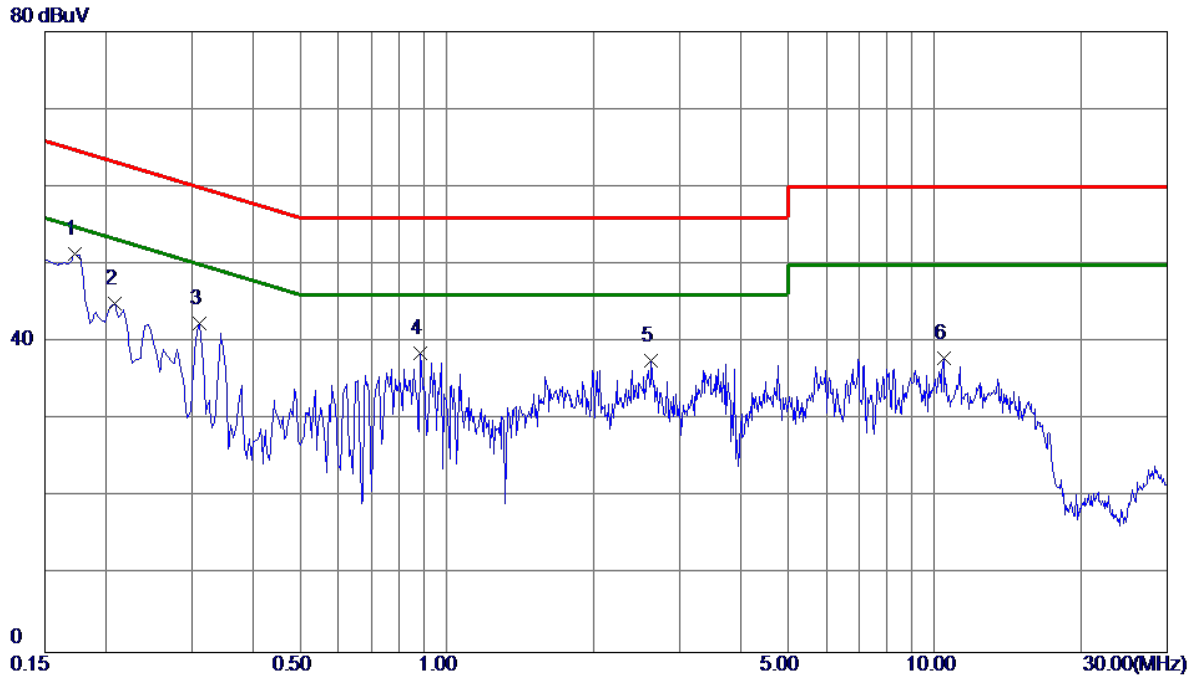

No.	Freq. MHz	Reading Level dBuV	Correct Factor dB	Measure ment dBuV	Limit dBuV	Margin dB	Detector	Comment
1 *	0.1725	41.67	9.64	51.31	64.84	-13.53	Peak	
2	0.2085	35.29	9.65	44.94	63.26	-18.32	Peak	
3	0.3120	32.69	9.64	42.33	59.92	-17.59	Peak	
4	0.8835	28.89	9.67	38.56	56.00	-17.44	Peak	
5	2.6295	27.81	9.75	37.56	56.00	-18.44	Peak	
6	10.4415	27.91	10.06	37.97	60.00	-22.03	Peak	

Note : The test result has included the cable loss.

Test Mode: TX MODE_Adapter: RD1201500-C55-24MG

Line

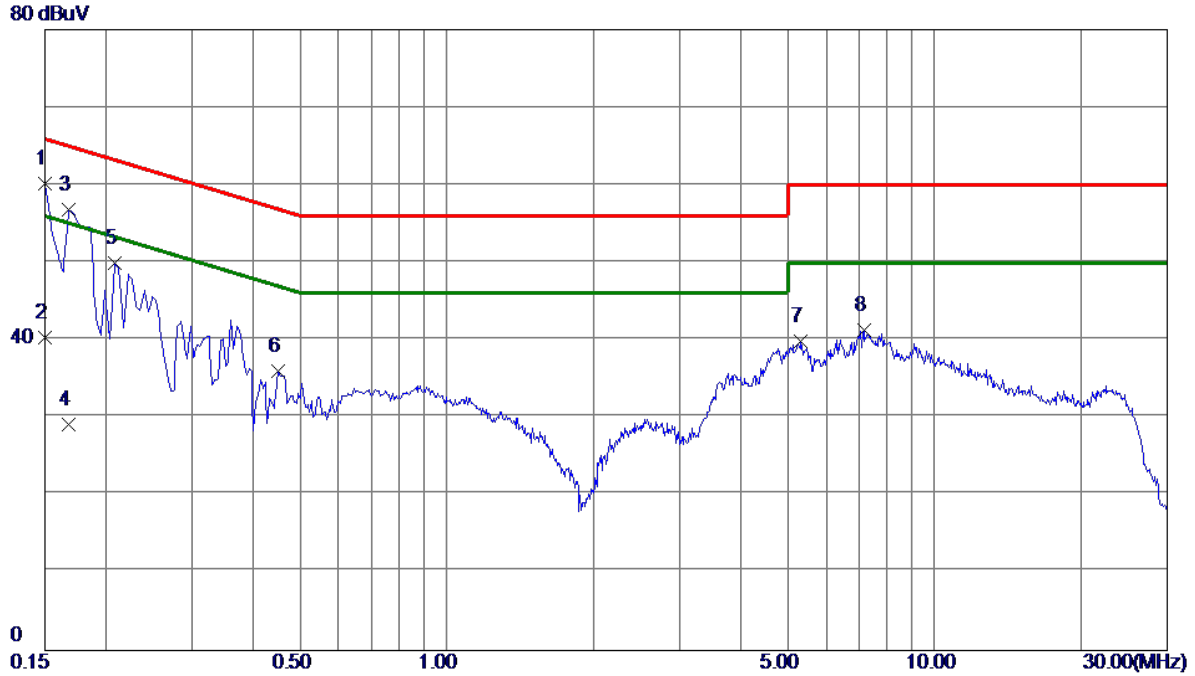

No.	Freq. MHz	Reading Level dBuV	Correct Factor dB	Measure ment dBuV	Limit dBuV	Margin dB	Detector	Comment
1 *	0.1500	50.39	9.75	60.14	66.00	-5.86	Peak	
2	0.1500	30.56	9.75	40.31	56.00	-15.69	AVG	
3	0.1680	47.04	9.74	56.78	65.06	-8.28	Peak	
4	0.1680	19.40	9.74	29.14	55.06	-25.92	AVG	
5	0.2085	40.17	9.72	49.89	63.26	-13.37	Peak	
6	0.4515	26.24	9.76	36.00	56.85	-20.85	Peak	
7	5.3160	29.94	9.90	39.84	60.00	-20.16	Peak	
8	7.1565	31.35	9.96	41.31	60.00	-18.69	Peak	

Note : The test result has included the cable loss.

Test Mode: TX MODE_Adapter: RD1201500-C55-24MG

Neutral

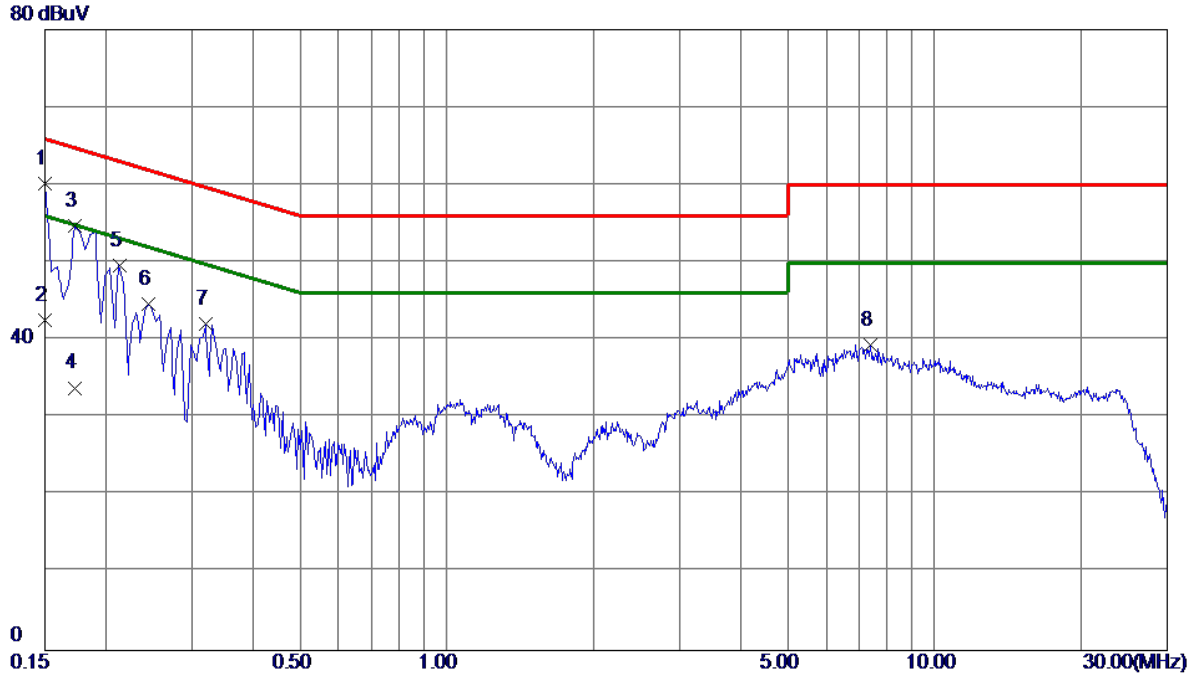

No.	Freq. MHz	Reading Level dBuV	Correct Factor dB	Measurement dBuV	Limit dBuV	Margin dB	Detector	Comment
1 *	0.1500	50.51	9.64	60.15	66.00	-5.85	Peak	
2	0.1500	32.93	9.64	42.57	56.00	-13.43	AVG	
3	0.1725	45.11	9.64	54.75	64.84	-10.09	Peak	
4	0.1725	24.20	9.64	33.84	54.84	-21.00	AVG	
5	0.2130	39.93	9.65	49.58	63.09	-13.51	Peak	
6	0.2445	35.05	9.64	44.69	61.94	-17.25	Peak	
7	0.3209	32.43	9.65	42.08	59.68	-17.60	Peak	
8	7.4040	29.51	9.89	39.40	60.00	-20.60	Peak	

Note : The test result has included the cable loss.

Test Mode: TX MODE_Adapter: RD1202000-C55-29MG

Line

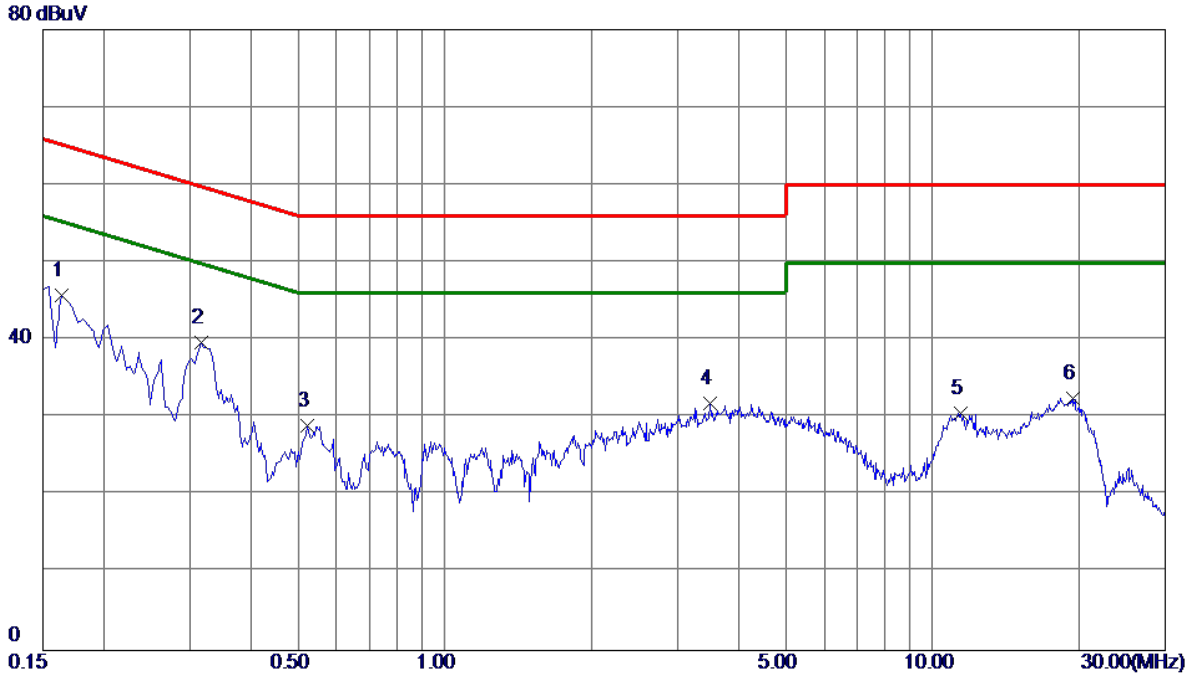

No.	Freq. MHz	Reading Level dBuV	Correct Factor dB	Measure ment dBuV	Limit dBuV	Margin dB	Detector	Comment
1 *	0.1635	36.08	9.74	45.82	65.28	-19.46	Peak	
2	0.3165	29.90	9.73	39.63	59.80	-20.17	Peak	
3	0.5235	19.13	9.76	28.89	56.00	-27.11	Peak	
4	3.5070	21.95	9.88	31.83	56.00	-24.17	Peak	
5	11.4360	20.42	10.15	30.57	60.00	-29.43	Peak	
6	19.4100	22.23	10.31	32.54	60.00	-27.46	Peak	

Note : The test result has included the cable loss.

Test Mode: TX MODE_Adapter: RD1202000-C55-29MG

Neutral

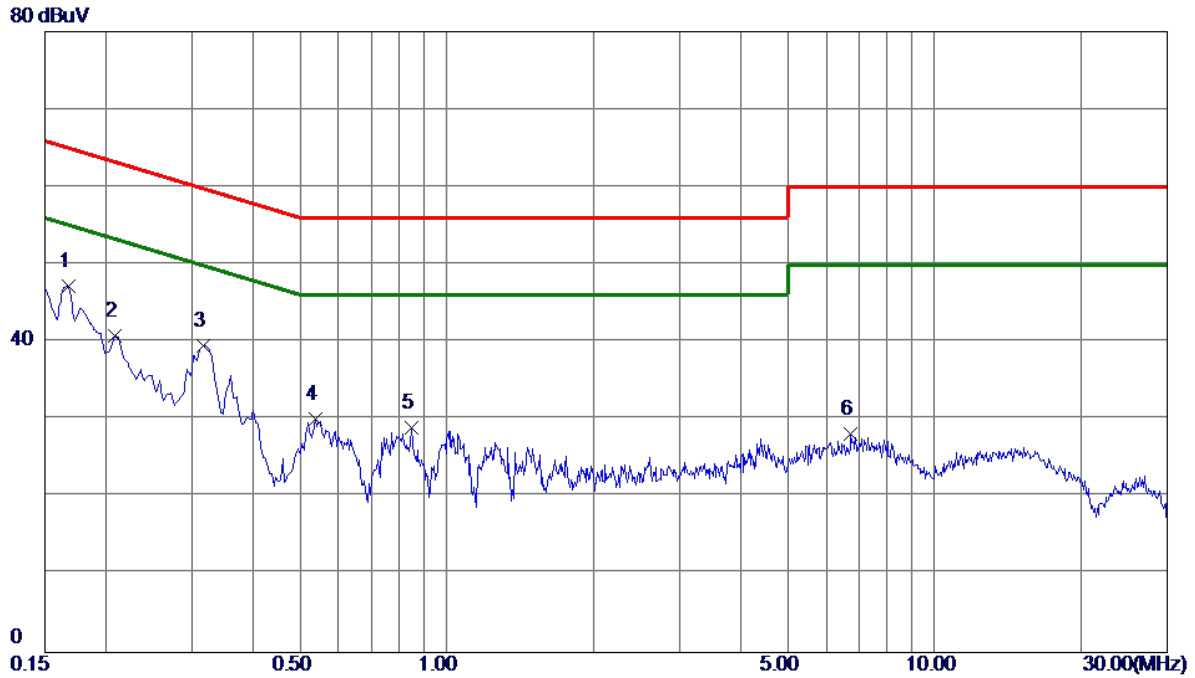

No.	Freq. MHz	Reading Level dBuV	Correct Factor dB	Measure ment dBuV	Limit dBuV	Margin dB	Detector	Comment
1 *	0.1680	37.51	9.64	47.15	65.06	-17.91	Peak	
2	0.2085	31.17	9.65	40.82	63.26	-22.44	Peak	
3	0.3165	29.90	9.64	39.54	59.80	-20.26	Peak	
4	0.5370	20.35	9.66	30.01	56.00	-25.99	Peak	
5	0.8475	19.25	9.67	28.92	56.00	-27.08	Peak	
6	6.7380	18.25	9.89	28.14	60.00	-31.86	Peak	

Note : The test result has included the cable loss.

Internal Antenna

Test Mode: TX MODE_Adapter: RD1201500-C55-81MG

Line

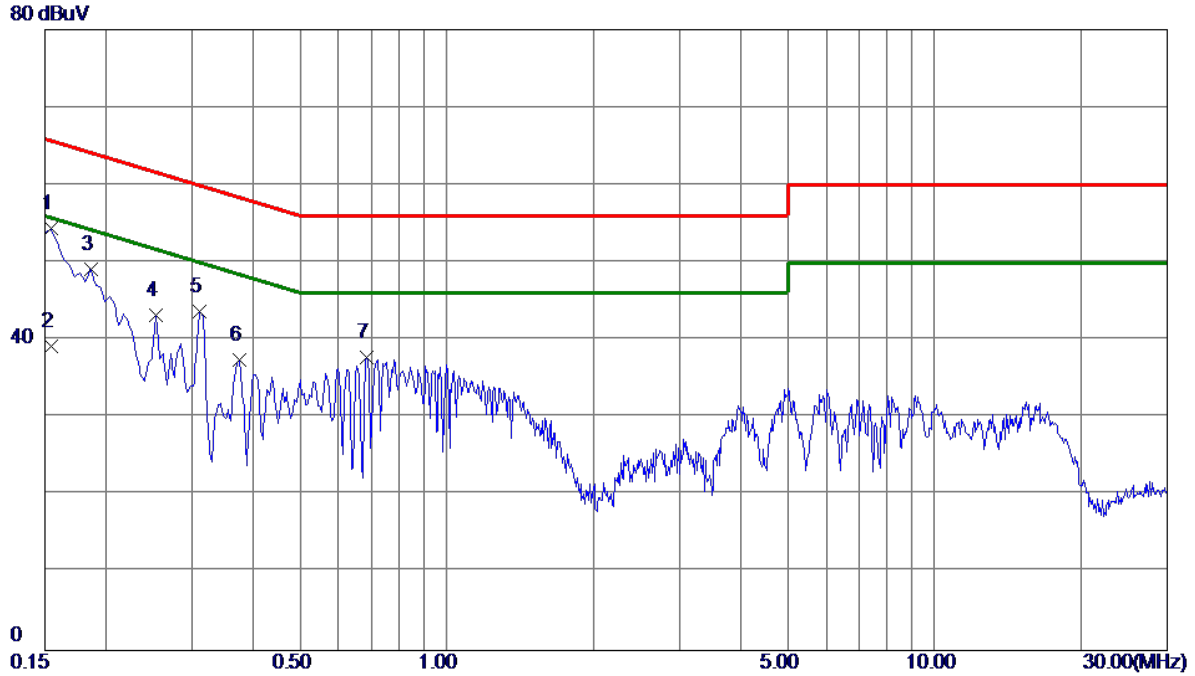

No.	Freq. MHz	Reading Level dBuV	Correct Factor dB	Measure ment dBuV	Limit dBuV	Margin dB	Detector	Comment
1 *	0.1544	44.58	9.75	54.33	65.76	-11.43	Peak	
2	0.1544	29.45	9.75	39.20	55.76	-16.56	AVG	
3	0.1860	39.38	9.73	49.11	64.21	-15.10	Peak	
4	0.2535	33.54	9.72	43.26	61.64	-18.38	Peak	
5	0.3120	33.99	9.72	43.71	59.92	-16.21	Peak	
6	0.3750	27.73	9.75	37.48	58.39	-20.91	Peak	
7	0.6855	27.95	9.77	37.72	56.00	-18.28	Peak	

Note : The test result has included the cable loss.

Test Mode: TX MODE_Adapter: RD1201500-C55-81MG

Neutral

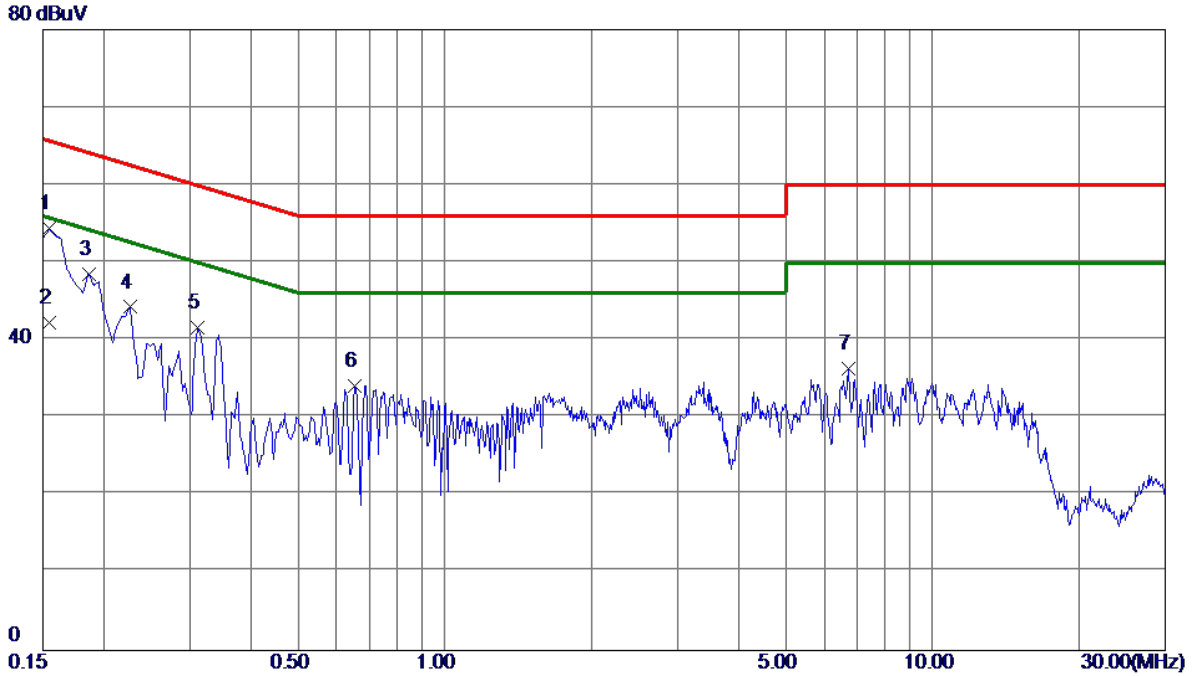

No.	Freq. MHz	Reading Level dBuV	Correct Factor dB	Measure ment dBuV	Limit dBuV	Margin dB	Detector	Comment
1 *	0.1544	44.69	9.64	54.33	65.76	-11.43	Peak	
2	0.1544	32.66	9.64	42.30	55.76	-13.46	AVG	
3	0.1860	38.90	9.65	48.55	64.21	-15.66	Peak	
4	0.2265	34.60	9.64	44.24	62.58	-18.34	Peak	
5	0.3120	31.96	9.64	41.60	59.92	-18.32	Peak	
6	0.6540	24.48	9.66	34.14	56.00	-21.86	Peak	
7	6.7245	26.42	9.89	36.31	60.00	-23.69	Peak	

Note : The test result has included the cable loss.

Test Mode: TX MODE_Adapter: RD1201500-C55-24MG

Line

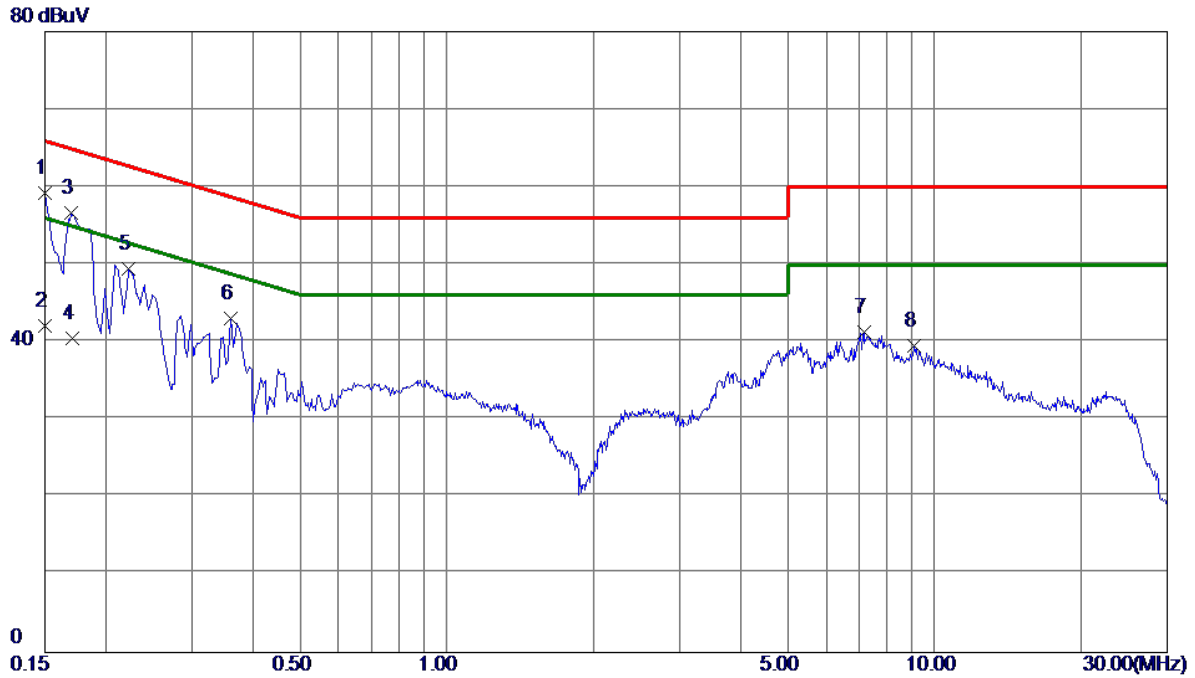

No.	Freq. MHz	Reading Level dBuV	Correct Factor dB	Measure ment dBuV	Limit dBuV	Margin dB	Detector	Comment
1 *	0.1500	49.39	9.75	59.14	66.00	-6.86	Peak	
2	0.1500	32.26	9.75	42.01	56.00	-13.99	AVG	
3	0.1693	46.86	9.74	56.60	64.99	-8.39	Peak	
4	0.1703	30.74	9.74	40.48	54.95	-14.47	AVG	
5	0.2220	39.76	9.72	49.48	62.74	-13.26	Peak	
6	0.3613	33.36	9.75	43.11	58.70	-15.59	Peak	
7	7.1565	31.35	9.96	41.31	60.00	-18.69	Peak	
8	9.0732	29.44	10.01	39.45	60.00	-20.55	Peak	

Note : The test result has included the cable loss.

Test Mode: TX MODE_Adapter: RD1201500-C55-24MG

Neutral

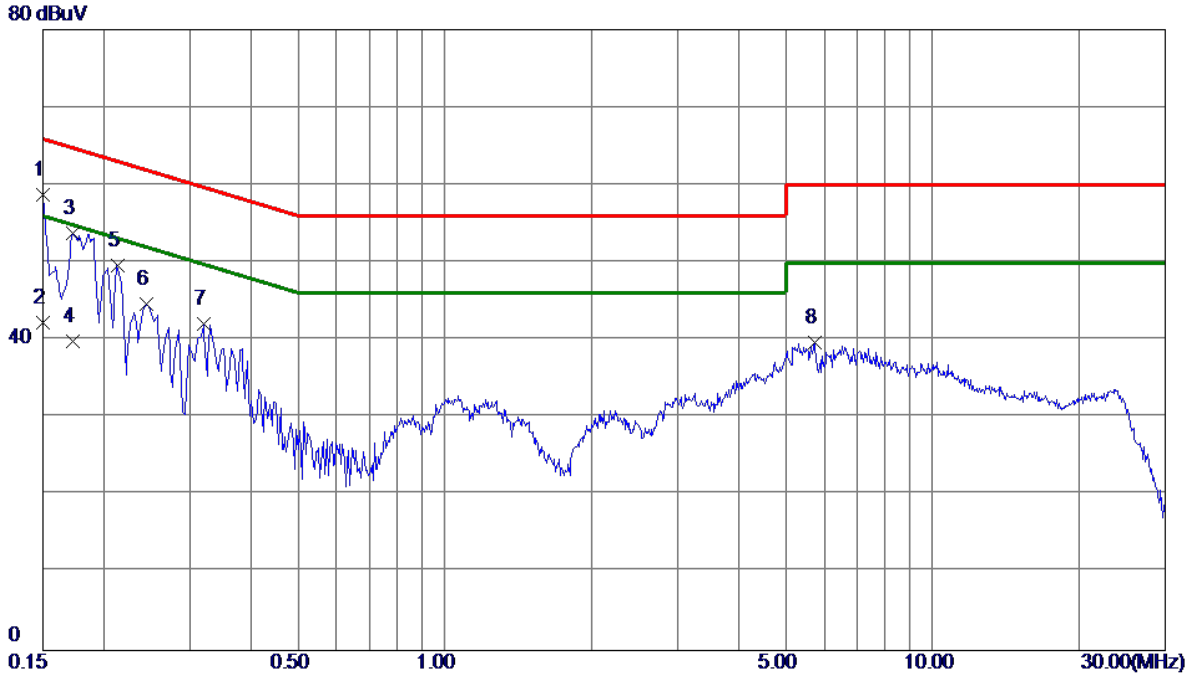

No.	Freq. MHz	Reading Level dBuV	Correct Factor dB	Measure ment dBuV	Limit dBuV	Margin dB	Detector	Comment
1 *	0.1500	49.01	9.64	58.65	66.00	-7.35	Peak	
2	0.1500	32.62	9.64	42.26	56.00	-13.74	AVG	
3	0.1723	44.11	9.64	53.75	64.85	-11.10	Peak	
4	0.1723	30.16	9.64	39.80	54.85	-15.05	AVG	
5	0.2130	39.93	9.65	49.58	63.09	-13.51	Peak	
6	0.2444	35.05	9.64	44.69	61.95	-17.26	Peak	
7	0.3209	32.43	9.65	42.08	59.68	-17.60	Peak	
8	5.7390	29.83	9.84	39.67	60.00	-20.33	Peak	

Note : The test result has included the cable loss.

Test Mode: TX MODE_Adapter: RD1202000-C55-29MG

Line

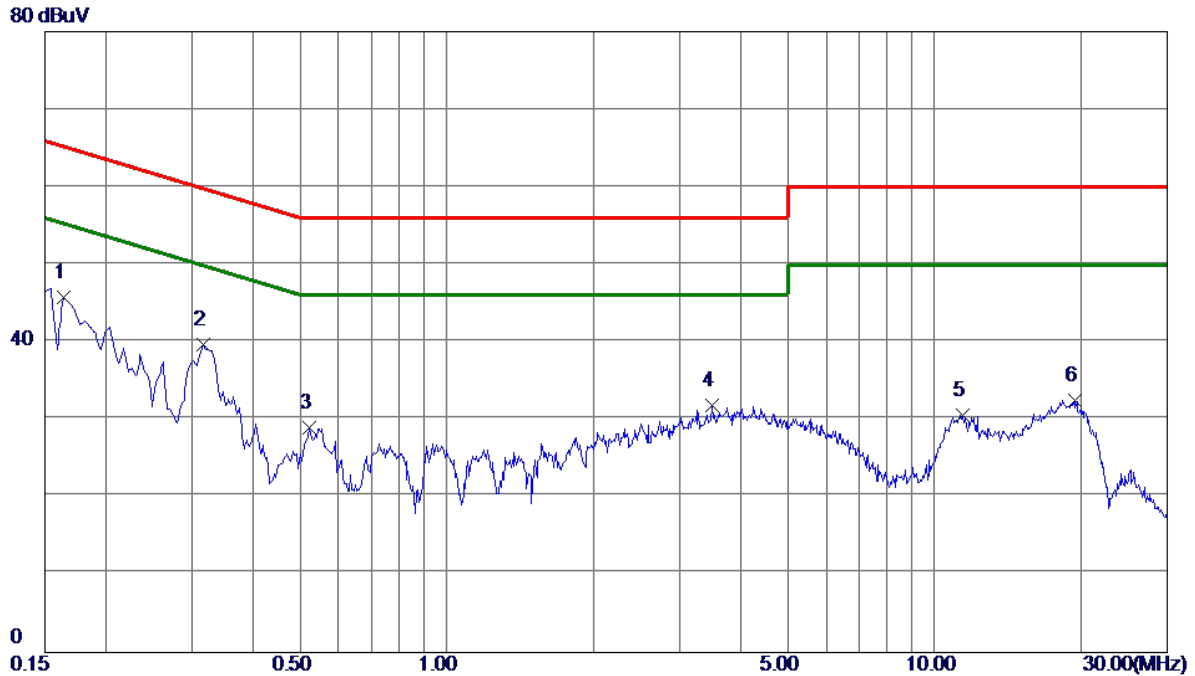

No.	Freq. MHz	Reading Level dBuV	Correct Factor dB	Measure ment dBuV	Limit dBuV	Margin dB	Detector	Comment
1 *	0.1635	36.08	9.74	45.82	65.28	-19.46	Peak	
2	0.3165	29.90	9.73	39.63	59.80	-20.17	Peak	
3	0.5235	19.13	9.76	28.89	56.00	-27.11	Peak	
4	3.5070	21.95	9.88	31.83	56.00	-24.17	Peak	
5	11.4360	20.42	10.15	30.57	60.00	-29.43	Peak	
6	19.4100	22.23	10.31	32.54	60.00	-27.46	Peak	

Note : The test result has included the cable loss.

Test Mode: TX MODE_Adapter: RD1202000-C55-29MG

Neutral

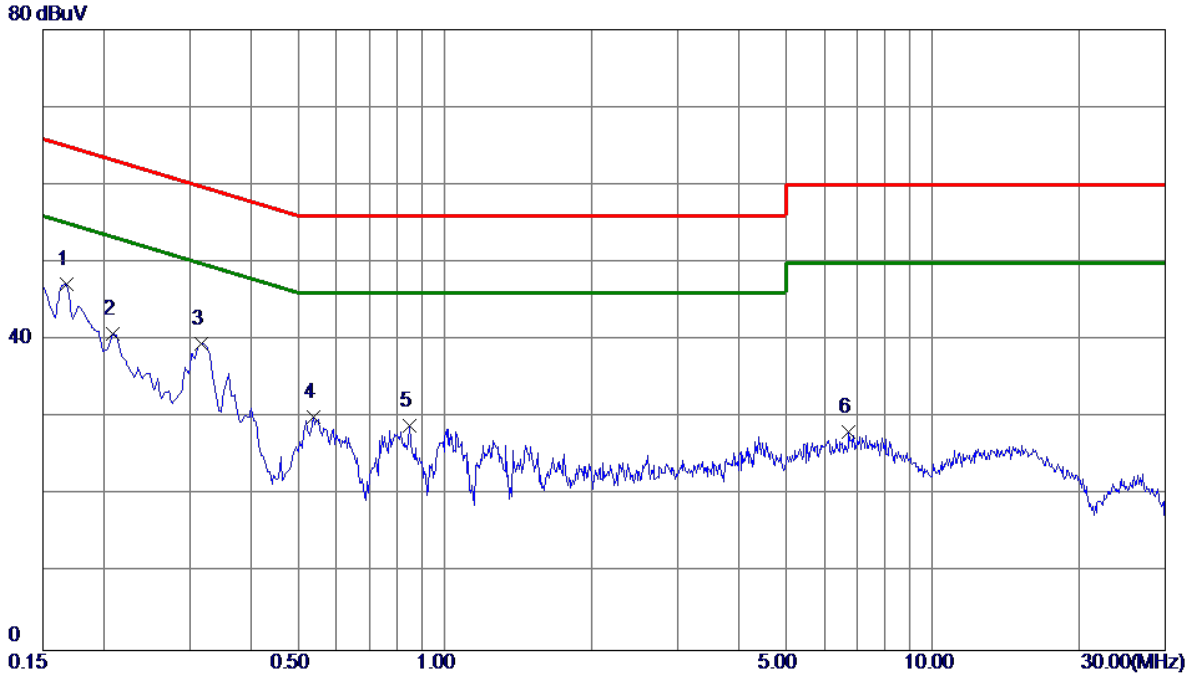

No.	Freq. MHz	Reading Level dBuV	Correct Factor dB	Measure ment dBuV	Limit dBuV	Margin dB	Detector	Comment
1 *	0.1680	37.51	9.64	47.15	65.06	-17.91	Peak	
2	0.2085	31.17	9.65	40.82	63.26	-22.44	Peak	
3	0.3165	29.90	9.64	39.54	59.80	-20.26	Peak	
4	0.5370	20.35	9.66	30.01	56.00	-25.99	Peak	
5	0.8475	19.25	9.67	28.92	56.00	-27.08	Peak	
6	6.7380	18.25	9.89	28.14	60.00	-31.86	Peak	

Note : The test result has included the cable loss.

APPENDIX B - RADIATED EMISSION (9KHZ TO 30MHZ)

External Antenna

Test Mode: TX MODE _Adapter: RD1201500-C55-81MG

Ant 0°

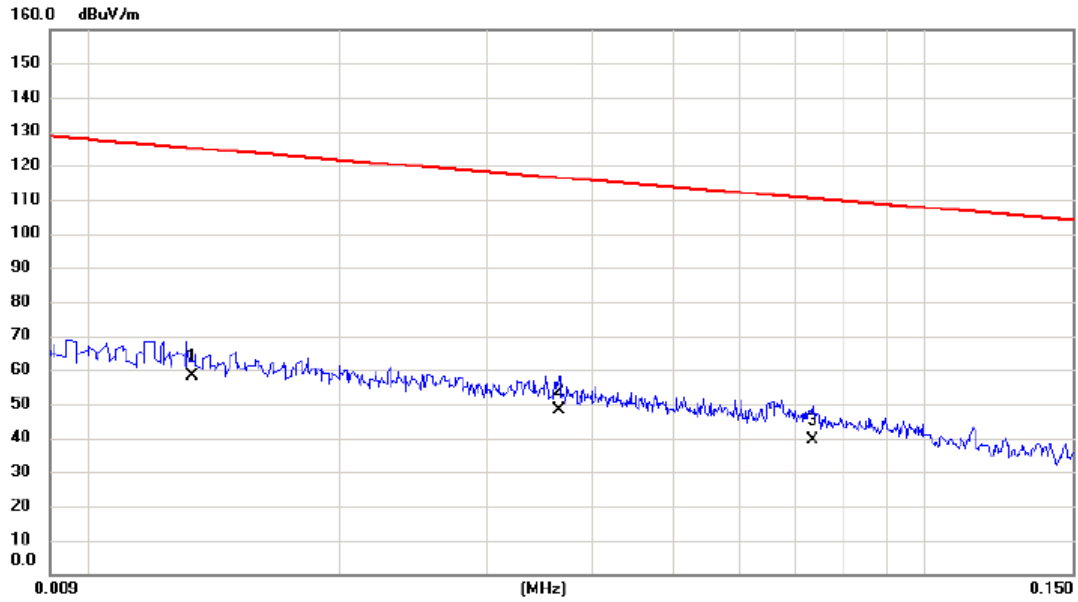

No.	Mk.	Freq.	Reading Level	Correct Factor	Measurement	Limit	Margin	Detector	Comment
		MHz	dBuV	dB	dBuV/m	dBuV/m	dB		
1	*	0.0133	37.70	20.49	58.19	125.13	-66.94	AVG	
2		0.0366	29.08	19.12	48.20	116.34	-68.14	AVG	
3		0.0734	21.02	18.26	39.28	110.29	-71.01	AVG	

Test Mode: TX MODE _Adapter: RD1201500-C55-81MG

Ant 0°

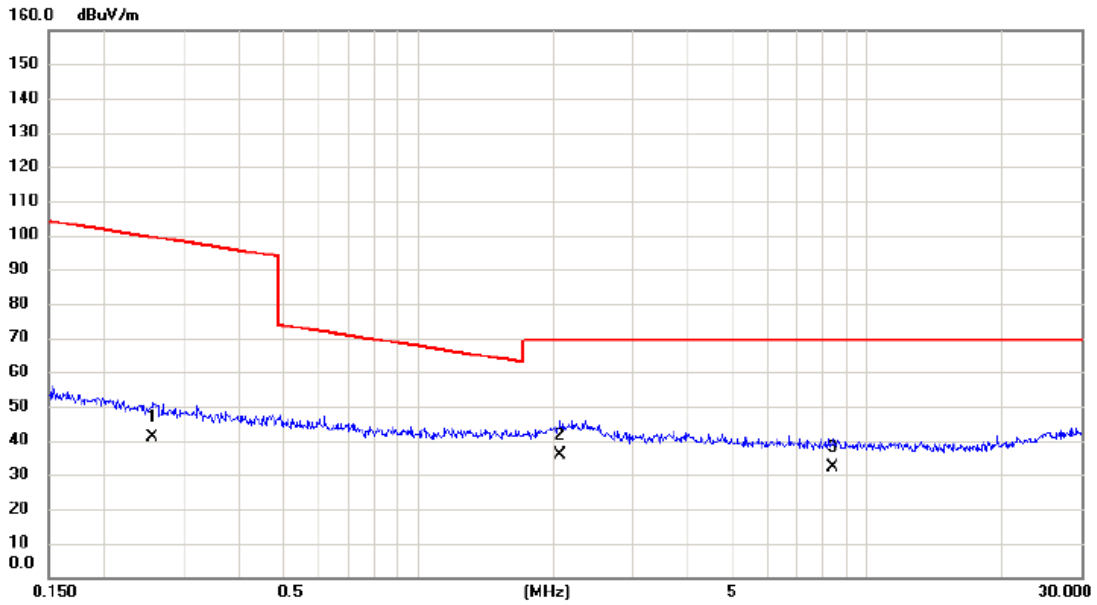

No.	Mk.	Freq. MHz	Reading Level dBuV	Correct Factor dB	Measure- ment dBuV/m	Limit dBuV/m	Margin dB	Detector	Comment
1		0.2562	24.30	16.66	40.96	99.43	-58.47	AVG	
2	*	2.0660	20.39	15.49	35.88	69.54	-33.66	QP	
3		8.3671	18.21	13.95	32.16	69.54	-37.38	QP	

Test Mode: TX MODE _Adapter: RD1201500-C55-81MG

Ant 90°

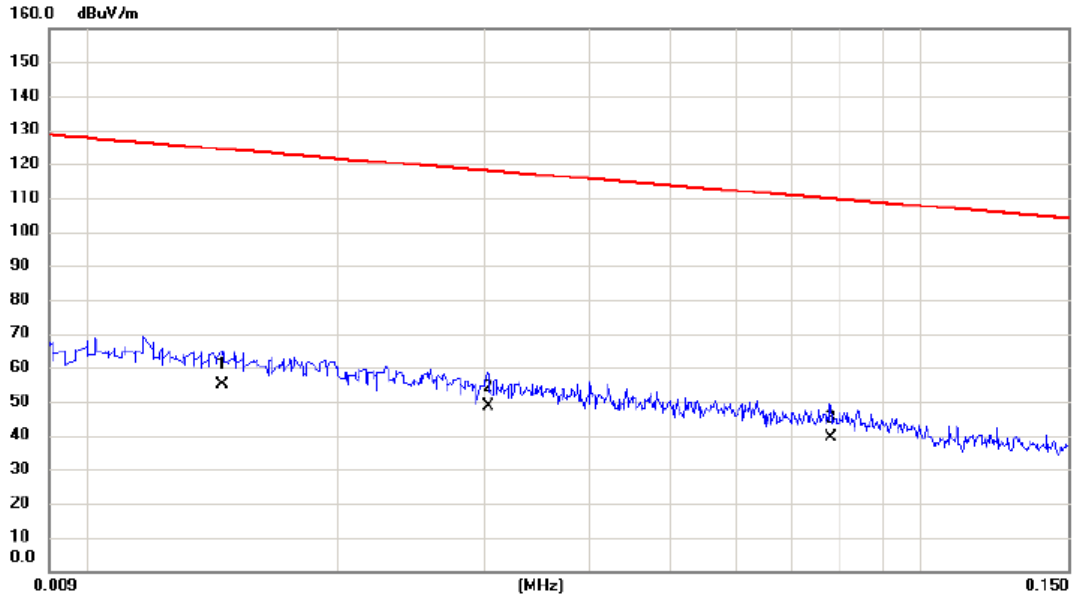

No.	Mk.	Freq. MHz	Reading Level dBuV	Correct Factor dB	Measure- ment dBuV/m	Limit dBuV/m	Margin dB	Detector	Comment
1		0.0145	34.60	20.34	54.94	124.38	-69.44	AVG	
2	*	0.0303	29.23	19.31	48.54	117.98	-69.44	AVG	
3		0.0780	21.23	18.16	39.39	109.76	-70.37	AVG	

Test Mode: TX MODE_Adapter: RD1201500-C55-81MG

Ant 90°

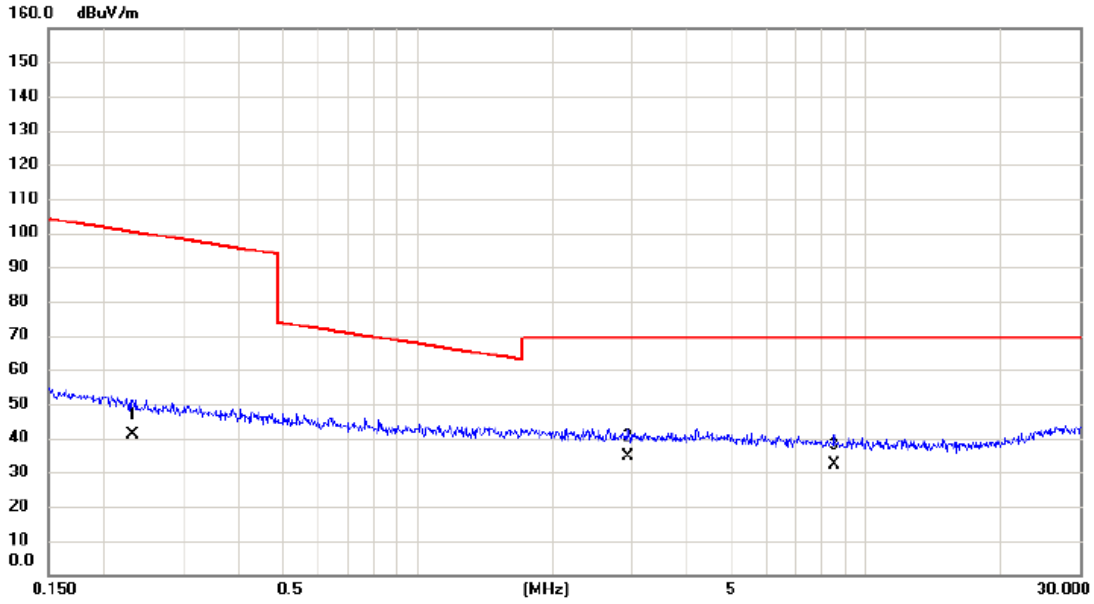

No.	Mk.	Freq. MHz	Reading Level dBuV	Correct Factor dB	Measure- ment dBuV/m	Limit dBuV/m	Margin dB	Detector	Comment
1		0.2316	24.48	16.71	41.19	100.31	-59.12	AVG	
2	*	2.9463	19.21	15.25	34.46	69.54	-35.08	QP	
3		8.5011	18.25	13.94	32.19	69.54	-37.35	QP	

Test Mode: TX MODE _Adapter: RD1201500-C55-24MG

Ant 0°

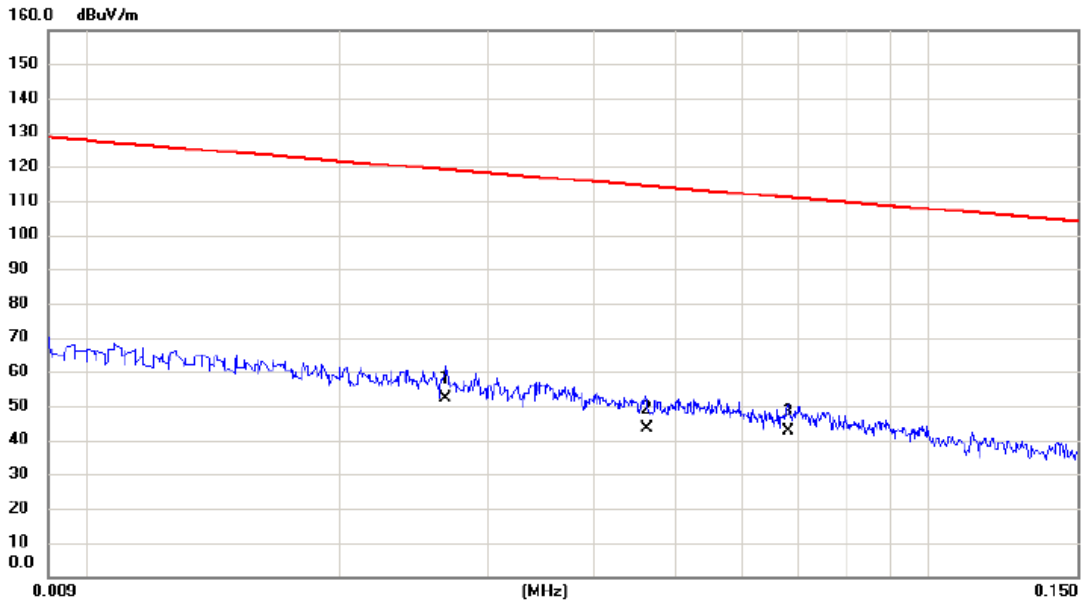

No.	Mk.	Freq. MHz	Reading Level dBuV	Correct Factor dB	Measure- ment dBuV/m	Limit dBuV/m	Margin dB	Detector	Comment
1	*	0.0267	32.65	19.42	52.07	119.07	-67.00	AVG	
2		0.0463	24.47	18.83	43.30	114.29	-70.99	AVG	
3		0.0680	24.36	18.37	42.73	110.95	-68.22	AVG	

Test Mode: TX MODE _Adapter: RD1201500-C55-24MG

Ant 0°

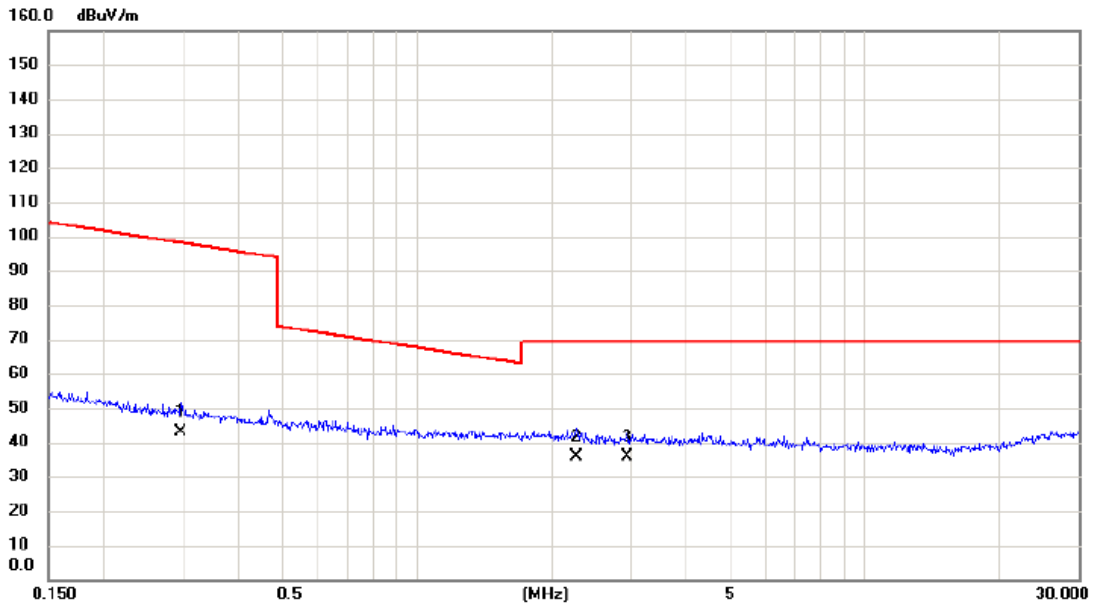

No.	Mk.	Freq. MHz	Reading Level dBuV	Correct Factor dB	Measure- ment dBuV/m	Limit dBuV/m	Margin dB	Detector	Comment
1		0.2971	26.54	16.62	43.16	98.15	-54.99	AVG	
2		2.2726	20.38	15.44	35.82	69.54	-33.72	QP	
3	*	2.9463	20.67	15.25	35.92	69.54	-33.62	QP	

Test Mode: TX MODE _Adapter: RD1201500-C55-24MG

Ant 90°

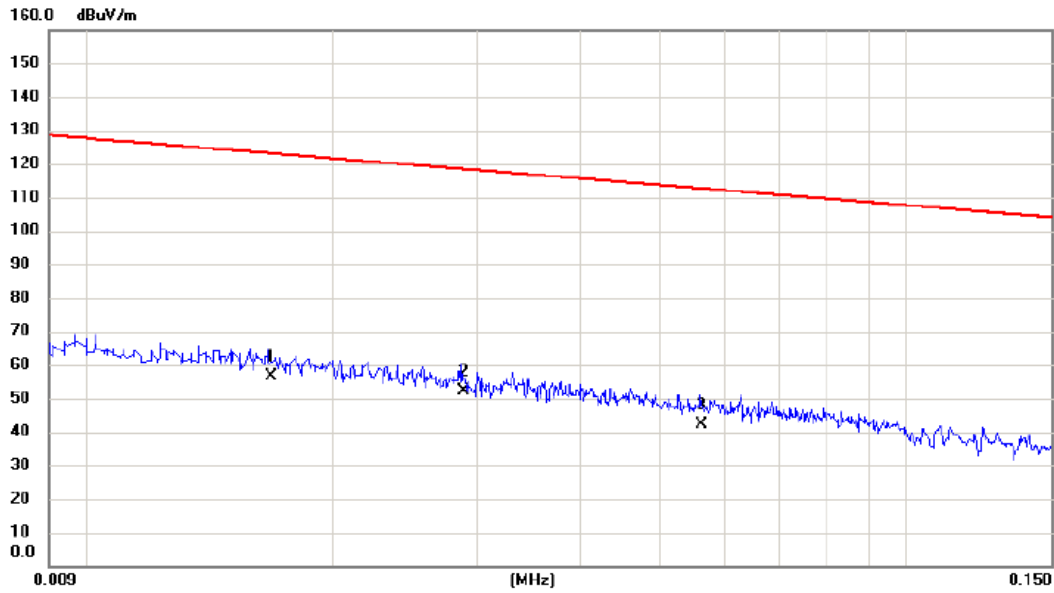

No.	Mk.	Freq. MHz	Reading Level dBuV	Correct Factor dB	Measure- ment dBuV/m	Limit dBuV/m	Margin dB	Detector	Comment
1		0.0168	36.58	20.04	56.62	123.10	-66.48	AVG	
2	*	0.0288	32.69	19.36	52.05	118.42	-66.37	AVG	
3		0.0562	23.55	18.61	42.16	112.61	-70.45	AVG	

Test Mode: TX MODE _Adapter: RD1201500-C55-24MG

Ant 90°

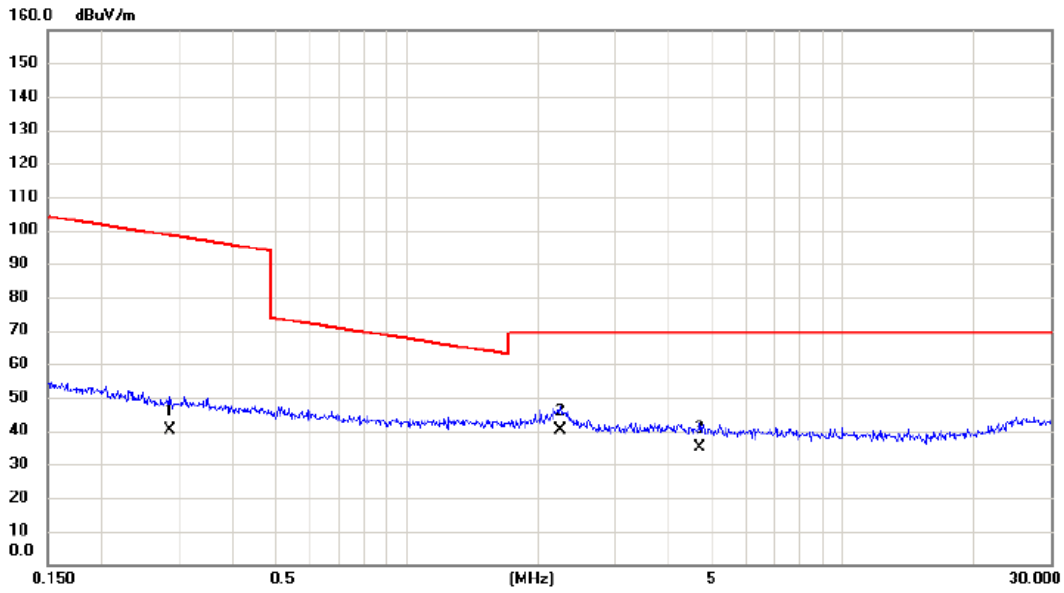

No.	Mk.	Freq. MHz	Reading Level dBuV	Correct Factor dB	Measure- ment dBuV/m	Limit dBuV/m	Margin dB	Detector	Comment
1		0.2863	23.58	16.63	40.21	98.47	-58.26	AVG	
2	*	2.2486	24.68	15.44	40.12	69.54	-29.42	QP	
3		4.6964	20.35	14.54	34.89	69.54	-34.65	QP	

Test Mode: TX MODE _Adapter: RD1202000-C55-29MG

Ant 0°

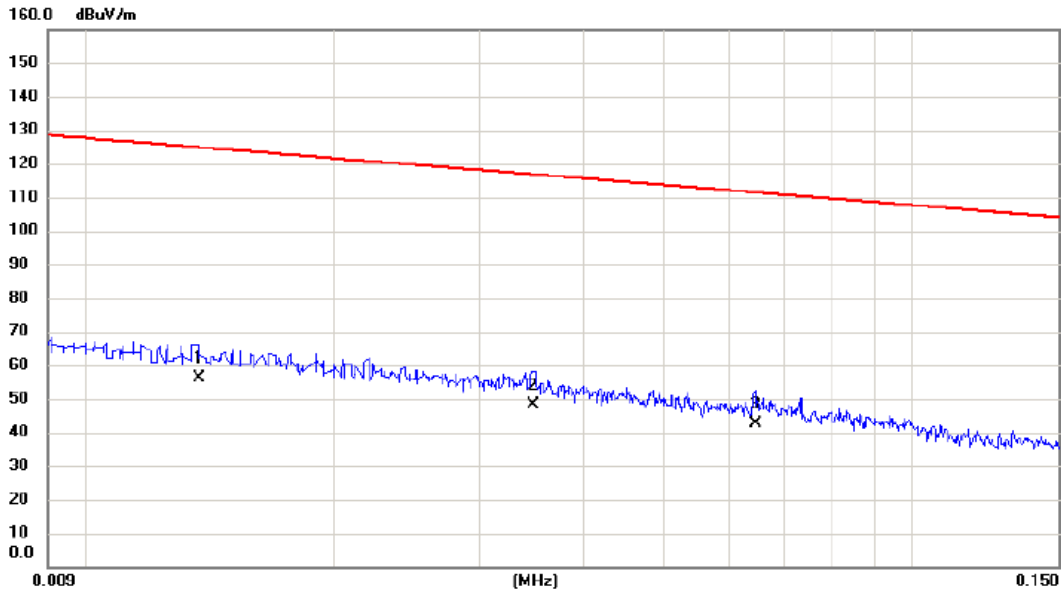

No.	Mk.	Freq. MHz	Reading Level dBuV	Correct Factor dB	Measure- ment dBuV/m	Limit dBuV/m	Margin dB	Detector	Comment
1	*	0.0137	35.87	20.44	56.31	124.87	-68.56	AVG	
2		0.0348	28.89	19.18	48.07	116.77	-68.70	AVG	
3		0.0646	24.02	18.44	42.46	111.40	-68.94	AVG	

Test Mode: TX MODE _Adapter: RD1202000-C55-29MG

Ant 0°

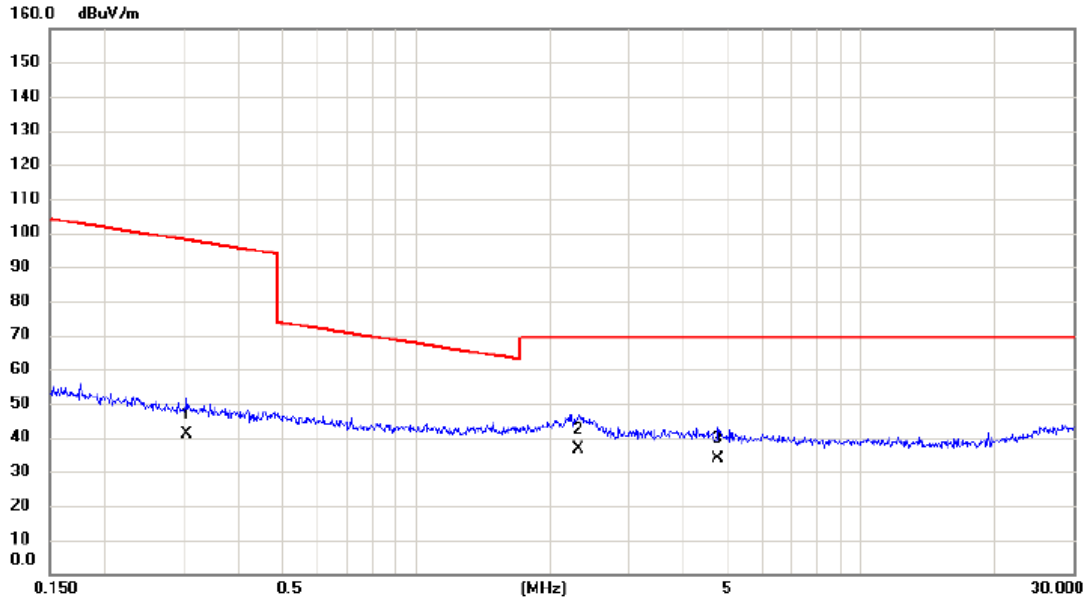

No.	Mk.	Freq. MHz	Reading Level dBuV	Correct Factor dB	Measurement dBuV/m	Limit dBuV/m	Margin dB	Detector	Comment
1		0.3051	24.56	16.62	41.18	97.92	-56.74	AVG	
2	*	2.3090	21.28	15.43	36.71	69.54	-32.83	QP	
3		4.7716	19.31	14.51	33.82	69.54	-35.72	QP	

Test Mode: TX MODE _Adapter: RD1202000-C55-29MG

Ant 90°

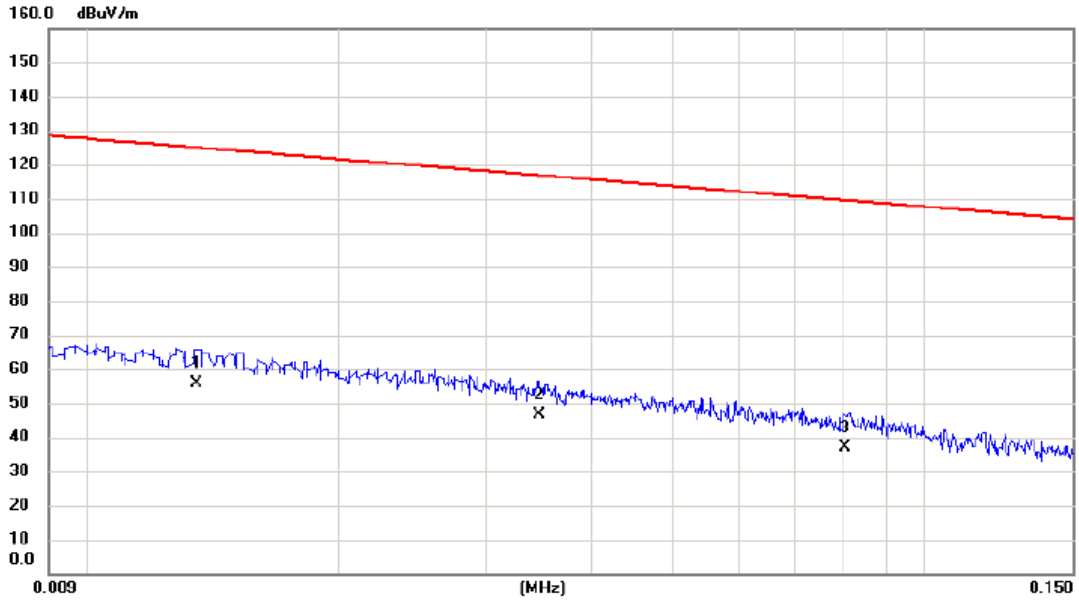

No.	Mk.	Freq. MHz	Reading Level dBuV	Correct Factor dB	Measure- ment dBuV/m	Limit dBuV/m	Margin dB	Detector	Comment
1	*	0.0135	35.31	20.47	55.78	125.00	-69.22	AVG	
2		0.0347	27.41	19.18	46.59	116.80	-70.21	AVG	
3		0.0803	19.05	18.10	37.15	109.51	-72.36	AVG	

Test Mode: TX MODE_Adapter: RD1202000-C55-29MG

Ant 90°

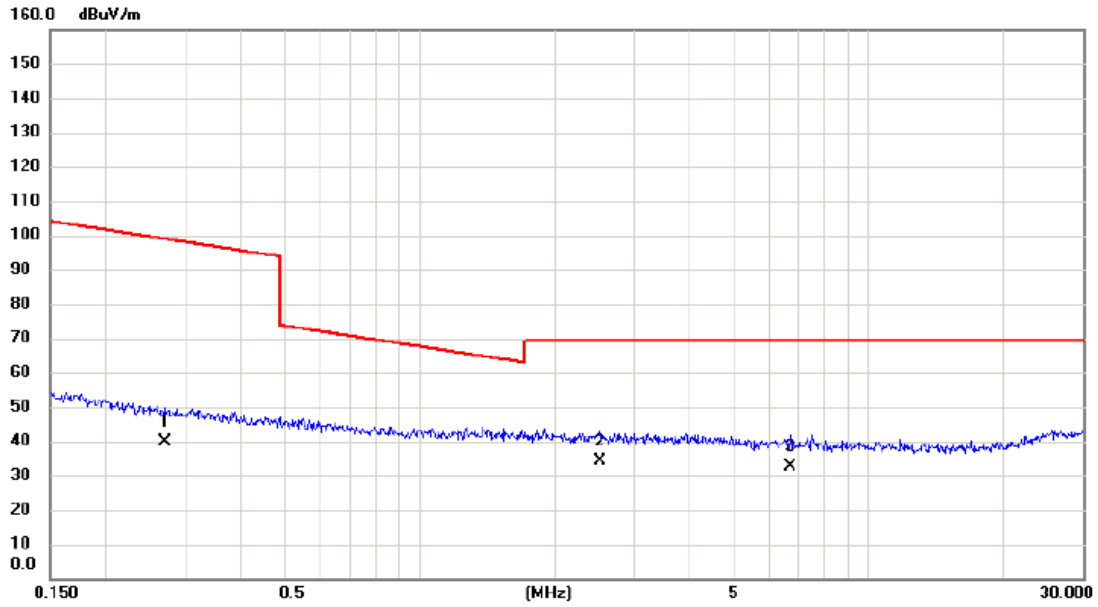

No.	Mk.	Freq. MHz	Reading Level dBuV	Correct Factor dB	Measure- ment dBuV/m	Limit dBuV/m	Margin dB	Detector	Comment
1		0.2714	23.02	16.64	39.66	98.93	-59.27	AVG	
2	*	2.5133	18.77	15.37	34.14	69.54	-35.40	QP	
3		6.6978	18.54	14.16	32.70	69.54	-36.84	QP	

Internal Antenna

Test Mode: TX MODE _Adapter: RD1201500-C55-81MG

Ant 0°

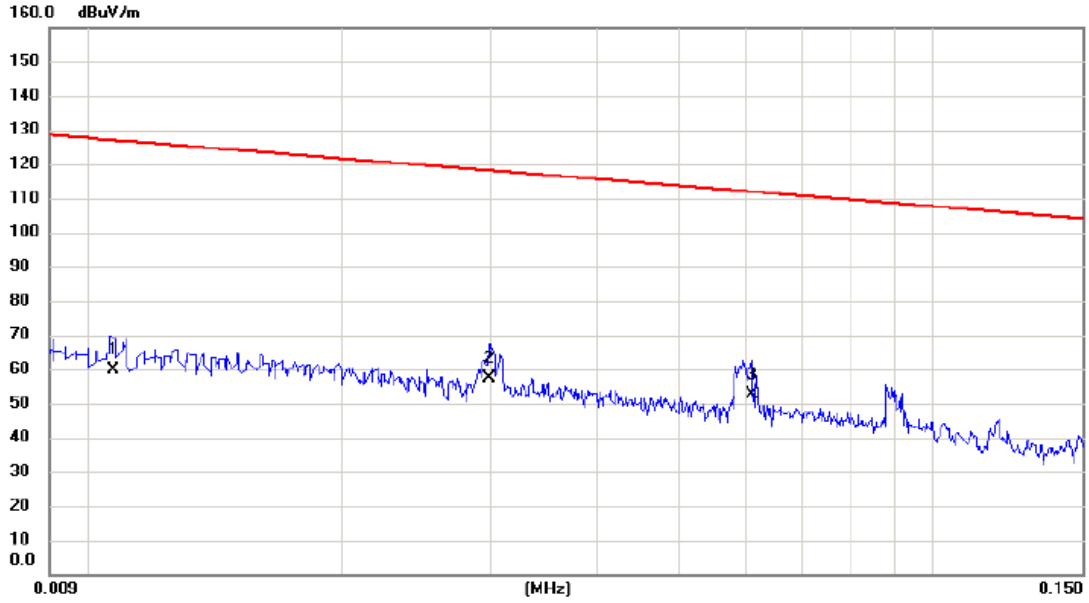

No.	Mk.	Freq. MHz	Reading Level dBuV	Correct Factor dB	Measure- ment dBuV/m	Limit dBuV/m	Margin dB	Detector	Comment
1		0.0107	39.01	20.83	59.84	127.02	-67.18	AVG	
2		0.0298	38.27	19.33	57.60	118.12	-60.52	AVG	
3	*	0.0610	34.23	18.51	52.74	111.90	-59.16	AVG	

Test Mode: TX MODE _Adapter: RD1201500-C55-81MG

Ant 0°

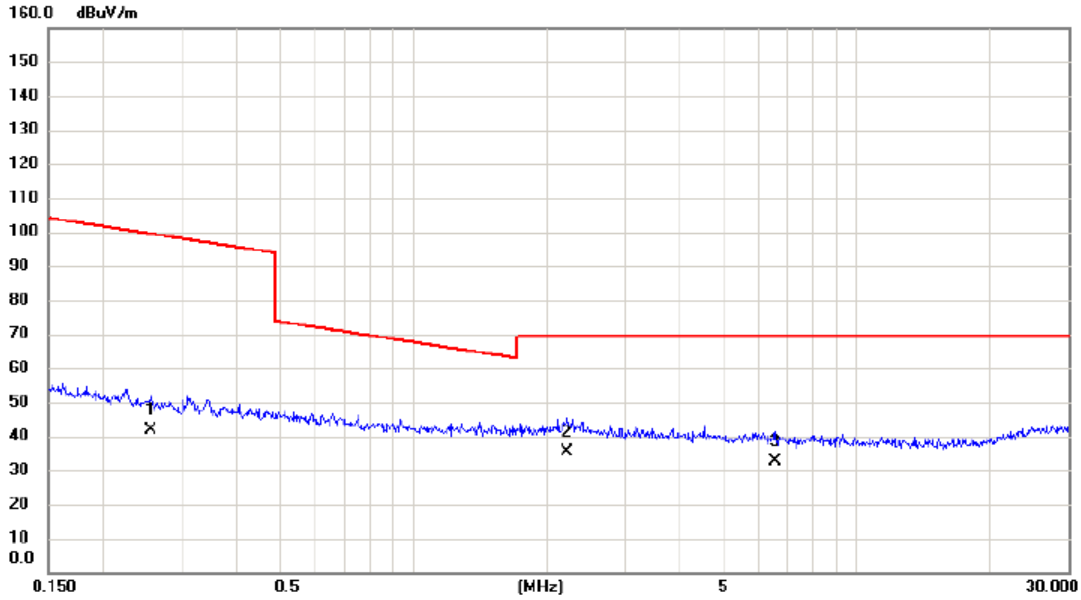

No.	Mk.	Freq. MHz	Reading Level dBuV	Correct Factor dB	Measure- ment dBuV/m	Limit dBuV/m	Margin dB	Detector	Comment
1		0.2562	25.23	16.66	41.89	99.43	-57.54	AVG	
2	*	2.2250	19.88	15.44	35.32	69.54	-34.22	QP	
3		6.5227	18.38	14.18	32.56	69.54	-36.98	QP	

Test Mode: TX MODE _Adapter: RD1201500-C55-81MG

Ant 90°

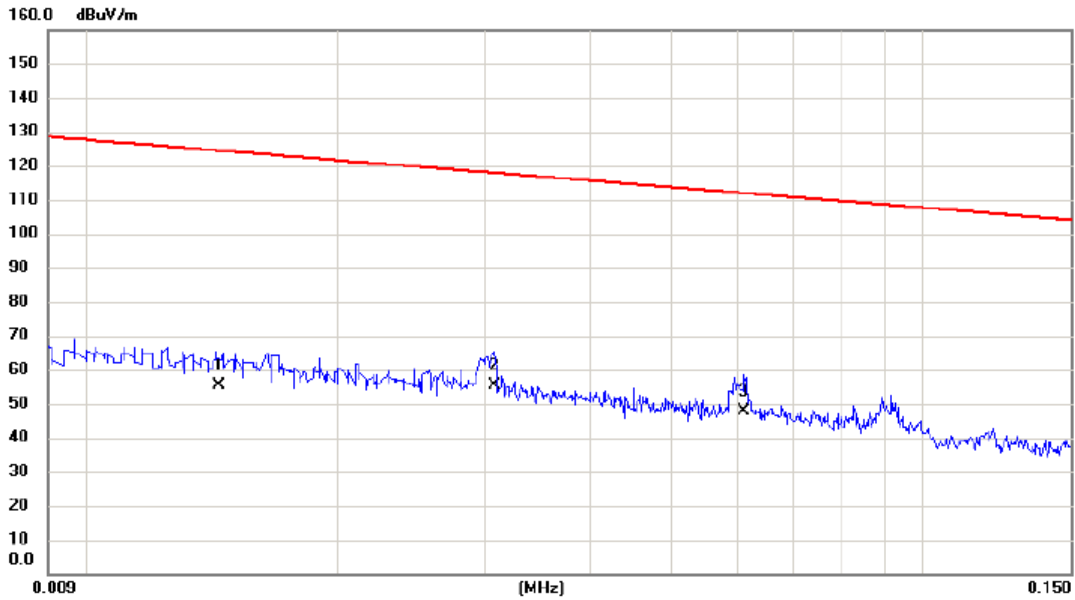

No.	Mk.	Freq. MHz	Reading Level dBuV	Correct Factor dB	Measure- ment dBuV/m	Limit dBuV/m	Margin dB	Detector	Comment
1		0.0144	35.06	20.35	55.41	124.44	-69.03	AVG	
2	*	0.0308	36.04	19.30	55.34	117.83	-62.49	AVG	
3		0.0610	29.39	18.51	47.90	111.90	-64.00	AVG	

Test Mode: TX MODE _Adapter: RD1201500-C55-81MG

Ant 90°

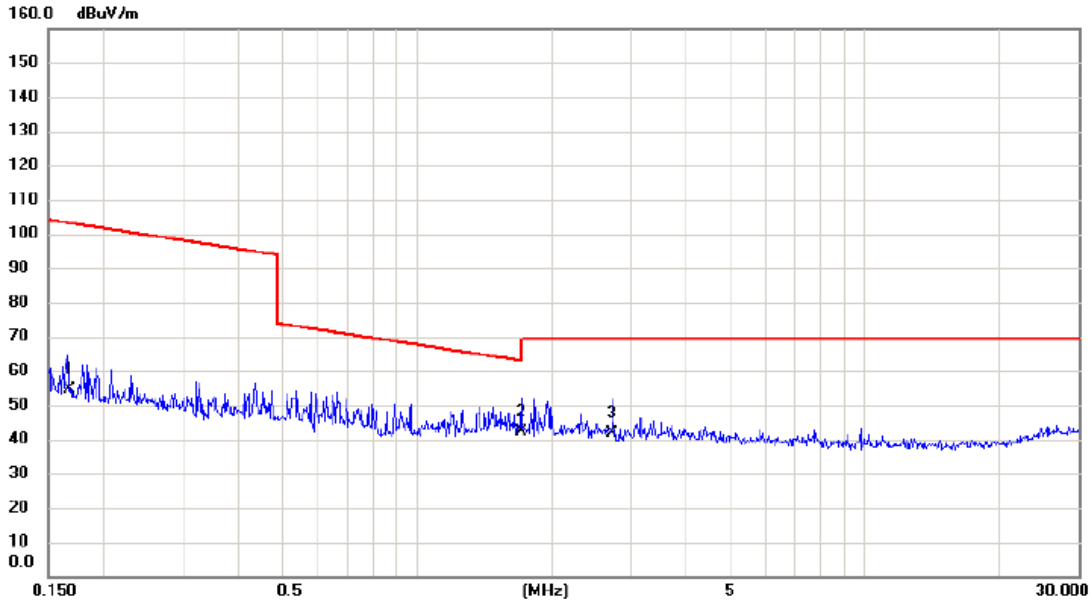

No.	Mk.	Freq. MHz	Reading Level dBuV	Correct Factor dB	Measure- ment dBuV/m	Limit dBuV/m	Margin dB	Detector	Comment
1		0.1668	37.54	16.90	54.44	103.16	-48.72	AVG	
2	*	1.7071	26.64	15.62	42.26	69.54	-27.28	QP	
3		2.7212	26.68	15.30	41.98	69.54	-27.56	QP	

Test Mode: TX MODE _Adapter: RD1201500-C55-24MG

Ant 0°

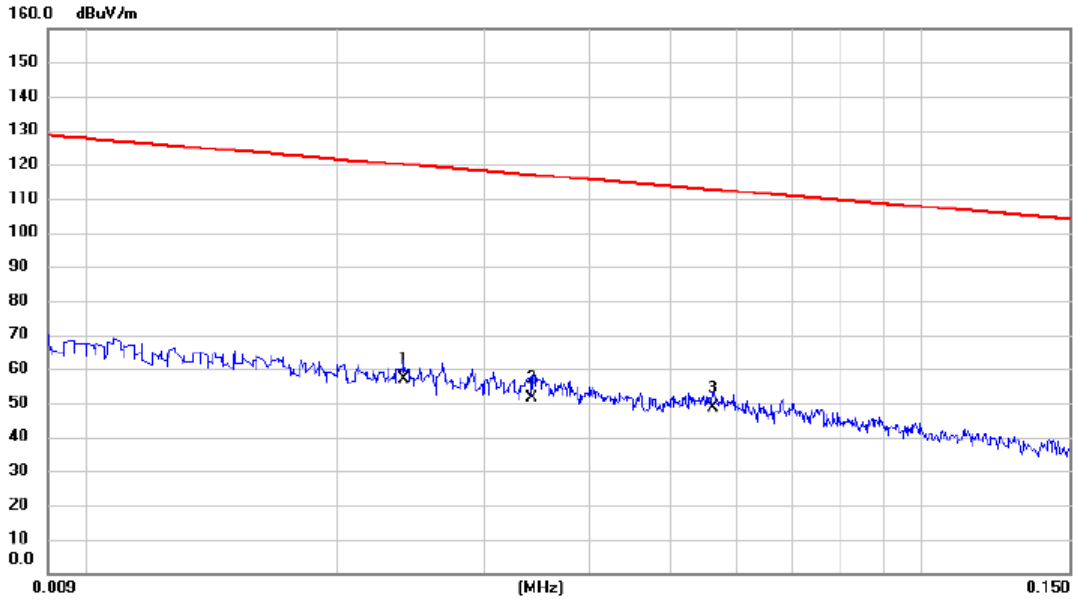

No.	Mk.	Freq. MHz	Reading Level dBuV	Correct Factor dB	Measure- ment dBuV/m	Limit dBuV/m	Margin dB	Detector	Comment
1	*	0.024	37.33	19.50	56.83	120.00	-63.17	AVG	
2		0.034	32.29	19.19	51.48	116.92	-65.44	AVG	
3		0.056	30.11	18.60	48.71	112.59	-63.88	AVG	

Test Mode: TX MODE _Adapter: RD1201500-C55-24MG

Ant 0°

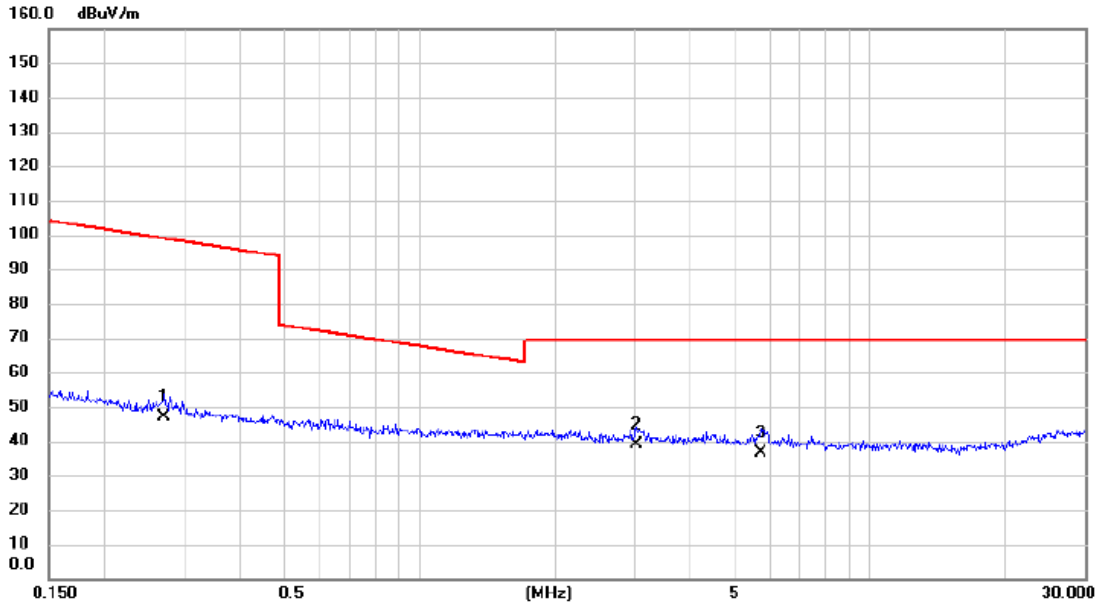

No.	Mk.	Freq. MHz	Reading Level dBuV	Correct Factor dB	Measure- ment dBuV/m	Limit dBuV/m	Margin dB	Detector	Comment
1		0.270	30.49	16.64	47.13	98.97	-51.84	AVG	
2	*	3.025	23.59	15.22	38.81	69.54	-30.73	QP	
3		5.744	22.37	14.28	36.65	69.54	-32.89	QP	

Test Mode: TX MODE _Adapter: RD1201500-C55-24MG

Ant 90°

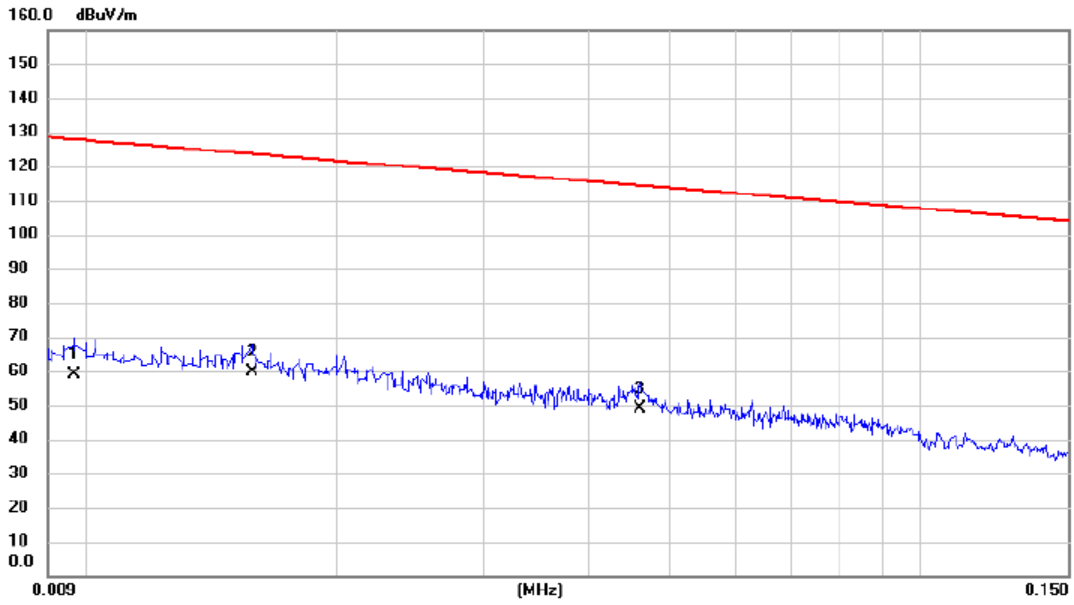

No.	Mk.	Freq.	Reading Level	Correct Factor	Measurement	Limit	Margin	Detector	Comment
		MHz	dBuV	dB	dBuV/m	dBuV/m	dB		
1		0.010	37.92	20.98	58.90	127.87	-68.97	AVG	
2	*	0.016	39.55	20.17	59.72	123.63	-63.91	AVG	
3		0.046	30.08	18.84	48.92	114.33	-65.41	AVG	

Test Mode: TX MODE _Adapter: RD1201500-C55-24MG

Ant 90°

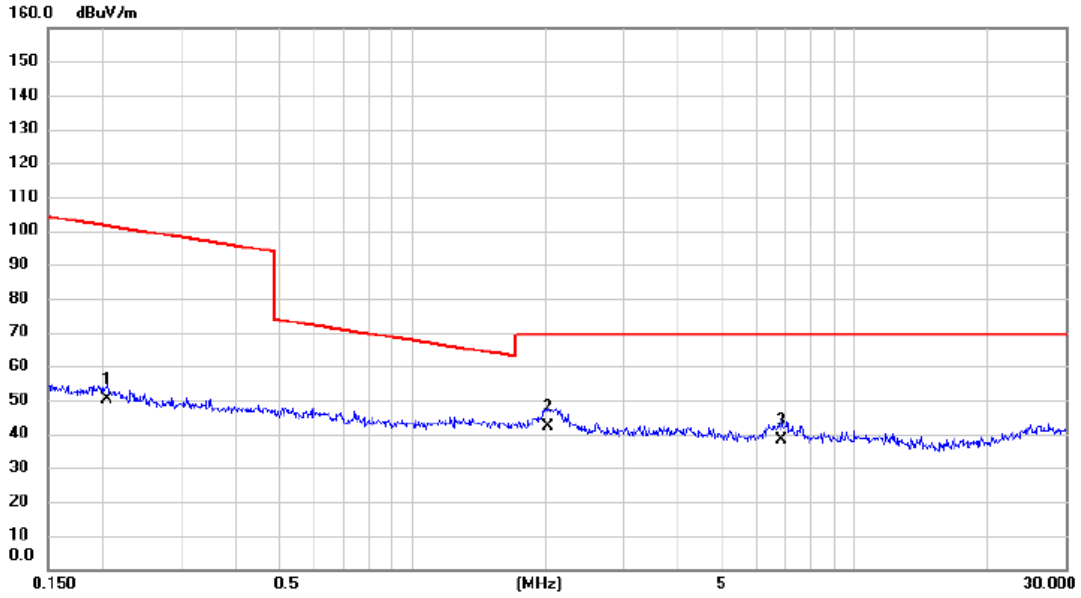

No. Mk.	Freq. MHz	Reading Level dBuV	Correct Factor dB	Measurement dBuV/m	Limit dBuV/m	Margin dB	Detector	Comment
1	0.204	33.59	16.79	50.38	101.41	-51.03	AVG	
2 *	2.033	26.51	15.50	42.01	69.54	-27.53	QP	
3	6.841	24.18	14.14	38.32	69.54	-31.22	QP	

Test Mode: TX MODE _Adapter: RD1202000-C55-29MG

Ant 0°

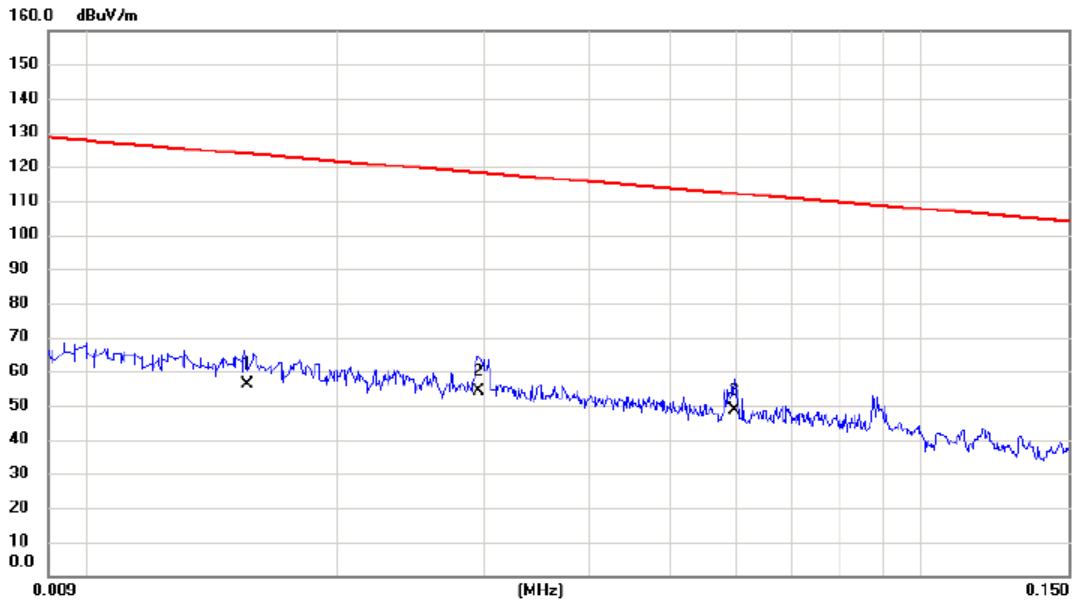

No.	Mk.	Freq. MHz	Reading Level dBuV	Correct Factor dB	Measure- ment dBuV/m	Limit dBuV/m	Margin dB	Detector	Comment
1		0.0156	36.02	20.19	56.21	123.74	-67.53	AVG	
2		0.0295	34.74	19.34	54.08	118.21	-64.13	AVG	
3	*	0.0598	29.89	18.53	48.42	112.07	-63.65	AVG	

Test Mode: TX MODE_Adapter: RD1202000-C55-29MG

Ant 0°

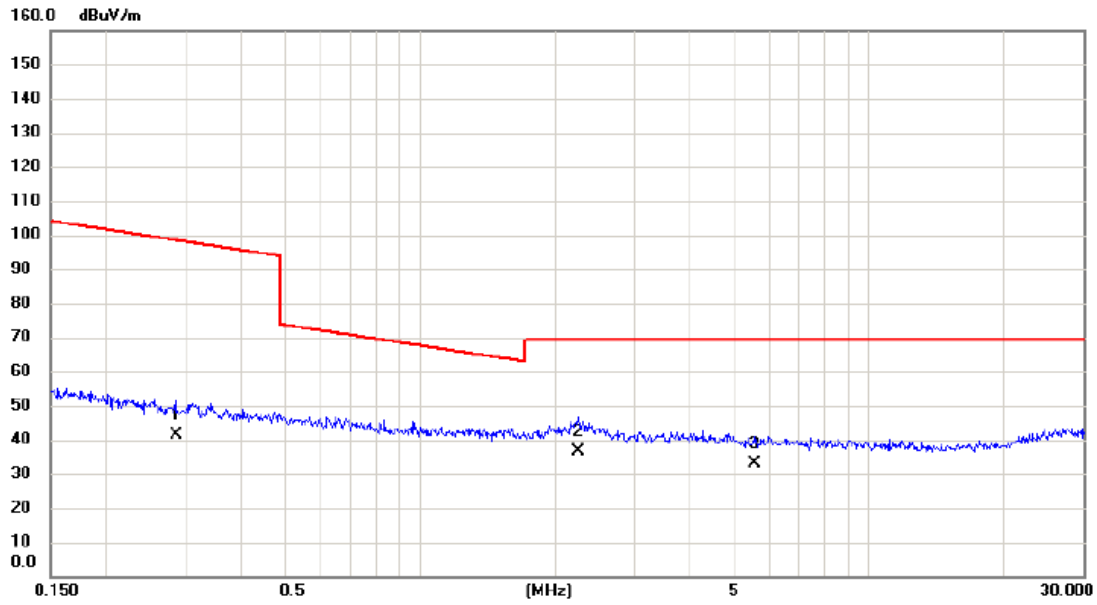

No.	Mk.	Freq. MHz	Reading Level dBuV	Correct Factor dB	Measure- ment dBuV/m	Limit dBuV/m	Margin dB	Detector	Comment
1		0.2863	24.89	16.63	41.52	98.47	-56.95	AVG	
2	*	2.2486	21.04	15.44	36.48	69.54	-33.06	QP	
3		5.5641	18.64	14.30	32.94	69.54	-36.60	QP	

Test Mode: TX MODE _Adapter: RD1202000-C55-29MG

Ant 90°

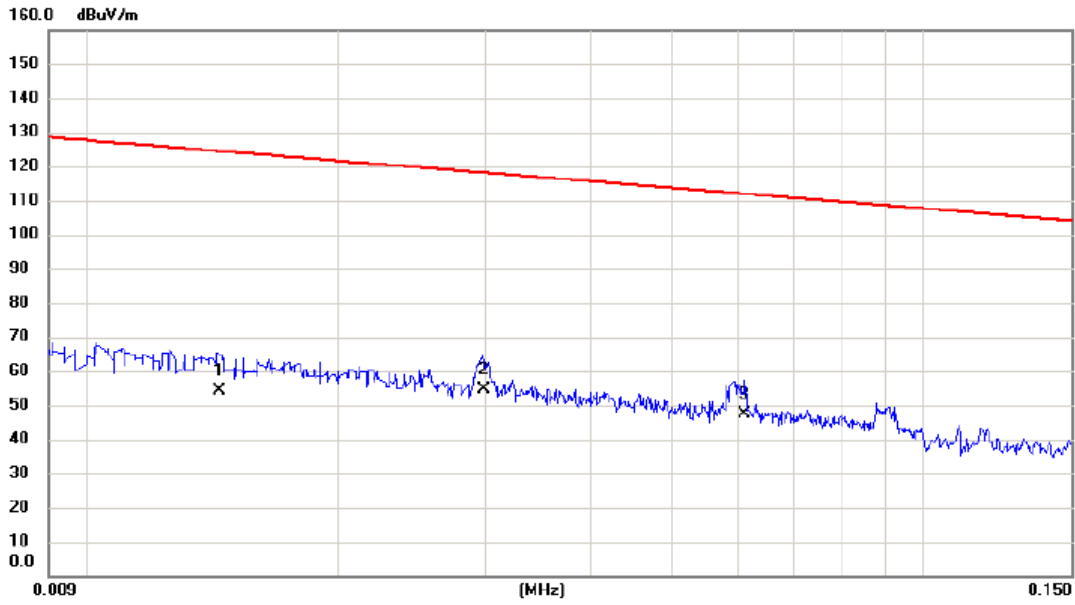

No.	Mk.	Freq. MHz	Reading Level dBuV	Correct Factor dB	Measure- ment dBuV/m	Limit dBuV/m	Margin dB	Detector	Comment
1		0.0144	34.05	20.35	54.40	124.44	-70.04	AVG	
2	*	0.0298	35.23	19.33	54.56	118.12	-63.56	AVG	
3		0.0610	28.77	18.51	47.28	111.90	-64.62	AVG	

Test Mode: TX MODE_Adapter: RD1202000-C55-29MG

Ant 90°

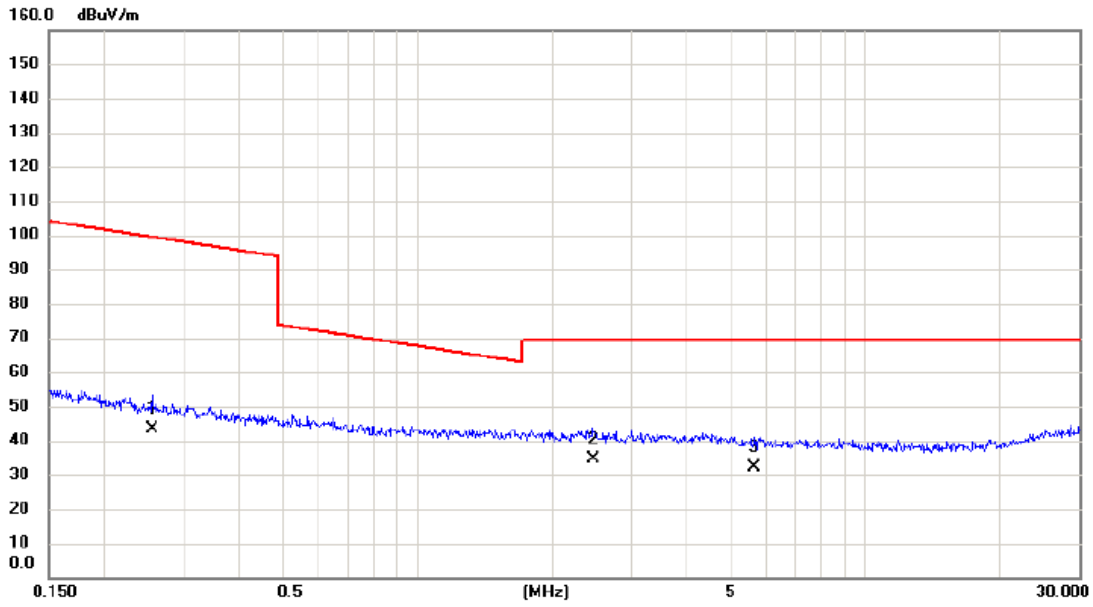

No.	Mk.	Freq. MHz	Reading Level dBuV	Correct Factor dB	Measurement dBuV/m	Limit dBuV/m	Margin dB	Detector	Comment
1		0.2562	26.75	16.66	43.41	99.43	-56.02	AVG	
2	*	2.4606	19.32	15.38	34.70	69.54	-34.84	QP	
3		5.6531	17.91	14.29	32.20	69.54	-37.34	QP	

APPENDIX C - RADIATED EMISSION (30MHZ TO 1000MHZ)

External Antenna

Test Mode: UNII-2A/TX A Mode 5260MHz_Adapter: RD1201500-C55-81MG

Vertical

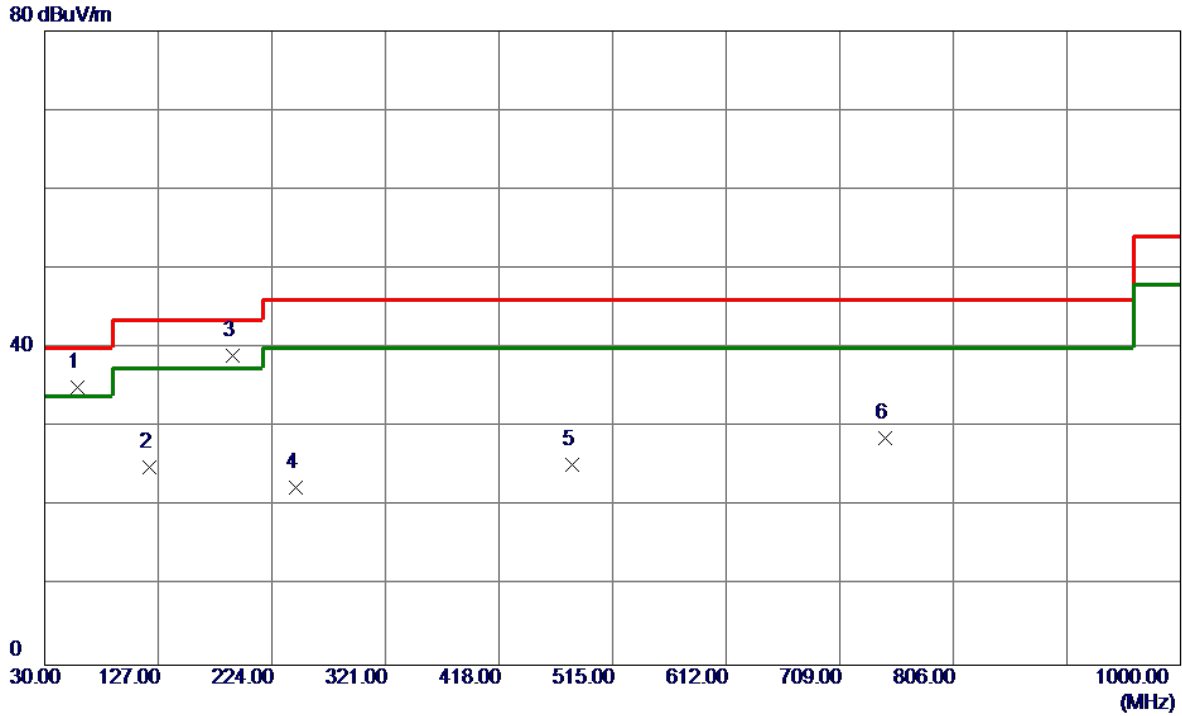

No.	Freq. MHz	Reading Level dBuV/m	Correct Factor dB	Measure ment dBuV/m	Limit dBuV/m	Margin dB	Detector	Comment
1	58.1300	49.15	-14.13	35.02	40.00	-4.98	Peak	
2	119.2400	40.42	-15.46	24.96	43.50	-18.54	Peak	
3 *	191.0200	52.03	-12.94	39.09	43.50	-4.41	Peak	
4	244.3700	36.95	-14.59	22.36	46.00	-23.64	Peak	
5	480.0800	34.47	-9.21	25.26	46.00	-20.74	Peak	
6	747.8000	31.14	-2.51	28.63	46.00	-17.37	Peak	

Test Mode: UNII-2A/TX A Mode 5260MHz_Adapter: RD1201500-C55-81MG

Horizontal

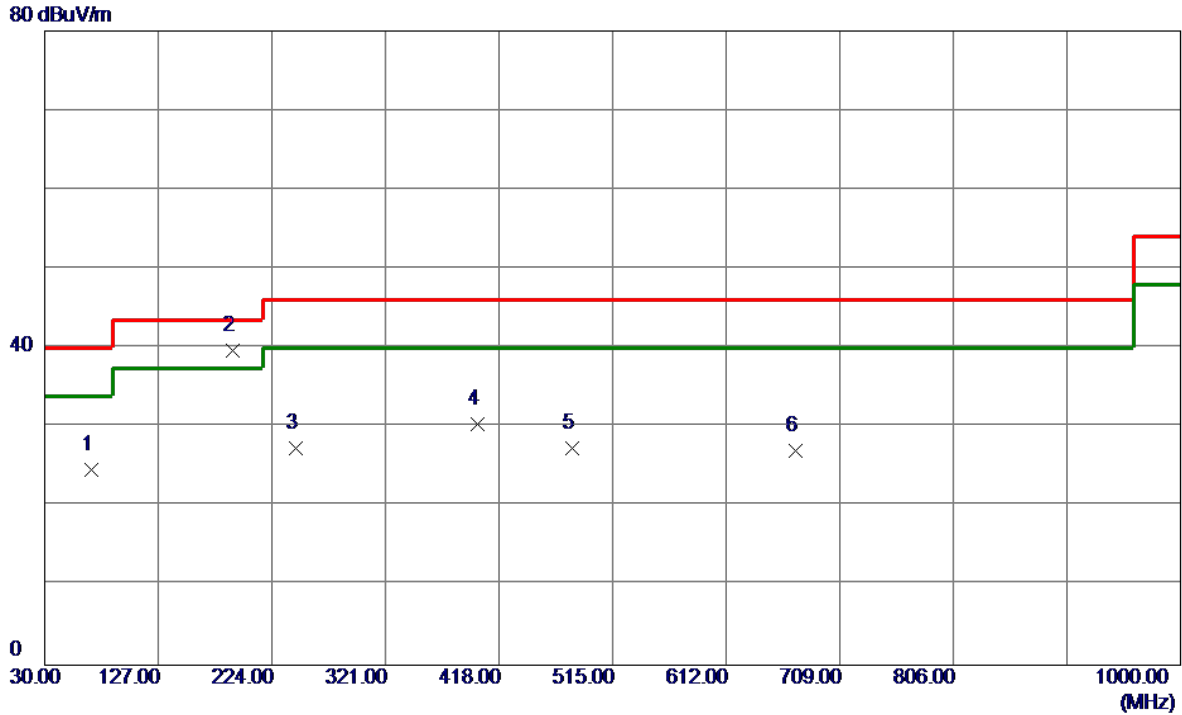

No.	Freq. MHz	Reading Level dBuV/m	Correct Factor dB	Measure ment dBuV/m	Limit dBuV/m	Margin dB	Detector	Comment
1	69.7699	41.16	-16.46	24.70	40.00	-15.30	Peak	
2 *	190.0500	52.56	-12.85	39.71	43.50	-3.79	QP	
3	244.3700	41.97	-14.59	27.38	46.00	-18.62	Peak	
4	399.5700	41.75	-11.37	30.38	46.00	-15.62	Peak	
5	480.0800	36.57	-9.21	27.36	46.00	-18.64	Peak	
6	671.1700	31.90	-4.83	27.07	46.00	-18.93	Peak	

Test Mode: UNII-2A/TX A Mode 5300MHz_Adapter: RD1201500-C55-81MG

Vertical

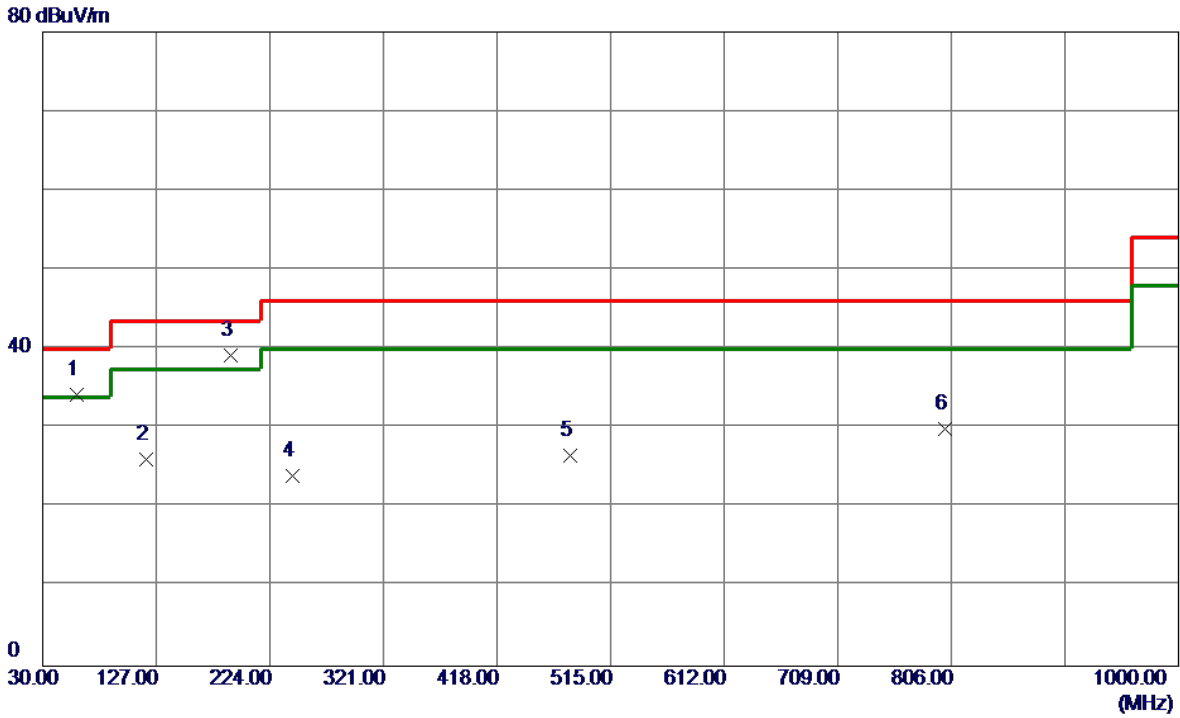

No.	Freq. MHz	Reading Level dBuV/m	Correct Factor dB	Measure ment dBuV/m	Limit dBuV/m	Margin dB	Detector	Comment
1	59.1000	48.47	-14.22	34.25	40.00	-5.75	Peak	
2	118.2700	41.63	-15.53	26.10	43.50	-17.40	Peak	
3 *	191.0200	52.20	-12.94	39.26	43.50	-4.24	Peak	
4	243.4000	38.60	-14.54	24.06	46.00	-21.94	Peak	
5	480.0800	35.79	-9.21	26.58	46.00	-19.42	Peak	
6	800.1800	31.29	-1.36	29.93	46.00	-16.07	Peak	

Test Mode: UNII-2A/TX A Mode 5300MHz_Adapter: RD1201500-C55-81MG

Horizontal

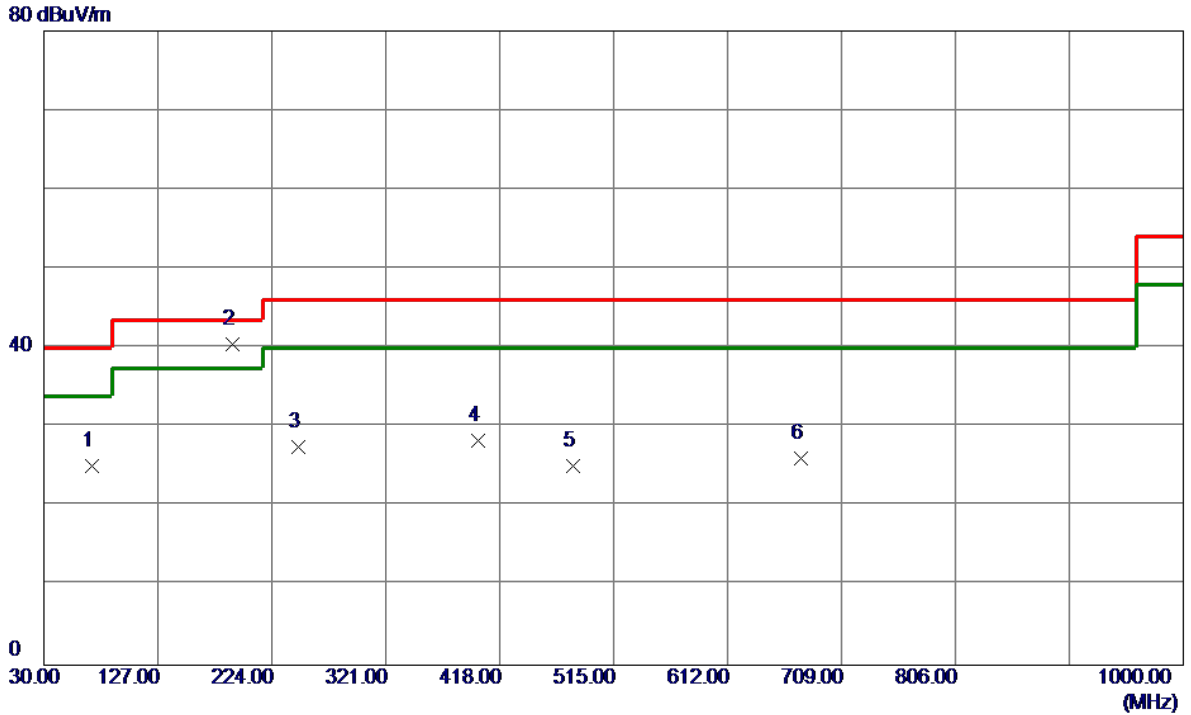

No.	Freq. MHz	Reading Level dBuV/m	Correct Factor dB	Measure ment dBuV/m	Limit dBuV/m	Margin dB	Detector	Comment
1	70.7400	41.67	-16.60	25.07	40.00	-14.93	Peak	
2 *	191.0200	53.36	-12.94	40.42	43.50	-3.08	QP	
3	246.3100	42.21	-14.69	27.52	46.00	-18.48	Peak	
4	399.5700	39.74	-11.37	28.37	46.00	-17.63	Peak	
5	480.0800	34.31	-9.21	25.10	46.00	-20.90	Peak	
6	674.0800	30.85	-4.74	26.11	46.00	-19.89	Peak	

Test Mode: UNII-2A/TX A Mode 5320MHz_Adapter: RD1201500-C55-81MG

Vertical

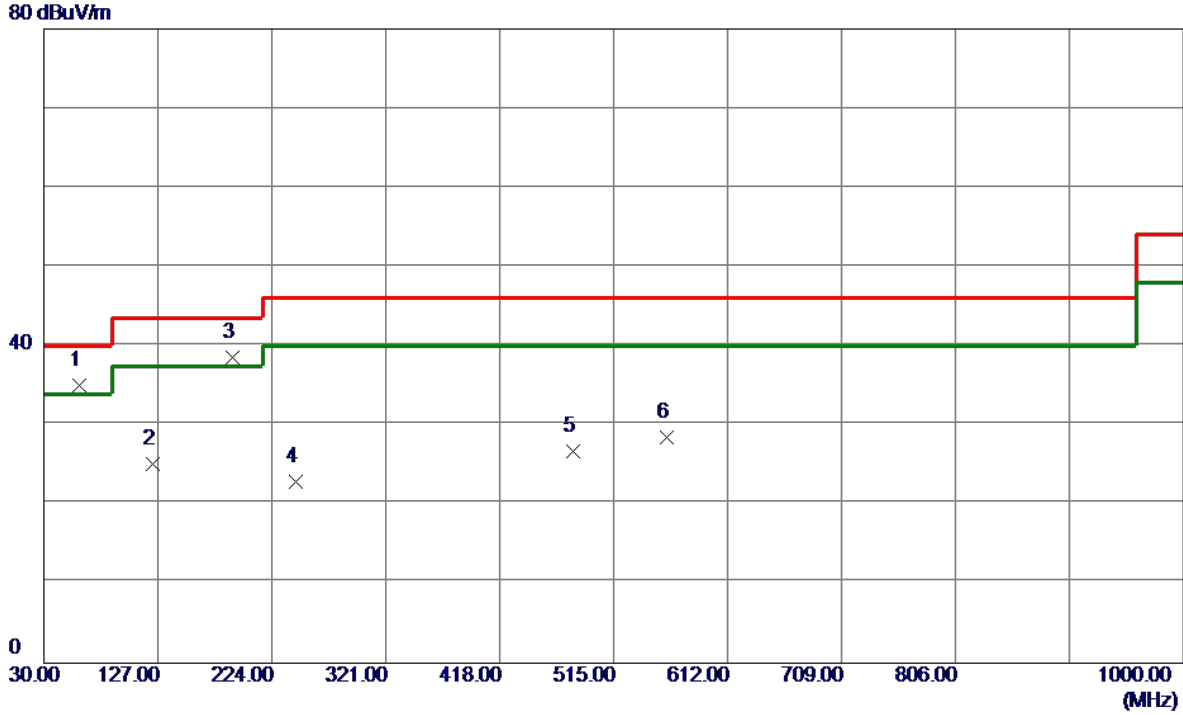

No.	Freq. MHz	Reading Level dBuV/m	Correct Factor dB	Measure ment dBuV/m	Limit dBuV/m	Margin dB	Detector	Comment
1 *	60.0700	49.41	-14.32	35.09	40.00	-4.91	Peak	
2	123.1200	40.26	-15.18	25.08	43.50	-18.42	Peak	
3	191.0200	51.46	-12.94	38.52	43.50	-4.98	Peak	
4	244.3700	37.51	-14.59	22.92	46.00	-23.08	Peak	
5	480.0800	35.89	-9.21	26.68	46.00	-19.32	Peak	
6	560.5900	35.87	-7.44	28.43	46.00	-17.57	Peak	

Test Mode: UNII-2A/TX A Mode 5320MHz_Adapter: RD1201500-C55-81MG

Horizontal

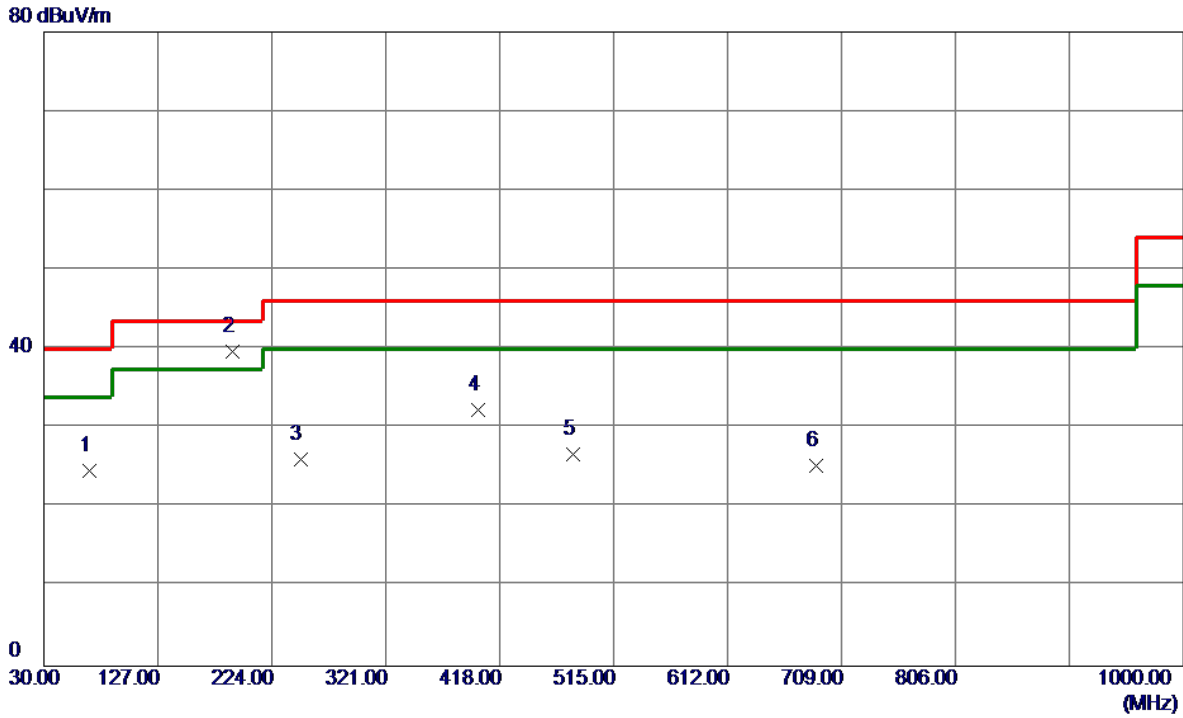

No.	Freq. MHz	Reading Level dBuV/m	Correct Factor dB	Measure ment dBuV/m	Limit dBuV/m	Margin dB	Detector	Comment
1	68.8000	40.85	-16.20	24.65	40.00	-15.35	Peak	
2 *	191.0200	52.55	-12.94	39.61	43.50	-3.89	QP	
3	248.2500	40.91	-14.79	26.12	46.00	-19.88	Peak	
4	399.5700	43.63	-11.37	32.26	46.00	-13.74	Peak	
5	480.0800	35.91	-9.21	26.70	46.00	-19.30	Peak	
6	687.6599	29.61	-4.32	25.29	46.00	-20.71	Peak	

Test Mode: UNII-2C/TX A Mode 5500MHz_Adapter: RD1201500-C55-81MG

Vertical

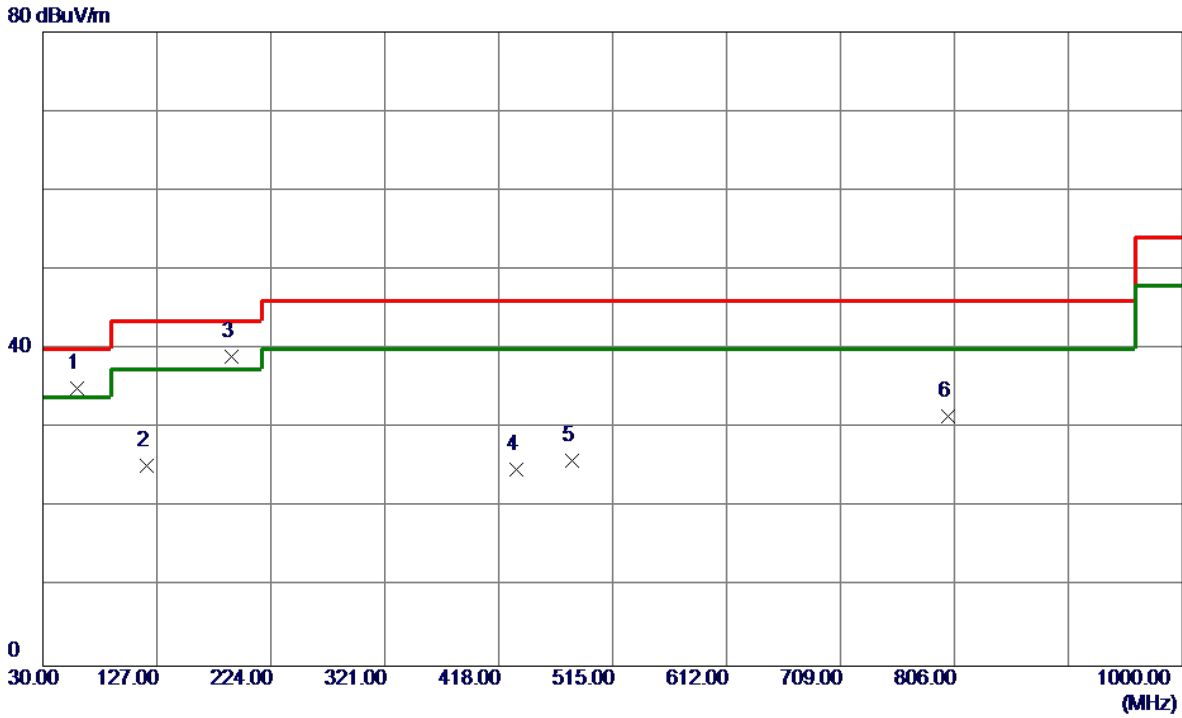

No.	Freq. MHz	Reading Level dBuV/m	Correct Factor dB	Measure ment dBuV/m	Limit dBuV/m	Margin dB	Detector	Comment
1	59.1000	49.22	-14.22	35.00	40.00	-5.00	Peak	
2	118.2700	40.78	-15.53	25.25	43.50	-18.25	Peak	
3 *	191.0200	51.99	-12.94	39.05	43.50	-4.45	Peak	
4	433.5200	35.23	-10.41	24.82	46.00	-21.18	Peak	
5	480.0800	35.19	-9.21	25.98	46.00	-20.02	Peak	
6	800.1800	32.85	-1.36	31.49	46.00	-14.51	Peak	

Test Mode: UNII-2C/TX A Mode 5500MHz_Adapter: RD1201500-C55-81MG

Horizontal

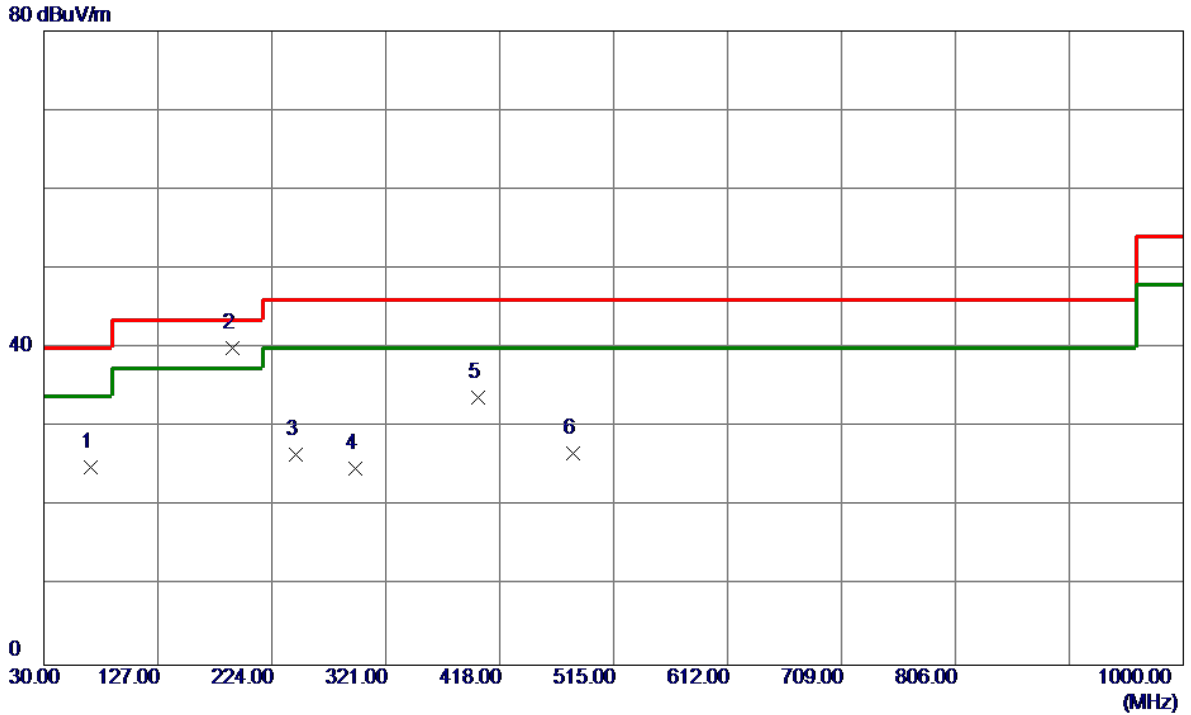

No.	Freq. MHz	Reading Level dBuV/m	Correct Factor dB	Measure ment dBuV/m	Limit dBuV/m	Margin dB	Detector	Comment
1	69.7699	41.48	-16.46	25.02	40.00	-14.98	Peak	
2 *	190.0500	52.80	-12.85	39.95	43.50	-3.55	QP	
3	244.3700	41.22	-14.59	26.63	46.00	-19.37	Peak	
4	294.8100	38.37	-13.54	24.83	46.00	-21.17	Peak	
5	399.5700	45.16	-11.37	33.79	46.00	-12.21	Peak	
6	480.0800	35.90	-9.21	26.69	46.00	-19.31	Peak	

Test Mode: UNII-2C/TX A Mode 5580MHz_Adapter: RD1201500-C55-81MG

Vertical

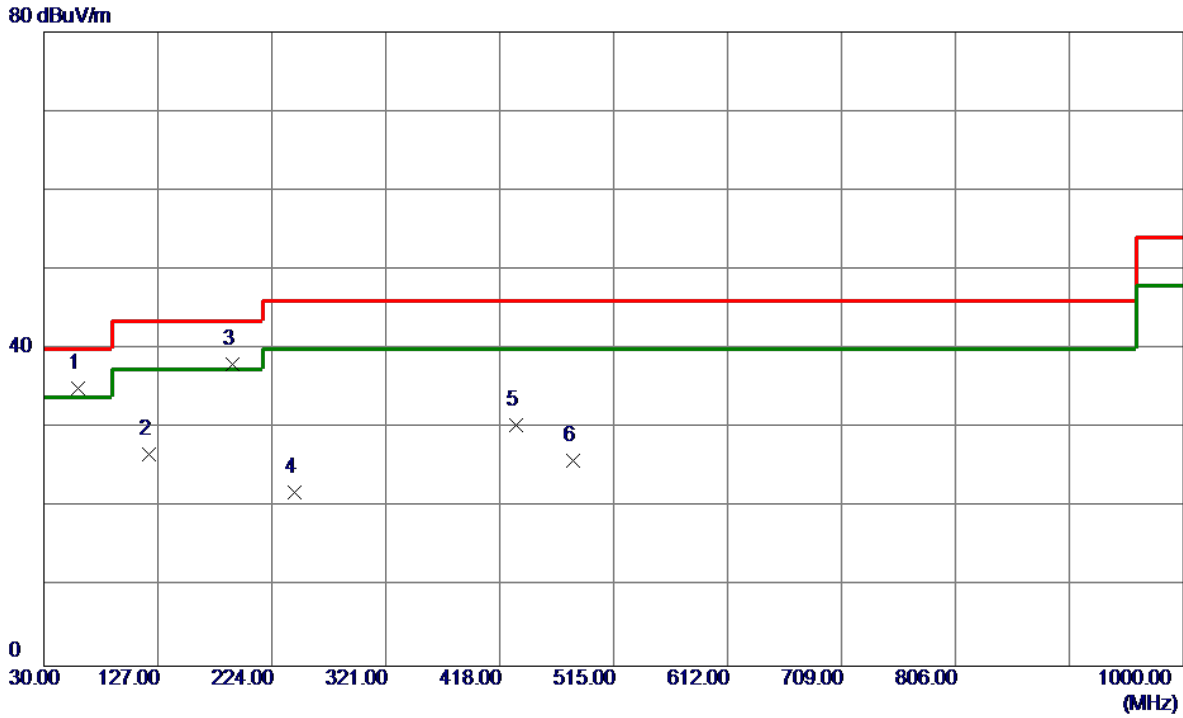

No.	Freq. MHz	Reading Level dBuV/m	Correct Factor dB	Measure ment dBuV/m	Limit dBuV/m	Margin dB	Detector	Comment
1 *	59.1000	49.22	-14.22	35.00	40.00	-5.00	Peak	
2	119.2400	42.14	-15.46	26.68	43.50	-16.82	Peak	
3	191.0200	50.99	-12.94	38.05	43.50	-5.45	Peak	
4	243.4000	36.49	-14.54	21.95	46.00	-24.05	Peak	
5	431.5800	40.92	-10.46	30.46	46.00	-15.54	Peak	
6	480.0800	35.10	-9.21	25.89	46.00	-20.11	Peak	

Test Mode: UNII-2C/TX A Mode 5580MHz_Adapter: RD1201500-C55-81MG

Horizontal

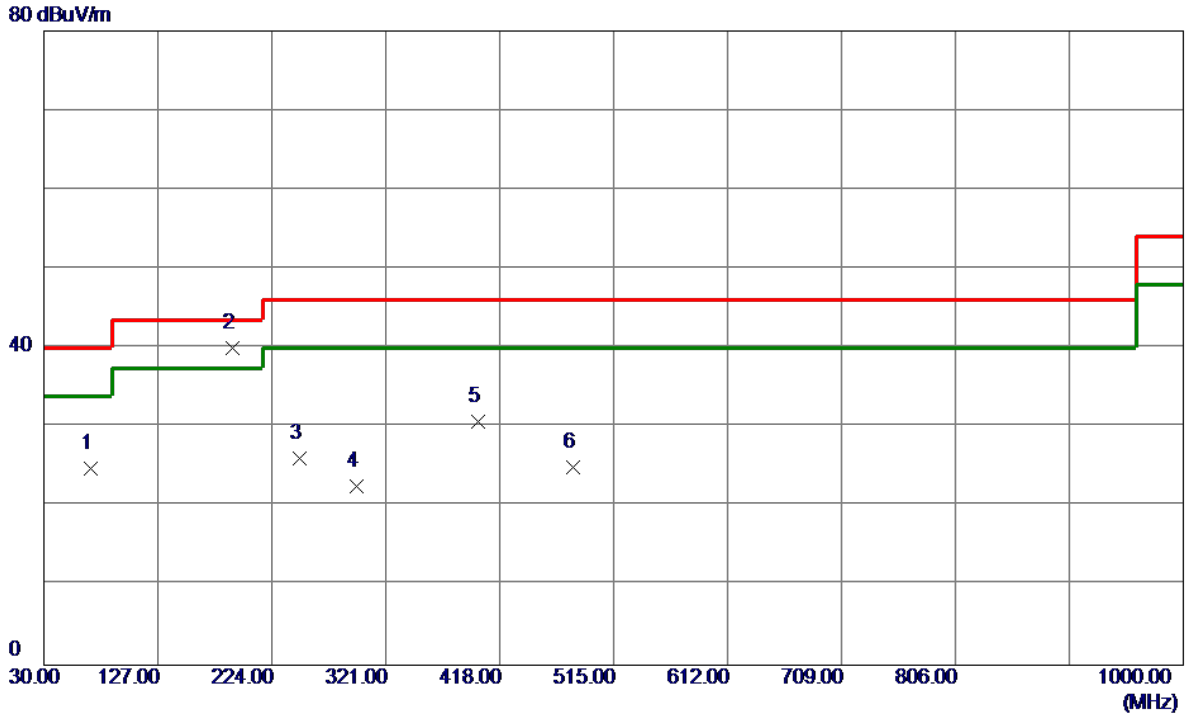

No.	Freq. MHz	Reading Level dBuV/m	Correct Factor dB	Measure ment dBuV/m	Limit dBuV/m	Margin dB	Detector	Comment
1	69.7699	41.23	-16.46	24.77	40.00	-15.23	Peak	
2 *	191.0200	52.90	-12.94	39.96	43.50	-3.54	QP	
3	247.2800	40.88	-14.74	26.14	46.00	-19.86	Peak	
4	295.7800	35.92	-13.41	22.51	46.00	-23.49	Peak	
5	399.5700	42.05	-11.37	30.68	46.00	-15.32	Peak	
6	480.0800	34.14	-9.21	24.93	46.00	-21.07	Peak	

Test Mode: UNII-2C/TX A Mode 5700MHz_Adapter: RD1201500-C55-81MG

Vertical

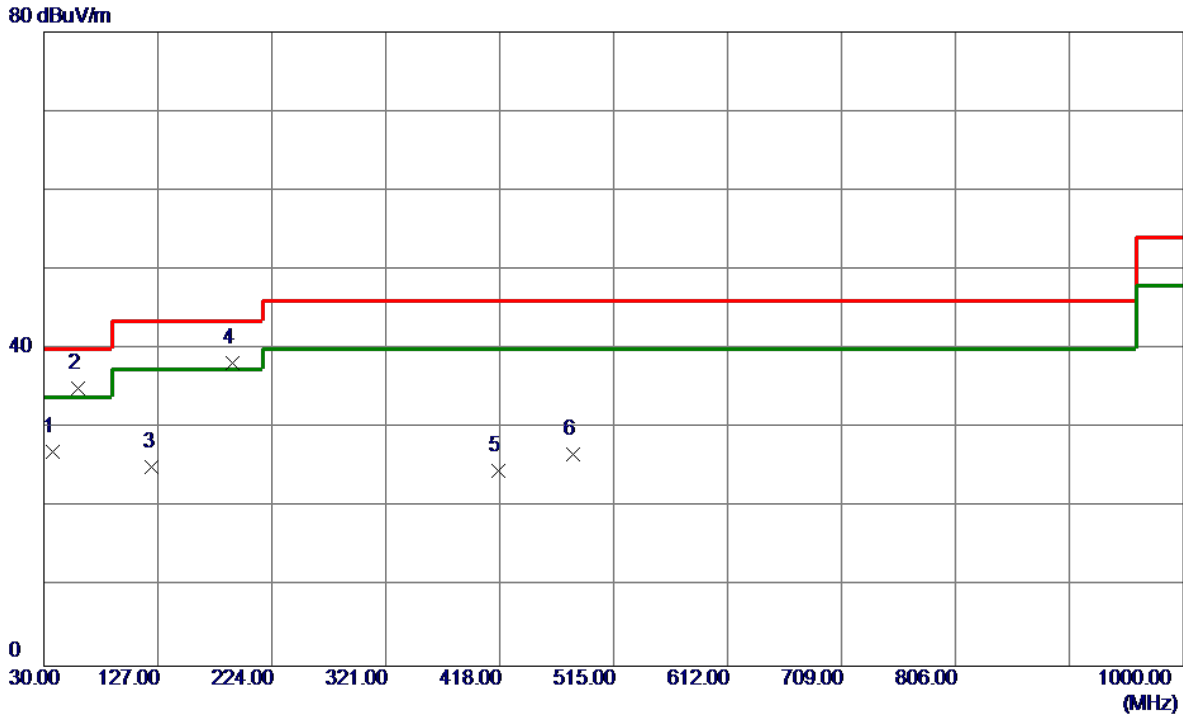

No.	Freq. MHz	Reading Level dBuV/m	Correct Factor dB	Measure ment dBuV/m	Limit dBuV/m	Margin dB	Detector	Comment
1	37.7599	41.34	-14.30	27.04	40.00	-12.96	Peak	
2 *	59.1000	49.22	-14.22	35.00	40.00	-5.00	Peak	
3	122.1500	40.37	-15.25	25.12	43.50	-18.38	Peak	
4	190.0500	51.07	-12.85	38.22	43.50	-5.28	Peak	
5	417.0300	35.57	-10.88	24.69	46.00	-21.31	Peak	
6	480.0800	35.91	-9.21	26.70	46.00	-19.30	Peak	

Test Mode: UNII-2C/TX A Mode 5700MHz_Adapter: RD1201500-C55-81MG

Horizontal

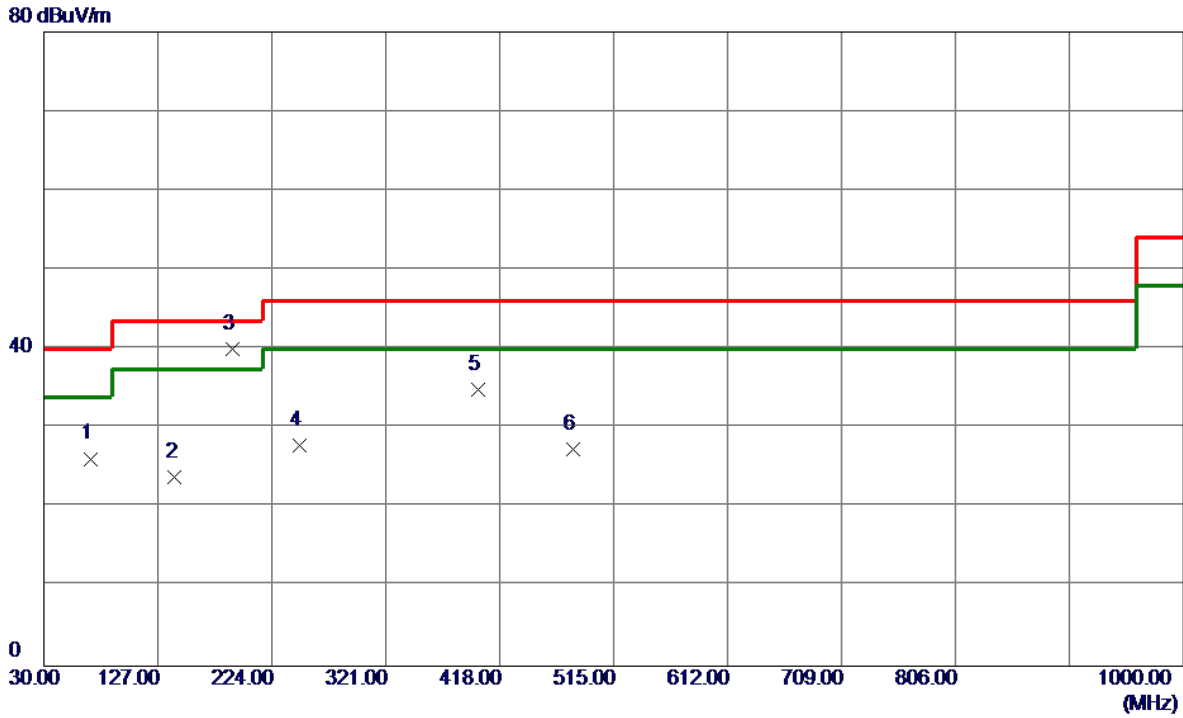

No.	Freq. MHz	Reading Level dBuV/m	Correct Factor dB	Measure ment dBuV/m	Limit dBuV/m	Margin dB	Detector	Comment
1	69.7699	42.62	-16.46	26.16	40.00	-13.84	Peak	
2	141.5500	37.93	-14.11	23.82	43.50	-19.68	Peak	
3 *	190.0500	52.90	-12.85	40.05	43.50	-3.45	QP	
4	247.2800	42.60	-14.74	27.86	46.00	-18.14	Peak	
5	399.5700	46.18	-11.37	34.81	46.00	-11.19	Peak	
6	480.0800	36.63	-9.21	27.42	46.00	-18.58	Peak	

Test Mode: UNII-2A/TX A Mode 5260MHz_Adapter: RD1201500-C55-24MG

Vertical

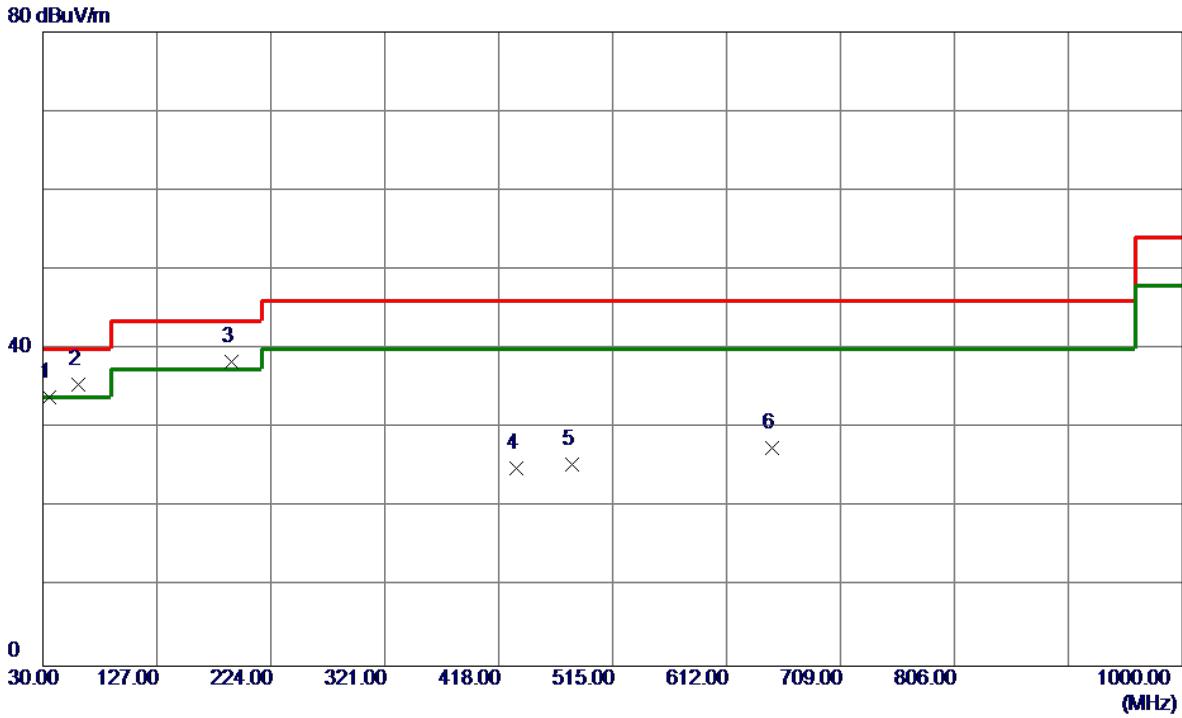

No.	Freq. MHz	Reading Level dBuV/m	Correct Factor dB	Measure ment dBuV/m	Limit dBuV/m	Margin dB	Detector	Comment
1	35.8200	48.38	-14.51	33.87	40.00	-6.13	Peak	
2 *	60.0700	49.91	-14.32	35.59	40.00	-4.41	Peak	
3	191.0200	51.30	-12.94	38.36	43.50	-5.14	Peak	
4	433.5200	35.40	-10.41	24.99	46.00	-21.01	Peak	
5	480.0800	34.67	-9.21	25.46	46.00	-20.54	Peak	
6	650.8000	33.01	-5.45	27.56	46.00	-18.44	Peak	

Test Mode: UNII-2A/TX A Mode 5260MHz_Adapter: RD1201500-C55-24MG

Horizontal

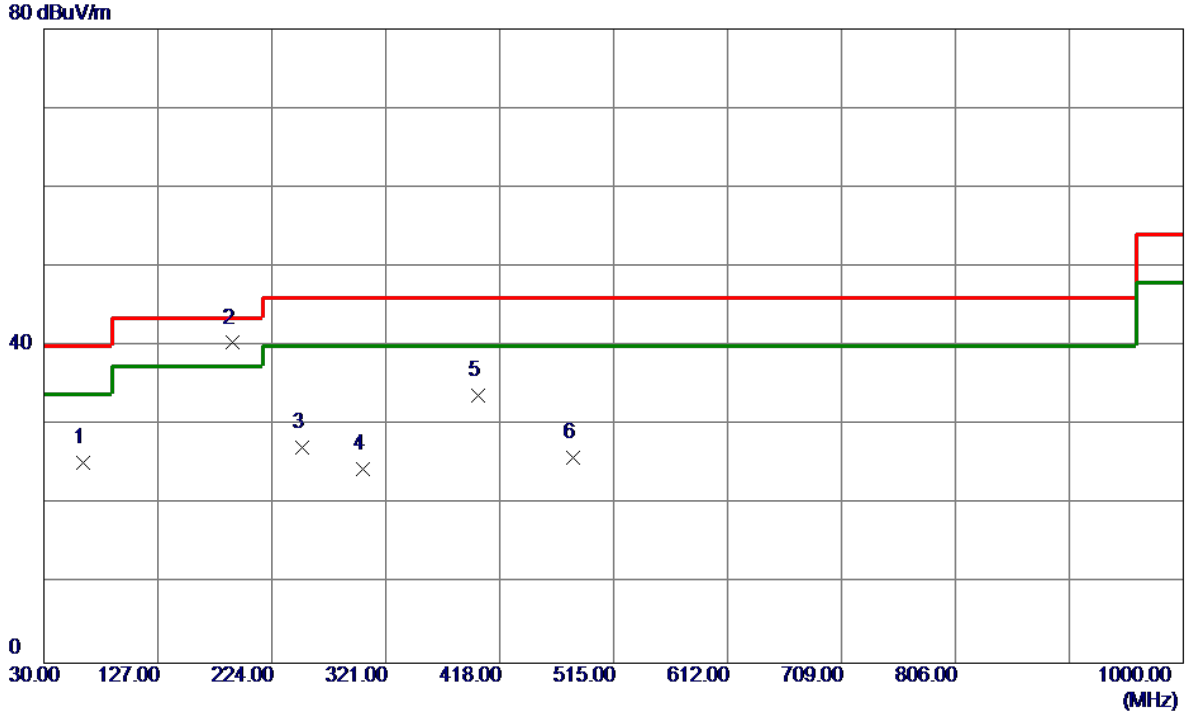

No.	Freq. MHz	Reading Level dBuV/m	Correct Factor dB	Measure ment dBuV/m	Limit dBuV/m	Margin dB	Detector	Comment
1	62.9800	40.16	-14.82	25.34	40.00	-14.66	Peak	
2 *	190.0500	53.25	-12.85	40.40	43.50	-3.10	QP	
3	250.1900	42.11	-14.90	27.21	46.00	-18.79	Peak	
4	301.6000	37.32	-12.80	24.52	46.00	-21.48	Peak	
5	399.5700	45.06	-11.37	33.69	46.00	-12.31	Peak	
6	480.0800	35.18	-9.21	25.97	46.00	-20.03	Peak	

Test Mode: UNII-2A/TX A Mode 5300MHz_Adapter: RD1201500-C55-24MG

Vertical

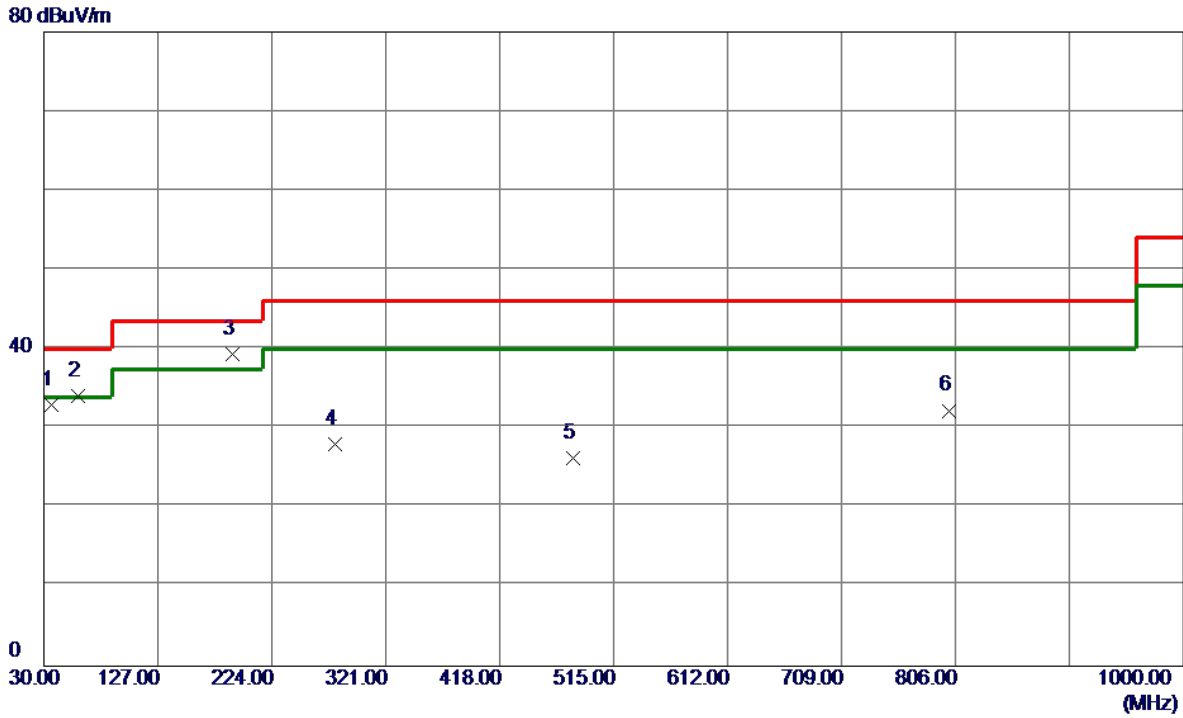

No.	Freq. MHz	Reading Level dBuV/m	Correct Factor dB	Measure ment dBuV/m	Limit dBuV/m	Margin dB	Detector	Comment
1	36.7900	47.41	-14.41	33.00	40.00	-7.00	Peak	
2	59.1000	48.28	-14.22	34.06	40.00	-5.94	Peak	
3 *	191.0200	52.35	-12.94	39.41	43.50	-4.09	Peak	
4	278.3200	42.94	-14.95	27.99	46.00	-18.01	Peak	
5	480.0800	35.47	-9.21	26.26	46.00	-19.74	Peak	
6	800.1800	33.60	-1.36	32.24	46.00	-13.76	Peak	

Test Mode: UNII-2A/TX A Mode 5300MHz_Adapter: RD1201500-C55-24MG

Horizontal

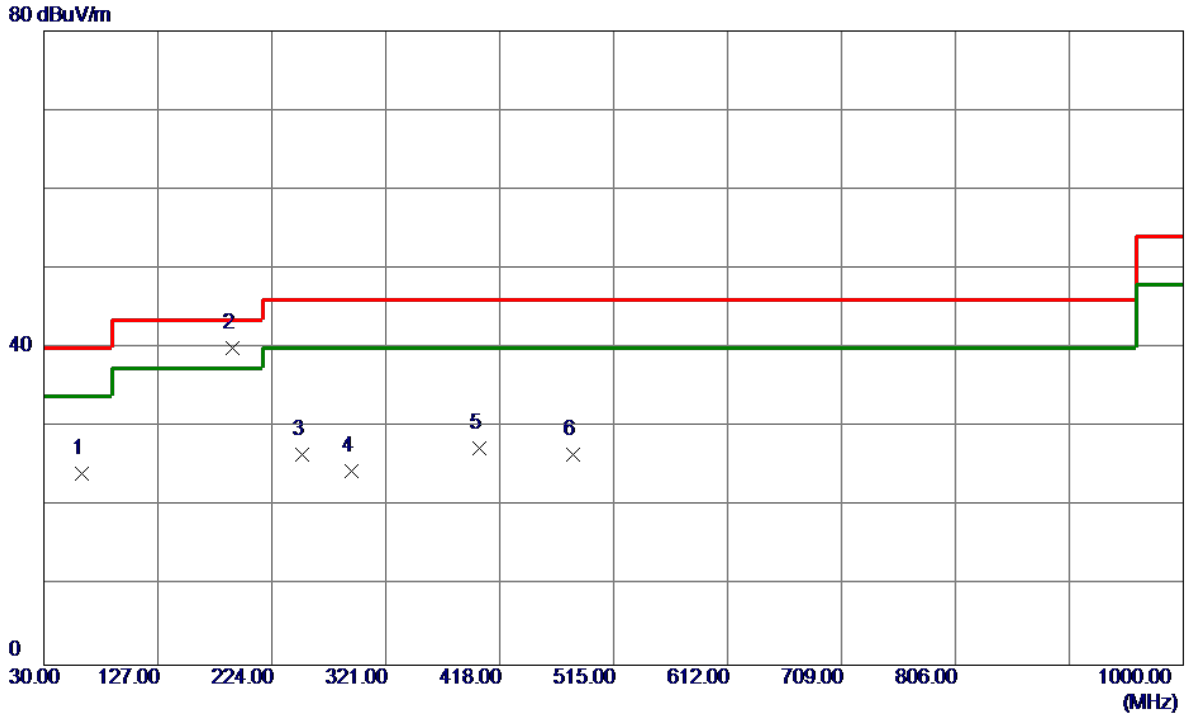

No.	Freq. MHz	Reading Level dBuV/m	Correct Factor dB	Measure ment dBuV/m	Limit dBuV/m	Margin dB	Detector	Comment
1	62.0100	38.79	-14.65	24.14	40.00	-15.86	Peak	
2 *	190.0500	52.84	-12.85	39.99	43.50	-3.51	QP	
3	250.1900	41.39	-14.90	26.49	46.00	-19.51	Peak	
4	291.9000	38.49	-13.94	24.55	46.00	-21.45	Peak	
5	400.5400	38.73	-11.34	27.39	46.00	-18.61	Peak	
6	480.0800	35.78	-9.21	26.57	46.00	-19.43	Peak	

Test Mode: UNII-2A/TX A Mode 5320MHz_Adapter: RD1201500-C55-24MG

Vertical

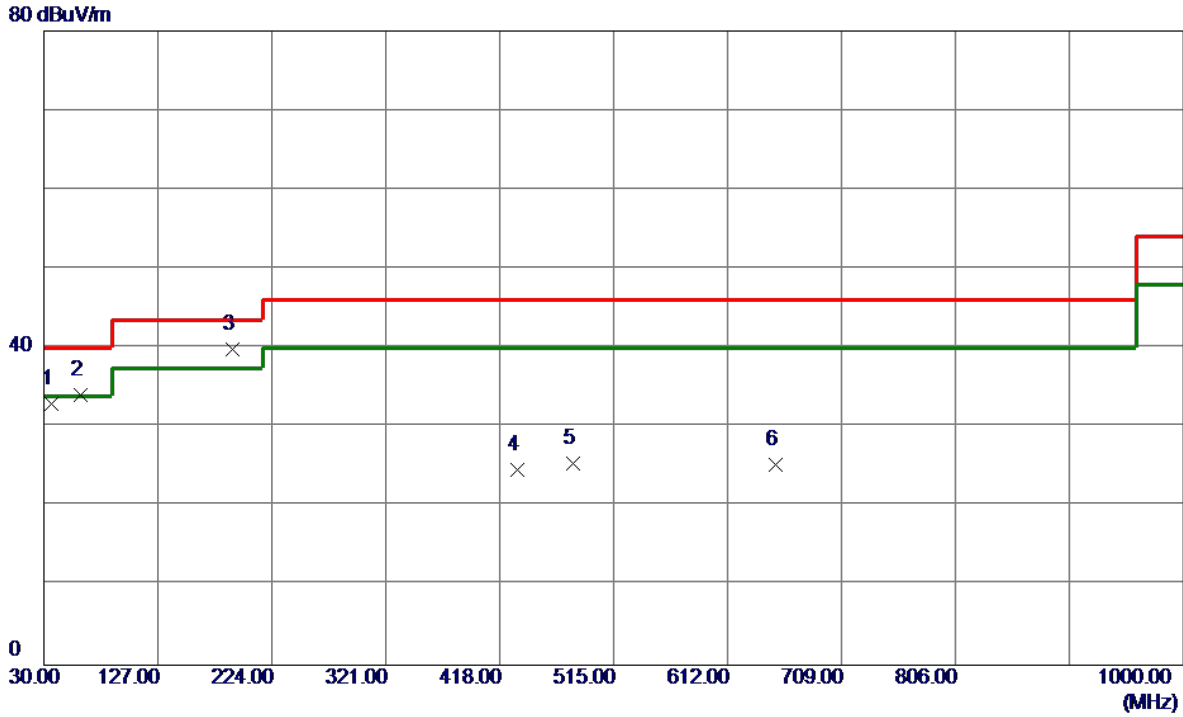

No.	Freq. MHz	Reading Level dBuV/m	Correct Factor dB	Measure ment dBuV/m	Limit dBuV/m	Margin dB	Detector	Comment
1	36.7900	47.35	-14.41	32.94	40.00	-7.06	Peak	
2	61.0400	48.60	-14.48	34.12	40.00	-5.88	Peak	
3 *	191.0200	52.85	-12.94	39.91	43.50	-3.59	Peak	
4	433.5200	35.06	-10.41	24.65	46.00	-21.35	Peak	
5	480.0800	34.65	-9.21	25.44	46.00	-20.56	Peak	
6	652.7400	30.67	-5.39	25.28	46.00	-20.72	Peak	

Test Mode: UNII-2A/TX A Mode 5320MHz_Adapter: RD1201500-C55-24MG

Horizontal

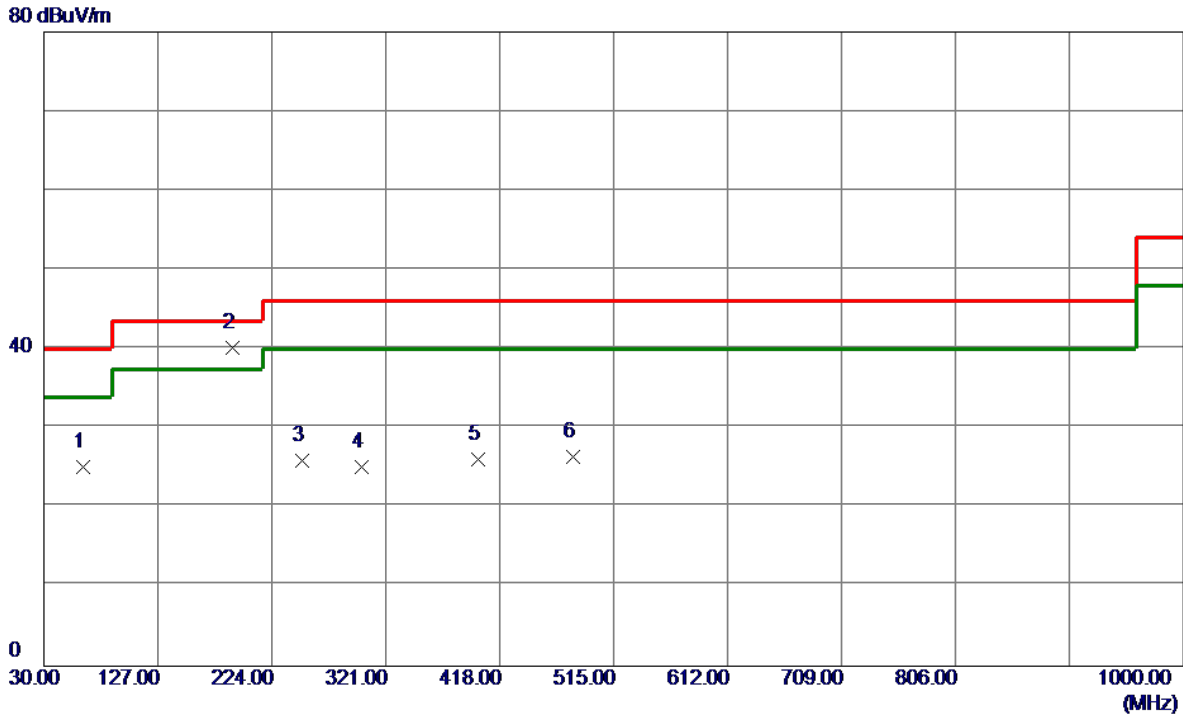

No.	Freq. MHz	Reading Level dBuV/m	Correct Factor dB	Measure ment dBuV/m	Limit dBuV/m	Margin dB	Detector	Comment
1	62.9800	39.88	-14.82	25.06	40.00	-14.94	Peak	
2 *	190.0500	53.05	-12.85	40.20	43.50	-3.30	QP	
3	250.1900	40.75	-14.90	25.85	46.00	-20.15	Peak	
4	300.6300	37.99	-12.82	25.17	46.00	-20.83	Peak	
5	399.5700	37.38	-11.37	26.01	46.00	-19.99	Peak	
6	480.0800	35.54	-9.21	26.33	46.00	-19.67	Peak	

Test Mode: UNII-2C/TX A Mode 5500MHz_Adapter: RD1201500-C55-24MG

Vertical

80 dBuV/m

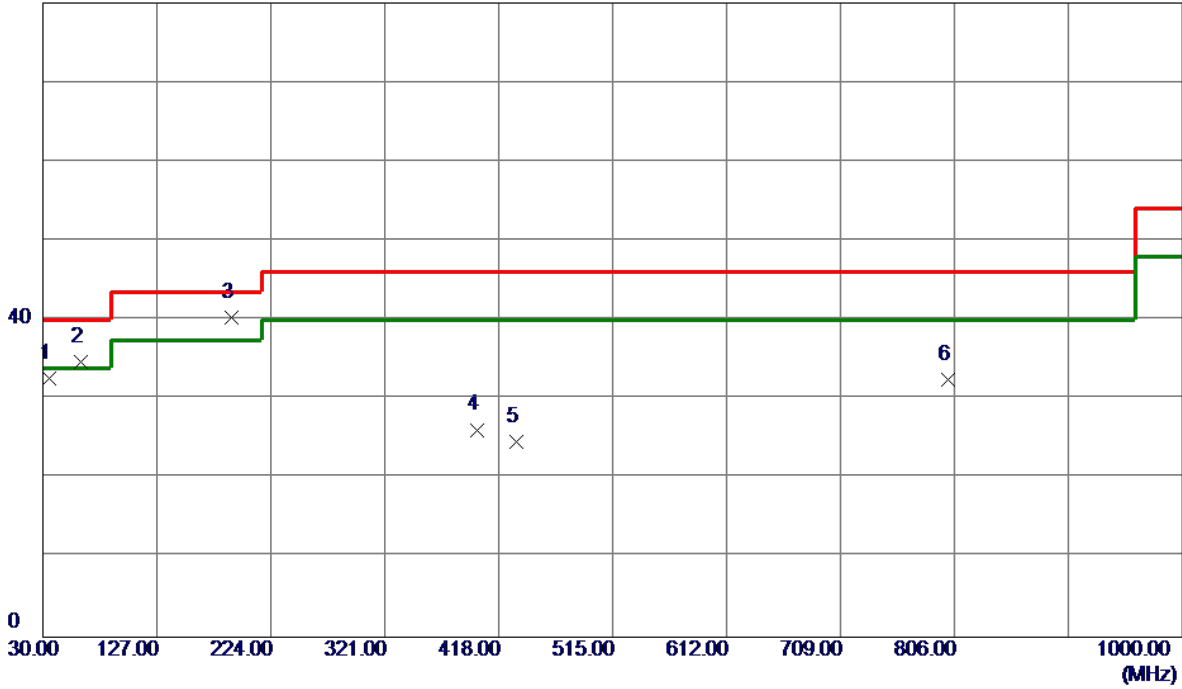

No.	Freq. MHz	Reading Level dBuV/m	Correct Factor dB	Measure ment dBuV/m	Limit dBuV/m	Margin dB	Detector	Comment
1	35.8200	47.11	-14.51	32.60	40.00	-7.40	Peak	
2	62.0100	49.41	-14.65	34.76	40.00	-5.24	Peak	
3 *	191.0200	53.23	-12.94	40.29	43.50	-3.21	Peak	
4	399.5700	37.53	-11.37	26.16	46.00	-19.84	Peak	
5	433.5200	35.08	-10.41	24.67	46.00	-21.33	Peak	
6	800.1800	33.81	-1.36	32.45	46.00	-13.55	Peak	

Test Mode: UNII-2C/TX A Mode 5500MHz_Adapter: RD1201500-C55-24MG

Horizontal

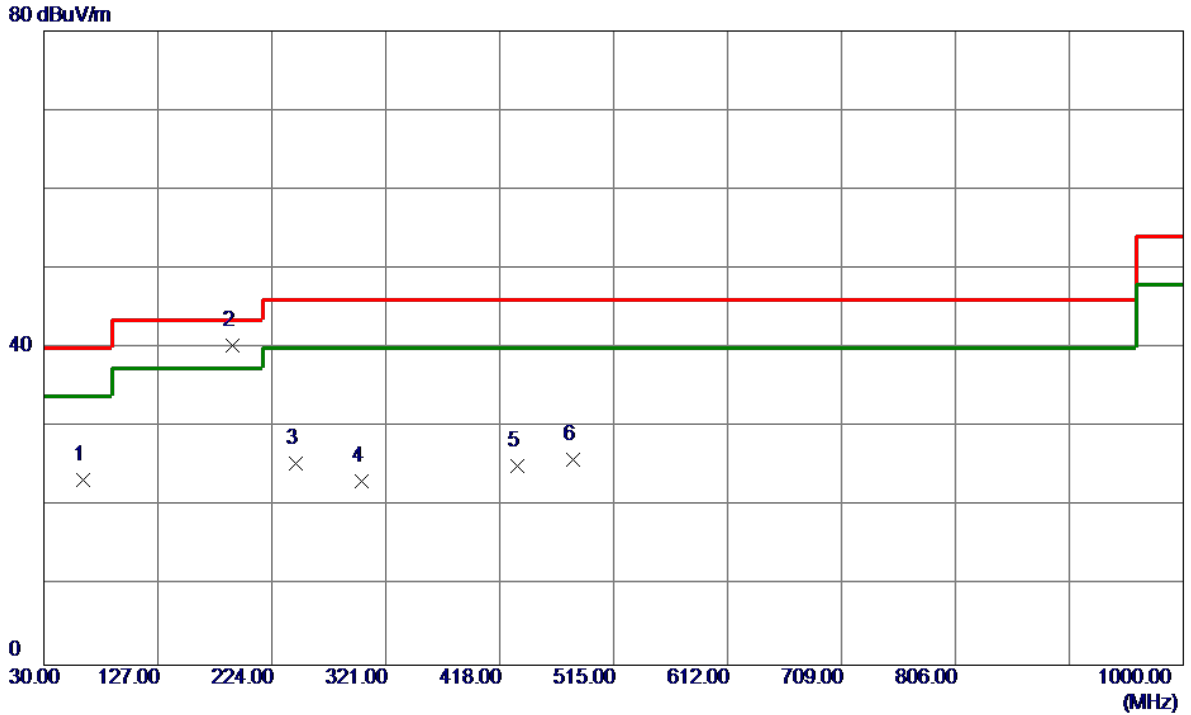

No.	Freq. MHz	Reading Level dBuV/m	Correct Factor dB	Measure ment dBuV/m	Limit dBuV/m	Margin dB	Detector	Comment
1	62.9800	38.11	-14.82	23.29	40.00	-16.71	Peak	
2 *	191.0200	53.27	-12.94	40.33	43.50	-3.17	QP	
3	244.3700	39.99	-14.59	25.40	46.00	-20.60	Peak	
4	300.6300	35.98	-12.82	23.16	46.00	-22.84	Peak	
5	433.5200	35.51	-10.41	25.10	46.00	-20.90	Peak	
6	480.0800	35.19	-9.21	25.98	46.00	-20.02	Peak	

Test Mode: UNII-2C/TX A Mode 5580MHz_Adapter: RD1201500-C55-24MG

Vertical

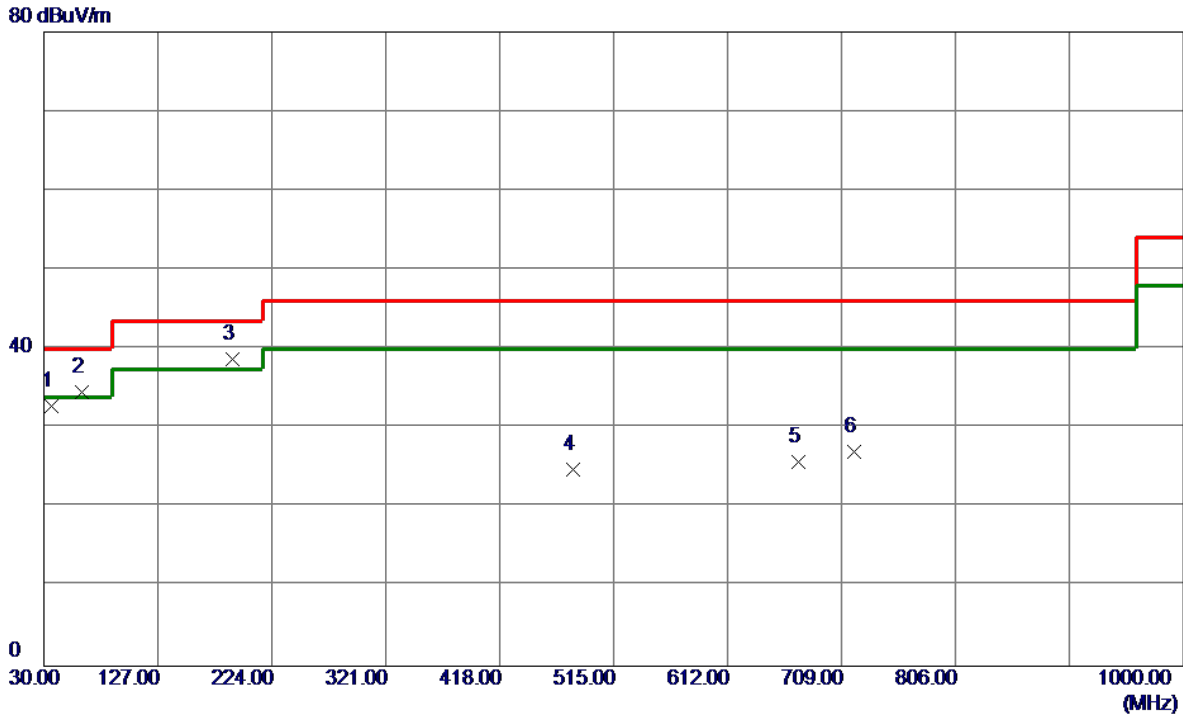

No.	Freq. MHz	Reading Level dBuV/m	Correct Factor dB	Measure ment dBuV/m	Limit dBuV/m	Margin dB	Detector	Comment
1	36.7900	47.24	-14.41	32.83	40.00	-7.17	Peak	
2	62.0100	49.27	-14.65	34.62	40.00	-5.38	Peak	
3 *	191.0200	51.64	-12.94	38.70	43.50	-4.80	Peak	
4	480.0800	34.03	-9.21	24.82	46.00	-21.18	Peak	
5	672.1400	30.53	-4.80	25.73	46.00	-20.27	Peak	
6	719.6700	30.33	-3.35	26.98	46.00	-19.02	Peak	

Test Mode: UNII-2C/TX A Mode 5580MHz_Adapter: RD1201500-C55-24MG

Horizontal

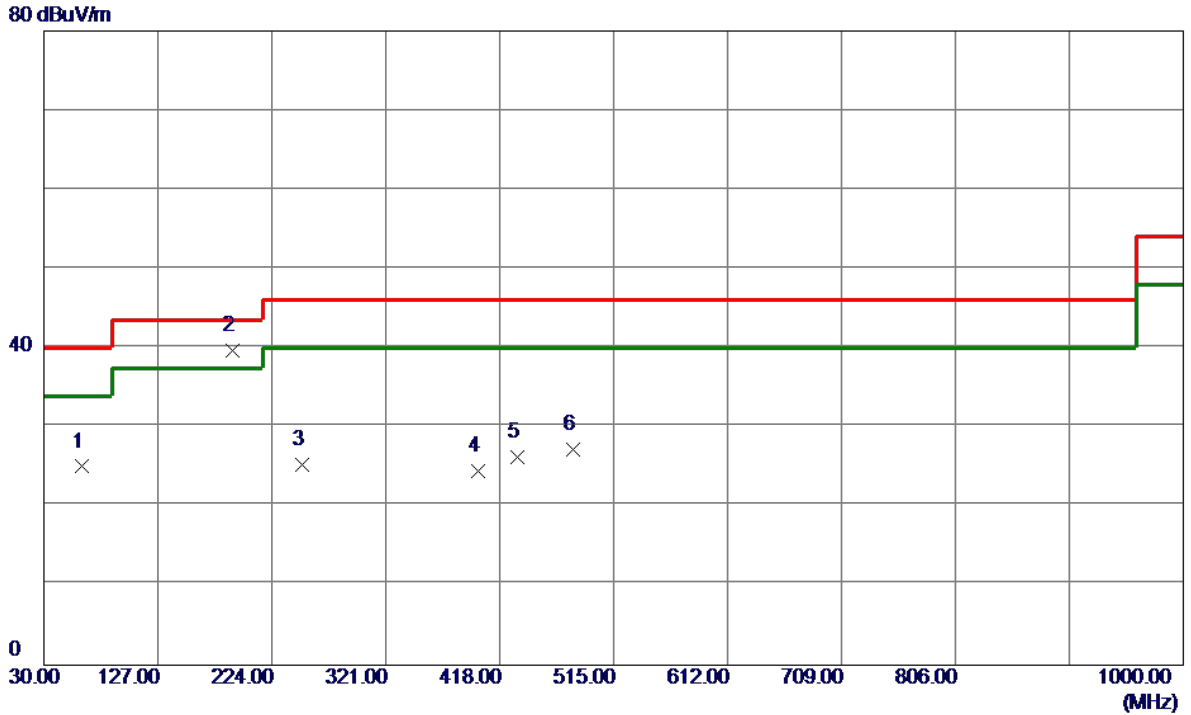

No.	Freq. MHz	Reading Level dBuV/m	Correct Factor dB	Measure ment dBuV/m	Limit dBuV/m	Margin dB	Detector	Comment
1	62.0100	39.69	-14.65	25.04	40.00	-14.96	Peak	
2 *	191.0200	52.66	-12.94	39.72	43.50	-3.78	QP	
3	250.1900	40.19	-14.90	25.29	46.00	-20.71	Peak	
4	399.5700	35.82	-11.37	24.45	46.00	-21.55	Peak	
5	433.5200	36.72	-10.41	26.31	46.00	-19.69	Peak	
6	480.0800	36.46	-9.21	27.25	46.00	-18.75	Peak	

Test Mode: UNII-2C/TX A Mode 5700MHz_Adapter: RD1201500-C55-24MG

Vertical

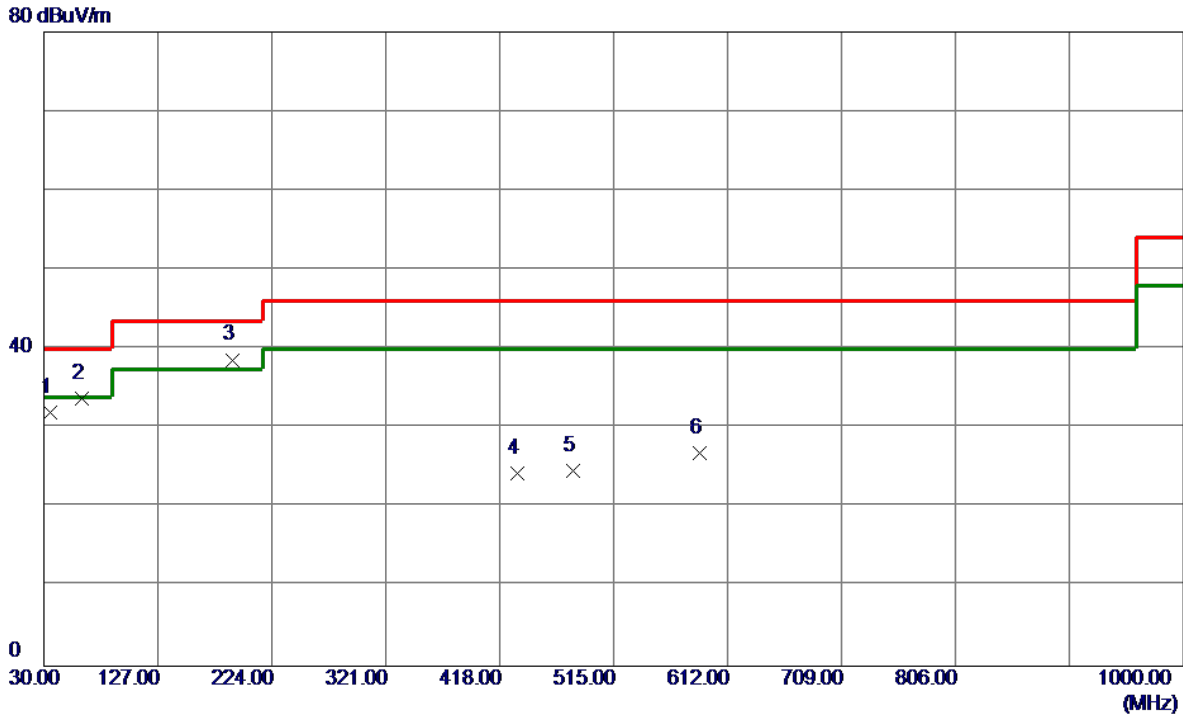

No.	Freq. MHz	Reading Level dBuV/m	Correct Factor dB	Measure ment dBuV/m	Limit dBuV/m	Margin dB	Detector	Comment
1	35.8200	46.49	-14.51	31.98	40.00	-8.02	Peak	
2	62.0100	48.44	-14.65	33.79	40.00	-6.21	Peak	
3 *	190.0500	51.49	-12.85	38.64	43.50	-4.86	Peak	
4	433.5200	34.71	-10.41	24.30	46.00	-21.70	Peak	
5	480.0800	33.79	-9.21	24.58	46.00	-21.42	Peak	
6	588.7199	33.55	-6.71	26.84	46.00	-19.16	Peak	

Test Mode: UNII-2C/TX A Mode 5700MHz_Adapter: RD1201500-C55-24MG

Horizontal

80 dBuV/m

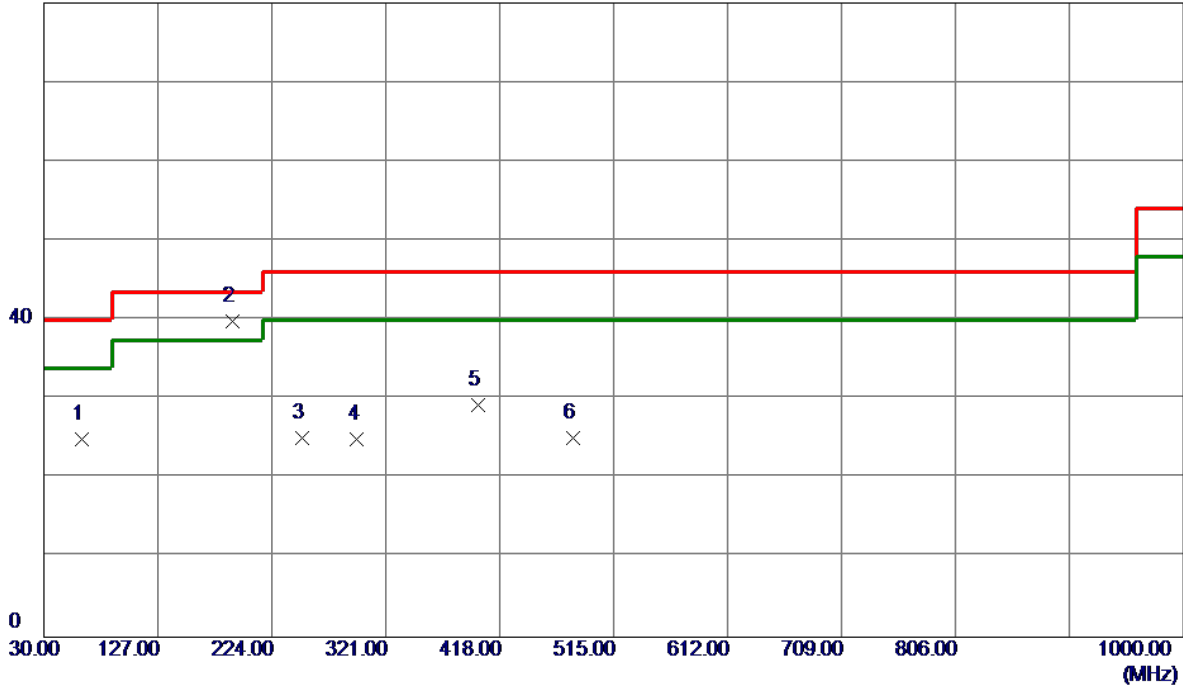

No.	Freq. MHz	Reading Level dBuV/m	Correct Factor dB	Measure ment dBuV/m	Limit dBuV/m	Margin dB	Detector	Comment
1	62.0100	39.62	-14.65	24.97	40.00	-15.03	Peak	
2 *	191.0200	52.86	-12.94	39.92	43.50	-3.58	QP	
3	250.1900	40.09	-14.90	25.19	46.00	-20.81	Peak	
4	296.7500	38.25	-13.28	24.97	46.00	-21.03	Peak	
5	399.5700	40.62	-11.37	29.25	46.00	-16.75	Peak	
6	480.0800	34.30	-9.21	25.09	46.00	-20.91	Peak	

Test Mode: UNII-2A/TX A Mode 5260MHz_Adapter: RD1202000-C55-29MG

Vertical

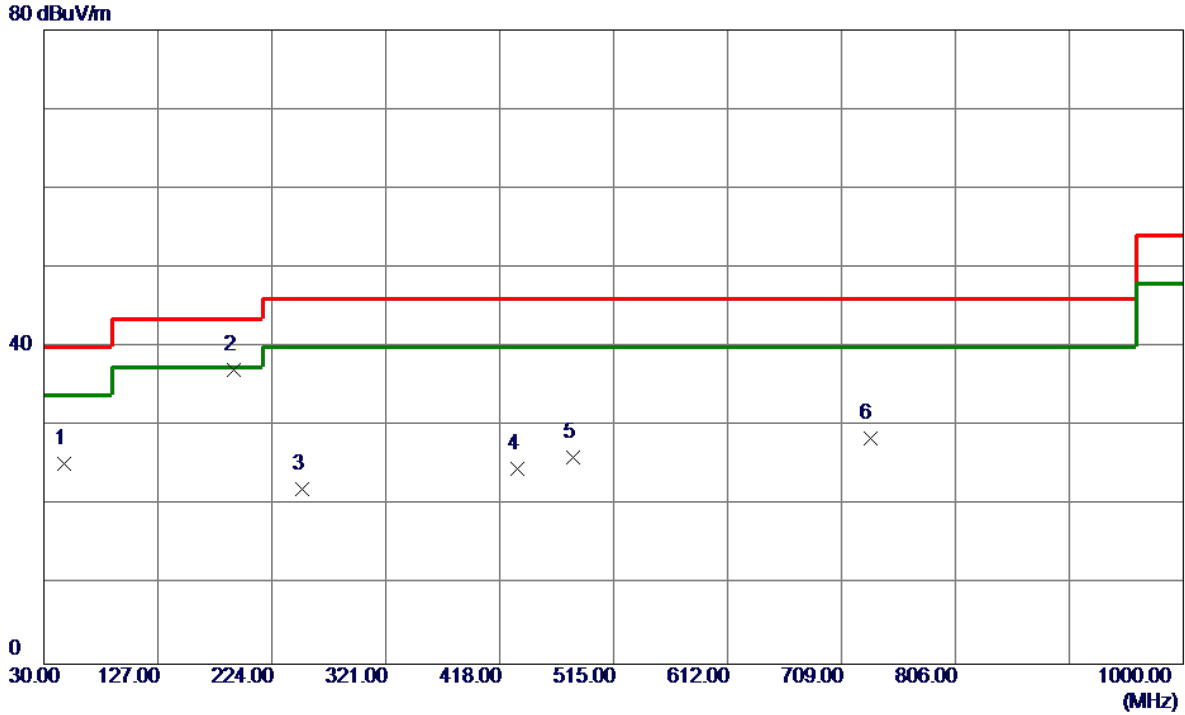

No.	Freq. MHz	Reading Level dBuV/m	Correct Factor dB	Measure ment dBuV/m	Limit dBuV/m	Margin dB	Detector	Comment
1	47.4600	38.37	-13.12	25.25	40.00	-14.75	Peak	
2 *	191.9900	50.15	-13.03	37.12	43.50	-6.38	Peak	
3	250.1900	36.92	-14.90	22.02	46.00	-23.98	Peak	
4	433.5200	35.01	-10.41	24.60	46.00	-21.40	Peak	
5	480.0800	35.27	-9.21	26.06	46.00	-19.94	Peak	
6	733.2500	31.37	-2.95	28.42	46.00	-17.58	Peak	

Test Mode: UNII-2A/TX A Mode 5260MHz_Adapter: RD1202000-C55-29MG

Horizontal

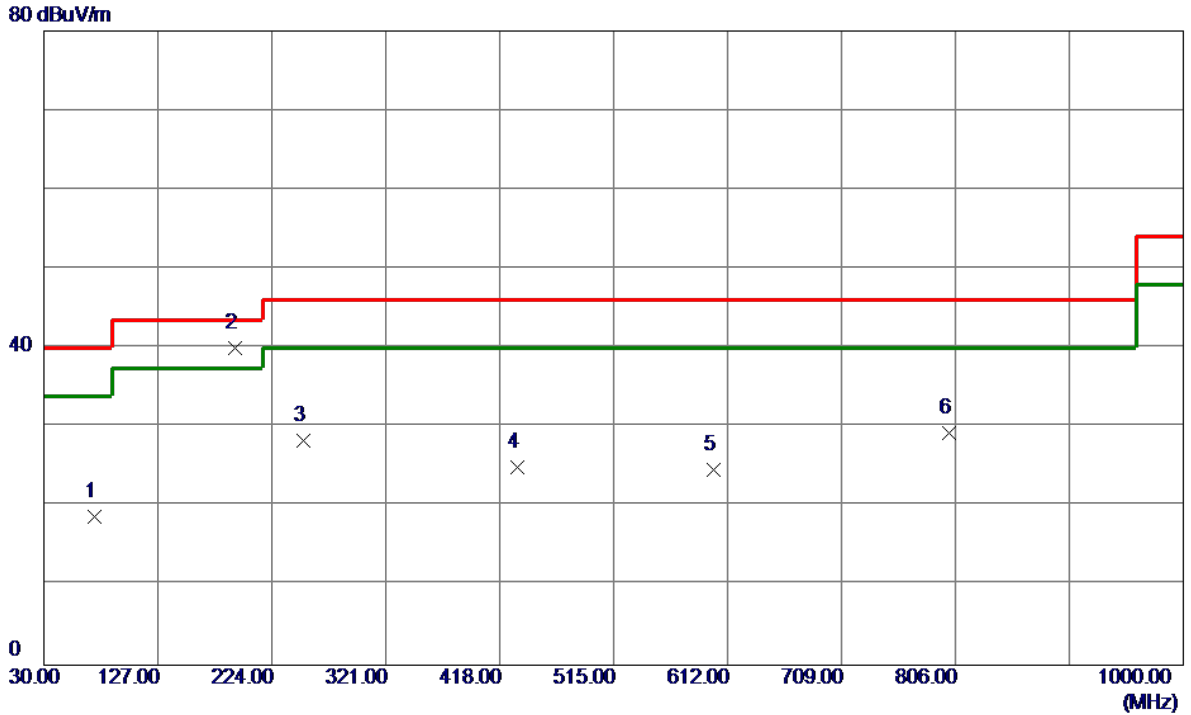

No.	Freq. MHz	Reading Level dBuV/m	Correct Factor dB	Measure ment dBuV/m	Limit dBuV/m	Margin dB	Detector	Comment
1	72.6800	35.60	-16.82	18.78	40.00	-21.22	Peak	
2 *	192.9600	53.18	-13.11	40.07	43.50	-3.43	QP	
3	251.1600	43.26	-14.98	28.28	46.00	-17.72	Peak	
4	433.5200	35.34	-10.41	24.93	46.00	-21.07	Peak	
5	600.3600	30.98	-6.41	24.57	46.00	-21.43	Peak	
6	800.1800	30.57	-1.36	29.21	46.00	-16.79	Peak	

Test Mode: UNII-2A/TX A Mode 5300MHz_Adapter: RD1202000-C55-29MG

Vertical

80 dBuV/m

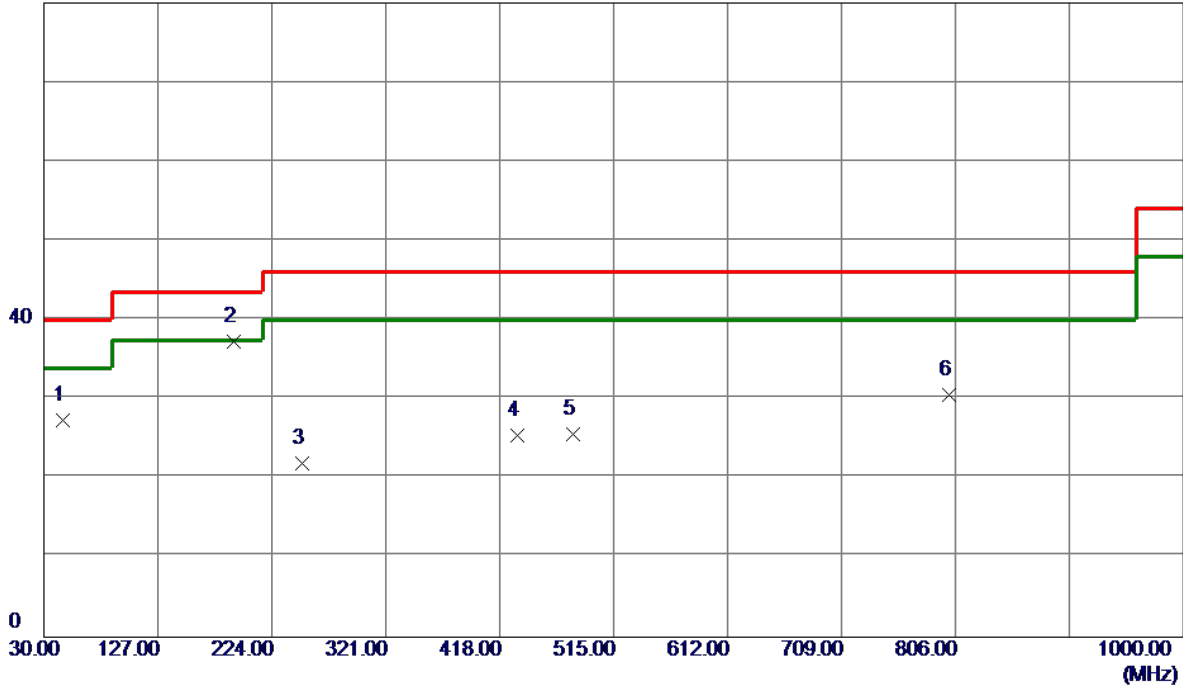

No.	Freq. MHz	Reading Level dBuV/m	Correct Factor dB	Measure ment dBuV/m	Limit dBuV/m	Margin dB	Detector	Comment
1	46.4900	40.32	-12.98	27.34	40.00	-12.66	Peak	
2 *	191.9900	50.26	-13.03	37.23	43.50	-6.27	Peak	
3	250.1900	36.86	-14.90	21.96	46.00	-24.04	Peak	
4	433.5200	35.78	-10.41	25.37	46.00	-20.63	Peak	
5	480.0800	34.84	-9.21	25.63	46.00	-20.37	Peak	
6	800.1800	31.90	-1.36	30.54	46.00	-15.46	Peak	

Test Mode: UNII-2A/TX A Mode 5300MHz_Adapter: RD1202000-C55-29MG

Horizontal

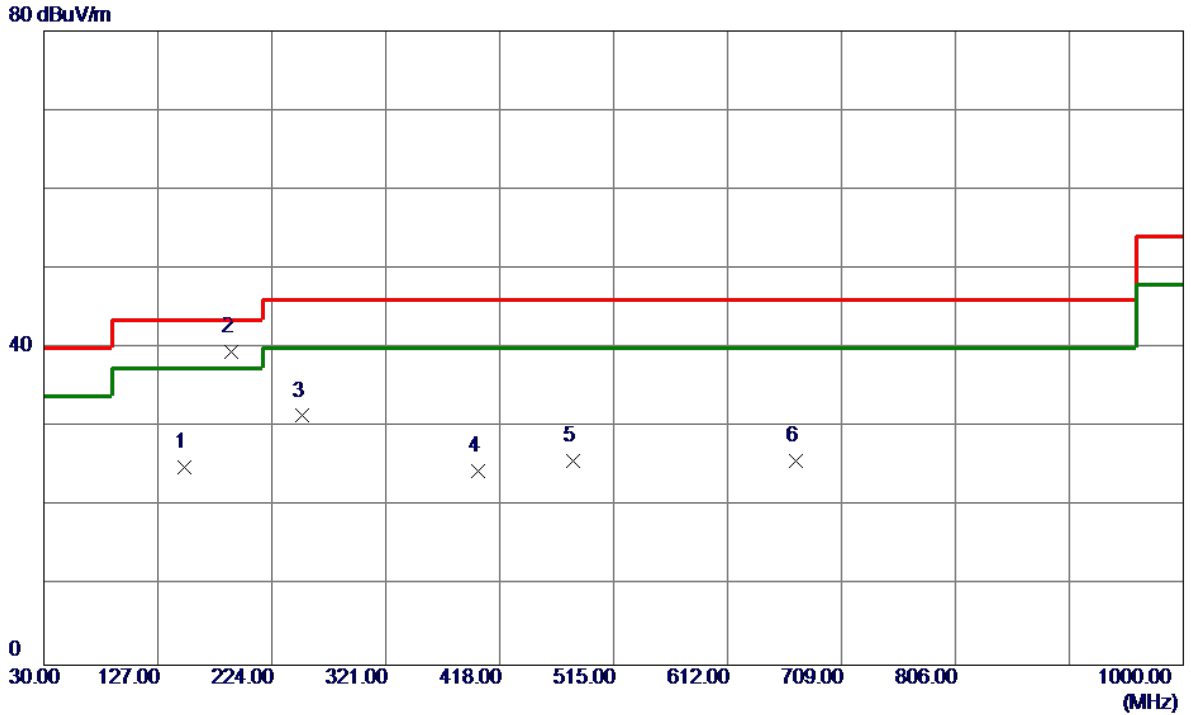

No.	Freq. MHz	Reading Level dBuV/m	Correct Factor dB	Measure ment dBuV/m	Limit dBuV/m	Margin dB	Detector	Comment
1	149.3100	38.57	-13.57	25.00	43.50	-18.50	Peak	
2 *	189.0800	52.30	-12.77	39.53	43.50	-3.97	QP	
3	250.1900	46.34	-14.90	31.44	46.00	-14.56	Peak	
4	399.5700	35.83	-11.37	24.46	46.00	-21.54	Peak	
5	480.0800	35.01	-9.21	25.80	46.00	-20.20	Peak	
6	670.2000	30.67	-4.85	25.82	46.00	-20.18	Peak	

Test Mode: UNII-2A/TX A Mode 5320MHz_Adapter: RD1202000-C55-29MG

Vertical

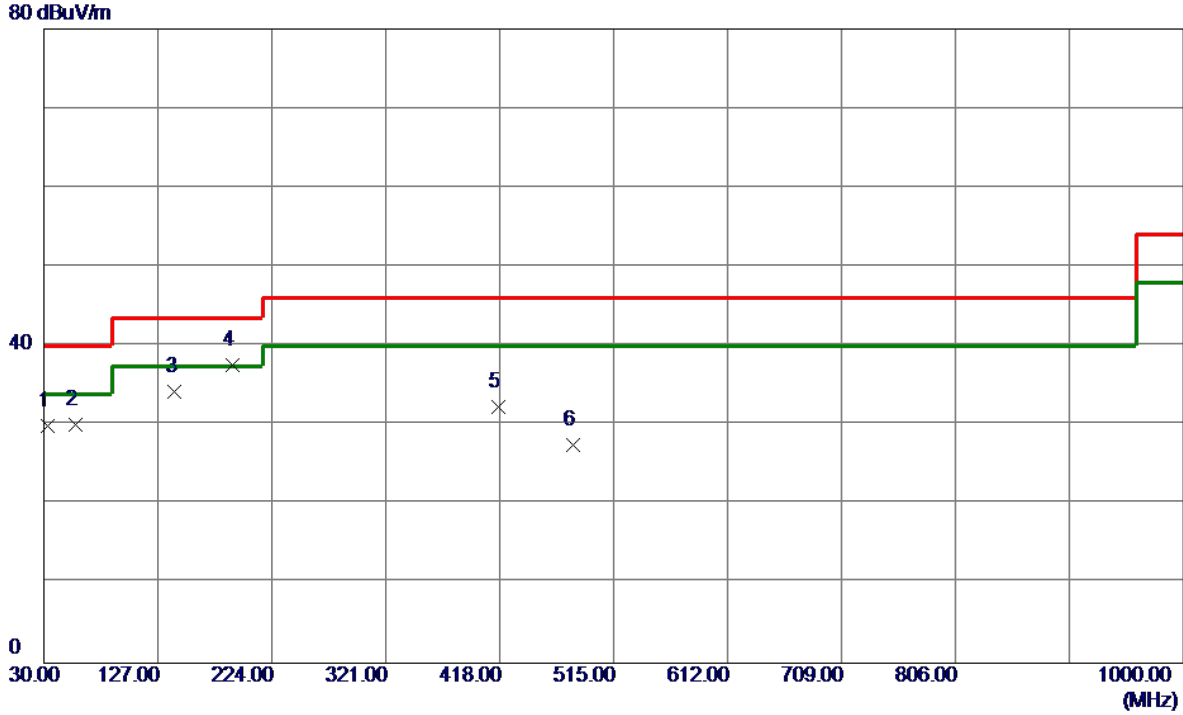

No.	Freq. MHz	Reading Level dBuV/m	Correct Factor dB	Measure ment dBuV/m	Limit dBuV/m	Margin dB	Detector	Comment
1	32.9100	44.77	-14.89	29.88	40.00	-10.12	Peak	
2	57.1600	44.15	-14.04	30.11	40.00	-9.89	Peak	
3	141.5500	48.32	-14.11	34.21	43.50	-9.29	Peak	
4 *	191.0200	50.53	-12.94	37.59	43.50	-5.91	Peak	
5	417.0300	43.23	-10.88	32.35	46.00	-13.65	Peak	
6	480.0800	36.74	-9.21	27.53	46.00	-18.47	Peak	

Test Mode: UNII-2A/TX A Mode 5320MHz_Adapter: RD1202000-C55-29MG

Horizontal

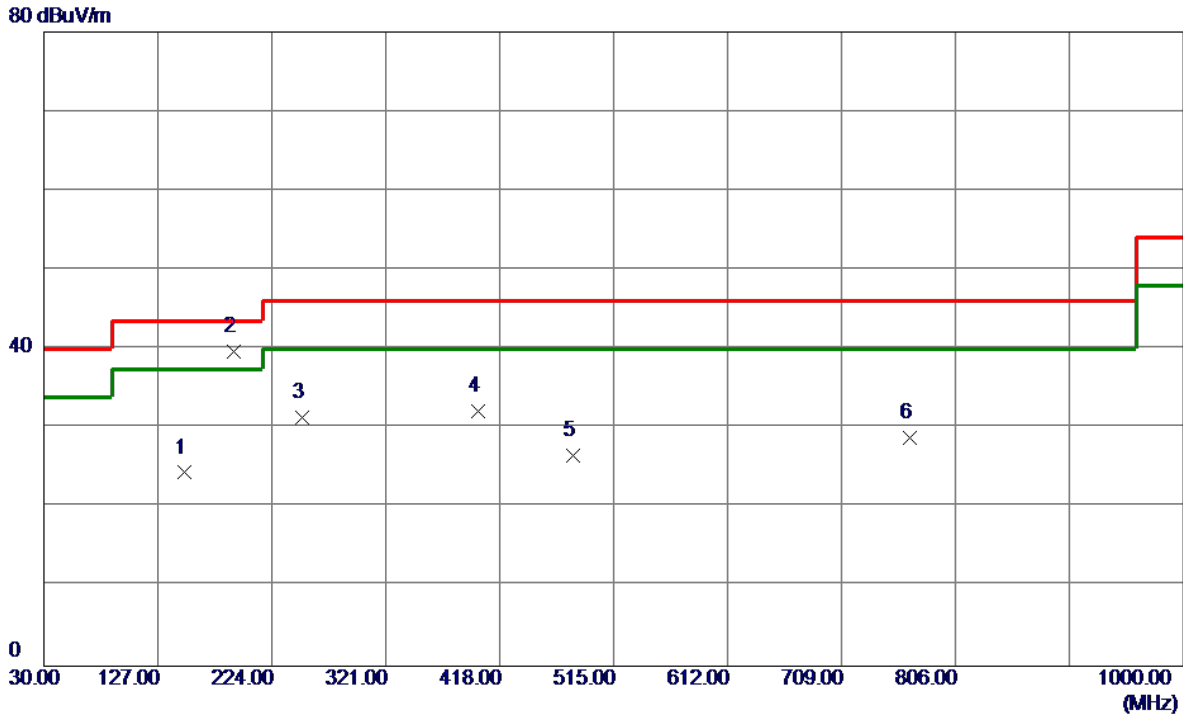

No.	Freq. MHz	Reading Level dBuV/m	Correct Factor dB	Measure ment dBuV/m	Limit dBuV/m	Margin dB	Detector	Comment
1	149.3100	37.97	-13.57	24.40	43.50	-19.10	Peak	
2 *	191.9900	52.70	-13.03	39.67	43.50	-3.83	QP	
3	250.1900	46.25	-14.90	31.35	46.00	-14.65	Peak	
4	399.5700	43.51	-11.37	32.14	46.00	-13.86	Peak	
5	480.0800	35.83	-9.21	26.62	46.00	-19.38	Peak	
6	767.2000	30.84	-2.07	28.77	46.00	-17.23	Peak	

Test Mode: UNII-2C/TX A Mode 5500MHz_Adapter: RD1202000-C55-29MG

Vertical

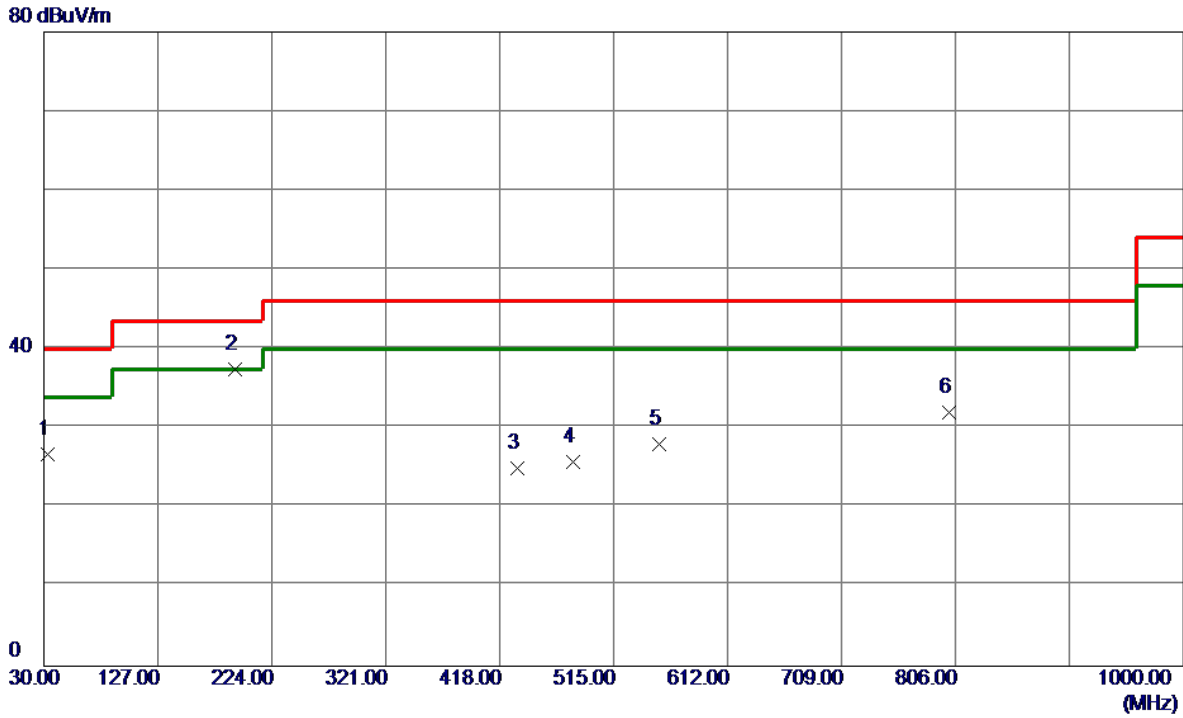

No.	Freq. MHz	Reading Level dBuV/m	Correct Factor dB	Measure ment dBuV/m	Limit dBuV/m	Margin dB	Detector	Comment
1	32.9100	41.67	-14.89	26.78	40.00	-13.22	Peak	
2 *	192.9600	50.53	-13.11	37.42	43.50	-6.08	Peak	
3	433.5200	35.39	-10.41	24.98	46.00	-21.02	Peak	
4	480.0800	34.94	-9.21	25.73	46.00	-20.27	Peak	
5	553.8000	35.64	-7.62	28.02	46.00	-17.98	Peak	
6	800.1800	33.36	-1.36	32.00	46.00	-14.00	Peak	

Test Mode: UNII-2C/TX A Mode 5500MHz_Adapter: RD1202000-C55-29MG

Horizontal

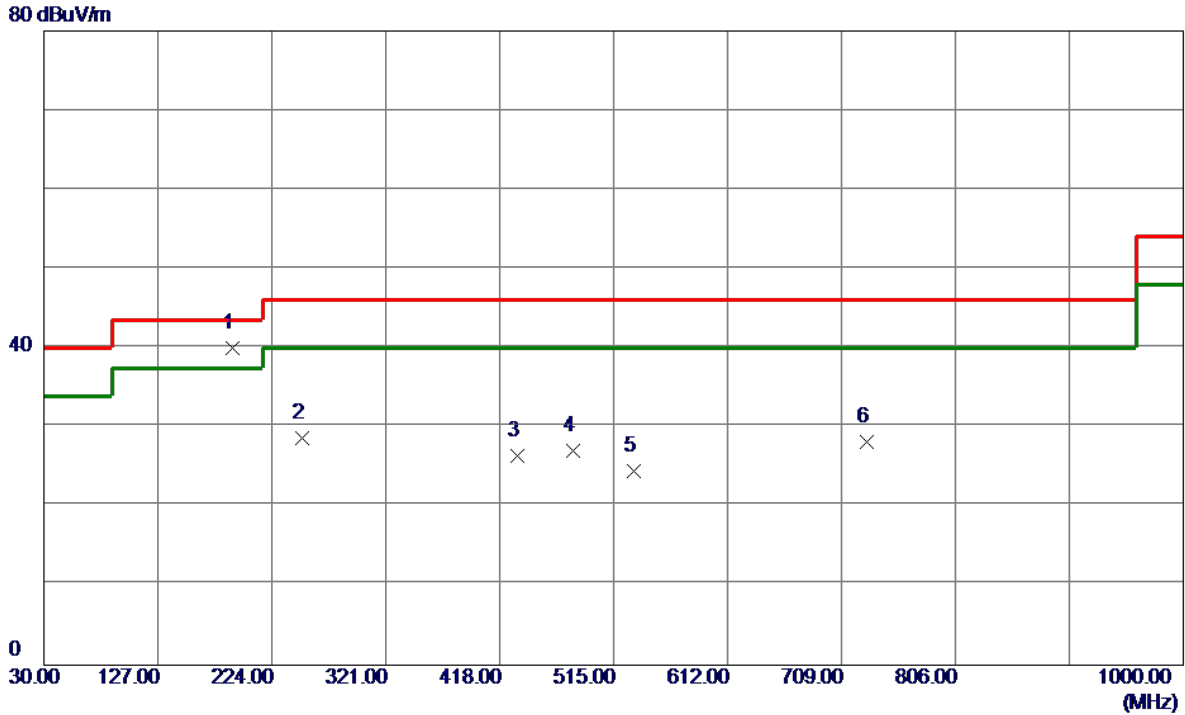

No.	Freq. MHz	Reading Level dBuV/m	Correct Factor dB	Measure ment dBuV/m	Limit dBuV/m	Margin dB	Detector	Comment
1 *	190.0500	52.78	-12.85	39.93	43.50	-3.57	QP	
2	250.1900	43.55	-14.90	28.65	46.00	-17.35	Peak	
3	433.5200	36.82	-10.41	26.41	46.00	-19.59	Peak	
4	480.0800	36.20	-9.21	26.99	46.00	-19.01	Peak	
5	532.4600	32.61	-8.07	24.54	46.00	-21.46	Peak	
6	730.3400	31.15	-3.03	28.12	46.00	-17.88	Peak	

Test Mode: UNII-2C/TX A Mode 5580MHz_Adapter: RD1202000-C55-29MG

Vertical

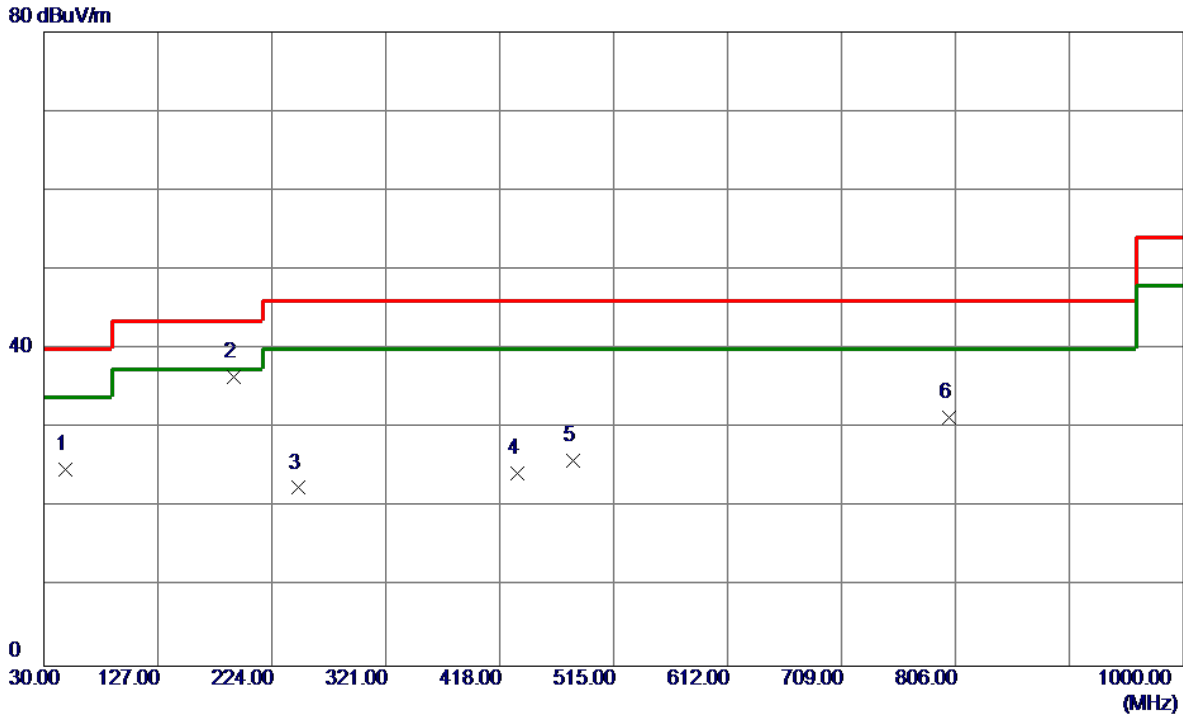

No.	Freq. MHz	Reading Level dBuV/m	Correct Factor dB	Measure ment dBuV/m	Limit dBuV/m	Margin dB	Detector	Comment
1	48.4300	38.03	-13.28	24.75	40.00	-15.25	Peak	
2 *	191.9900	49.50	-13.03	36.47	43.50	-7.03	Peak	
3	246.3100	37.17	-14.69	22.48	46.00	-23.52	Peak	
4	433.5200	34.73	-10.41	24.32	46.00	-21.68	Peak	
5	480.0800	35.11	-9.21	25.90	46.00	-20.10	Peak	
6	800.1800	32.71	-1.36	31.35	46.00	-14.65	Peak	

Test Mode: UNII-2C/TX A Mode 5580MHz_Adapter: RD1202000-C55-29MG

Horizontal

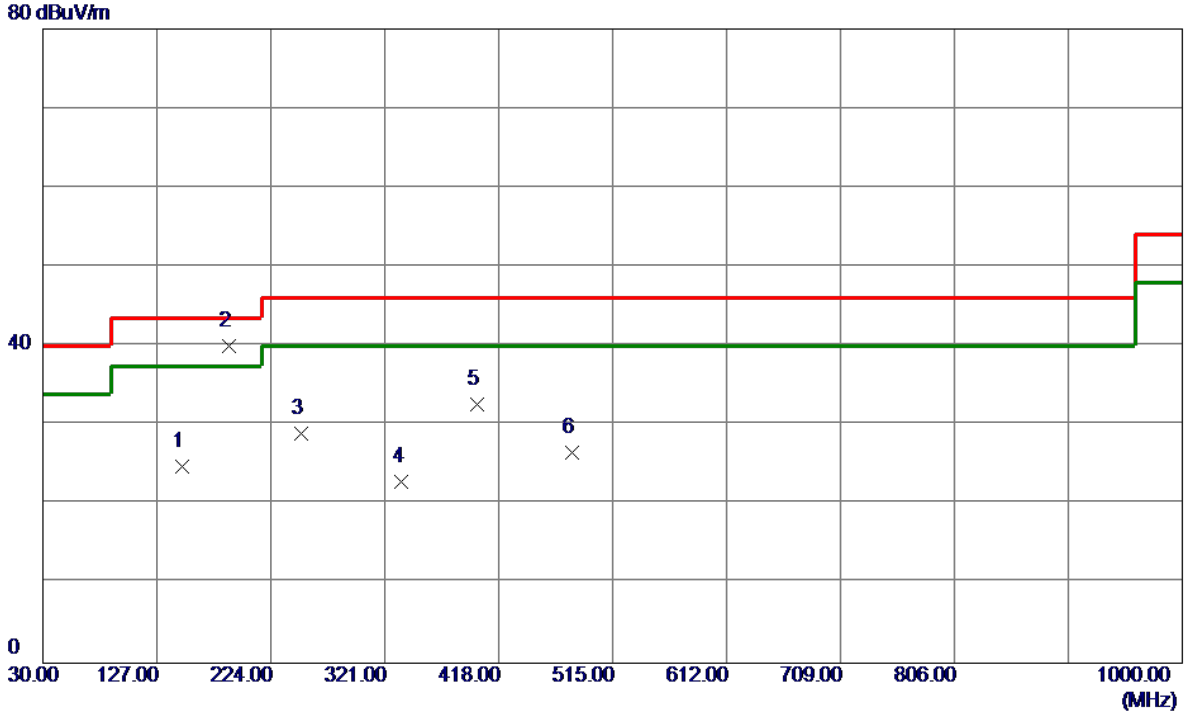

No.	Freq. MHz	Reading Level dBuV/m	Correct Factor dB	Measure ment dBuV/m	Limit dBuV/m	Margin dB	Detector	Comment
1	148.3400	38.45	-13.64	24.81	43.50	-18.69	Peak	
2 *	188.1100	52.65	-12.69	39.96	43.50	-3.54	QP	
3	250.1900	43.88	-14.90	28.98	46.00	-17.02	Peak	
4	335.5500	35.08	-12.21	22.87	46.00	-23.13	Peak	
5	399.5700	44.04	-11.37	32.67	46.00	-13.33	Peak	
6	480.0800	35.74	-9.21	26.53	46.00	-19.47	Peak	

Test Mode: UNII-2C/TX A Mode 5700MHz_Adapter: RD1202000-C55-29MG

Vertical

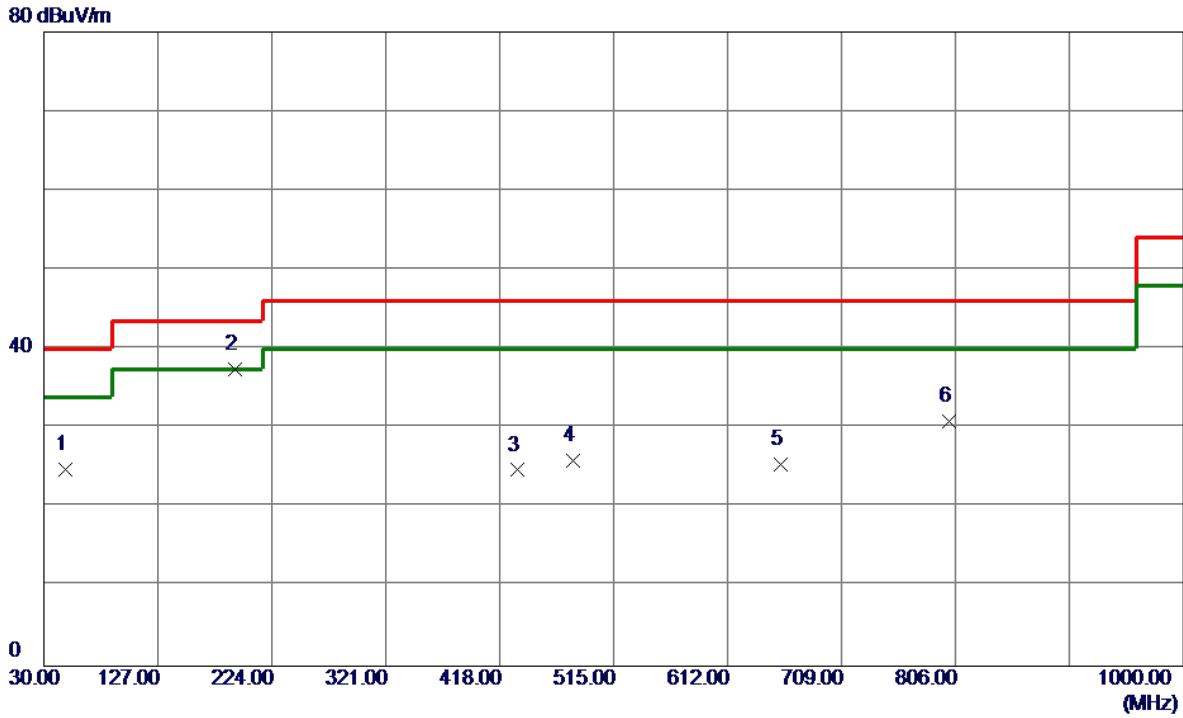

No.	Freq. MHz	Reading Level dBuV/m	Correct Factor dB	Measure ment dBuV/m	Limit dBuV/m	Margin dB	Detector	Comment
1	48.4300	38.03	-13.28	24.75	40.00	-15.25	Peak	
2 *	192.9600	50.61	-13.11	37.50	43.50	-6.00	Peak	
3	433.5200	35.13	-10.41	24.72	46.00	-21.28	Peak	
4	480.0800	35.11	-9.21	25.90	46.00	-20.10	Peak	
5	657.5900	30.65	-5.24	25.41	46.00	-20.59	Peak	
6	800.1800	32.21	-1.36	30.85	46.00	-15.15	Peak	

Test Mode: UNII-2C/TX A Mode 5700MHz_Adapter: RD1202000-C55-29MG

Horizontal

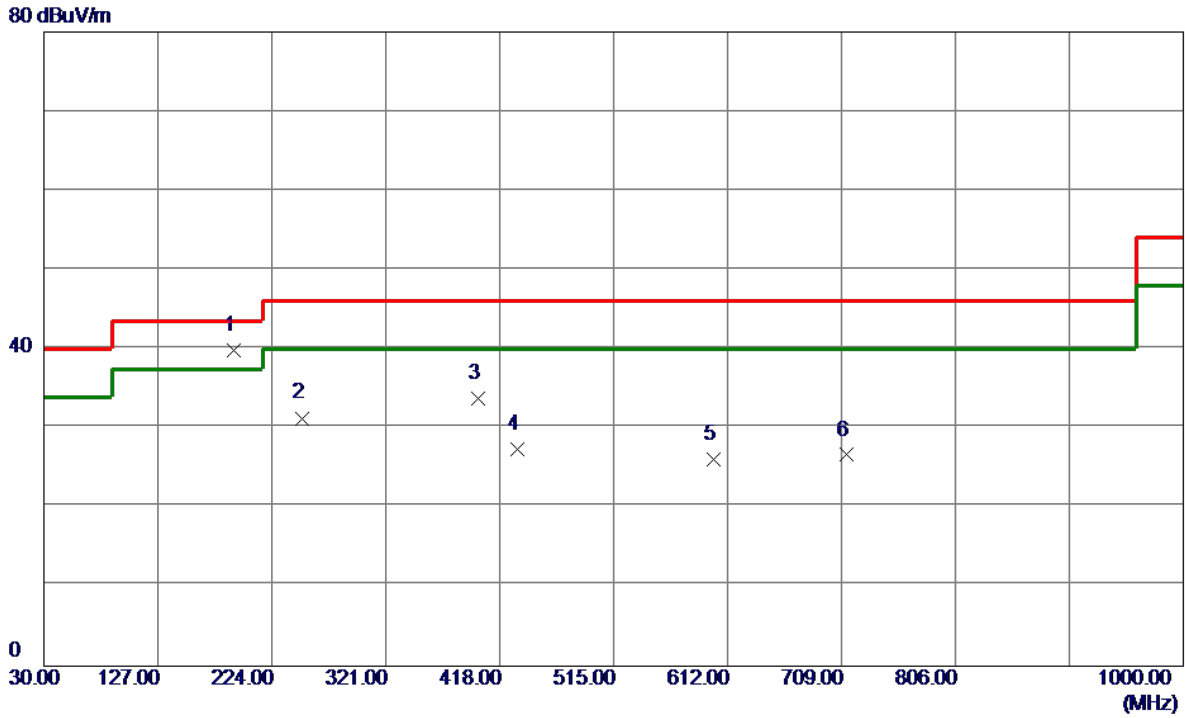

No.	Freq. MHz	Reading Level dBuV/m	Correct Factor dB	Measure ment dBuV/m	Limit dBuV/m	Margin dB	Detector	Comment
1 *	191.9900	52.83	-13.03	39.80	43.50	-3.70	QP	
2	250.1900	46.18	-14.90	31.28	46.00	-14.72	Peak	
3	399.5700	45.10	-11.37	33.73	46.00	-12.27	Peak	
4	433.5200	37.82	-10.41	27.41	46.00	-18.59	Peak	
5	600.3600	32.50	-6.41	26.09	46.00	-19.91	Peak	
6	712.8800	30.19	-3.55	26.64	46.00	-19.36	Peak	

Internal Antenna

Test Mode: UNII-2A/TX A Mode 5260MHz _Adapter: RD1201500-C55-81MG

Vertical

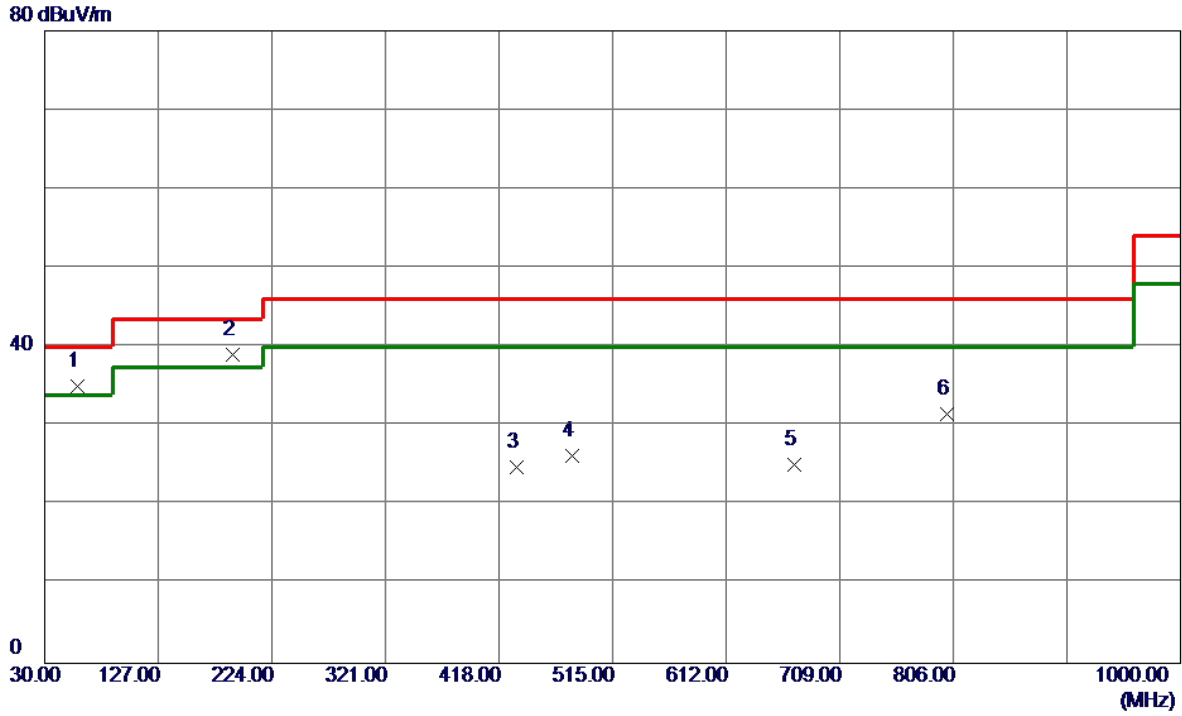

No.	Freq. MHz	Reading Level dBuV/m	Correct Factor dB	Measure ment dBuV/m	Limit dBuV/m	Margin dB	Detector	Comment
1	58.1300	49.15	-14.13	35.02	40.00	-4.98	Peak	
2 *	191.0200	52.03	-12.94	39.09	43.50	-4.41	Peak	
3	433.5200	35.23	-10.41	24.82	46.00	-21.18	Peak	
4	480.0800	35.47	-9.21	26.26	46.00	-19.74	Peak	
5	670.2000	29.98	-4.85	25.13	46.00	-20.87	Peak	
6	800.1800	32.88	-1.36	31.52	46.00	-14.48	Peak	

Test Mode: UNII-2A/TX A Mode 5260MHz_Adapter: RD1201500-C55-81MG

Horizontal

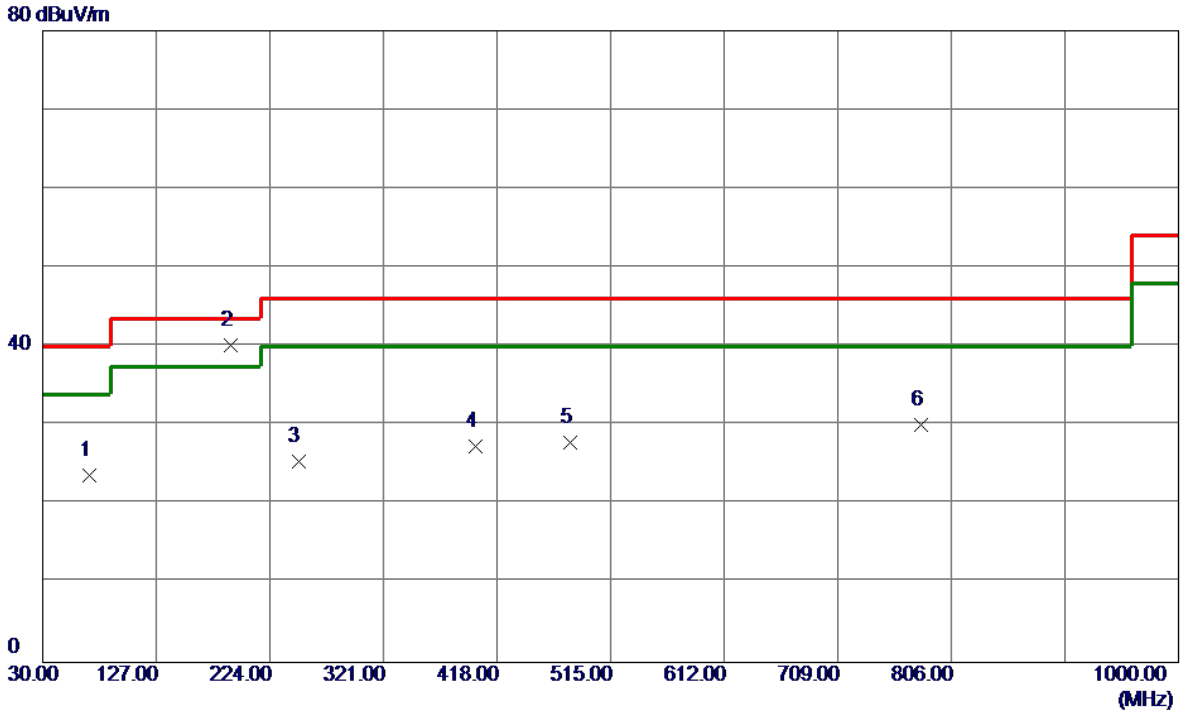

No.	Freq. MHz	Reading Level dBuV/m	Correct Factor dB	Measure ment dBuV/m	Limit dBuV/m	Margin dB	Detector	Comment
1	69.7699	40.16	-16.46	23.70	40.00	-16.30	Peak	
2 *	190.0500	53.06	-12.85	40.21	43.50	-3.29	QP	
3	248.2500	40.22	-14.79	25.43	46.00	-20.57	Peak	
4	399.5700	38.75	-11.37	27.38	46.00	-18.62	Peak	
5	480.0800	37.07	-9.21	27.86	46.00	-18.14	Peak	
6	779.8100	31.88	-1.80	30.08	46.00	-15.92	Peak	

Test Mode: UNII-2A/TX A Mode 5300MHz_Adapter: RD1201500-C55-81MG

Vertical

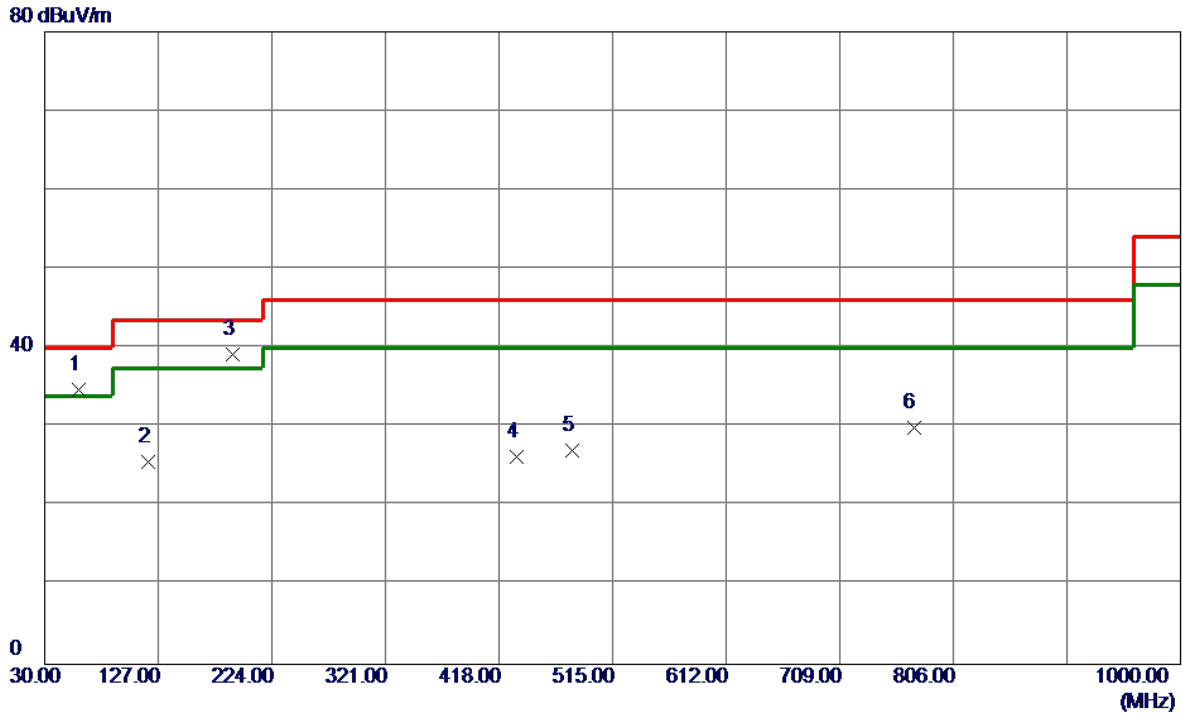

No.	Freq. MHz	Reading Level dBuV/m	Correct Factor dB	Measure ment dBuV/m	Limit dBuV/m	Margin dB	Detector	Comment
1	59.1000	48.97	-14.22	34.75	40.00	-5.25	Peak	
2	118.2700	41.13	-15.53	25.60	43.50	-17.90	Peak	
3 *	191.0200	52.20	-12.94	39.26	43.50	-4.24	Peak	
4	433.5200	36.72	-10.41	26.31	46.00	-19.69	Peak	
5	480.0800	36.29	-9.21	27.08	46.00	-18.92	Peak	
6	772.0500	31.82	-1.97	29.85	46.00	-16.15	Peak	

Test Mode: UNII-2A/TX A Mode 5300MHz_Adapter: RD1201500-C55-81MG

Horizontal

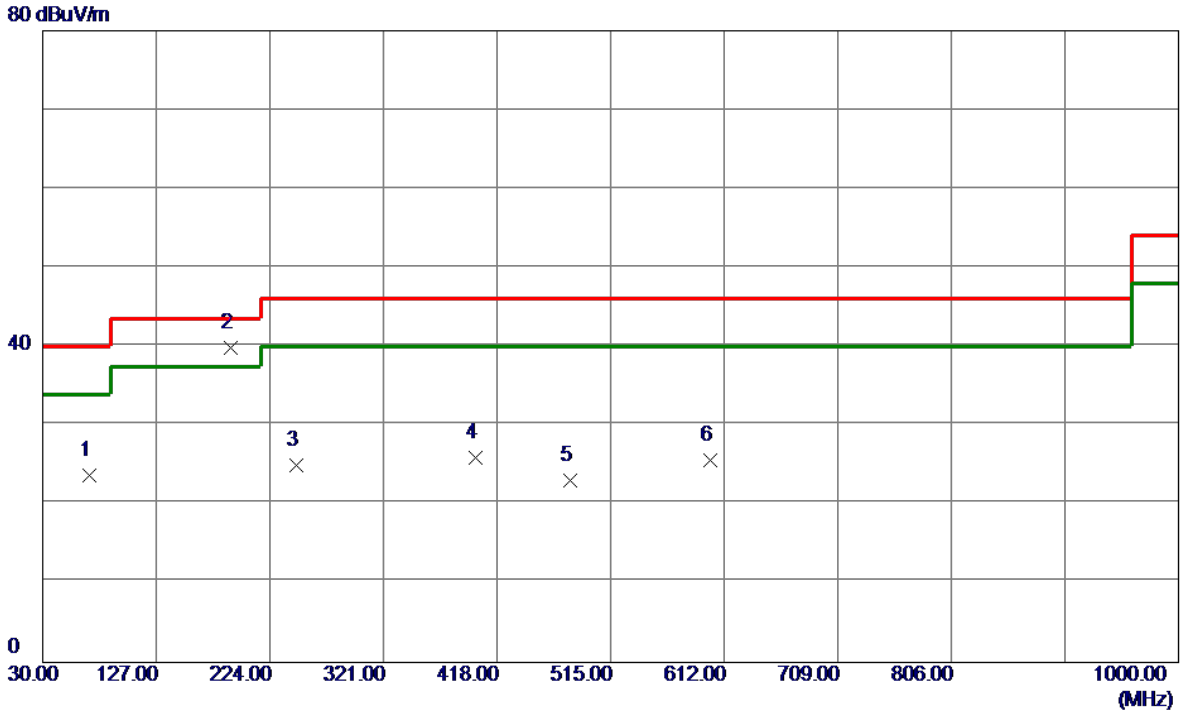

No.	Freq. MHz	Reading Level dBuV/m	Correct Factor dB	Measure ment dBuV/m	Limit dBuV/m	Margin dB	Detector	Comment
1	69.7699	40.17	-16.46	23.71	40.00	-16.29	Peak	
2 *	191.0200	52.86	-12.94	39.92	43.50	-3.58	QP	
3	246.3100	39.71	-14.69	25.02	46.00	-20.98	Peak	
4	399.5700	37.24	-11.37	25.87	46.00	-20.13	Peak	
5	480.0800	32.31	-9.21	23.10	46.00	-22.90	Peak	
6	600.3600	31.98	-6.41	25.57	46.00	-20.43	Peak	

Test Mode: UNII-2A/TX A Mode 5320MHz_Adapter: RD1201500-C55-81MG

Vertical

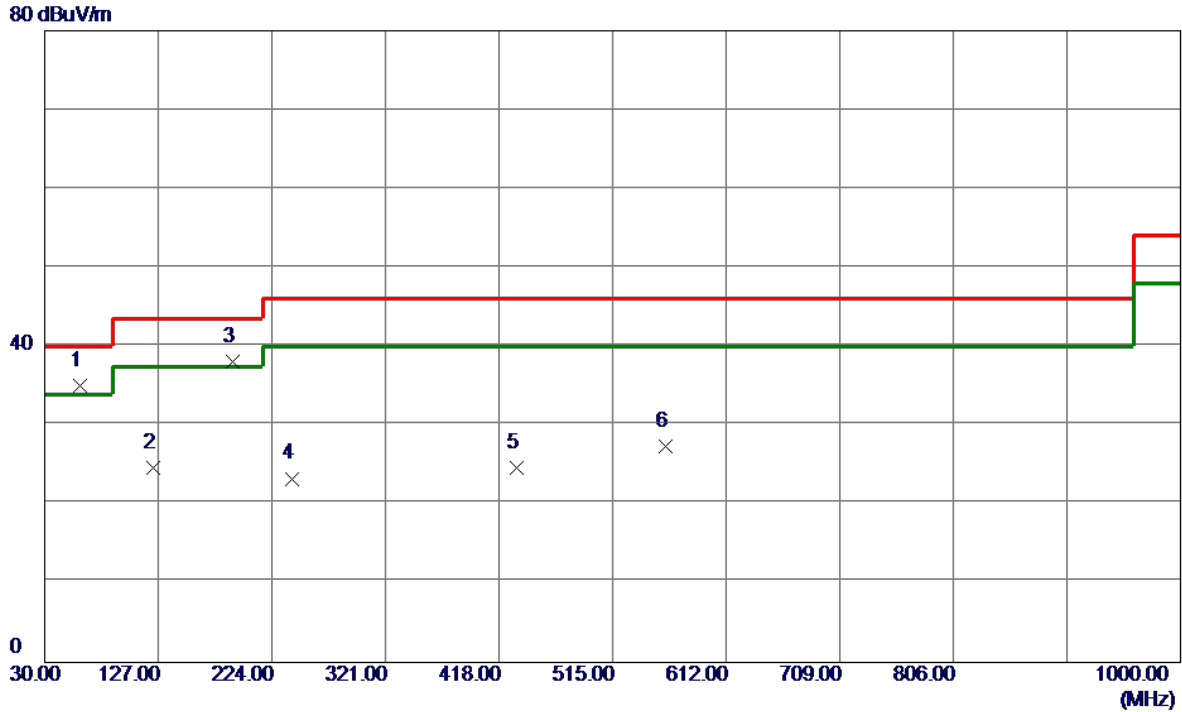

No.	Freq. MHz	Reading Level dBuV/m	Correct Factor dB	Measure ment dBuV/m	Limit dBuV/m	Margin dB	Detector	Comment
1 *	60.0700	49.41	-14.32	35.09	40.00	-4.91	Peak	
2	123.1200	39.76	-15.18	24.58	43.50	-18.92	Peak	
3	191.0200	50.96	-12.94	38.02	43.50	-5.48	Peak	
4	241.4600	37.72	-14.44	23.28	46.00	-22.72	Peak	
5	433.5200	35.00	-10.41	24.59	46.00	-21.41	Peak	
6	560.5900	34.87	-7.44	27.43	46.00	-18.57	Peak	

Test Mode: UNII-2A/TX A Mode 5320MHz_Adapter: RD1201500-C55-81MG

Horizontal

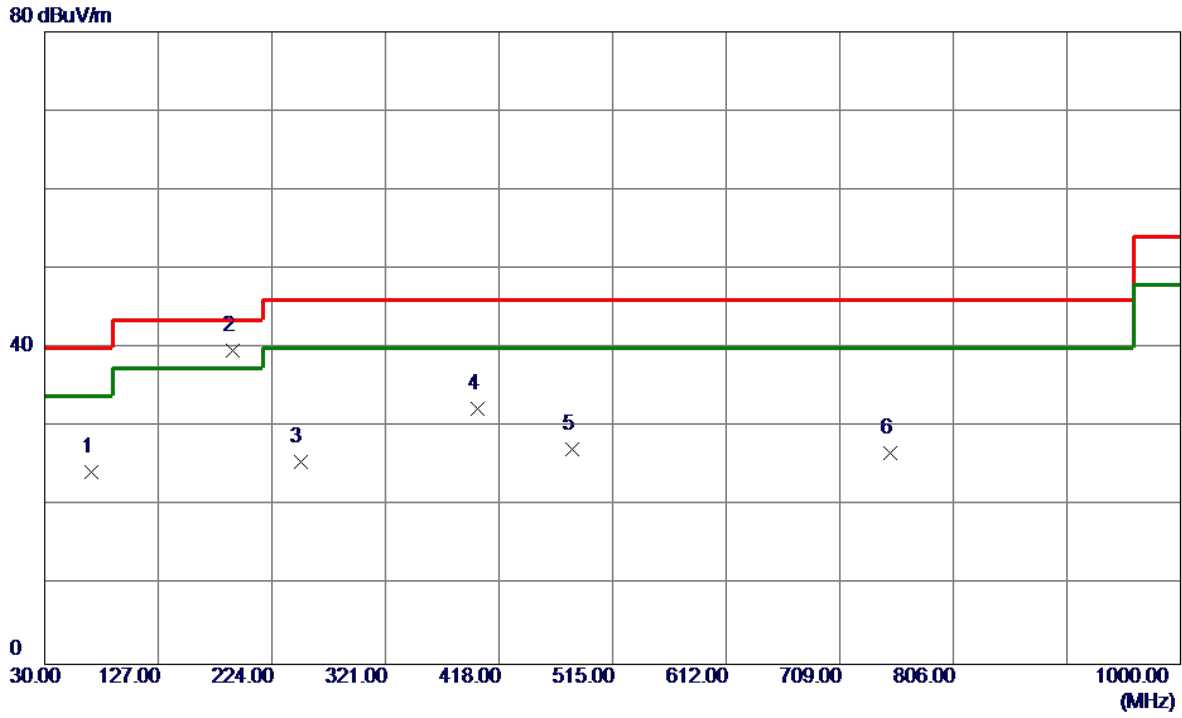

No.	Freq. MHz	Reading Level dBuV/m	Correct Factor dB	Measure ment dBuV/m	Limit dBuV/m	Margin dB	Detector	Comment
1	69.7699	40.75	-16.46	24.29	40.00	-15.71	Peak	
2 *	191.0200	52.55	-12.94	39.61	43.50	-3.89	QP	
3	248.2500	40.41	-14.79	25.62	46.00	-20.38	Peak	
4	399.5700	43.63	-11.37	32.26	46.00	-13.74	Peak	
5	480.0800	36.41	-9.21	27.20	46.00	-18.80	Peak	
6	751.6800	29.16	-2.41	26.75	46.00	-19.25	Peak	

Test Mode: UNII-2C/TX A Mode 5500MHz_Adapter: RD1201500-C55-81MG

Vertical

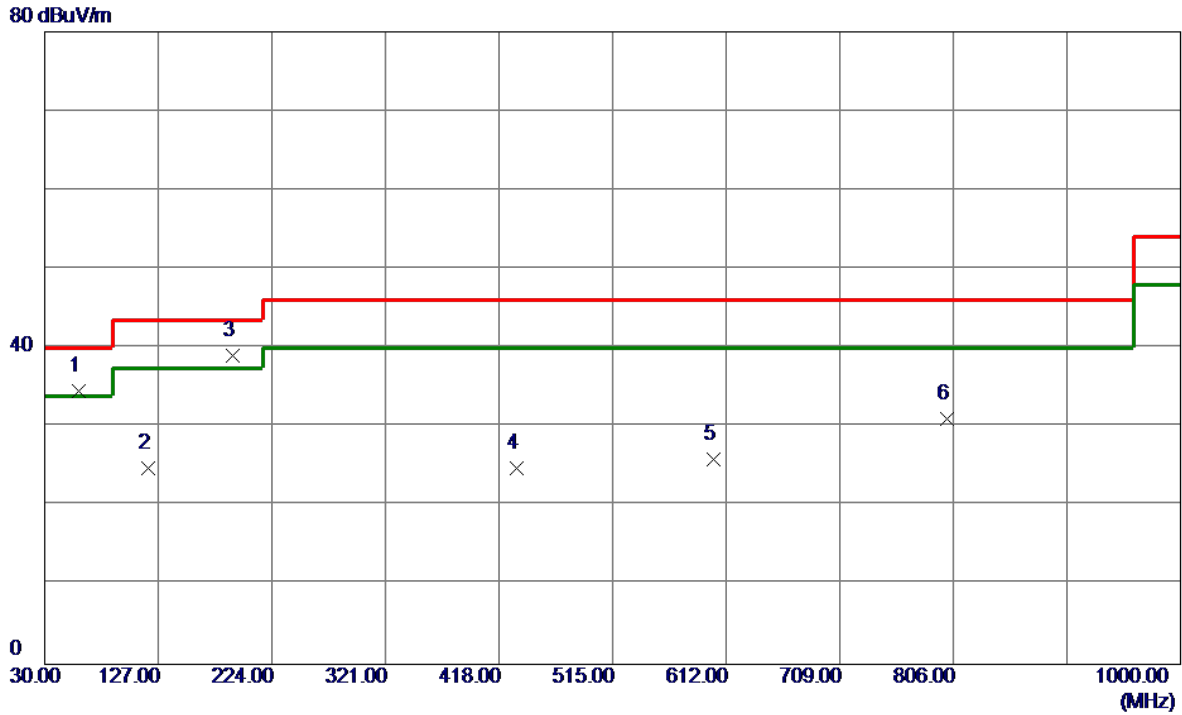

No.	Freq. MHz	Reading Level dBuV/m	Correct Factor dB	Measure ment dBuV/m	Limit dBuV/m	Margin dB	Detector	Comment
1	59.1000	48.72	-14.22	34.50	40.00	-5.50	Peak	
2	118.2700	40.28	-15.53	24.75	43.50	-18.75	Peak	
3 *	191.0200	51.99	-12.94	39.05	43.50	-4.45	Peak	
4	433.5200	35.23	-10.41	24.82	46.00	-21.18	Peak	
5	601.3300	32.24	-6.39	25.85	46.00	-20.15	Peak	
6	800.1800	32.35	-1.36	30.99	46.00	-15.01	Peak	

Test Mode: UNII-2C/TX A Mode 5500MHz_Adapter: RD1201500-C55-81MG

Horizontal

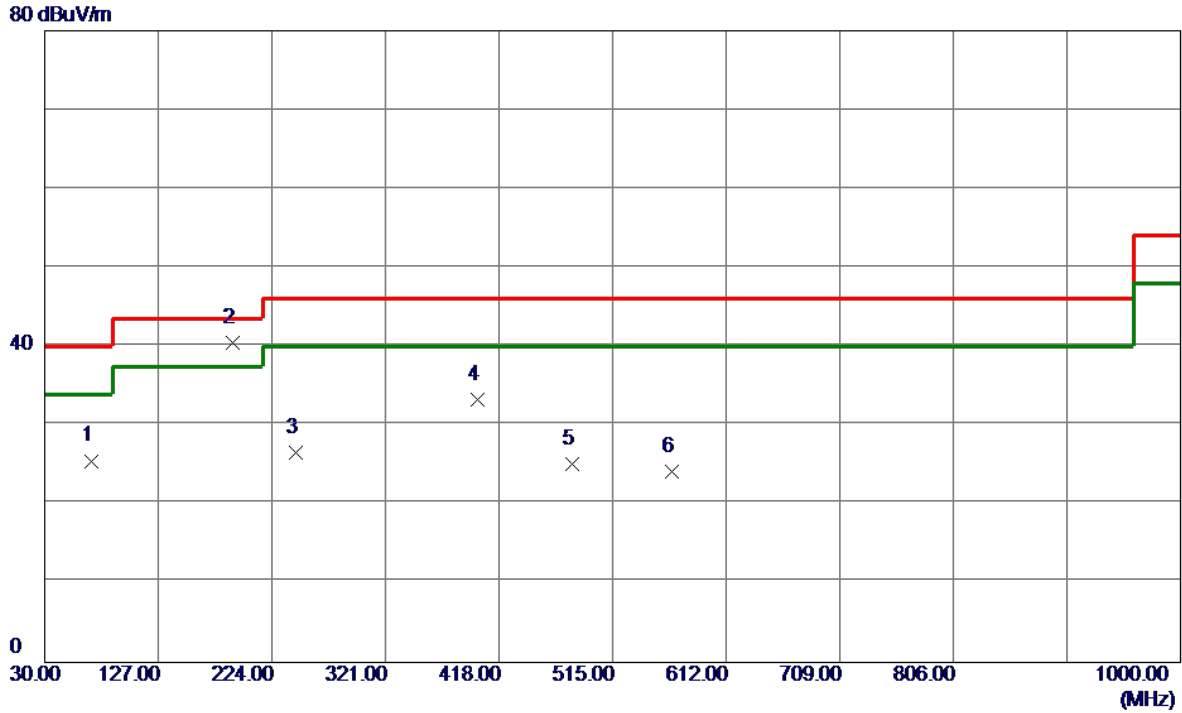

No.	Freq. MHz	Reading Level dBuV/m	Correct Factor dB	Measure ment dBuV/m	Limit dBuV/m	Margin dB	Detector	Comment
1	69.7699	41.98	-16.46	25.52	40.00	-14.48	Peak	
2 *	190.0500	53.30	-12.85	40.45	43.50	-3.05	QP	
3	244.3700	41.22	-14.59	26.63	46.00	-19.37	Peak	
4	399.5700	44.66	-11.37	33.29	46.00	-12.71	Peak	
5	480.0800	34.40	-9.21	25.19	46.00	-20.81	Peak	
6	565.4400	31.44	-7.32	24.12	46.00	-21.88	Peak	

Test Mode: UNII-2C/TX A Mode 5580MHz_Adapter: RD1201500-C55-81MG

Vertical

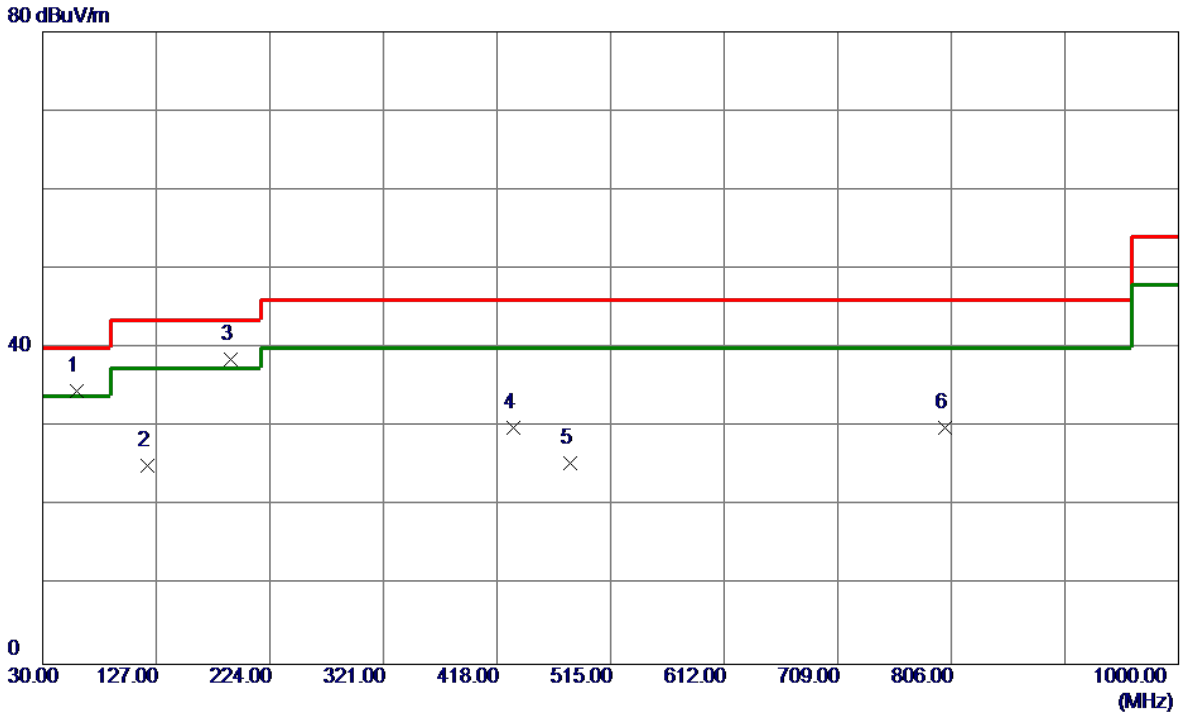

No.	Freq. MHz	Reading Level dBuV/m	Correct Factor dB	Measure ment dBuV/m	Limit dBuV/m	Margin dB	Detector	Comment
1	59.1000	48.72	-14.22	34.50	40.00	-5.50	Peak	
2	119.2400	40.64	-15.46	25.18	43.50	-18.32	Peak	
3 *	191.0200	51.49	-12.94	38.55	43.50	-4.95	Peak	
4	431.5800	40.42	-10.46	29.96	46.00	-16.04	Peak	
5	480.0800	34.60	-9.21	25.39	46.00	-20.61	Peak	
6	800.1800	31.35	-1.36	29.99	46.00	-16.01	Peak	

Test Mode: UNII-2C/TX A Mode 5580MHz_Adapter: RD1201500-C55-81MG

Horizontal

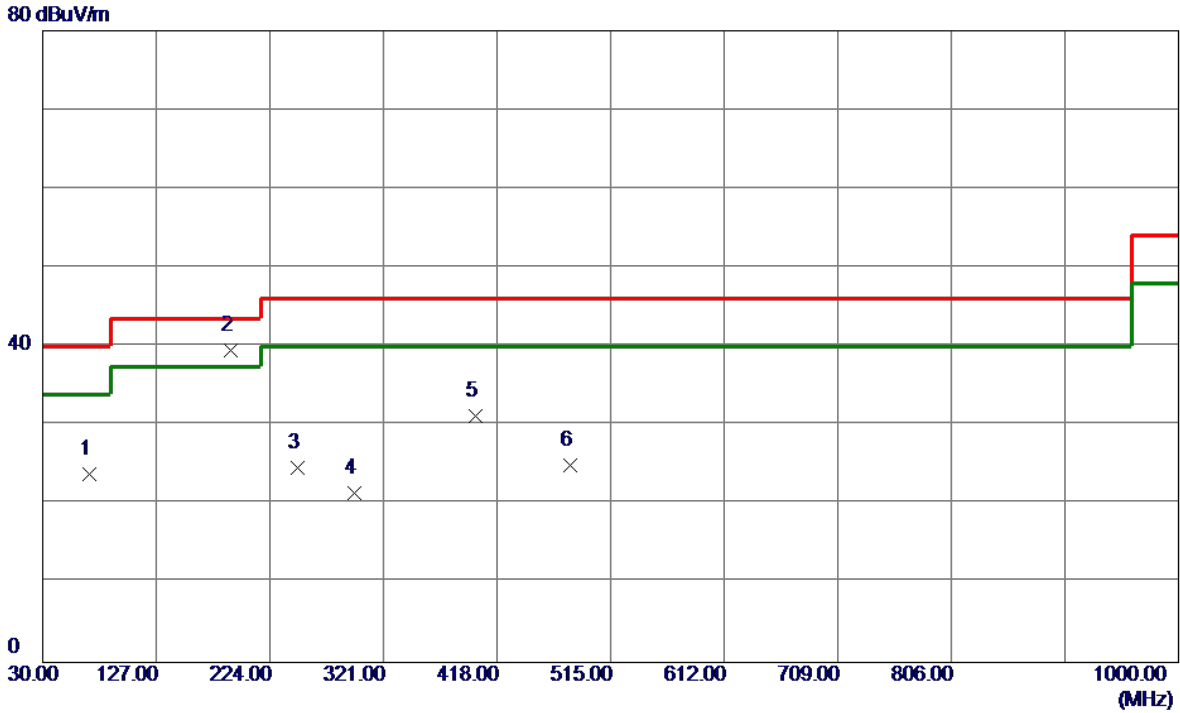

No.	Freq. MHz	Reading Level dBuV/m	Correct Factor dB	Measure ment dBuV/m	Limit dBuV/m	Margin dB	Detector	Comment
1	69.7699	40.23	-16.46	23.77	40.00	-16.23	Peak	
2 *	191.0200	52.50	-12.94	39.56	43.50	-3.94	QP	
3	247.2800	39.38	-14.74	24.64	46.00	-21.36	Peak	
4	295.7800	34.92	-13.41	21.51	46.00	-24.49	Peak	
5	399.5700	42.55	-11.37	31.18	46.00	-14.82	Peak	
6	480.0800	34.14	-9.21	24.93	46.00	-21.07	Peak	

Test Mode: UNII-2C/TX A Mode 5700MHz_Adapter: RD1201500-C55-81MG

Vertical

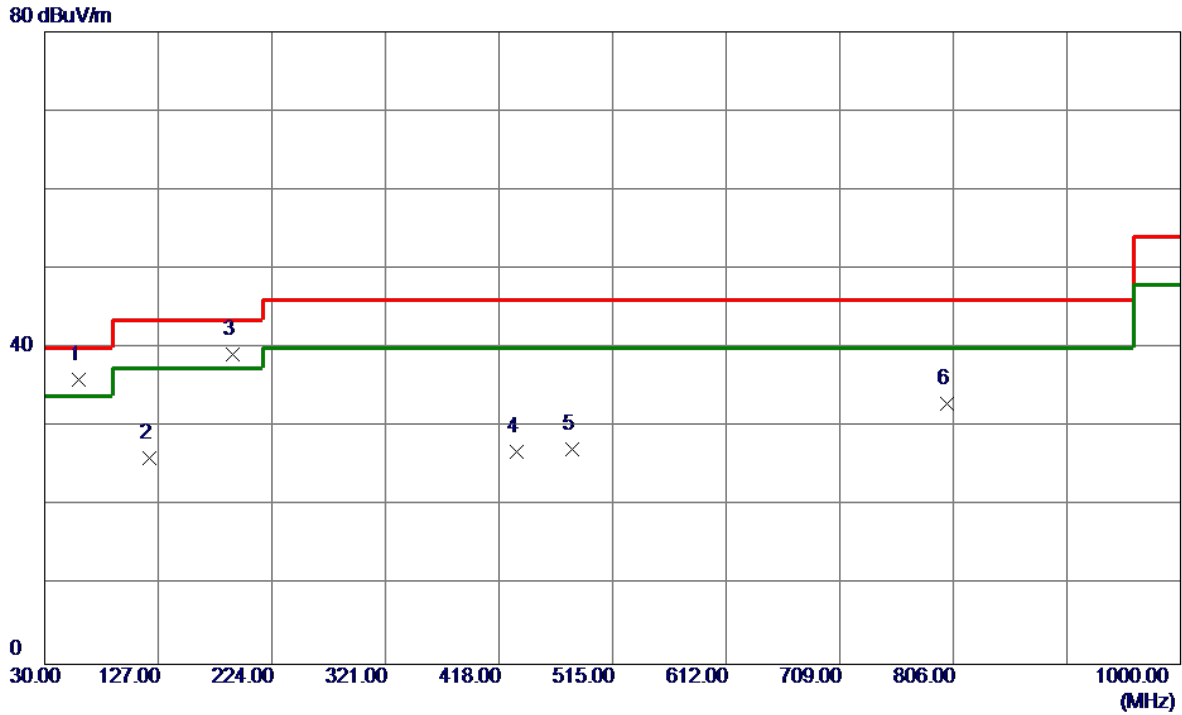

No.	Freq. MHz	Reading Level dBuV/m	Correct Factor dB	Measure ment dBuV/m	Limit dBuV/m	Margin dB	Detector	Comment
1 *	59.1000	50.22	-14.22	36.00	40.00	-4.00	Peak	
2	119.2400	41.55	-15.46	26.09	43.50	-17.41	Peak	
3	190.0500	52.07	-12.85	39.22	43.50	-4.28	Peak	
4	433.5200	37.26	-10.41	26.85	46.00	-19.15	Peak	
5	480.0800	36.41	-9.21	27.20	46.00	-18.80	Peak	
6	800.1800	34.34	-1.36	32.98	46.00	-13.02	Peak	

Test Mode: UNII-2C/TX A Mode 5700MHz_Adapter: RD1201500-C55-81MG

Horizontal

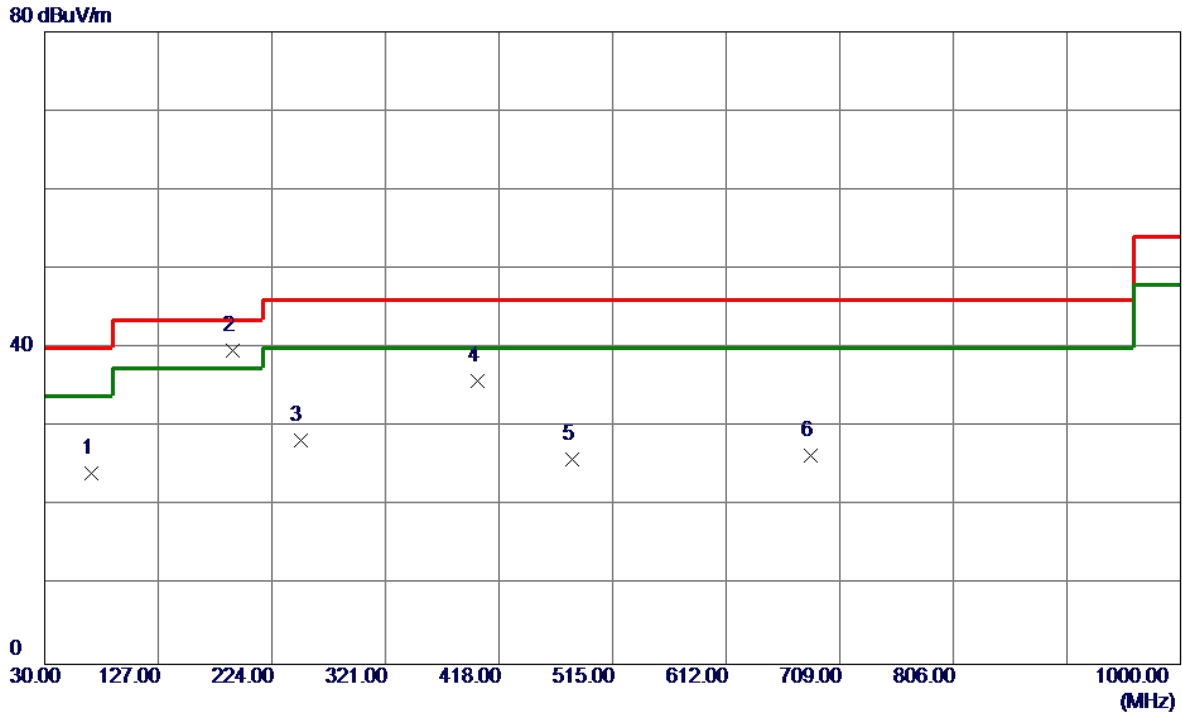

No.	Freq. MHz	Reading Level dBuV/m	Correct Factor dB	Measure ment dBuV/m	Limit dBuV/m	Margin dB	Detector	Comment
1	69.7699	40.62	-16.46	24.16	40.00	-15.84	Peak	
2 *	190.0500	52.50	-12.85	39.65	43.50	-3.85	QP	
3	248.2500	43.11	-14.79	28.32	46.00	-17.68	Peak	
4	399.5700	47.18	-11.37	35.81	46.00	-10.19	Peak	
5	480.0800	35.13	-9.21	25.92	46.00	-20.08	Peak	
6	683.7800	30.81	-4.44	26.37	46.00	-19.63	Peak	

Test Mode: UNII-2A/TX A Mode 5260MHz_Adapter: RD1201500-C55-24MG

Vertical

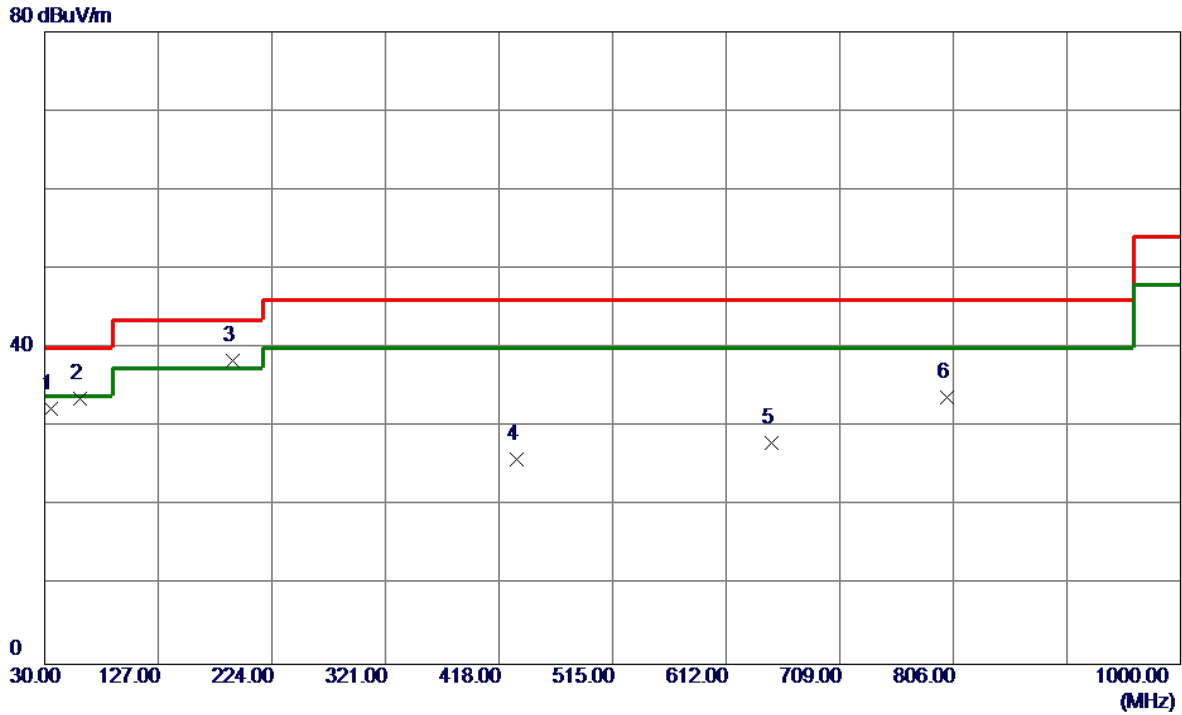

No.	Freq. MHz	Reading Level dBuV/m	Correct Factor dB	Measure ment dBuV/m	Limit dBuV/m	Margin dB	Detector	Comment
1	35.8200	46.88	-14.51	32.37	40.00	-7.63	Peak	
2	60.0700	47.91	-14.32	33.59	40.00	-6.41	Peak	
3 *	191.0200	51.30	-12.94	38.36	43.50	-5.14	Peak	
4	433.5200	36.40	-10.41	25.99	46.00	-20.01	Peak	
5	650.8000	33.51	-5.45	28.06	46.00	-17.94	Peak	
6	800.1800	35.19	-1.36	33.83	46.00	-12.17	Peak	

Test Mode: UNII-2A/TX A Mode 5260MHz_Adapter: RD1201500-C55-24MG

Horizontal

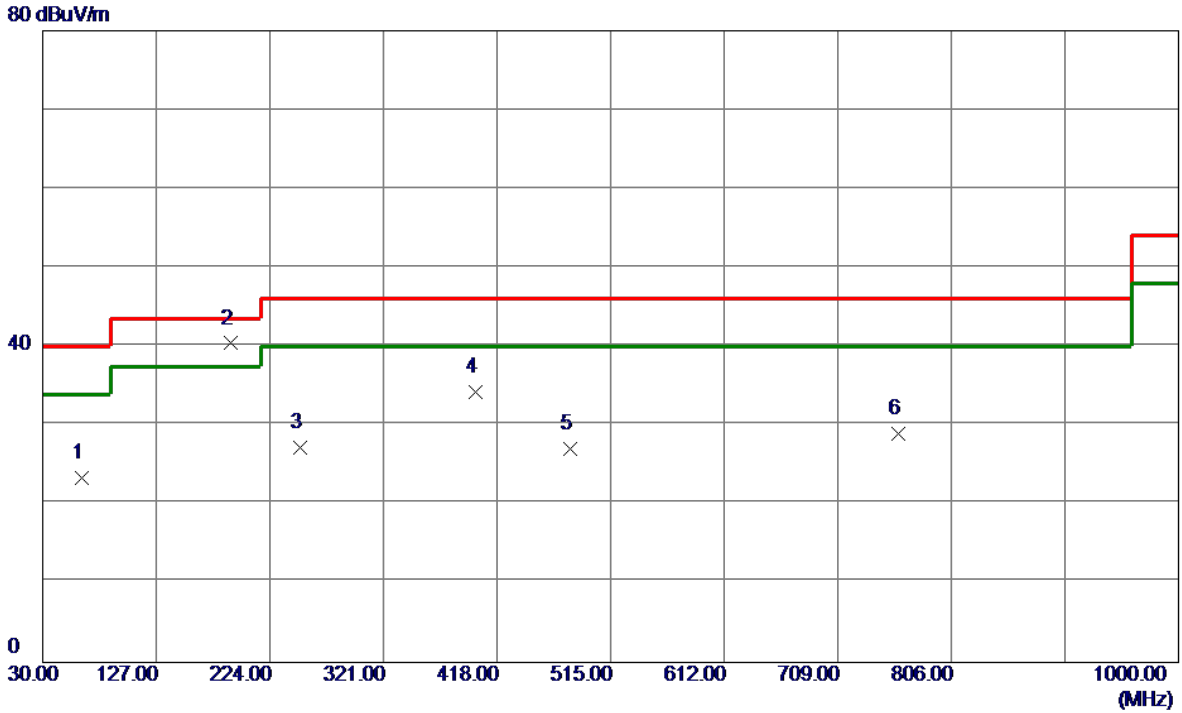

No.	Freq. MHz	Reading Level dBuV/m	Correct Factor dB	Measure ment dBuV/m	Limit dBuV/m	Margin dB	Detector	Comment
1	62.9800	38.16	-14.82	23.34	40.00	-16.66	Peak	
2 *	190.0500	53.25	-12.85	40.40	43.50	-3.10	QP	
3	250.1900	42.11	-14.90	27.21	46.00	-18.79	Peak	
4	399.5700	45.56	-11.37	34.19	46.00	-11.81	Peak	
5	480.0800	36.18	-9.21	26.97	46.00	-19.03	Peak	
6	760.4099	31.16	-2.22	28.94	46.00	-17.06	Peak	

Test Mode: UNII-2A/TX A Mode 5300MHz_Adapter: RD1201500-C55-24MG

Vertical

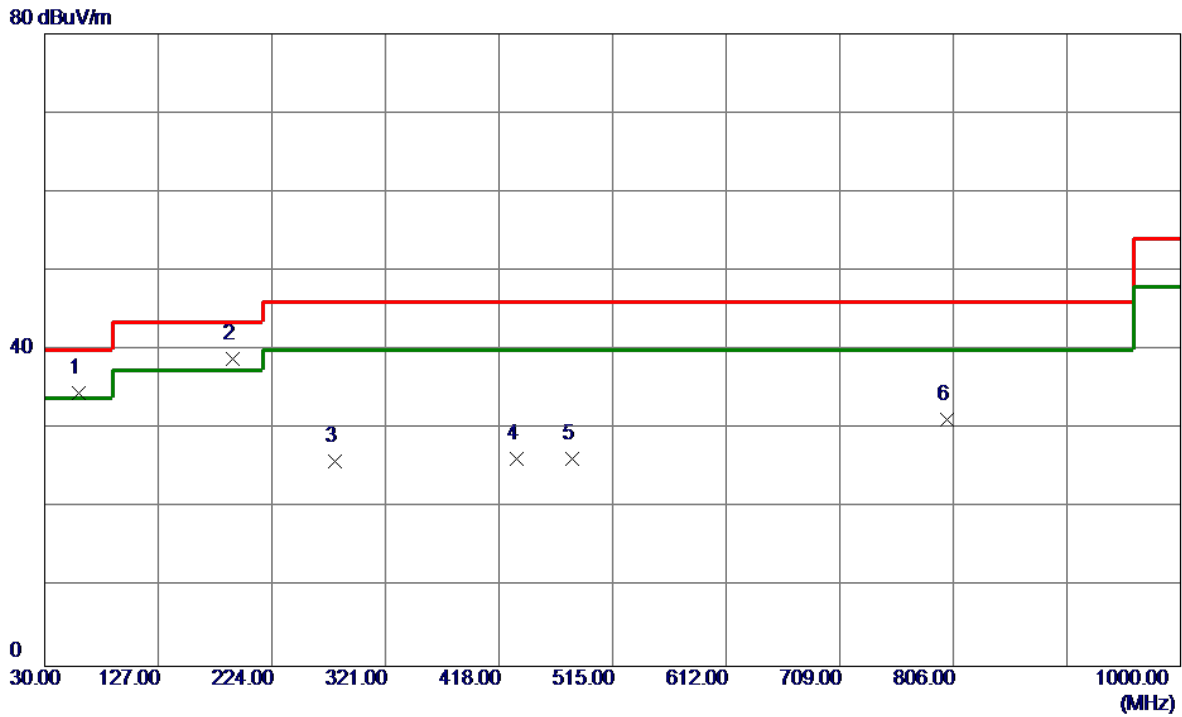

No.	Freq. MHz	Reading Level dBuV/m	Correct Factor dB	Measure ment dBuV/m	Limit dBuV/m	Margin dB	Detector	Comment
1	59.1000	48.78	-14.22	34.56	40.00	-5.44	Peak	
2 *	191.0200	51.85	-12.94	38.91	43.50	-4.59	Peak	
3	278.3200	40.94	-14.95	25.99	46.00	-20.01	Peak	
4	433.5200	36.65	-10.41	26.24	46.00	-19.76	Peak	
5	480.0800	35.47	-9.21	26.26	46.00	-19.74	Peak	
6	800.1800	32.60	-1.36	31.24	46.00	-14.76	Peak	

Test Mode: UNII-2A/TX A Mode 5300MHz_Adapter: RD1201500-C55-24MG

Horizontal

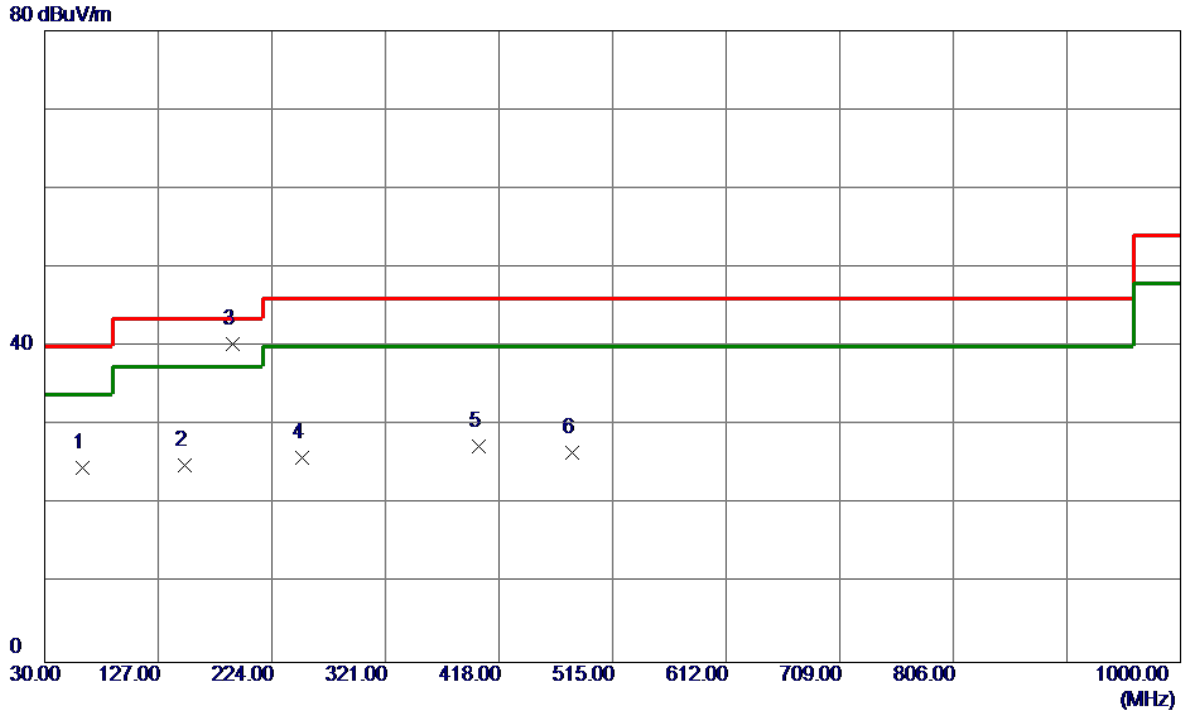

No.	Freq. MHz	Reading Level dBuV/m	Correct Factor dB	Measure ment dBuV/m	Limit dBuV/m	Margin dB	Detector	Comment
1	62.0100	39.29	-14.65	24.64	40.00	-15.36	Peak	
2	149.3100	38.50	-13.57	24.93	43.50	-18.57	Peak	
3 *	190.0500	53.11	-12.85	40.26	43.50	-3.24	QP	
4	250.1900	40.89	-14.90	25.99	46.00	-20.01	Peak	
5	400.5400	38.73	-11.34	27.39	46.00	-18.61	Peak	
6	480.0800	35.78	-9.21	26.57	46.00	-19.43	Peak	

Test Mode: UNII-2A/TX A Mode 5320MHz_Adapter: RD1201500-C55-24MG

Vertical

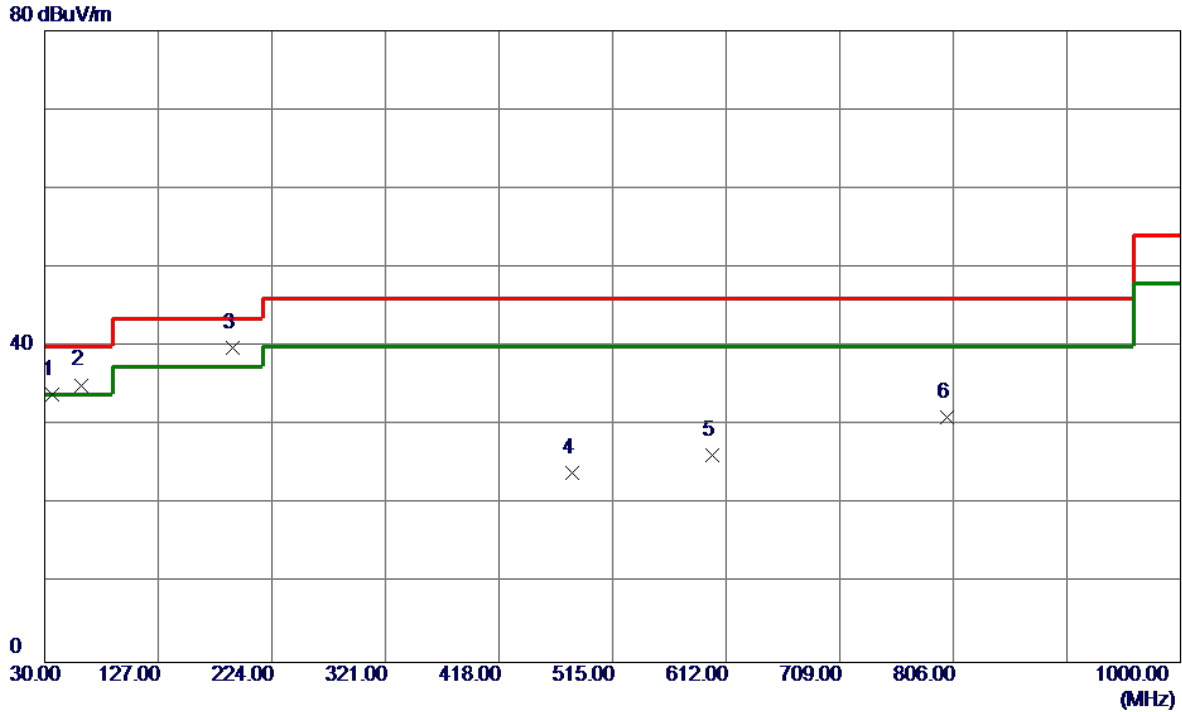

No.	Freq. MHz	Reading Level dBuV/m	Correct Factor dB	Measure ment dBuV/m	Limit dBuV/m	Margin dB	Detector	Comment
1	36.7900	48.35	-14.41	33.94	40.00	-6.06	Peak	
2	61.0400	49.60	-14.48	35.12	40.00	-4.88	Peak	
3 *	191.0200	52.85	-12.94	39.91	43.50	-3.59	Peak	
4	480.0800	33.15	-9.21	23.94	46.00	-22.06	Peak	
5	600.3600	32.64	-6.41	26.23	46.00	-19.77	Peak	
6	800.1800	32.40	-1.36	31.04	46.00	-14.96	Peak	

Test Mode: UNII-2A/TX A Mode 5320MHz_Adapter: RD1201500-C55-24MG

Horizontal

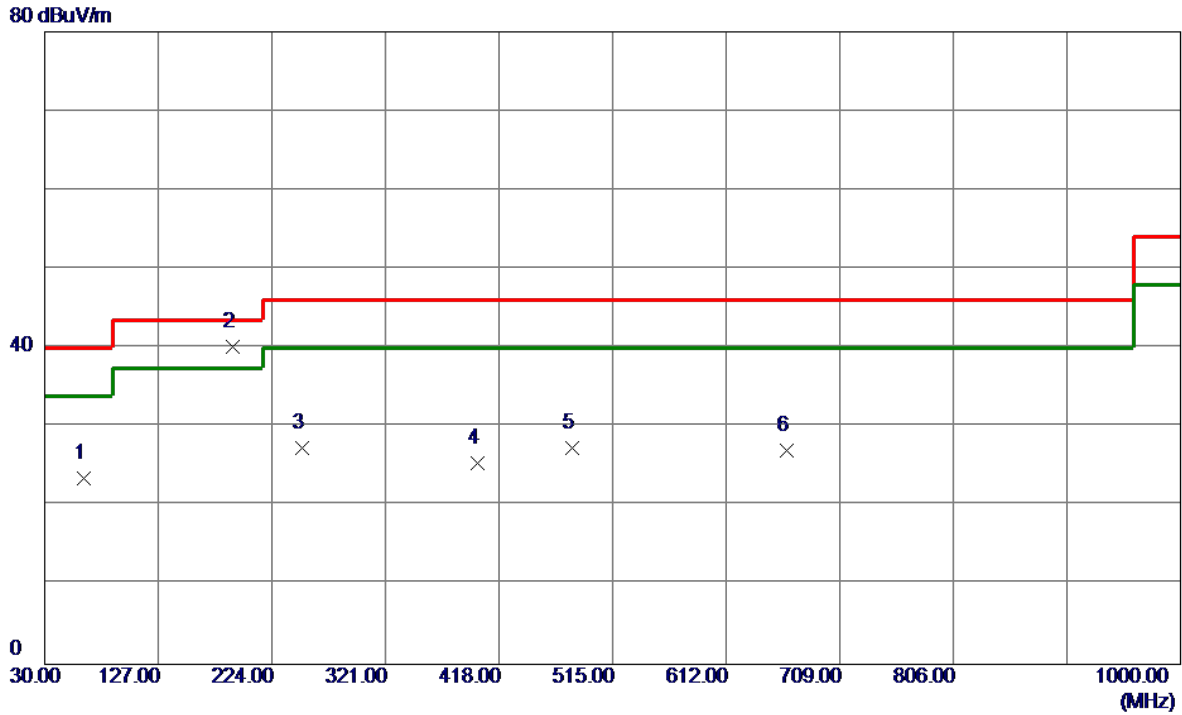

No.	Freq. MHz	Reading Level dBuV/m	Correct Factor dB	Measure ment dBuV/m	Limit dBuV/m	Margin dB	Detector	Comment
1	62.9800	38.38	-14.82	23.56	40.00	-16.44	Peak	
2 *	190.0500	53.05	-12.85	40.20	43.50	-3.30	QP	
3	250.1900	42.25	-14.90	27.35	46.00	-18.65	Peak	
4	399.5700	36.88	-11.37	25.51	46.00	-20.49	Peak	
5	480.0800	36.54	-9.21	27.33	46.00	-18.67	Peak	
6	663.4099	32.03	-5.06	26.97	46.00	-19.03	Peak	

Test Mode: UNII-2C/TX A Mode 5500MHz_Adapter: RD1201500-C55-24MG

Vertical

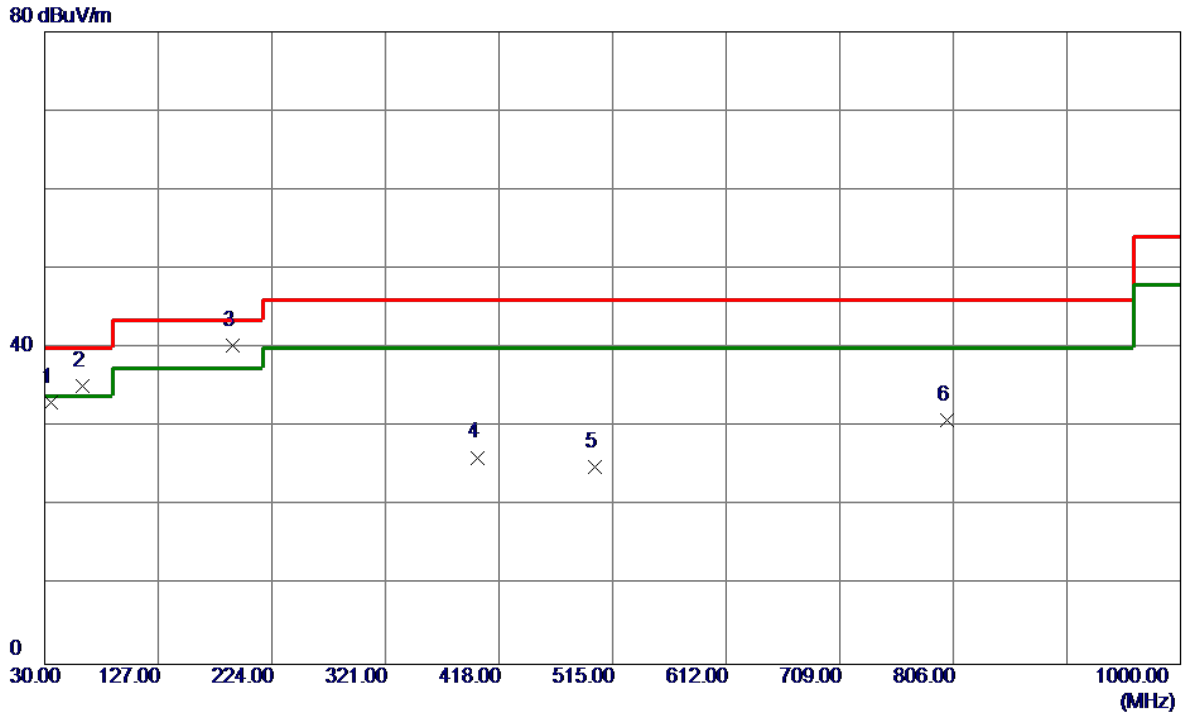

No.	Freq. MHz	Reading Level dBuV/m	Correct Factor dB	Measure ment dBuV/m	Limit dBuV/m	Margin dB	Detector	Comment
1	35.8200	47.61	-14.51	33.10	40.00	-6.90	Peak	
2	62.0100	49.91	-14.65	35.26	40.00	-4.74	Peak	
3 *	191.0200	53.23	-12.94	40.29	43.50	-3.21	Peak	
4	399.5700	37.53	-11.37	26.16	46.00	-19.84	Peak	
5	499.4800	33.68	-8.73	24.95	46.00	-21.05	Peak	
6	800.1800	32.31	-1.36	30.95	46.00	-15.05	Peak	

Test Mode: UNII-2C/TX A Mode 5500MHz_Adapter: RD1201500-C55-24MG

Horizontal

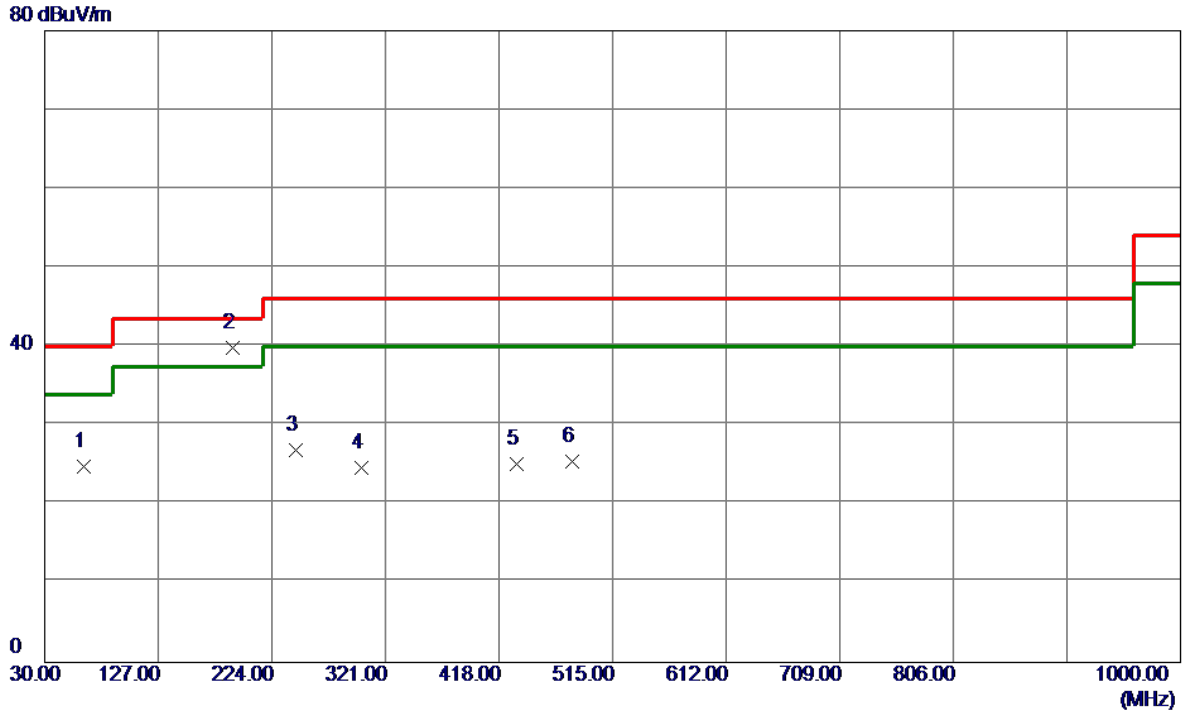

No.	Freq. MHz	Reading Level dBuV/m	Correct Factor dB	Measure ment dBuV/m	Limit dBuV/m	Margin dB	Detector	Comment
1	62.9800	39.61	-14.82	24.79	40.00	-15.21	Peak	
2 *	191.0200	52.77	-12.94	39.83	43.50	-3.67	QP	
3	244.3700	41.49	-14.59	26.90	46.00	-19.10	Peak	
4	300.6300	37.48	-12.82	24.66	46.00	-21.34	Peak	
5	433.5200	35.51	-10.41	25.10	46.00	-20.90	Peak	
6	480.0800	34.69	-9.21	25.48	46.00	-20.52	Peak	

Test Mode: UNII-2C/TX A Mode 5580MHz_Adapter: RD1201500-C55-24MG

Vertical

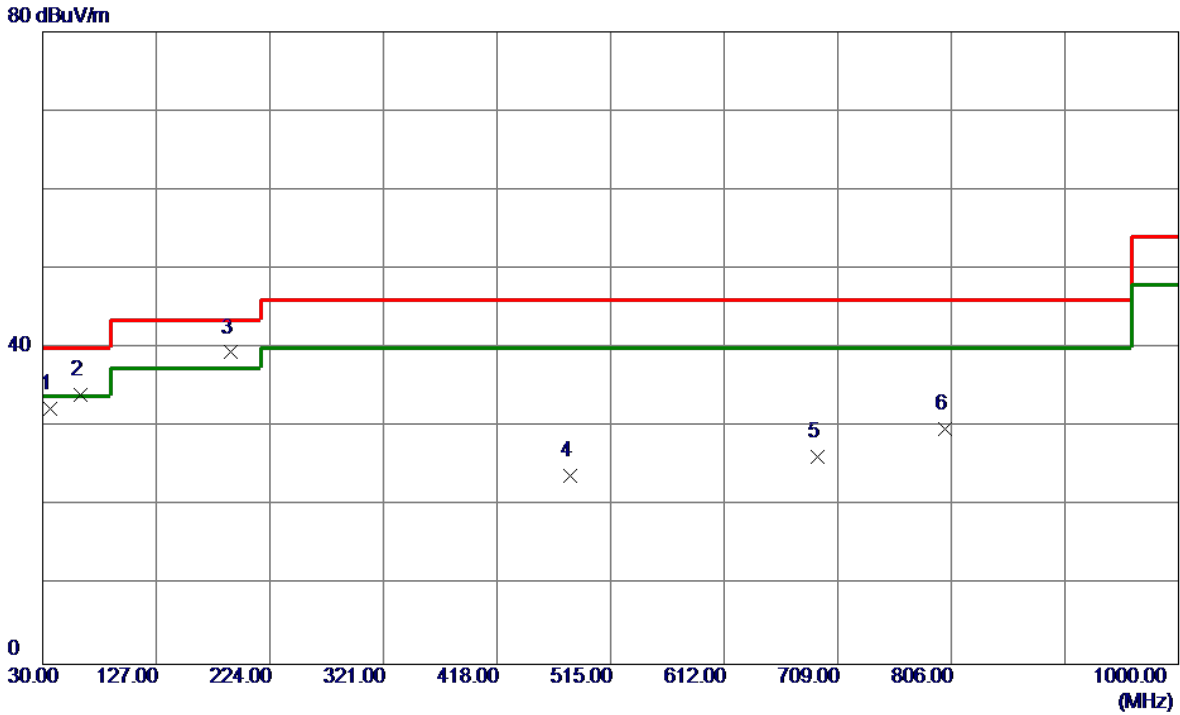

No.	Freq. MHz	Reading Level dBuV/m	Correct Factor dB	Measure ment dBuV/m	Limit dBuV/m	Margin dB	Detector	Comment
1	36.7900	46.74	-14.41	32.33	40.00	-7.67	Peak	
2	62.0100	48.77	-14.65	34.12	40.00	-5.88	Peak	
3 *	190.0500	52.29	-12.85	39.44	43.50	-4.06	Peak	
4	480.0800	33.03	-9.21	23.82	46.00	-22.18	Peak	
5	691.5400	30.39	-4.20	26.19	46.00	-19.81	Peak	
6	800.1800	31.05	-1.36	29.69	46.00	-16.31	Peak	

Test Mode: UNII-2C/TX A Mode 5580MHz_Adapter: RD1201500-C55-24MG

Horizontal

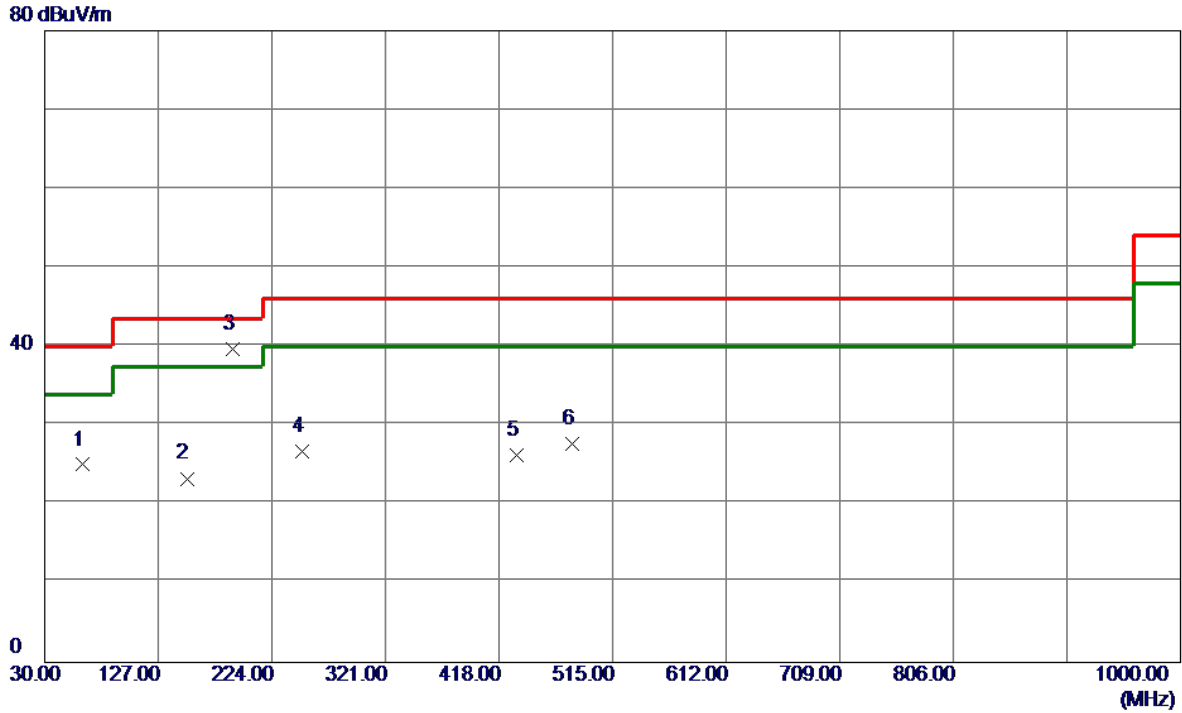

No.	Freq. MHz	Reading Level dBuV/m	Correct Factor dB	Measure ment dBuV/m	Limit dBuV/m	Margin dB	Detector	Comment
1	62.0100	39.69	-14.65	25.04	40.00	-14.96	Peak	
2	151.2500	36.73	-13.45	23.28	43.50	-20.22	Peak	
3 *	191.0200	52.66	-12.94	39.72	43.50	-3.78	QP	
4	250.1900	41.69	-14.90	26.79	46.00	-19.21	Peak	
5	433.5200	36.72	-10.41	26.31	46.00	-19.69	Peak	
6	480.0800	36.96	-9.21	27.75	46.00	-18.25	Peak	

Test Mode: UNII-2C/TX A Mode 5700MHz_Adapter: RD1201500-C55-24MG

Vertical

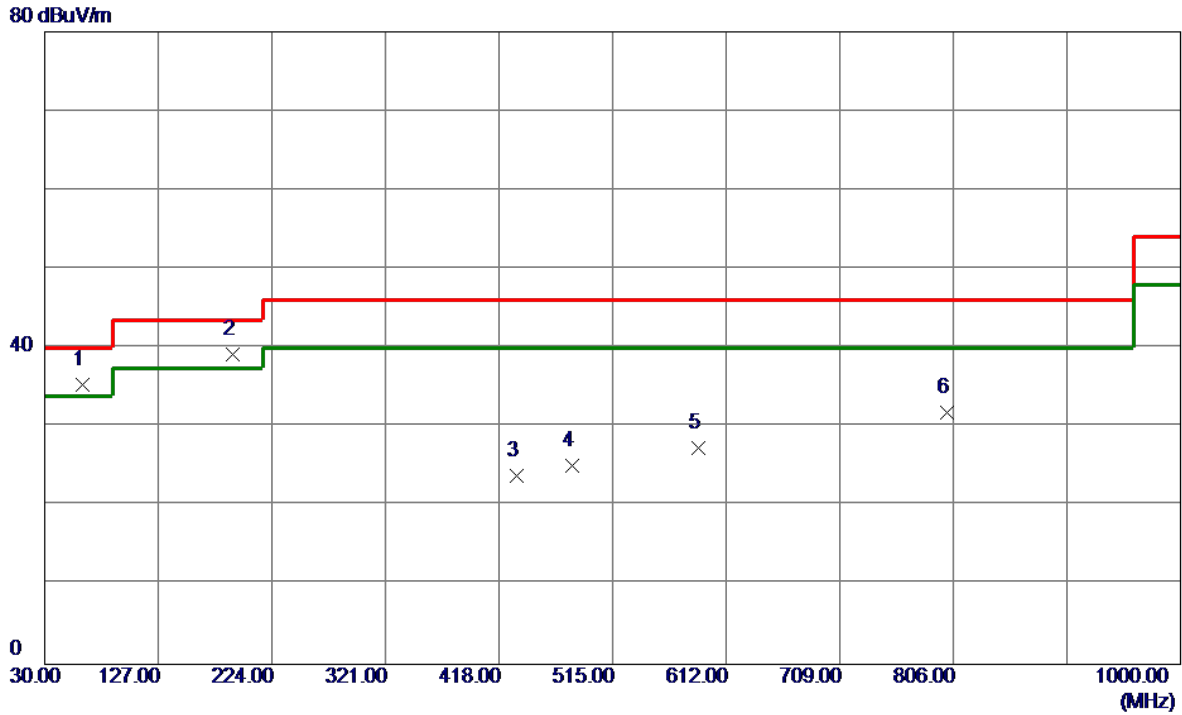

No.	Freq. MHz	Reading Level dBuV/m	Correct Factor dB	Measure ment dBuV/m	Limit dBuV/m	Margin dB	Detector	Comment
1	62.0100	49.94	-14.65	35.29	40.00	-4.71	Peak	
2 *	191.0200	52.10	-12.94	39.16	43.50	-4.34	Peak	
3	433.5200	34.21	-10.41	23.80	46.00	-22.20	Peak	
4	480.0800	34.29	-9.21	25.08	46.00	-20.92	Peak	
5	588.7199	34.05	-6.71	27.34	46.00	-18.66	Peak	
6	800.1800	33.25	-1.36	31.89	46.00	-14.11	Peak	

Test Mode: UNII-2C/TX A Mode 5700MHz_Adapter: RD1201500-C55-24MG

Horizontal

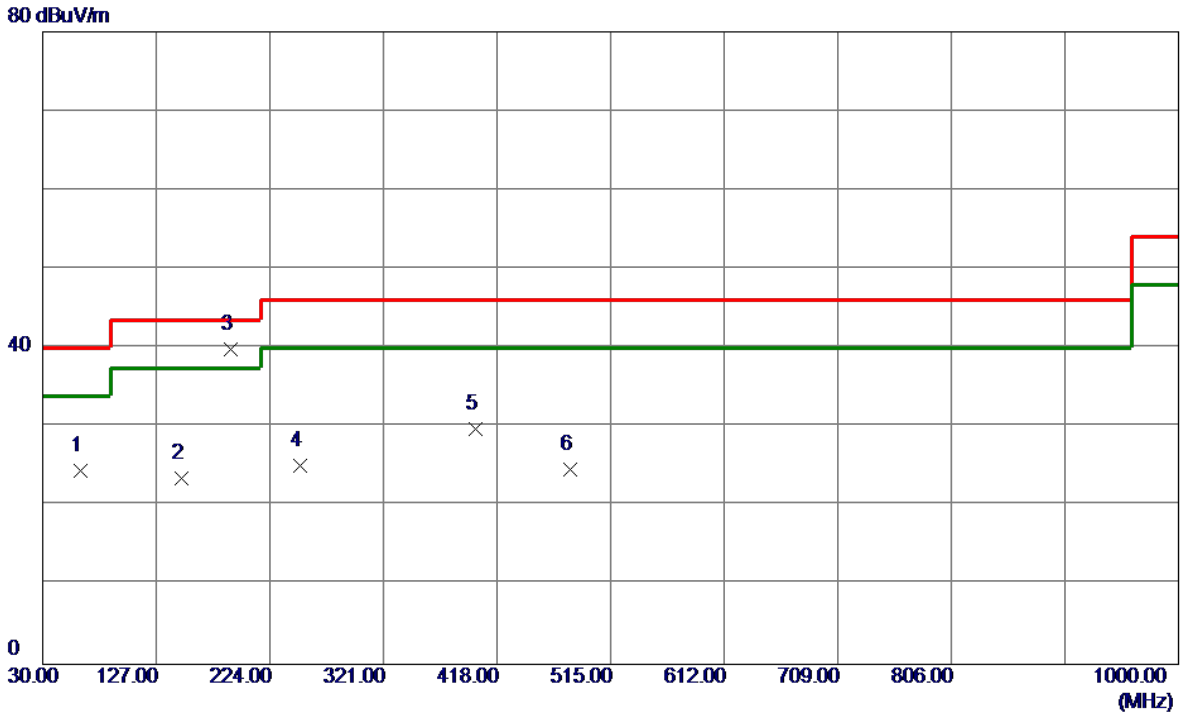

No.	Freq. MHz	Reading Level dBuV/m	Correct Factor dB	Measure ment dBuV/m	Limit dBuV/m	Margin dB	Detector	Comment
1	62.0100	39.12	-14.65	24.47	40.00	-15.53	Peak	
2	148.3400	37.09	-13.64	23.45	43.50	-20.05	Peak	
3 *	191.0200	52.86	-12.94	39.92	43.50	-3.58	QP	
4	250.1900	40.09	-14.90	25.19	46.00	-20.81	Peak	
5	399.5700	41.12	-11.37	29.75	46.00	-16.25	Peak	
6	480.0800	33.80	-9.21	24.59	46.00	-21.41	Peak	

Test Mode: UNII-2A/TX A Mode 5260MHz_Adapter: RD1202000-C55-29MG

Vertical

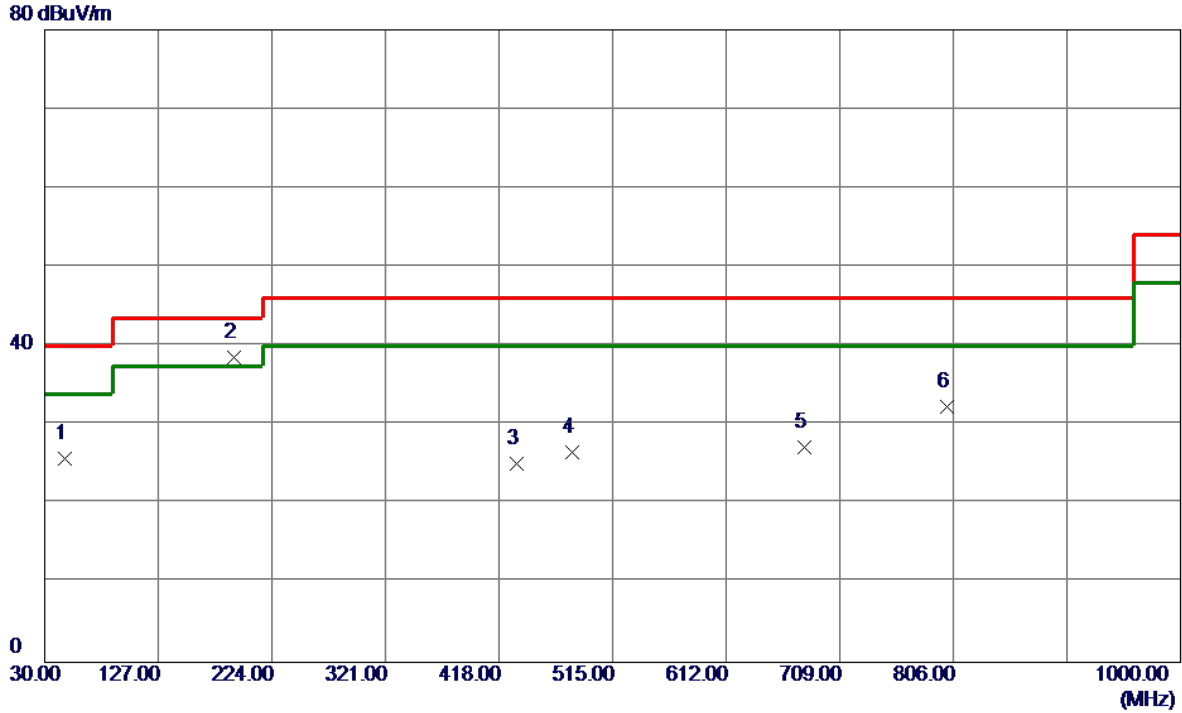

No.	Freq. MHz	Reading Level dBuV/m	Correct Factor dB	Measure ment dBuV/m	Limit dBuV/m	Margin dB	Detector	Comment
1	47.4600	38.87	-13.12	25.75	40.00	-14.25	Peak	
2 *	191.9900	51.65	-13.03	38.62	43.50	-4.88	Peak	
3	433.5200	35.51	-10.41	25.10	46.00	-20.90	Peak	
4	480.0800	35.77	-9.21	26.56	46.00	-19.44	Peak	
5	678.9300	31.85	-4.59	27.26	46.00	-18.74	Peak	
6	800.1800	33.65	-1.36	32.29	46.00	-13.71	Peak	

Test Mode: UNII-2A/TX A Mode 5260MHz_Adapter: RD1202000-C55-29MG

Horizontal

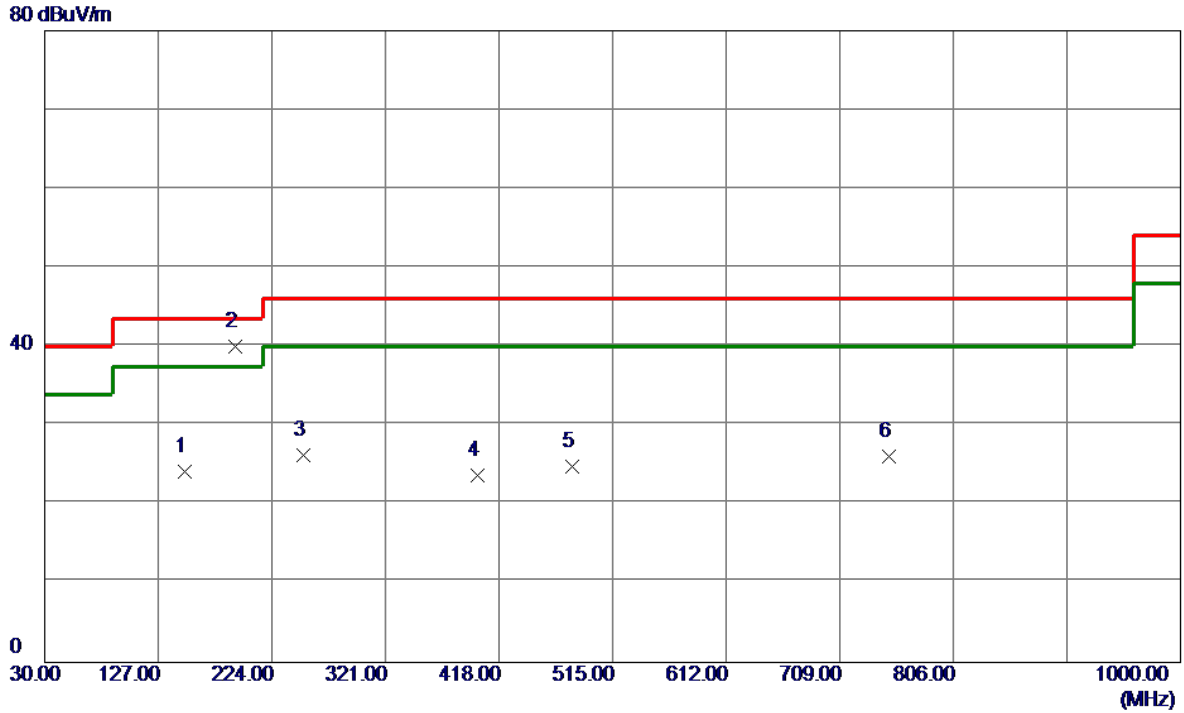

No.	Freq. MHz	Reading Level dBuV/m	Correct Factor dB	Measure ment dBuV/m	Limit dBuV/m	Margin dB	Detector	Comment
1	149.3100	37.74	-13.57	24.17	43.50	-19.33	Peak	
2 *	192.9600	53.18	-13.11	40.07	43.50	-3.43	QP	
3	251.1600	41.26	-14.98	26.28	46.00	-19.72	Peak	
4	399.5700	35.08	-11.37	23.71	46.00	-22.29	Peak	
5	480.0800	34.07	-9.21	24.86	46.00	-21.14	Peak	
6	750.7100	28.52	-2.43	26.09	46.00	-19.91	Peak	

Test Mode: UNII-2A/TX A Mode 5300MHz_Adapter: RD1202000-C55-29MG

Vertical

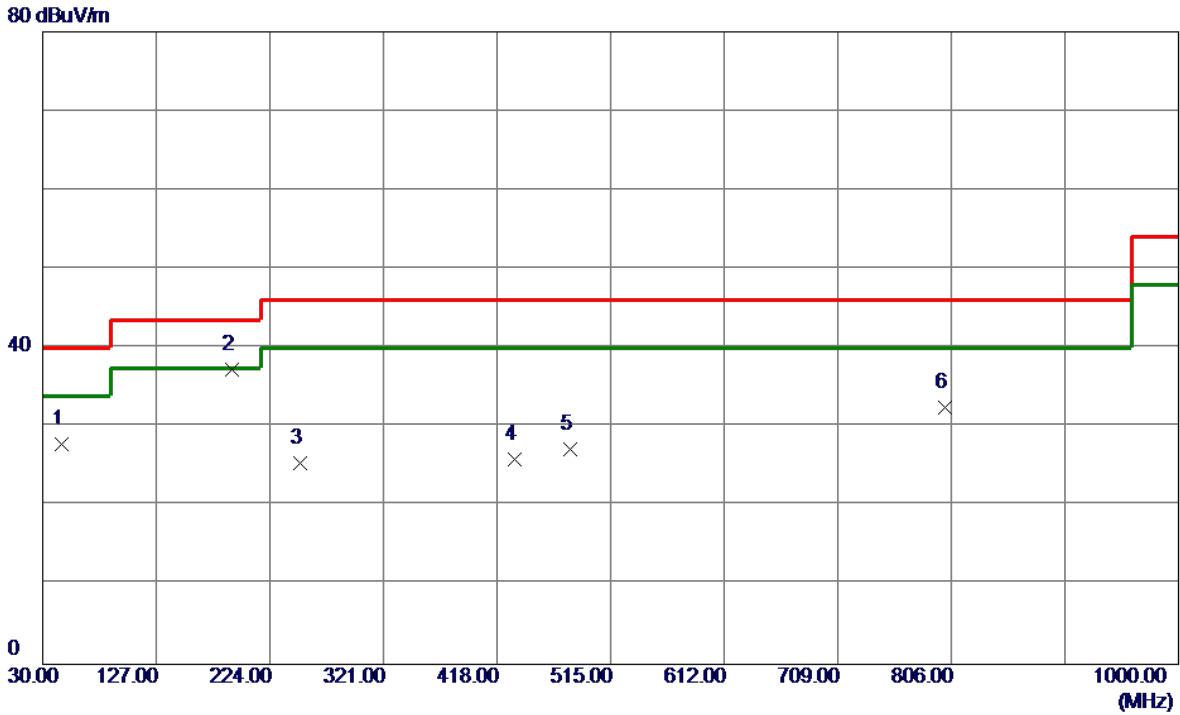

No.	Freq. MHz	Reading Level dBuV/m	Correct Factor dB	Measure ment dBuV/m	Limit dBuV/m	Margin dB	Detector	Comment
1	46.4900	40.82	-12.98	27.84	40.00	-12.16	Peak	
2 *	191.9900	50.26	-13.03	37.23	43.50	-6.27	Peak	
3	250.1900	40.36	-14.90	25.46	46.00	-20.54	Peak	
4	433.5200	36.28	-10.41	25.87	46.00	-20.13	Peak	
5	480.0800	36.34	-9.21	27.13	46.00	-18.87	Peak	
6	800.1800	33.90	-1.36	32.54	46.00	-13.46	Peak	

Test Mode: UNII-2A/TX A Mode 5300MHz_Adapter: RD1202000-C55-29MG

Horizontal

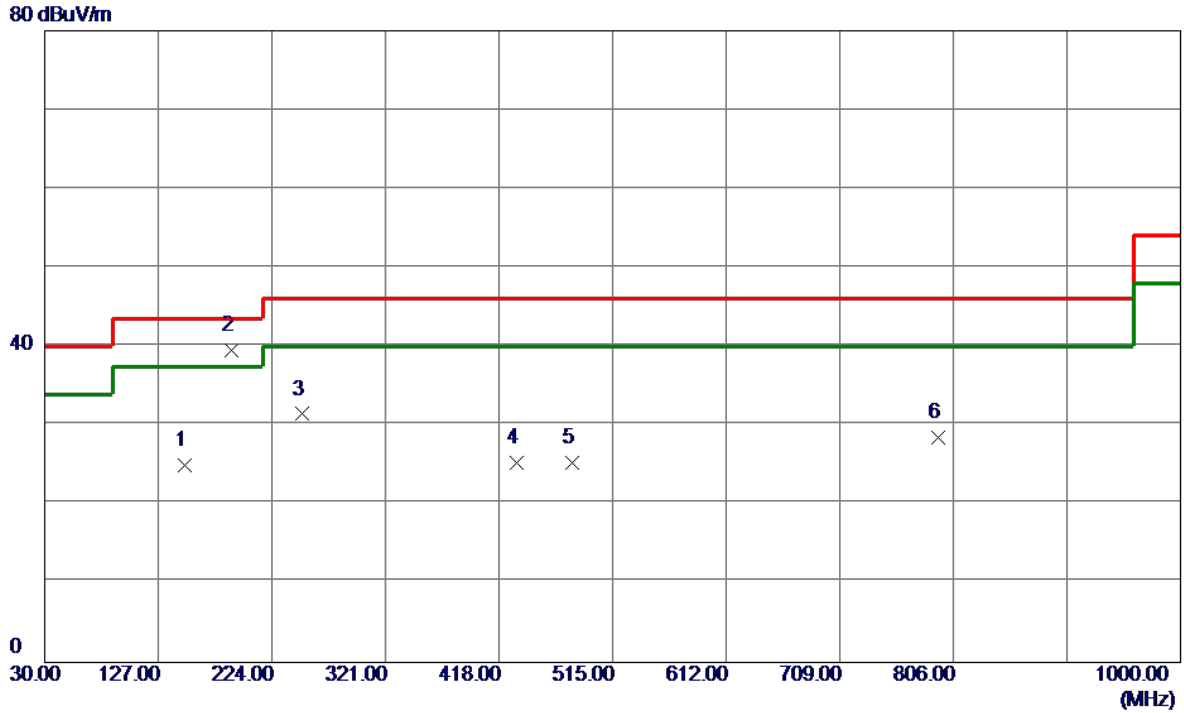

No.	Freq. MHz	Reading Level dBuV/m	Correct Factor dB	Measure ment dBuV/m	Limit dBuV/m	Margin dB	Detector	Comment
1	149.3100	38.57	-13.57	25.00	43.50	-18.50	Peak	
2 *	189.0800	52.30	-12.77	39.53	43.50	-3.97	QP	
3	250.1900	46.34	-14.90	31.44	46.00	-14.56	Peak	
4	433.5200	35.71	-10.41	25.30	46.00	-20.70	Peak	
5	480.0800	34.51	-9.21	25.30	46.00	-20.70	Peak	
6	793.3900	29.95	-1.50	28.45	46.00	-17.55	Peak	

Test Mode: UNII-2A/TX A Mode 5320MHz_Adapter: RD1202000-C55-29MG

Vertical

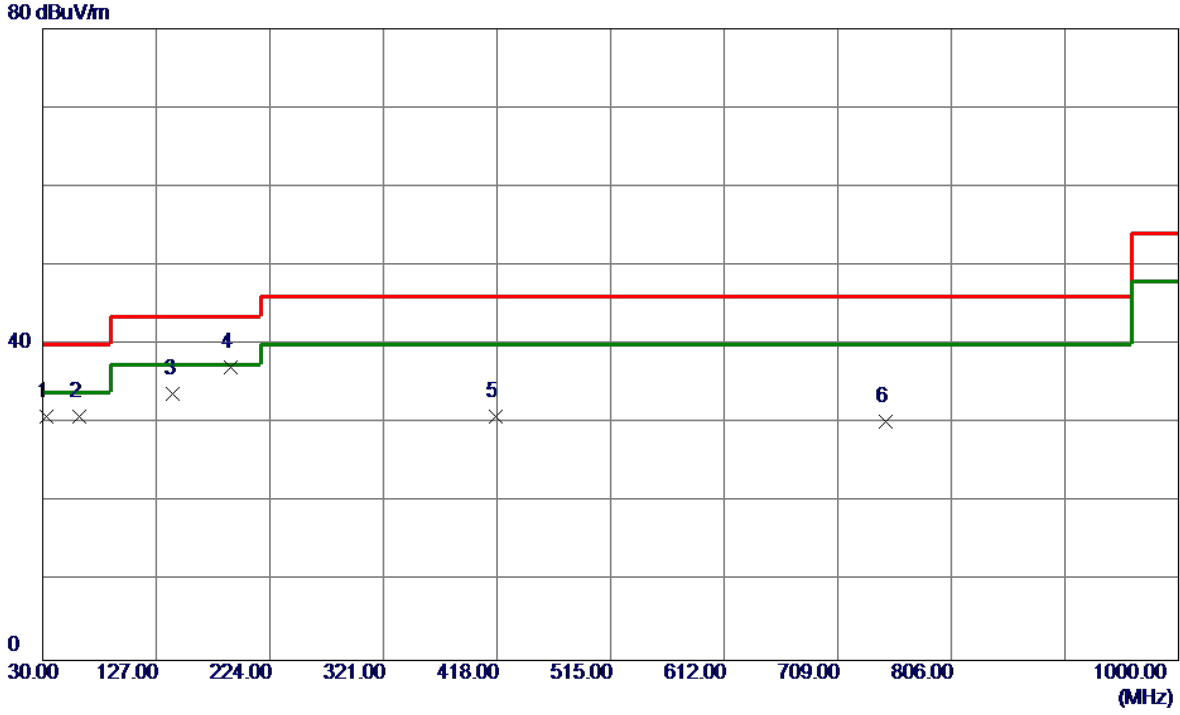

No.	Freq. MHz	Reading Level dBuV/m	Correct Factor dB	Measure ment dBuV/m	Limit dBuV/m	Margin dB	Detector	Comment
1	32.9100	45.77	-14.89	30.88	40.00	-9.12	Peak	
2	61.0400	45.31	-14.48	30.83	40.00	-9.17	Peak	
3	141.5500	47.82	-14.11	33.71	43.50	-9.79	Peak	
4 *	191.0200	50.03	-12.94	37.09	43.50	-6.41	Peak	
5	417.0300	41.73	-10.88	30.85	46.00	-15.15	Peak	
6	749.7400	32.73	-2.45	30.28	46.00	-15.72	Peak	

Test Mode: UNII-2A/TX A Mode 5320MHz_Adapter: RD1202000-C55-29MG

Horizontal

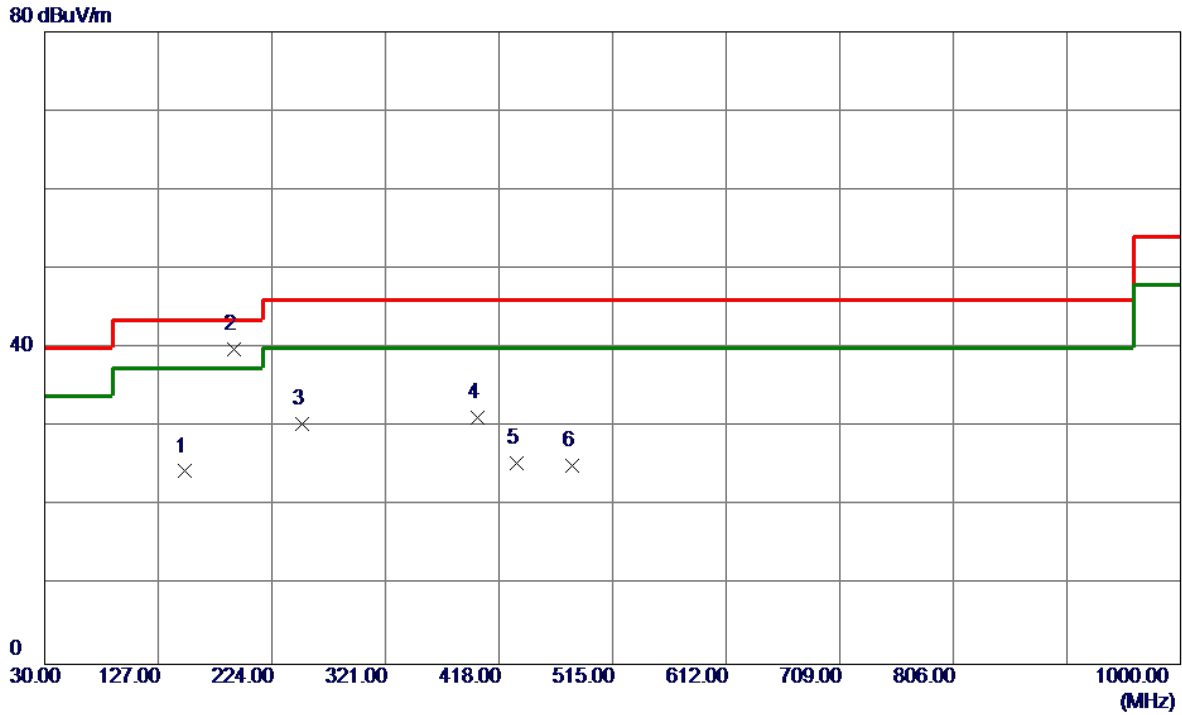

No.	Freq. MHz	Reading Level dBuV/m	Correct Factor dB	Measure ment dBuV/m	Limit dBuV/m	Margin dB	Detector	Comment
1	149.3100	37.97	-13.57	24.40	43.50	-19.10	Peak	
2 *	191.9900	52.80	-13.03	39.77	43.50	-3.73	QP	
3	250.1900	45.25	-14.90	30.35	46.00	-15.65	Peak	
4	399.5700	42.51	-11.37	31.14	46.00	-14.86	Peak	
5	433.5200	35.89	-10.41	25.48	46.00	-20.52	Peak	
6	480.0800	34.33	-9.21	25.12	46.00	-20.88	Peak	

Test Mode: UNII-2C/TX A Mode 5500MHz_Adapter: RD1202000-C55-29MG

Vertical

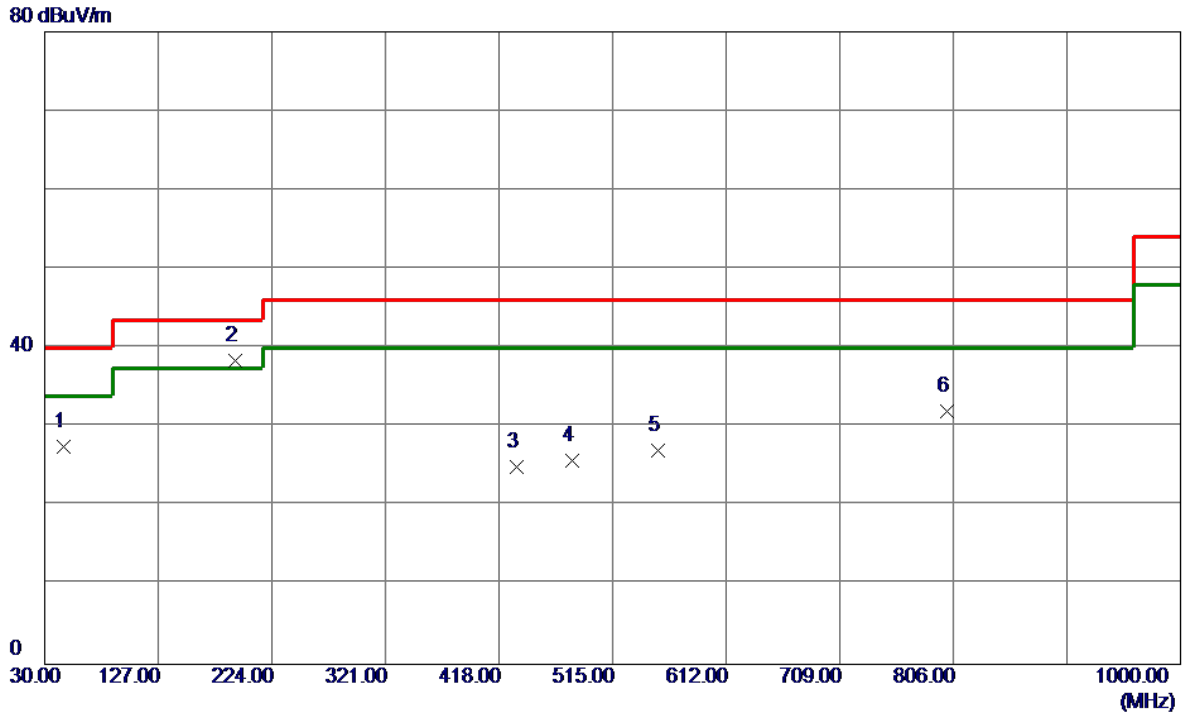

No.	Freq. MHz	Reading Level dBuV/m	Correct Factor dB	Measure ment dBuV/m	Limit dBuV/m	Margin dB	Detector	Comment
1	46.4900	40.51	-12.98	27.53	40.00	-12.47	Peak	
2 *	192.9600	51.53	-13.11	38.42	43.50	-5.08	Peak	
3	433.5200	35.39	-10.41	24.98	46.00	-21.02	Peak	
4	480.0800	34.94	-9.21	25.73	46.00	-20.27	Peak	
5	553.8000	34.64	-7.62	27.02	46.00	-18.98	Peak	
6	800.1800	33.36	-1.36	32.00	46.00	-14.00	Peak	

Test Mode: UNII-2C/TX A Mode 5500MHz_Adapter: RD1202000-C55-29MG

Horizontal

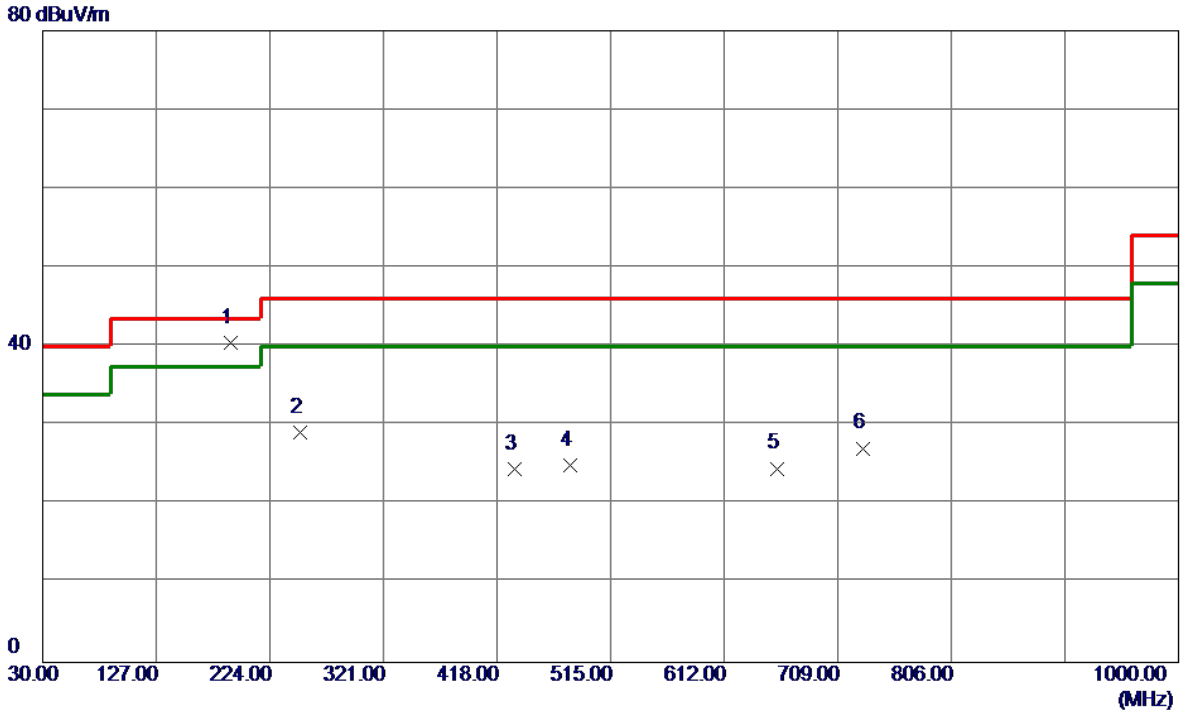

No.	Freq. MHz	Reading Level dBuV/m	Correct Factor dB	Measure ment dBuV/m	Limit dBuV/m	Margin dB	Detector	Comment
1 *	190.0500	53.28	-12.85	40.43	43.50	-3.07	QP	
2	250.1900	44.05	-14.90	29.15	46.00	-16.85	Peak	
3	433.5200	34.82	-10.41	24.41	46.00	-21.59	Peak	
4	480.0800	34.20	-9.21	24.99	46.00	-21.01	Peak	
5	657.5900	29.80	-5.24	24.56	46.00	-21.44	Peak	
6	730.3400	30.15	-3.03	27.12	46.00	-18.88	Peak	

Test Mode: UNII-2C/TX A Mode 5580MHz_Adapter: RD1202000-C55-29MG

Vertical

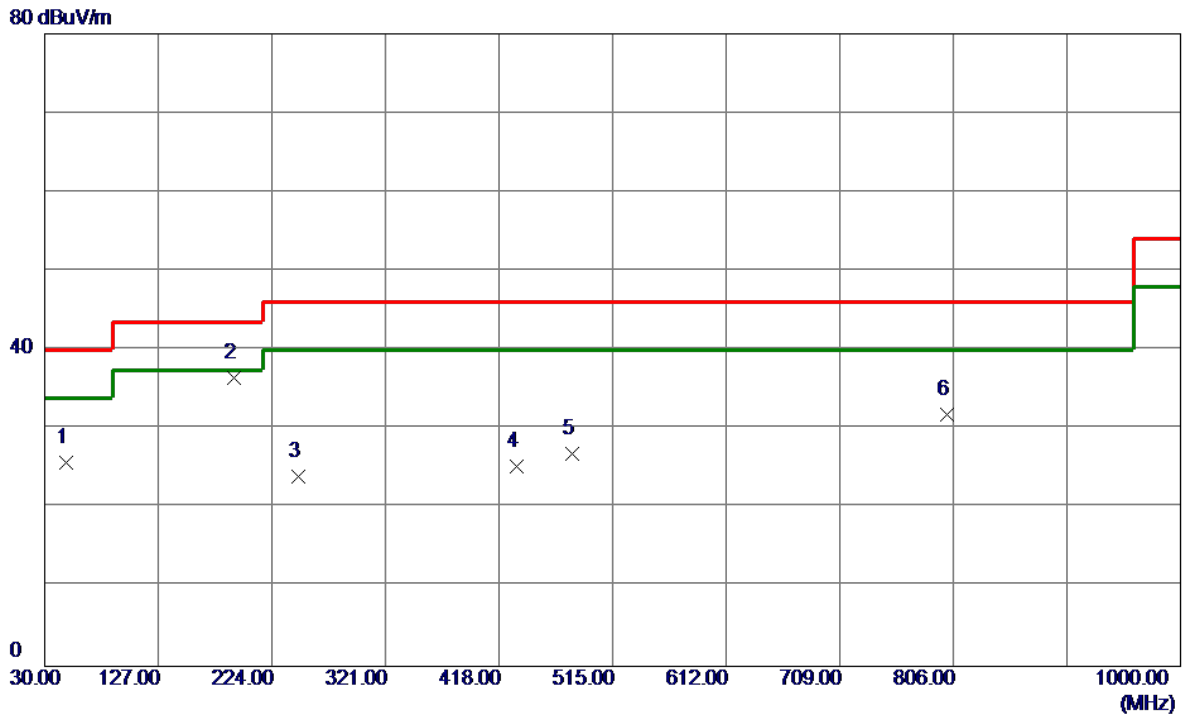

No.	Freq. MHz	Reading Level dBuV/m	Correct Factor dB	Measure ment dBuV/m	Limit dBuV/m	Margin dB	Detector	Comment
1	48.4300	39.03	-13.28	25.75	40.00	-14.25	Peak	
2 *	191.9900	49.50	-13.03	36.47	43.50	-7.03	Peak	
3	246.3100	38.67	-14.69	23.98	46.00	-22.02	Peak	
4	433.5200	35.73	-10.41	25.32	46.00	-20.68	Peak	
5	480.0800	36.11	-9.21	26.90	46.00	-19.10	Peak	
6	800.1800	33.21	-1.36	31.85	46.00	-14.15	Peak	

Test Mode: UNII-2C/TX A Mode 5580MHz_Adapter: RD1202000-C55-29MG

Horizontal

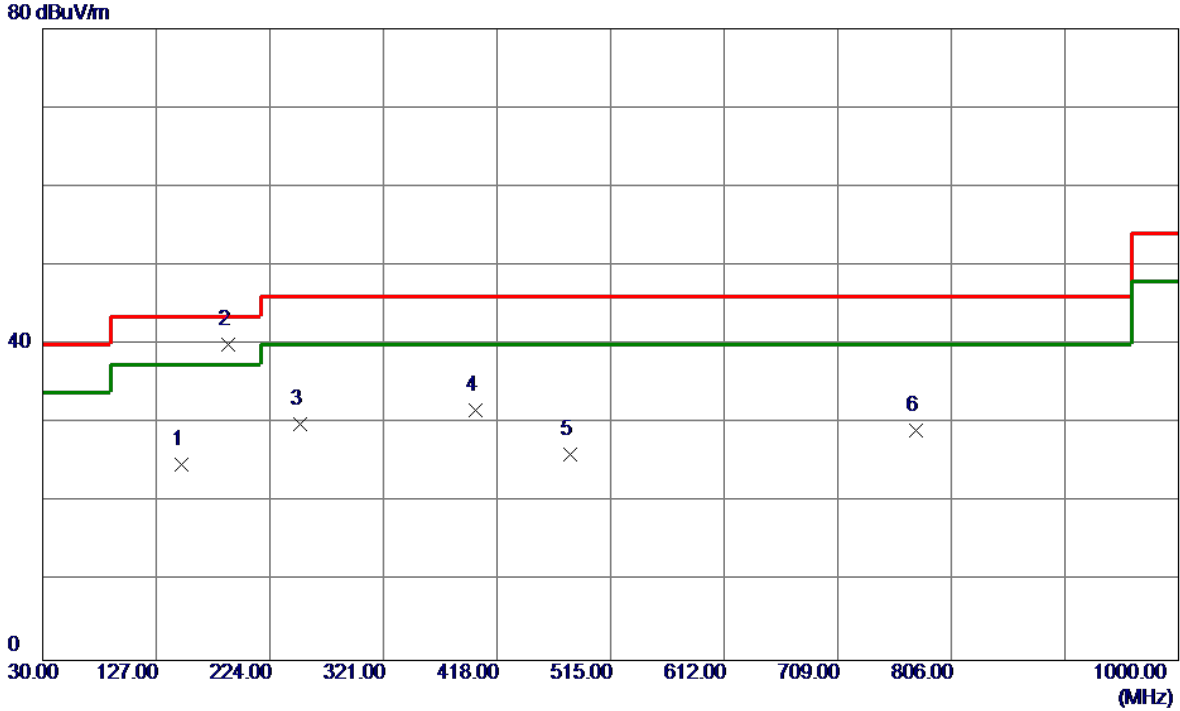

No.	Freq. MHz	Reading Level dBuV/m	Correct Factor dB	Measure ment dBuV/m	Limit dBuV/m	Margin dB	Detector	Comment
1	148.3400	38.45	-13.64	24.81	43.50	-18.69	Peak	
2 *	188.1100	52.72	-12.69	40.03	43.50	-3.47	QP	
3	250.1900	44.88	-14.90	29.98	46.00	-16.02	Peak	
4	399.5700	43.04	-11.37	31.67	46.00	-14.33	Peak	
5	480.0800	35.24	-9.21	26.03	46.00	-19.97	Peak	
6	775.9300	31.02	-1.88	29.14	46.00	-16.86	Peak	

Test Mode: UNII-2C/TX A Mode 5700MHz_Adapter: RD1202000-C55-29MG

Vertical

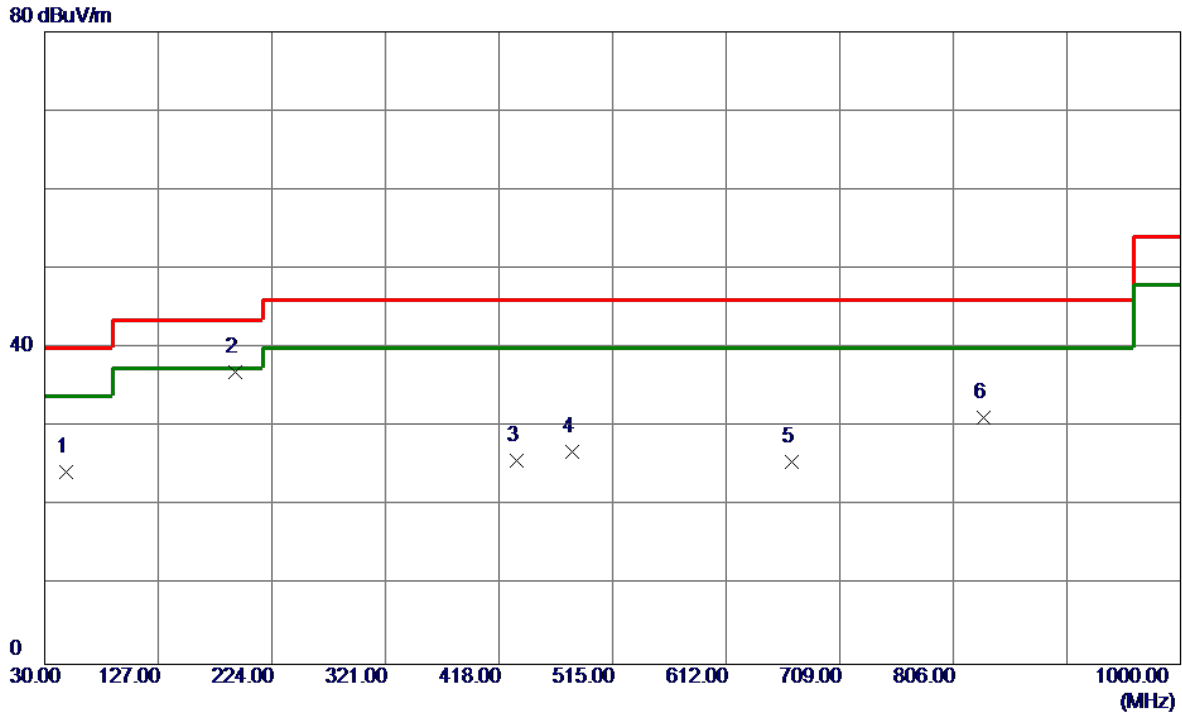

No.	Freq. MHz	Reading Level dBuV/m	Correct Factor dB	Measure ment dBuV/m	Limit dBuV/m	Margin dB	Detector	Comment
1	48.4300	37.53	-13.28	24.25	40.00	-15.75	Peak	
2 *	192.9600	50.11	-13.11	37.00	43.50	-6.50	Peak	
3	433.5200	36.13	-10.41	25.72	46.00	-20.28	Peak	
4	480.0800	36.11	-9.21	26.90	46.00	-19.10	Peak	
5	668.2600	30.45	-4.91	25.54	46.00	-20.46	Peak	
6	832.1900	31.71	-0.48	31.23	46.00	-14.77	Peak	

Test Mode: UNII-2C/TX A Mode 5700MHz_Adapter: RD1202000-C55-29MG

Horizontal

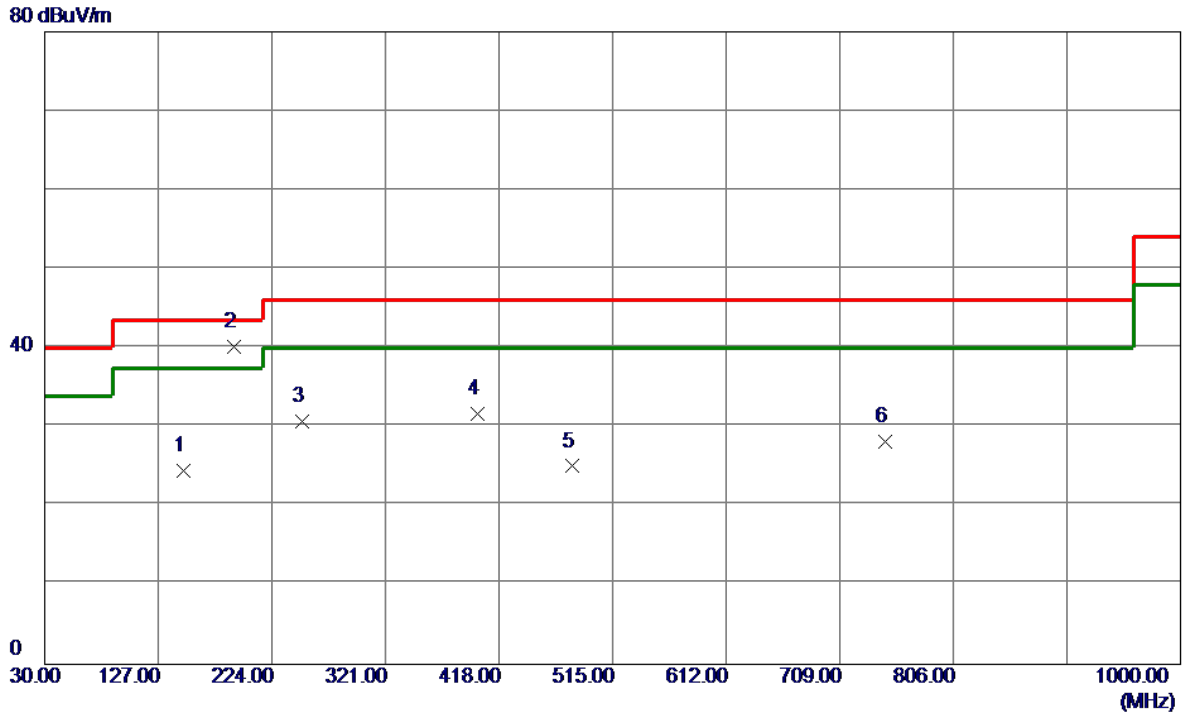

No.	Freq. MHz	Reading Level dBuV/m	Correct Factor dB	Measure ment dBuV/m	Limit dBuV/m	Margin dB	Detector	Comment
1	148.3400	38.05	-13.64	24.41	43.50	-19.09	Peak	
2 *	191.9900	53.12	-13.03	40.09	43.50	-3.41	QP	
3	250.1900	45.68	-14.90	30.78	46.00	-15.22	Peak	
4	399.5700	43.10	-11.37	31.73	46.00	-14.27	Peak	
5	480.0800	34.25	-9.21	25.04	46.00	-20.96	Peak	
6	747.8000	30.63	-2.51	28.12	46.00	-17.88	Peak	