



# FCC TEST REPORT (NFC)

**REPORT NO.:** RF141226C02B-3  
**MODEL NO.:** RS30  
**FCC ID:** Q3N-RS30  
**RECEIVED:** Apr. 24, 2015  
**TESTED:** May 04 ~ May 05, 2015  
**ISSUED:** May 11, 2015

**APPLICANT:** CIPHERLAB CO., LTD

**ADDRESS:** 12F, 333 Dunhua S. Rd., Sec.2 Taipei, Taiwan  
106

**ISSUED BY:** Bureau Veritas Consumer Products Services  
(H.K.) Ltd., Taoyuan Branch

**LAB ADDRESS:** No. 47-2, 14th Ling, Chia Pau Vil., Lin Kou Dist.,  
New Taipei City, Taiwan, R.O.C.

**TEST LOCATION:** No. 19, Hwa Ya 2nd Rd., Wen Hwa Vil., Kwei  
Shan Dist., Taoyuan City 33383, TAIWAN  
(R.O.C.)

This report should not be used by the client to claim product certification, approval, or endorsement by TAF or any government agencies.



This report is for your exclusive use. Any copying or replication of this report to or for any other person or entity, or use of our name or trademark, is permitted only with our prior written permission. This report sets forth our findings solely with respect to the test samples identified herein. The results set forth in this report are not indicative or representative of the quality or characteristics of the lot from which a test sample was taken or any similar or identical product unless specifically and expressly noted. Our report includes all of the tests requested by you and the results thereof based upon the information that you provided to us. You have 60 days from date of issuance of this report to notify us of any material error or omission caused by our negligence, provided, however, that such notice shall be in writing and shall specifically address the issue you wish to raise. A failure to raise such issue within the prescribed time shall constitute your unqualified acceptance of the completeness of this report, the tests conducted and the correctness of the report contents. Unless specific mention, the uncertainty of measurement has been explicitly taken into account to declare the compliance or non-compliance to the specification.



## Table of Contents

RELEASE CONTROL RECORD .....	3
1. CERTIFICATION .....	4
2. SUMMARY OF TEST RESULTS .....	5
2.1 MEASUREMENT UNCERTAINTY .....	5
3. GENERAL INFORMATION .....	6
3.1 GENERAL DESCRIPTION OF EUT .....	6
3.2 DESCRIPTION OF TEST MODES .....	7
3.2.1 TEST MODE APPLICABILITY AND TESTED CHANNEL DETAIL .....	7
3.3 DESCRIPTION OF SUPPORT UNITS .....	8
3.3.1 CONFIGURATION OF SYSTEM UNDER TEST .....	8
3.4 GENERAL DESCRIPTION OF APPLIED STANDARDS .....	8
4. TEST TYPES AND RESULTS .....	9
4.1 RADIATED EMISSION MEASUREMENT .....	9
4.1.1 LIMITS OF RADIATED EMISSION MEASUREMENT .....	9
4.1.2 TEST INSTRUMENTS .....	10
4.1.3 TEST PROCEDURES .....	11
4.1.4 DEVIATION FROM TEST STANDARD .....	11
4.1.5 TEST SETUP .....	12
4.1.6 EUT OPERATING CONDITIONS .....	12
4.1.7 TEST RESULTS .....	13
4.2 CONDUCTED EMISSION MEASUREMENT .....	17
4.2.1 LIMITS OF CONDUCTED EMISSION MEASUREMENT .....	17
4.2.2 TEST INSTRUMENTS .....	17
4.2.3 TEST PROCEDURES .....	18
4.2.4 DEVIATION FROM TEST STANDARD .....	18
4.2.5 TEST SETUP .....	18
4.2.6 EUT OPERATING CONDITIONS .....	18
4.2.7 TEST RESULTS .....	19
5. PHOTOGRAPHS OF THE TEST CONFIGURATION .....	23
6. INFORMATION ON THE TESTING LABORATORIES .....	24
7. APPENDIX A - MODIFICATIONS RECORDERS FOR ENGINEERING CHANGES TO THE EUT BY THE LAB .....	25



## RELEASE CONTROL RECORD

ISSUE NO.	REASON FOR CHANGE	DATE ISSUED
RF141226C02B-3	Original release	May 11, 2015



# 1. CERTIFICATION

**PRODUCT:** Mobile Computer  
**MODEL:** RS30  
**BRAND:** CIPHERLAB  
**APPLICANT:** CIPHERLAB CO., LTD  
**TESTED:** May 04 ~ May 05, 2015  
**TEST SAMPLE:** ENGINEERING SAMPLE  
**STANDARDS:** **FCC Part 15, Subpart C (Section 15.225)**  
**FCC Part 15, Subpart C (Section 15.215)**  
ANSI C63.10-2009

This report is issued as a supplementary report of **RF141226C02-3**. This report shall be used combined together with its original report.

**PREPARED BY :** Celine Chou , **DATE :** May 11, 2015  
Celine Chou / Specialist

**APPROVED BY :** Ken Liu , **DATE :** May 11, 2015  
Ken Liu / Senior Manager

**NOTE:** The radiated emission and conducted emission test were performed for the modification. Refer to original report for the other test data.

## 2. SUMMARY OF TEST RESULTS

The EUT has been tested according to the following specifications:

APPLIED STANDARD: FCC PART 15, SUBPART C (SECTION 15.225, 15.215)			
STANDARD SECTION	TEST TYPE AND LIMIT	RESULT	REMARK
15.207	Conducted emission test	PASS	Meet the requirement of limit. Minimum passing margin is -14.49dB at 13.56026MHz.
15.225 (a)	The field strength of any emissions within the band 13.553-13.567 MHz	PASS	Meet the requirement of limit. Minimum passing margin is -66.20dB at 13.56MHz.
15.225 (d)	The field strength of any emissions appearing outside of the 13.110-14.010 MHz band	PASS	Meet the requirement of limit. Minimum passing margin is -6.8dB at 37.66MHz.
15.225 (e)	The frequency tolerance	PASS	Refer to NOTE below
15.215 (c)	20dB Bandwidth	PASS	Refer to NOTE below

**NOTE:** The radiated emission and conducted emission test were performed for the modification. Refer to original report for the other test data.

### 2.1 MEASUREMENT UNCERTAINTY

Where relevant, the following measurement uncertainty levels have been estimated for tests performed on the EUT as specified in CISPR 16-4-2:

MEASUREMENT	FREQUENCY	UNCERTAINTY
Conducted emissions	150kHz~30MHz	2.44 dB
Radiated emissions	30MHz ~ 200MHz	3.59 dB
	200MHz ~1000MHz	3.60 dB

This uncertainty represents an expanded uncertainty expressed at approximately the 95% confidence level using a coverage factor of k=2.

### 3. GENERAL INFORMATION

#### 3.1 GENERAL DESCRIPTION OF EUT

<b>EUT</b>	Mobile Computer
<b>MODEL NO.</b>	RS30
<b>POWER SUPPLY</b>	3.7Vdc (Battery) 5Vdc (Adapter)
<b>MODULATION TYPE</b>	ASK
<b>OPERATING FREQUENCY</b>	13.56MHz
<b>ANTENNA TYPE</b>	Loop antenna
<b>DATA CABLE</b>	1.0m shielded USB cable without core 1.6m non-shielded snapon cable with one core
<b>I/O PORTS</b>	Refer to users' manual
<b>ACCESSORY DEVICES</b>	Adapter, Battery

**NOTE:**

1. This report is prepared for FCC class II permissive change.
2. This report is issued as a supplementary report to BV ADT report no. RF141226C02-3. The differences compared with original report are changing EUT's appearance, battery and NFC's antenna position. The radiated emission and conducted emission test were performed for the modification. Refer to original report for the other test data. This report shall be combined together with its original report.
3. The EUT consumes power from the following adapter and battery. (Changed part is marked in boldface.)

<b>ADAPTER</b>	
<b>BRAND</b>	Sunny COMPUTER TECHNOLOGY CO., LTD.
<b>MODEL</b>	SYS1460-1005
<b>INPUT POWER</b>	100-240Vac, 50-60Hz, 1.0A
<b>OUTPUT POWER</b>	<b>5Vdc, 2A</b>

<b>BATTERY</b>	
<b>BRAND</b>	CIPHERLAB
<b>MODEL</b>	<b>BA-0092A5</b>
<b>POWER RATING</b>	<b>3.7Vdc, 2500mAh, 9.25Wh</b>

4. The above EUT information is declared by manufacturer and for more detailed features description, please refer to the manufacturer's specifications or User's Manual.

## 3.2 DESCRIPTION OF TEST MODES

### 3.2.1 TEST MODE APPLICABILITY AND TESTED CHANNEL DETAIL

EUT CONFIGURE MODE	APPLICABLE TO		DESCRIPTION
	RE	PLC	
-	√	√	-

Where **RE<1G**: Radiated Emission below 1GHz **PLC**: Power Line Conducted Emission

**NOTE:** The EUT had been pre-tested on the positioned of each 3 axis. The worst case was found when positioned on **Z-plane**.

#### RADIATED EMISSION TEST:

- Pre-Scan has been conducted to determine the worst-case mode from all possible combinations between available modulations antenna ports (if EUT with antenna diversity architecture).
- Following channel(s) was (were) selected for the final test as listed below.

EUT CONFIGURE MODE	AVAILABLE CHANNEL	TESTED CHANNEL	MODULATION TYPE
-	1	1	ASK

#### POWER LINE CONDUCTED EMISSION TEST:

- Pre-Scan has been conducted to determine the worst-case mode from all possible combinations between available modulations and antenna ports (if EUT with antenna diversity architecture).
- Following channel(s) was (were) selected for the final test as listed below.

EUT CONFIGURE MODE	AVAILABLE CHANNEL	TESTED CHANNEL	MODULATION TYPE
-	1	1	ASK

#### TEST CONDITION:

APPLICABLE TO	ENVIRONMENTAL CONDITIONS	INPUT POWER	TESTED BY
RE	18deg. C, 70%RH	120Vac, 60Hz	Nick Hsu
PLC	18deg. C, 70%RH	120Vac, 60Hz	Nick Hsu

### 3.3 DESCRIPTION OF SUPPORT UNITS

The EUT has been tested as an independent unit.

#### 3.3.1 CONFIGURATION OF SYSTEM UNDER TEST

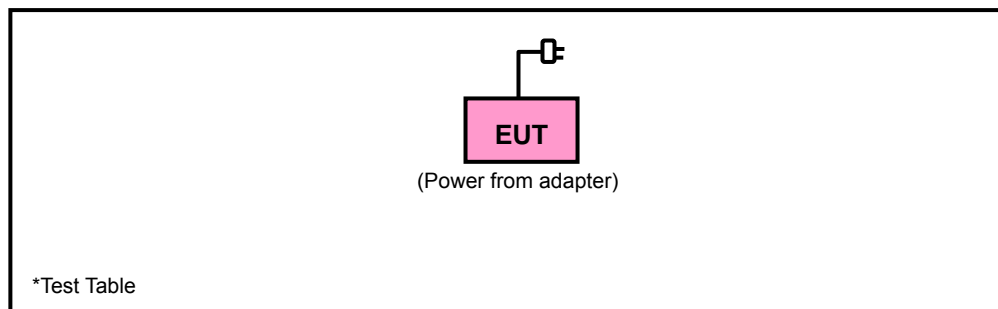

### 3.4 GENERAL DESCRIPTION OF APPLIED STANDARDS

The EUT is a RFID Product. According to the specifications of the manufacturer, it must comply with the requirements of the following standards:

**FCC Part 15, Subpart C (15.225)**

**FCC Part 15, Subpart C (15.215)**

ANSI C63.10-2009

All test items have been performed and recorded as per the above standards.

**NOTE:** The EUT is also considered as a kind of computer peripheral, because the connection to computer is necessary for typical use. It has been verified to comply with the requirements of FCC Part 15, Subpart B, Class B (DoC). The test report has been issued separately.



## 4. TEST TYPES AND RESULTS

### 4.1 RADIATED EMISSION MEASUREMENT

#### 4.1.1 LIMITS OF RADIATED EMISSION MEASUREMENT

The field strength of any emissions within the band 13.553-13.567 MHz shall not exceed 15,848 microvolts/meter at 30 meters.

The field strength of any emissions appearing outside of the 13.110-14.010 MHz band shall not exceed the general radiated emission limits in § 15.209.

FREQUENCIES (MHz)	FIELD STRENGTH (microvolts/meter)	MEASUREMENT DISTANCE (meters)
0.009 ~ 0.490	2400/F(kHz)	300
0.490 ~ 1.705	24000/F(kHz)	30
1.705 ~ 30.0	30	30
30 ~ 88	100	3
88 ~ 216	150	3
216 ~ 960	200	3
Above 960	500	3

**NOTE:**

1. The lower limit shall apply at the transition frequencies.
2. Emission level (dBuV/m) = 20 log Emission level (uV/m).
3. As shown in 15.35(b), for frequencies above 1000MHz, the field strength limits are based on average detector, however, the peak field strength of any emission shall not exceed the maximum permitted average limits, specified above by more than 20dB under any condition of modulation.

#### 4.1.2 TEST INSTRUMENTS

DESCRIPTION & MANUFACTURER	MODEL NO.	SERIAL NO.	DATE OF CALIBRATION	DUE DATE OF CALIBRATION
Test Receiver ROHDE & SCHWARZ	ESCI	100424	Oct. 06, 2014	Oct. 05, 2015
Spectrum Analyzer ROHDE & SCHWARZ	FSP40	100040	Jul. 25, 2014	Jul. 24, 2015
BILOG Antenna SCHWARZBECK	VULB9168	9168-155	Feb. 06, 2015	Feb. 05, 2016
HORN Antenna SCHWARZBECK	BBHA 9120D	9120D-1170	Feb. 05, 2015	Feb. 04, 2016
HORN Antenna SCHWARZBECK	BBHA 9170	BBHA9170241	Feb. 09, 2015	Feb. 08, 2016
Preamplifier Agilent	8449B	3008A01960	Aug. 09, 2014	Aug. 08, 2015
Preamplifier Agilent	8447D	2944A10631	Aug. 09, 2014	Aug. 08, 2015
RF signal cable HUBER+SUHNNER	SUCOFLEX 104	309220/4	Aug. 09, 2014	Aug. 08, 2015
RF signal cable HUBER+SUHNNER	SUCOFLEX 104	250724/4	Aug. 09, 2014	Aug. 08, 2015
RF signal cable HUBER+SUHNNER	SUCOFLEX 104	295012/4	Aug. 09, 2014	Aug. 08, 2015
Software BV ADT	ADT_Radiated_ V7.6.15.9.4	NA	NA	NA
Antenna Tower inn-co GmbH	MA 4000	010303	NA	NA
Antenna Tower Controller BV ADT	AT100	AT93021703	NA	NA
Turn Table BV ADT	TT100.	TT93021703	NA	NA
Turn Table Controller BV ADT	SC100.	SC93021703	NA	NA

- NOTE:**
1. The calibration interval of the above test instruments is 12 months and the calibrations are traceable to NML/ROC and NIST/USA.
  2. The test was performed in HwaYa Chamber 4.
  3. The horn antenna and HP preamplifier (model: 8449B) are used only for the measurement of emission frequency above 1GHz if tested.
  4. The FCC Site Registration No. is 460141.
  5. The IC Site Registration No. is IC7450F-4.

#### 4.1.3 TEST PROCEDURES

- a. The EUT was placed on the top of a rotating table 0.8 meters above the ground at a 3 meter semi-anechoic chamber. The table was rotated 360 degrees to determine the position of the highest radiation.
- b. The EUT was set 3 meters away from the interference-receiving antenna, which was mounted on the top of a variable-height antenna tower.
- c. The antenna is a broadband antenna, and its height is varied from one meter to four meters above the ground to determine the maximum value of the field strength. Both horizontal and vertical polarizations of the antenna are set to make the measurement.
- d. For each suspected emission, the EUT was arranged to its worst case and then the antenna was tuned to heights from 1 meter to 4 meters and the rotatable table was turned from 0 degrees to 360 degrees to find the maximum reading.
- e. The test-receiver system was set to Peak Detect Function and Specified Bandwidth with Maximum Hold Mode.
- f. If the emission level of the EUT in peak mode was lower than the limit specified, then testing could be stopped and the peak values of the EUT would be reported. Otherwise the emissions would be re-tested one by one using peak, quasi-peak or average method as specified and then reported in a data sheet.

**NOTE:**

1. The resolution bandwidth and video bandwidth of test receiver/spectrum analyzer is 120kHz for Quasi-peak detection at frequency below 1GHz.
2. The resolution bandwidth of test receiver/spectrum analyzer is 1 MHz and video bandwidth is 3MHz for Peak detection at frequency above 1GHz.
3. All modes of operation were investigated and the worst-case emissions are reported.

#### 4.1.4 DEVIATION FROM TEST STANDARD

No deviation.

#### 4.1.5 TEST SETUP

##### Frequency range 30MHz~1GHz

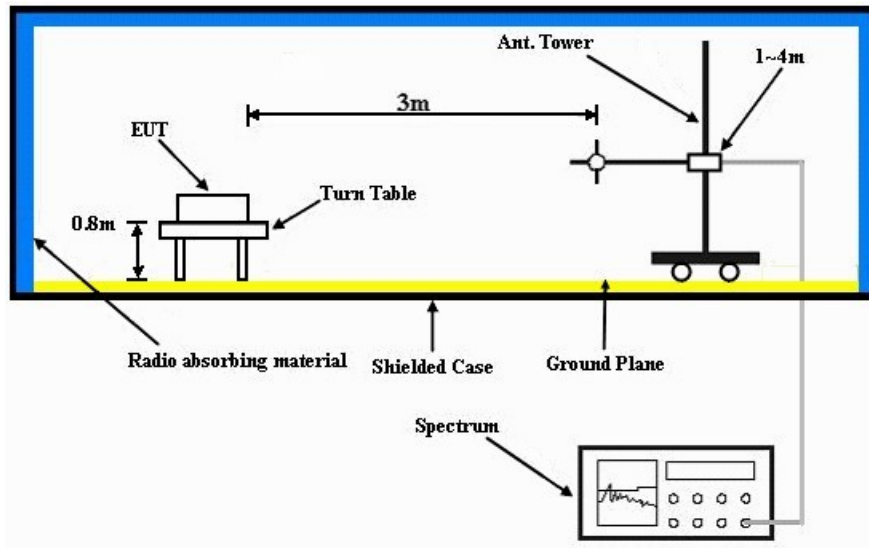

For the actual test configuration, please refer to the attached file (Test Setup Photo).

#### 4.1.6 EUT OPERATING CONDITIONS

Set the EUT under transmission condition continuously at specific channel frequency.

### 4.1.7 TEST RESULTS

EUT TEST CONDITION		MEASUREMENT DETAIL	
CHANNEL	Channel 1	FREQUENCY RANGE	13.553 ~ 13.567MHz
INPUT POWER	120Vac, 60Hz	DETECTOR FUNCTION	Quasi-Peak
ENVIRONMENTAL CONDITIONS	18deg. C, 70%RH	TESTED BY	Nick Hsu

ANTENNA POLARITY & TEST DISTANCE: LOOP ANTENNA OPEN AT 3m								
No.	Freq. (MHz)	Emission Level (dBuV/m)	Limit (dBuV/m)	Margin (dB)	Antenna Height (m)	Table Angle (Degree)	Raw Value (dBuV)	Correction Factor (dB/m)
1	13.56	57.80	124.00	-66.20	1.00	350	37.55	20.25

- REMARKS:**
1. Emission level(dBuV/m)=Raw Value(dBuV) + Correction Factor(dB/m)
  2. Correction Factor(dB/m) = Antenna Factor (dB/m) + Cable Factor (dB)
  3. The other emission levels were very low against the limit.
  4. Margin value = Emission level – Limit value.
  5. Above limits have been translated by the formula

The measured field strength was extrapolated to distance 30 meters, using the formula that the limit of field strength varies as the inverse distance square (40dB per decade of distance)

Example:

$$\begin{aligned}
 13.56\text{MHz} &= 15848\mu\text{V/m} && 30\text{m} \\
 &= 84\text{dBuV/m} && 30\text{m} \\
 &= 84+20\log(30/3)^2 && 3\text{m} \\
 &= 124\text{dBuV/m}
 \end{aligned}$$

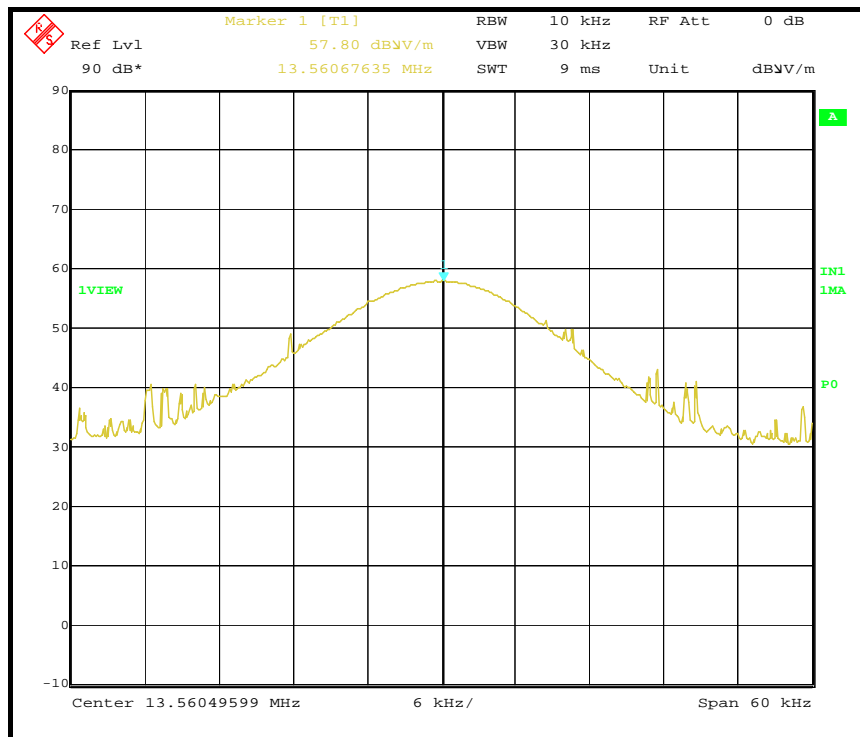

EUT TEST CONDITION		MEASUREMENT DETAIL	
CHANNEL	Channel 1	FREQUENCY RANGE	13.553 ~ 13.567MHz
INPUT POWER	120Vac, 60Hz	DETECTOR FUNCTION	Quasi-Peak
ENVIRONMENTAL CONDITIONS	18deg. C, 70%RH	TESTED BY	Nick Hsu

ANTENNA POLARITY & TEST DISTANCE: LOOP ANTENNA CLOSE AT 3m								
No.	Freq. (MHz)	Emission Level (dBuV/m)	Limit (dBuV/m)	Margin (dB)	Antenna Height (m)	Table Angle (Degree)	Raw Value (dBuV)	Correction Factor (dB/m)
1	13.56	55.80	124.00	-68.20	1.00	247	35.55	20.25

- REMARKS:**
1. Emission level(dBuV/m)=Raw Value(dBuV) + Correction Factor(dB/m)
  2. Correction Factor(dB/m) = Antenna Factor (dB/m) + Cable Factor (dB)
  3. The other emission levels were very low against the limit.
  4. Margin value = Emission level – Limit value.
  5. Above limits have been translated by the formula

The measured field strength was extrapolated to distance 30 meters, using the formula that the limit of field strength varies as the inverse distance square (40dB per decade of distance)

Example:

$$\begin{aligned}
 13.56\text{MHz} &= 15848\mu\text{V/m} && 30\text{m} \\
 &= 84\text{dBuV/m} && 30\text{m} \\
 &= 84+20\log(30/3)^2 && 3\text{m} \\
 &= 124\text{dBuV/m}
 \end{aligned}$$

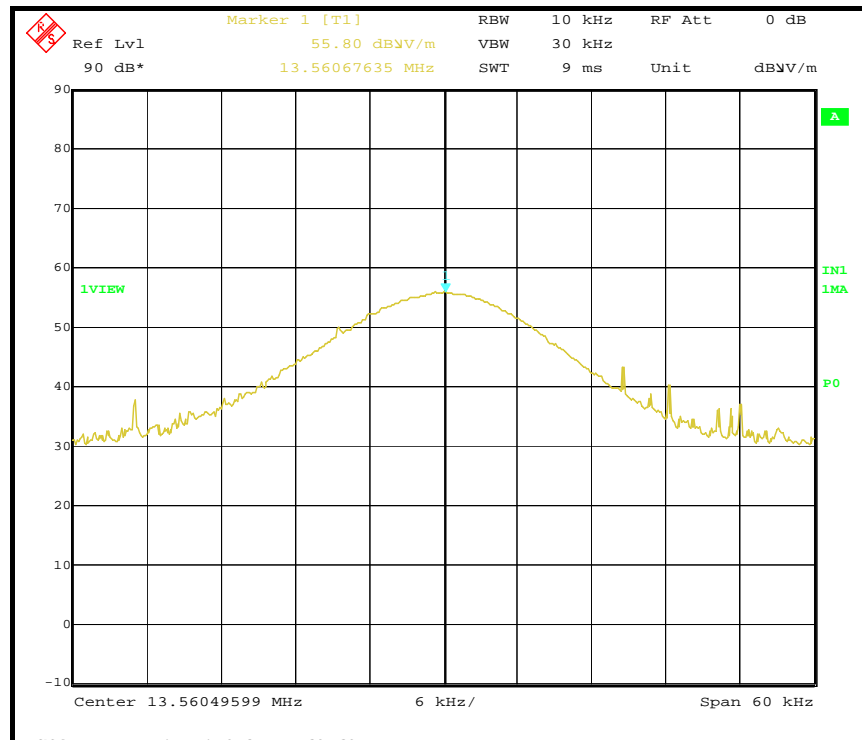

EUT TEST CONDITION		MEASUREMENT DETAIL	
CHANNEL	Channel 1	FREQUENCY RANGE	Below 30MHz
INPUT POWER	120Vac, 60Hz	DETECTOR FUNCTION	Quasi-Peak
ENVIRONMENTAL CONDITIONS	24deg. C, 63%RH	TESTED BY	Alan Wu

ANTENNA POLARITY & TEST DISTANCE: LOOP ANTENNA OPEN AT 3m								
No.	Freq. (MHz)	Emission Level (dBuV/m)	Limit (dBuV/m)	Margin (dB)	Antenna Height (m)	Table Angle (Degree)	Raw Value (dBuV)	Correction Factor (dB/m)
1	27.12	35.04	69.54	-34.50	1.00	94	14.59	20.45
ANTENNA POLARITY & TEST DISTANCE: LOOP ANTENNA CLOSE AT 3m								
No.	Freq. (MHz)	Emission Level (dBuV/m)	Limit (dBuV/m)	Margin (dB)	Antenna Height (m)	Table Angle (Degree)	Raw Value (dBuV)	Correction Factor (dB/m)
1	27.12	34.49	69.54	-35.05	1.00	204	14.04	20.45

- REMARKS:**
1. Emission level(dBuV/m)=Raw Value(dBuV) + Correction Factor(dB/m)
  2. Correction Factor(dB/m) = Antenna Factor (dB/m) + Cable Factor (dB)
  3. The other emission levels were very low against the limit.
  4. Margin value = Emission level – Limit value.

### BELOW 1GHz WORST-CASE DATA

EUT TEST CONDITION		MEASUREMENT DETAIL	
CHANNEL	Channel 1	FREQUENCY RANGE	Below 1000MHz
INPUT POWER	120Vac, 60Hz	DETECTOR FUNCTION	Quasi-Peak
ENVIRONMENTAL CONDITIONS	18deg. C, 70%RH	TESTED BY	Nick Hsu

ANTENNA POLARITY & TEST DISTANCE: HORIZONTAL AT 3 M								
NO.	FREQ. (MHz)	EMISSION LEVEL (dBuV/m)	LIMIT (dBuV/m)	MARGIN (dB)	ANTENNA HEIGHT (m)	TABLE ANGLE (Degree)	RAW VALUE (dBuV)	CORRECTION FACTOR (dB/m)
1	51.24	20.9 QP	40.0	-19.1	1.01 H	126	35.00	-14.10
2	101.69	21.5 QP	43.5	-22.0	2.00 H	9	39.90	-18.40
3	121.10	19.9 QP	43.5	-23.6	1.51 H	12	36.10	-16.20
4	159.91	22.1 QP	43.5	-21.4	2.00 H	285	35.80	-13.70
5	518.88	29.4 QP	46.0	-16.6	2.00 H	320	38.00	-8.60
6	546.05	25.8 QP	46.0	-20.2	1.51 H	174	34.20	-8.40
ANTENNA POLARITY & TEST DISTANCE: VERTICAL AT 3 M								
NO.	FREQ. (MHz)	EMISSION LEVEL (dBuV/m)	LIMIT (dBuV/m)	MARGIN (dB)	ANTENNA HEIGHT (m)	TABLE ANGLE (Degree)	RAW VALUE (dBuV)	CORRECTION FACTOR (dB/m)
1	37.66	33.2 QP	40.0	-6.8	1.00 V	279	48.00	-14.80
2	51.24	29.0 QP	40.0	-11.0	1.00 V	165	43.10	-14.10
3	70.65	28.5 QP	40.0	-11.5	1.00 V	87	44.60	-16.10
4	99.75	23.0 QP	43.5	-20.5	1.00 V	152	41.60	-18.60
5	159.91	20.2 QP	43.5	-23.3	1.50 V	262	33.90	-13.70
6	216.18	22.5 QP	46.0	-23.5	1.50 V	8	39.00	-16.50

#### REMARKS:

1. Emission Level(dBuV/m) = Raw Value(dBuV) + Correction Factor(dB/m)
2. Correction Factor(dB/m) = Antenna Factor(dB/m) + Cable Factor(dB)
3. The other emission levels were very low against the limit.
4. Margin value = Emission Level – Limit value



## 4.2 CONDUCTED EMISSION MEASUREMENT

### 4.2.1 LIMITS OF CONDUCTED EMISSION MEASUREMENT

FREQUENCY OF EMISSION (MHz)	CONDUCTED LIMIT (dB $\mu$ V)	
	Quasi-peak	Average
0.15 ~ 0.5	66 to 56	56 to 46
0.5 ~ 5	56	46
5 ~ 30	60	50

- NOTE:**
1. The lower limit shall apply at the transition frequencies.
  2. The limit decreases in line with the logarithm of the frequency in the range of 0.15 to 0.50 MHz.
  3. All emanations from a class A/B digital device or system, including any network of conductors and apparatus connected thereto, shall not exceed the level of field strengths specified above.

### 4.2.2 TEST INSTRUMENTS

DESCRIPTION & MANUFACTURER	MODEL NO.	SERIAL NO.	DATE OF CALIBRATION	DUE DATE OF CALIBRATION
Test Receiver ROHDE & SCHWARZ	ESCI	100613	Nov. 11, 2014	Nov. 10, 2015
RF signal cable Woken	5D-FB	Cable-HYC01-01	Dec. 26, 2014	Dec. 25, 2015
LISN ROHDE & SCHWARZ (EUT)	ESH3-Z5	835239/001	Mar. 02, 2015	Mar. 01, 2016
LISN ROHDE & SCHWARZ (Peripheral)	ESH3-Z5	100311	Jul. 21, 2014	Jul. 20, 2015
Software ADT	BV ADT_Cond_ V7.3.7.3	NA	NA	NA

- NOTE:**
1. The calibration interval of the above test instruments is 12 months and the calibrations are traceable to NML/ROC and NIST/USA.
  2. The test was performed in HwaYa Shielded Room 1.
  3. The VCCI Site Registration No. is C-2040.

### 4.2.3 TEST PROCEDURES

- The EUT was placed 0.4 meters from the conducting wall of the shielded room with EUT being connected to the power mains through a line impedance stabilization network (LISN). Other support units were connected to the power mains through another LISN. The two LISNs provide 50 ohm/ 50uH of coupling impedance for the measuring instrument.
- Both lines of the power mains connected to the EUT were checked for maximum conducted interference.
- The frequency range from 150kHz to 30MHz was searched. Emission levels under (Limit - 20dB) was not recorded.

**NOTE:** All modes of operation were investigated and the worst-case emissions are reported.

### 4.2.4 DEVIATION FROM TEST STANDARD

No deviation.

### 4.2.5 TEST SETUP

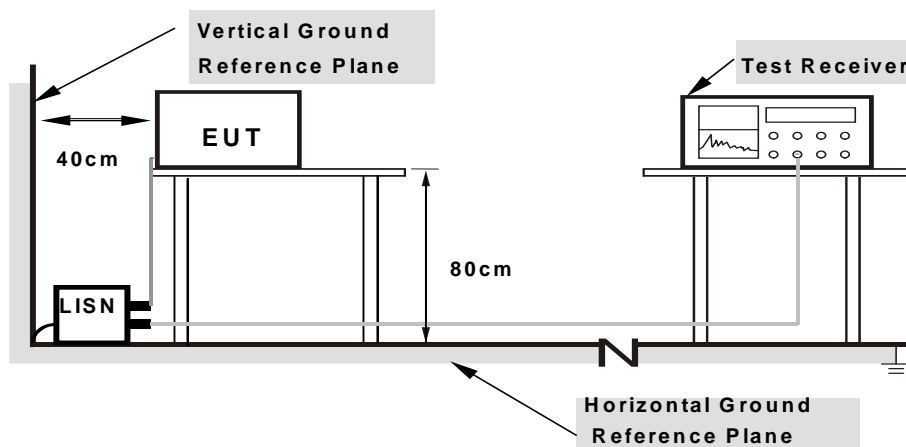

- Note:**
- Support units were connected to second LISN.
  - Both of LISNs (AMN) are 80 cm from EUT and at least 80 cm from other units and other metal planes

For the actual test configuration, please refer to the attached file (Test Setup Photo).

### 4.2.6 EUT OPERATING CONDITIONS

Same as 4.1.6.

#### 4.2.7 TEST RESULTS

PHASE	Line 1	6dB BANDWIDTH	9kHz
-------	--------	---------------	------

No	Freq. [MHz]	Corr. Factor (dB)	Reading Value		Emission Level		Limit		Margin	
			[dB (uV)]		[dB (uV)]		[dB (uV)]		(dB)	
			Q.P.	AV.	Q.P.	AV.	Q.P.	AV.	Q.P.	AV.
1	0.16173	0.09	34.76	21.93	34.85	22.02	65.37	55.37	-30.53	-33.36
2	0.37700	0.09	31.67	14.53	31.76	14.62	58.35	48.35	-26.59	-33.73
3	1.54978	0.20	28.09	12.29	28.29	12.49	56.00	46.00	-27.71	-33.51
4	2.89482	0.23	34.34	18.96	34.57	19.19	56.00	46.00	-21.43	-26.81
5	4.57612	0.27	33.72	18.20	33.99	18.47	56.00	46.00	-22.01	-27.53
6	13.56026	0.65	40.73	34.86	41.38	35.51	60.00	50.00	-18.62	-14.49

#### REMARKS:

1. Q.P. and AV. are abbreviations of quasi-peak and average individually.
2. The emission levels of other frequencies were very low against the limit.
3. Margin value = Emission level - Limit value
4. Correction factor = Insertion loss + Cable loss
5. Emission Level = Correction Factor + Reading Value
6. This is NFC signal inductive with measurement system. Please check P21-22 to see test result for EUT with a suitable dummy load.

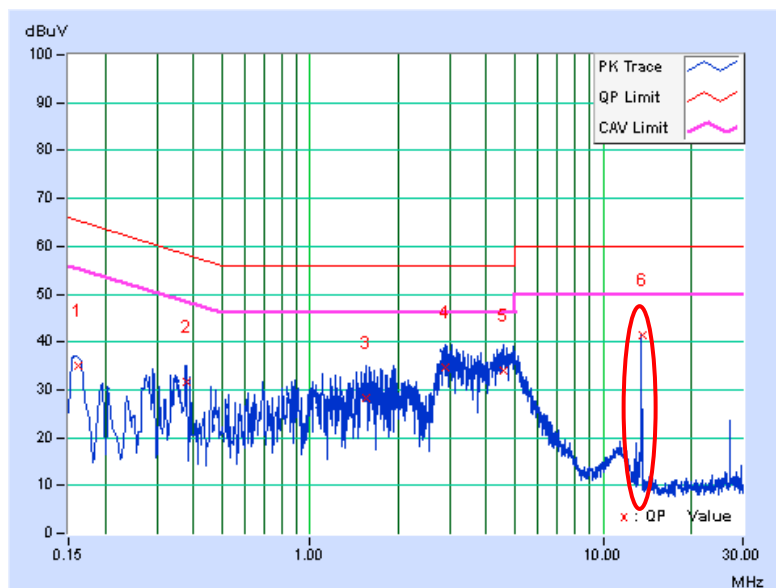

PHASE	Line 2	6dB BANDWIDTH	9kHz
-------	--------	---------------	------

No	Freq. [MHz]	Corr. Factor (dB)	Reading Value		Emission Level		Limit		Margin	
			[dB (uV)]		[dB (uV)]		[dB (uV)]		(dB)	
			Q.P.	AV.	Q.P.	AV.	Q.P.	AV.	Q.P.	AV.
1	0.37287	0.18	36.85	24.98	37.03	25.16	58.44	48.44	-21.41	-23.28
2	0.68176	0.17	29.26	15.61	29.43	15.78	56.00	46.00	-26.57	-30.22
3	1.28781	0.19	31.00	16.98	31.19	17.17	56.00	46.00	-24.81	-28.83
4	2.85968	0.29	33.97	22.23	34.26	22.52	56.00	46.00	-21.74	-23.48
5	4.53702	0.40	31.78	18.88	32.18	19.28	56.00	46.00	-23.82	-26.72
6	13.56000	0.65	20.19	18.74	20.84	19.39	60.00	50.00	-39.16	-30.61

**REMARKS:**

1. Q.P. and AV. are abbreviations of quasi-peak and average individually.
2. The emission levels of other frequencies were very low against the limit.
3. Margin value = Emission level - Limit value
4. Correction factor = Insertion loss + Cable loss
5. Emission Level = Correction Factor + Reading Value
6. This is NFC signal inductive with measurement system. Please check P21-22 to see test result for EUT with a suitable dummy load.

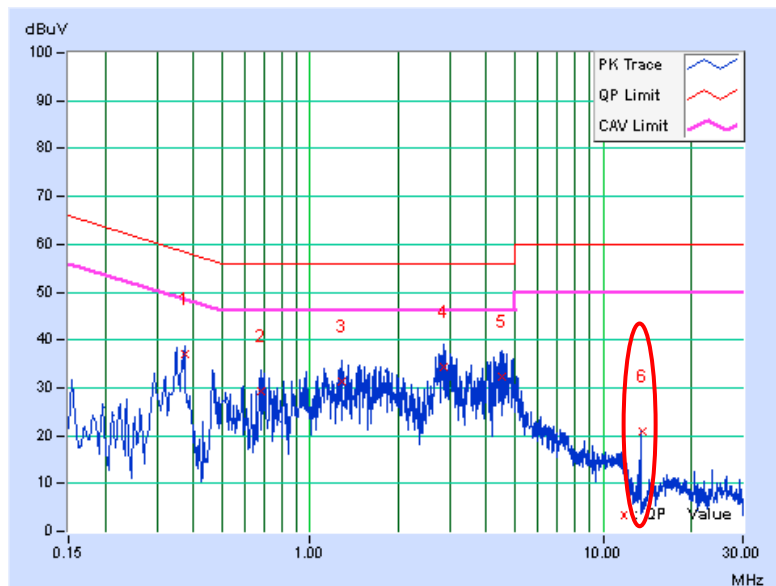

With a suitable dummy load

PHASE	Line 1	6dB BANDWIDTH	9kHz
-------	--------	---------------	------

No	Freq. [MHz]	Corr. Factor (dB)	Reading Value		Emission Level		Limit		Margin	
			[dB (uV)]		[dB (uV)]		[dB (uV)]		(dB)	
			Q.P.	AV.	Q.P.	AV.	Q.P.	AV.	Q.P.	AV.
1	0.35723	0.09	35.73	19.95	35.82	20.04	58.79	48.79	-22.97	-28.75
2	0.72477	0.13	28.63	13.14	28.76	13.27	56.00	46.00	-27.24	-32.73
3	1.18615	0.19	27.98	12.45	28.17	12.64	56.00	46.00	-27.83	-33.36
4	1.58888	0.20	28.40	13.17	28.60	13.37	56.00	46.00	-27.40	-32.63
5	2.87136	0.23	33.65	18.02	33.88	18.25	56.00	46.00	-22.12	-27.75
6	4.52138	0.27	34.46	18.40	34.73	18.67	56.00	46.00	-21.27	-27.33

REMARKS:

1. Q.P. and AV. are abbreviations of quasi-peak and average individually.
2. The emission levels of other frequencies were very low against the limit.
3. Margin value = Emission level - Limit value
4. Correction factor = Insertion loss + Cable loss
5. Emission Level = Correction Factor + Reading Value

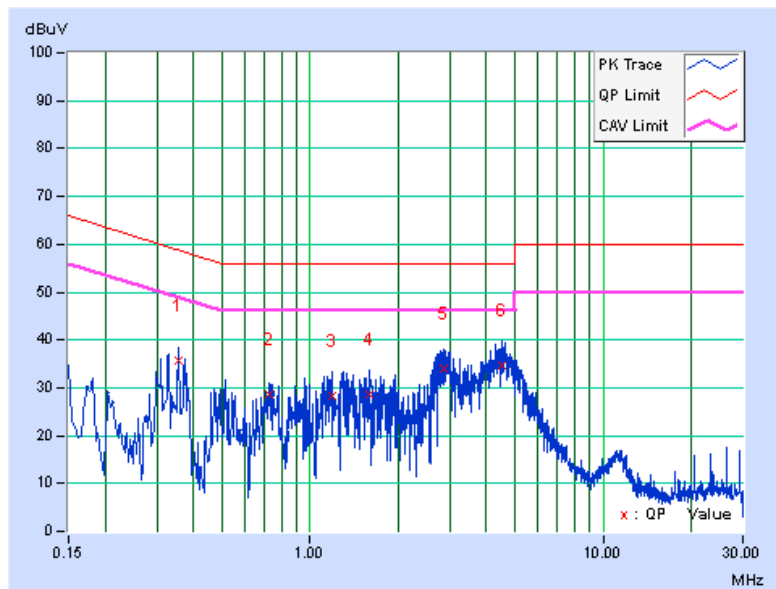

PHASE	Line 2	6dB BANDWIDTH	9kHz
-------	--------	---------------	------

No	Freq. [MHz]	Corr. Factor (dB)	Reading Value		Emission Level		Limit		Margin	
			[dB (uV)]		[dB (uV)]		[dB (uV)]		(dB)	
			Q.P.	AV.	Q.P.	AV.	Q.P.	AV.	Q.P.	AV.
1	0.36526	0.18	38.35	27.53	38.53	27.71	58.61	48.61	-20.07	-20.89
2	0.95546	0.18	30.12	18.08	30.30	18.26	56.00	46.00	-25.70	-27.74
3	1.13141	0.18	30.99	18.01	31.17	18.19	56.00	46.00	-24.83	-27.81
4	1.52632	0.20	30.73	17.27	30.93	17.47	56.00	46.00	-25.07	-28.53
5	2.85572	0.29	34.23	22.16	34.52	22.45	56.00	46.00	-21.48	-23.55
6	4.57221	0.40	31.08	18.72	31.48	19.12	56.00	46.00	-24.52	-26.88

#### REMARKS:

1. Q.P. and AV. are abbreviations of quasi-peak and average individually.
2. The emission levels of other frequencies were very low against the limit.
3. Margin value = Emission level - Limit value
4. Correction factor = Insertion loss + Cable loss
5. Emission Level = Correction Factor + Reading Value

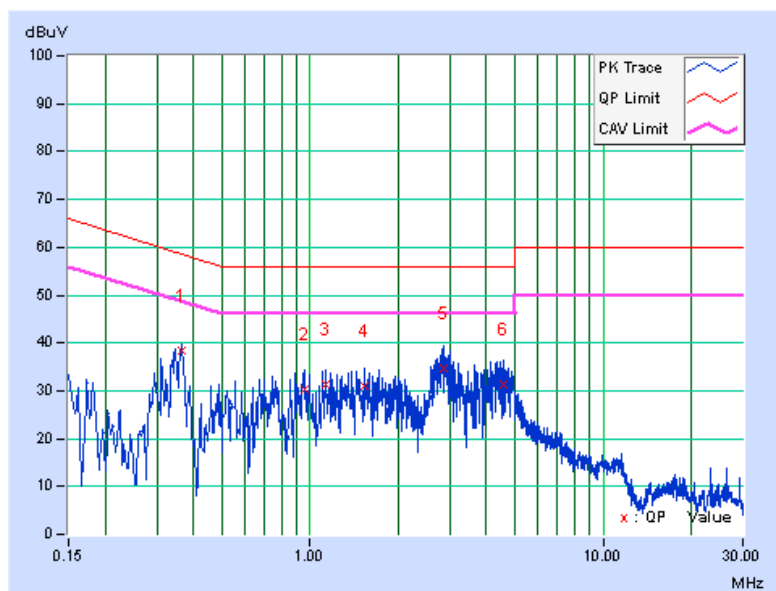

## 5. PHOTOGRAPHS OF THE TEST CONFIGURATION

Please refer to the attached file (Test Setup Photo).



## 6. INFORMATION ON THE TESTING LABORATORIES

We, Bureau Veritas Consumer Products Services (H.K.) Ltd., Taoyuan Branch, were founded in 1988 to provide our best service in EMC, Radio, Telecom and Safety consultation. Our laboratories are accredited and approved according to ISO/IEC 17025.

If you have any comments, please feel free to contact us at the following:

**Linko EMC/RF Lab:**

Tel: 886-2-26052180

Fax: 886-2-26051924

**Hsin Chu EMC/RF/Telecom Lab:**

Tel: 886-3-5935343

Fax: 886-3-5935342

**Hwa Ya EMC/RF/Safety Lab:**

Tel: 886-3-3183232

Fax: 886-3-3270892

**Email:** [service.adt@tw.bureauveritas.com](mailto:service.adt@tw.bureauveritas.com)

**Web Site:** [www.bureauveritas-adt.com](http://www.bureauveritas-adt.com)

The address and road map of all our labs can be found in our web site also.



## **7. APPENDIX A - MODIFICATIONS RECORDERS FOR ENGINEERING CHANGES TO THE EUT BY THE LAB**

No any modifications are made to the EUT by the lab during the test.

--- END ---