

CipherLab Reference Manual

Android 4.4

RS30

Version 1.00



Copyright © 2015 CIPHERLAB CO., LTD.
All rights reserved

The software is provided under a license agreement containing restrictions on use and disclosure and is also protected by copyright law. Reverse engineering of the software is prohibited.

Due to continued product development this information may change without notice. The information and intellectual property contained herein is confidential between CIPHERLAB and the client and remains the exclusive property of CIPHERLAB CO., LTD. If you find any problems in the documentation, please report them to us in writing. CIPHERLAB does not warrant that this document is error-free.

No part of this publication may be reproduced, stored in a retrieval system, or transmitted in any form or by any means, electronic, mechanical, photocopying, recording or otherwise without the prior written permission of CIPHERLAB CO., LTD.

For product consultancy and technical support, please contact your local sales representative. Also, you may visit our web site for more information.

The CipherLab logo is a registered trademark of CIPHERLAB CO., LTD.

All brand, product and service, and trademark names are the property of their registered owners.

The editorial use of these names is for identification as well as to the benefit of the owners, with no intention of infringement.

CIPHERLAB CO., LTD.

Website: <http://www.CipherLab.com>

IMPORTANT NOTICES

FOR USA

This equipment has been tested and found to comply with the limits for a **Class B** digital device, pursuant to Part 15 of the FCC Rules. These limits are designed to provide reasonable protection against harmful interference in a residential installation. This equipment generates, uses and can radiate radio frequency energy and, if not installed and used in accordance with the instructions, may cause harmful interference to radio communication. However, there is no guarantee that interference will not occur in a particular installation. If this equipment does cause harmful interference to radio or television reception, which can be determined by turning the equipment off and on, the user is encouraged to try to correct the interference by one or more of the following measures:

- ▶ Reorient or relocate the receiving antenna.
- ▶ Increase the separation between the equipment and receiver.
- ▶ Connect the equipment into an outlet on a circuit different from that to which the receiver is connected.
- ▶ Consult the dealer or an experienced radio/TV technician for help.

This device complies with Part 15 of the FCC Rules. Operation is subject to the following two conditions: (1) This device may not cause harmful interference, and (2) this device must accept any interference received, including interference that may cause undesired operation.

FCC Caution:

Any changes or modifications not expressly approved by the party responsible for compliance could void the user's authority to operate this equipment. This transmitter must not be co-located or operating in conjunction with any other antenna or transmitter.

FOR PRODUCT WITH LASER

CAUTION



This laser component emits FDA / IEC Class 2 laser light at the exit port. Do not stare into beam.

SPECIFIC ABSORPTION RATE (SAR) INFORMATION

The product complies with the FCC / Canada portable RF exposure limit set forth for an uncontrolled environment and are safe for intended operation as described in this manual. The further RF exposure reduction can be achieved if the products can be kept as far as possible from the user body or set the device to lower output power if such function is available.

SAFETY PRECAUTIONS

RISK OF EXPLOSION IF BATTERY IS REPLACED BY AN INCORRECT TYPE. DISPOSE OF USED BATTERIES ACCORDING TO THE INSTRUCTIONS.

- ▶ The use of any batteries or charging devices, which are not originally sold or manufactured by CipherLab, will void your warranty and may cause damage to human body or the product itself.
- ▶ DO NOT disassemble, incinerate or short circuit the battery.
- ▶ DO NOT expose the scanner or the battery to any flammable sources.
- ▶ For green-environment issue, it's important that batteries should be recycled in a proper way.
- ▶ Under no circumstances, internal components are self-serviceable.

CARE & MAINTENANCE

- ▶ This mobile computer is intended for industrial use. The mobile computer is rated IP65, however, damage may be done to the mobile computer if it is exposed to extreme temperatures or soaked in water.
- ▶ When the body of the mobile computer gets dirty, use a clean, wet cloth to wipe off dust and debris. DO NOT use bleaches or cleaners.
- ▶ Use a clean, non-abrasive, lint-free cloth to wipe dust off the LCD touch screen. DO NOT use any pointed or sharp objects against the surface. Always keep the LCD dry.

- ▶ If you want to put away the mobile computer for a period of time, download the collected data to a host computer, and then remove the battery pack from the mobile computer's battery compartment. Store the mobile computer and battery pack separately.
- ▶ If you encounter malfunction on the mobile computer, write down the specific scenario and consult your local sales representative.

RELEASE NOTES

Version	Date	Notes
1.00	Jan 26, 2015	▶ Initial release

CONTENTS

IMPORTANT NOTICES.....	- 3 -
For USA	- 3 -
For Canada	- 4 -
For Product with Laser	- 5 -
Specific Absorption Rate (SAR) information	- 5 -
Safety Precautions	- 5 -
Care & Maintenance	- 5 -
RELEASE NOTES	- 7 -
INTRODUCTION	1
Features	2
Inside the Package	2
Accessories	2
QUICK START	3
1.1. Overview	3
1.1.1. Installing Battery	5
1.1.2. Installing SIM Card, SAM Card and Memory Card	6
1.1.3. Power On/Off Mobile Computer	7
1.1.4. Using Hardware Buttons	7
1.1.5. Connecting Headset	8
1.2. Charging & Communication	9
1.2.1. Charge Mobile Computer	9
1.2.2. Wired Data Transmission	11
1.2.3. Using Wireless Networks	11
USING THE RS30 MOBILE COMPUTER	13
2.1. Battery	14
2.1.1. Battery Status Indicators	15
2.1.2. Monitor Battery Level	16
2.1.3. Replace Main Battery	18
2.1.4. Power Management	19
2.2. Memory	20
2.2.1. Check Storage Space	21
2.3. Touch Screen	22
2.3.1. Screen Brightness	22
2.3.2. Screen Rotation	22
2.3.3. Screen Timeout Settings	23
2.3.4. Text Size	24
2.4. Notifications	25
2.4.1. Status LED	25
2.4.2. Audio	25
2.4.3. Vibrator	27

2.5.	Date and Time	28
2.5.1.	Set Date, Time and Time Zone	28
2.6.	Language & Keyboard Input	29
2.6.1.	On-screen Keyboard	29
2.7.	Sound and Volume	30
2.8.	Data Capture.....	31
2.8.1.	Barcode Reader	31
2.8.2.	Digital Camera	31
2.9.	Snap-on USB Cable	32
2.10.	Charging & Communication Cradle	32
BASIC OPERATION OF THE RS30 MOBILE COMPUTER.....		35
3.1.	Home Screen	36
3.1.1.	Customize Home Screen.....	38
3.1.2.	Customize Wallpaper.....	40
3.2.	Widgets.....	41
3.2.1.	Add Widgets	42
3.2.2.	Remove Widgets	43
3.3.	Status Bar	44
3.4.	Notifications Panel	47
3.5.	Applications Menu	49
3.6.	Manage Applications	51
3.6.1.	Current Applications	51
3.7.	Suspend & Lock.....	52
3.7.1.	Suspend Device	52
3.7.2.	Lock Device.....	52
WIRELESS RADIOS.....		53
4.1.	Use Wireless Wide Area Network	54
4.2.	Use Wireless Local Area Network (Wi-Fi)	56
4.2.1.	Power On/Off Wi-Fi	56
4.2.2.	Connect to Wi-Fi Network.....	56
4.2.3.	Manually Add Wi-Fi Network	58
4.3.	Use Bluetooth	59
4.3.1.	Bluetooth Profiles	59
4.3.2.	Power On/Off Bluetooth	60
4.3.3.	Set Bluetooth Visibility.....	61
4.3.4.	Change Bluetooth Name.....	62
4.3.5.	Pair Bluetooth Device.....	62
4.3.6.	Unpair Bluetooth Device	63
4.3.7.	Select Bluetooth Service	63
4.4.	Use Near Field Communications	64
USING THE PHONE.....		67
5.1.	Phone Power	68
5.1.1.	Turn On/Off Phone Power	69
5.1.2.	SIM Card Missing.....	69

SPECIFICATIONS	71
Platform, Processor & Memory.....	71
Communication & Data Capture	71
Electrical Characteristics	72
Physical Characteristics	73
Environmental Characteristics	74
Programming Support.....	75
Accessories.....	75

INTRODUCTION

The RS30 Mobile Computer, powered by Android 4.4, is light-weight, easy to use, and provides more powerful and handy tools to delivering flexibility in customization.

Specifically designed to work as an industrial PDA, the RS30 Mobile Computer provides rich options of data collection, voice and data communication, long-lasting working hours, and so on. Its large color transmissive TFT display guarantees ease in reading in all lighting conditions. Integrated with Bluetooth and 802.11b/g technologies, you may choose to include a GSM/GPRS module to gain greater speeds and optimal mobility. In particular, an integrated GPS receiver is made available for use with third-party location-based applications.

This manual serves to guide you through how to install, configure, and operate the mobile computer. The Care & Maintenance section is specifically crucial for those who are in charge of taking care of the mobile computer.

We recommend you to keep one copy of the manual at hand for quick reference or maintenance purposes. To avoid any improper disposal or operation, please read the manual thoroughly before use.

Thank you for choosing CipherLab products!

FEATURES

- ▶ Built tough to survive drop test and sealed against moisture/dust to industrial standard IP54
- ▶ Android 4.4 operating system with a powerful MT8382 Quad Core 1.3 GHz processor
- ▶ 8GB eMMC flash memory to store OS and software programs
- ▶ 1GB LPDDR2 to store and run programs, as well as store program data
- ▶ One microSD expansion slot for SDHC memory card up to 32GB with SDXC support
- ▶ Three reader options — 1D linear, 1D laser or 2D imager
- ▶ Built-in 8.0 Megapixel CMOS digital camera with white LED for flash and auto focus
- ▶ Left and right side triggers for ambidextrous scanning
- ▶ Total wireless solution — connectivity includes Bluetooth, 802.11b/g and GSM/EDGE/UMTS/HSPA
- ▶ A 4.7" color transmissive TFT display delivering excellent visibility in all lighting conditions
- ▶ Programmable feedback indicators including speaker and vibrator
- ▶ Built-in scan engine setting tool Reader Configuration
- ▶ Accessories and peripherals include Snap-on Charging Cable and Charging Cradle

INSIDE THE PACKAGE

The following items are included in the kit package. Save the box and packaging material for future use in case you need to store or ship the mobile computer.

- ▶ RS30 Mobile Computer
- ▶ Rechargeable Li-ion battery pack
- ▶ Wrist Band
- ▶ Protective Boot
- ▶ AC Power Adaptor
- ▶ Quick Guide

ACCESSORIES

- ▶ Snap-on Charging Cable
- ▶ Charging Cradle

QUICK START

1.1. OVERVIEW

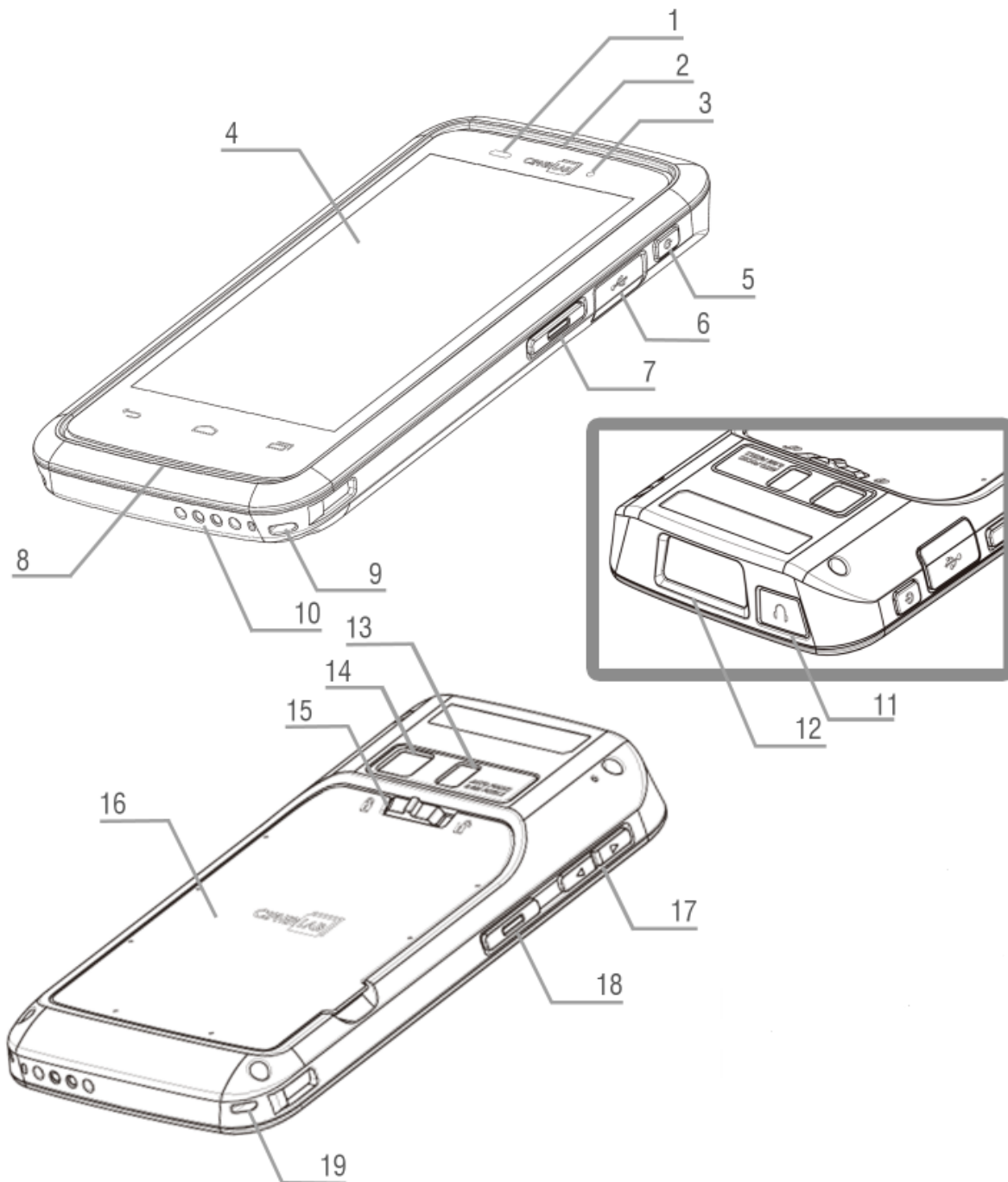

No.	Description	No.	Description
1	Light Sensor	2	Receiver
3	Status LED	4	Touchscreen
5	Power Button	6	Micro USB Port
7	Side Key	8	Speaker
9	Wristband Slot	10	Charging Pins
11	Headset Jack	12	Scan Window
13	Camera Flash	14	Camera
15	Battery Cover Latch	16	Battery Cover
17	Volume Buttons	18	Side Key
19	Wristband Slot		

1.1.1. INSTALLING BATTERY

For shipping and storage purposes, the mobile computer and the main battery are saved in separate packages.

Note: Any improper handling may reduce the battery life.

To install the main battery:

- 1) Push the battery lock at the top of the battery cover to the right in order to unlock.
- 2) Open the battery cover by pulling up the tab in the lower right corner.
- 3) Insert the main battery with the contact pins seated in the bottom left corner.
- 4) Fix the left edge of the battery cover first.
- 5) Press in the battery cover at the dotted sites.
- 6) Push the battery lock back to the lock position.

Warning:

- (1) Check that the battery lock is at the "lock" position before powering on the device.
- (2) For initial use, insert a charged battery, lock battery cover in place, then press the Power key to power on the mobile computer.

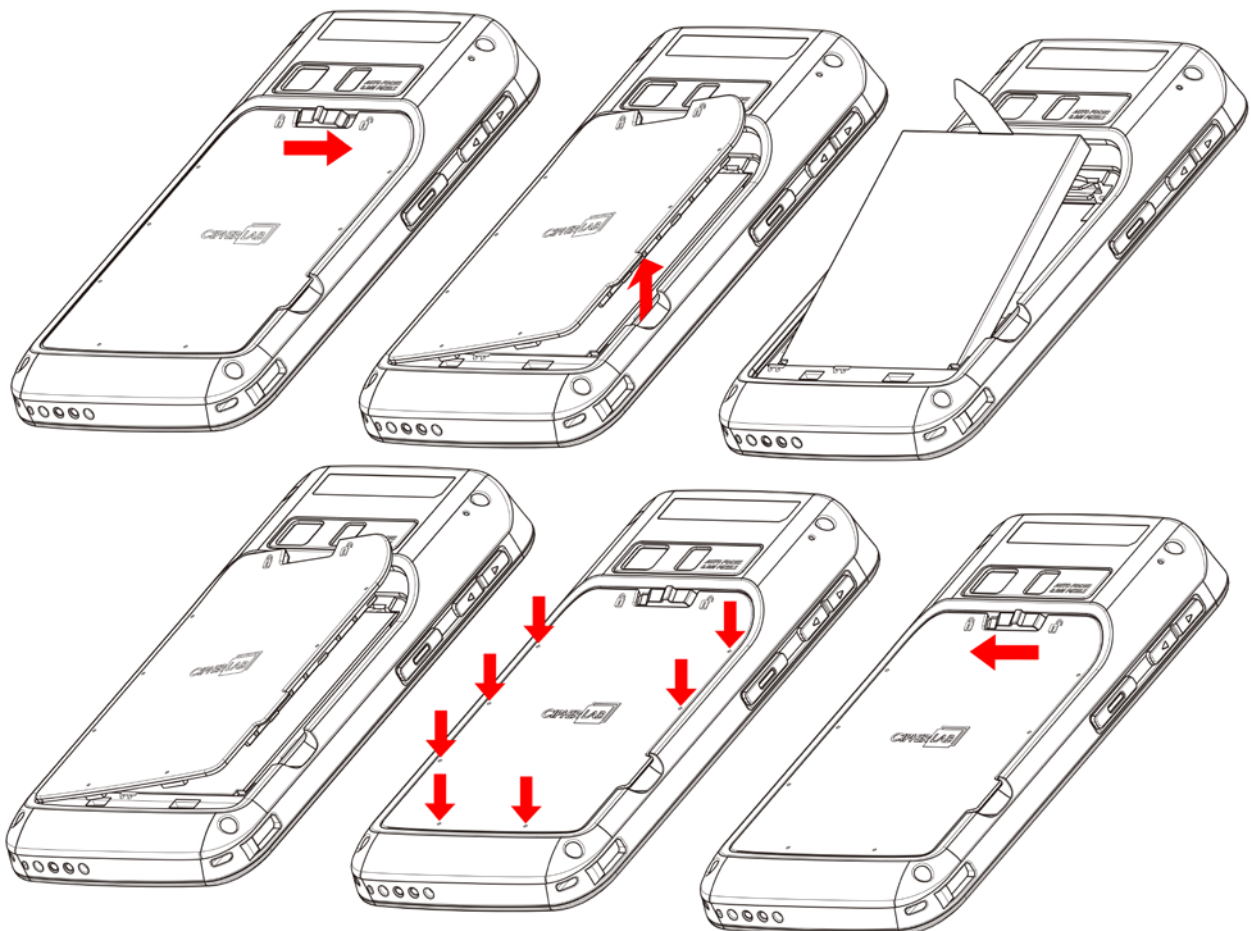

1.1.2. INSTALLING SIM CARD, SAM CARD AND MEMORY CARD

The RS30 Mobile Computer is equipped with two SIM card slots, one SAM card slot and one memory card slot.

Insert Cards

- 1) Remove the battery cover as described in steps 1-3 of [Installing Battery](#).
- 2) The two SIM card slots are located above the slots for the SAM card and SD card. Insert the cards into their respective slots according to the directions indicated. Push the cards to lock them in.

The SIM 1 slot (on the right) supports both 2G and 3G networks, while the SIM 2 slot (on the left) supports only 2G networks.

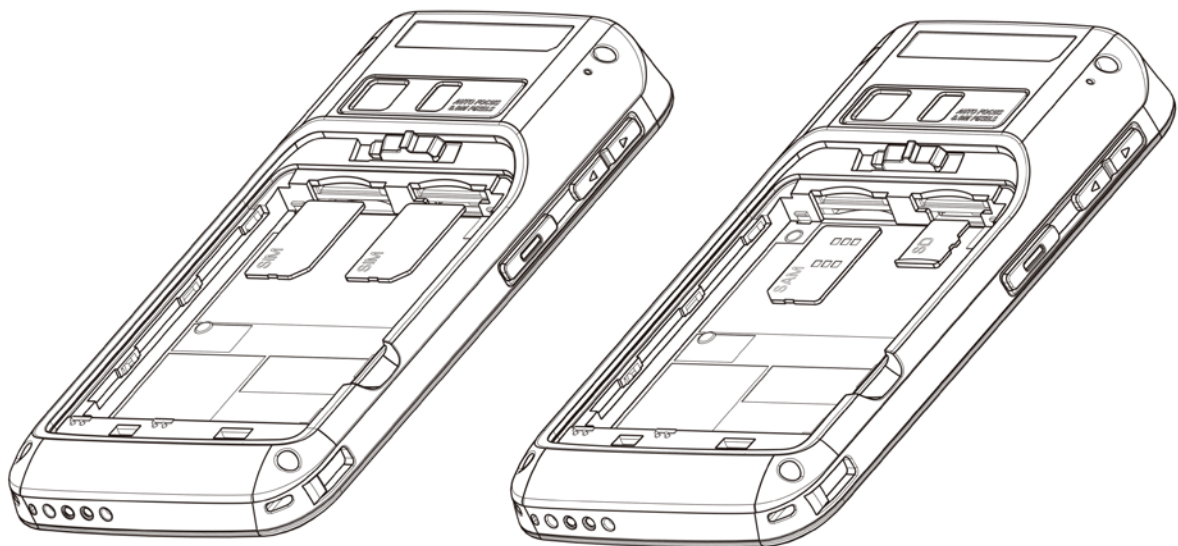

- 3) Replace the battery cover and push the battery lock back to the lock position.

Remove Cards

- 1) Remove the battery cover as described in steps 1-3 of [Installing Battery](#).
- 2) Push the SIM cards, SAM card and SD card to eject them from their slots.
- 3) Replace the battery cover and push the battery lock back to the lock position.

1.1.3. POWER ON/OFF MOBILE COMPUTER

POWER ON

To power on the mobile computer, press and hold the power button  located on the upper right side of the device. The mobile computer opens to show the [Home Screen](#).

Note: For the mobile computer to power on, the battery cover must be secured in place.

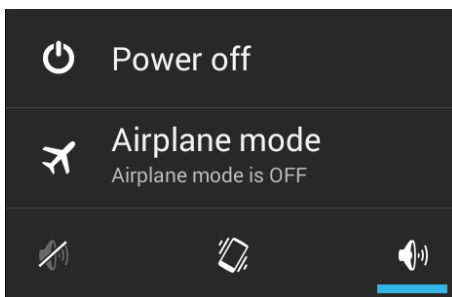

POWER OFF

To power off the mobile computer, press and hold the power button  for more than three seconds. A menu will appear on-screen which allows you to power off the device, switch to airplane mode, or set the system sound to mute or vibrate only. Make sure all user data and tasks have been stored before tapping **Power off**.



1.1.4. USING HARDWARE BUTTONS

On the bottom of the mobile computer are three hardware buttons that deliver the following functions:

Button	Function	Description
	Back button	Returns to the previous screen or closes the active window or keyboard.
	Home button	Displays the Home screen. Tap and hold the Home button to open a list of recently used applications.
	Recent apps button	Opens a list of recently used applications.

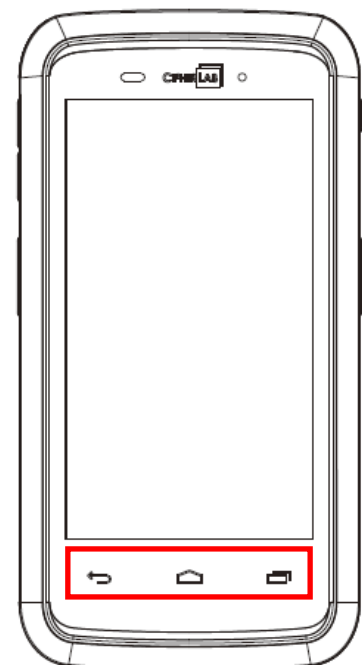

1.1.5. CONNECTING HEADSET

The headset jack is located on the top of the mobile computer. You can use the headset for audio playback or communication via the phone application, audio instant messaging, etc.

- 1) Flip up the rubber cover.
- 2) Connect the headset to the headset jack.
- 3) Replace the rubber cover.

1.2. CHARGING & COMMUNICATION

1.2.1. CHARGE MOBILE COMPUTER

The main battery may not be charged to full for shipment. When you first receive the kit package, you will need to charge the main battery to full before using the mobile computer. You may use the USB Snap-on USB Cable or Charging Cradle along with a power adapter to charge the mobile computer.

Charging Time

- ▶ Main battery: The main battery powers the mobile computer to work. It takes approximately 4 hours to charge an empty main battery to full. The charging LED above the screen (located on the right) will light up in red while charging and will turn green when charging is complete.
- ▶ When the main battery is removed, RTC retention will be maintained.
- ▶ Backup battery: The backup battery is mounted on the main board. Its role is to temporarily keep the mobile computer in suspension when the main battery is drained out so data in DRAM will be retained. The backup battery takes approximately 3.5 hours to charge to full by the main battery or power adapter.

Charging Temperature

- ▶ It is recommended to charge the battery at room temperature (18°C to 25°C) for optimal performance.
- ▶ Battery charging stops when ambient temperature drops below 0°C or exceeds 40°C.

Operation on Battery Power

- ▶ When 802.11b/g, GSM/GPRS, Bluetooth and GPS are all enabled on battery power, the main battery charge will drop down substantially.
- ▶ In order to prevent system shut down after the battery is drained out, we suggest that you keep a fresh battery for replacement at all times, or connect the mobile computer to an external power.

USING SNAP-ON USB CABLE

- 1) Fasten the Snap-on USB Cable to the lower end of the mobile computer.
- 2) Connect the other end of the Snap-on USB Cable to the adapter.
- 3) Fix the adapter plug onto the adapter, and plug in into an electrical outlet.

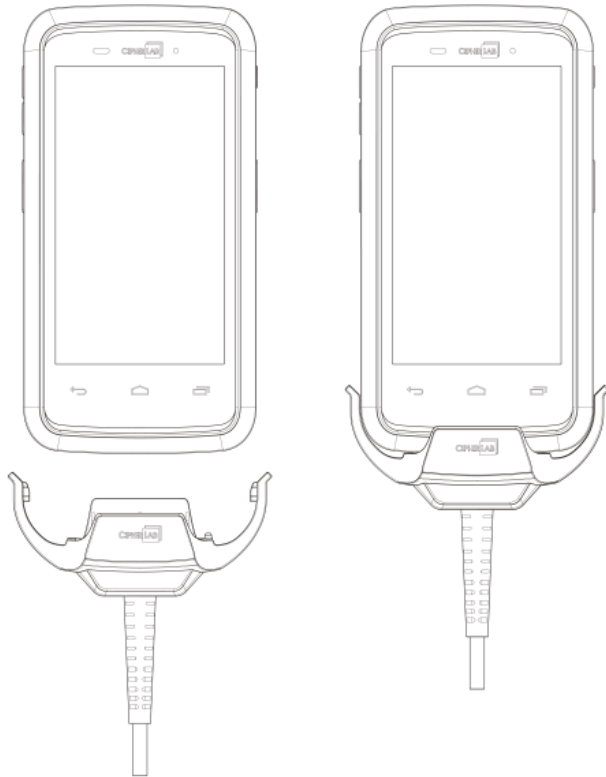

RS30 LED Indicator	Status	Description
Charging	Red, solid	Charging the mobile computer
	Green, solid	Charging complete

USING CRADLE

- 1) Insert the mobile computer onto the Charging Cradle.
- 2) If a Protective Boot is installed on the mobile computer, remove the cap on the Cradle's charging station, and insert the mobile computer.
- 3) Connect the adapter to the Cradle, and plug the other end into an electrical outlet.

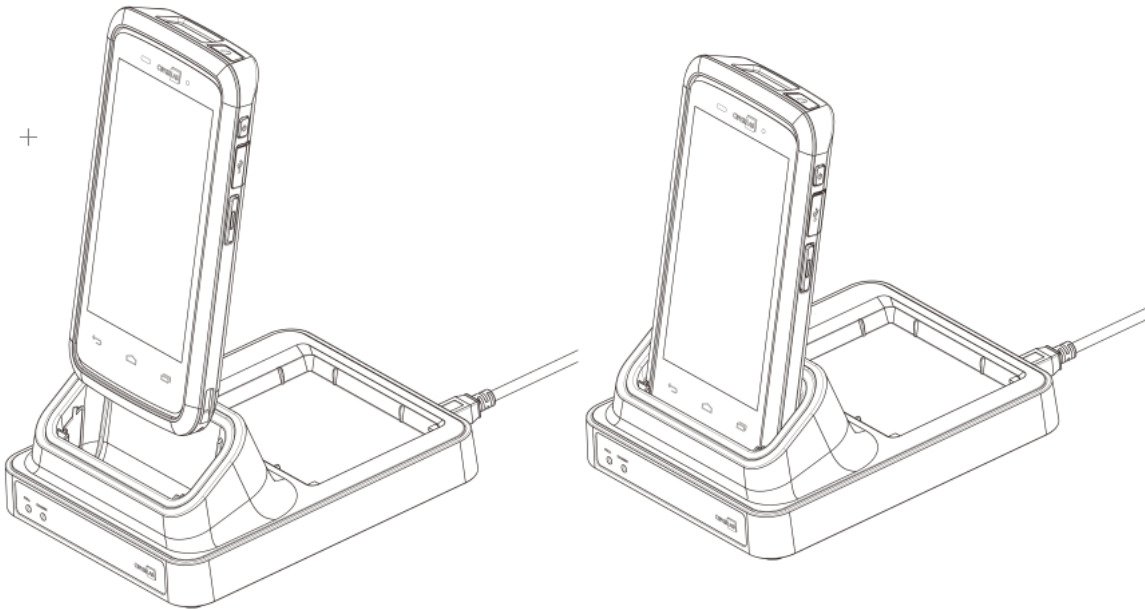

RS30 Cradle LED Indicator	Status	Description
Charging	Red, solid	Charging the mobile computer
	Green, solid	Charging complete
	No light	Charging error (charging will stop)

1.2.2. WIRED DATA TRANSMISSION

Use the micro USB cable to connect the mobile computer to your PC for data transmission.

1.2.3. USING WIRELESS NETWORKS

The mobile computer supports widely applied wireless technologies, Bluetooth and 802.11b/g, and is able to send/receive data in real time in an efficient way. Select GSM/GPRS modules embedded for a total wireless solution for data and voice communication.

USING THE RS30 MOBILE COMPUTER

This chapter explains the features and usage of the mobile computer.

IN THIS CHAPTER

2.1 Battery	14
2.2 Memory	20
2.3 Touch Screen	22
2.4 Notifications	25
2.5 Date and Time	28
2.6 Language & Keyboard Input	29
2.7 Sound and Volume	30
2.8 Data Capture.....	31
2.9 Snap-on USB Cable	32
2.10 Charging & Communication Cradle	32

2.1. BATTERY

▶ Main Battery

The mobile computer is powered by a rechargeable 3.8V / 3100mAh Li-ion battery pack, and it takes approximately 4 hours to charge it to full from the power adaptor. However, the charging time may vary by your working condition.

▶ Spare Battery

A spare battery pack is provided as an accessory. We recommend keeping a fully charged spare battery at hand in order to replace the main battery when it is nearly drained out.

▶ Backup Battery

Settled on the main board is a backup battery that keeps the mobile computer in suspension when the main battery is depleted. The backup battery is a 60 mAh rechargeable Li-ion battery, and can retain data in the DRAM for 30 minutes when it is fully charged (as long as wireless modules on the mobile computer are inactive). The backup battery can be charged by the main battery or the power adaptor, and takes approximately 3.5 hours to charge to full.





Warning:



- (1) The battery cover must be secured in position. If not, the mobile computer cannot turn on by pressing the power key or wake up by pressing the scan key.
 - (2) For a new battery, make sure it is fully charged before using.
 - (3) To avoid data loss, when replacing the main battery, make sure you replace it with a well-charged spare battery pack. Always prepare a spare battery at hand, especially when you are on the road.
-

2.1.1. BATTERY STATUS INDICATORS

The main battery pack is the only power source for the mobile computer to work. Therefore, when the main battery level goes low, you need to replace the battery pack with a charged one or charge it as soon as possible. Most of all, you should backup important data on a regular basis.

By checking the battery status icon, you can tell the battery level remaining in the main battery.

Battery Icon	Description
	External power source is connected and main battery is being charged.
	Main battery is fully charged.
	Main battery level is partially drained.
	Main battery level is low.
	Main battery level is very low and needs charging immediately.

Note: When the mobile computer is fully charged and battery level reaches 100%, the battery icon will change from  to  to indicate charging is completed.

Warning:

- (1) Once the battery level drops below 20%, the low battery notification will be displayed on the screen.
- (2) Data loss with RAM may occur when battery level is low. Always save data before the battery runs out of power or keep a fresh battery for replacement.
- (3) Constant usage of the mobile computer at low battery level can affect battery life. For maximum performance, recharge the battery periodically to avoid battery drain out and maintain good battery health.

2.1.2. MONITOR BATTERY LEVEL

MAIN BATTERY LEVEL

The main battery is the only source that feeds the mobile computer to work. It also supplies the backup battery on the main board in order to retain the data stored in DRAM. When main battery level gets low, recharge it or replace it as soon as possible. Most critically, back up the important data from time to time to protect your work.

To check main battery level:

Tap **Home**  | **Settings**  | **Battery** .

Battery level percentage is also shown to provide a clear grasp of the remaining battery power. The screen also shows the rate of battery discharge since the last battery charging session, how long the device has been running on battery power, and which applications are consuming the most battery power.

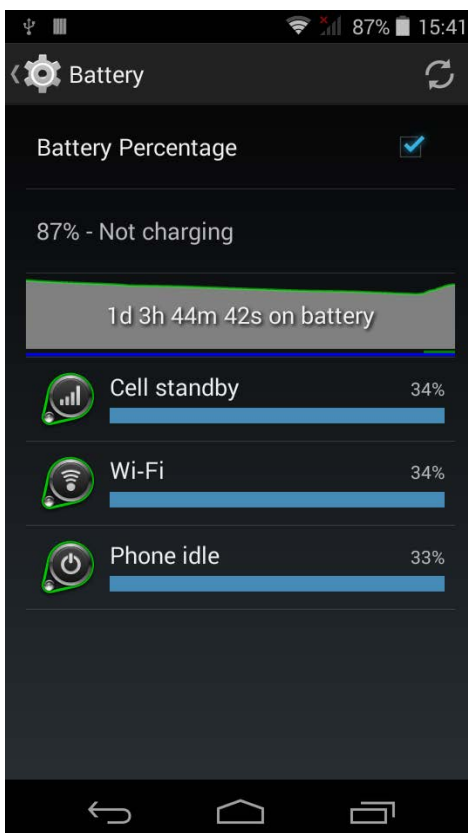

LOW BATTERY ALERT

When the main battery level drops to 20%, the mobile computer prompts a warning reminding you to charge the main battery. When the main battery level drops to 10%, the mobile computer prompts a second warning. When the main battery level drops to 4%, the mobile computer shuts down. When either of these situations occurs, connect the mobile computer to an external power source, or replace the main battery pack as soon as possible.

To replace the main battery pack, see [Replace Main Battery](#).

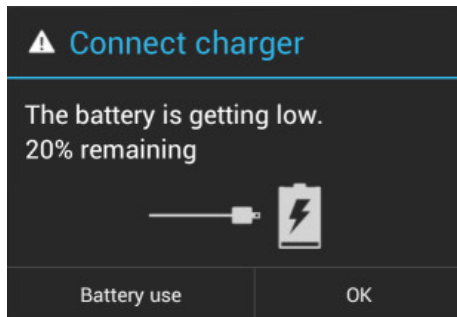

2.1.3. REPLACE MAIN BATTERY

When main battery level is low, follow the steps below to replace the main battery.

- 1) Press and hold the power button on the side of the mobile computer.
- 2) Tap power off in the pop-up menu. The mobile computer will power off.

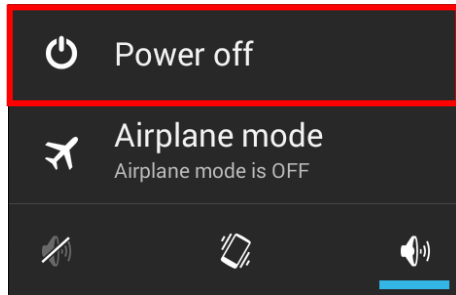

- 3) Open the battery cover and insert a charged main battery as in [Installing Battery](#).
- 4) Press the power button to power on the mobile computer.

Note:

- (1) Before replacing the main battery, make sure the backup battery is well-charged in order to avoid unnecessary data loss.
 - (2) After removing the main battery, insert a well-charged battery as soon as possible.
-

2.1.4. POWER MANAGEMENT

For any portable device, power management is a critical issue especially when you are on the road. Below are some tips to help you save battery power.

Warning: Using backlight, wireless connectivity, and peripheral devices while on battery power will substantially reduce battery power.

- ▶ Bring an additional main battery pack with you on the road.
- ▶ End wireless connections (such as Bluetooth, 802.11a/b/g/n, GSM/GPRS, and GPS) which are not in use.
- ▶ Shorten the screen turn off time. See [Screen Timeout Settings](#).
- ▶ Reduce the screen brightness level. See [Screen Brightness](#).
- ▶ Shut down automatic data syncing of applications (such as Email, Calendar, Contacts).

2.2. MEMORY

- ▶ Flash Memory (ROM)

8GB flash memory for storing the OS (Android 4.4) and custom application programs.

- ▶ Random-access Memory (RAM)

1GB RAM for storing and running programs, as well as storing program data.

- ▶ Expansion Slot

The mobile computer is equipped with one microSD card slot which accommodates an SD card up to 32 GB. High capacity memory card (microSDHC) is supported as well.

CAUTION OF DATA LOSS

When the main battery is removed or drained, the backup battery on the main board takes over to supply the mobile computer and keep it in suspension. A fully charged backup battery will retain the data in the RAM for 30 minutes. When the backup battery is drained out as well, only the contents of RTC will be retained. All other unsaved data will be lost.

If you want to put away the mobile computer for a couple of days, you should be aware that data loss occurs when the main battery and backup battery discharges completely. Therefore, it is necessary to backup data and files before putting away the mobile computer.

2.2.1. CHECK STORAGE SPACE

Tap **Home**  | **Settings**  | **Storage**  to check usage of the internal and external storage spaces.



2.3. TOUCH SCREEN

The mobile computer comes with a 4.7" TFT graphic LCD with 240 by 320 pixels resolution (QVGA). The LED backlight of the screen, which helps ease reading under dim environments, can be controlled manually and automatically.

Warning: DO NOT use any pointed or sharp objects to move against the surface of the screen.

2.3.1. SCREEN BRIGHTNESS

Tap **Home**  | **Settings**  | **Display**  | **Brightness**.

Adjust screen brightness by dragging the slider to the right (to increase brightness) or left (to reduce brightness). Select the **Economical backlight** checkbox to enable automatic backlight adjustment with the mobile computer's built in sensor.

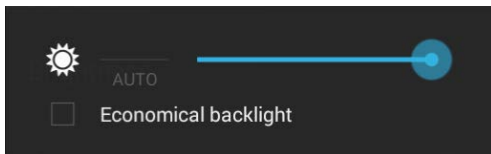

Note: To save battery power, dim the screen brightness while working in a well-lit area, or set a shorter sleeping plan for the screen backlight to go off.

2.3.2. SCREEN ROTATION

For the mobile computer to automatically adjust screen orientation:

Select **Home**  | **Settings**  | **Display**  | **Auto-rotate screen**.

Note: The Home Screen does not rotate.

2.3.3. SCREEN TIMEOUT SETTINGS

Tap **Home**  | **Settings**  | **Display**  | **Sleep**.

Select the time for screen timeout.

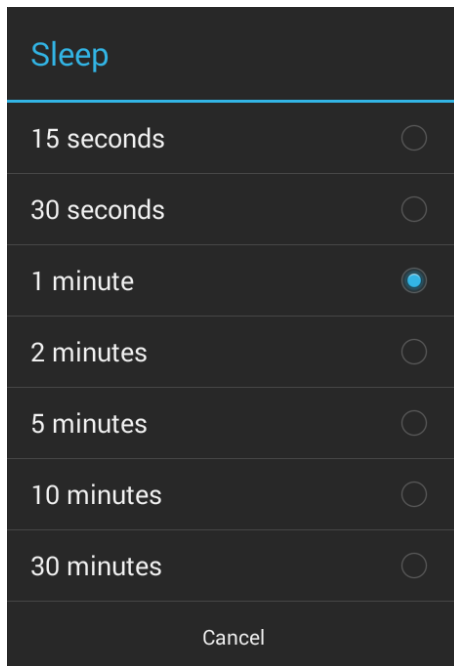

2.3.4. TEXT SIZE

Tap **Home**  | **Settings**  | **Display**  | **Font Size**. Select the font size between Small, Normal, Large and Extra Large.

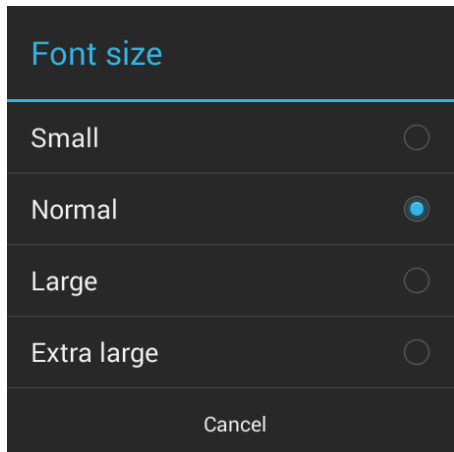

2.4. NOTIFICATIONS

2.4.1. STATUS LED

An LED indicators located above the touch screen provide information about charging status, scanner light beam, and scanner "Good Read" during data collection.

Indicator	Status	Description
Charging	Green, solid	Charging complete
	Red, solid	Charging the mobile computer
	Red, blinking	Charging error (for instance, battery not in place)
Scanner decode	Green, flash once	Good read
Wireless radio	Blue, blinking	Wi-Fi, Bluetooth, or mobile data is in use

2.4.2. AUDIO

The speaker is used to play sounds for events in Windows and programs, or play audio files. In addition, it can be programmed for status feedback. In noisy environments, you may consider connecting a headset instead. A headset jack is provided on the top of the mobile computer, which is a 3.5 mm DIA stereo earphone jack. The mobile computer also supports using Bluetooth headsets.

Supported audio file formats include: WAV, MP3, AAC, AAC+, Enhanced AAC+, AU (including ADPCM), Midi, XMF, AMR (NB and WB).

Use the volume buttons on the side of the mobile computer to adjust the system volume.

AUDIO PROFILE

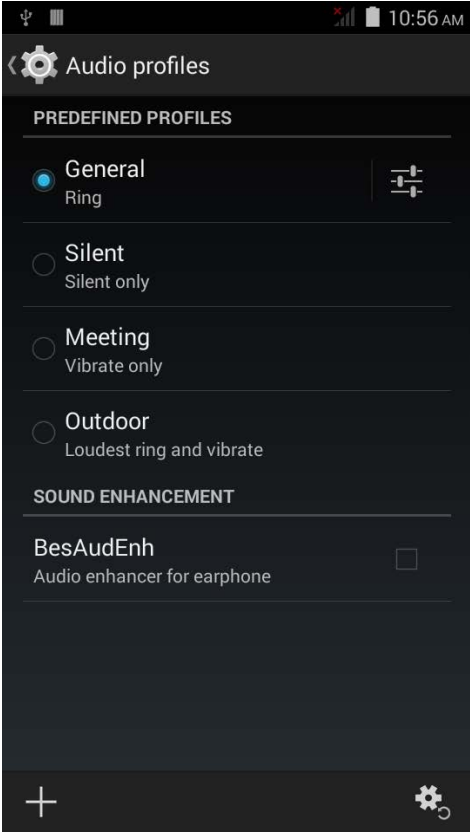

Tap **Home**  | **Settings**  | **Audio profiles** .

Select the audio profile to suit your working environment.



2.4.3. VIBRATOR

The mobile computer is integrated with a vibrator, which is software programmable for tactile feedback. This can be helpful when working in noisy environments.

You may also set the mobile computer to vibrate only, in which all system sounds will be muted and replaced by the vibrator. Tap **Home**  | **Settings**  | **Audio profiles**  and select **Meeting – Vibrate only**.

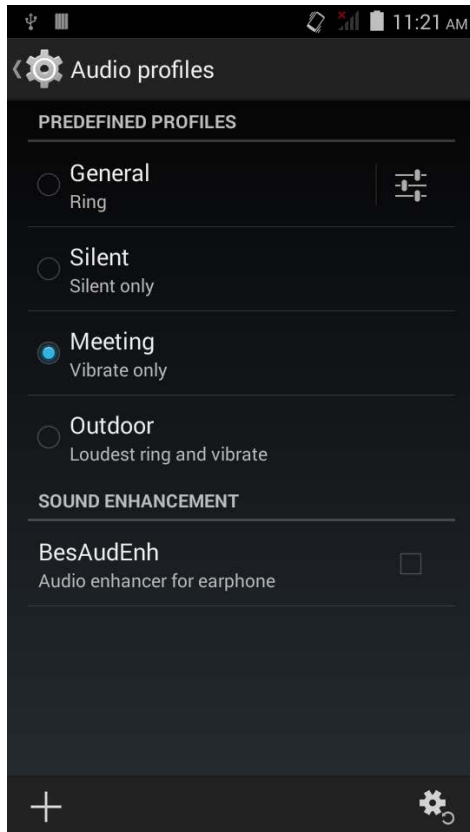

OR

Press and hold the power key, and tap the vibrate mode icon  in the menu.

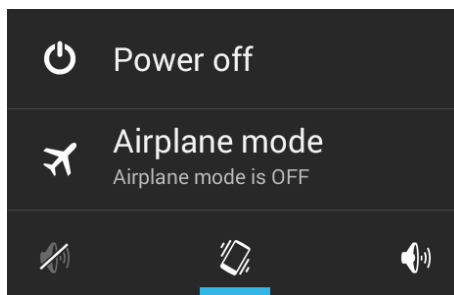



2.5. DATE AND TIME

2.5.1. SET DATE, TIME AND TIME ZONE

By default, the mobile computer automatically synchronizes the date and time to the WAN network (if connected).

To set the data and time manually:

- 1) Tap **Home**  | **Settings**  | **Date & time** .
- 2) Tap **Automatic data & time** and select **Off** to disable using network-provided time.
- 3) Deselect Automatic time zone.
- 4) Tap **Set date**. Use the sliders to select the correct month, date and year. Tap **Done** to save.
- 5) Tap **Set time**. Use the sliders to select the correct time. Tap **Done** to save.
- 6) Tap **Select time zone**. Select the correct time zone from the list.

2.6. LANGUAGE & KEYBOARD INPUT

Tap **Home**  | **Settings**  | **Language & input** to change the system language, default keyboard type, and configure keyboard input and speech settings.

2.6.1. ON-SCREEN KEYBOARD

Tap a text input field to automatically open an on-screen keyboard.

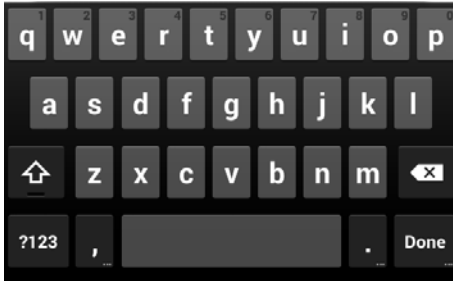

ADJUST KEYBOARD SETTINGS

To configure keyboard settings, tap and hold the comma button  until a settings

button  appears. A menu will open allowing you to adjust input language (if you would like to use an input language different from the system language) or keyboard settings.

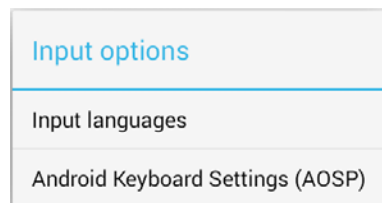

EDIT TEXT

Tap and hold text on the screen to enable a text editing menu for selecting all text, or cutting, copying and pasting text within or across applications. Some applications may use different ways to select or edit text.



ENTER NUMBERS AND SYMBOLS

The top row of keys on the on-screen keyboard have an ellipsis (...) below the character. Tap and hold one of the top row keys until a menu opens, and select a number.

ENTER UPPERCASE LETTERS

Tap and hold the Shift key, and tap a character key to enter an uppercase letter. The letters will return to lower case once an uppercase letter is entered.

ENTER SYMBOLS

Tap  to switch to a keyboard for entering numbers and symbols. On this keyboard,

tap  to open a keyboard for entering special characters. Tap and hold a number or symbol key to open a menu of additional symbols related to that key.

Tap  to switch back to the keyboard for entering lowercase letters.

2.7. SOUND AND VOLUME

Use the volume buttons on the left side of the mobile computer to adjust system and ringer volume.

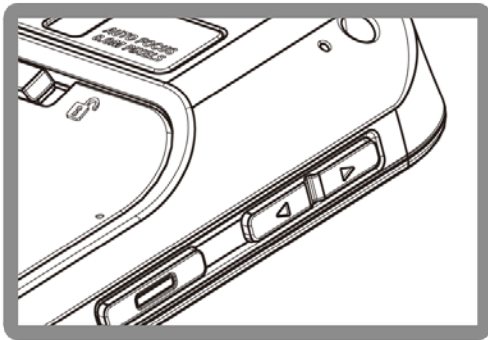

2.8. DATA CAPTURE

2.8.1. BARCODE READER

A selection of scan engines is available for delivering flexibility to meet different requirements. Depending on the scan engine integrated, the mobile computer is capable of scanning barcodes of a number of symbologies that are enabled by default while running the ReaderConfig.exe utility. If you need to scan barcodes that are encoded in a different symbology, enable the symbology first.

2.8.2. DIGITAL CAMERA

An integrated 8 megapixel camera in the mobile computer is specifically designed for collecting image data. You may use the image capture utility to turn on the camera and capture images.

2.9. SNAP-ON USB CABLE

The Snap-on USB Cable provides a convenient way to charge your mobile computer.

- ▶ Click the Snap-on USB Cable on to attach; pull either side outwards to detach
- ▶ Connect USB to PC or adapter to charge mobile computer
- ▶ Cable completes charging in approximately 4 hours
- ▶ LED on mobile computer shows charging status
- ▶ Adapter input 100-240VAC, 50/60Hz; output 5VDC/2A

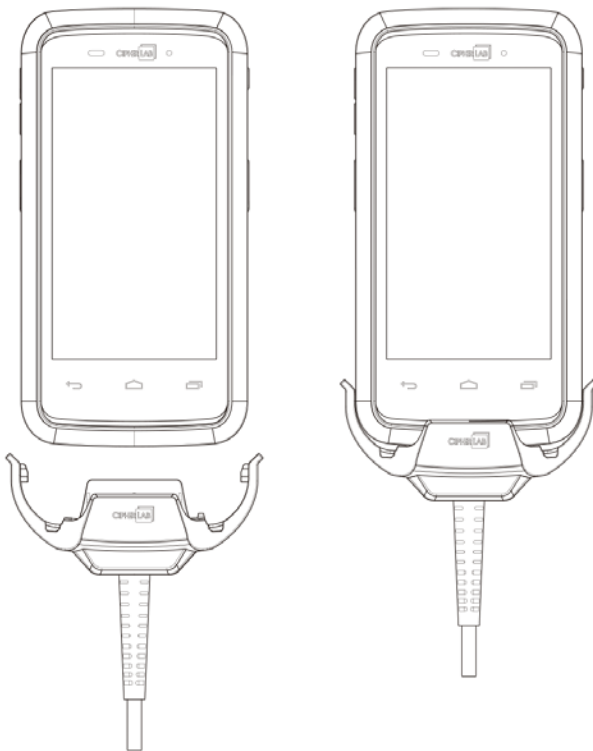

2.10. CHARGING & COMMUNICATION CRADLE

The Charging & Communication Cradle charges your mobile computer and a spare battery at the same time.

- ▶ Presents charging compartment for mobile computer and spare battery
- ▶ Provides microUSB socket on the back for charging
- ▶ Supports USB Host Mode via a USB OTG cable
- ▶ Completes charging in approximately 4 hours
- ▶ Two LEDs, one for power connection status and one for battery charging status
- ▶ Adapter input 100-240VAC, 50/60Hz; output 5VDC/2A

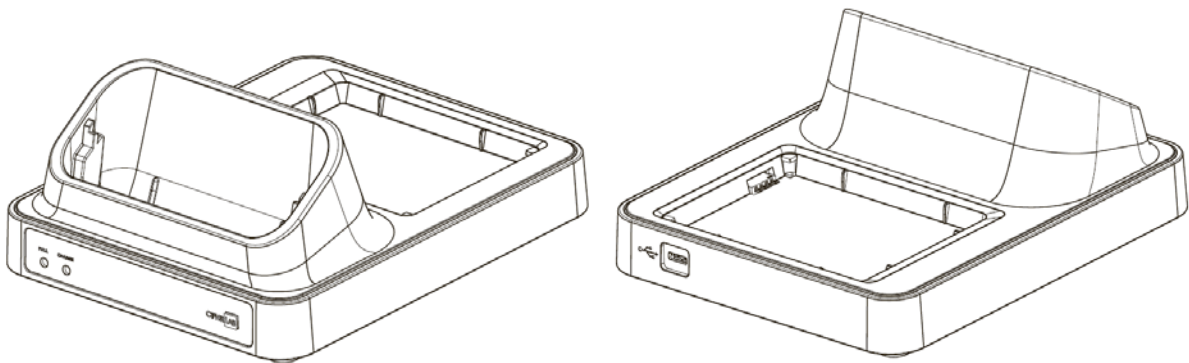

BASIC OPERATION OF THE RS30 MOBILE COMPUTER

This chapter describes the basic skills to work with the RS30 Mobile Computer, for instance how to operate the home screen, check system statuses and manage notifications. The add-on utilities for applications regarding data collection, processing, and transmission are introduced in the following chapters.

IN THIS CHAPTER

3.1 Home Screen.....	36
3.2 Widgets	41
3.3 Status Bar.....	44
3.4 Notifications Panel	47
3.5 Applications Menu	49
3.6 Manage Applications.....	51
3.7 Suspend & Lock	52

3.1. HOME SCREEN

When the mobile computer is fully charged, press the Power key for three seconds to turn on the mobile computer. A locked screen will appear. Slide the lock button  in either direction to unlock the screen.

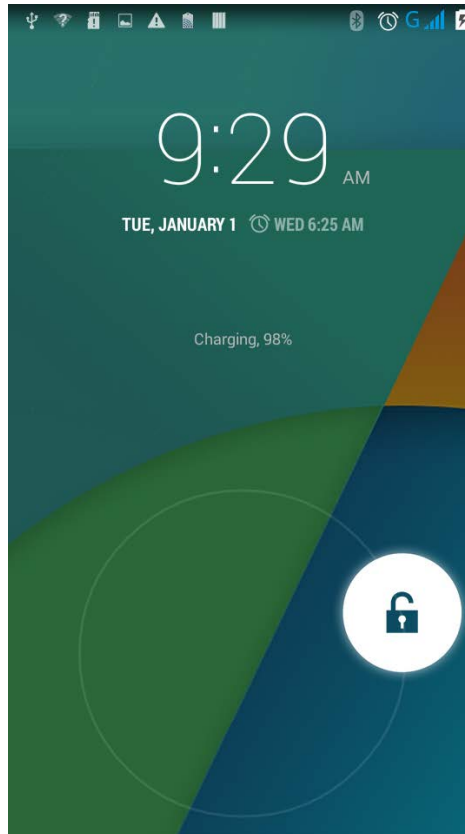
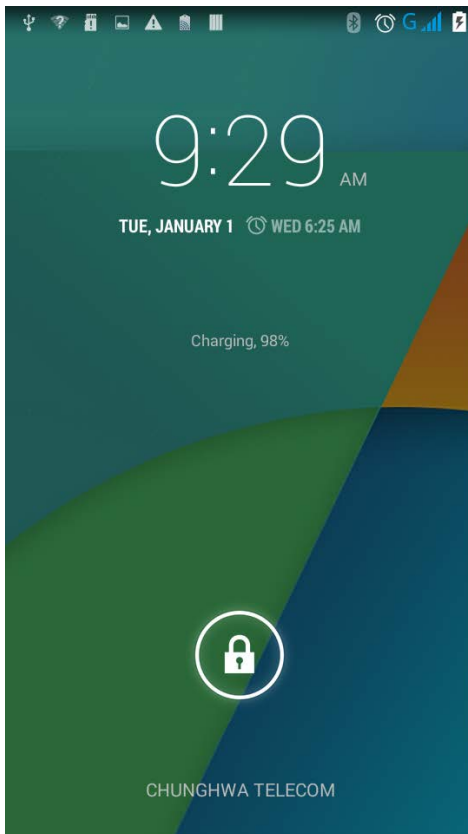

The **Home Screen** appears showing a status bar, shortcut icons, and a dock bar containing an All Apps button. The home screen allows up to four pages for placing shortcut icons and widgets. You may customize the home screen according to your preferences.

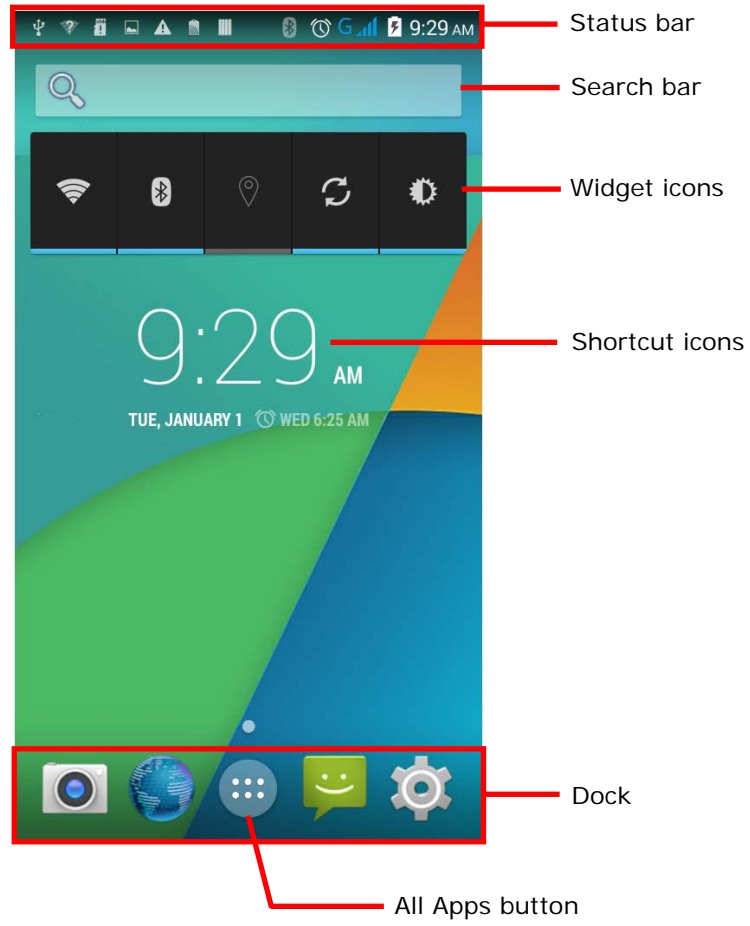

3.1.1. CUSTOMIZE HOME SCREEN

ADD APPLICATION SHORTCUT TO HOME SCREEN

- 1) On the home screen you would like to customize, tap .
- 2) Locate the application to add.
- 3) Tap and hold the application icon. The home screen will appear.
- 4) Drag the application icon to your preferred position and release to have it placed.

ADD WIDGET TO HOME SCREEN

- 1) Tap and hold any empty spot on the home screen.
- 2) Tap **Widgets** in the menu that appears.
- 3) Tap and hold the widget to add. The home screen will appear.
- 4) Drag the widget to your preferred position and release to have it placed.

MOVE APPLICATION SHORTCUTS ON HOME SCREEN

- 1) On the home screen you would like to customize, tap and hold the application shortcut you would like to move.
- 2) Drag the icon to the preferred position and release it to have it placed.

REMOVE APPLICATION SHORTCUT OR WIDGET FROM HOME SCREEN

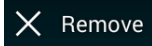
- 1) On the home screen you would like to customize, tap and hold the application shortcut or widget you would like to move.
- 2) Drag the icon to the top of the screen where the remove icon  is located.

CREATE FOLDER

- 1) On the home screen you would like to customize, tap and hold the application shortcut you would like to move.
- 2) Drag the icon on the top of another icon to create a folder.

NAME FOLDER

- 1) Tap the folder you would like to name.
- 2) Tap **Unnamed Folder** and edit the folder name.
- 3) Tap **Done** on the on-screen keyboard.

REMOVE FOLDER

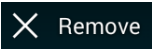
- 1) Tap and hold the folder you would like to remove.
- 2) Drag the folder to the top of the screen where the remove icon  is located.

CHANGE HOME SCREEN WALLPAPER

- 1) Tap and hold any empty spot on the home screen.
- 2) Tap **Wallpapers** in the menu that appears.
- 3) Select an image to apply as the wallpaper.
- 4) Tap **Set wallpaper** at the bottom of the wallpaper preview screen to apply it.

3.1.2. CUSTOMIZE WALLPAPER

- 1) Tap and hold any empty area on the Home Screen. A settings menu for the Home Screen will open at the bottom.



- 2) Tap **WALLPAPER** in the settings menu.

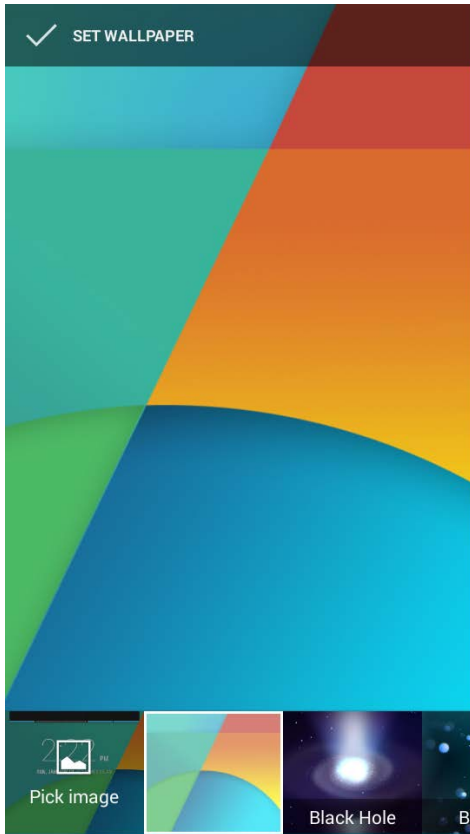



- 3) A wallpaper selection screen opens. Scroll through the wallpapers to select a wallpaper to apply.

3.2. WIDGETS

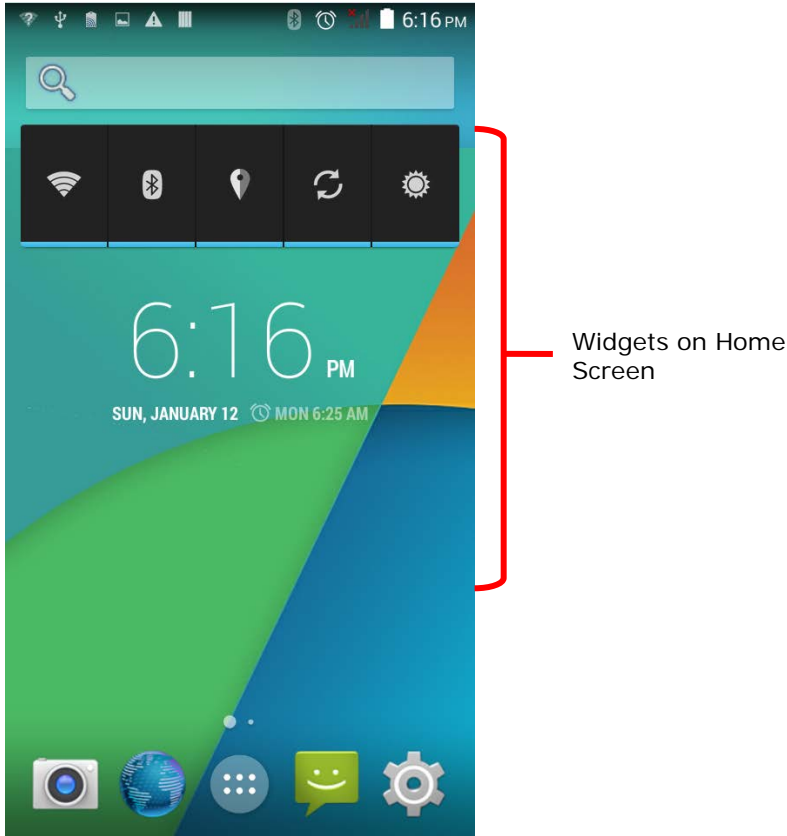
Widgets are designed for easy control of settings and viewing of status. Enabled widgets will be displayed on the Home Screen.

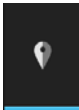
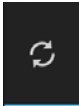

By default, two widgets are enabled, the power control widget and digital clock widget.

Default Widget	Icon	Description
Power control		Wi-Fi control. .See Power On/Off Wi-Fi .
		Bluetooth control. See Power On/Off Bluetooth .
		GPS control. Sets GPS mode between high accuracy and battery saving.
		Data syncing control. Syncs data of your Google account.

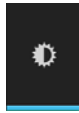

Screen brightness control. Sets the screen brightness profile between full, half, dim or auto.

Digital clock



Shows the current time, date and the set alarm.

3.2.1. ADD WIDGETS

To add a widget:

- 1) Tap and hold any empty area on the Home Screen. A settings menu for the Home Screen will open at the bottom.



- 2) Tap **WIDGETS** in the settings menu.
- 3) A widget menu opens. Tap and hold a widget and drag it to the Home Screen you would like to place it on.



3.2.2. REMOVE WIDGETS

To remove a widget:

- 1) Tap and hold a widget so it becomes highlighted. The widget is available for relocation.
- 2) Drag the widget to the top of the screen where a remove icon is located. The remove icon will change to red to indicate the widget is about to be removed.

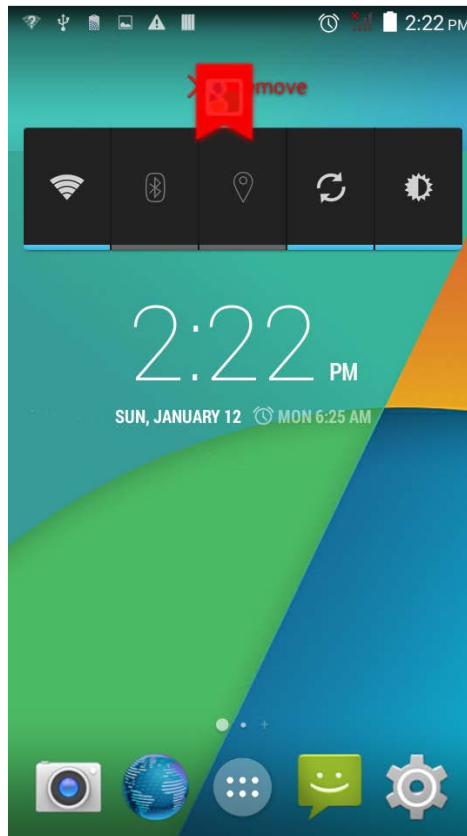
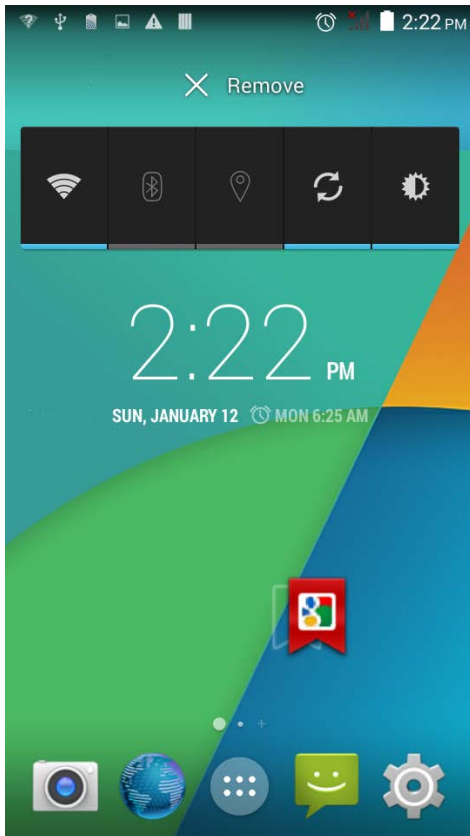





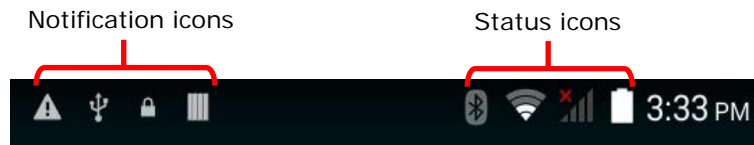















3.3. STATUS BAR

The left side of the status bar shows notification icons, and the right side of the status bar shows status icons.









NOTIFICATION ICONS

















Icon	Description
	More notifications are available, tap to show the Notifications Panel
	Upcoming event
	Data is syncing
	A problem has occurred with sign-in or data sync
	A song is currently playing
	Preparing storage card
	Storage card is almost full
	Uploading data
	Downloading data; when download is finished, icon stops flashing
	Connected to PC via USB cable. Change the type of USB connection by viewing the notification in the Notifications Panel
	No SIM card detected in either of the two SIM card slots
	NFC is enabled

	Multiuser feature is enabled
	New user is logged in
	Text message is received
	Missed call
	Car mode is active
	Connected to/disconnected from VPN network
	Bluetooth tethering is active
	USB tethering is active
	Wi-Fi network is available
	Wi-Fi hotspot is active

STATUS ICONS

The icons at the top of the screen are explained below.

Icon	Description
	GPS is active
	Currently searching for location data
	Alarm is active
	Vibrate mode is active; all system sounds (except media and alarms) are muted
	Phone ringer is muted
	Microphone is muted during a call
	Battery is fully charged

	Battery is partially drained
	Battery level is very low
	Battery is almost completely drained and needs charging immediately
	Battery is charging
	Airplane mode is active
	Bluetooth is active
	Connected to a Bluetooth device
	Connected to a Wi-Fi network
	No Wi-Fi signal detected
	Signal strength of mobile network
	No mobile network signal
	Connected to 3G network
	Connected to HSPA network
	Connected to EDGE network
	Connected to GPRS network
	No SIM card installed

3.4. NOTIFICATIONS PANEL

Use a downwards sliding motion from the top of the screen to open the notifications panel. To close the panel, slide the screen back upwards.

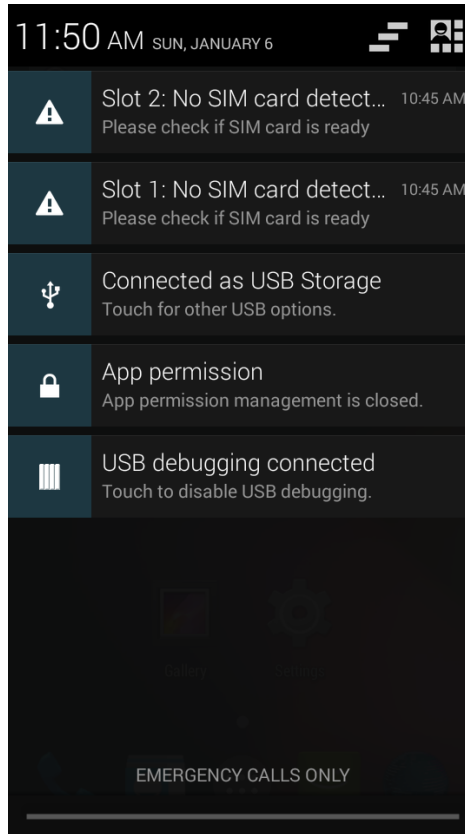
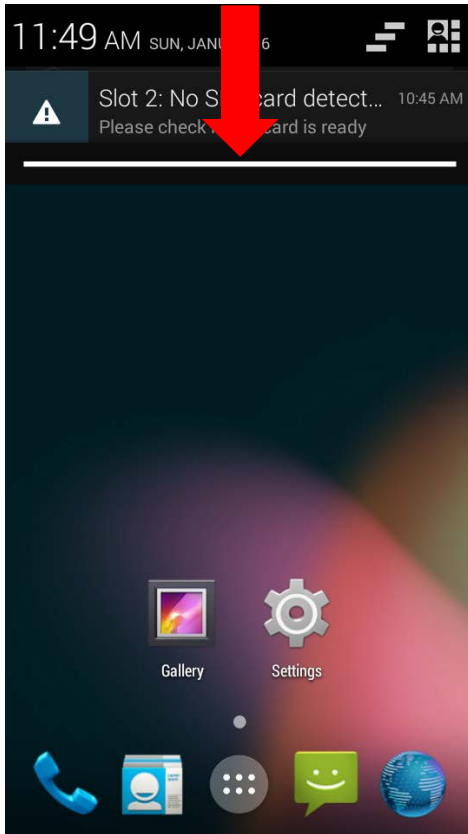

VIEW NOTIFICATIONS

Tap a notification message to enter a page for subsequent activity. The activity required for each notification will differ.

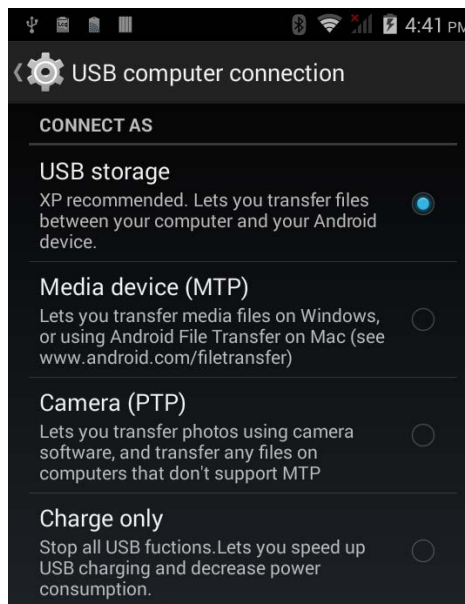
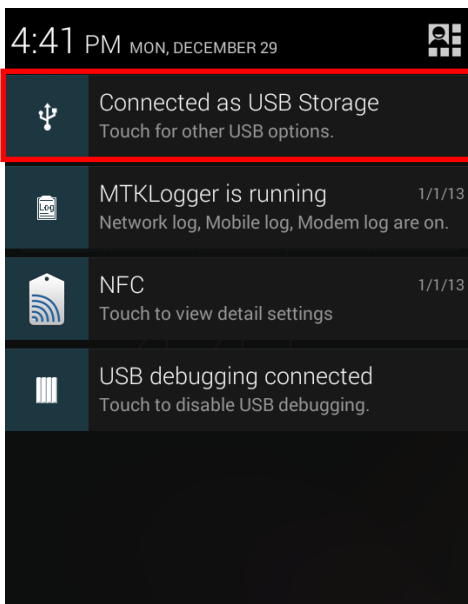

CLEAR NOTIFICATION













Slide each notification sideways to have it cleared. Some notifications will require subsequent activity to be cleared; tap the notification to enter a corresponding settings page for taking further steps.









CLEAR ALL NOTIFICATIONS

Tap  on the status bar to clear all notifications. Ongoing notifications and notifications that require subsequent activity to be cleared will remain in the list.

3.5. APPLICATIONS MENU

Tap  on the Home screen to open the applications menu.

Icon	Name	Description
	Browser	Accesses the internet or intranet.
	Calculator	Performs mathematical calculations.
	Calendar	Creates and manages events, meetings and appointments.
	Camera	Takes pictures and shoots videos.
	Clock	Sets date, time, time zone according to your locale and sets and manages alarms.
	Downloads	List all files downloaded on the mobile computer.
	Email	Sends and receives emails.
	File Manager	Browses and manages files on the local storage and storage card.
	Gallery	Views photos and videos stored on the mobile computer.
	GPS Test	Shows GPS information read from the internal GPS antenna, including GPS signal chart, satellite positions, your current location, speed, direction, altitude, and time read of your current time zone.
	Messaging	Sends SMS and MMS messages.
	Movie Studio	Creates movies with the video files stored on the mobile computer.
	Music	Plays music and audio files stored on the mobile computer and storage card.

	People	Manages contact information, and shares or exports/imports the information to other devices or SD card.
	Phone	Places and receives calls, accesses voicemail, views call history, manages phone contacts and adjusts phone settings.
	Search	Searches the internet and mobile computer with the Google search engine.
	Settings	Opens settings to configure the mobile computer.
	SIM Toolkit	Additional services provided by your mobile carrier.
	Sound Recorder	Records and plays audio information.
	Switch Barcode Service	Enables/Disables the mobile computer's barcode reader service.
	ToDo	Manages tasks to do.
	Videos	Plays video files taken or stored on the mobile computer.

3.6. MANAGE APPLICATIONS

3.6.1. CURRENT APPLICATIONS

Tap and hold the Home button . The screen will show a list of recently used applications.

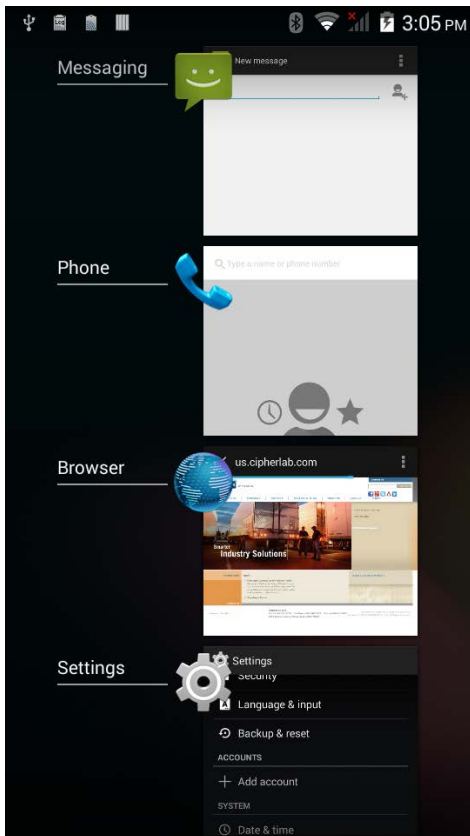

Actions to take on this screen include the following:

SWITCH BETWEEN APPLICATIONS

Tap one of the listed applications to open it on the screen.

END APPLICATION

Slide an application to the left or right to close it.

Note: Close unused applications in order to release RAM. Remember to save your data or settings before closing any application.

3.7. SUSPEND & LOCK

3.7.1. SUSPEND DEVICE

The mobile computer operates continuously once it is powered on. To minimize power consumption, suspend the mobile computer if you are not actively using it. When the mobile computer enters suspension, the system is in a power-saving status and can be quickly awoken to operate as needed.

Lock the mobile computer to prevent unintended operation. When locked, the mobile computer will not respond to screen touch until it is unlocked; volume keys and side buttons will also be unavailable until the device is unlocked.

SUSPEND RS30

The mobile computer is suspended when the power button is pressed, or when the time period set in [Screen Timeout Settings](#) has passed without any activity.

3.7.2. LOCK DEVICE

LOCK RS30

Tap **Home**  | **Settings**  | **Security**  | **Screen lock** to change the lock method.

- ▶ None
- ▶ Slide: Uses the default slide gesture to unlock a locked screen.
- ▶ Voice Unlock: Select a voice command to use for unlocking the screen.
- ▶ Pattern: Enter a pattern to use for unlocking the screen.
- ▶ PIN: Uses the PIN code to unlock a locked screen.
- ▶ Password: Enter a password of at least 4 characters for unlocking the screen.

UNLOCK RS30

When the mobile computer is in suspend mode, pressing the power button will wake it up. If a lock method is set, follow the gestures below to unlock the screen:

- ▶ None
- ▶ Slide: Slide the lock icon in either direction so it relocates outside of the white circle.
- ▶ Voice Unlock: Say the voice command to unlock.
- ▶ Pattern: Swipe the set pattern to unlock.
- ▶ PIN: Enter the PIN code to unlock.
- ▶ Password: Enter the password unlock.

Warning: To save battery power, suspend the mobile computer when not in use.

WIRELESS RADIOS

The Wi-Fi module integrated on the mobile computer lets you configure and connect to network wirelessly.

IN THIS CHAPTER

4.1 Use Wireless Wide Area Network.....	54
4.2 Use Wireless Local Area Network (Wi-Fi)	56
4.3 Use Bluetooth.....	59
4.4 Use Near Field Communications.....	64

4.1. USE WIRELESS WIDE AREA NETWORK

The mobile computer will be automatically configured to connect to your wireless service provider's network when you insert a SIM card and turn on data connection for the first time.

- 1) When a SIM card is inserted, a dialog will appear confirming the mobile carrier detected. By default, data connection is set as "off".

If you would like to change the default settings, tap **Change** to enter the SIM management settings page.

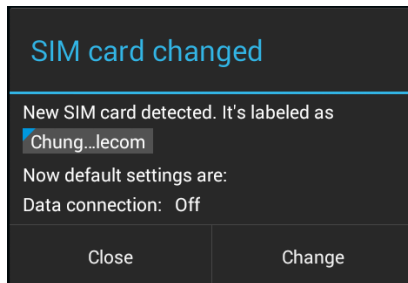



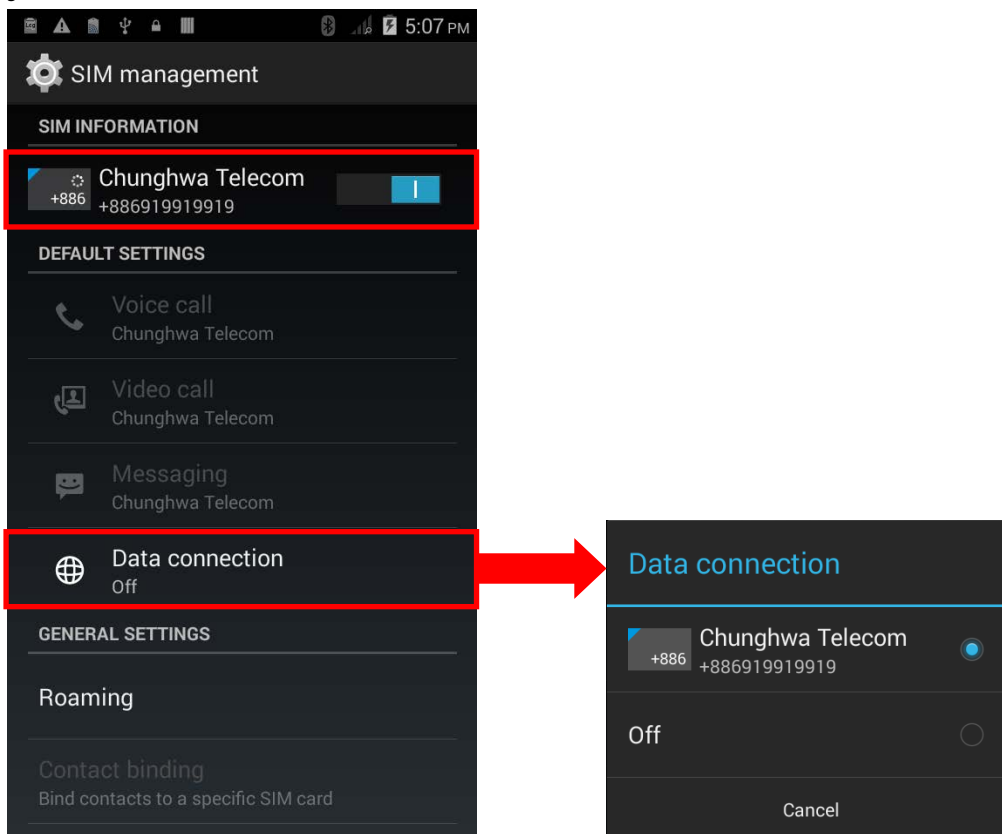

- 2) By default, phone power is turned "on", and data connection is turned "off". To enable mobile data connection, tap **Data connection**, and select the mobile carrier you would like to use.



EDIT ACCESS POINT NAME

You may need to change the access point name according to the information obtained from your mobile carrier.

- 1) Tap **Home**  | **Settings**  | **Mobile networks**.
- 2) On the Network settings page, tap **Access Point Names**.
- 3) Tap the settings button , and tap **New APN** in the pop-up menu.
- 4) Tap each field to input the APN name and settings obtained from your mobile carrier.
- 5) When finished, tap the settings button  and tap **Save**.
- 6) Tap the radio button next to the APN you would like to apply.

4.2. USE WIRELESS LOCAL AREA NETWORK (WI-FI)

4.2.1. POWER ON/OFF WI-FI

To power on Wi-Fi:

- 1) Tap the Wi-Fi icon on the power control widget.



OR

- 1) Tap **Home**  | **Settings** .

- 2) Slide the Wi-Fi switch to the right to turn on Wi-Fi power.

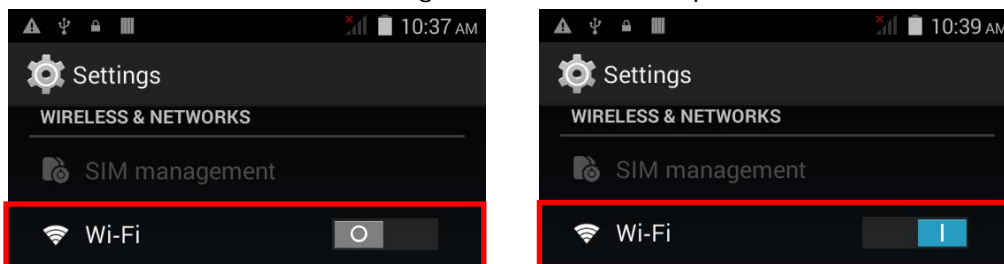

Slide the switch back to turn off Wi-Fi power.

4.2.2. CONNECT TO WI-FI NETWORK

To connect to a Wi-Fi network:

- 1) Tap **Home**  | **Settings**  | **Wi-Fi** .

The Wi-Fi screen shows a list of available Wi-Fi hotspots.

- 2) Tap the network you would like to connect to.

OR

Tap and hold the network to connect, and tap **Connect to network** in the pop-up menu.

- 3) If the network is an open one, the mobile computer will attempt to connect to it directly. When connected, the status will change to show "Connected".

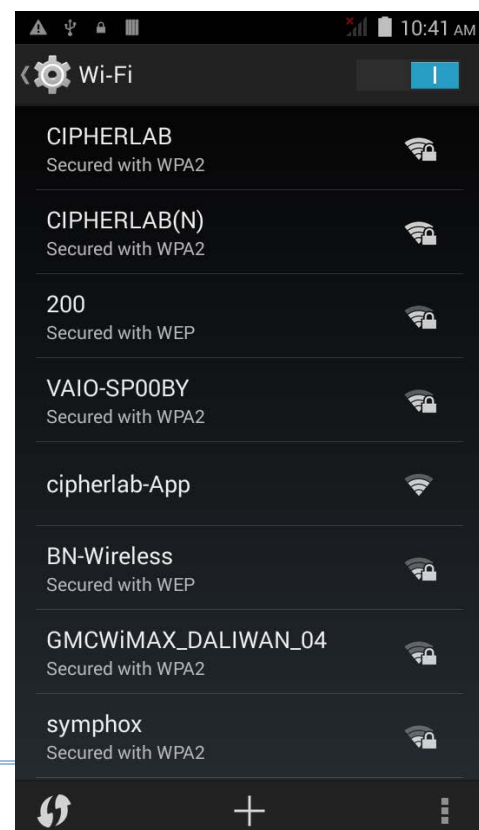

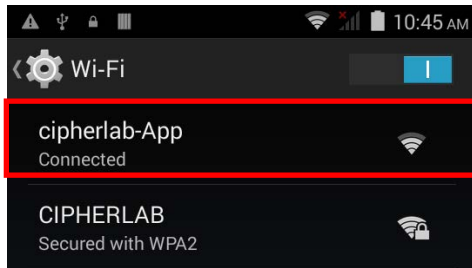

If the network is a secured one, the mobile computer prompts a dialog to enter the password for connection.

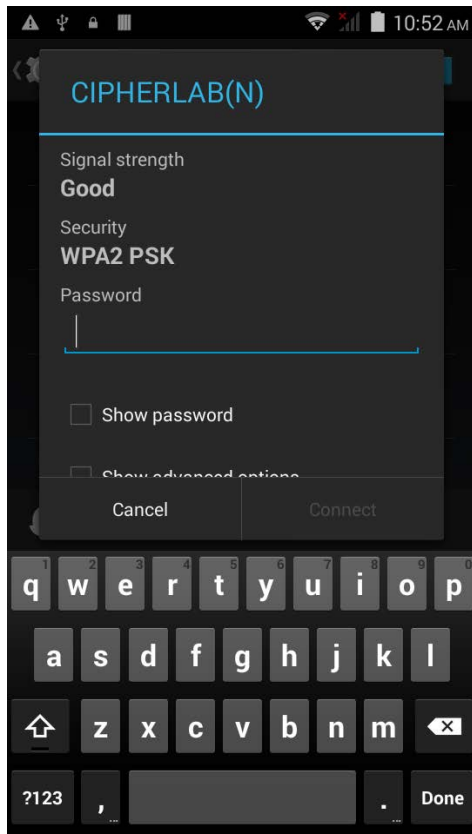

- ▶ For WEP/WPA/WPA2 PSK connections: Enter the required password and tap **Connect**.
- ▶ For 802.1x EAP connections: Check the **Show advanced options** checkbox and select the **EAP method** in the drop-down box (PEAP, TLS, TTLS, PWD, SIM, AKA), and the **Phase 2 authentication** in the drop-down box (None, MSCHAPV2, GTC). Select a **CA certificate** and **User certificate** if required (certificates may be installed under **Home | Settings | Security**.) Enter your username in the **Identity** box and the password in the **Password** box if required.

4.2.3. MANUALLY ADD WI-FI NETWORK

If the network you would like to connect to does not broadcast its SSID, or if the network is out of range, you may add it manually.

- 1) On the Wi-Fi screen, tap the add button  seated at the bottom.
- 2) In the dialog box, enter the name of the network in the **Network SSID** field, and select a security method in the **Security** field (None, WEP, WPA/WPA2 PSK, 802.1x EAP).
 - ▶ For WEP/WPA/WPA2 PSK connections: Enter the required password and tap **Save**.
 - ▶ For 802.1x EAP connections: Check the **Show advanced options** checkbox and select the **EAP method** in the drop-down box (PEAP, TLS, TTLS, PWD, SIM, AKA), and the **Phase 2 authentication** in the drop-down box (None, MSCHAPV2, GTC). Select a **CA certificate** and **User certificate** if required (certificates may be installed under **Home | Settings | Security**.) Enter your username in the **Identity** box and the password in the **Password** box if required.
- 3) If necessary, select the **Proxy** server and **IPv4** settings. By default, no proxy is set and IP settings are set to **DHCP**.

4.3. USE BLUETOOTH

The RS30 Mobile Computer lets you configure Bluetooth settings and manage Bluetooth services provided on remote devices.

4.3.1. BLUETOOTH PROFILES

Bluetooth Profiles Supported

Generic Access Profile	(GAP)	For device discovery and authentication.
Serial Discovery Profile	(SDP)	Discovers services on remote devices.
Serial Port Profile	(SPP)	Sets up a virtual serial port to connect two Bluetooth devices.
Human Interface Device Profile	(HID)	Provides a low latency Bluetooth connection with keyboards, pointing devices, etc.
Object Push Profile	(OPP)	Pushes and pulls objects to and from a push server.
Dial-Up Networking Profile	(DUN)	Accesses the internet and other dial-up services.
Hands-Free Profile	(HFP)	Allows using a hands-free device to place and receive calls.
Advanced Audio Distribution Profile	(A2DP)	Streams stereo-quality audio to a wireless headset or speaker.
Audio/Video Remote Control Profile	(AVRCP)	Allows controlling of television and Hi-Fi equipment.
Generic Object Exchange Profile	(GEOP)	Provides a basis for other data profiles.
Personal Area Networking Profile	(PAN)	Uses Bluetooth Network Encapsulation Protocol for Bluetooth transmission.
General Audio/Video Distribution Profile	(GAVDP)	Provides a basis for A2DP and VDP.
Phone Book Access Profile	(PBAP)	Transfers Phone Book Objects to a car kit to display the information of an incoming call received on the mobile phone, or initiate a call.

4.3.2. POWER ON/OFF BLUETOOTH

To power on Bluetooth:

- 1) Tap the Bluetooth icon on the power control widget.

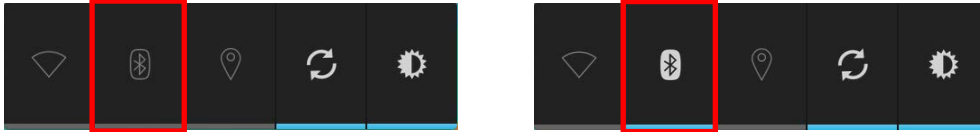

OR

- 1) Tap **Home**  | **Settings** .

- 2) Slide the Bluetooth switch to the right to turn on Bluetooth power.

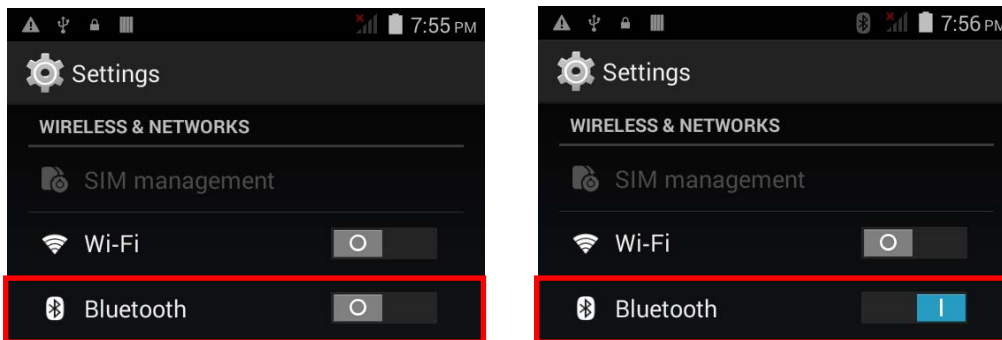



Slide the switch back to turn off Bluetooth power.

Note: After turned on, Bluetooth power is maintained even when the mobile computer is suspended. However, if the power mode is switched to Airplane Mode, Bluetooth power will be turned off regardless of the settings.

4.3.3. SET BLUETOOTH VISIBILITY

To pair Bluetooth devices:

- 1) Tap **Home**  | **Settings**  | **Bluetooth** .
- 2) Tap **Search For Devices** at the bottom of the screen. The screen shows a list of Bluetooth devices nearby.
- 3) By default, Bluetooth visibility is turned off. Tap **ANDROID BT** at the top of the screen to turn on Bluetooth visibility. The status will change to “Visible to all nearby Bluetooth devices”.

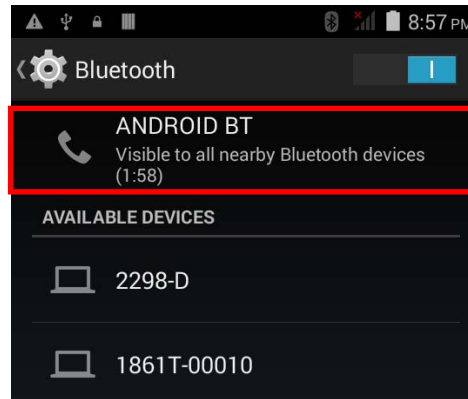
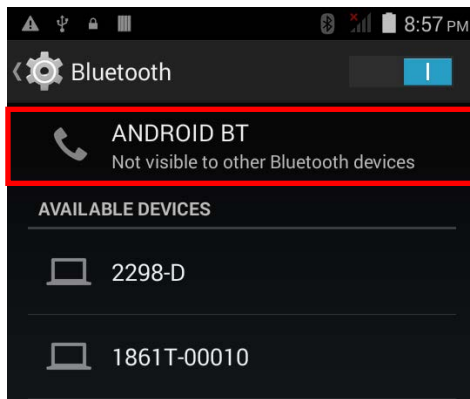

BLUETOOTH VISIBILITY TIMEOUT

To change the timeout period for Bluetooth visibility:

- 1) On the available Bluetooth devices screen, tap  in the bottom right corner.
- 2) Tap **Visibility timeout** in the pop-up menu.
- 3) Select a timeout period for Bluetooth visibility to be automatically turned off.



4.3.4. CHANGE BLUETOOTH NAME

To change the Bluetooth name to make the mobile computer more:

- 1) On the available Bluetooth devices screen, tap  in the bottom right corner.
- 2) Select **Rename phone** in the pop-up menu. Type a new name in the field and tap **Rename**.

4.3.5. PAIR BLUETOOTH DEVICE

To pair Bluetooth devices:

- 1) Tap **Home**  | **Settings**  | **Bluetooth** .
- 2) Tap **Search For Devices** at the bottom of the screen. The screen shows a list of Bluetooth devices nearby.
- 3) Scroll through the list and tap the device you would like to pair.

Note: If the device you would like to pair with is not listed, make sure Bluetooth visibility is enabled on the device.

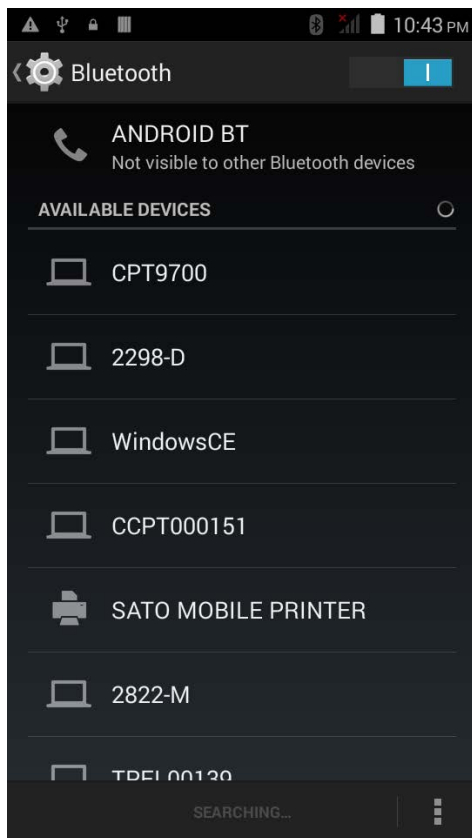

- 4) The **Bluetooth pairing request** window opens. Depending on the pairing settings of the Bluetooth device, you may need to enter a passkey, or confirm the assigned passkey on the device to pair if a smart pairing method is applied.

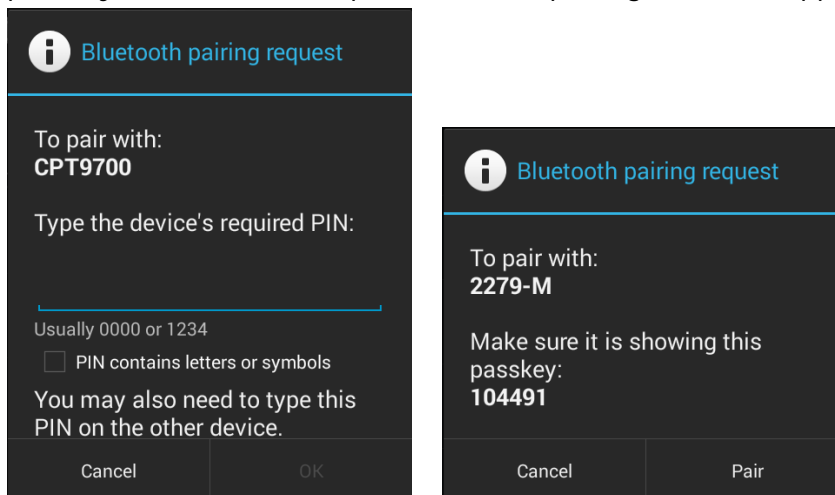

- 5) Enter/confirm the passkey on the device to pair.
- 6) Once pairing is done, the Bluetooth device will be listed in the **Paired Devices** list.

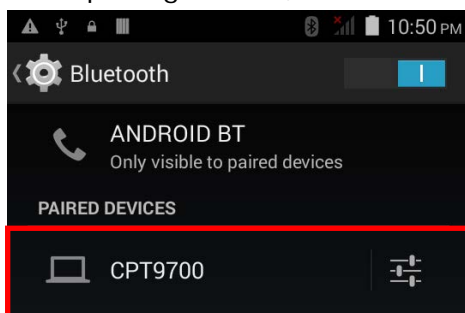

4.3.6. UNPAIR BLUETOOTH DEVICE

To unpair a paired device:

- 1) In the **Paired Devices** list, tap the settings button  next to the paired device.
- 2) On the **Paired Bluetooth device** screen, tap **Unpair**.

4.3.7. SELECT BLUETOOTH SERVICE

To select the service of a paired device:

- 1) In the **Paired Devices** list, tap the settings button  next to the paired device.
- 2) On the **Paired Bluetooth device** screen, check the profile to use.

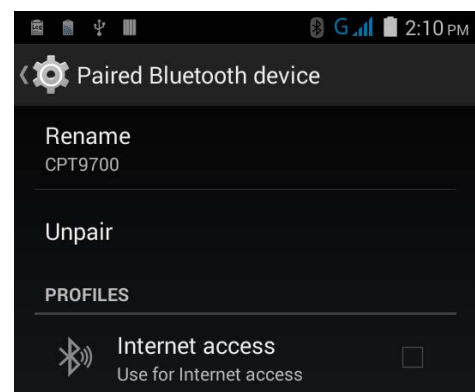

4.4. USE NEAR FIELD COMMUNICATIONS

Near field communications (NFC) uses close proximity (4 cm or less) to establish radio communication through electromagnetic fields. With NFC enabled, the mobile computer can collect information from NFC tags, exchange information with other NFC supported devices, and even change information on the NFC tag if authorized.

Before starting to communicate through NFC, perform the following:

- 1) On the mobile computer, tap **Home**  | **Settings**  | **More...**
- 2) On the Wireless & networks page, make sure the **NFC** switch is enabled.

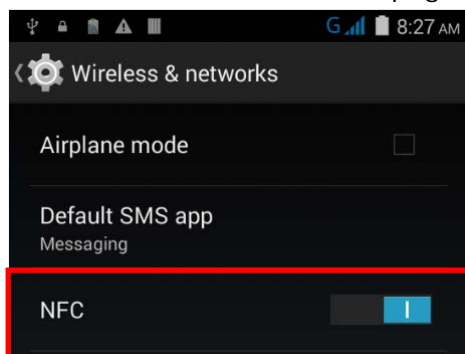

- 3) Tap the **NFC** label to enter the NFC settings page, and tap **Android Beam**.

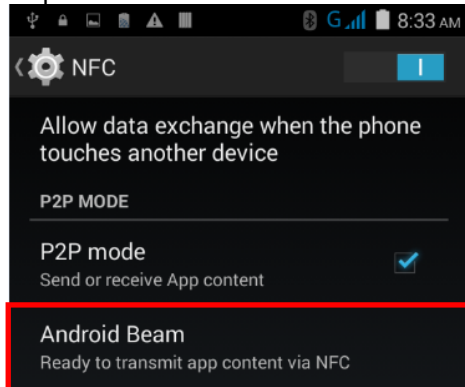

- 4) Make sure the **Android Beam** switch is enabled.

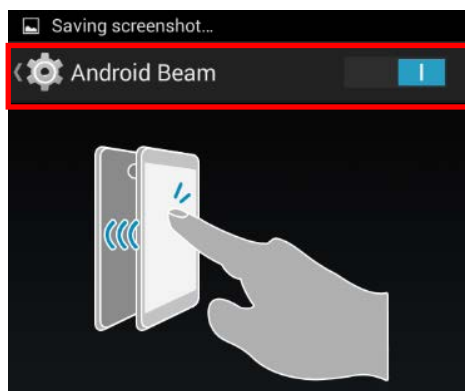

PAIR WITH NFC ENABLED BLUETOOTH DEVICES

- 1) On the device you would like to pair with, make sure NFC is enabled, and Bluetooth discovery is enabled.
- 2) Hold the mobile computer without covering the antenna area above the battery door.
- 3) Move the mobile computer in proximity with the device. A screen notification will appear to indicate that pairing is successful.

SHARE INFORMATION

- 1) Open the web page, video, photo or contact info page you would like to transfer.
- 2) Place the back of the mobile computer in close proximity with the other device you would like to share data with.
- 3) When the two devices connect, a "Touch to beam" notification will appear on the screen.
- 4) Touch the screen to initiate data transfer.

Note: Once the data begins to transfer, the two devices only need to be held within a 10 m (32.8 ft.) range; they no longer have to be held within close range in order to transfer successfully.

COMMUNICATION WITH NFC

- 1) On the mobile computer, launch an NFC enabled application.
- 2) Hold the mobile computer without covering the antenna area above the battery door.
- 3) Place the mobile computer close to the NFC tag or device until the application indicates data transfer is complete.

USING THE PHONE

The RS30 Mobile Computer allows making phone calls and connecting to the network over General Packet Radio Service (GPRS). Insert the SIM card before turning on the power. Refer to [Installing SIM Card](#).

Note: If the SIM card is not in position, you may make emergency calls if the service is supported.

IN THIS CHAPTER

5.1 Phone Power	68
-----------------------	----



5.1. PHONE POWER

The mobile computer accommodates two SIM cards and supports dual standby of two different networks. Both networks will be monitored at the same time, and the phone will dynamically switch between the two networks during usage. Calls will be placed with either one of the networks; you cannot switch networks in the middle of a received call or placed call, or receive or place calls with both networks at the same time.

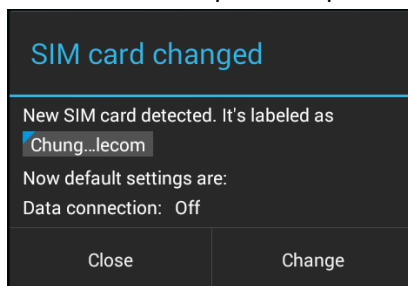
- 1) When a SIM card is installed for the first time, the phone power is turned on automatically when the mobile computer is powered on. A dialog box pops-up when the mobile computer is powered on notifying that a SIM card is detected.



Note: If only one SIM card is installed on the mobile computer, make sure it is installed in the first SIM card slot.

- 2) Tap **Change** in the dialog box.
- 3) The **SIM management** screen opens showing the name of the mobile carrier and the current phone settings.
- 4) To open the **SIM management** screen from other screens, tap **Home**  | **Settings**  | **SIM management** .

Note: If only one SIM card is installed on the mobile computer, make sure it is installed in the first SIM card slot.

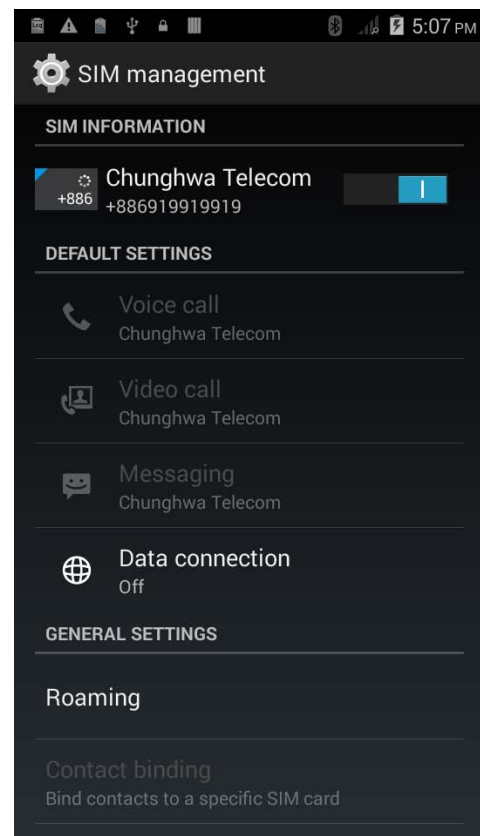

5.1.1. TURN ON/OFF PHONE POWER

To power on the phone:

- 1) On the **SIM management** screen, slide the phone power switch to the right.

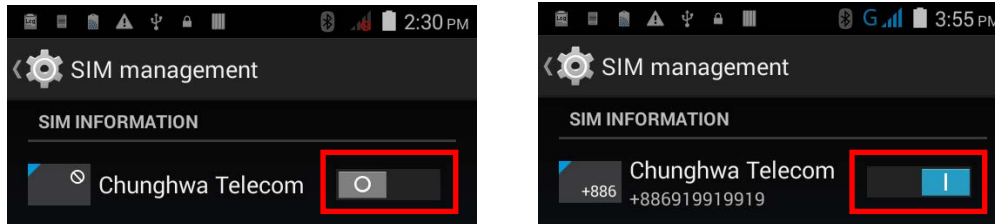

Slide the switch back to turn off Wi-Fi power.

5.1.2. SIM CARD MISSING

If either one of the SIM card slots is empty, a warning icon will be displayed on the status bar.



Open the Notifications list to check the notification.

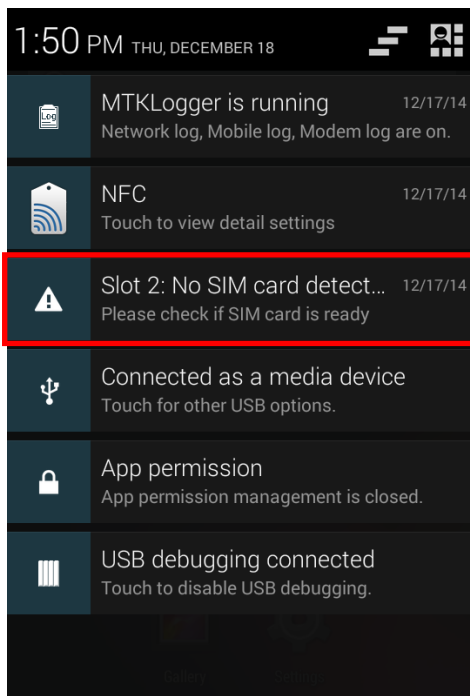

EMERGENCY CALLS

Depending on your service provider, the mobile computer might support making emergency phone call when the SIM card is locked, or even when no SIM card is inserted. Emergency phone numbers will vary by country.

SPECIFICATIONS

PLATFORM, PROCESSOR & MEMORY

Operating System & CPU

OS Version	Android 4.4
CPU	Cortex-A7 1.3 GHz Quad-core

Memory

ROM	8GB NAND flash memory
RAM	1GB RAM
Expansion Slot	One microSD card slot (up to 32GB) ▶ SDXC supported

COMMUNICATION & DATA CAPTURE

Communication

USB Client	USB 2.0 OTG
WPAN	Bluetooth Class II, v4.0 & v2.1 EDR
WLAN	IEEE 802.11b/g/n networking
WWAN	Built-in module for HSPA+/Quadband GSM/WCDMA850/900/1900/2100/HSPA+ GPRS/EDGE/WCDMA/HSPA Frequency band: WCDMA 850/900/1900/2100 HSPA+ 14.4 Mbps/5.76 Mbps
GPS	Built-in GPS with AGPS support, ephemeris downloadable

Data & Image Capture

Digital Camera	8 Mega pixels with user-controllable flash	
Barcode Reader	Ordering options include	<ul style="list-style-type: none"> ▶ Linear Imager (SM1) ▶ 1D Laser (SE955) ▶ 2D Imager (SE4500)
HF RFID Reader	ISO14443A/B (Mifare), ISO15693 (Felica)	
	<ul style="list-style-type: none"> ▶ Supports NFC (Peer-to-peer, Card reader, Card emulation) 	

ELECTRICAL CHARACTERISTICS

Batteries

Main Battery Pack	Rechargeable Li-ion battery – 3.8V, 3100 mAh	
	Charging time: 4 hours	
Backup Battery Pack	Rechargeable Li-ion battery – 4.2 V, 70 mAh	
	Data retention for 30 minutes	
	Charging time: 4 hours	

Power Adaptor

Power Supply Cord with	Input	AC 100~240 V, 50/60 Hz
Universal Power Adaptor	Output	DC 5 V, 2 A

Working Time

Supports working time for up to 8-10 hours.

PHYSICAL CHARACTERISTICS**Color Touch Screen Display**

Display	4.7" Transmissive IPS LCD, 510 NITS, Corning Gorilla Glass 3
Resolution	QVGA (960 x 540 pixels)

Notifications

Status LED	Single LED which lights red when charging, green when charging is complete, and blue when wireless radio is on
Audio	Integrated with one speaker, dual array digital microphones with echo and noise cancellation

Dimensions & Weight

Dimensions	155 mm (L) x 80mm (W) x 15.3 (H)
Weight	250 g (Laser, including battery)

ENVIRONMENTAL CHARACTERISTICS

Temperature

Operating	-20 °C to 50 °C
Storage	-30 °C to 70 °C (transmissive)
Charging	0°C to 40°C

Humidity

Operating	10% to 90% (non-condensing)
Storage	5% to 95% (non-condensing)

Resistance

Impact Resistance	<p>With protective boot:</p> <p>Multiple drops onto concrete at 1.2 m (4 ft.) on all six sides</p> <p>Without protective boot:</p> <p>Multiple drops onto concrete at 1.5 m (5 ft.) on all six sides</p>
Tumble Test	<p>With protective boot:</p> <p>500 tumbles (1000 drops) at 0.5 m per applicable IEC tumble specifications</p> <p>Without protective boot:</p> <p>150 tumbles (300 drops) at 0.5 m per applicable IEC tumble specifications</p>
Splash/Dust Resistance	IP54 per applicable IEC sealing specifications
Electrostatic Discharge	±15 kV air discharge, ±8 kV contact discharge

PROGRAMMING SUPPORT

Development Environment & Tools

Integrated Environment	Development	Visual Studio 2008
		Visual Studio 2005
Software Development Kit		Microsoft SDK
		Reader API (DLL) for reader configuration

Software & Utilities

CipherLab Software Package	▶ Reader Configuration
Third-party Software	▶ Kalipso

ACCESSORIES

Accessory Options

- ▶ Charging Cradle

This phone has been tested and rated for use with hearing aids for some of the wireless technologies that it uses. However, there may be some newer wireless technologies used in this phone that have not been tested yet for use with hearing aids. It is important to try the different features of this phone thoroughly and in different locations, using your hearing aid or cochlear implant, to determine if you hear any interfering noise. Consult your service provider or the manufacturer of this phone for information on hearing aid compatibility. If you have questions about return or exchange policies, consult your service

To determine the compatibility of a WD and a particular hearing aid, simply add the numerical part of the hearing aid category (e.g. M2/T2=2) with the numerical part of the WD emission rating (e.g., M3=3) to arrive at the system classification for this particular combination of WD and hearing aid. A sum of 5 would indicate that the WD and hearing aid would provide normal use, and a sum of 6 or greater would indicate that the WD and hearing aid would provide excellent performance. A category sum of less than 4 would likely result in a performance that is judged unacceptable by the hearing aid user.

WHAT IS HEARING AID COMPATIBILITY?

The Federal Communications Commission has implemented rules and a rating system designed to enable people who wear hearing aids to more effectively use these wireless telecommunications devices. The standard for compatibility of digital wireless phones with hearing aids is set forth in American National Standard Institute (ANSI) standard C63.19. There are two sets of ANSI standards with ratings from one to four (four being the best rating): an "M" rating for reduced interference making it easier to hear conversations on the phone when using the hearing aid microphone, and a "T" rating that enables the phone to be used with hearing aids operating in the telecoil mode thus reducing unwanted background noise.

HOW WILL I KNOW WHICH WIRELESS PHONES ARE HEARING AID COMPATIBLE?

The Hearing Aid Compatibility rating is displayed on the wireless phone box.

A phone is considered Hearing Aid Compatible for acoustic coupling (microphone mode) if it has an "M3" or "M4" rating. A digital wireless phone is considered Hearing Aid Compatible for inductive coupling (telecoil mode) if it has a "T3" or "T4" rating.

The tested M-Rating and T-Rating for this device (FCC ID: Q3N-RS30) are M3 and T3.

HOW WILL I KNOW IF MY HEARING AID WILL WORK WITH A PARTICULAR DIGITAL WIRELESS PHONE?

You'll want to try a number of wireless phones so that you can decide which works the best with your hearing aids. You may also want to talk with your hearing aid professional about the extent to which your hearing aids are immune to interference, if they have wireless phone shielding, and whether your hearing aid has a HAC rating.