



FCC PART 22/24 TEST REPORT

FCC Part 22 /Part 24

Report Reference No..... : TRE1311003802 R/C: 19534

FCC ID..... : Q34-S100

Compiled by

(position+printed name+signature) : File administrators Jerome Luo

Supervised by

(position+printed name+signature) : Test Engineer Yuchao Wang

Approved by

(position+printed name+signature) : Manager Wenliang Li

Date of issue..... : Nov 23, 2013

Testing Laboratory Name : Shenzhen Huatongwei International Inspection Co., Ltd

Address..... : Keji Nan No.12 Road, Hi-tech Park, Shenzhen, China

Applicant's name : Star Computer Group

Address..... : 2175 NORTHWEST 115TH AVE. DORAL FL 33172, USA

Test specification:

Standard : **FCC Part 22: PUBLIC MOBILE SERVICES**
: **FCC Part 24: PERSONAL COMMUNICATIONS SERVICES**

TRF Originator..... : Shenzhen Huatongwei International Inspection CO., Ltd

Master TRF..... : Dated 2006-06

Shenzhen Huatongwei International Inspection Co., Ltd. All rights reserved.

This publication may be reproduced in whole or in part for non-commercial purposes as long as the Shenzhen Huatongwei International Inspection Co., Ltd is acknowledged as copyright owner and source of the material. Shenzhen Huatongwei International Inspection Co., Ltd takes no responsibility for and will not assume liability for damages resulting from the reader's interpretation of the reproduced material due to its placement and context.

Test item description : Mobile phone

Trade Mark : Argom

Manufacturer : **Star Computer Group**

Model/Type reference..... : S100

Listed Models : /

Ratings..... : DC 3.70V

Modulation : QPSK

Hardware version : S100_V003

Software version : 3.4.5

Android version : 4.2.2

Frequency..... : FDD WCDMA Band II,FDD WCDMA Band V

Result..... : **PASS**

T E S T R E P O R T

Test Report No. :	TRE1311003802	Nov 23, 2013
		Date of issue

Equipment under Test : Mobile Phone

Model /Type : S100

Listed Models : /

Applicant : **Star Computer Group**

Address : 2175 NORTHWEST 115TH AVE. DORAL FL 33172, USA

Manufacturer : **Star Computer Group**

Address : 2175 NORTHWEST 115TH AVE. DORAL FL 33172, USA

Test Result	PASS
--------------------	-------------

The test report merely corresponds to the test sample.
It is not permitted to copy extracts of these test result without the written permission of the test laboratory.

Contents

1.	<u>TEST STANDARDS</u>	4
2.	<u>SUMMARY</u>	5
2.1.	General Remarks	5
2.2.	Product Description	5
2.3.	Equipment under Test	5
2.4.	Short description of the Equipment under Test (EUT)	6
2.5.	Internal Identification of EUT used during the test	6
2.6.	Internal Identification of AE used during the test	6
2.7.	Normal Accessory setting	6
2.8.	EUT configuration	6
2.9.	Related Submittal(s) / Grant (s)	6
2.10.	Modifications	7
2.11.	Note	7
3.	<u>TEST ENVIRONMENT</u>	8
3.1.	Address of the test laboratory	8
3.2.	Test Facility	8
3.3.	Environmental conditions	9
3.4.	Statement of the measurement uncertainty	9
3.5.	Test Description	9
3.6.	Equipments Used during the Test	10
4.	<u>TEST CONDITIONS AND RESULTS</u>	11
4.1.	Conducted Emissions Test	11
4.2.	OUTPUT POWER	20
4.3.	Radiated Spurious Emssion	23
4.4.	OCCUPIED BANDWIDTH	27
4.5.	EMISSION BANDWIDTH	32
4.6.	BAND EDGE COMPLIANCE	37
4.7.	Spurious Emssion on Antenna Port	41
4.8.	Frequency Stability Test	64
5.	<u>TEST SETUP PHOTOS OF THE EUT</u>	66
6.	<u>EXTERNAL AND INTERNAL PHOTOS OF THE EUT</u>	68

1. TEST STANDARDS

The tests were performed according to following standards:

[FCC Part 22 \(10-1-12 Edition\)](#): PRIVATE LAND MOBILE RADIO SERVICES.

[FCC Part 24\(10-1-12 Edition\)](#): PUBLIC MOBILE SERVICES

[TIA/EIA 603 D June 2010](#): Land Mobile FM or PM Communications Equipment Measurement and Performance Standards.

[47 CFR FCC Part 15 Subpart B](#): - Unintentional Radiators

[FCC Part 2](#): FREQUENCY ALLOCA-TIONS AND RADIO TREATY MAT-TERS; GENERAL RULES AND REG-ULATIONS

[KDB971168 D01:201](#): Procedures for Compliance Measurement of the Fundamental Emission Power of Licensed Wideband (> 1 MHz) Digital Transmission Systems

[ANSI C63.4:2009](#): Methods of Measurement of Radio-Noise Emissions from Low-Voltage Electrical and Electronic Equipment in the Range of 9 kHz to 40 GHz

2. SUMMARY

2.1. General Remarks

Date of receipt of test sample	:	Oct 11, 2013
Testing commenced on	:	Oct 12, 2013
Testing concluded on	:	Nov 23, 2013

2.2. Product Description

The **Star Computer Group's** Model: S100 or the "EUT" as referred to in this report; more general information as follows, for more details, refer to the user's manual of the EUT.

Name of EUT	Mobile Phone
Model Number	S100
FCC ID	Q34-S100
Modulation Type	QPSK for WCDMA, GMSK for GSM/GPRS/EDGE
Antenna Type	Internal
Hardware version	S100_V003
Software version	3.4.5
Android version	4.2.2
GSM/EDGE/GPRS	Supported GSM/GPRS/EDGE
WCDMA Operation Frequency Band	FDD Band II, FDD Band V
HSDPA Release Version	Release 8
HSUPA Release Version	Release 6
WCDMA Release Version	R99
Extreme temp. Tolerance	-30°C to +60°C
Extreme vol. Limits	3.40VDC to 4.20VDC (nominal: 3.70VDC)
GSM/GPRS Operation Frequency Band	GSM850/PCS1900
GSM Release Version	R99
GPRS operation mode	Class B
GPRS Multislot Class	12
EGPRS Multislot Class	12

2.3. Equipment under Test

Power supply system utilised

Power supply voltage	:	<input type="radio"/> 120V / 60 Hz	<input type="radio"/> 115V / 60Hz
		<input type="radio"/> 12 V DC	<input type="radio"/> 24 V DC
		<input checked="" type="radio"/> Other (specified in blank below)	

DC 3.70V

Test frequency list

Modulation Type	Test Channel	Channel Number	Test Frequency
FDD Band II	Low	9262	1852.4 MHz
	Middle	9400	1880.0 MHz
	High	9538	1907.6 MHz
FDD Band V	Low	4132	826.40 MHz
	Middle	4182	836.60 MHz
	High	4233	846.60 MHz

2.4. Short description of the Equipment under Test (EUT)

The Equipment Under Test (EUT) is a model of Mobile Phone with

WCDMA/HSUPA/HSDPA/GPRS/GSM,WLAN and Bluetooth function and integrated antenna. Manual and specifications of the EUT were provided to fulfil the test.

Samples undergoing test were selected by the Client.

2.5. Internal Identification of EUT used during the test

SN or IMEI	HW Version	SW Version
354718041824829	S100_V003	3.4.5
354718041824853	S100_V003	3.4.5
354718041824814	S100_V003	3.4.5

2.6. Internal Identification of AE used during the test

AE ID*	Description
AE1	Battery
AE2	Charger and USB cable

AE1

Model:S100
 Manufacturer: Star Computer Group
 Capacitance: 2600mAh
 Nominal Voltage:3.70V

AE2:

Model: S100
 Manufacturer: Star Computer Group
 Input: 100-240V~50/60Hz 0.15A
 Output: OUTPUT: 5.0V DC 1.0A
 Power Cable Length: 96cm
 Shielded Unshielded

*AE ID: is used to identify the test sample in the lab internally.

2.7. Normal Accessory setting

Fully charged battery was used during the test.

2.8. EUT configuration

The following peripheral devices and interface cables were connected during the measurement:

- supplied by the manufacturer

- supplied by the lab

<input type="radio"/>	Power Cable	Length (m) :	/
		Shield :	/
		Detachable :	/
<input type="radio"/>	Multimeter	Manufacturer :	/
		Model No. :	/

2.9. Related Submittal(s) / Grant (s)

This submittal(s) (test report) is intended for FCC ID: **Q34-S100** filing to comply with FCC Part 22 and Part 24 Rules

2.10. Modifications

No modifications were implemented to meet testing criteria.

2.11. Note

1. The EUT is a Mobile Phone WCDMA/HSUPA/HSDPA/GPRS/GSM,WLAN and Bluetooth function,The functions of the EUT listed as below:

	Test Standards	Reference Report
GSM/GPRS/EGPRS	FCC Part 22/FCC Part 24	TRE1311003801
WCDMA/HSUPA/HSDPA	FCC Part 22/FCC Part 24	TRE1311003802
WLAN	FCC Part 15 C 15.247	TRE1311003803
Bluetooth v2.1	FCC Part 15 C 15.247	TRE1311003804
Bluetooth 4.0	FCC Part 15 C 15.247	TRE1311003805
USB Port	FCC Part 15 B	TRE1311003806
SAR	FCC Part 2 §2.1093	TRE1311003807

3. TEST ENVIRONMENT

3.1. Address of the test laboratory

Shenzhen Huatongwei International Inspection Co., Ltd
Keji Nan No.12 Road, Hi-tech Park, Shenzhen, China
Phone: 86-755-26715686 Fax: 86-755-26748089

The sites are constructed in conformance with the requirements of ANSI C63.7, ANSI C63.4 (2009) and CISPR Publication 22.

3.2. Test Facility

The test facility is recognized, certified, or accredited by the following organizations:

CNAS-Lab Code: L1225

Shenzhen Huatongwei International Inspection Co., Ltd has been assessed and proved to be in compliance with CNAS-CL01 Accreditation Criteria for Testing and Calibration Laboratories (identical to ISO/IEC 17025: 2005 General Requirements) for the Competence of Testing and Calibration Laboratories, Date of Registration: Mar 01, 2012. Valid time is until Feb 28, 2015.

A2LA-Lab Cert. No. 2243.01

Shenzhen Huatongwei International Inspection Co., Ltd, EMC Laboratory has been accredited by A2LA for technical competence in the field of electrical testing, and proved to be in compliance with ISO/IEC 17025: 2005 General Requirements for the Competence of Testing and Calibration Laboratories and any additional program requirements in the identified field of testing. Valid time is until Sept 30, 2015.

FCC-Registration No.: 662850

Shenzhen Huatongwei International Inspection Co., Ltd, EMC Laboratory has been registered and fully described in a report filed with the FCC (Federal Communications Commission). The acceptance letter from the FCC is maintained in our files. Registration 662850, Renewal date June 01, 2015.

IC-Registration No.: 5377

The 3m Alternate Test Site of Shenzhen Huatongwei International Inspection Co., Ltd has been registered by Certification and Engineering Bureau of Industry Canada for the performance of radiated measurements with Registration No. 5377 on Jan 25, 2011. Valid time is until Jan 24, 2014

ACA

Shenzhen Huatongwei International Inspection Co., Ltd, EMC Laboratory can also perform testing for the Australian C-Tick mark as a result of our A2LA accreditation.

VCCI

The 3m Semi-anechoic chamber (12.2m×7.95m×6.7m) and Shielded Room (8m×4m×3m) of Shenzhen Huatongwei International Inspection Co., Ltd has been registered in accordance with the Regulations for Voluntary Control Measures with Registration No.: R-2484. Date of Registration: December 20, 2009. Valid time is until December 19, 2013.

Main Ports Conducted Interference Measurement of Shenzhen Huatongwei International Inspection Co., Ltd has been registered in accordance with the Regulations for Voluntary Control Measures with Registration No.: C-2726. Date of Registration: December 20, 2009. Valid time is until December 19, 2013.

DNV

Shenzhen Huatongwei International Inspection Co Ltd has been found to comply with the requirements of DNV towards subcontractor of EMC and safety testing services in conjunction with the EMC and Low voltage Directives and in the voluntary field. The acceptance is based on a formal quality Audit and follow-ups according to relevant parts of ISO/IEC Guide 17025(2005), in accordance with the requirements of the DNV Laboratory Quality Manual towards subcontractors. Valid time is until Aug 24, 2016.

3.3. Environmental conditions

During the measurement the environmental conditions were within the listed ranges:

Temperature:	15-35 ° C
Humidity:	30-60 %
Atmospheric pressure:	950-1050mbar

3.4. Statement of the measurement uncertainty

The data and results referenced in this document are true and accurate. The reader is cautioned that there may be errors within the calibration limits of the equipment and facilities. The measurement uncertainty was calculated for all measurements listed in this test report acc. to CISPR 16 - 4 „Specification for radio disturbance and immunity measuring apparatus and methods – Part 4: Uncertainty in EMC Measurements“ and is documented in the Shenzhen Huatongwei International Inspection Co., Ltd quality system acc. to DIN EN ISO/IEC 17025. Furthermore, component and process variability of devices similar to that tested may result in additional deviation. The manufacturer has the sole responsibility of continued compliance of the device.

Hereafter the best measurement capability for Shenzhen Huatongwei laboratory is reported:

Test Items	Measurement Uncertainty	Notes
Frequency stability	25 Hz	(1)
Transmitter power conducted	0.57 dB	(1)
Transmitter power Radiated	2.20 dB	(1)
Conducted spurious emission 9KHz-12.75 GHz	1.60 dB	(1)
Conducted Emission 9KHz-30MHz	3.39 dB	(1)
Radiated Emission 30~1000MHz	4.24 dB	(1)
Radiated Emission 1~18GHz	5.16 dB	(1)
Radiated Emission 18-40GHz	5.54 dB	(1)
Occupied Bandwidth	-----	(1)
Emission Mask	-----	(1)
Modulation Characteristic	-----	(1)
Transmitter Frequency Behavior	-----	(1)

- (1) This uncertainty represents an expanded uncertainty expressed at approximately the 95% confidence level using a coverage factor of k=1.96.

3.5. Test Description

Test Items	Clause in FCC rules	Verdict
Conducted Emission	15.107/15.207	PASS
Output Power	22.913(a)/24.232(c)	PASS
Radiated Spurious Emission	2.1051/22.917/24.238	PASS
Frequency Stability	2.1055/24.235	PASS
Occupied Bandwidth	2.1049(h)(i)	PASS
Emission Bandwidth	22.917(b)/24.238(b)	PASS
Band Edge Compliance	22.917(b)/24.238(b)	PASS
Conducted Spurious Emission	2.1057/22.917/24.238	PASS

Remark:

1. The measurement uncertainty is not included in the test result.

3.6. Equipments Used during the Test

AC Power Conducted Emission					
No.	Equipment	Manufacturer	Model No.	Serial No.	Last Cal.
1	Artificial Mains	Rohde&Schwarz	ESH2-Z5	100028	2013/10/26
2	EMI Test Receiver	Rohde&Schwarz	ESCS 30	100038	2013/10/26
3	Pulse Limiter	Rohde&Schwarz	ESHSZ2	100044	2013/10/26
4	EMI Test Software	Rohde&Schwarz	ES-K1 V1.71	N/A	N/A
5	UNIVERSAL RADIO COMMUNICATION	Rohde&Schwarz	CMU200	112012	2013/10/26

Output Power(Conducted) & Occupied Bandwidth & Emission Bandwidth & Band Edge Compliance & Conducted Spurious Emission					
No.	Equipment	Manufacturer	Model No.	Serial No.	Last Cal.
1	UNIVERSAL RADIO COMMUNICATION	Rohde&Schwarz	CMU200	112012	2013/10/26
2	Spectrum Analyzer	Rohde&Schwarz	FSU26	201141	2013/10/26
3	Splitter	Mini-Circuit	ZAPD-4	400059	2013/10/26

Frequency Stability					
No.	Equipment	Manufacturer	Model No.	Serial No.	Last Cal.
1	UNIVERSAL RADIO COMMUNICATION	Rohde&Schwarz	CMU200	112012	2013/10/26
2	Spectrum Analyzer	Rohde&Schwarz	FSU26	201141	2013/10/26
3	Climate Chamber	ESPEC	EL-10KA	05107008	2013/10/26
4	Splitter	Mini-Circuit	ZAPD-4	400059	2013/10/26

Output Power (Radiated) & Radiated Spurious Emission					
No.	Equipment	Manufacturer	Model No.	Serial No.	Last Cal.
1	UNIVERSAL RADIO COMMUNICATION	Rohde&Schwarz	CMU200	112012	2013/10/26
2	Spectrum Analyzer	Rohde&Schwarz	FSU26	201141	2013/10/26
3	HORN ANTENNA	ShwarzBeck	9120D	1012	2013/10/26
4	HORN ANTENNA	ShwarzBeck	9120D	1011	2013/10/26
5	Ultra-Broadband Antenna	ShwarzBeck	VULB9163	538	2013/10/26
6	Ultra-Broadband Antenna	ShwarzBeck	VULB9163	539	2013/10/26
7	TURNTABLE	MATURO	TT2.0	----	N/A
8	ANTENNA MAST	MATURO	TAM-4.0-P	----	N/A
9	EMI Test Software	Audix	E3	N/A	N/A
10	EMI Test Receiver	Rohde&Schwarz	ESIB 26	100009	2013/10/26
11	RF Test Panel	Rohde&Schwarz	TS / RSP	335015/ 0017	N/A
12	High pass filter	Compliance Direction systems	BSU-6	34202	2013/10/26
13	Splitter	Mini-Circuit	ZAPD-4	400059	2013/10/26
14	Horn Antenna	SCHWARZBECK	BBHA9170	25841	2013/10/26
15	Horn Antenna	SCHWARZBECK	BBHA9170	25842	2013/10/26
16	Preamplifier	ShwarzBeck	BBV 9718	BBV 9718	2013/10/26
17	Broadband Preamplifier	ShwarzBeck	BBV743	9743-0079	2013/10/26
18	Signal Generator	Rohde&Schwarz	SMF100A	101932	2013/10/26
19	Amplifier	Compliance Direction systems	PAP1-4060	120	2013/10/26
20	TURNTABLE	ETS	2088	2149	N/A
21	ANTENNA MAST	ETS	2075	2346	N/A
22	HORN ANTENNA	Rohde&Schwarz	HF906	100068	2013/10/26
23	HORN ANTENNA	Rohde&Schwarz	HF906	100039	2013/10/26

The calibration interval was one year.

4. TEST CONDITIONS AND RESULTS

4.1. Conducted Emissions Test

TEST APPLICABLE

The EUT was tested according to ANSI C63.4 - 2009. The frequency spectrum from 0.15 MHz to 30 MHz was investigated. The LISN used was 50 ohm / 50 u Henry as specified by section 5.1 of ANSI C63.4 - 2009. Cables and peripherals were moved to find the maximum emission levels for each frequency.

TEST CONFIGURATION

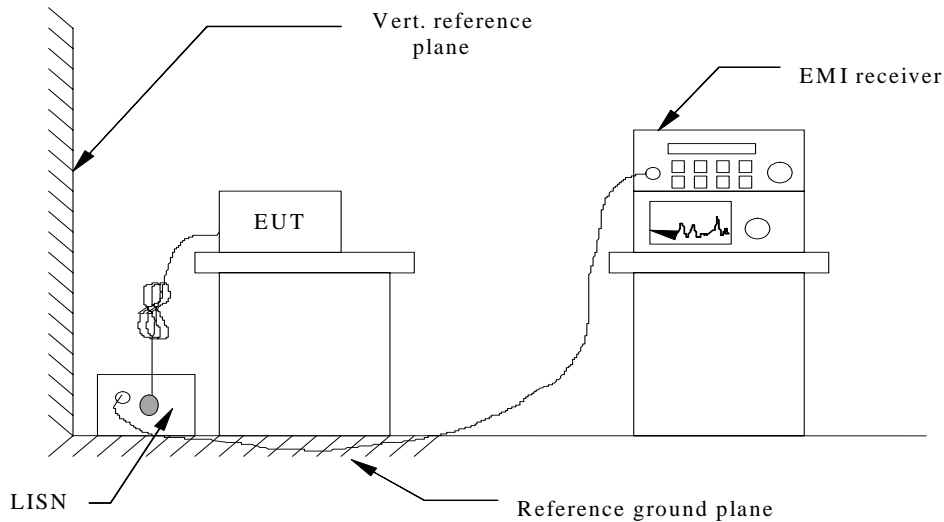

TEST PROCEDURE

1. The equipment was set up as per the test configuration to simulate typical actual usage per the user's manual. The EUT is a tabletop system; a wooden table with a height of 0.8 meters is used and is placed on the ground plane as per ANSI C63.4-2009.
2. Support equipment, if needed, was placed as per ANSI C63.4-2009.
3. All I/O cables were positioned to simulate typical actual usage as per ANSI C63.4-2009.
4. If EUT received DC power from the adapter, the adapter received AC120V/60Hz power through a Line Impedance Stabilization Network (LISN) which supplied power source and was grounded to the ground plane.
5. All support equipments received AC power from a second LISN, if any.
6. The EUT test program was started. Emissions were measured on each current carrying line of the EUT using a spectrum Analyzer / Receiver connected to the LISN powering the EUT. The LISN has two monitoring points: Line 1 (Hot Side) and Line 2 (Neutral Side). Two scans were taken: one with Line 1 connected to Analyzer / Receiver and Line 2 connected to a 50 ohm load; the second scan had Line 1 connected to a 50 ohm load and Line 2 connected to the Analyzer / Receiver.
7. Analyzer / Receiver scanned from 150 KHz to 30MHz for emissions in each of the test modes.
8. During the above scans, the emissions were maximized by cable manipulation.

Conducted Power Line Emission Limit

For unintentional device, according to § 15.107(a) Line Conducted Emission Limits is as following :

Frequency (MHz)	Maximum RF Line Voltage (dBµV)			
	CLASS A		CLASS B	
	Q.P.	Ave.	Q.P.	Ave.
0.15 - 0.50	79	66	66-56*	56-46*
0.50 - 5.00	73	60	56	46
5.00 - 30.0	73	60	60	50

* Decreasing linearly with the logarithm of the frequency

For intentional device, according to §15.207(a) Line Conducted Emission Limit is same as above table.

TEST RESULTS

WCDMA Band II-AE2

SCAN TABLE: "Voltage (9K-30M) FIN"

Short Description: 150K-30M Voltage

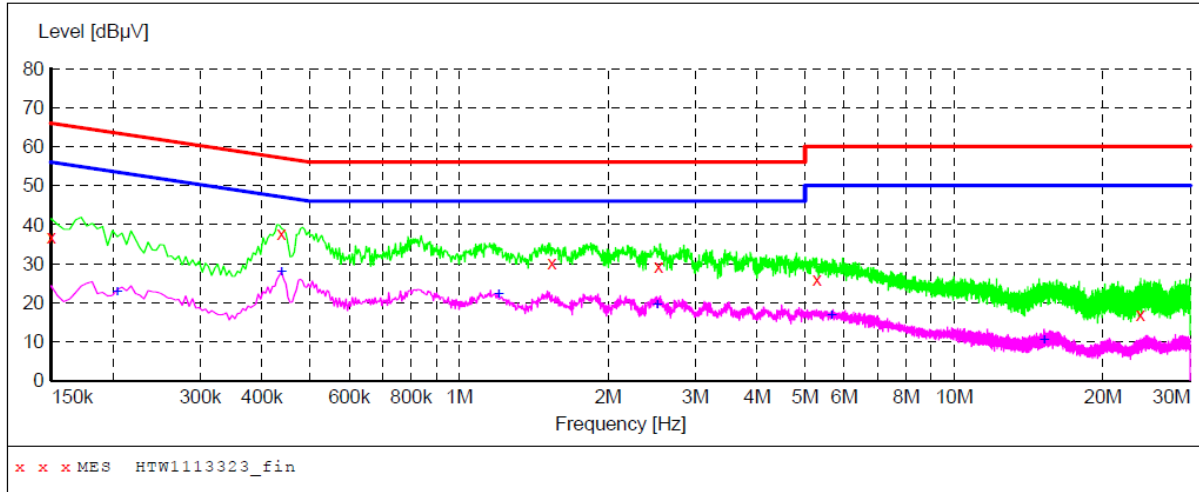

MEASUREMENT RESULT: "HTW1113323_fin"

11/13/2013 2:56PM

Frequency MHz	Level dBµV	Transd dB	Limit dBµV	Margin dB	Detector	Line	PE
0.150000	37.00	10.1	66	29.0	QP	L1	GND
0.438000	37.60	10.1	57	19.5	QP	L1	GND
1.540500	30.30	10.3	56	25.7	QP	L1	GND
2.530500	29.40	10.3	56	26.6	QP	L1	GND
5.284500	25.90	10.3	60	34.1	QP	L1	GND
23.802000	16.90	11.0	60	43.1	QP	L1	GND

MEASUREMENT RESULT: "HTW1113323_fin2"

11/13/2013 2:56PM

Frequency MHz	Level dBµV	Transd dB	Limit dBµV	Margin dB	Detector	Line	PE
0.204000	22.60	10.1	53	30.8	AV	L1	GND
0.438000	27.80	10.1	47	19.3	AV	L1	GND
1.203000	22.10	10.3	46	23.9	AV	L1	GND
2.512500	19.40	10.3	46	26.6	AV	L1	GND
5.658000	16.70	10.3	50	33.3	AV	L1	GND
15.207000	10.50	10.6	50	39.5	AV	L1	GND

SCAN TABLE: "Voltage (9K-30M)FIN"
 Short Description: 150K-30M Voltage

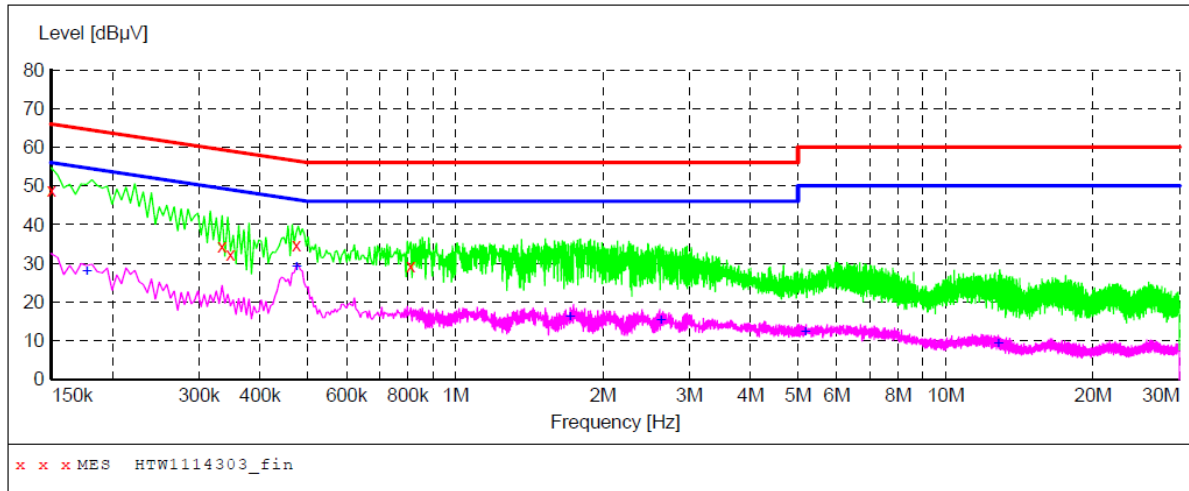

MEASUREMENT RESULT: "HTW1114303_fin"

11/14/2013 8:52AM

Frequency MHz	Level dBµV	Transd dB	Limit dBµV	Margin dB	Detector	Line	PE
0.150000	48.80	10.1	66	17.2	QP	N	GND
0.334500	34.50	10.1	59	24.8	QP	N	GND
0.348000	32.40	10.1	59	26.6	QP	N	GND
0.474000	34.90	10.1	56	21.5	QP	N	GND
0.811500	29.40	10.2	56	26.6	QP	N	GND

MEASUREMENT RESULT: "HTW1114303_fin2"

11/14/2013 8:52AM

Frequency MHz	Level dBµV	Transd dB	Limit dBµV	Margin dB	Detector	Line	PE
0.177000	27.70	10.1	55	26.9	AV	N	GND
0.474000	29.10	10.1	46	17.3	AV	N	GND
1.711500	16.20	10.3	46	29.8	AV	N	GND
2.625000	15.30	10.3	46	30.7	AV	N	GND
5.172000	12.10	10.3	50	37.9	AV	N	GND
12.808500	9.00	10.6	50	41.0	AV	N	GND

WCDMA Band V-AE2

SCAN TABLE: "Voltage (9K-30M) FIN"

Short Description: 150K-30M Voltage

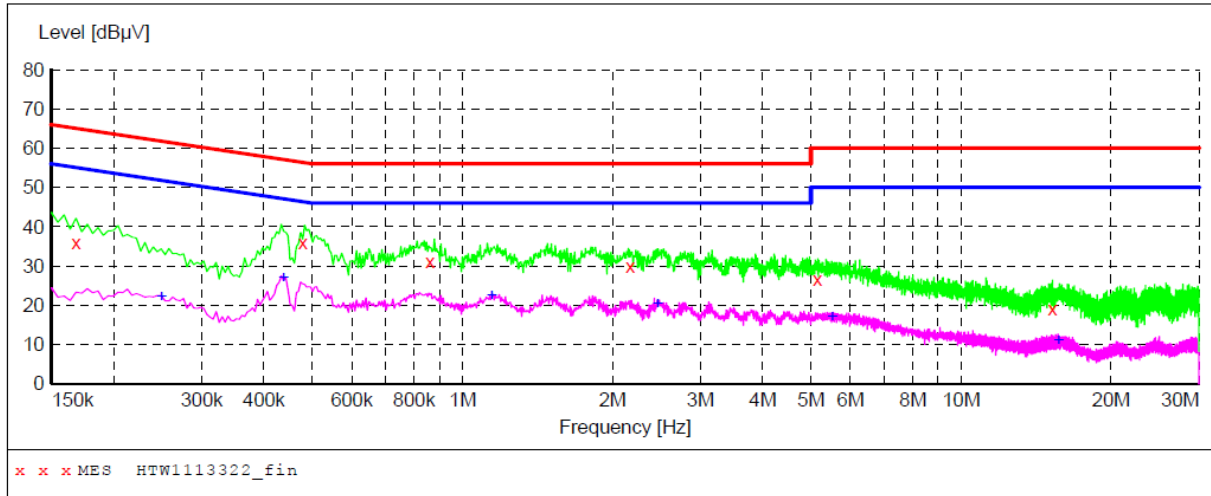

MEASUREMENT RESULT: "HTW1113322_fin"

11/13/2013 2:53PM

Frequency MHz	Level dBµV	Transd dB	Limit dBµV	Margin dB	Detector	Line	PE
0.168000	36.00	10.1	65	29.1	QP	L1	GND
0.478500	35.90	10.1	56	20.5	QP	L1	GND
0.861000	31.10	10.2	56	24.9	QP	L1	GND
2.170500	29.80	10.3	56	26.2	QP	L1	GND
5.154000	26.50	10.3	60	33.5	QP	L1	GND
15.256500	19.20	10.6	60	40.8	QP	L1	GND

MEASUREMENT RESULT: "HTW1113322_fin2"

11/13/2013 2:53PM

Frequency MHz	Level dBµV	Transd dB	Limit dBµV	Margin dB	Detector	Line	PE
0.249000	22.20	10.1	52	29.6	AV	L1	GND
0.438000	27.00	10.1	47	20.1	AV	L1	GND
1.144500	22.30	10.3	46	23.7	AV	L1	GND
2.463000	20.20	10.3	46	25.8	AV	L1	GND
5.514000	17.00	10.3	50	33.0	AV	L1	GND
15.675000	10.90	10.7	50	39.1	AV	L1	GND

SCAN TABLE: "Voltage (9K-30M) FIN"

Short Description: 150K-30M Voltage

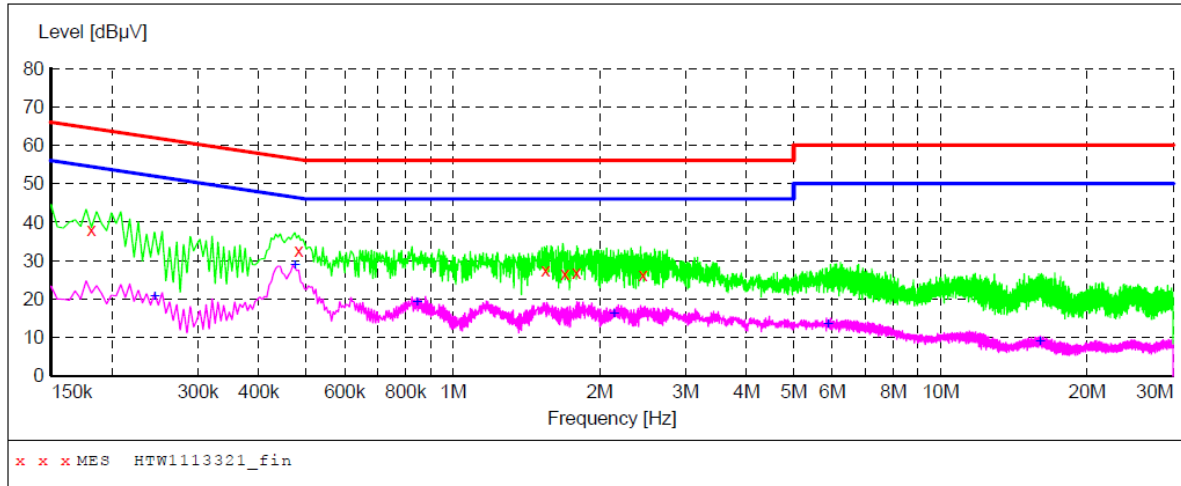

MEASUREMENT RESULT: "HTW1113321_fin"

11/13/2013 2:51PM

Frequency MHz	Level dBµV	Transd dB	Limit dBµV	Margin dB	Detector	Line	PE
0.181500	38.10	10.1	64	26.3	QP	N	GND
0.483000	32.50	10.1	56	23.8	QP	N	GND
1.549500	27.40	10.3	56	28.6	QP	N	GND
1.698000	26.70	10.3	56	29.3	QP	N	GND
1.792500	26.90	10.3	56	29.1	QP	N	GND
2.454000	26.40	10.3	56	29.6	QP	N	GND

MEASUREMENT RESULT: "HTW1113321_fin2"

11/13/2013 2:51PM

Frequency MHz	Level dBµV	Transd dB	Limit dBµV	Margin dB	Detector	Line	PE
0.244500	20.50	10.1	52	31.4	AV	N	GND
0.474000	28.70	10.1	46	17.7	AV	N	GND
0.843000	19.10	10.2	46	26.9	AV	N	GND
2.139000	16.10	10.3	46	29.9	AV	N	GND
5.878500	13.30	10.3	50	36.7	AV	N	GND
15.976500	8.70	10.7	50	41.3	AV	N	GND

MP3-AE2

SCAN TABLE: "Voltage (9K-30M) FIN"

Short Description: 150K-30M Voltage

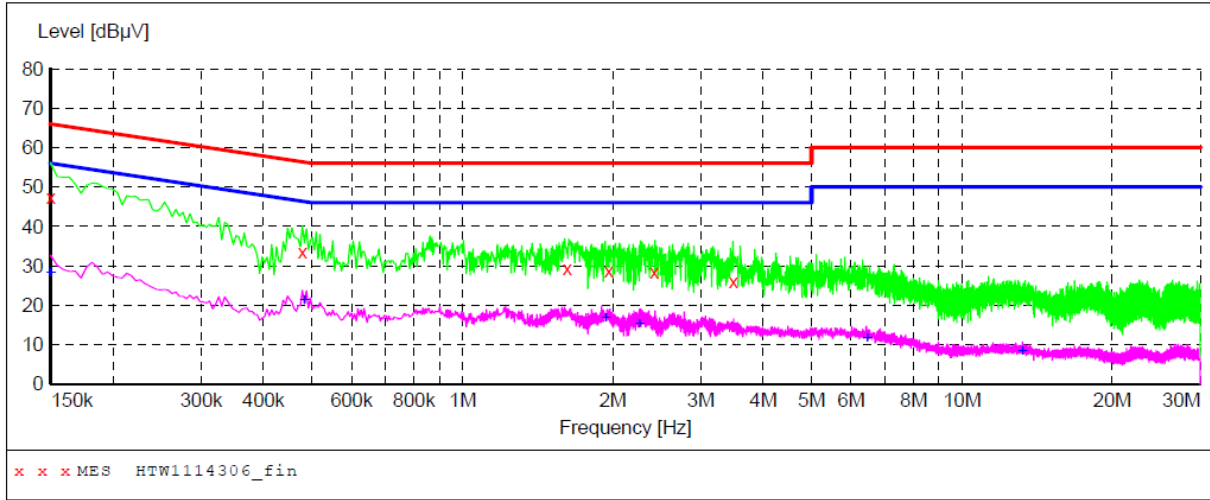

MEASUREMENT RESULT: "HTW1114306_fin"

11/14/2013 1:27PM

Frequency MHz	Level dBµV	Transd dB	Limit dBµV	Margin dB	Detector	Line	PE
0.150000	47.40	10.1	66	18.6	QP	N	GND
0.478500	33.60	10.1	56	22.8	QP	N	GND
1.621500	29.40	10.3	56	26.6	QP	N	GND
1.963500	28.80	10.3	56	27.2	QP	N	GND
2.422500	28.50	10.3	56	27.5	QP	N	GND
3.489000	25.90	10.3	56	30.1	QP	N	GND

MEASUREMENT RESULT: "HTW1114306_fin2"

11/14/2013 1:27PM

Frequency MHz	Level dBµV	Transd dB	Limit dBµV	Margin dB	Detector	Line	PE
0.150000	28.20	10.1	56	27.8	AV	N	GND
0.483000	21.10	10.1	46	25.2	AV	N	GND
1.936500	16.60	10.3	46	29.4	AV	N	GND
2.260500	15.00	10.3	46	31.0	AV	N	GND
6.463500	11.40	10.4	50	38.6	AV	N	GND
13.213500	8.20	10.6	50	41.8	AV	N	GND

SCAN TABLE: "Voltage (9K-30M) FIN"
 Short Description: 150K-30M Voltage

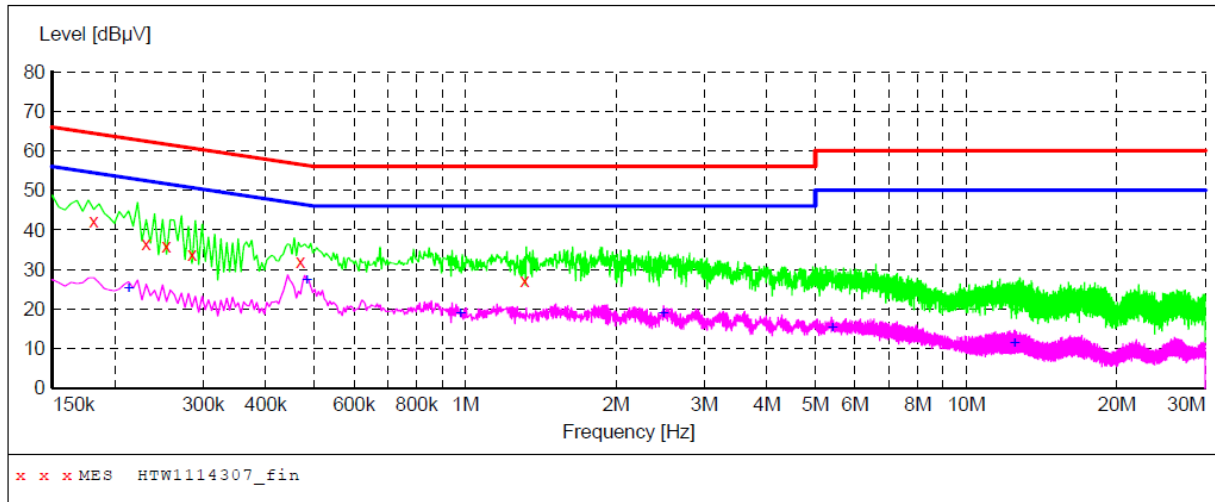

MEASUREMENT RESULT: "HTW1114307_fin"

11/14/2013 1:31PM

Frequency MHz	Level dBµV	Transd dB	Limit dBµV	Margin dB	Detector	Line	PE
0.181500	42.40	10.1	64	22.0	QP	L1	GND
0.231000	36.40	10.1	62	26.0	QP	L1	GND
0.253500	35.80	10.1	62	25.8	QP	L1	GND
0.285000	33.80	10.1	61	26.9	QP	L1	GND
0.469500	32.00	10.1	57	24.5	QP	L1	GND
1.315500	27.20	10.3	56	28.8	QP	L1	GND

MEASUREMENT RESULT: "HTW1114307_fin2"

11/14/2013 1:31PM

Frequency MHz	Level dBµV	Transd dB	Limit dBµV	Margin dB	Detector	Line	PE
0.213000	25.00	10.1	53	28.1	AV	L1	GND
0.483000	27.30	10.1	46	19.0	AV	L1	GND
0.978000	18.70	10.2	46	27.3	AV	L1	GND
2.485500	18.80	10.3	46	27.2	AV	L1	GND
5.406000	15.30	10.3	50	34.7	AV	L1	GND
12.484500	11.30	10.6	50	38.7	AV	L1	GND

CAMERA-AE2

SCAN TABLE: "Voltage (9K-30M) FIN"

Short Description: 150K-30M Voltage

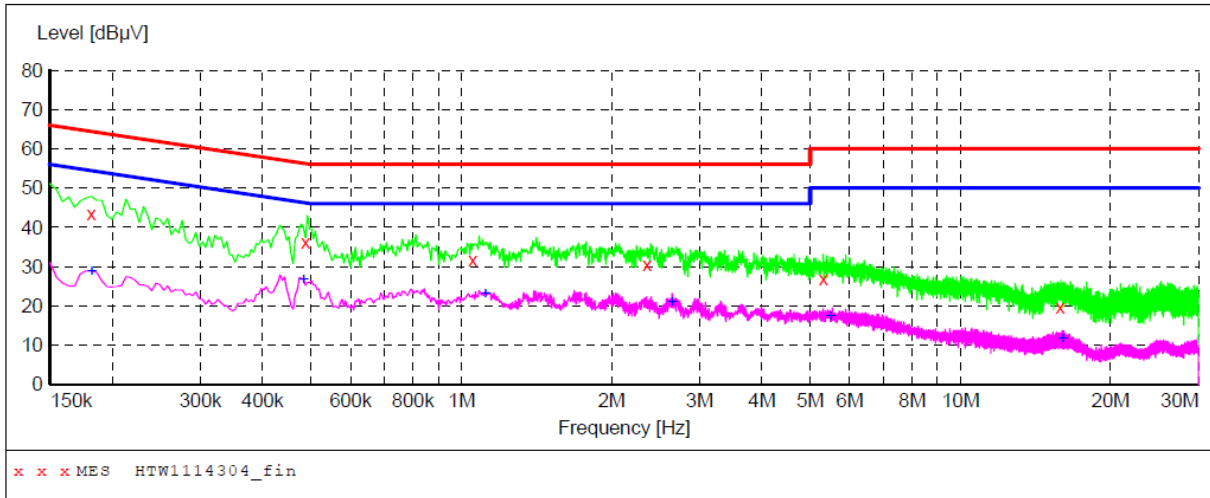

MEASUREMENT RESULT: "HTW1114304_fin"

11/14/2013 8:55AM

Frequency MHz	Level dBµV	Transd dB	Limit dBµV	Margin dB	Detector	Line	PE
0.181500	43.50	10.1	64	20.9	QP	L1	GND
0.487500	36.20	10.1	56	20.0	QP	L1	GND
1.054500	31.70	10.3	56	24.3	QP	L1	GND
2.355000	30.40	10.3	56	25.6	QP	L1	GND
5.316000	26.80	10.3	60	33.2	QP	L1	GND
15.868500	19.70	10.7	60	40.3	QP	L1	GND

MEASUREMENT RESULT: "HTW1114304_fin2"

11/14/2013 8:55AM

Frequency MHz	Level dBµV	Transd dB	Limit dBµV	Margin dB	Detector	Line	PE
0.181500	28.60	10.1	54	25.8	AV	L1	GND
0.483000	26.60	10.1	46	19.7	AV	L1	GND
1.117500	22.90	10.3	46	23.1	AV	L1	GND
2.643000	20.80	10.3	46	25.2	AV	L1	GND
5.496000	17.20	10.3	50	32.8	AV	L1	GND
16.021500	11.70	10.7	50	38.3	AV	L1	GND

SCAN TABLE: "Voltage (9K-30M)FIN"

Short Description: 150K-30M Voltage

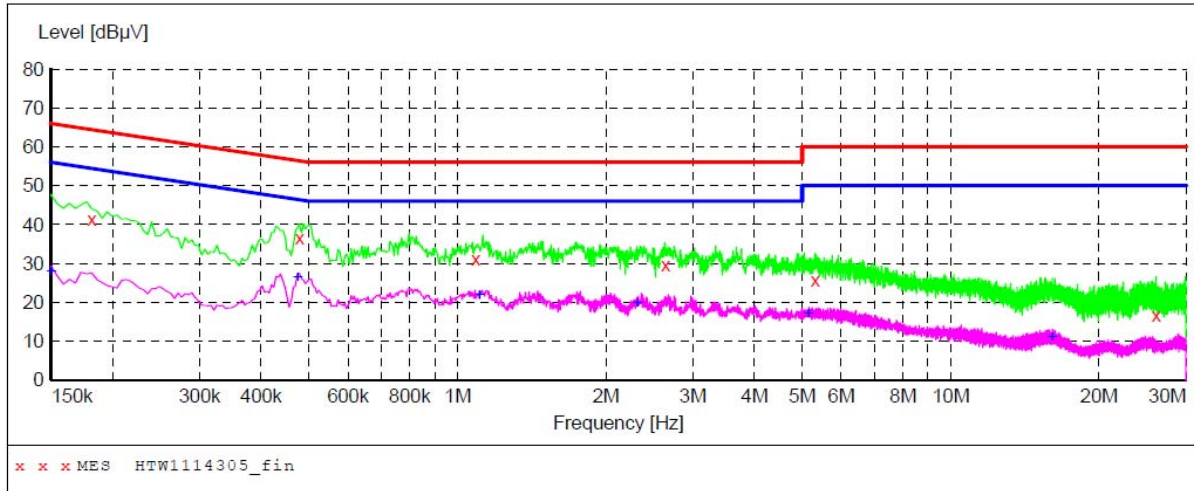

MEASUREMENT RESULT: "HTW1114305_fin"

11/14/2013 8:58AM

Frequency MHz	Level dBµV	Transd dB	Limit dBµV	Margin dB	Detector	Line	PE
0.181500	41.50	10.1	64	22.9	QP	L1	GND
0.478500	36.40	10.1	56	20.0	QP	L1	GND
1.090500	31.00	10.3	56	25.0	QP	L1	GND
2.647500	29.50	10.3	56	26.5	QP	L1	GND
5.320500	25.80	10.3	60	34.2	QP	L1	GND
26.119500	16.70	11.1	60	43.3	QP	L1	GND

MEASUREMENT RESULT: "HTW1114305_fin2"

11/14/2013 8:58AM

Frequency MHz	Level dBµV	Transd dB	Limit dBµV	Margin dB	Detector	Line	PE
0.150000	27.70	10.1	56	28.3	AV	L1	GND
0.474000	26.30	10.1	46	20.1	AV	L1	GND
1.108500	21.80	10.3	46	24.2	AV	L1	GND
2.314500	19.70	10.3	46	26.3	AV	L1	GND
5.145000	16.90	10.3	50	33.1	AV	L1	GND
16.057500	11.00	10.7	50	39.0	AV	L1	GND

4.2. OUTPUT POWER

TEST APPLICABLE

During the process of testing, the EUT was controlled via Rhode & Schwarz Digital Radio Communication tester (CMU-200) to ensure max power transmission and proper modulation. This result contains output power and EIRP measurements for the EUT. In all cases, output power is within the specified limits.

4.2.1. Conducted Output Power

TEST CONFIGURATION

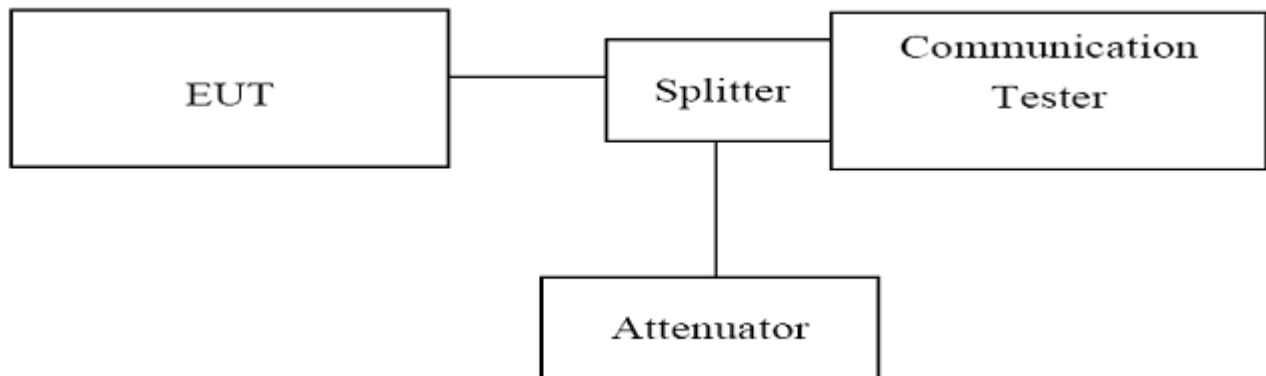

TEST PROCEDURE

1. The EUT was set up for the max output power with pseudo random data modulation.
2. The power was measured with Rhode & Schwarz Spectrum Analyzer FSU (peak)
3. These measurements were done at 3 frequencies, 1850.20 MHz, 1880.00 MHz and 1907.60 MHz for WCDMA band II; 826.40 MHz, 836.60 MHz and 846.60 MHz for WCDMA band V. (low, middle and high of operational frequency range).

TEST CONDITION

RBW	VBW	Sweep Time	Span
10MHz	10MHz	800ms	50MHz

TEST RESULTS

WCDMA V		
Channel	Frequency (MHz)	Output Power(dBm)
4132	826.40	23.42
4183	836.60	23.98
4233	846.60	23.94

WCDMA II		
Channel	Frequency (MHz)	Output Power(dBm)
9262	1852.40	23.07
9400	1880.00	23.56
9538	1907.60	23.69

4.2.2. Radiated Output Power

TEST DESCRIPTION

This is the test for the maximum radiated power from the EUT.

Rule Part 24.232(c) specifies, "Mobile/portable stations are limited to 2 watts e.i.r.p. Peak power" and 24.232(c) specifies that "Peak transmit power must be measured over any interval of continuous transmission using instrumentation calibrated in terms of an rms-equivalent voltage." Rule Part 22.913(a) specifies "The ERP of mobile transmitters and auxiliary test transmitters must not exceed 7 Watts." and Rule Part 27.50(d)(2) specifies, "Fixed, mobile, and portable (handheld) stations operating in the 1710–1755 MHz band are limited to a peak EIRP of 1 watt."

TEST CONFIGURATION

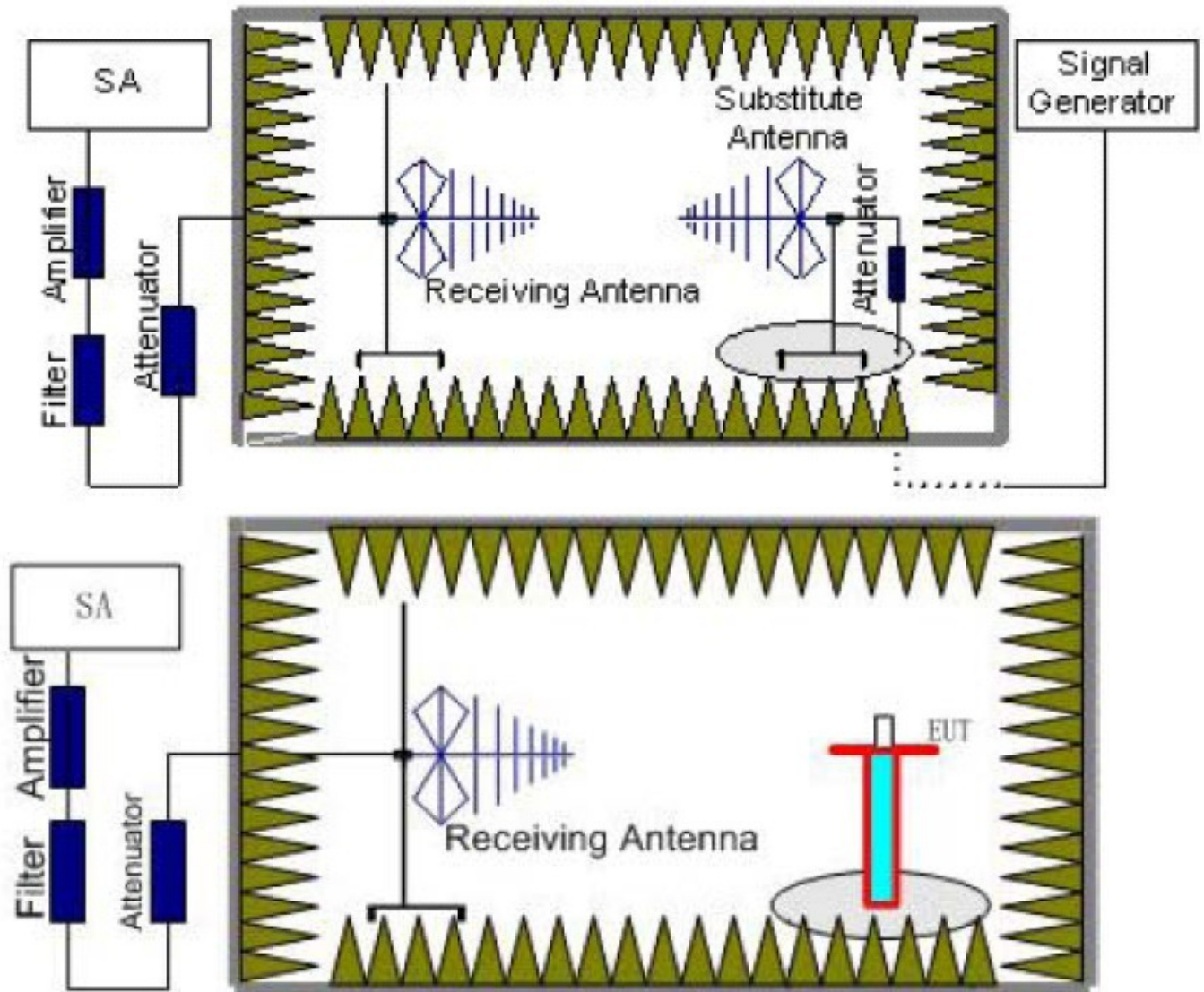

TEST PROCEDURE

1. EUT was placed on a 0.80 meter high non-conductive stand at a 3 meter test distance from the receive antenna. A receiving antenna was placed on the antenna mast 3 meters from the EUT for emission measurements. The height of receiving antenna is 0.80m. Detected emissions were maximized at each frequency by rotating the EUT through 360° and adjusting the receiving antenna polarization. The radiated emission measurements of all transmit frequencies in three channels (High, Middle, Low) were measured with peak detector.
2. A log-periodic antenna or double-ridged waveguide horn antenna shall be substituted in place of the EUT. The log-periodic antenna will be driven by a signal generator and the level will be adjusted till the same power value on the spectrum analyzer or receiver. The level of the spurious emissions can be calculated through the level of the signal generator, cable loss, the gain of the substitution antenna and the reading of the spectrum analyzer or receiver.

3. The EUT is then put into continuously transmitting mode at its maximum power level during the test. Set Test Receiver or Spectrum RBW=10MHz, VBW=10MHz, And the maximum value of the receiver should be recorded as (P_r).
4. The EUT shall be replaced by a substitution antenna. In the chamber, an substitution antenna for the frequency band of interest is placed at the reference point of the chamber. An RF Signal source for the frequency band of interest is connected to the substitution antenna with a cable that has been constructed to not interfere with the radiation pattern of the antenna. A power (P_{Mea}) is applied to the input of the substitution antenna, and adjust the level of the signal generator output until the value of the receiver reach the previously recorded (P_r). The power of signal source (P_{Mea}) is recorded. The test should be performed by rotating the test item and adjusting the receiving antenna polarization.
5. A amplifier should be connected to the Signal Source output port. And the cable should be connect between the Amplifier and the Substitution Antenna. The cable loss (P_{cl}), the Substitution Antenna Gain (G_a) and the Amplifier Gain (P_{Ag}) should be recorded after test.
The measurement results are obtained as described below:
Power(EIRP)= $P_{Mea} - P_{Ag} - P_{cl} - G_a$
We used SMF100A microwave signal generator which signal level can up to 33dBm, so we not used power Amplifier for substitution test; The measurement results are amend as described below:
Power(EIRP)= $P_{Mea} - P_{cl} - G_a$
6. This value is EIRP since the measurement is calibrated using an antenna of known gain (2.15 dBi) and known input power.
7. ERP can be calculated from EIRP by subtracting the gain of the dipole, $ERP = EIRP - 2.15\text{dBi}$.

TEST LIMIT

According to 22.913(a) and 24.232(c), the ERP should be not exceed following table limits:

	Burst Peak EIRP
WCDMA Band II	33dBm (2W)
	Burst Peak ERP
WCDMA Band V	38.45dBm (7W)

TEST RESULTS

WCDMA Band II						
Frequency (MHz)	P_{Mea} (dBm)	P_{cl} (dB)	G_a Antenna Gain (dB)	Correction (dB)	EIRP (dBm)	Polarization
1852.4	16.99	3.52	8.35	2.15	21.82	H
1880.0	17.80	3.61	8.29	2.15	22.48	H
1907.6	17.84	3.67	8.37	2.15	22.54	H
1852.4	17.13	3.52	8.35	2.15	21.96	V
1880.0	17.50	3.61	8.29	2.15	22.18	V
1907.6	17.57	3.67	8.37	2.15	22.27	V

WCDMA Band V						
Frequency (MHz)	P_{Mea} (dBm)	P_{cl} (dB)	G_a Antenna Gain (dB)	Correction (dB)	ERP (dBm)	Polarization
826.40	14.58	1.56	8.45	2.15	19.32	H
836.60	15.11	1.50	8.45	2.15	19.91	H
846.60	15.57	1.67	8.39	2.15	20.14	H
826.40	14.72	1.56	8.45	2.15	19.46	V
836.60	14.81	1.50	8.45	2.15	19.61	V
846.60	15.3	1.67	8.39	2.15	19.87	V

4.3. Radiated Spurious Emission

TEST APPLICABLE

According to the TIA/EIA 603D:2010 test method, The Receiver or Spectrum was scanned from 30 MHz to the 10th harmonic of the highest frequency generated within the equipment, which is the transmitted carrier that can be as high as 1910 MHz. The resolution bandwidth is set as outlined in Part 24.238 and Part 22.917. The spectrum is scanned with the mobile station transmitting at carrier frequencies that pertain to low, mid and high channels of WCDMA Band II and WCDMA Band V.

TEST CONFIGURATION

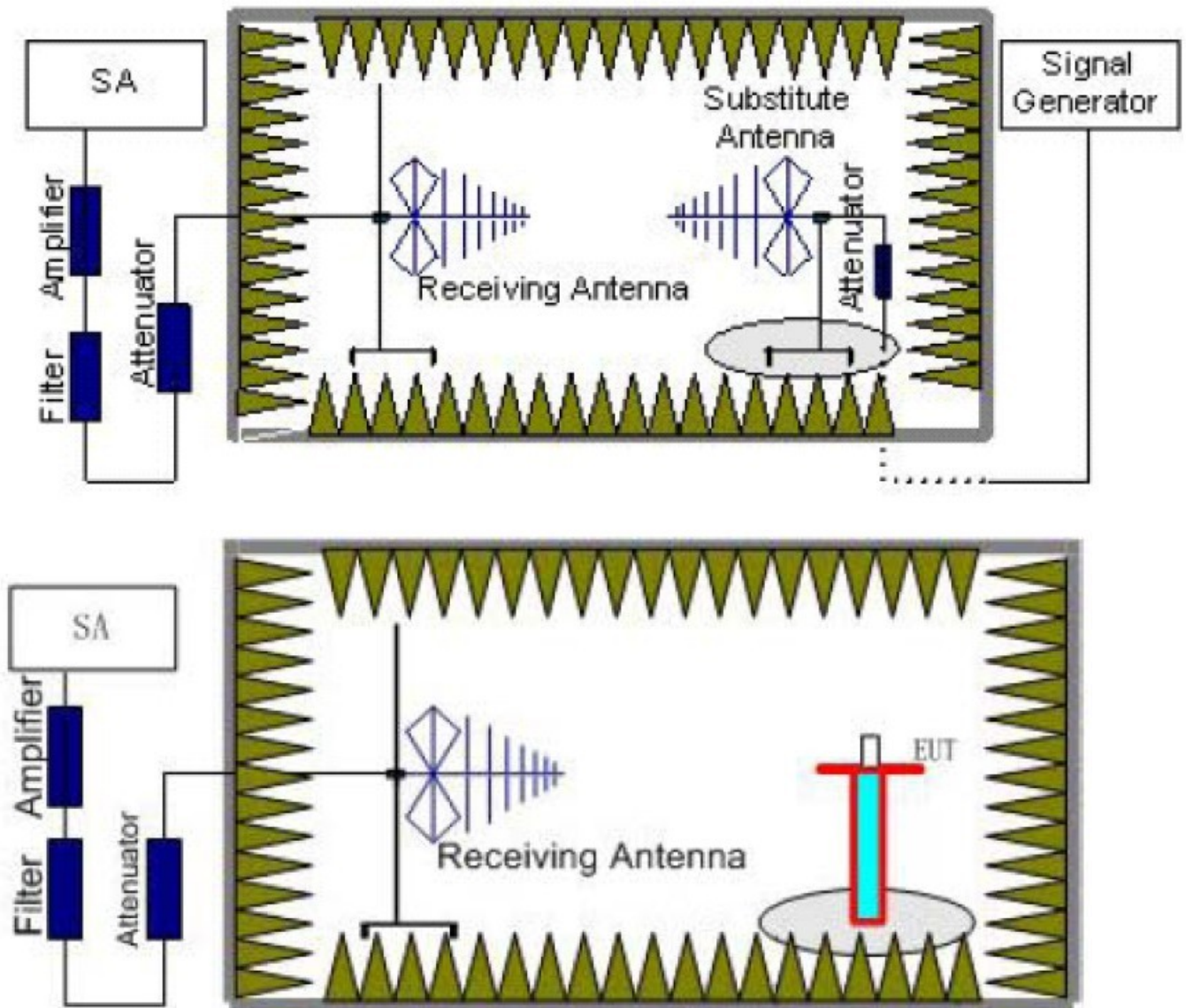

TEST PROCEDURE

1. EUT was placed on a 0.80 meter high non-conductive stand at a 3 meter test distance from the receive antenna. A receiving antenna was placed on the antenna mast 3 meters from the EUT for emission measurements. The height of receiving antenna is 0.80m. Detected emissions were maximized at each frequency by rotating the EUT through 360° and adjusting the receiving antenna polarization. The radiated emission measurements of all transmit frequencies in three channels (High, Middle, Low) were measured with peak detector.
2. A log-periodic antenna or double-ridged waveguide horn antenna shall be substituted in place of the EUT. The log-periodic antenna will be driven by a signal generator and the level will be adjusted till the same power value on the spectrum analyzer or receiver. The level of the spurious emissions can be calculated through the level of the signal generator, cable loss, the gain of the substitution antenna and the reading of the spectrum analyzer or receiver.

3. The EUT is then put into continuously transmitting mode at its maximum power level during the test. Set Test Receiver or Spectrum RBW=1MHz, VBW=3MHz, And the maximum value of the receiver should be recorded as (P_r).
4. The EUT shall be replaced by a substitution antenna. In the chamber, an substitution antenna for the frequency band of interest is placed at the reference point of the chamber. An RF Signal source for the frequency band of interest is connected to the substitution antenna with a cable that has been constructed to not interfere with the radiation pattern of the antenna. A power (P_{Mea}) is applied to the input of the substitution antenna, and adjust the level of the signal generator output until the value of the receiver reach the previously recorded (P_r). The power of signal source (P_{Mea}) is recorded. The test should be performed by rotating the test item and adjusting the receiving antenna polarization.
5. A amplifier should be connected to the Signal Source output port. And the cable should be connect between the Amplifier and the Substitution Antenna. The cable loss (P_{cl}), the Substitution Antenna Gain (G_a) and the Amplifier Gain (P_{Ag}) should be recorded after test. The measurement results are obtained as described below:
Power(EIRP)= $P_{Mea} - P_{Ag} - P_{cl} + G_a$
6. This value is EIRP since the measurement is calibrated using an antenna of known gain (2.15 dBi) and known input power.
7. ERP can be calculated from EIRP by subtracting the gain of the dipole, ERP = EIRP -2.15dBi.
8. In order to make sure test results more clearly, we set frequency range and sweep time for difference frequency range as follows table:

Working Frequency	Subrange (GHz)	RBW	VBW	Sweep time (s)
850MHz	0.03~1	100KHz	300KHz	10
	1-2	1 MHz	3 MHz	2
	2~5	1 MHz	3 MHz	3
	5~8	1 MHz	3 MHz	3
	8~10	1 MHz	3 MHz	3
94000MHz	0.03~1	100KHz	300KHz	10
	1-2	1 MHz	3 MHz	2
	2~5	1 MHz	3 MHz	3
	5~8	1 MHz	3 MHz	3
	8~11	1 MHz	3 MHz	3
	11~14	1 MHz	3 MHz	3
	14~18	1 MHz	3 MHz	3
18~20	1 MHz	3 MHz	2	

TEST LIMITS

According to 24.238 and 22.917 specify that the power of any emission outside of the authorized operating frequency ranges must be attenuated below the transmitting power (P) by a factor of at least $43 + 10 \log(P)$ dB.

The specification that emissions shall be attenuated below the transmitter power (P) by at least $43 + 10 \log(P)$ dB, translates in the relevant power range (1 to 0.001 W) to -13 dBm. At 1 W the specified minimum attenuation becomes 43 dB and relative to a 30 dBm (1 W) carrier becomes a limit of -13 dBm. At 0.001 W (0 dBm) the minimum attenuation is 13 dB, which again yields a limit of -13 dBm. In this way a translation of the specification from relative to absolute terms is carried out.

Frequency	Channel	Frequency Range	Verdict
GSM 850MHz	Low	30MHz-10GHz	PASS
	Middle	30MHz-10GHz	PASS
	High	30MHz-10GHz	PASS
GSM 94000MHz	Low	30MHz-20GHz	PASS
	Middle	30MHz-20GHz	PASS
	High	30MHz-20GHz	PASS

WCDMA Band II							
Channel Number: 9262				Test Frequency: 1852.40 MHz			
Frequency (MHz)	P _{Mea} (dBm)	Path Loss	Antenna Gain	Correction (dB)	Peak ERP(dBm)	Limit (dBm)	Polarization
3704.80	-32.31	4.55	12.34	2.15	-26.67	-13.00	H
5557.20	-28.83	5.05	13.53	2.15	-22.5	-13.00	H
7409.60	-30.10	4.64	11.60	2.15	-25.29	-13.00	H
3704.80	-28.79	4.55	12.34	2.15	-23.15	-13.00	V
5557.20	-26.2	5.05	13.53	2.15	-19.87	-13.00	V
7409.60	-26.82	4.64	11.60	2.15	-22.01	-13.00	V

WCDMA Band II							
Channel Number: 9400				Test Frequency: 1880.00 MHz			
Frequency (MHz)	P _{Mea} (dBm)	Path Loss	Antenna Gain	Correction (dB)	Peak ERP(dBm)	Limit (dBm)	Polarization
3760.00	-32.8	4.55	12.40	2.15	-27.10	-13.00	H
5640.00	-29.72	4.96	13.60	2.15	-23.23	-13.00	H
7520.00	-29.63	4.71	11.89	2.15	-24.6	-13.00	H
3760.00	-28.84	4.55	12.40	2.15	-23.14	-13.00	V
5640.00	-26.49	4.96	13.60	2.15	-20.00	-13.00	V
7520.00	-26.67	4.71	11.89	2.15	-21.64	-13.00	V

WCDMA Band II							
Channel Number: 9538				Test Frequency: 1907.60 MHz			
Frequency (MHz)	P _{Mea} (dBm)	Path Loss	Antenna Gain	Correction (dB)	Peak ERP(dBm)	Limit (dBm)	Polarization
3815.20	-30.60	4.51	12.43	2.15	-24.83	-13.00	H
5722.80	-28.04	4.90	13.61	2.15	-21.48	-13.00	H
7630.40	-28.04	4.78	12.00	2.15	-22.97	-13.00	H
3815.20	-26.89	4.51	12.43	2.15	-21.12	-13.00	V
5722.80	-25.64	4.90	13.61	2.15	-19.08	-13.00	V
7630.40	-25.31	4.78	12.00	2.15	-20.24	-13.00	V

WCDMA Band V							
Channel Number: 4132				Test Frequency: 826.40 MHz			
Frequency (MHz)	P _{Mea} (dBm)	Path Loss	Antenna Gain	Correction (dB)	Peak ERP(dBm)	Limit (dBm)	Polarization
2479.20	-23.88	4.32	6.77	2.15	-23.58	-13.00	H
3305.60	-27.05	4.55	12.25	2.15	-21.50	-13.00	H
4958.40	-29.81	4.70	12.92	2.15	-23.74	-13.00	H
2479.20	-22.23	4.32	6.77	2.15	-21.93	-13.00	V
3305.60	-25.12	4.55	12.25	2.15	-19.57	-13.00	V
4958.40	-27.81	4.59	12.76	2.15	-21.79	-13.00	V

WCDMA Band V							
Channel Number: 4183				Test Frequency: 836.60 MHz			
Frequency (MHz)	P _{Mea} (dBm)	Path Loss	Antenna Gain	Correction (dB)	Peak ERP(dBm)	Limit (dBm)	Polarization
3342.30	-31.42	4.55	12.25	2.15	-25.87	-13.00	H
4183.00	-28.82	4.59	12.76	2.15	-22.80	-13.00	H
5014.44	-29.79	4.78	12.88	2.15	-23.84	-13.00	H
3342.30	-28.00	4.55	12.25	2.15	-22.45	-13.00	V
4183.00	-26.1	4.59	12.76	2.15	-20.08	-13.00	V
5014.44	-26.5	4.78	12.88	2.15	-20.55	-13.00	V

WCDMA Band V							
Channel Number: 4233				Test Frequency: 846.60 MHz			
Frequency (MHz)	P _{Mea} (dBm)	Path Loss	Antenna Gain	Correction (dB)	Peak ERP(dBm)	Limit (dBm)	Polarization
2547.31	-26.93	4.29	6.83	2.15	-26.54	-13.00	H
3390.64	-29.79	4.58	12.59	2.15	-23.93	-13.00	H
4232.50	-31.29	4.59	12.76	2.15	-25.27	-13.00	H
2547.31	-24.25	4.29	6.83	2.15	-23.86	-13.00	V
3390.64	-26.96	4.58	12.59	2.15	-21.10	-13.00	V
4232.50	-29.47	4.59	12.76	2.15	-23.45	-13.00	V

Note: 1. In general, the worse case attenuation requirement shown above was applied.

3. *** means that the emission level is too low to be measured or at least 20 dB down than the limit.

4.4. OCCUPIED BANDWIDTH

TEST APPLICABLE

Similar to conducted emissions; occupied bandwidth measurements are only provided for selected frequencies in order to reduce the amount of submitted data. Data were taken at the extreme and mid frequencies of WCDMA Band II and WCDMA band V. The table below lists the measured 99% BW.

TEST CONFIGURATION

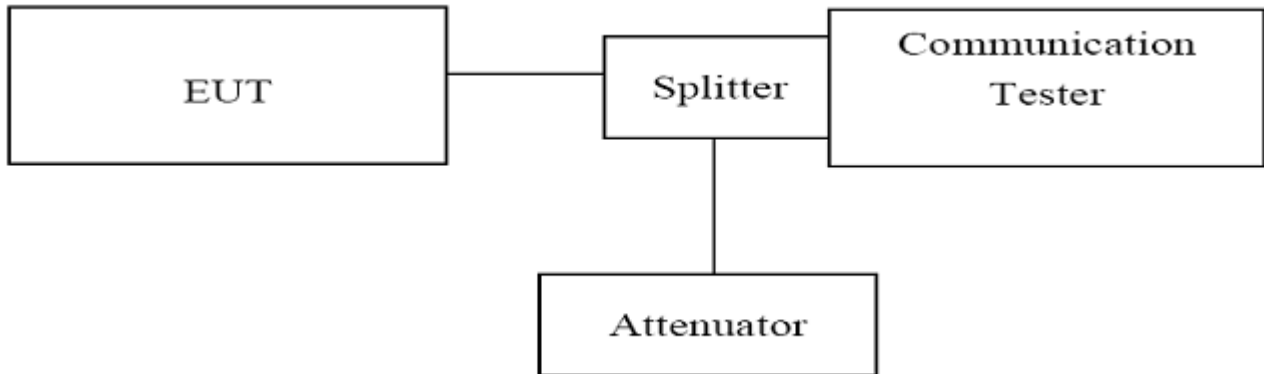

TEST PROCEDURE

1. The EUT was set up for the max output power with pseudo random data modulation;
2. The Occupied bandwidth was measured with Rhode & Schwarz Spectrum Analyzer FSU (peak);
3. Set RBW=5KHz,VBW=50KHz,Span=500KHz,SWT=20ms;
4. Set SPA Max hold. Mark peak, Set 99% Occupied Bandwidth
5. These measurements were done at 3 frequencies, 1850.20 MHz, 1880.00 MHz and 1709.80 MHz for WCDMA band II; 826.40 MHz, 836.60 MHz and 846.60 MHz for WCDMA band V. (low, middle and high of operational frequency range).

TEST RESULTS

WCDMA Band II				
Channel Number	Frequency (MHz)	Occupied Bandwidth (99% BW) (kHz)	Refer to Plot	Verdict
9262	1852.4	4166.67	Plot 4.4.1 A	PASS
9400	1880.0	4182.69	Plot 4.4.1 B	PASS
9538	1907.6	4150.64	Plot 4.4.1 C	PASS



*RBW 50 kHz Marker 1 [T1]
*VBW 100 kHz 11.92 dBm
*SWT 5 ms 1.852383974 GHz
Ref 37 dBm *Att 20 dB

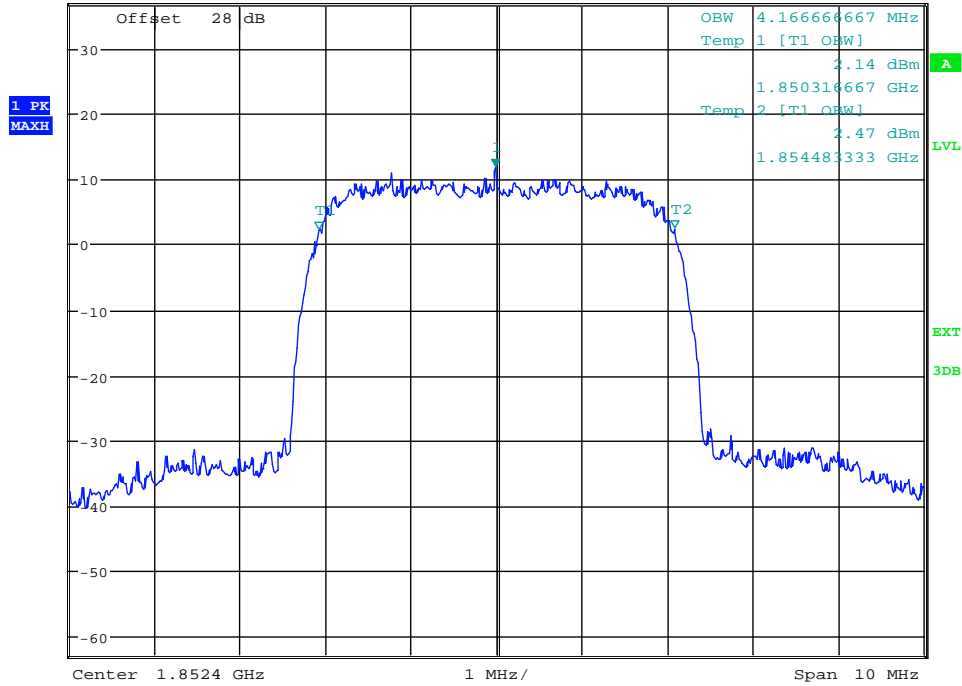

Date: 21.NOV.2013 13:51:12

(Plot 4.4.1 A: Channel 9262: 1852.4MHz WCDMA Band II)



*RBW 50 kHz Marker 1 [T1]
*VBW 100 kHz 11.59 dBm
*SWT 5 ms 1.881490385 GHz
Ref 37 dBm *Att 20 dB

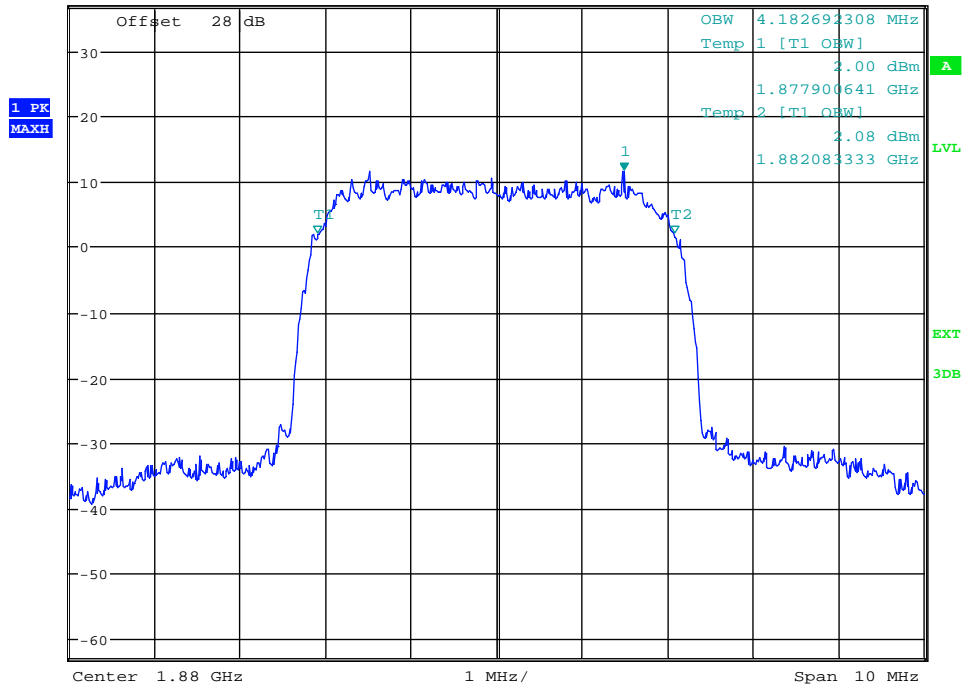

Date: 21.NOV.2013 13:50:46

(Plot 4.4.1 B: Channel 9400: 1880.0MHz WCDMA Band II)

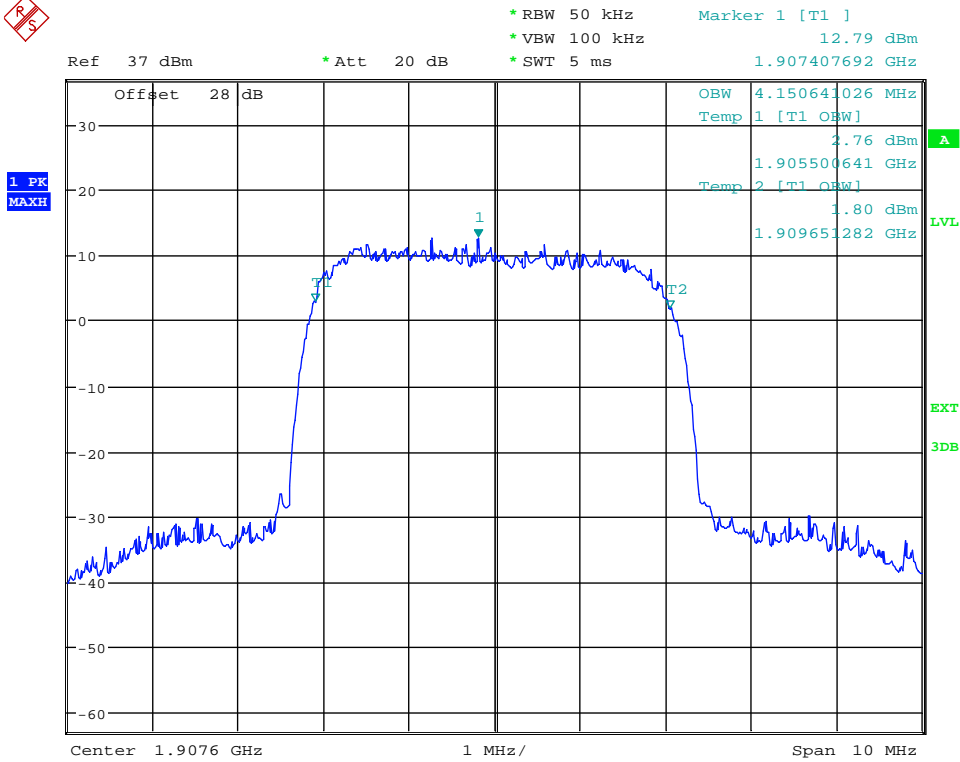

Date: 21.NOV.2013 13:50:11

(Plot 4.4.1 C: Channel 9538: 1907.6MHz WCDMA Band II)

WCDMA Band V				
Channel Number	Frequency (MHz)	Occupied Bandwidth (99% BW) (kHz)	Refer to Plot	Verdict
4132	826.4	4166.67	Plot 4.4.2 A	PASS
4183	836.6	4166.67	Plot 4.4.2 B	PASS
4233	846.6	4150.64	Plot 4.4.2 C	PASS

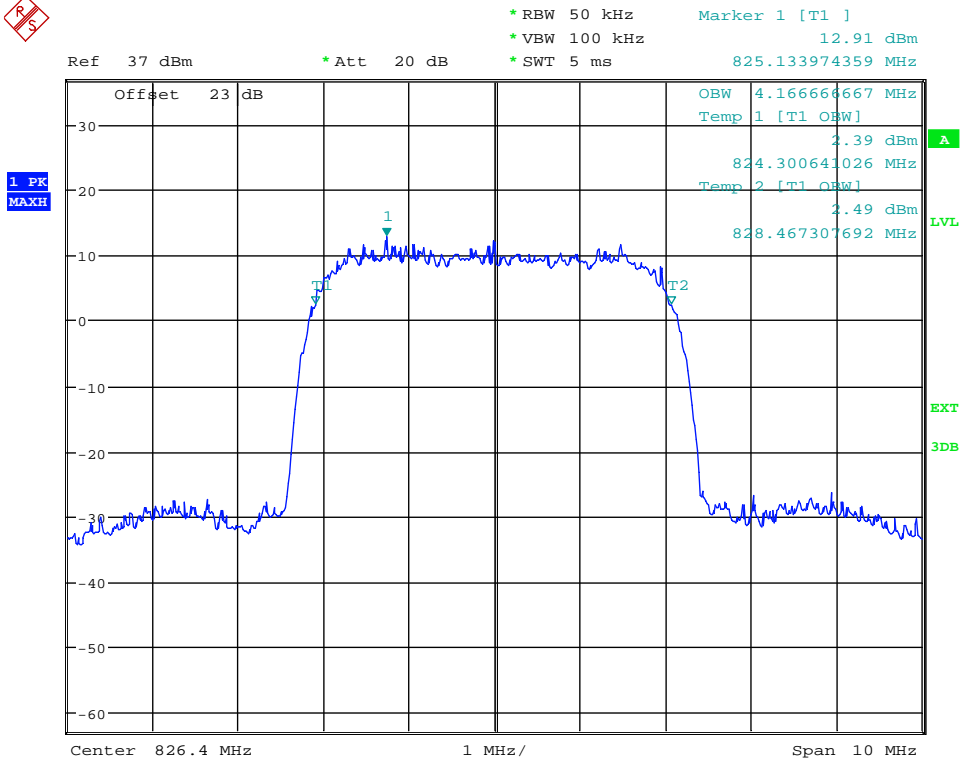

Date: 21.NOV.2013 14:27:26

(Plot 4.4.2 A: Channel 4132:826.4MHz @ WCDMA Band V)

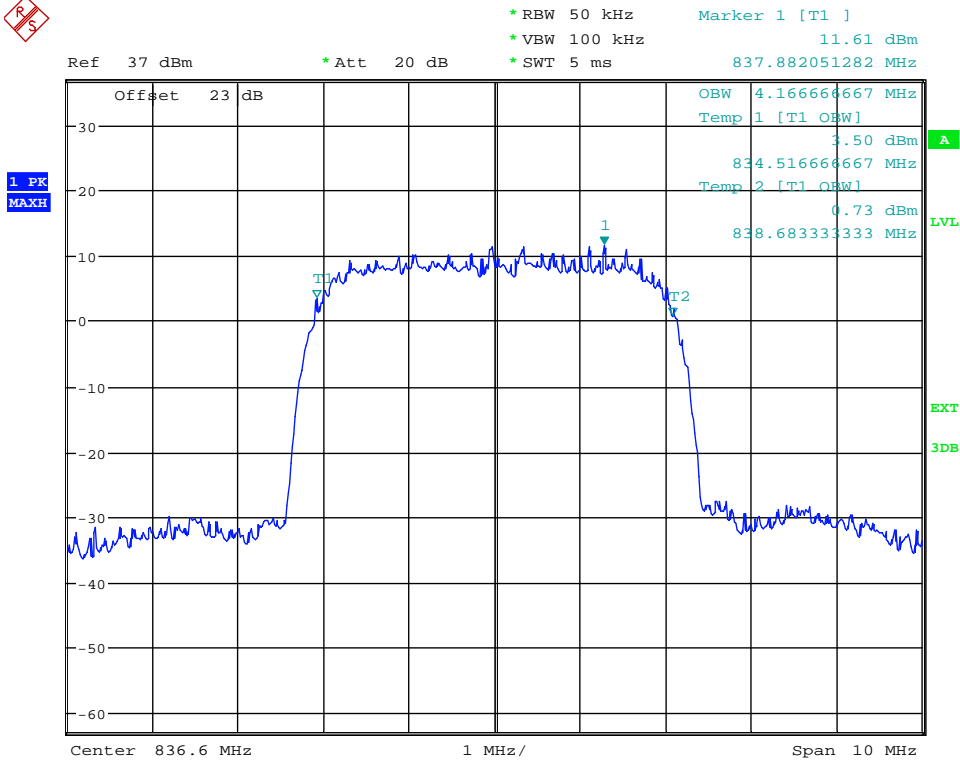

Date: 21.NOV.2013 14:27:55

(Plot 4.4.2 B: Channel 4183:836.6MHz @ WCDMA Band V)



*RBW 50 kHz Marker 1 [T1]
*VBW 100 kHz 11.35 dBm
*SWT 5 ms 846.567948718 MHz

Ref 37 dBm *Att 20 dB

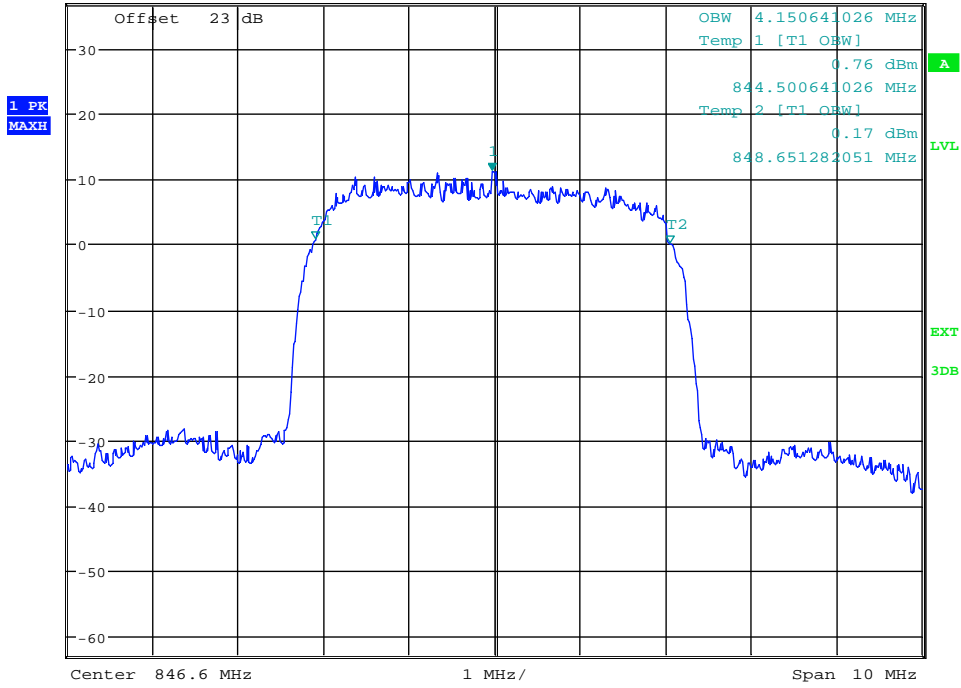

Date: 21.NOV.2013 14:28:16

(Plot 4.4.4 C: Channel 4233:846.6MHz @ WCDMA Band V)

4.5. EMISSION BANDWIDTH

TEST APPLICABLE

Similar to conducted emissions; occupied bandwidth measurements are only provided for selected frequencies in order to reduce the amount of submitted data. Data were taken at the extreme and mid frequencies of PCS94000 band and WCDMA II band. The table below lists the measured -26dBc BW.

TEST CONFIGURATION

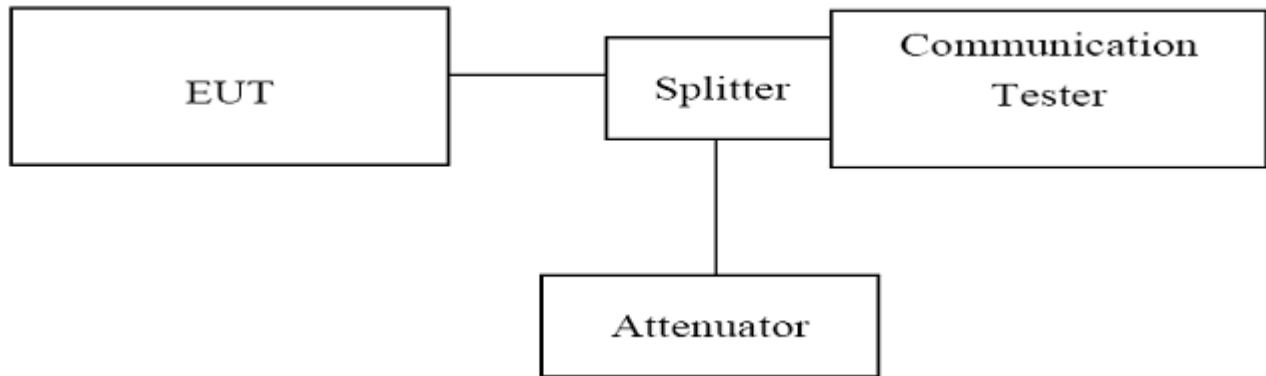

TEST PROCEDURE

1. The EUT was set up for the max output power with pseudo random data modulation;
2. The Occupied bandwidth was measured with Rhode & Schwarz Spectrum Analyzer FSU (peak);
3. Set RBW=5KHz, VBW=50KHz, Span=500KHz, SWT=20ms;
4. Set SPA Max hold. Mark peak, Set -26dBc Occupied Bandwidth
5. These measurements were done at 3 frequencies, 1850.20 MHz, 1880.00 MHz and 94009.80 MHz for WCDMA band II; 826.40 MHz, 836.60 MHz and 846.60 MHz for WCDMA band V. (low, middle and high of operational frequency range).

TEST RESULTS

WCDMA Band II				
Channel Number	Frequency (MHz)	Occupied Bandwidth (-26dBc BW) (kHz)	Refer to Plot	Verdict
9262	1852.4	4679.49	Plot 4.5.1 A	PASS
9400	1880.0	4631.41	Plot 4.5.1 B	PASS
9538	1907.6	4631.41	Plot 4.5.1 C	PASS



Ref 37 dBm * Att 20 dB * RBW 50 kHz * VBW 100 kHz * SWT 5 ms Marker 1 [T1] 11.18 dBm 1.851230128 GHz

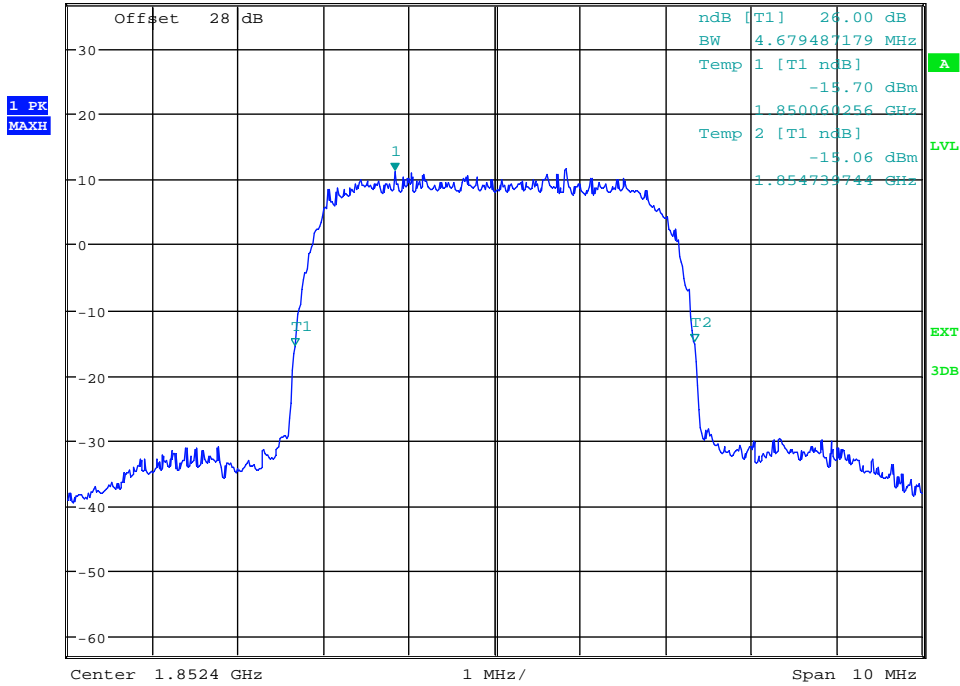

Date: 21.NOV.2013 13:52:33

(Plot 4.5.1 A: Channel 9262: 1852.4MHz WCDMA Band II)



Ref 37 dBm * Att 20 dB * RBW 50 kHz * VBW 100 kHz * SWT 5 ms Marker 1 [T1] 12.76 dBm 1.880576923 GHz

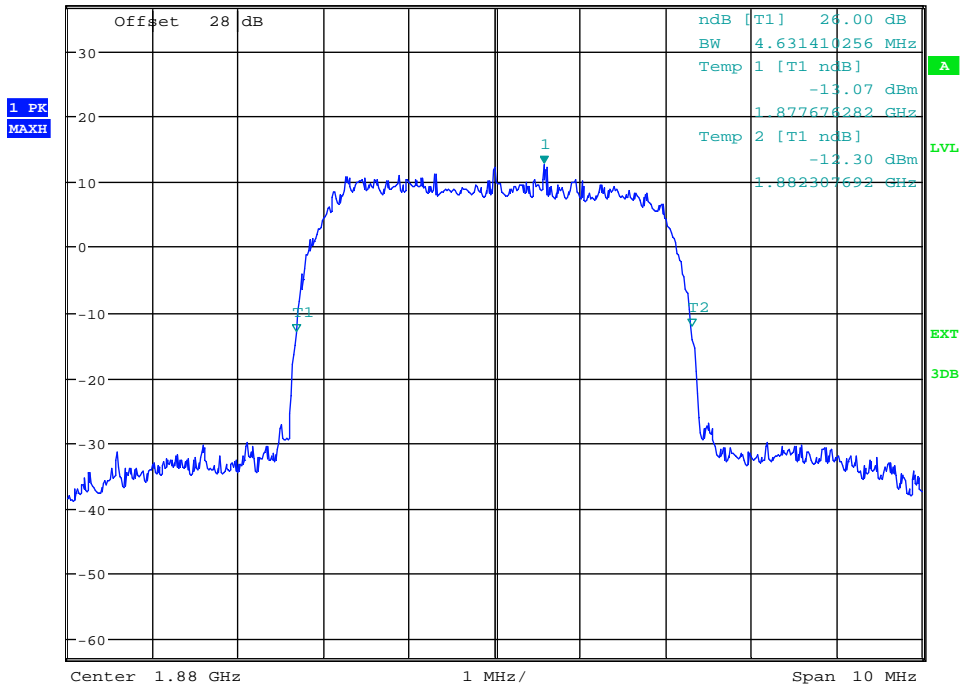

Date: 21.NOV.2013 13:53:10

(Plot 4.5.1 B: Channel 9400: 1880.0MHz WCDMA Band II)



*RBW 50 kHz Marker 1 [T1]
 *VBW 100 kHz 12.71 dBm
 *SWT 5 ms 1.906542308 GHz

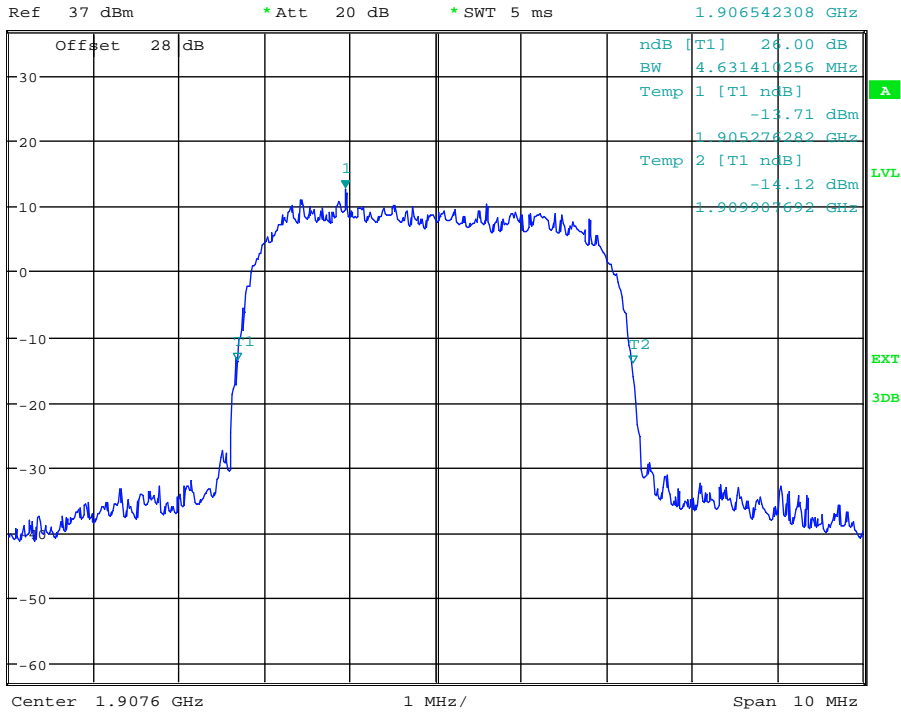

Date: 21.NOV.2013 13:53:26

(Plot 4.5.1 C: Channel 9538: 1907.6MHz WCDMA Band II)

WCDMA Band V				
Channel Number	Frequency (MHz)	Occupied Bandwidth (99% BW) (kHz)	Refer to Plot	Verdict
4132	826.4	4679.49	Plot 4.5.2 A	PASS
4183	836.6	4663.46	Plot 4.5.2 B	PASS
4233	846.6	4647.44	Plot 4.5.2 C	PASS



*RBW 50 kHz Marker 1 [T1]
*VBW 100 kHz 11.71 dBm
*SWT 5 ms 826.367948718 MHz

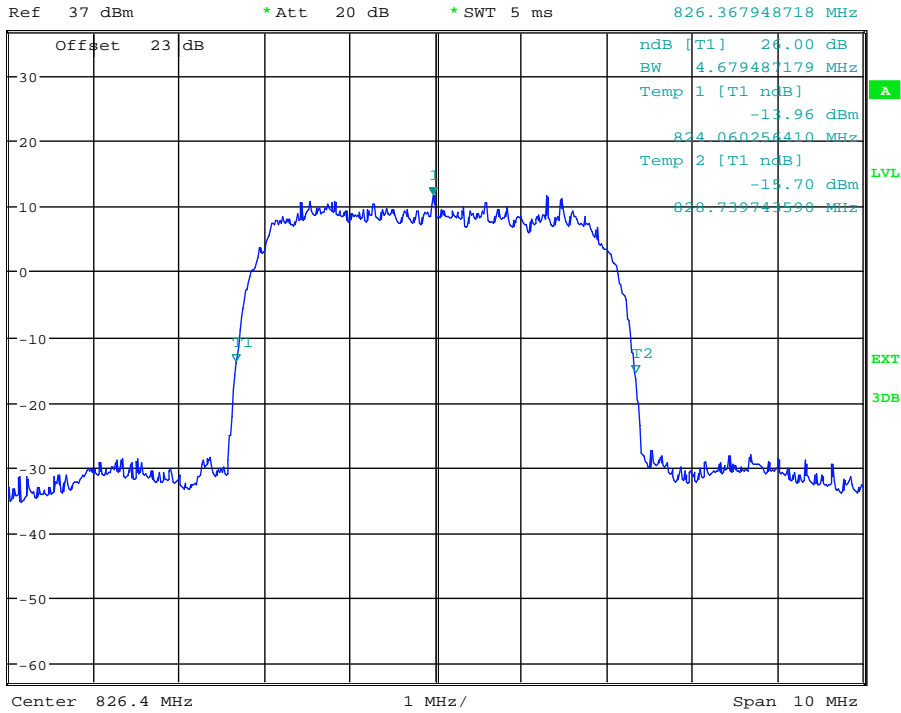

Date: 21.NOV.2013 14:29:13

(Plot 4.5.2 A: Channel 4132:826.4MHz @ WCDMA Band V)



*RBW 50 kHz Marker 1 [T1]
*VBW 100 kHz 10.50 dBm
*SWT 5 ms 836.391666667 MHz

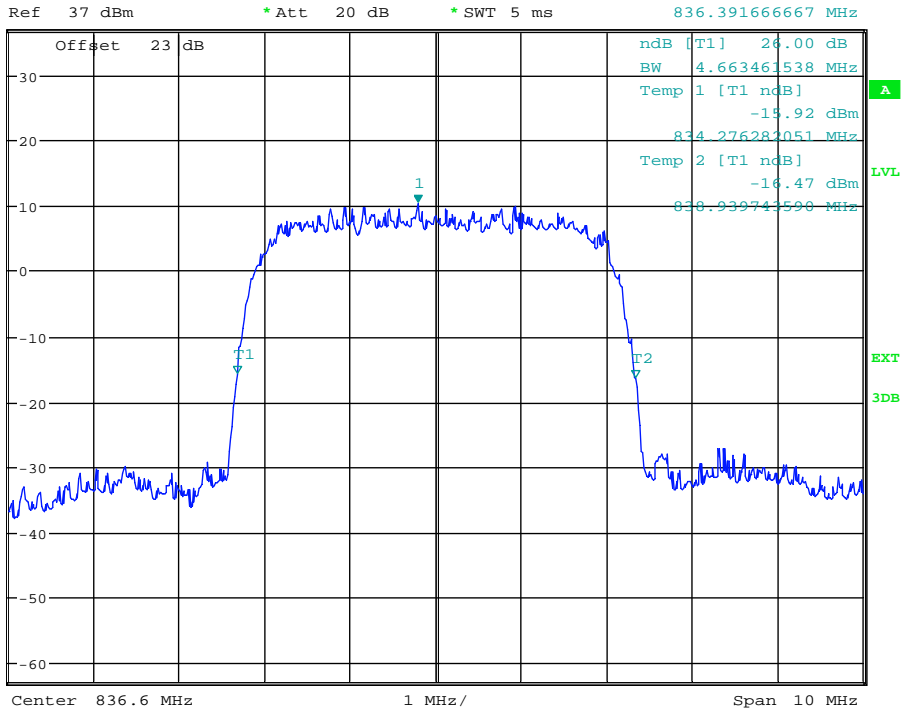

Date: 21.NOV.2013 14:28:42

(Plot 4.5.2 B: Channel 4183:836.6MHz @ WCDMA Band V)



*RBW 50 kHz Marker 1 [T1]
*VBW 100 kHz 11.65 dBm
*SWT 5 ms 845.189743590 MHz

Ref 37 dBm *Att 20 dB

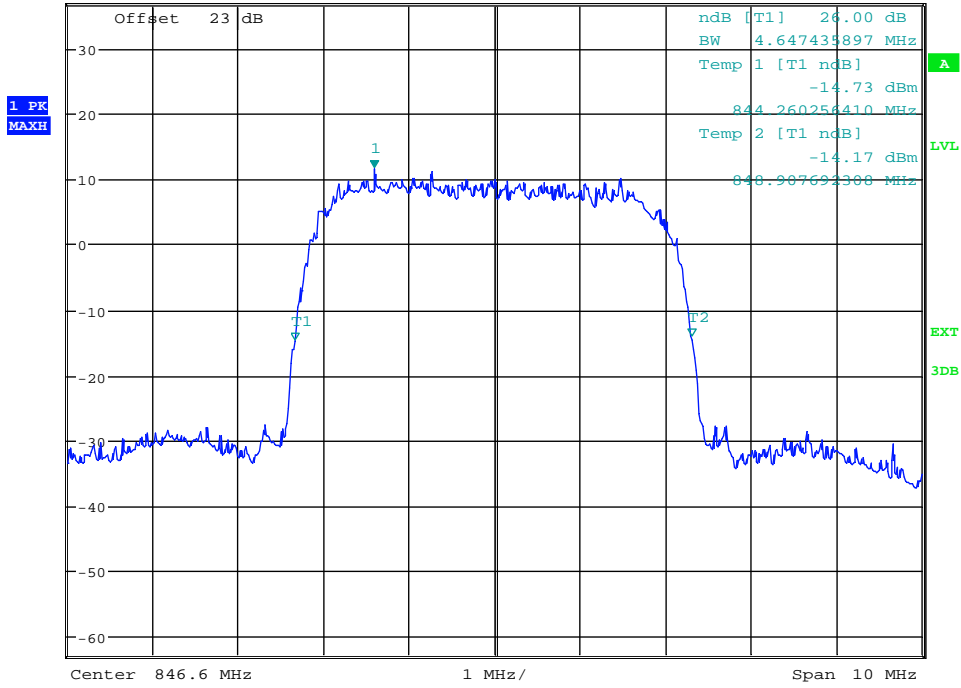

Date: 21.NOV.2013 14:28:26

(Plot 4.5.2 C: Channel 4233:846.6MHz @ WCDMA Band V)

4.6. BAND EDGE COMPLIANCE

TEST APPLICABLE

During the process of testing, the EUT was controlled via Rhode & Schwarz Digital Radio Communication tester (CMU-200) to ensure max power transmission and proper modulation.

TEST CONFIGURATION

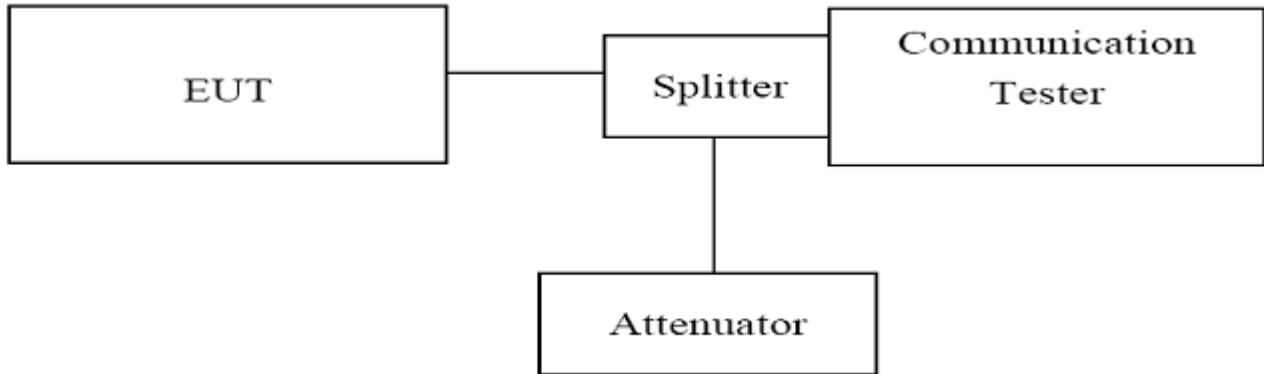

TEST PROCEDURE

1. The EUT was set up for the max output power with pseudo random data modulation;
2. The power was measured with Rhode & Schwarz Spectrum Analyzer FSU (peak);
3. Set RBW=5KHz,VBW=50KHz,Span=1MHz,SWT=300ms;
4. These measurements were done at 3 frequencies, 1850.20 MHz, 1880.00 MHz and 94009.80 MHz for WCDMA band II; 826.4 MHz, 836.6 MHz and 846.6 MHz for WCDMA band V. (low, middle and high of operational frequency range).

TEST RESULTS

WCDMA Band II						
Channel Number	Frequency (MHz)	Measurement Results		Limit (dBm)	Refer to Plot	Verdict
		Frequency (MHz)	Values (dBm)			
9262	1852.4	1850.00	-25.89	-13.00	Plot 4.6.1 A	PASS
9538	1907.6	1910.69	-24.64	-13.00	Plot 4.6.1 B	PASS



*RBW 50 kHz Marker 1 [T1]
*VBW 100 kHz -25.89 dBm
*SWT 800 ms 1.850000000 GHz

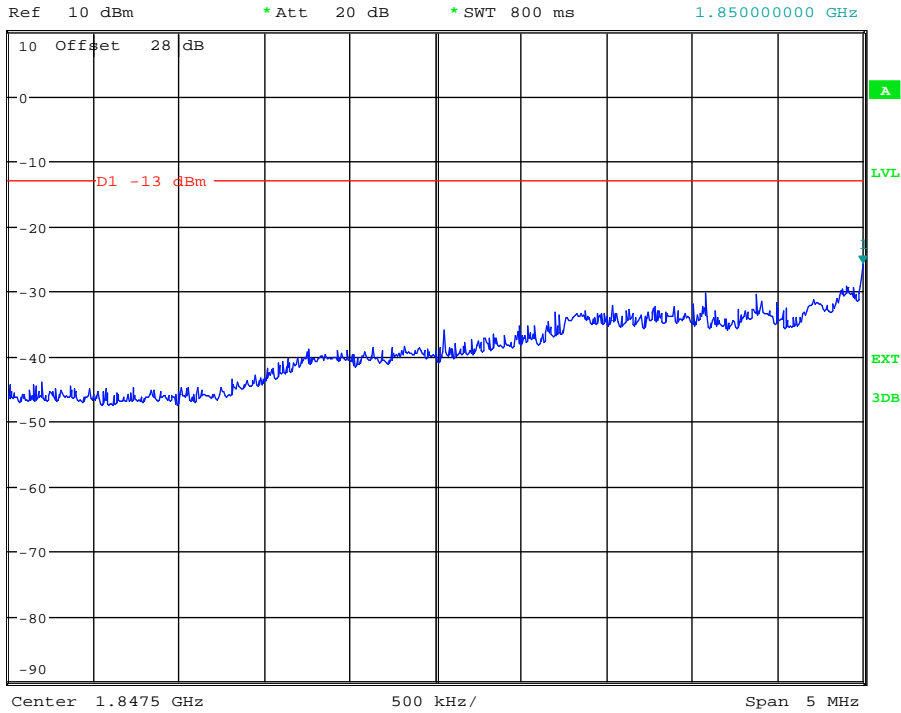

Date: 21.NOV.2013 13:56:34

(Plot 4.6.1 A: Channel 9262: 1852.4MHz WCDMA Band II)



*RBW 50 kHz Marker 1 [T1]
*VBW 100 kHz -24.64 dBm
*SWT 800 ms 1.910689103 GHz

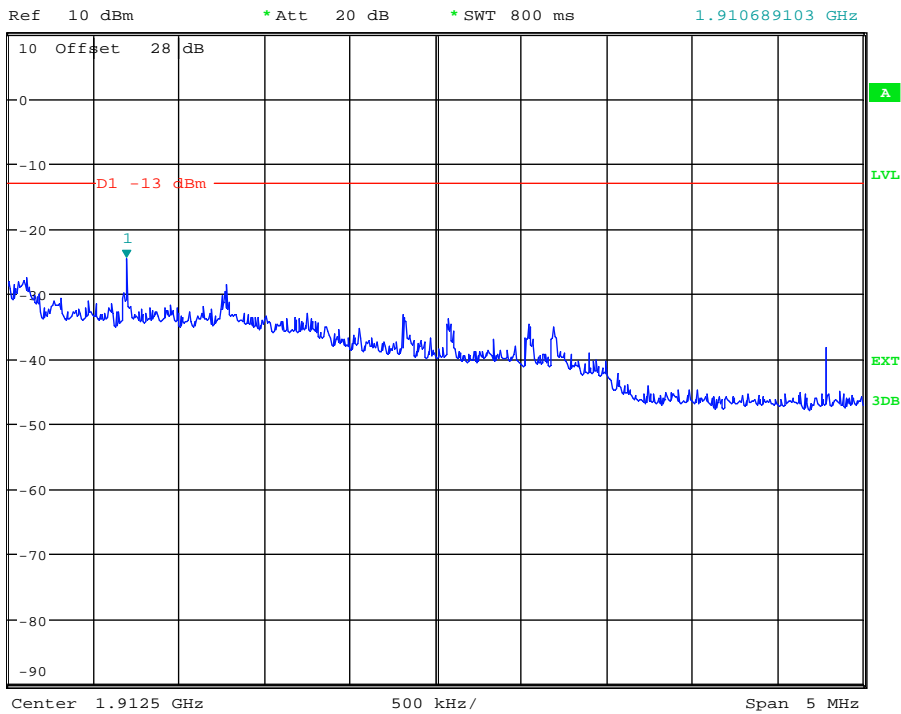

Date: 21.NOV.2013 13:55:27

(Plot 4.6.1 B: Channel 9538: 1907.6MHz WCDMA Band II)

WCDMA Band V						
Channel Number	Frequency (MHz)	Measurement Results		Limit (dBm)	Refer to Plot	Verdict
		Frequency (MHz)	Values (dBm)			
4132	826.4	824.00	-22.74	-13.00	Plot 4.6.2 A	PASS
4233	846.6	849.00	-26.02	-13.00	Plot 4.6.2 B	PASS

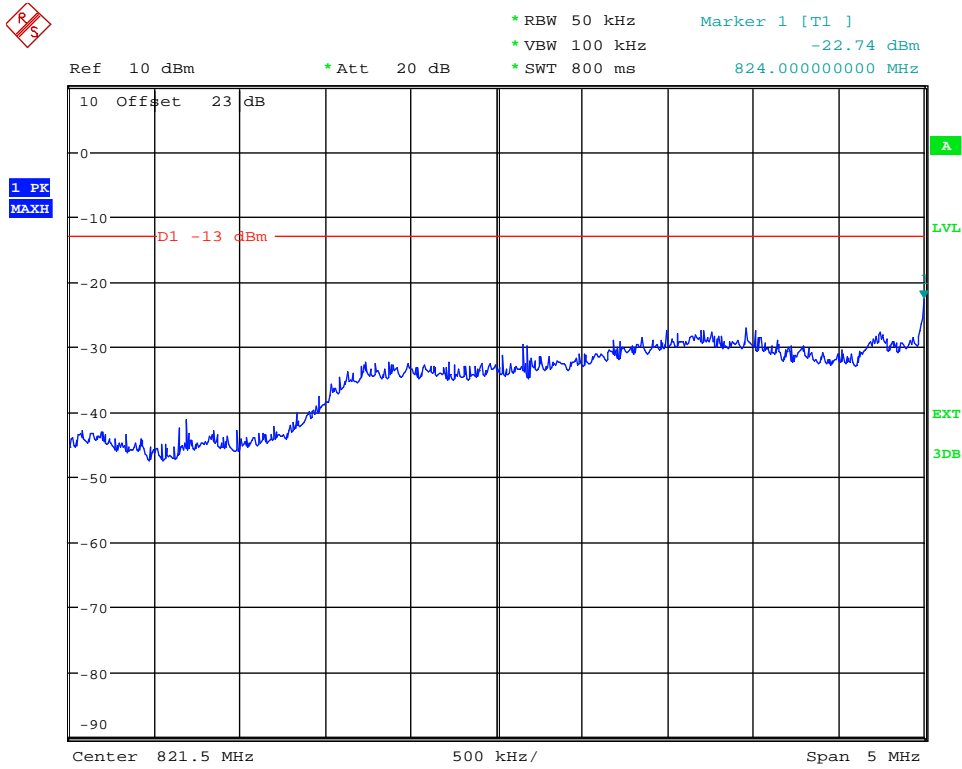

Date: 21.NOV.2013 14:30:49

(Plot 4.6.2 A: Channel 4132: 826.4MHz @ WCDMA Band V)



*RBW 50 kHz Marker 1 [T1]
*VBW 100 kHz -26.02 dBm
*SWT 800 ms 849.000000000 MHz

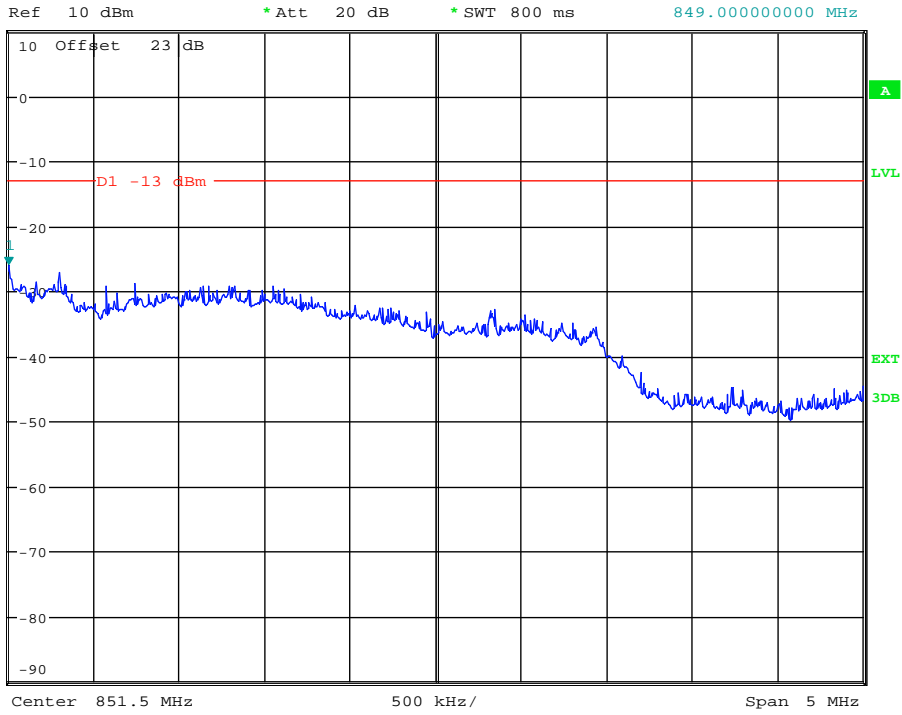

Date: 21.NOV.2013 14:31:27

(Plot 4.6.2 B: Channel 4233: 846.6MHz @ WCDMA Band V)

4.7. Spurious Emission on Antenna Port

TEST APPLICABLE

The following steps outline the procedure used to measure the conducted emissions from the EUT.

1. Determine frequency range for measurements: From CFR 2.1057 the spectrum should be investigated from the lowest radio frequency generated in the equipment up to at least the 10th harmonic of the carrier frequency. For the equipment of WCDMA band II, this equates to a frequency range of 30 MHz to 20GHz, data taken from 30 MHz to 20 GHz. For WCDMA Band V, data taken from 30 MHz to 10 GHz.
2. The sweep time is set automatically by instrument itself. That should be the optimal sweep time for the span and the RBW. If the sweep time is too short, that is sweep is too fast, the sweep result is not accurate; if the sweep time is too long, that is sweep is too low, some frequency components may be lost. The instrument will give a optimal sweep time according the selected span and RBW.
3. The procedure to get the conducted spurious emission is as follows:
The trace mode is set to MaxHold to get the highest signal at each frequency;
Wait 25 seconds;
Get the result.
4. Determine EUT transmit frequencies: below outlines the band edge frequencies pertinent to conducted emissions testing.

TEST CONFIGURATION

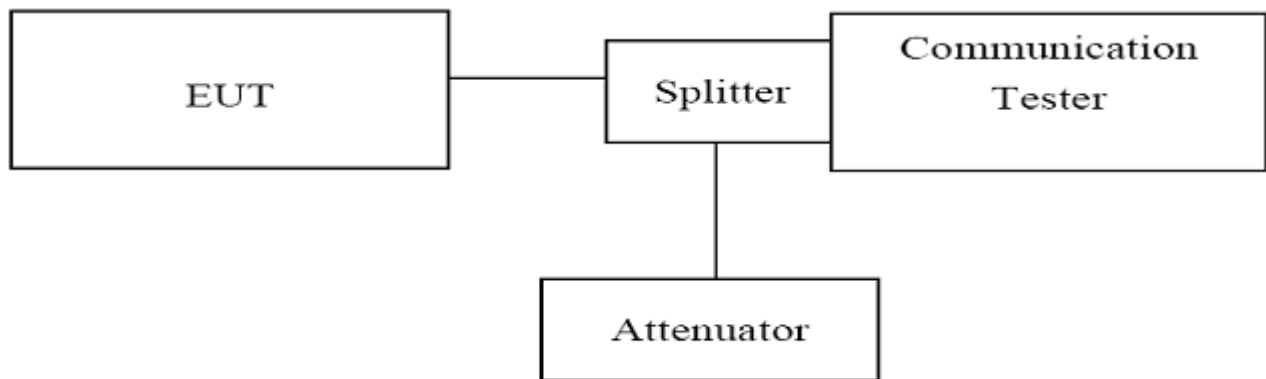

TEST PROCEDURE

1. The EUT was set up for the max output power with pseudo random data modulation;
2. The power was measured with Rhode & Schwarz Spectrum Analyzer FSU (peak);
3. These measurements were done at 3 frequencies, 1850.20 MHz, 1880.00 MHz and 1709.80 MHz for WCDMA band II; 826.4 MHz, 836.6 MHz and 846.6 MHz for WCDMA band V. (low, middle and high of operational frequency range).

TEST LIMIT

Part 24.238 and Part 22.917 specify that the power of any emission outside of the authorized operating frequency ranges must be attenuated below the transmitting power (P) by a factor of at least $43 + 10 \log(P)$ dB.

The specification that emissions shall be attenuated below the transmitter power (P) by at least $43 + 10 \log(P)$ dB, translates in the relevant power range (1 to 0.001 W) to -13 dBm. At 1 W the specified minimum attenuation becomes 43 dB and relative to a 30 dBm (1 W) carrier becomes a limit of -13 dBm. At 0.001 W (0 dBm) the minimum attenuation is 13 dB, which again yields a limit of -13 dBm. In this way a translation of the specification from relative to absolute terms is carried out.

TEST RESULTS

WCDMA Band II						
Channel Number: 9262		Test Frequency: 1852.4 MHz			Test Mode: Traffic	
Start Frequency (MHz)	Stop Frequency (MHz)	Measurement Results		Limit (dBm)	Refer to Plot	Verdict
		Frequency (MHz)	Values (dBm)			
30	1000	598.94	-32.95	-13.00	Plot 4.7.1 A1	PASS
1000	2500	***	***	-13.00	Plot 4.7.1 A2	PASS
2500	7500	2956.73	-29.81	-13.00	Plot 4.7.1 A3	PASS
7500	10000	9847.76	-31.49	-13.00	Plot 4.7.1 A4	PASS
10000	15000	12155.44	-30.83	-13.00	Plot 4.7.1 A5	PASS
15000	20000	17027.24	-30.24	-13.00	Plot 4.7.1 A6	PASS

WCDMA Band II						
Channel Number: 9400		Test Frequency: 1880.0 MHz			Test Mode: Traffic	
Start Frequency (MHz)	Stop Frequency (MHz)	Measurement Results		Limit (dBm)	Refer to Plot	Verdict
		Frequency (MHz)	Values (dBm)			
30	1000	972.02	-32.69	-13.00	Plot 4.7.2 A1	PASS
1000	2500	***	***	-13.00	Plot 4.7.2 A2	PASS
2500	7500	3549.68	-29.14	-13.00	Plot 4.7.2 A3	PASS
7500	10000	8133.02	-31.35	-13.00	Plot 4.7.2 A4	PASS
10000	15000	14719.55	-31.59	-13.00	Plot 4.7.2 A5	PASS
15000	20000	17323.71	-30.57	-13.00	Plot 4.7.2 A6	PASS

WCDMA Band II						
Channel Number: 9538		Test Frequency: 1907.6 MHz			Test Mode: Traffic	
Start Frequency (MHz)	Stop Frequency (MHz)	Measurement Results		Limit (dBm)	Refer to Plot	Verdict
		Frequency (MHz)	Values (dBm)			
30	1000	1000.00	-32.58	-13.00	Plot 4.7.3 A1	PASS
1000	2500	***	***	-13.00	Plot 4.7.3 A2	PASS
2500	7500	2588.14	-29.90	-13.00	Plot 4.7.3 A3	PASS
7500	10000	8405.49	-30.82	-13.00	Plot 4.7.3 A4	PASS
10000	15000	14286.86	-31.73	-13.00	Plot 4.7.3 A5	PASS
15000	20000	19823.72	-30.70	-13.00	Plot 4.7.3 A6	PASS

WCDMA Band II						
Test Mode: Idle						
Start Frequency (MHz)	Stop Frequency (MHz)	Measurement Results		Limit (dBm)	Refer to Plot	Verdict
		Frequency (MHz)	Values (dBm)			
30	1000	735.74	-32.93	-13.00	Plot 4.7.4 A1	PASS
1000	2500	2406.25	-30.54	-13.00	Plot 4.7.4 A2	PASS
2500	7500	3525.64	-29.42	-13.00	Plot 4.7.4 A3	PASS
7500	10000	8505.60	-31.36	-13.00	Plot 4.7.4 A4	PASS
10000	15000	13549.68	-31.20	-13.00	Plot 4.7.4 A5	PASS
15000	20000	17371.79	-31.02	-13.00	Plot 4.7.4 A6	PASS

Note: 1. In general, the worse case attenuation requirement shown above was applied.

2. *** means that the emission level is too low to be measured or at least 20 dB down than the limit.



*RBW 1 MHz Marker 1 [T1]
*VBW 3 MHz -32.95 dBm
SWT 2.5 ms 598.942307692 MHz

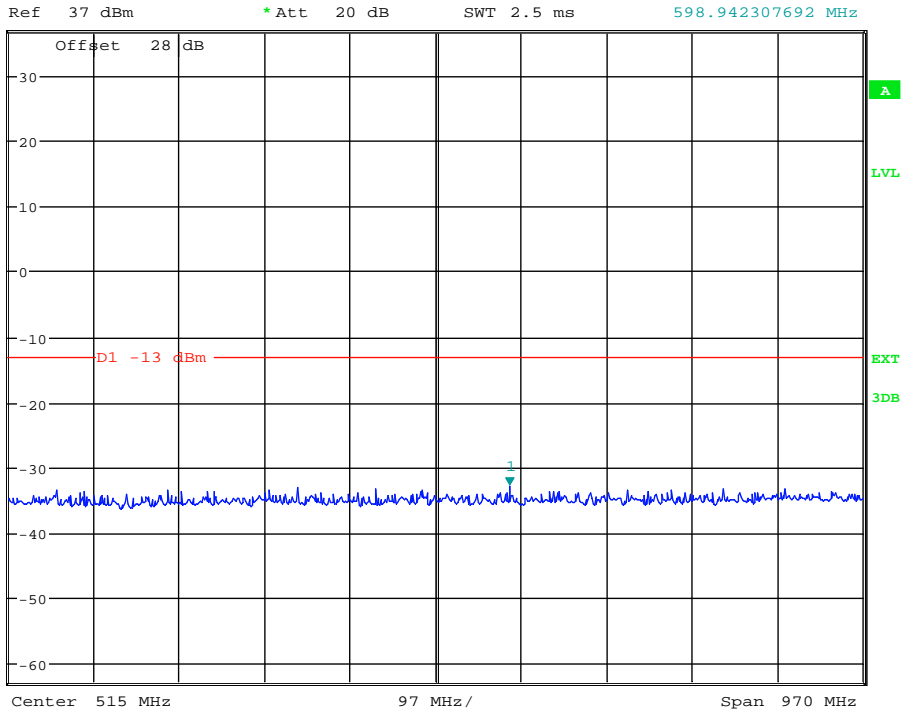

Date: 21.NOV.2013 13:58:03

(Plot 4.7.1 A1: Channel 9262: 1852.4MHz @ Traffic WCDMA Band II)



*RBW 1 MHz Marker 1 [T1]
*VBW 3 MHz 22.17 dBm
SWT 5 ms 1.850961538 GHz

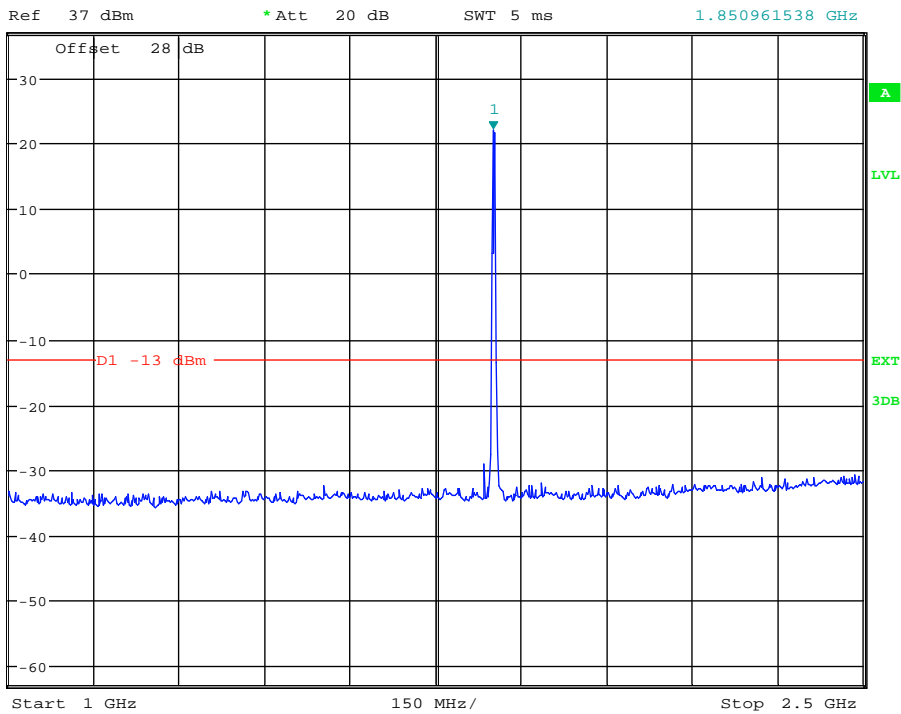

Date: 21.NOV.2013 13:58:38

(Plot 4.7.1 A2: Channel 9262: 1852.4MHz @ Traffic WCDMA Band II)



*RBW 1 MHz Marker 1 [T1]
*VBW 3 MHz -29.81 dBm
SWT 30 ms 2.956730769 GHz

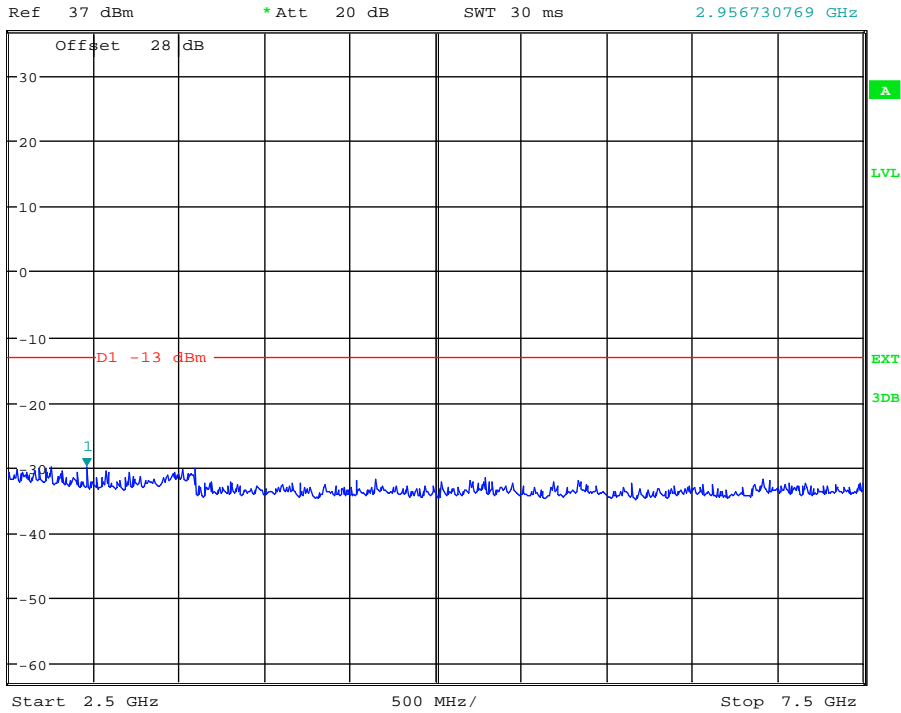

Date: 21.NOV.2013 13:59:03

(Plot 4.7.1 A3: Channel 9262: 1852.4MHz @ Traffic WCDMA Band II)



*RBW 1 MHz Marker 1 [T1]
*VBW 3 MHz -31.49 dBm
SWT 20 ms 9.847756410 GHz

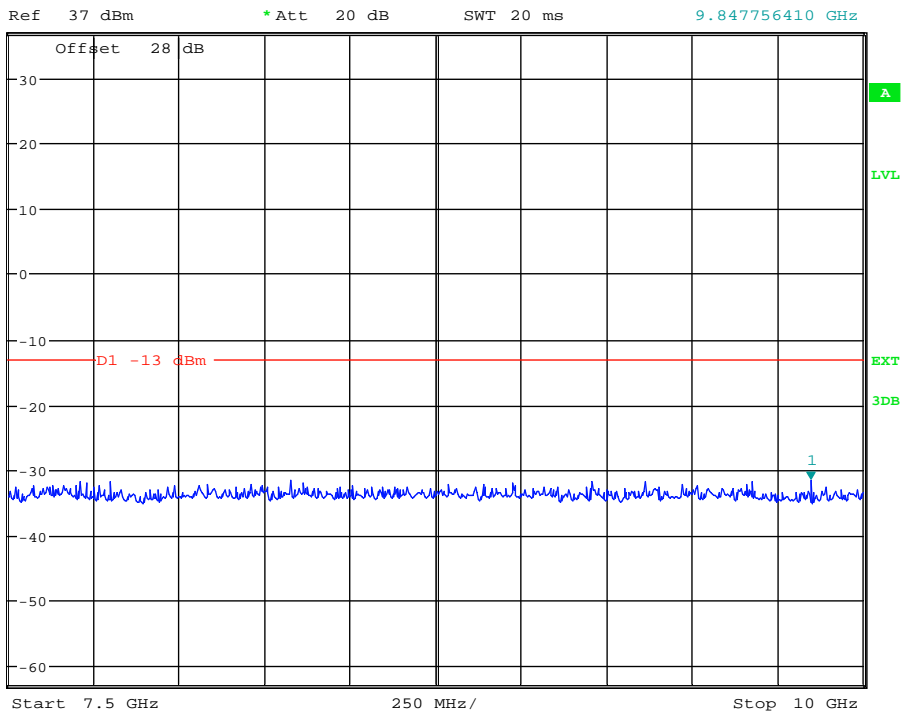

Date: 21.NOV.2013 13:59:19

(Plot 4.7.1 A4: Channel 9262: 1852.4MHz @ Traffic WCDMA Band II)



* RBW 1 MHz
 * VBW 3 MHz
 SWT 30 ms

Marker 1 [T1]
 -30.83 dBm
 12.155448718 GHz

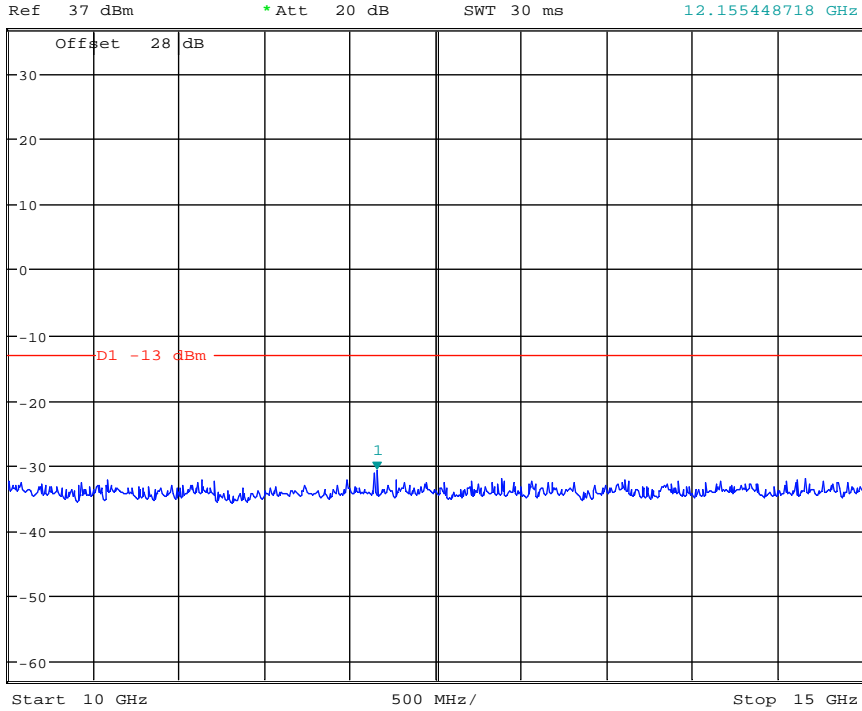

Date: 21.NOV.2013 13:59:31

(Plot 4.7.1 A5: Channel 9262: 1852.4MHz @ Traffic WCDMA Band II)



* RBW 1 MHz
 * VBW 3 MHz
 SWT 30 ms

Marker 1 [T1]
 -30.24 dBm
 17.027243590 GHz

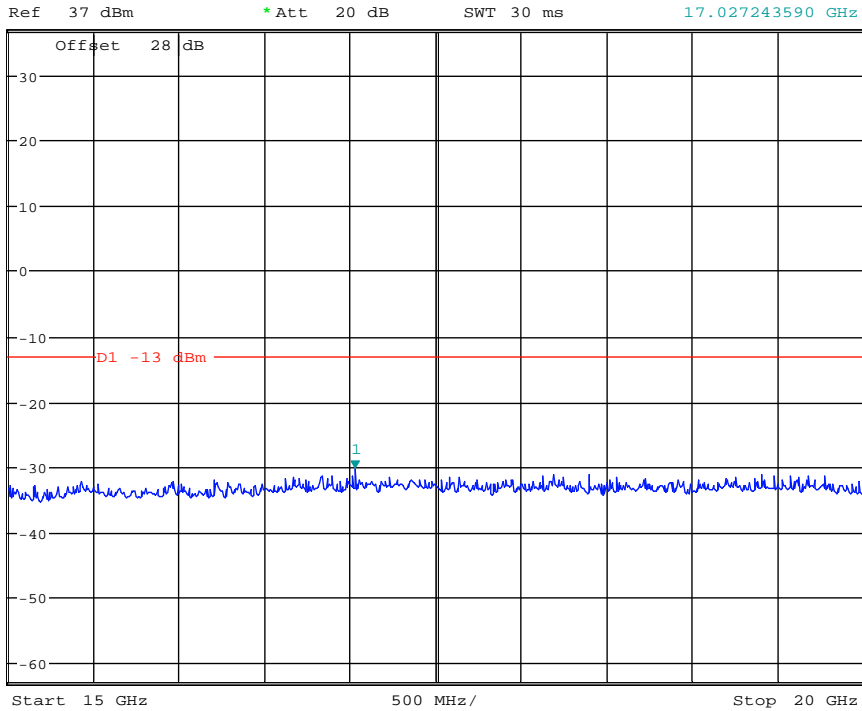

Date: 21.NOV.2013 13:59:42

(Plot 4.7.1 A6: Channel 9262: 1852.4MHz @ Traffic WCDMA Band II)



*RBW 1 MHz Marker 1 [T1]
*VBW 3 MHz -32.69 dBm
SWT 2.5 ms 972.019230769 MHz

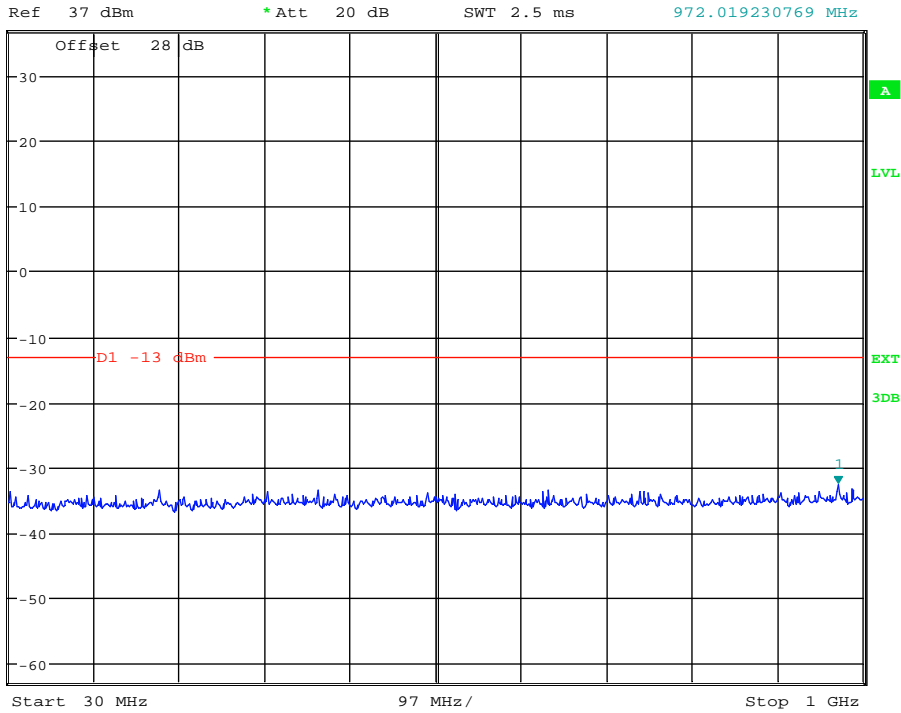

Date: 21.NOV.2013 14:00:05

(Plot 4.7.2 A1: Channel 9400: 1880.0MHz @ Traffic WCDMA Band II)



*RBW 1 MHz Marker 1 [T1]
*VBW 3 MHz 20.99 dBm
SWT 5 ms 1.879807692 GHz

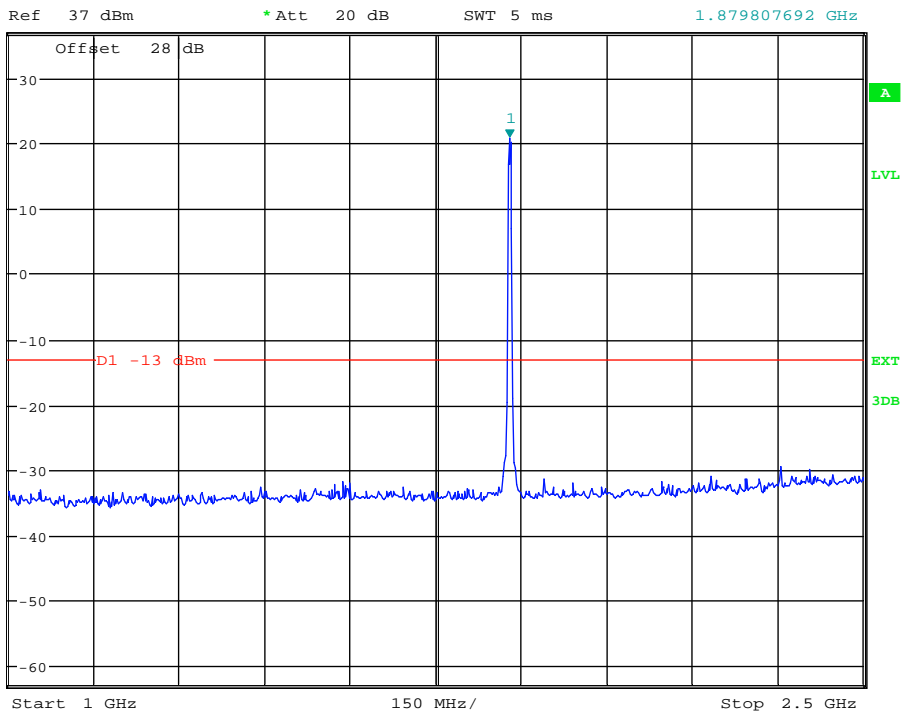

Date: 21.NOV.2013 14:00:42

(Plot 4.7.2 A2: Channel 9400: 1880.0MHz @ Traffic WCDMA Band II)



*RBW 1 MHz Marker 1 [T1]
*VBW 3 MHz -29.14 dBm
SWT 30 ms 3.549679487 GHz

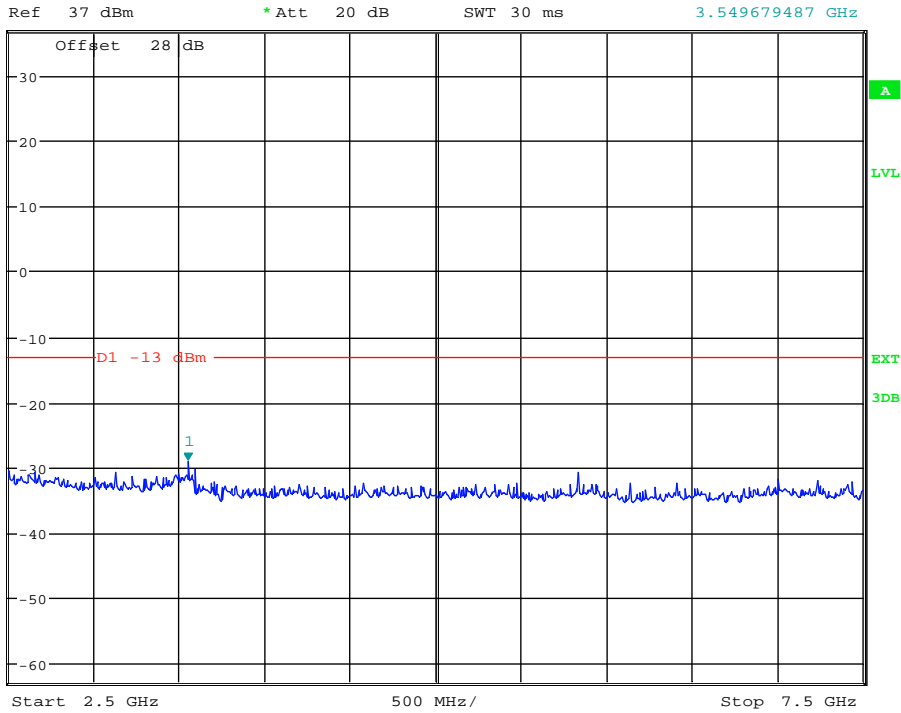

Date: 21.NOV.2013 14:00:58

(Plot 4.7.2 A3: Channel 9400: 1880.0MHz @ Traffic WCDMA Band II)



*RBW 1 MHz Marker 1 [T1]
*VBW 3 MHz -31.35 dBm
SWT 20 ms 8.133012821 GHz

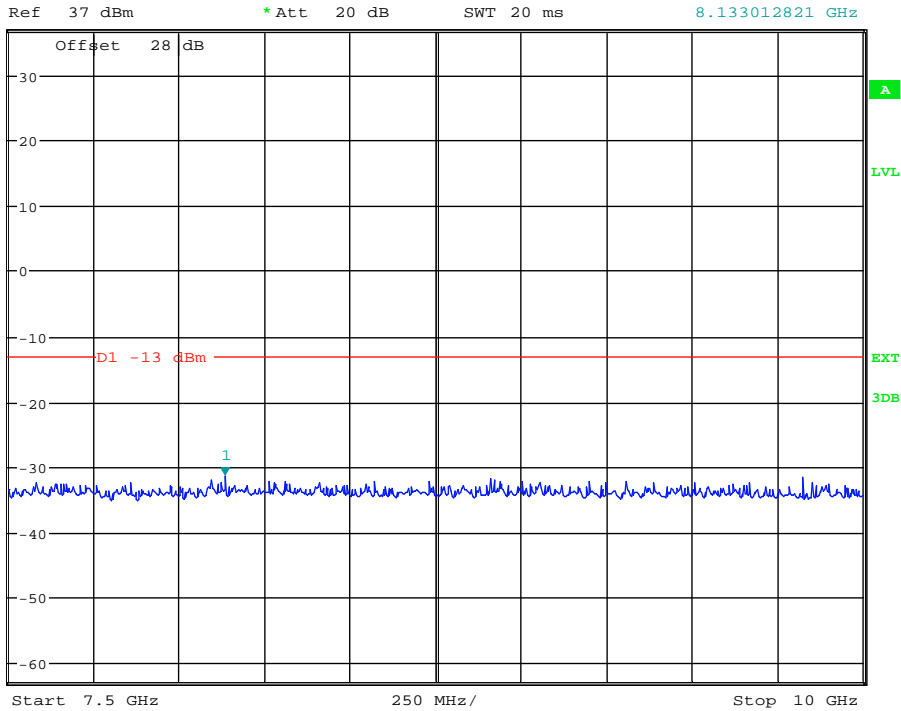

Date: 21.NOV.2013 14:01:08

(Plot 4.7.2 A4: Channel 9400: 1880.0MHz @ Traffic WCDMA Band II)



Ref 37 dBm * Att 20 dB * RBW 1 MHz Marker 1 [T1] -31.59 dBm
* VBW 3 MHz 14.719551282 GHz
SWT 30 ms

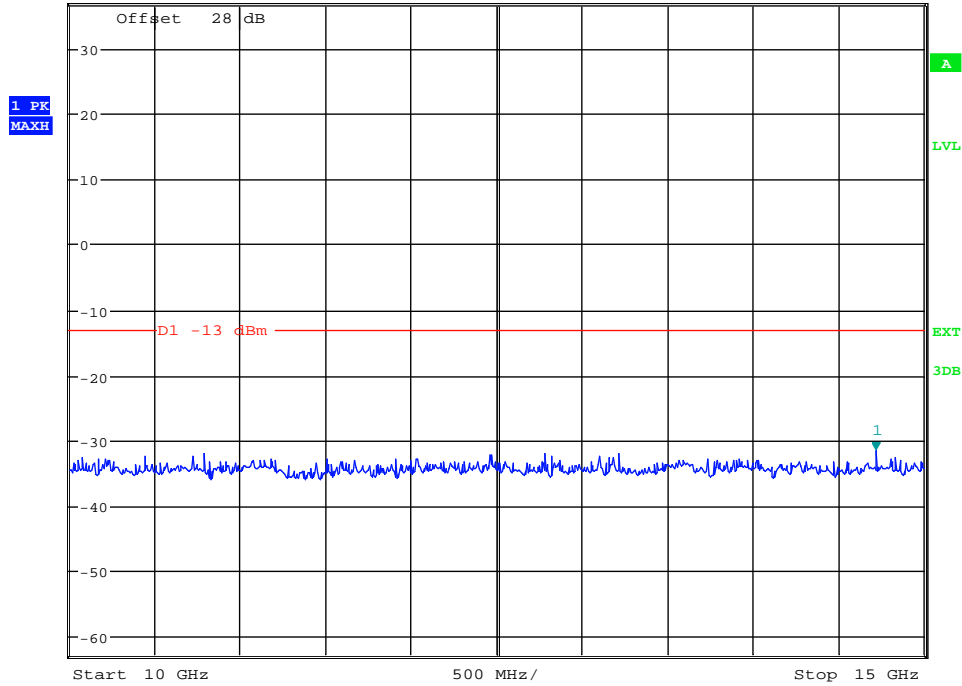

Date: 21.NOV.2013 14:01:19

(Plot 4.7.2 A5: Channel 9400: 1880.0MHz @ Traffic WCDMA Band II)



Ref 37 dBm * Att 20 dB * RBW 1 MHz Marker 1 [T1] -30.57 dBm
* VBW 3 MHz 17.323717949 GHz
SWT 30 ms

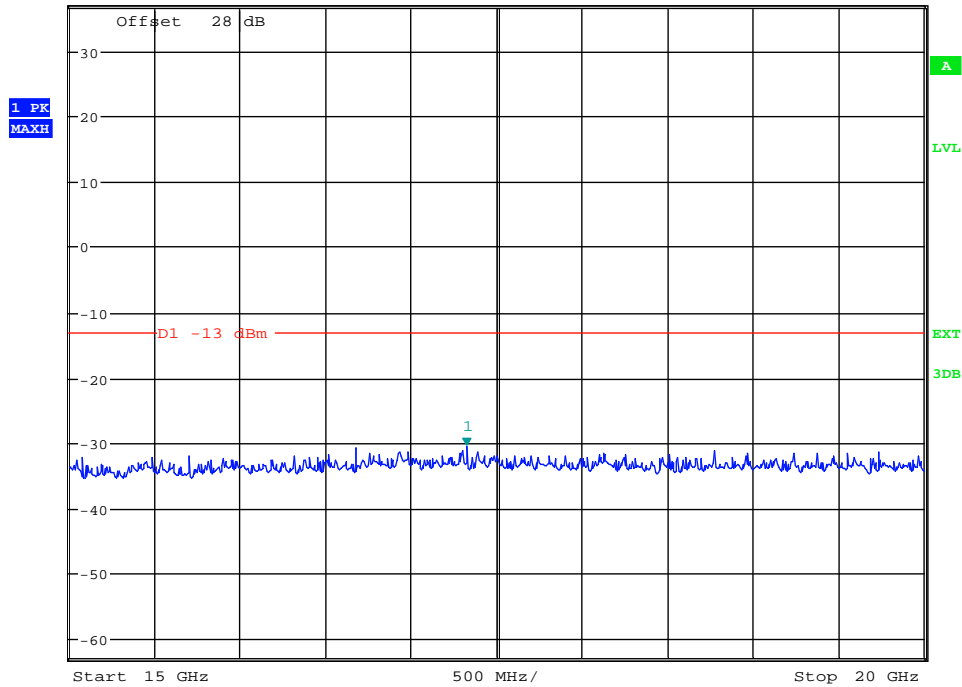

Date: 21.NOV.2013 14:01:30

(Plot 4.7.2 A6: Channel 9400: 1880.0MHz @ Traffic WCDMA Band II)



*RBW 1 MHz Marker 1 [T1]
*VBW 3 MHz -32.58 dBm
SWT 2.5 ms 1.000000000 GHz

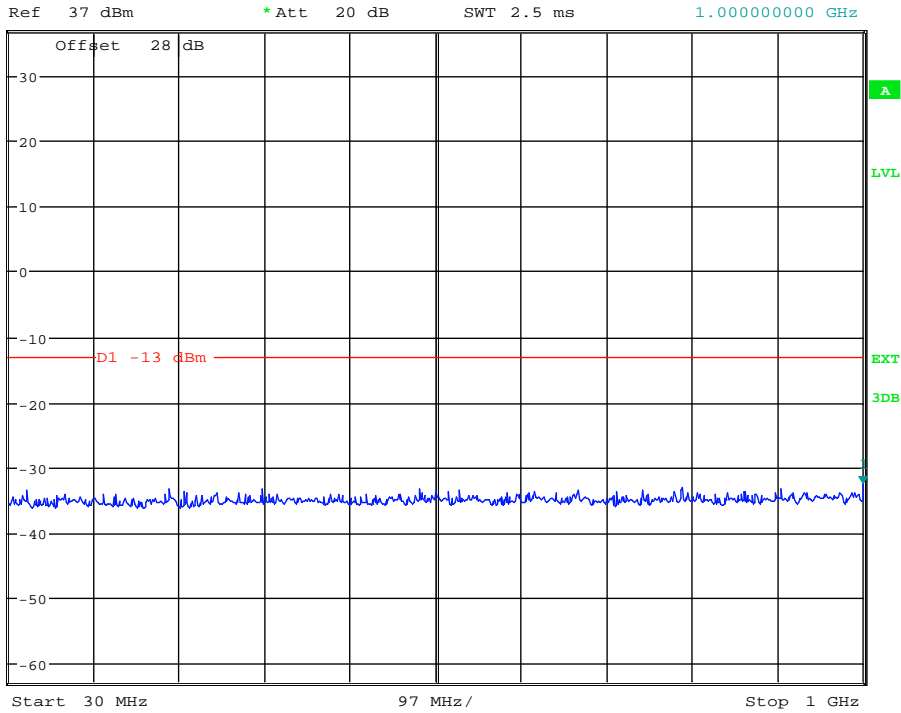

Date: 21.NOV.2013 14:02:01

(Plot 4.7.3 A1: Channel 9538: 1907.6MHz @ Traffic WCDMA Band II)



*RBW 1 MHz Marker 1 [T1]
*VBW 3 MHz 22.26 dBm
SWT 5 ms 1.908653846 GHz

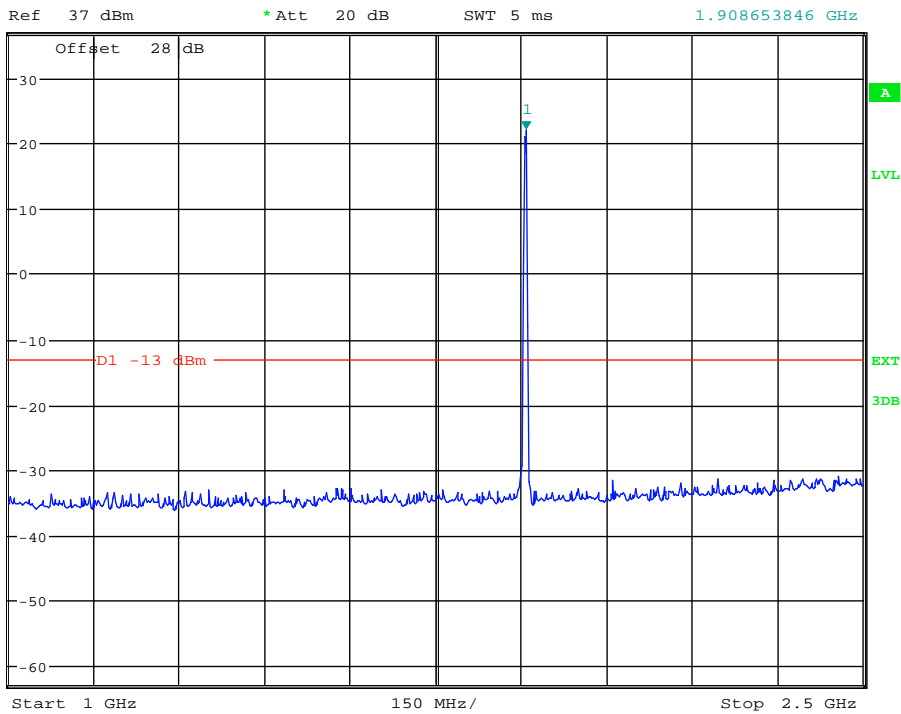

Date: 21.NOV.2013 14:02:16

(Plot 4.7.3 A2: Channel 9538: 1907.6MHz @ Traffic WCDMA Band II)



*RBW 1 MHz Marker 1 [T1]
*VBW 3 MHz -29.90 dBm
SWT 30 ms 2.588141026 GHz

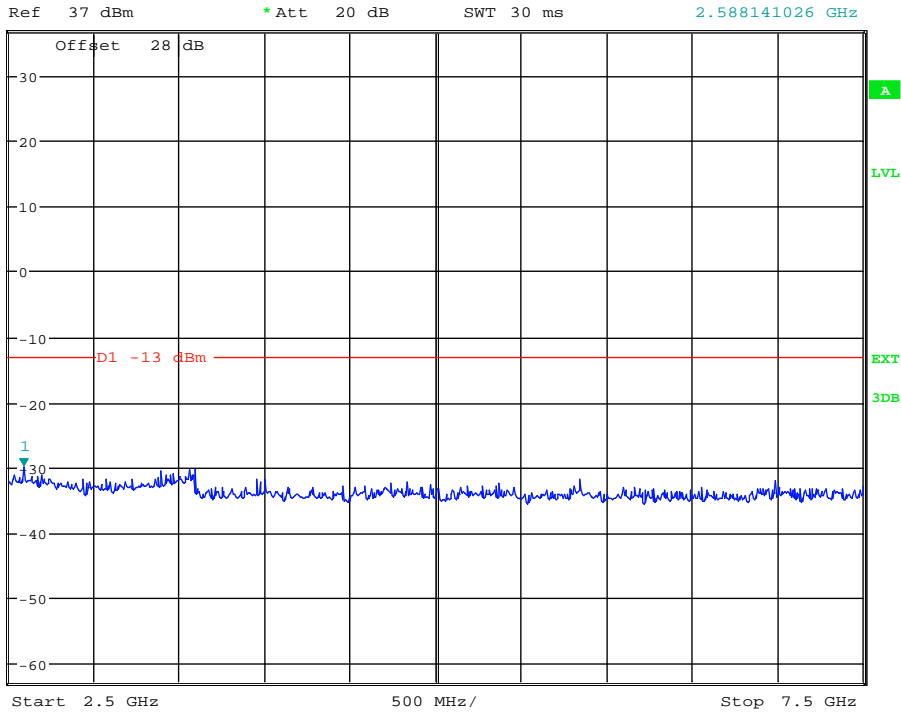

Date: 21.NOV.2013 14:02:28

(Plot 4.7.3 A3: Channel 9538: 1907.6MHz @ Traffic WCDMA Band II)



*RBW 1 MHz Marker 1 [T1]
*VBW 3 MHz -30.82 dBm
SWT 20 ms 8.405448718 GHz

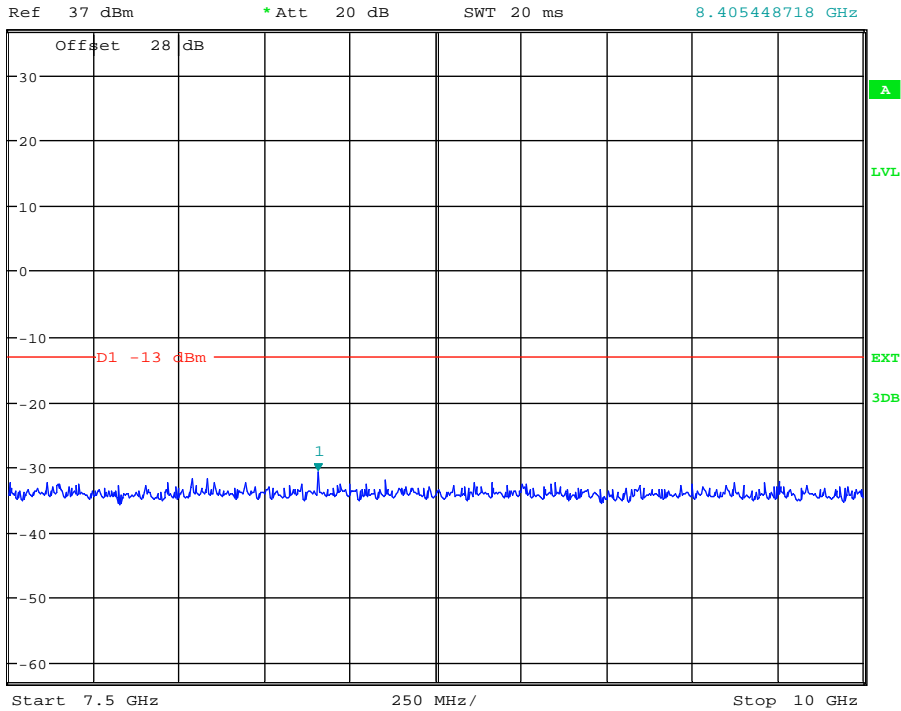

Date: 21.NOV.2013 14:02:40

(Plot 4.7.3 A4: Channel 9538: 1907.6MHz @ Traffic WCDMA Band II)



*RBW 1 MHz Marker 1 [T1]
*VBW 3 MHz -31.73 dBm
SWT 30 ms 14.286858974 GHz

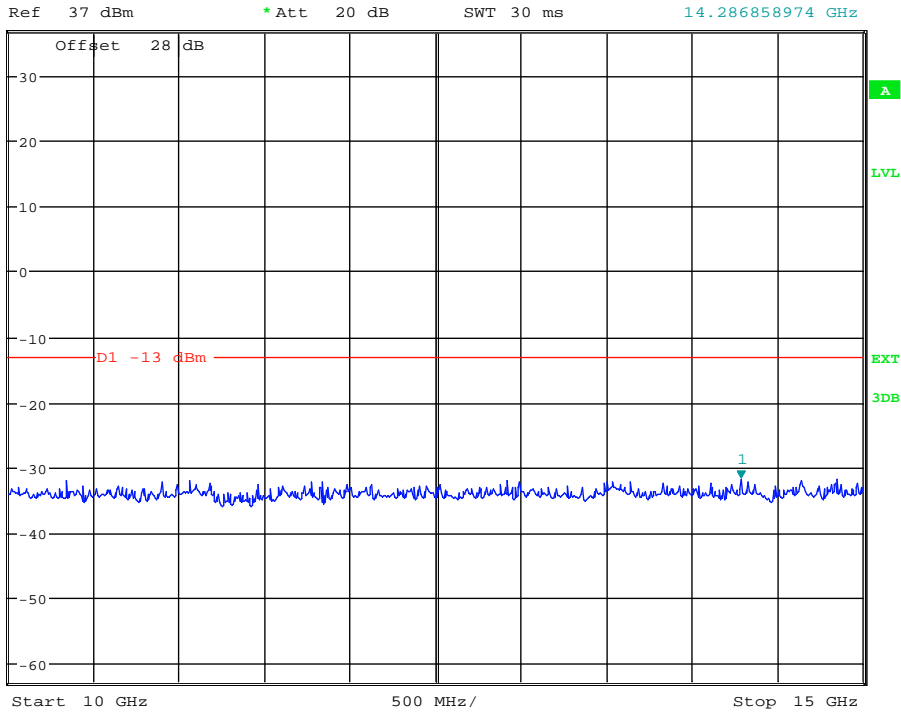

Date: 21.NOV.2013 14:02:54

(Plot 4.7.3 A5: Channel 9538: 1907.6MHz @ Traffic WCDMA Band II)



*RBW 1 MHz Marker 1 [T1]
*VBW 3 MHz -30.70 dBm
SWT 30 ms 19.823717949 GHz

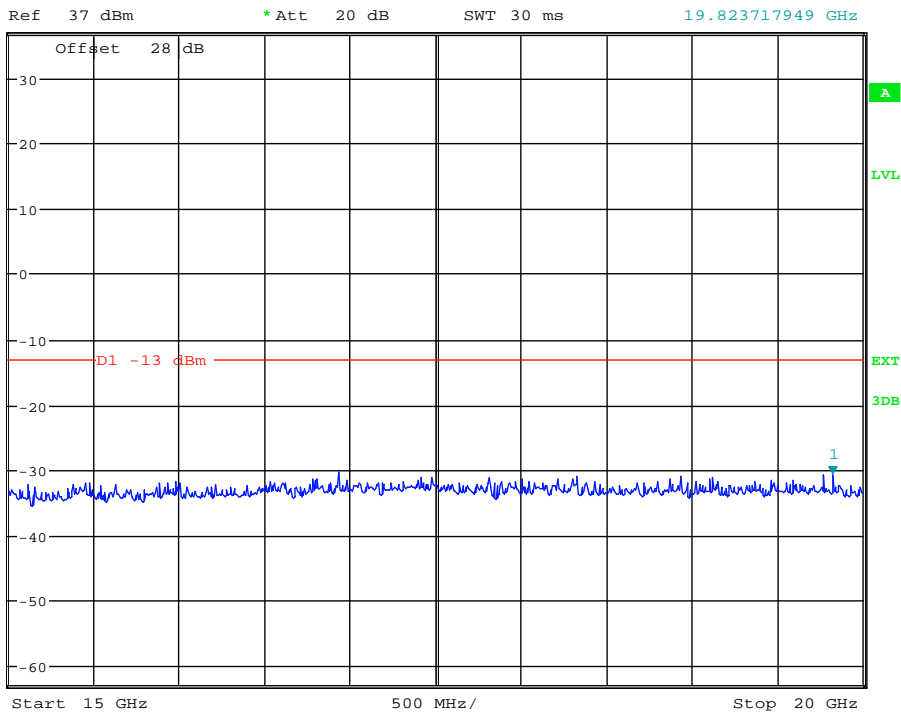

Date: 21.NOV.2013 14:03:09

(Plot 4.7.3 A6: Channel 9538: 1907.6MHz @ Traffic WCDMA Band II)



*RBW 1 MHz Marker 1 [T1]
*VBW 3 MHz -32.93 dBm
SWT 2.5 ms 735.737179487 MHz

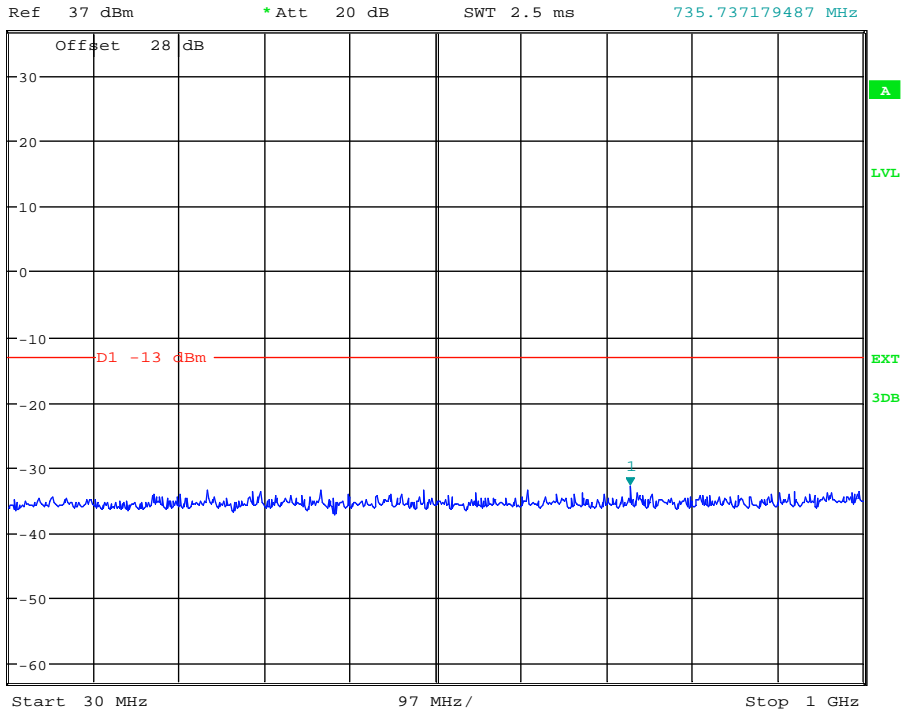

Date: 21.NOV.2013 14:03:43

(Plot 4.7.4 A1: Idle WCDMA Band II)



*RBW 1 MHz Marker 1 [T1]
*VBW 3 MHz -30.54 dBm
SWT 5 ms 2.406250000 GHz

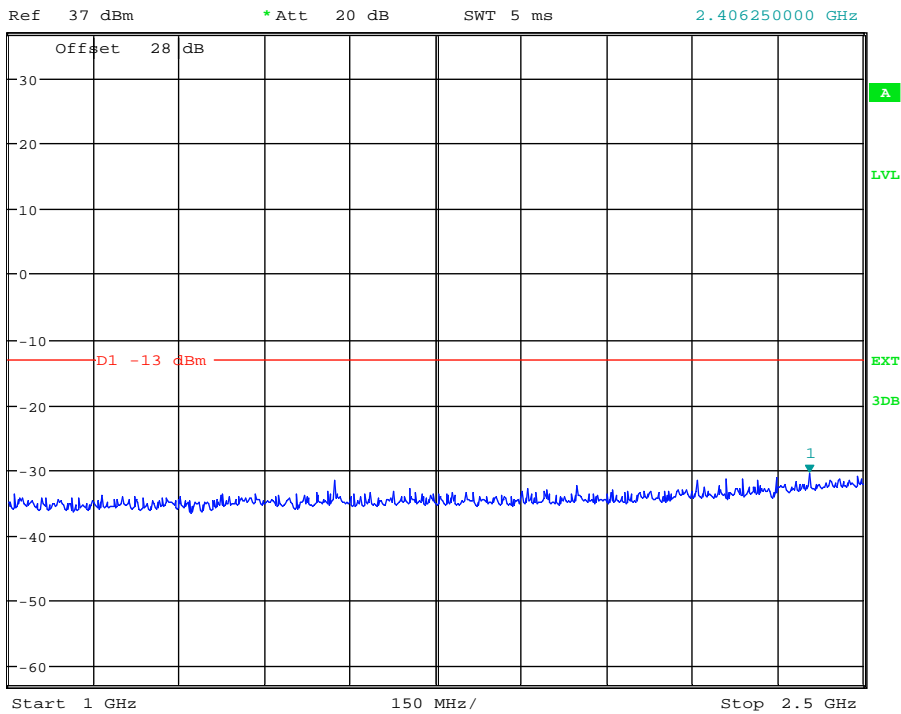

Date: 21.NOV.2013 14:03:55

(Plot 4.7.4 A2: Idle WCDMA Band II)



*RBW 1 MHz Marker 1 [T1]
*VBW 3 MHz -29.42 dBm
SWT 30 ms 3.525641026 GHz

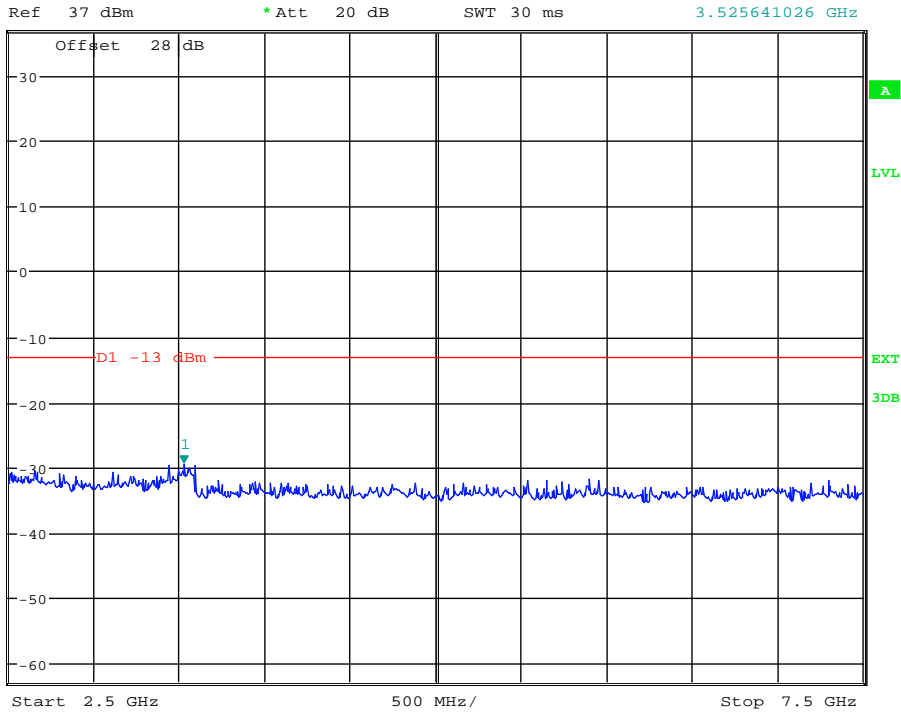

Date: 21.NOV.2013 14:04:06

(Plot 4.7.4 A3: Idle WCDMA Band II)



*RBW 1 MHz Marker 1 [T1]
*VBW 3 MHz -31.36 dBm
SWT 20 ms 8.505608974 GHz

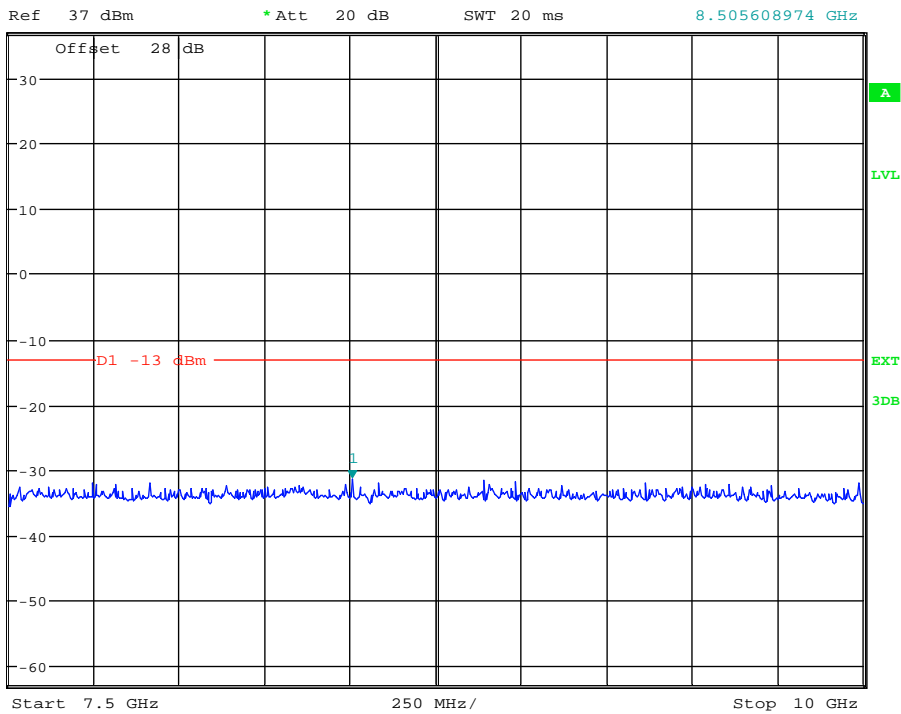

Date: 21.NOV.2013 14:04:18

(Plot 4.7.4 A4: Idle WCDMA Band II)



*RBW 1 MHz Marker 1 [T1]
*VBW 3 MHz -31.20 dBm
SWT 30 ms 13.549679487 GHz

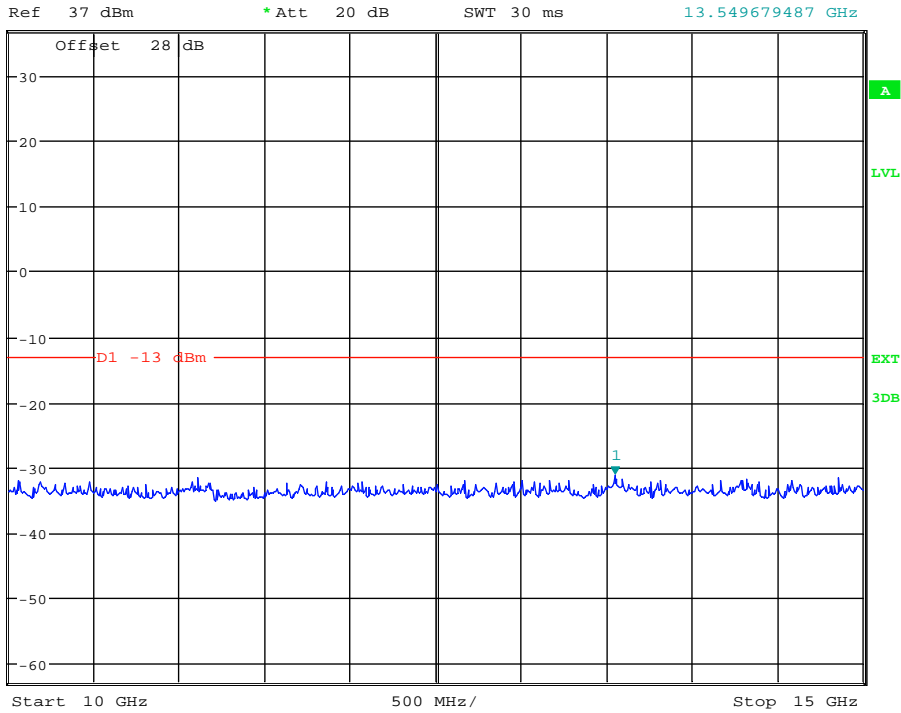

Date: 21.NOV.2013 14:04:35

(Plot 4.7.4 A5: Idle WCDMA Band II)



*RBW 1 MHz Marker 1 [T1]
*VBW 3 MHz -31.02 dBm
SWT 30 ms 17.371794872 GHz

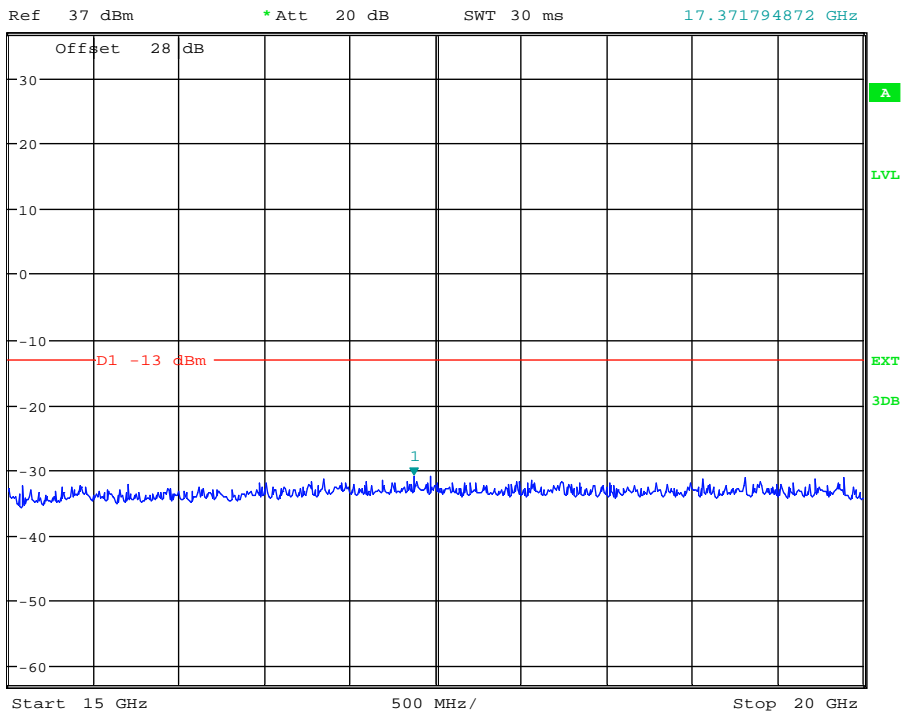

Date: 21.NOV.2013 14:04:47

(Plot 4.7.4 A6: Idle WCDMA Band II)

WCDMA Band V						
Channel Number: 4132		Test Frequency: 826.40 MHz			Test Mode: Traffic	
Start Frequency (MHz)	Stop Frequency (MHz)	Measurement Results		Limit (dBm)	Refer to Plot	Verdict
		Frequency (MHz)	Values (dBm)			
30	1000	***	***	-13.00	Plot 4.7.5 A1	PASS
1000	2500	2442.31	-34.72	-13.00	Plot 4.7.5 A2	PASS
2500	7500	2700.32	-33.95	-13.00	Plot 4.7.5 A3	PASS
7500	10000	8974.36	-35.15	-13.00	Plot 4.7.5 A4	PASS

WCDMA Band V						
Channel Number: 4183		Test Frequency: 836.60 MHz			Test Mode: Traffic	
Start Frequency (MHz)	Stop Frequency (MHz)	Measurement Results		Limit (dBm)	Refer to Plot	Verdict
		Frequency (MHz)	Values (dBm)			
30	1000	***	***	-13.00	Plot 4.7.6 A1	PASS
1000	2500	2334.13	-34.97	-13.00	Plot 4.7.6 A2	PASS
2500	7500	3533.65	-33.88	-13.00	Plot 4.7.6 A3	PASS
7500	10000	8705.93	-35.24	-13.00	Plot 4.7.6 A4	PASS

WCDMA Band V						
Channel Number: 4233		Test Frequency: 846.60 MHz			Test Mode: Traffic	
Start Frequency (MHz)	Stop Frequency (MHz)	Measurement Results		Limit (dBm)	Refer to Plot	Verdict
		Frequency (MHz)	Values (dBm)			
30	1000	***	***	-13.00	Plot 4.7.7 A1	PASS
1000	2500	2492.79	-34.45	-13.00	Plot 4.7.7 A2	PASS
2500	7500	3549.68	-33.58	-13.00	Plot 4.7.7 A3	PASS
7500	10000	9166.67	-34.87	-13.00	Plot 4.7.7 A4	PASS

WCDMA Band V						
Test Mode: Idle						
Start Frequency (MHz)	Stop Frequency (MHz)	Measurement Results		Limit (dBm)	Refer to Plot	Verdict
		Frequency (MHz)	Values (dBm)			
30	1000	967.36	-35.76	-13.00	Plot 4.7.8 A1	PASS
1000	2500	2449.52	-34.41	-13.00	Plot 4.7.8 A2	PASS
2500	7500	2628.21	-33.16	-13.00	Plot 4.7.8 A3	PASS
7500	10000	7632.21	-34.25	-13.00	Plot 4.7.8 A4	PASS

Note: 1. In general, the worse case attenuation requirement shown above was applied.

2. *** means that the emission level is too low to be measured or at least 20 dB down than the limit.



Ref 37 dBm * Att 20 dB * RBW 1 MHz Marker 1 [T1] 20.69 dBm
* VBW 3 MHz 827.451923077 MHz
SWT 2.5 ms

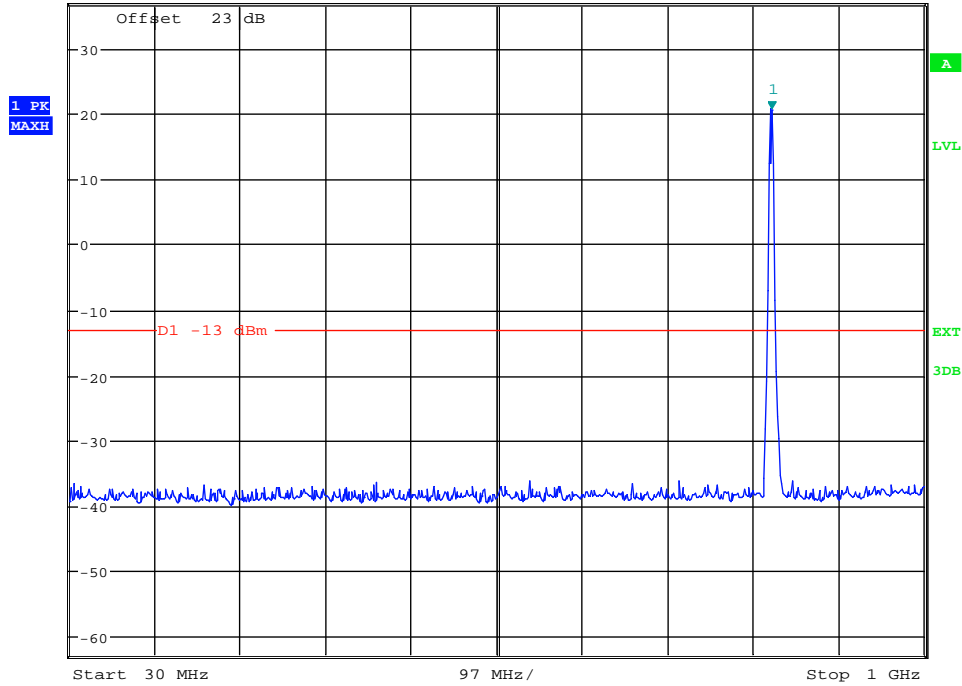

Date: 21.NOV.2013 14:34:59

(Plot 4.7.5 A1: Channel 4132: 826.40 MHz @ WCDMA Band V)



Ref 37 dBm * Att 20 dB * RBW 1 MHz Marker 1 [T1] -34.72 dBm
* VBW 3 MHz 2.442307692 GHz
SWT 5 ms

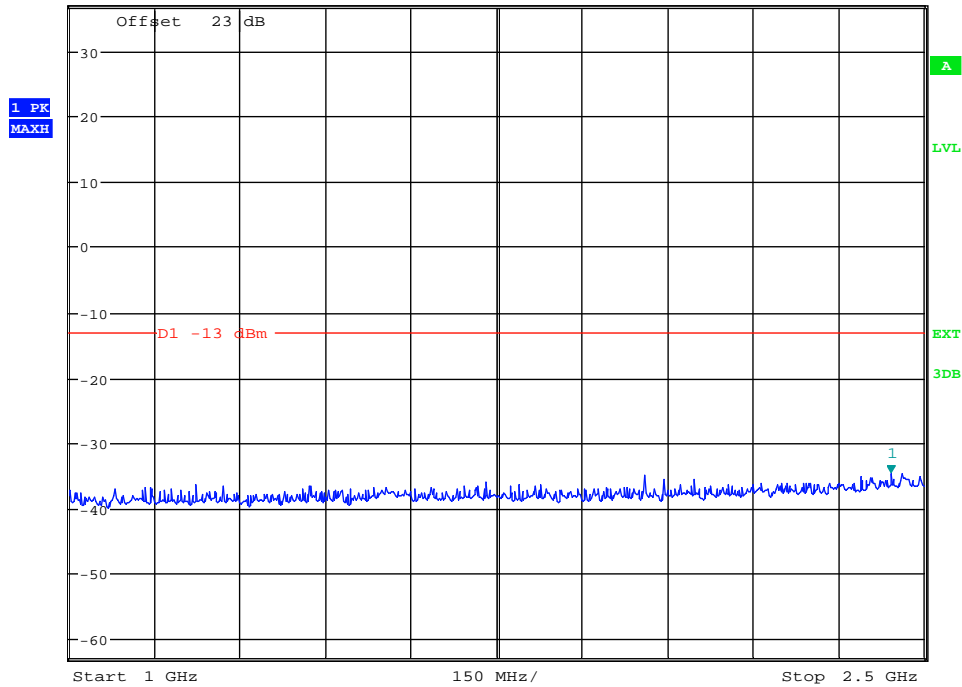

Date: 21.NOV.2013 14:35:16

(Plot 4.7.5 A2: Channel 4132: 826.40 MHz @ WCDMA Band V)



*RBW 1 MHz Marker 1 [T1]
*VBW 3 MHz -33.95 dBm
SWT 30 ms 2.700320513 GHz

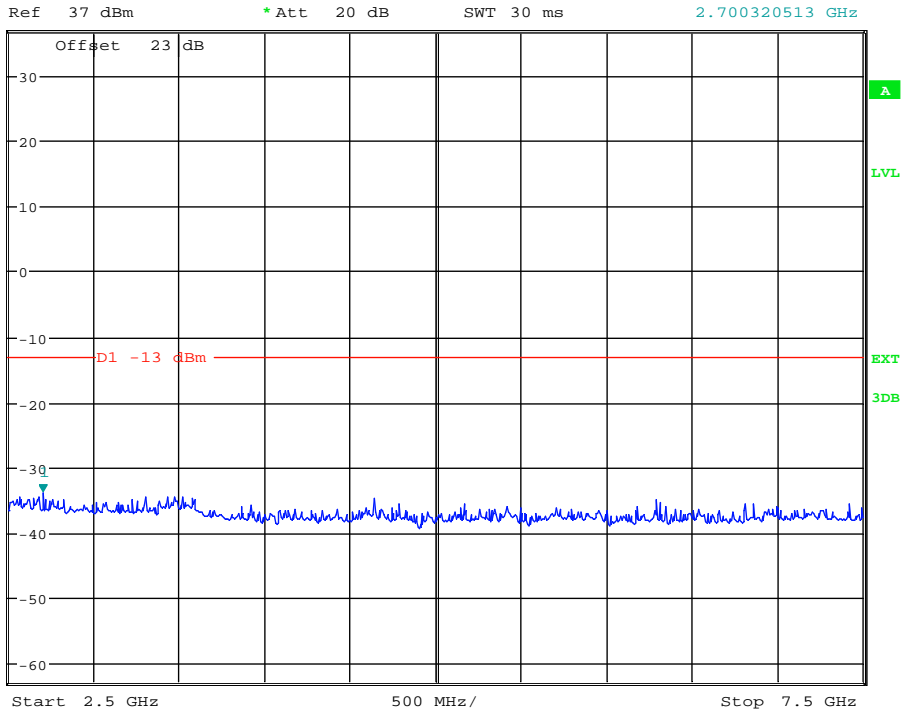

Date: 21.NOV.2013 14:35:28

(Plot 4.7.5 A3: Channel 4132: 826.40 MHz @ WCDMA Band V)



*RBW 1 MHz Marker 1 [T1]
*VBW 3 MHz -35.15 dBm
SWT 20 ms 8.974358974 GHz

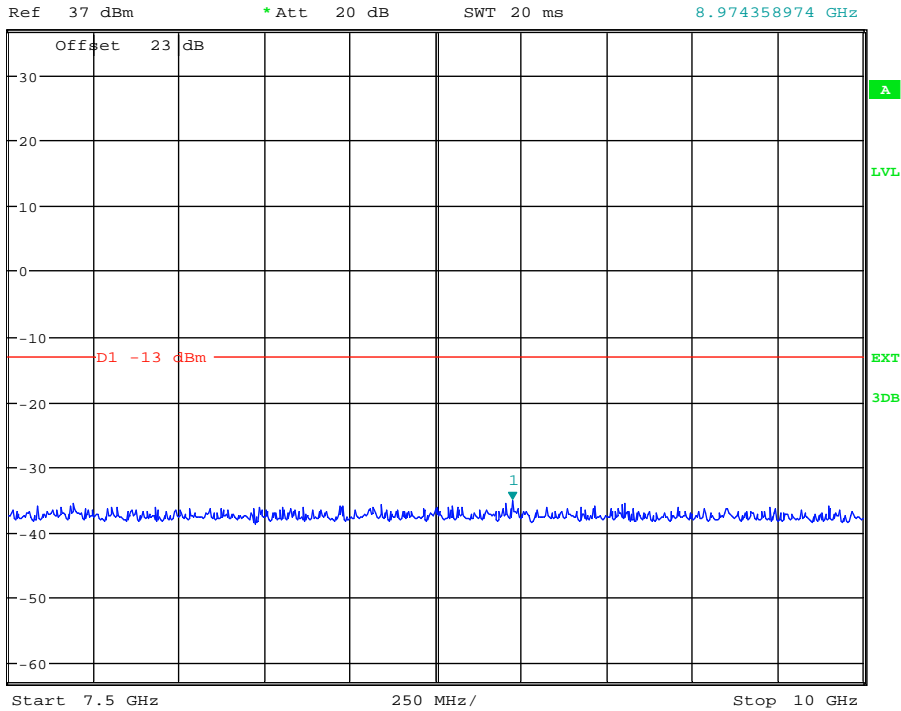

Date: 21.NOV.2013 14:35:42

(Plot 4.7.5 A4: Channel 4132: 826.40 MHz @ WCDMA Band V)



Ref 37 dBm * Att 20 dB * RBW 1 MHz Marker 1 [T1]
* VBW 3 MHz 20.54 dBm
SWT 2.5 ms 836.778846154 MHz

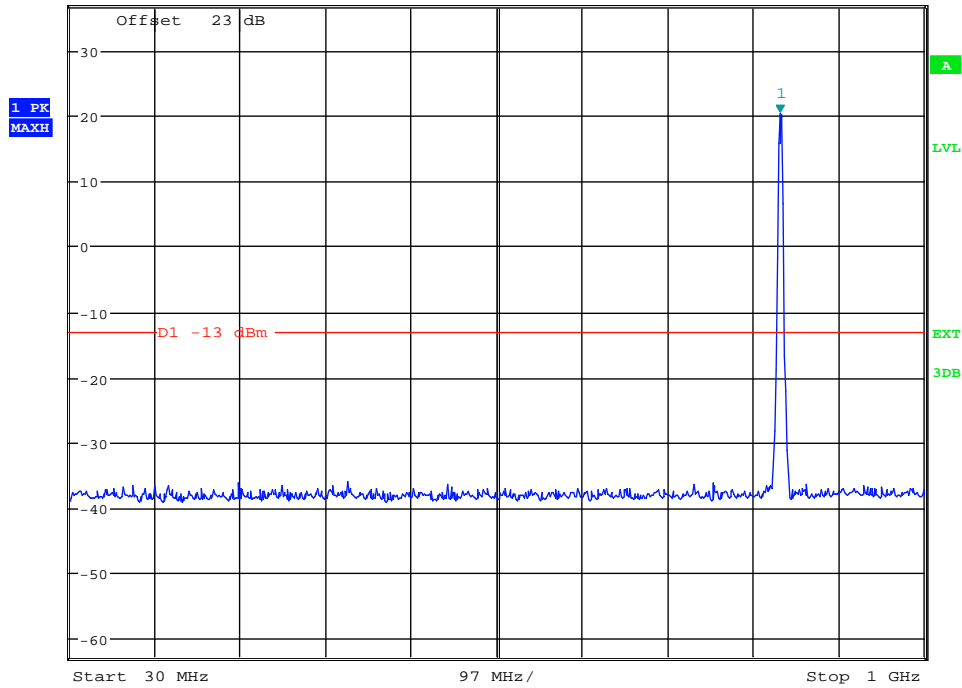

Date: 21.NOV.2013 14:33:50

(Plot 4.7.6 A1: Channel 4183: 836.60 MHz @ WCDMA Band V)



Ref 37 dBm * Att 20 dB * RBW 1 MHz Marker 1 [T1]
* VBW 3 MHz -34.97 dBm
SWT 5 ms 2.334134615 GHz

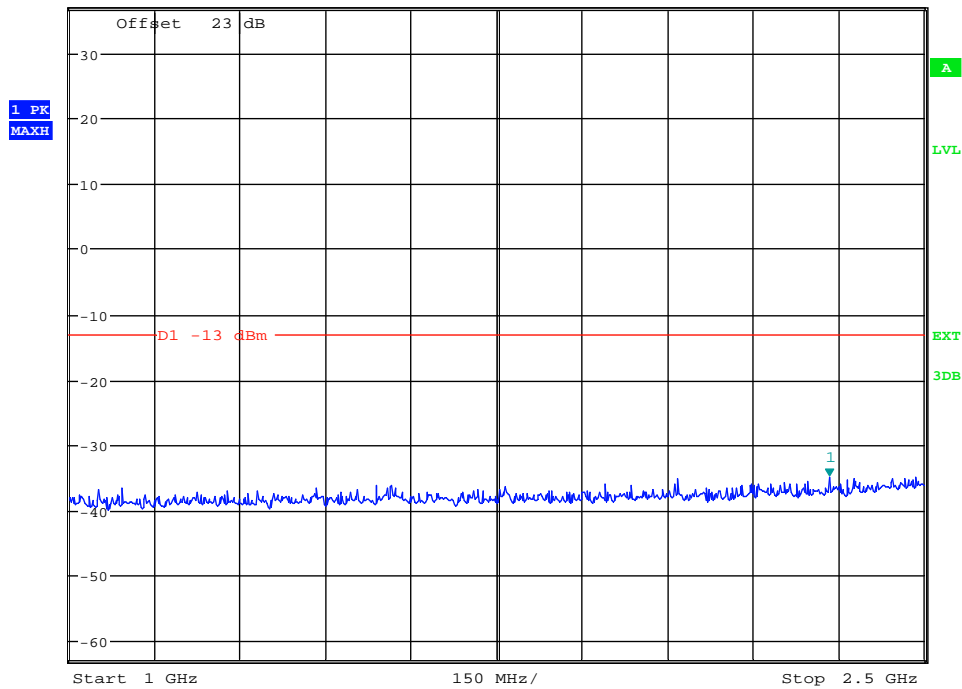

Date: 21.NOV.2013 14:34:05

(Plot 4.7.6 A2: Channel 4183: 836.60 MHz @ WCDMA Band V)



*RBW 1 MHz Marker 1 [T1]
*VBW 3 MHz -33.88 dBm
SWT 30 ms 3.533653846 GHz

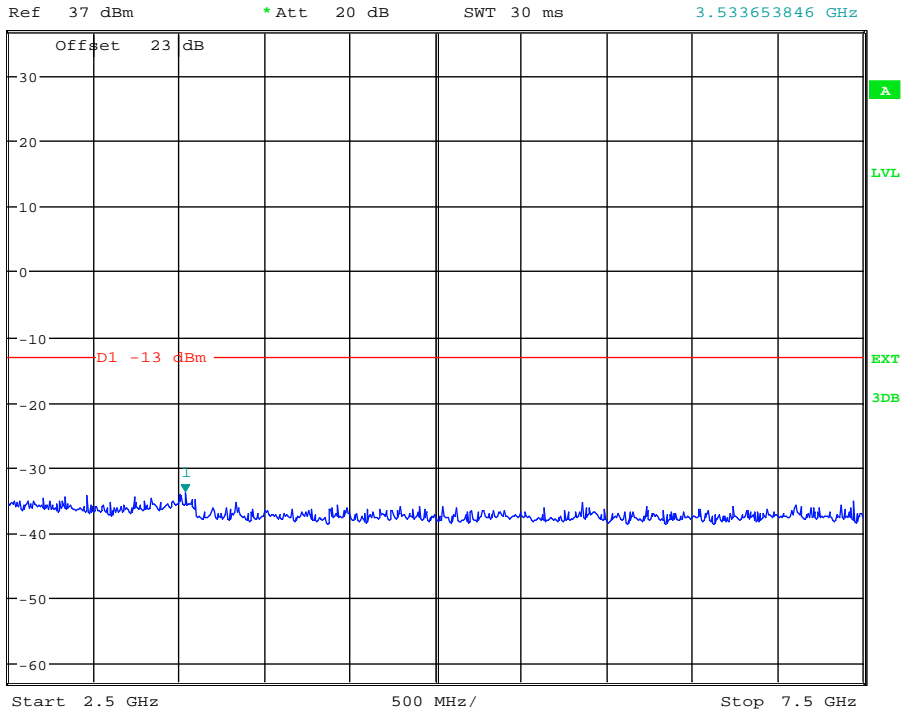

Date: 21.NOV.2013 14:34:18

(Plot 4.7.6 A3: Channel 4183: 836.60 MHz @ WCDMA Band V)



*RBW 1 MHz Marker 1 [T1]
*VBW 3 MHz -35.24 dBm
SWT 20 ms 8.705929487 GHz

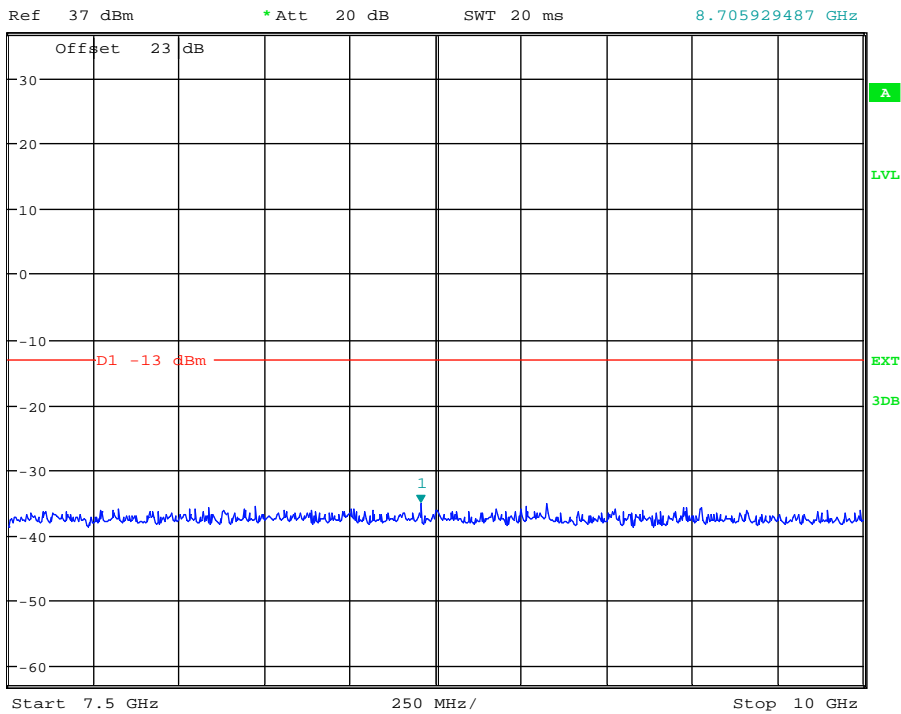

Date: 21.NOV.2013 14:34:28

(Plot 4.7.6 A4: Channel 4183: 836.60 MHz @ WCDMA Band V)



*RBW 1 MHz Marker 1 [T1]
*VBW 3 MHz 20.98 dBm
SWT 2.5 ms 846.105769231 MHz

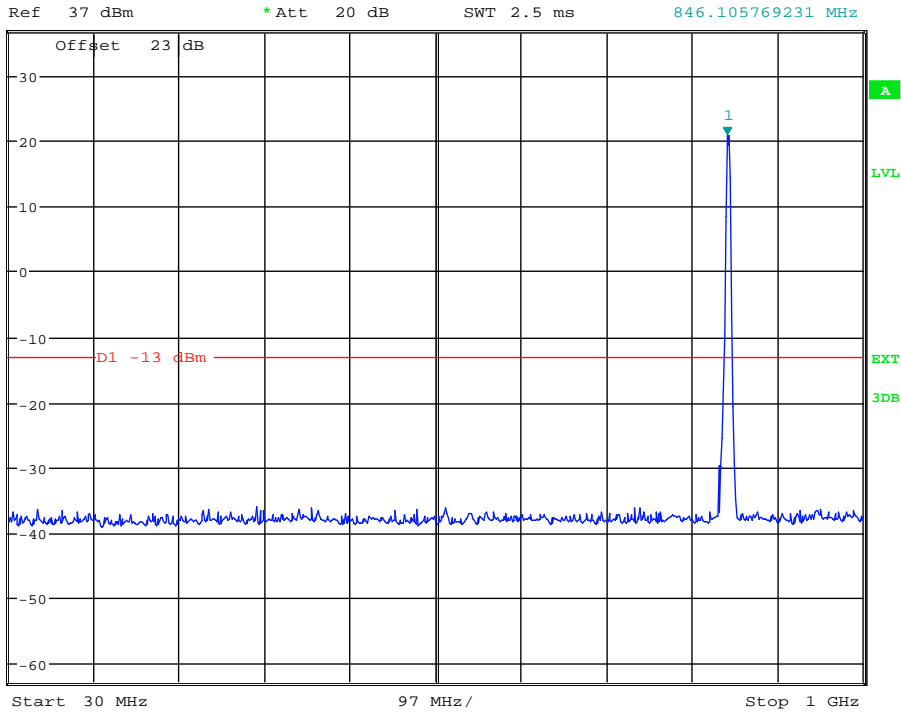

Date: 21.NOV.2013 14:32:19

(Plot 4.7.7 A1: Channel 4233: 846.60 MHz @ WCDMA Band V)



*RBW 1 MHz Marker 1 [T1]
*VBW 3 MHz -34.45 dBm
SWT 5 ms 2.492788462 GHz

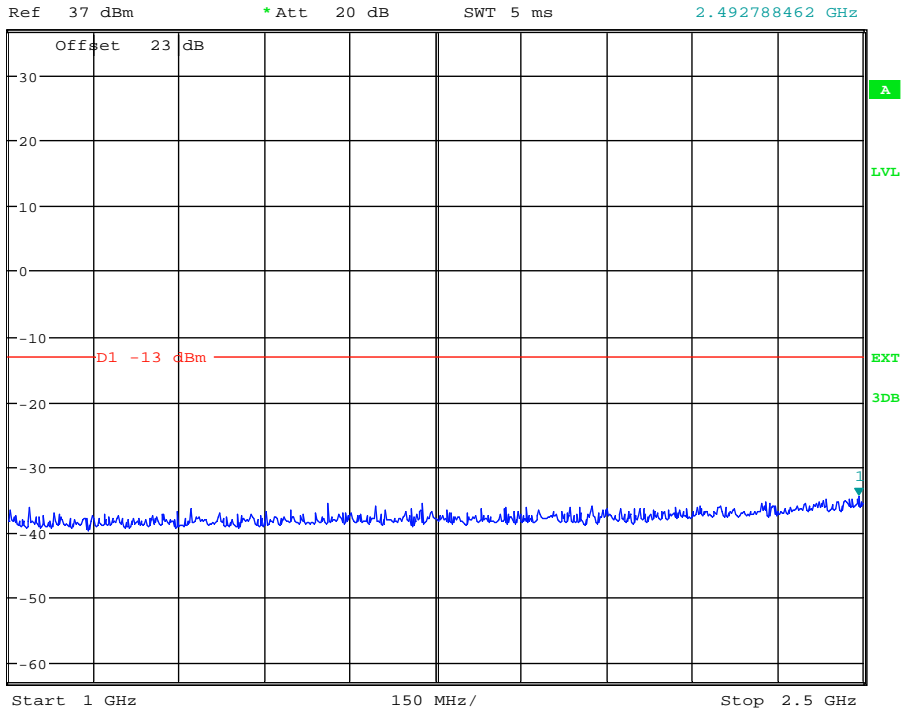

Date: 21.NOV.2013 14:32:31

(Plot 4.7.7 A2: Channel 4233: 846.60 MHz @ WCDMA Band V)



*RBW 1 MHz Marker 1 [T1]
*VBW 3 MHz -33.58 dBm
SWT 30 ms 3.549679487 GHz

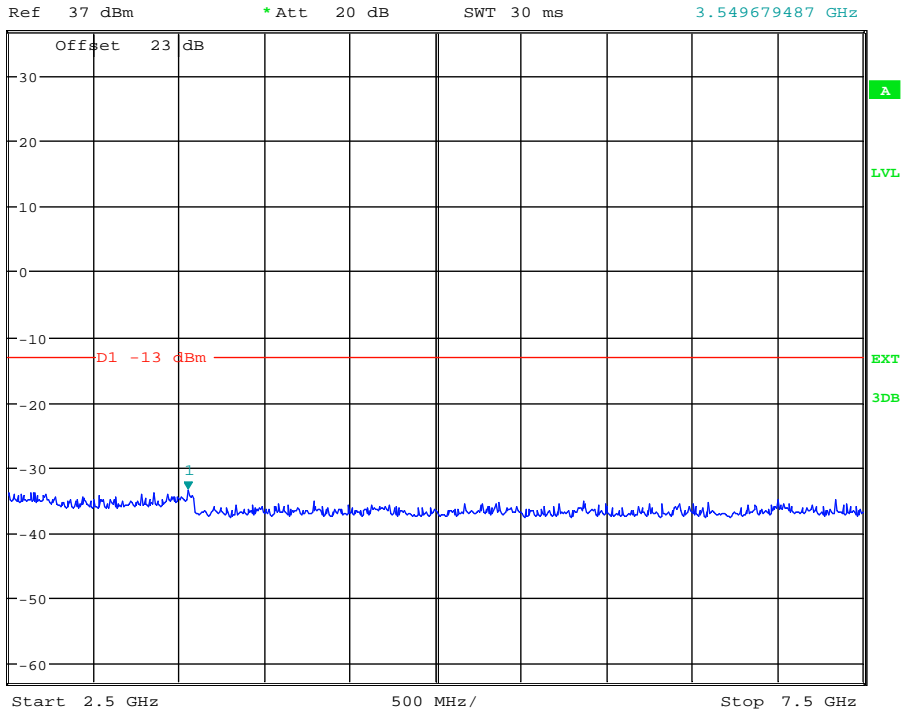

Date: 21.NOV.2013 14:33:00

(Plot 4.7.7 A3: Channel 4233: 846.60 MHz @ WCDMA Band V)



*RBW 1 MHz Marker 1 [T1]
*VBW 3 MHz -34.87 dBm
SWT 20 ms 9.166666667 GHz

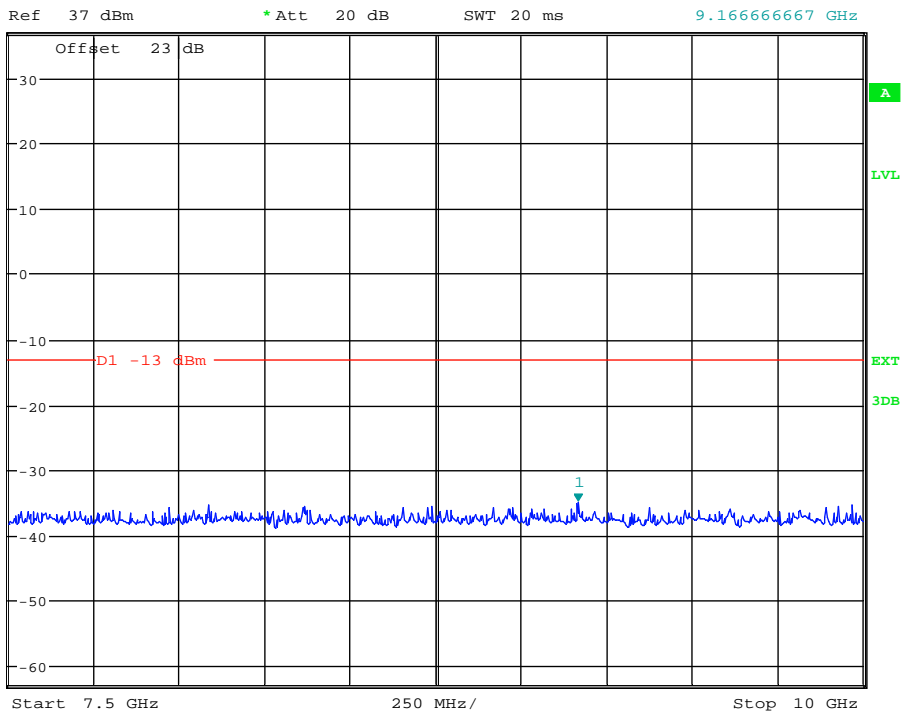

Date: 21.NOV.2013 14:33:16

(Plot 4.7.7 A4: Channel 4233: 846.60 MHz @ WCDMA Band V)



*RBW 1 MHz Marker 1 [T1]
*VBW 3 MHz -35.76 dBm
SWT 2.5 ms 967.355769231 MHz

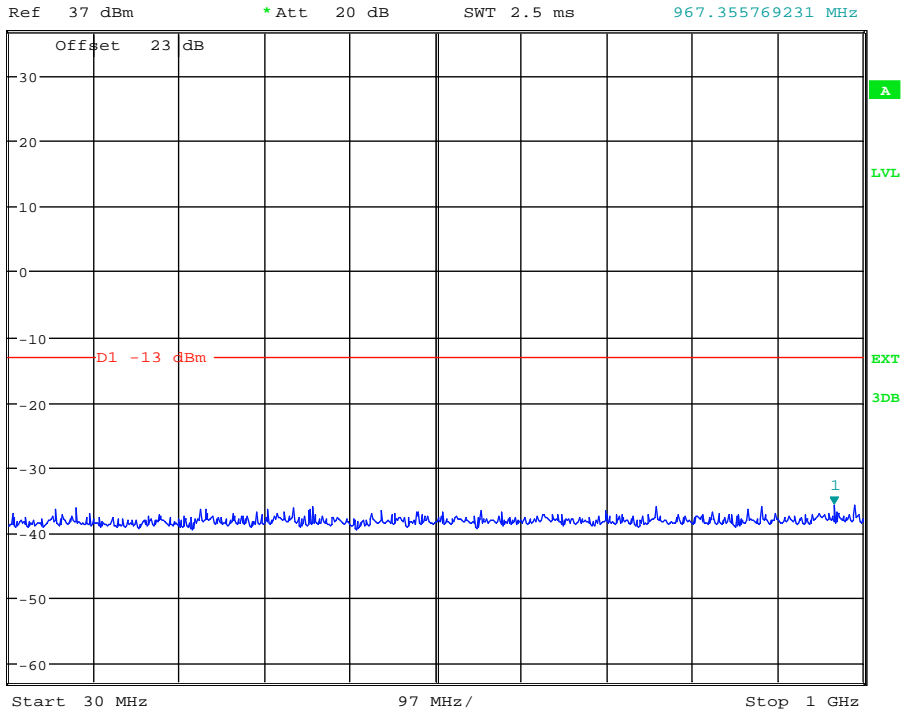

Date: 21.NOV.2013 14:36:06

(Plot 4.7.8 A1: Idle @ WCDMA Band V)



*RBW 1 MHz Marker 1 [T1]
*VBW 3 MHz -34.41 dBm
SWT 5 ms 2.449519231 GHz

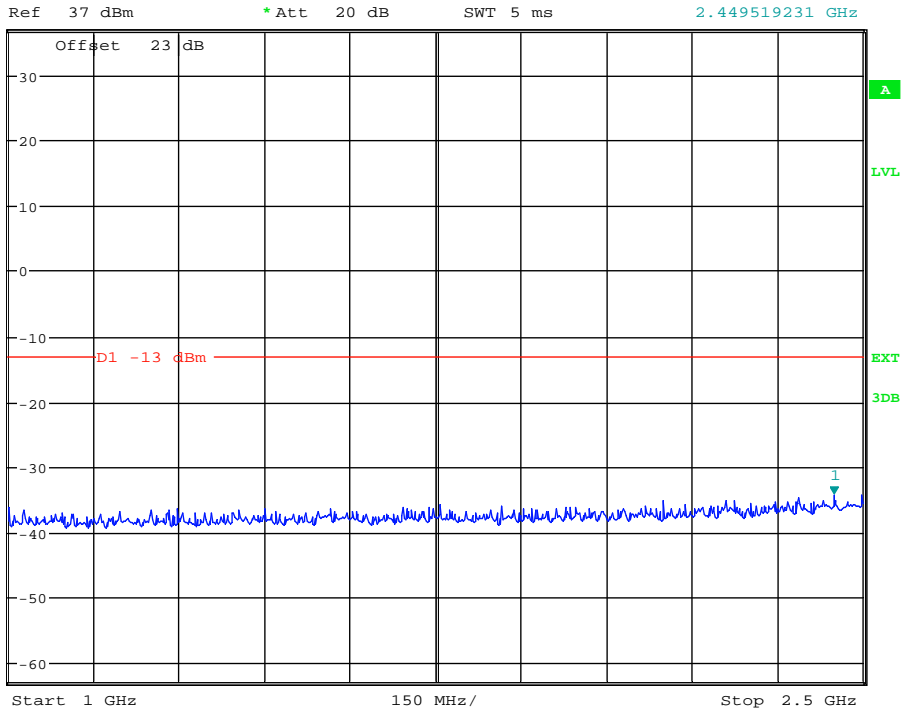

Date: 21.NOV.2013 14:36:21

(Plot 4.7.8 A2: Idle @ WCDMA Band V)



*RBW 1 MHz Marker 1 [T1]
*VBW 3 MHz -33.16 dBm
SWT 30 ms 2.628205128 GHz

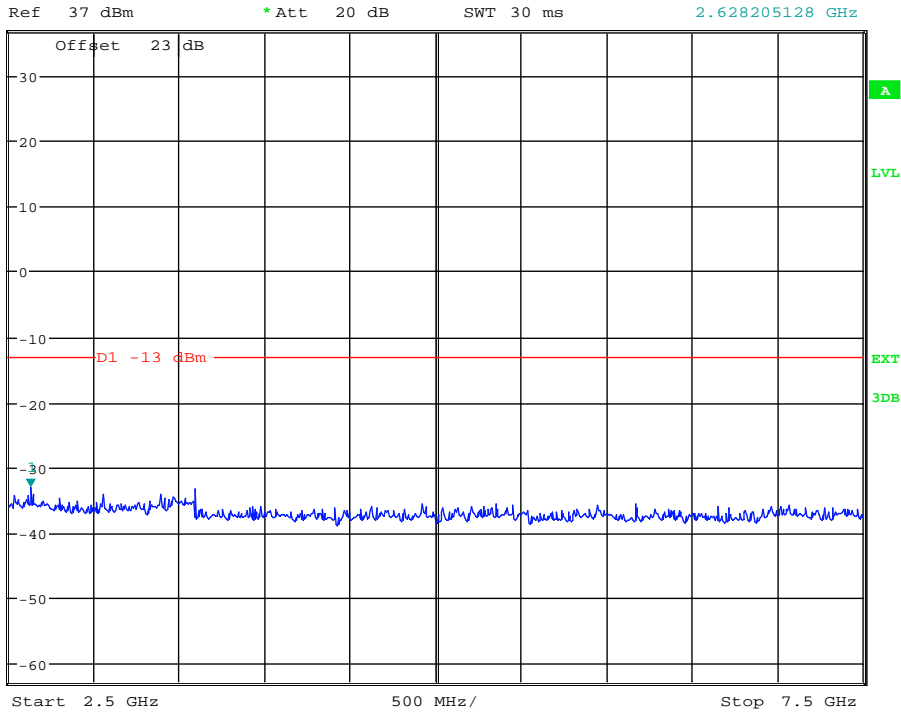

Date: 21.NOV.2013 14:36:34

(Plot 4.7.8 A3: Idle @ WCDMA Band V)



*RBW 1 MHz Marker 1 [T1]
*VBW 3 MHz -34.25 dBm
SWT 20 ms 7.632211538 GHz

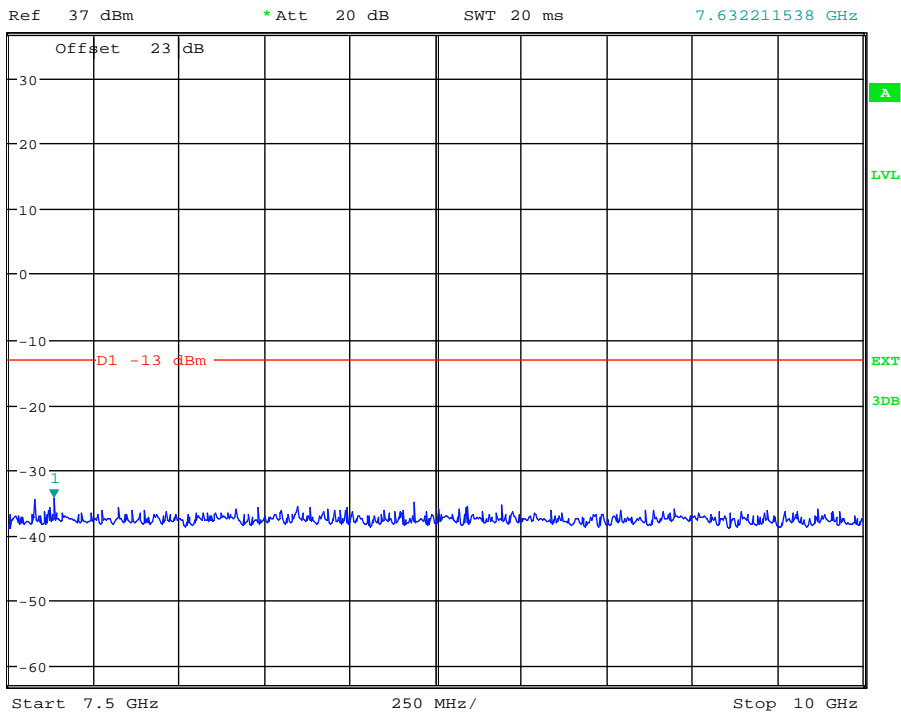

Date: 21.NOV.2013 14:36:47

(Plot 4.7.8 A4: Idle @ WCDMA Band V)

4.8. Frequency Stability Test

TEST APPLICABLE

1. According to FCC Part 2 Section 2.1055 (a)(1), the frequency stability shall be measured with variation of ambient temperature from -30°C to +50°C centigrade.
2. According to FCC Part 2 Section 2.1055 (a) (2), for battery powered equipment, the frequency stability shall be measured with reducing primary supply voltage to the battery operating end point, which is specified by the manufacture.
3. Vary primary supply voltage from 85 to 115 percent of the nominal value for other than hand carried voltage equipment and the end voltage point was 3.45V.

TEST PROCEDURE

In order to measure the carrier frequency under the condition of AFC lock, it is necessary to make measurements with the EUT in a "call mode". This is accomplished with the use of R&S CMU200 DIGITAL RADIO COMMUNICATION TESTER.

1. Measure the carrier frequency at room temperature;
2. Subject the EUT to overnight soak at -30°C;
3. With the EUT, powered via nominal voltage, connected to the CMU200 and in a simulated call on middle channel of PCS 94000 and WCDMA II, measure the carrier frequency. These measurements should be made within 2 minutes of Powering up the EUT, to prevent significant self-warming;
4. Repeat the above measurements at 10°C increments from -30°C to +50°C. Allow at least 0.5 hours at each temperature, unpowered, before making measurements;
5. Remeasure carrier frequency at room temperature with nominal voltage. Vary supply voltage from minimum voltage to maximum voltage, in 0.1Volt increments remeasuring carrier frequency at each voltage. Pause at nominal voltage for 0.5 hours unpowered, to allow any self-heating to stabilize, before continuing;
6. Subject the EUT to overnight soak at +50°C;
7. With the EUT, powered via nominal voltage, connected to the CMU200 and in a simulated call on the centre channel, measure the carrier frequency. These measurements should be made within 2 minutes of Powering up the EUT, to prevent significant self-warming;
8. Repeat the above measurements at 10°C increments from +50°C to -30°C. Allow at least 0.5 hours at each temperature, unpowered, before making measurements;
9. At all temperature levels hold the temperature to +/- 0.5°C during the measurement procedure;

TEST CONFIGURATION

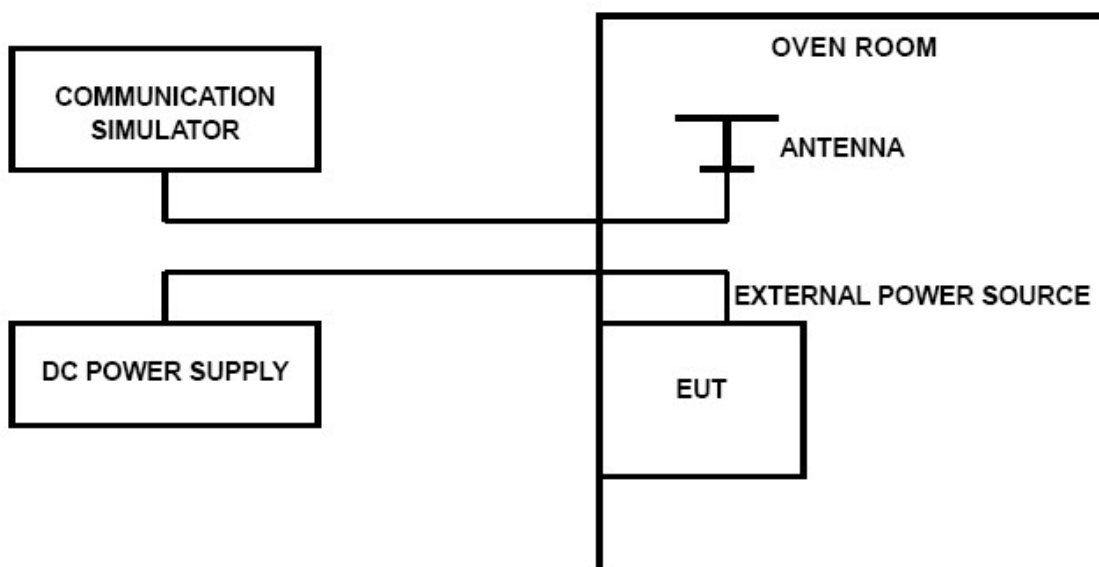

TEST LIMITS

For Hand carried battery powered equipment

According to the JTC standard the frequency stability of the carrier shall be accurate to within 0.1 ppm of the received frequency from the base station. This accuracy is sufficient to meet Sec. 24.235, Frequency Stability.

The frequency stability shall be sufficient to ensure that the fundamental emission stays within the authorized frequency block. As this transceiver is considered "Hand carried, battery powered equipment" Section 2.1055(d)(2) applies. This requires that the lower voltage for frequency stability testing be specified by the manufacturer. This transceiver is specified to operate with an input voltage of between 3.40VDC and 4.20VDC, with a nominal voltage of 3.70DC. Operation above or below these voltage limits is prohibited by transceiver software in order to prevent improper operation as well as to protect components from overstress. These voltages represent a tolerance of -10 % and +12.5 %. For the purposes of measuring frequency stability these voltage limits are to be used.

For equipment powered by primary supply voltage

According to the JTC standard the frequency stability of the carrier shall be accurate to within 0.1 ppm of the received frequency from the base station. This accuracy is sufficient to meet Sec. 24.235, Frequency Stability. The frequency stability shall be sufficient to ensure that the fundamental emission stays within the authorized frequency block. For this EUT section 2.1055(d)(1) applies. This requires varying primary supply voltage from 85 to 115 percent of the nominal value for other than hand carried battery equipment.

TEST RESULTS

WCDMA Band V					
DC Power	Temperature (°C)	Frequency error(Hz)	Frequency error(ppm)	Limit (ppm)	Verdict
3.40	25	30	0.036	0.10	PASS
3.70	25	-29	0.035	0.10	PASS
4.20	25	-21	0.025	0.10	PASS
3.70	-30	-26	0.031	0.10	PASS
3.70	-20	-25	0.030	0.10	PASS
3.70	-10	-19	0.023	0.10	PASS
3.70	0	-18	0.022	0.10	PASS
3.70	10	-29	0.035	0.10	PASS
3.70	20	-27	0.032	0.10	PASS
3.70	30	-26	0.031	0.10	PASS
3.70	40	-21	0.025	0.10	PASS
3.70	50	-25	0.030	0.10	PASS

WCDMA Band II					
DC Power	Temperature (°C)	Frequency error(Hz)	Frequency error(ppm)	Limit (ppm)	Verdict
3.40	20	-50	0.027	0.10	PASS
3.70	20	-58	0.031	0.10	PASS
4.20	20	-46	0.024	0.10	PASS
3.70	-30	-37	0.020	0.10	PASS
3.70	-20	-42	0.022	0.10	PASS
3.70	-10	-46	0.024	0.10	PASS
3.70	0	-48	0.026	0.10	PASS
3.70	10	-38	0.020	0.10	PASS
3.70	20	-50	0.027	0.10	PASS
3.70	30	-47	0.025	0.10	PASS
3.70	40	-39	0.021	0.10	PASS
3.70	50	-42	0.022	0.10	PASS

5. Test Setup Photos of the EUT

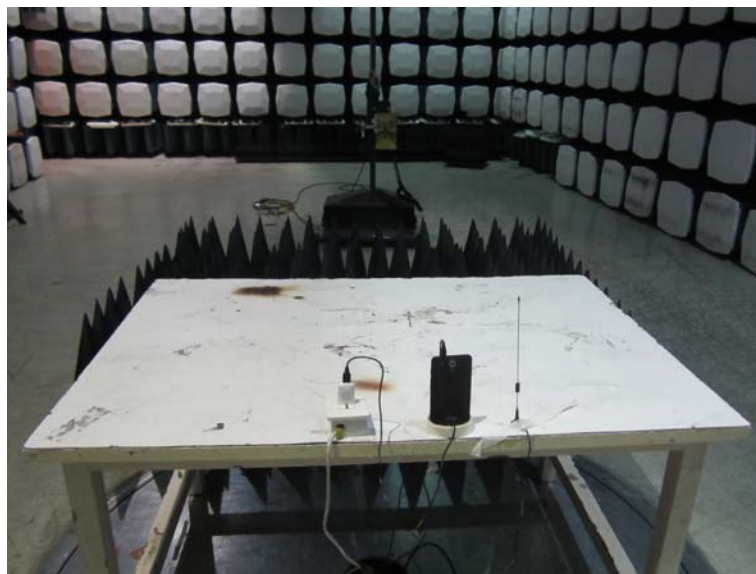
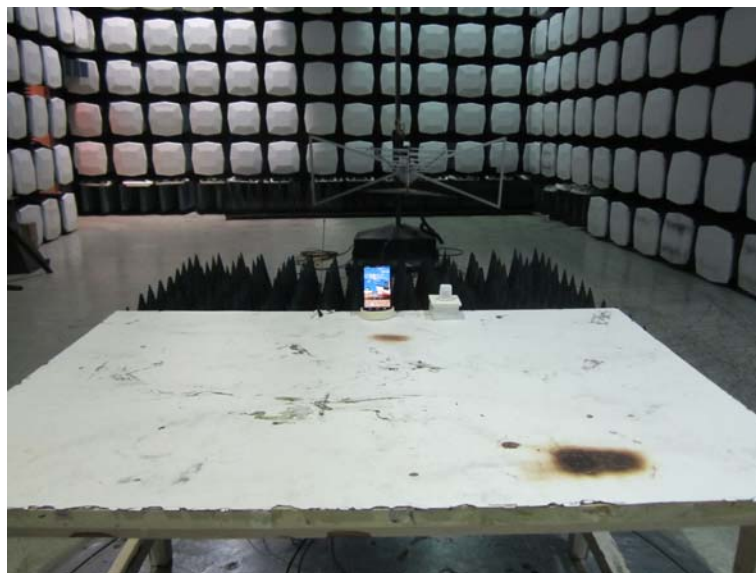



6. External and Internal Photos of the EUT

External photos of the EUT







Internal photos of the EUT



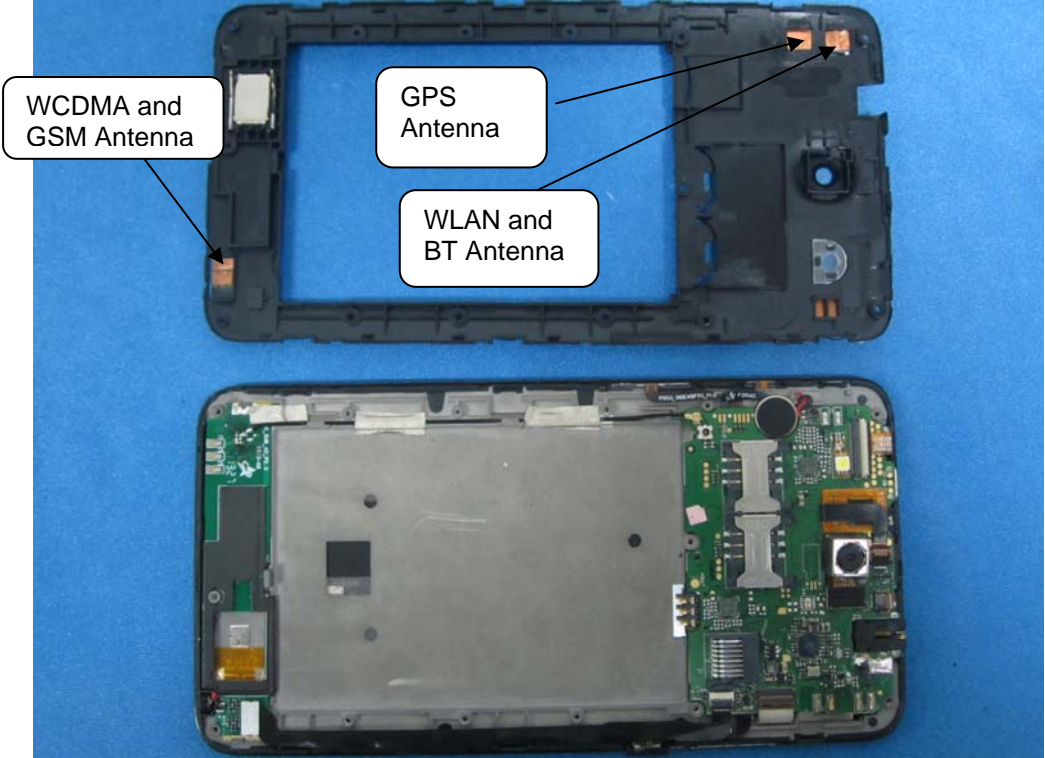

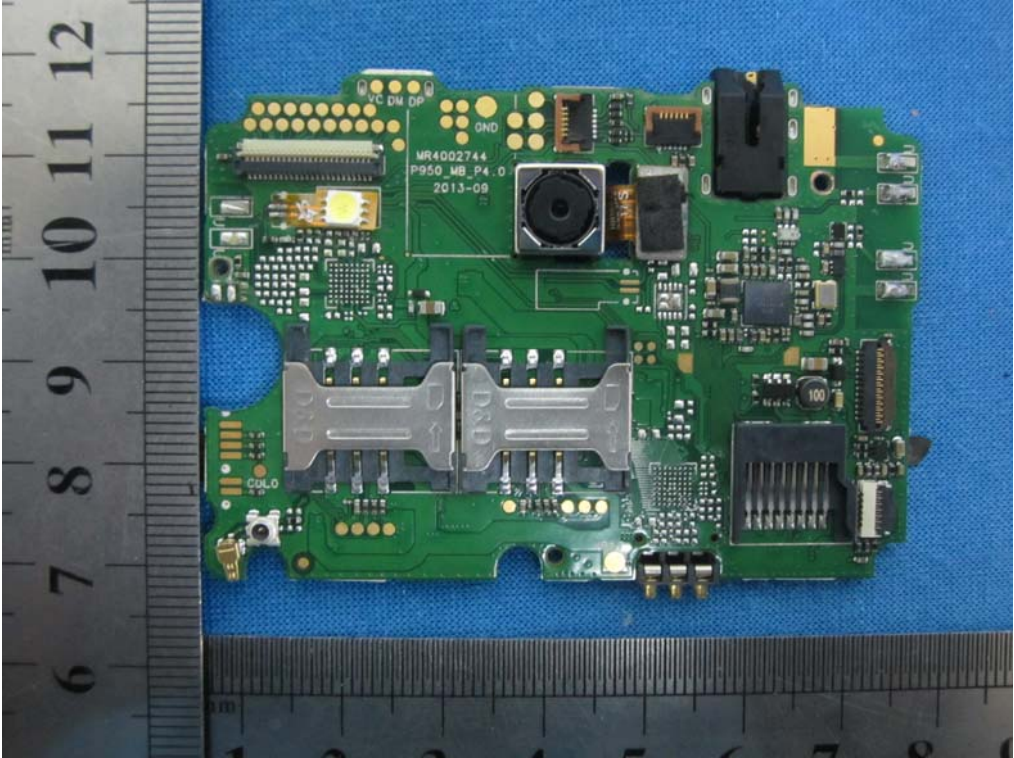

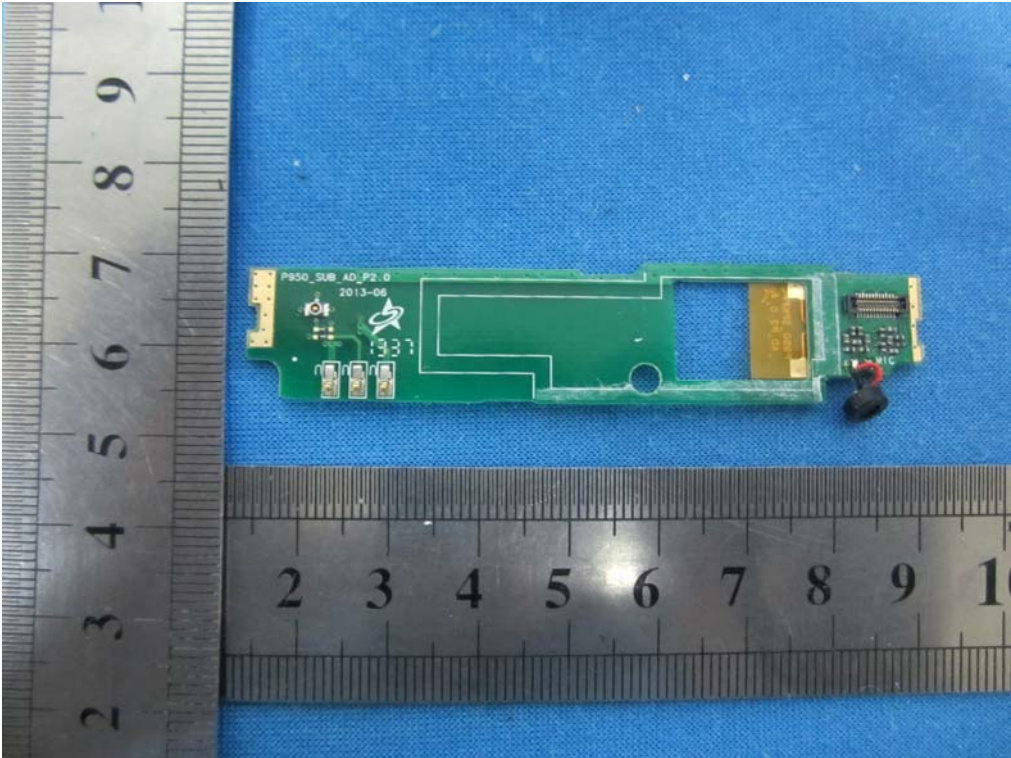
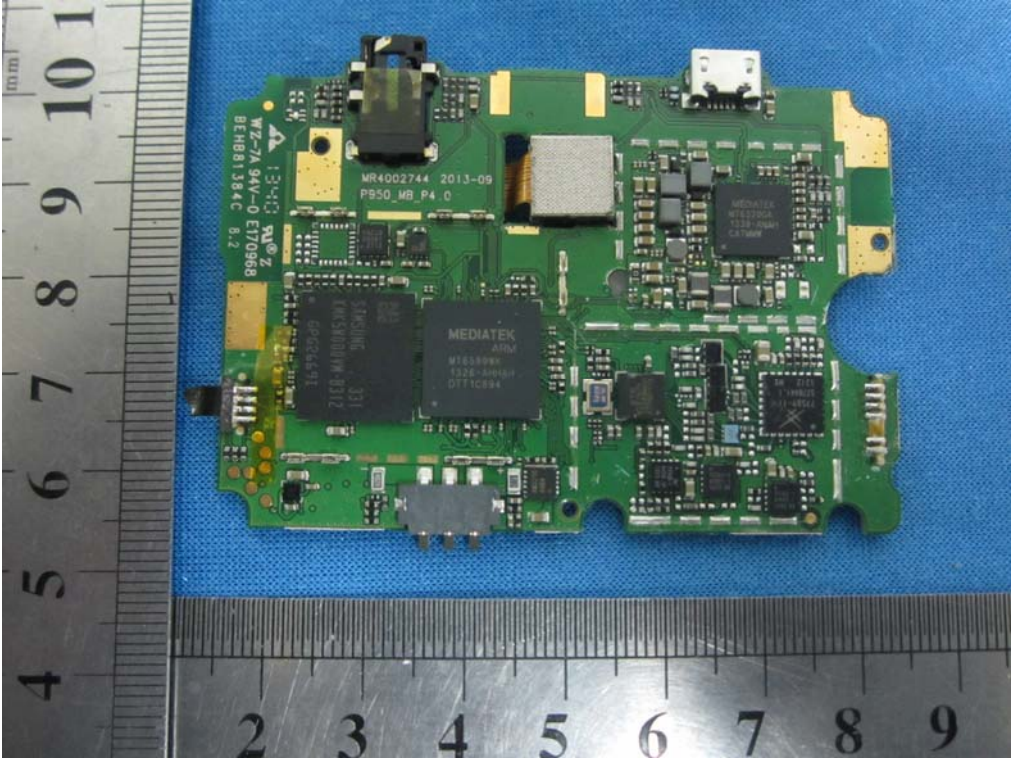

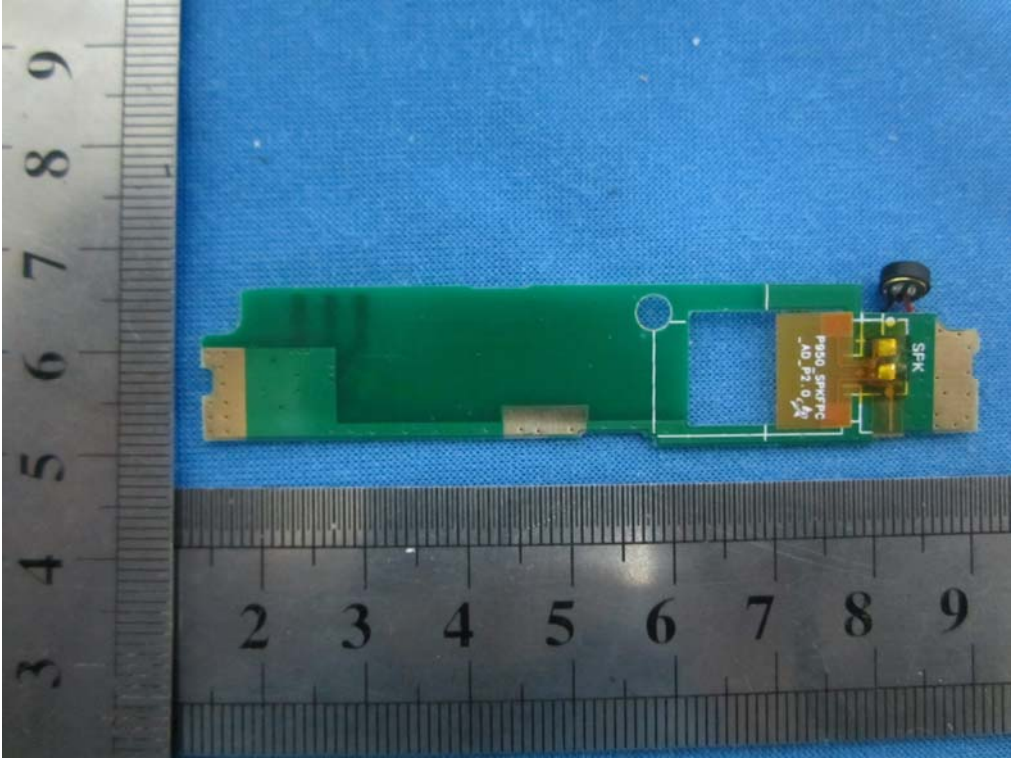

.....End of Report.....