

FCC Test Report (15.247)

Report No.: RF150430E10

FCC ID: PY315200310

Test Model: R7800

Received Date: Mar. 25, 2015

Test Date: May 07 to 16, 2015

Issued Date: May 21, 2015

Applicant: NETGEAR, Inc.

Address: 350 East Plumeria Drive San Jose, CA 95134

Issued By: Bureau Veritas Consumer Products Services (H.K.) Ltd., Taoyuan Branch
Hsin Chu Laboratory

Lab Address: No. 81-1, Lu Liao Keng, 9th Ling, Wu Lung Tsuen, Chiung Lin Hsiang, Hsin
Chu Hsien 307, Taiwan R.O.C.

Test Lab (A): Bureau Veritas Consumer Products Services (H.K.) Ltd., Taoyuan Branch
Hsin Chu Laboratory

Test Location (1): No. 81-1, Lu Liao Keng, 9th Ling, Wu Lung Tsuen, Chiung Lin Hsiang, Hsin
Chu Hsien 307, Taiwan R.O.C.

Test Location (2): No. 49, Ln. 206, Wende Rd., Shangshan Tsuen, Chiung Lin Hsiang, Hsin
Chu Hsien 307, Taiwan R.O.C.

Test Lab (B): Bureau Veritas Consumer Products Services (H.K.) Ltd., Taoyuan Branch
Lin Kou Laboratories

Test Location (1): No.19, Hwa Ya 2nd Rd., Wen Hwa Vil., Kwei Shan Dist., Taoyuan City
33383, TAIWAN (R.O.C.)



This report is for your exclusive use. Any copying or replication of this report to or for any other person or entity, or use of our name or trademark, is permitted only with our prior written permission. This report sets forth our findings solely with respect to the test samples identified herein. The results set forth in this report are not indicative or representative of the quality or characteristics of the lot from which a test sample was taken or any similar or identical product unless specifically and expressly noted. Our report includes all of the tests requested by you and the results thereof based upon the information that you provided to us. You have 60 days from date of issuance of this report to notify us of any material error or omission caused by our negligence, provided, however, that such notice shall be in writing and shall specifically address the issue you wish to raise. A failure to raise such issue within the prescribed time shall constitute your unqualified acceptance of the completeness of this report, the tests conducted and the correctness of the report contents. Unless specific mention, the uncertainty of measurement has been explicitly taken into account to declare the compliance or non-compliance to the specification. The report must not be used by the client to claim product certification, approval, or endorsement by TAF or any government agencies. The report must not be used by the client to claim product certification, approval, or endorsement by TAF or any government agency. This report contains Radiated Emissions & Band Edge Measurement (above 1GHz) test data that were produced under subcontract by Bureau Veritas Consumer Products Services (H.K.) Ltd., Taoyuan Branch Lin Kou Laboratories.

Table of Contents

Release Control Record	5
1 Certificate of Conformity	6
2 Summary of Test Results	7
2.1 Measurement Uncertainty	7
2.2 Modification Record	7
3 General Information	8
3.1 General Description of EUT	8
3.2 Description of Test Modes	11
3.2.1 Test Mode Applicability and Tested Channel Detail	12
3.3 Duty Cycle of Test Signal	16
3.4 Description of Support Units	17
3.4.1 Configuration of System under Test	17
3.5 General Description of Applied Standards	18
4 Test Types and Results (For 2.4GHz Band)	19
4.1 Radiated Emission and Bandedge Measurement	19
4.1.1 Limits of Radiated Emission and Bandedge Measurement	19
4.1.2 Test Instruments	20
4.1.3 Test Procedures	22
4.1.4 Deviation from Test Standard	22
4.1.5 Test Setup	23
4.1.6 EUT Operating Conditions	23
4.1.7 Test Results	24
4.2 Conducted Emission Measurement	28
4.2.1 Limits of Conducted Emission Measurement	28
4.2.2 Test Instruments	28
4.2.3 Test Procedures	29
4.2.4 Deviation from Test Standard	29
4.2.5 Test Setup	29
4.2.6 EUT Operating Conditions	29
4.2.7 Test Results	30
4.3 6dB Bandwidth Measurement	32
4.3.1 Limits of 6dB Bandwidth Measurement	32
4.3.2 Test Setup	32
4.3.3 Test Instruments	32
4.3.4 Test Procedure	32
4.3.5 Deviation from Test Standard	32
4.3.6 EUT Operating Conditions	32
4.3.7 Test Result	33
4.4 Conducted Output Power Measurement	34
4.4.1 Limits of Conducted Output Power Measurement	34
4.4.2 Test Setup	34
4.4.3 Test Instruments	34
4.4.4 Test Procedures	34
4.4.5 Deviation from Test Standard	34
4.4.6 EUT Operating Conditions	34
4.4.7 Test Results	35
4.5 Power Spectral Density Measurement	36
4.5.1 Limits of Power Spectral Density Measurement	36
4.5.2 Test Setup	36
4.5.3 Test Instruments	36
4.5.4 Test Procedure	36
4.5.5 Deviation from Test Standard	36
4.5.6 EUT Operating Condition	36

4.5.7	Test Results	37
4.6	Conducted Out of Band Emission Measurement	38
4.6.1	Limits of Conducted Out of Band Emission Measurement	38
4.6.2	Test Setup	38
4.6.3	Test Instruments	38
4.6.4	Test Procedure	38
4.6.5	Deviation from Test Standard	38
4.6.6	EUT Operating Condition	39
4.6.7	Test Results	39
5	Test Types and Results (For 5GHz Band).....	44
5.1	Radiated Emission and Bandedge Measurement.....	44
5.1.1	Limits of Radiated Emission and Bandedge Measurement	44
5.1.2	Test Instruments	45
5.1.3	Test Procedures.....	47
5.1.4	Deviation from Test Standard	47
5.1.5	Test Setup.....	48
5.1.6	EUT Operating Conditions.....	48
5.1.7	Test Results	49
5.2	Conducted Emission Measurement	59
5.2.1	Limits of Conducted Emission Measurement	59
5.2.2	Test Instruments	59
5.2.3	Test Procedures.....	60
5.2.4	Deviation from Test Standard	60
5.2.5	Test Setup.....	60
5.2.6	EUT Operating Conditions.....	60
5.2.7	Test Results	61
5.3	6dB Bandwidth Measurement	63
5.3.1	Limits of 6dB Bandwidth Measurement	63
5.3.2	Test Setup.....	63
5.3.3	Test Instruments	63
5.3.4	Test Procedure	63
5.3.5	Deviation from Test Standard	63
5.3.6	EUT Operating Conditions.....	63
5.3.7	Test Result.....	64
5.4	Conducted Output Power Measurement.....	66
5.4.1	Limits of Conducted Output Power Measurement	66
5.4.2	Test Setup.....	66
5.4.3	Test Instruments	66
5.4.4	Test Procedures.....	66
5.4.5	Deviation from Test Standard	66
5.4.6	EUT Operating Conditions.....	66
5.4.7	Test Results	67
5.5	Power Spectral Density Measurement.....	68
5.5.1	Limits of Power Spectral Density Measurement	68
5.5.2	Test Setup.....	68
5.5.3	Test Instruments	68
5.5.4	Test Procedure	68
5.5.5	Deviation from Test Standard	69
5.5.6	EUT Operating Condition	69
5.5.7	Test Results	70
5.6	Conducted Out of Band Emission Measurement	74
5.6.1	Limits of Conducted Out of Band Emission Measurement	74
5.6.2	Test Setup.....	74
5.6.3	Test Instruments	74
5.6.4	Test Procedure	74
5.6.5	Deviation from Test Standard	74
5.6.6	EUT Operating Condition	75



5.6.7 Test Results 75

6 Pictures of Test Arrangements 92

Appendix – Information on the Testing Laboratories 93



A D T

Release Control Record

Issue No.	Description	Date Issued
RF150430E10	Original release.	May 21, 2015



A D T

1 Certificate of Conformity

Product: Nighthawk X4S Smart WIFI Router
Brand: NETGEAR
Test Model: R7800
Sample Status: ENGINEERING SAMPLE
Applicant: NETGEAR, Inc.
Test Date: May 07 to 16, 2015
Standards: 47 CFR FCC Part 15, Subpart C (Section 15.247)
ANSI C63.10:2009

The above equipment has been tested by **Bureau Veritas Consumer Products Services (H.K.) Ltd., Taoyuan Branch**, and found compliance with the requirement of the above standards. The test record, data evaluation & Equipment Under Test (EUT) configurations represented herein are true and accurate accounts of the measurements of the sample's EMC characteristics under the conditions specified in this report. This report contains Radiated Emissions & Band Edge Measurement (above 1GHz) test data that were produced under subcontract by Bureau Veritas Consumer Products Services (H.K.) Ltd., Taoyuan Branch Lin Kou Laboratories.

Prepared by :  , **Date:** May 21, 2015
Lori Chung / Specialist

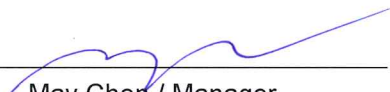
Approved by :  , **Date:** May 21, 2015
May Chen / Manager

2 Summary of Test Results

47 CFR FCC Part 15, Subpart C (SECTION 15.247)			
FCC Clause	Test Item	Result	Remarks
15.207	AC Power Conducted Emission	PASS	Meet the requirement of limit. Minimum passing margin is -9.51dB at 9.38281MHz.
15.205 / 15.209 / 15.247(d)	Radiated Emissions and Band Edge Measurement	PASS	Meet the requirement of limit. Minimum passing margin is -0.1dB at 2390.00MHz.
15.247(d)	Antenna Port Emission	PASS	Meet the requirement of limit.
15.247(a)(2)	6dB bandwidth	PASS	Meet the requirement of limit.
15.247(b)	Conducted power	PASS	Meet the requirement of limit.
15.247(e)	Power Spectral Density	PASS	Meet the requirement of limit.
15.203	Antenna Requirement	PASS	Antenna connector is i-pex(MHF) not a standard connector.

NOTE: The EUT was operating in 2.400 ~ 2.4835GHz, 5.15~5.25GHz and 5.725~5.850GHz frequencies band. This report was recorded the RF parameters including 2.400 ~ 2.4835GHz and 5.725~5.850GHz. For the 5.15~5.25GHz RF parameters was recorded in another test report.

2.1 Measurement Uncertainty

Where relevant, the following measurement uncertainty levels have been estimated for tests performed on the EUT as specified in CISPR 16-4-2:

Measurement	Frequency	Expanded Uncertainty (k=2) (\pm)
Conducted Emissions at mains ports	150kHz ~ 30MHz	2.86 dB
Radiated Emissions up to 1 GHz	30MHz ~ 1GHz	5.43 dB
Radiated Emissions above 1 GHz	1GHz ~ 18GHz	2.29 dB
	18GHz ~ 40GHz	2.29 dB

2.2 Modification Record

There were no modifications required for compliance.

3 General Information

3.1 General Description of EUT

Product	Nighthawk X4S Smart WIFI Router
Brand	NETGEAR
Test Model	R7800
Status of EUT	ENGINEERING SAMPLE
Power Supply Rating	19Vdc from power adapter
Modulation Type	CCK, DQPSK, DBPSK for DSSS 64QAM, 16QAM, QPSK, BPSK for OFDM 256QAM for OFDM in 11ac mode
Modulation Technology	DSSS, OFDM
Transfer Rate	802.11b: up to 11Mbps 802.11a: up to 54Mbps 802.11n: up to 600Mbps 802.11ac: up to 1733.3Mbps
Operating Frequency	For 15.407 5.18 ~ 5.24GHz
	For 15.247 2.4GHz: 2.412 ~ 2.462GHz 5GHz: 5.745 ~ 5.825GHz
Number of Channel	For 15.407 4 for 802.11a, 802.11n (HT20), 802.11ac (VHT20) 2 for 802.11n (HT40), 802.11ac (VHT40) 1 for 802.11ac (VHT80)
	For 15.247 (2.4GHz) 11 for 802.11b For 15.247 (5GHz) 5 for 802.11a, 802.11n (HT20), 802.11ac (VHT20) 2 for 802.11n (HT40), 802.11ac (VHT40) 1 for 802.11ac (VHT80)
Output Power	For 15.407 CDD Mode: 802.11a: 918.069mW 802.11ac (VHT20): 951.947mW 802.11ac (VHT40): 711.113mW 802.11ac (VHT80): 238.875mW Beamforming Mode: 802.11ac (VHT20): 744.333mW 802.11ac (VHT40): 711.113mW 802.11ac (VHT80): 238.875mW
	For 15.247 (2.4GHz) CDD Mode: 802.11b: 962.497mW For 15.247 (5GHz) CDD Mode: 802.11a: 944.69mW Beamforming Mode: 802.11ac (VHT20): 936.896mW 802.11ac (VHT40): 937.418mW 802.11ac (VHT80): 658.63mW
Antenna Type	Refer to Note
Antenna Connector	Refer to Note
Accessory Device	Adapter x 1
Data Cable Supplied	Ethernet cable (shielded, 1.5m)

Note:

1. The emission of the simultaneous operation (2.4GHz & 5GHz) has been evaluated and no non-compliance was found.
2. The EUT must be supplied with a power adapter as following table:

Brand	NETGEAR
Model	AD2003F10
P/N	332-10631-01
Input Power	100-120Vac, 50/60Hz, 1.5A
Output Power	19Vdc, 3.16A
Power Line	DC output cable: Unshielded, 1.8m

3. The antennas provided to the EUT, please refer to the following table:

Antenna No.	Ant. Gain(dBi)	Frequency range (GHz to GHz)	Antenna Type	Connector Type
External (1)	0.67	2.4~2.4835	Dipole	i-pex(MHF)
	1.16	5.15~5.25	Dipole	i-pex(MHF)
	0.62	5.25~5.35	Dipole	i-pex(MHF)
	0.4	5.47~5.725	Dipole	i-pex(MHF)
	0.21	5.725~5.85	Dipole	i-pex(MHF)
External (2)	0.67	2.4~2.4835	Dipole	i-pex(MHF)
	1.16	5.15~5.25	Dipole	i-pex(MHF)
	0.62	5.25~5.35	Dipole	i-pex(MHF)
	0.4	5.47~5.725	Dipole	i-pex(MHF)
	0.21	5.725~5.85	Dipole	i-pex(MHF)
External (3)	0.67	2.4~2.4835	Dipole	i-pex(MHF)
	1.16	5.15~5.25	Dipole	i-pex(MHF)
	0.62	5.25~5.35	Dipole	i-pex(MHF)
	0.4	5.47~5.725	Dipole	i-pex(MHF)
	0.21	5.725~5.85	Dipole	i-pex(MHF)
External (4)	0.67	2.4~2.4835	Dipole	i-pex(MHF)
	1.16	5.15~5.25	Dipole	i-pex(MHF)
	0.62	5.25~5.35	Dipole	i-pex(MHF)
	0.4	5.47~5.725	Dipole	i-pex(MHF)
	0.21	5.725~5.85	Dipole	i-pex(MHF)

4. The EUT incorporates a MIMO function with beamforming for 5GHz (802.11n & 802.11ac mode).

For 2.4GHz Band			
MODULATION MODE	DATA RATE (MCS)	TX & RX CONFIGURATION	
802.11b	1 ~ 11Mbps	4TX	4RX
For 5GHz Band			
MODULATION MODE	DATA RATE (MCS)	TX & RX CONFIGURATION	
802.11a	6 ~ 54Mbps	4TX	4RX
802.11n (HT20)	MCS 0~7	4TX	4RX
	MCS 8~15	4TX	4RX
	MCS 16~23	4TX	4RX
	MCS 24~31	4TX	4RX
802.11n (HT40)	MCS 0~7	4TX	4RX
	MCS 8~15	4TX	4RX
	MCS 16~23	4TX	4RX
	MCS 24~31	4TX	4RX
802.11ac (VHT20)	MCS 0~8, Nss=1	4TX	4RX
	MCS 0~8, Nss=2	4TX	4RX
	MCS 0~9, Nss=3	4TX	4RX
	MCS 0~9, Nss=4	4TX	4RX
802.11ac (VHT40)	MCS 0~9, Nss=1	4TX	4RX
	MCS 0~9, Nss=2	4TX	4RX
	MCS 0~9, Nss=3	4TX	4RX
	MCS 0~9, Nss=4	4TX	4RX
802.11ac (VHT80)	MCS 0~9, Nss=1	4TX	4RX
	MCS 0~9, Nss=2	4TX	4RX
	MCS 0~9, Nss=3	4TX	4RX
	MCS 0~9, Nss=4	4TX	4RX

Note: The modulation and bandwidth are similar for 802.11n mode for 20MHz (40MHz) and 802.11ac mode for 20MHz (40MHz), therefore investigated worst case to representative mode in test report. (Final test mode refer section 3.2.1)

5. The above EUT information is declared by manufacturer and for more detailed features description, please refer to the manufacturer's specifications or user's manual.

3.2 Description of Test Modes

For 2.4GHz:

11 channels are provided for 802.11b:

Channel	Frequency	Channel	Frequency
1	2412MHz	7	2442MHz
2	2417MHz	8	2447MHz
3	2422MHz	9	2452MHz
4	2427MHz	10	2457MHz
5	2432MHz	11	2462MHz
6	2437MHz		

For 5GHz (5745 ~ 5825MHz):

5 channels are provided for 802.11a, 802.11n (HT20), 802.11ac (VHT20):

Channel	Frequency	Channel	Frequency
149	5745MHz	161	5805MHz
153	5765MHz	165	5825MHz
157	5785MHz		

2 channels are provided for 802.11n (HT40), 802.11ac (VHT40):

Channel	Frequency	Channel	Frequency
151	5755MHz	159	5795MHz

1 channel is provided for 802.11ac (VHT80):

Channel	Frequency	Channel	Frequency
155	5775MHz		

3.2.1 Test Mode Applicability and Tested Channel Detail

For 2.4GHz:

EUT CONFIGURE MODE	APPLICABLE TO				DESCRIPTION
	RE≥1G	RE<1G	PLC	APCM	
-	√	√	√	√	-

Where **RE≥1G**: Radiated Emission above 1GHz

RE<1G: Radiated Emission below 1GHz

PLC: Power Line Conducted Emission

APCM: Antenna Port Conducted Measurement

NOTE: The EUT had been pre-tested on the positioned of each 2 axis. The worst case was found when positioned on **X plane**.

Radiated Emission Test (Above 1GHz):

- Pre-Scan has been conducted to determine the worst-case mode from all possible combinations between available modulations, data rates and antenna ports (if EUT with antenna diversity architecture).
- Following channel(s) was (were) selected for the final test as listed below.

CDD MODE					
MODE	AVAILABLE CHANNEL	TESTED CHANNEL	MODULATION TECHNOLOGY	MODULATION TYPE	DATA RATE (Mbps)
802.11b	1 to 11	1, 6, 11	DSSS	DBPSK	1

Radiated Emission Test (Below 1GHz):

- Pre-Scan has been conducted to determine the worst-case mode from all possible combinations between available modulations, data rates and antenna ports (if EUT with antenna diversity architecture).
- Following channel(s) was (were) selected for the final test as listed below.

CDD MODE					
MODE	AVAILABLE CHANNEL	TESTED CHANNEL	MODULATION TECHNOLOGY	MODULATION TYPE	DATA RATE (Mbps)
802.11b	1 to 11	6	DSSS	DBPSK	1

Power Line Conducted Emission Test:

- Pre-Scan has been conducted to determine the worst-case mode from all possible combinations between available modulations, data rates and antenna ports (if EUT with antenna diversity architecture).
- Following channel(s) was (were) selected for the final test as listed below.

CDD MODE					
MODE	AVAILABLE CHANNEL	TESTED CHANNEL	MODULATION TECHNOLOGY	MODULATION TYPE	DATA RATE (Mbps)
802.11b	1 to 11	6	DSSS	DBPSK	1

Antenna Port Conducted Measurement:

- This item includes all test value of each mode, but only includes spectrum plot of worst value of each mode.
- Pre-Scan has been conducted to determine the worst-case mode from all possible combinations between available modulations, data rates and antenna ports (if EUT with antenna diversity architecture).
- Following channel(s) was (were) selected for the final test as listed below.

CDD MODE					
MODE	AVAILABLE CHANNEL	TESTED CHANNEL	MODULATION TECHNOLOGY	MODULATION TYPE	DATA RATE (Mbps)
802.11b	1 to 11	1, 6, 11	DSSS	DBPSK	1

Test Condition:

APPLICABLE TO	ENVIRONMENTAL CONDITIONS	INPUT POWER	TESTED BY
RE≥1G	25deg. C, 69%RH	120Vac, 60Hz	Gary Cheng
RE<1G	25deg. C, 68%RH	120Vac, 60Hz	Robert Cheng
PLC	25deg. C, 70%RH	120Vac, 60Hz	Mike Hsieh
APCM	25deg. C, 60%RH	120Vac, 60Hz	Anderson Chen

For 5GHz (5745 ~ 5825MHz):

EUT CONFIGURE MODE	APPLICABLE TO				DESCRIPTION
	RE≥1G	RE<1G	PLC	APCM	
-	√	√	√	√	-

 Where **RE≥1G**: Radiated Emission above 1GHz

RE<1G: Radiated Emission below 1GHz

PLC: Power Line Conducted Emission

APCM: Antenna Port Conducted Measurement

NOTE: The EUT had been pre-tested on the positioned of each 2 axis. The worst case was found when positioned on **X plane**.

Radiated Emission Test (Above 1GHz):

- Pre-Scan has been conducted to determine the worst-case mode from all possible combinations between available modulations, data rates and antenna ports (if EUT with antenna diversity architecture).
- Following channel(s) was (were) selected for the final test as listed below.

CDD MODE					
MODE	AVAILABLE CHANNEL	TESTED CHANNEL	MODULATION TECHNOLOGY	MODULATION TYPE	DATA RATE (Mbps)
802.11a	149 to 165	149, 157, 165	OFDM	BPSK	6
Beamforming MODE					
MODE	AVAILABLE CHANNEL	TESTED CHANNEL	MODULATION TECHNOLOGY	MODULATION TYPE	DATA RATE (Mbps)
802.11ac (VHT20)	149 to 165	149, 157, 165	OFDM	BPSK	6.5
802.11ac (VHT40)	151 to 159	151, 159	OFDM	BPSK	13.5
802.11ac (VHT80)	155	155	OFDM	BPSK	29.3

Radiated Emission Test (Below 1GHz):

- Pre-Scan has been conducted to determine the worst-case mode from all possible combinations between available modulations, data rates and antenna ports (if EUT with antenna diversity architecture).
- Following channel(s) was (were) selected for the final test as listed below.

Beamforming MODE					
MODE	AVAILABLE CHANNEL	TESTED CHANNEL	MODULATION TECHNOLOGY	MODULATION TYPE	DATA RATE (Mbps)
802.11ac (VHT20)	149 to 165	149	OFDM	BPSK	6.5

Power Line Conducted Emission Test:

- Pre-Scan has been conducted to determine the worst-case mode from all possible combinations between available modulations, data rates and antenna ports (if EUT with antenna diversity architecture).
- Following channel(s) was (were) selected for the final test as listed below.

Beamforming MODE					
MODE	AVAILABLE CHANNEL	TESTED CHANNEL	MODULATION TECHNOLOGY	MODULATION TYPE	DATA RATE (Mbps)
802.11ac (VHT20)	149 to 165	149	OFDM	BPSK	6.5

Antenna Port Conducted Measurement:

- This item includes all test value of each mode, but only includes spectrum plot of worst value of each mode.
- Pre-Scan has been conducted to determine the worst-case mode from all possible combinations between available modulations, data rates and antenna ports (if EUT with antenna diversity architecture).
- Following channel(s) was (were) selected for the final test as listed below.

CDD MODE					
MODE	AVAILABLE CHANNEL	TESTED CHANNEL	MODULATION TECHNOLOGY	MODULATION TYPE	DATA RATE (Mbps)
802.11a	149 to 165	149, 157, 165	OFDM	BPSK	6
Beamforming MODE					
MODE	AVAILABLE CHANNEL	TESTED CHANNEL	MODULATION TECHNOLOGY	MODULATION TYPE	DATA RATE (Mbps)
802.11ac (VHT20)	149 to 165	149, 157, 165	OFDM	BPSK	6.5
802.11ac (VHT40)	151 to 159	151, 159	OFDM	BPSK	13.5
802.11ac (VHT80)	155	155	OFDM	BPSK	29.3

Test Condition:

APPLICABLE TO	ENVIRONMENTAL CONDITIONS	INPUT POWER	TESTED BY
RE \geq 1G	25deg. C, 69%RH	120Vac, 60Hz	Gary Cheng
RE $<$ 1G	25deg. C, 68%RH	120Vac, 60Hz	Robert Cheng
PLC	25deg. C, 70%RH	120Vac, 60Hz	Mike Hsieh
APCM	25deg. C, 60%RH	120Vac, 60Hz	Anderson Chen

3.3 Duty Cycle of Test Signal

2.4GHz Band:

Duty cycle of test signal is $\geq 98\%$, duty factor is not required.

802.11b: Duty cycle = $12.411\text{ ms} / 12.431\text{ ms} = 0.998$

802.11b

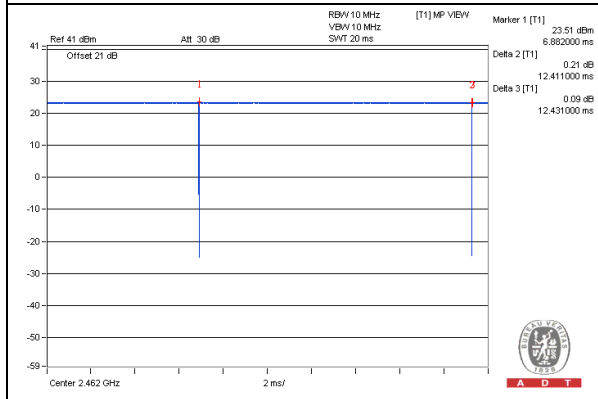

For 5GHz (5745 ~ 5825MHz):

If duty cycle of test signal is $\geq 98\%$, duty factor is not required.

If duty cycle of test signal is $< 98\%$, duty factor shall be considered.

802.11a: Duty cycle = $2.062\text{ ms} / 2.086\text{ ms} = 0.988$

802.11ac (VHT20): Duty cycle = $1.918\text{ ms} / 1.939\text{ ms} = 0.989$

802.11ac (VHT40): Duty cycle = $0.941\text{ ms} / 0.962\text{ ms} = 0.978$, Duty factor = $10 * \log(1/0.978) = 0.10$

802.11ac (VHT80): Duty cycle = $0.458\text{ ms} / 0.477\text{ ms} = 0.96$, Duty factor = $10 * \log(1/0.96) = 0.18$

802.11a

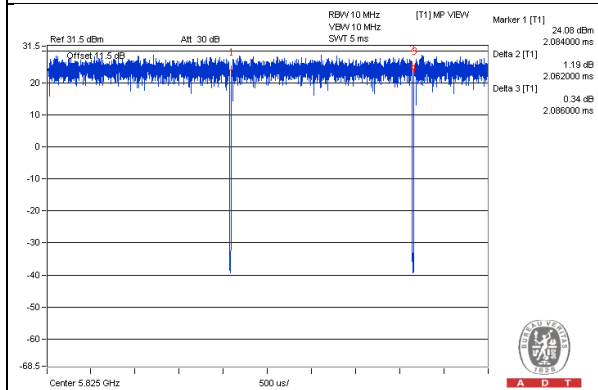

802.11ac (VHT20)

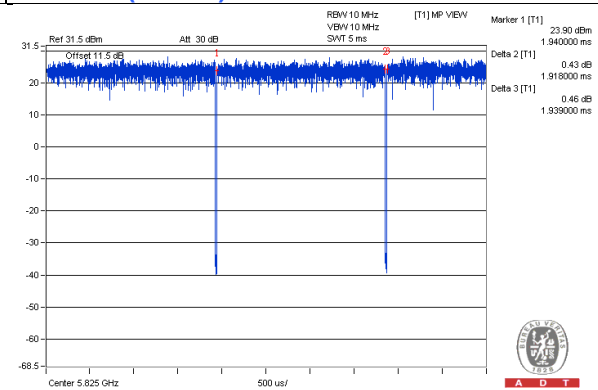

802.11ac (VHT40)

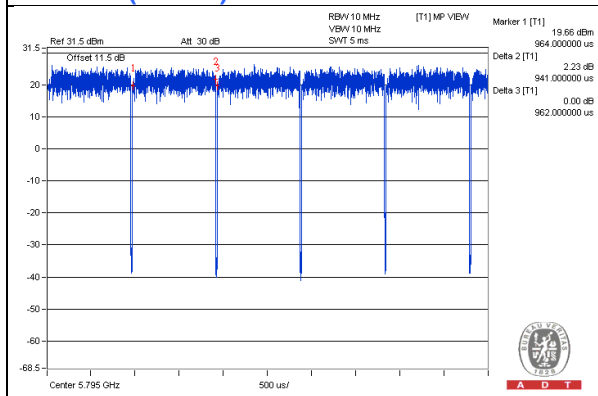

802.11ac (VHT80)

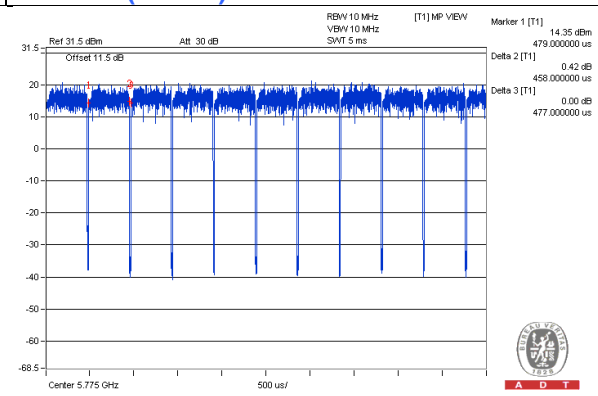

3.4 Description of Support Units

The EUT has been tested as an independent unit together with other necessary accessories or support units. The following support units or accessories were used to form a representative test configuration during the tests.

No.	Product	Brand	Model No.	Serial No.	FCC ID	Remark
A	USB Flash Driver	Transcend	JetFlash 790	NA	NA	Provided by Lab
B	USB Flash Driver	Transcend	JetFlash 790	NA	NA	Provided by Lab
C	NOTEBOOK COMPUTER	DELL	PP32LA	HSLB32S	FCC DoC	Provided by Lab
D	NOTEBOOK COMPUTER	DELL	E5430	4YV4VY1	FCC DoC	Provided by Lab
E	HUB	ZyXEL	ES-116P	S060H02000215	FCC DoC	Provided by Lab

NOTE:

1. All power cords of the above support units are non-shielded (1.8 m).

No.	Cable	Qty.	Length (m)	Shielded (Yes/ No)	Cores (Number)	Remark
1	DC	1	1.8	No	0	Supplied by Client
2	RJ45	1	10	No	0	Provided by Lab
3	RJ45	3	10	No	0	Provided by Lab
4	RJ45	1	10	No	0	Provided by Lab

3.4.1 Configuration of System under Test

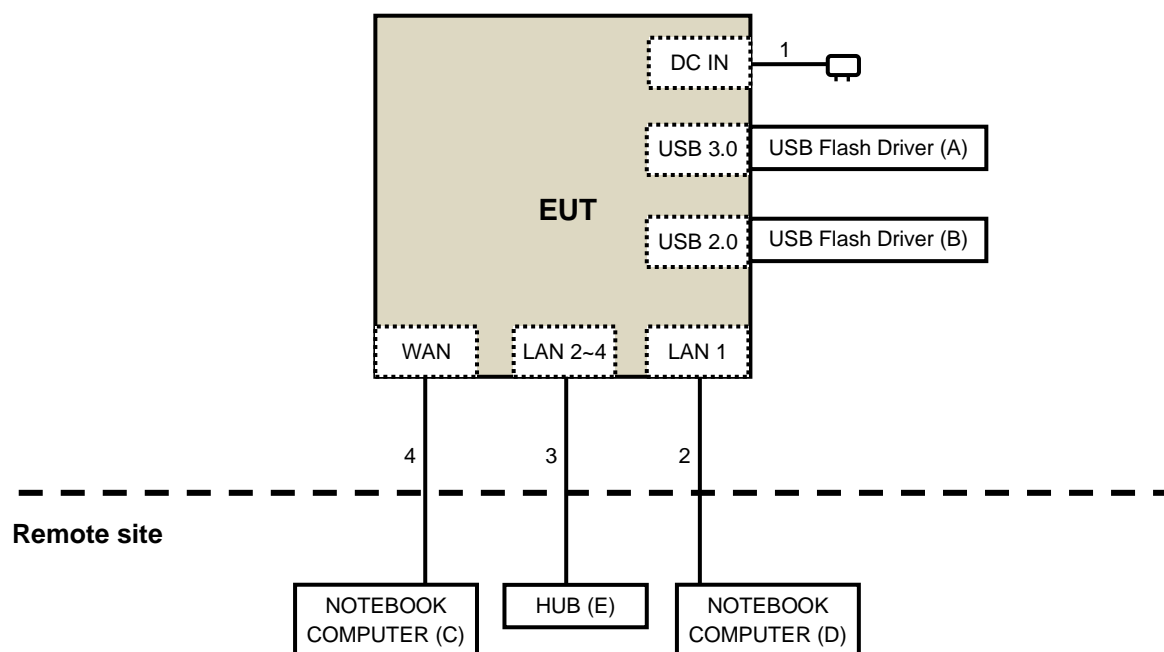

3.5 General Description of Applied Standards

The EUT is a RF Product. According to the specifications of the manufacturer, it must comply with the requirements of the following standards:

FCC Part 15, Subpart C (15.247)

558074 D01 DTS Meas Guidance v03r02

662911 D01 Multiple Transmitter Output v02r01

ANSI C63.10-2009

All test items have been performed and recorded as per the above standards.

NOTE: The EUT has been verified to comply with the requirements of FCC Part 15, Subpart B, Class B (DoC). The test report has been issued separately.

4 Test Types and Results (For 2.4GHz Band)

4.1 Radiated Emission and Bandedge Measurement

4.1.1 Limits of Radiated Emission and Bandedge Measurement

Radiated emissions which fall in the restricted bands must comply with the radiated emission limits specified as below table. Other emissions shall be at least 30dB below the highest level of the desired power:

Frequencies (MHz)	Field Strength (microvolts/meter)	Measurement Distance (meters)
0.009 ~ 0.490	2400/F(kHz)	300
0.490 ~ 1.705	24000/F(kHz)	30
1.705 ~ 30.0	30	30
30 ~ 88	100	3
88 ~ 216	150	3
216 ~ 960	200	3
Above 960	500	3

NOTE:

1. The lower limit shall apply at the transition frequencies.
2. Emission level (dBuV/m) = 20 log Emission level (uV/m).
3. For frequencies above 1000MHz, the field strength limits are based on average detector, however, the peak field strength of any emission shall not exceed the maximum permitted average limits, specified above by more than 20dB under any condition of modulation.



4.1.2 Test Instruments

For above 1GHz

DESCRIPTION & MANUFACTURER	MODEL NO.	SERIAL NO.	CALIBRATED DATE	CALIBRATED UNTIL
Test Receiver ROHDE & SCHWARZ	ESCI	100424	Oct. 06, 2014	Oct. 05, 2015
Spectrum Analyzer ROHDE & SCHWARZ	FSP40	100040	July 25, 2014	July 24, 2015
BILOG Antenna SCHWARZBECK	VULB9168	9168-155	Feb. 06, 2015	Feb. 05, 2016
HORN Antenna SCHWARZBECK	BBHA 9120D	9120D-1170	Feb. 05, 2015	Feb. 04, 2016
HORN Antenna SCHWARZBECK	BBHA 9170	BBHA9170241	Feb. 09, 2015	Feb. 08, 2016
Preamplifier Agilent	8449B	3008A01961	Oct. 18, 2014	Oct. 17, 2015
Preamplifier Agilent	8447D	2944A10738	Oct. 18, 2014	Oct. 17, 2015
RF signal cable HUBER+SUHNNER	SUCOFLEX 104	309220/4	Aug. 09, 2014	Aug. 08, 2015
RF signal cable HUBER+SUHNNER	SUCOFLEX 104	250724/4	Aug. 09, 2014	Aug. 08, 2015
RF signal cable HUBER+SUHNNER	SUCOFLEX 104	295012/4	Aug. 09, 2014	Aug. 08, 2015
Software BV ADT	ADT_Radiated_ V7.6.15.9.4	NA	NA	NA
Antenna Tower inn-co GmbH	MA 4000	010303	NA	NA
Antenna Tower Controller inn-co GmbH	CO2000	019303	NA	NA
Turn Table BV ADT	TT100	TT93021704	NA	NA
Turn Table Controller BV ADT	SC100	SC93021704	NA	NA
26GHz ~ 40GHz Amplifier	EM26400	815221	Oct. 18, 2014	Oct. 17, 2015

- NOTE: 1. The calibration interval of the above test instruments is 12 months and the calibrations are traceable to NML/ROC and NIST/USA.
2. The test was performed in HwaYa Chamber 4.
3. The horn antenna and HP preamplifier (model: 8449B) are used only for the measurement of emission frequency above 1GHz if tested.
4. The FCC Site Registration No. is 460141.
5. The IC Site Registration No. is IC7450F-4.
6. Tested Date: May 16, 2015

For below 1GHz

DESCRIPTION & MANUFACTURER	MODEL NO.	SERIAL NO.	CALIBRATED DATE	CALIBRATED UNTIL
Test Receiver Agilent	N9038A	MY50010156	Aug. 11, 2014	Aug. 10, 2015
Pre-Amplifier Mini-Circuits	ZFL-1000VH2 B	AMP-ZFL-04	Nov. 12, 2014	Nov. 11, 2015
Trilog Broadband Antenna SCHWARZBECK	VULB 9168	9168-361	Feb. 06, 2015	Feb. 05, 2016
RF Cable	NA	CHHCAB_001	Oct. 05, 2014	Oct. 04, 2015
Horn_Antenna AISI	AIH.8018	0000220091110	Feb. 06, 2015	Feb. 05, 2016
Pre-Amplifier Agilent	8449B	300801923	Oct. 28, 2014	Oct. 27, 2015
RF Cable	NA	131206 131213 131215 SNMY23685/4	Jan. 16, 2015	Jan. 15, 2016
Spectrum Analyzer R&S	FSV40	100964	July 05, 2014	July 04, 2015
Pre-Amplifier SPACEK LABS	SLKKa-48-6	9K16	Dec. 12, 2014	Dec. 11, 2015
Horn_Antenna SCHWARZBECK	BBHA 9170	9170-424	Feb. 05, 2015	Feb. 04, 2016
RF Cable	NA	329751/4 RF104-204	Dec. 11, 2014	Dec. 10, 2015
Software	ADT_Radiated _V8.7.07	NA	NA	NA
Antenna Tower & Turn Table CT	NA	NA	NA	NA

Note:

1. The calibration interval of the above test instruments is 12 months and the calibrations are traceable to NML/ROC and NIST/USA.
2. The horn antenna, preamplifier (model: 8449B) are used only for the measurement of emission frequency above 1GHz if tested.
3. The test was performed in 966 Chamber No. H.
4. The FCC Site Registration No. is 797305.
5. The CANADA Site Registration No. is IC 7450H-3.
6. Tested Date: May 16, 2015

4.1.3 Test Procedures

- a. The EUT was placed on the top of a rotating table 0.8 meters above the ground at 3 meter chamber room for test. The table was rotated 360 degrees to determine the position of the highest radiation.
- b. The EUT was set 3 meters away from the interference-receiving antenna, which was mounted on the top of a variable-height antenna tower.
- c. The height of antenna is varied from one meter to four meters above the ground to determine the maximum value of the field strength. Both horizontal and vertical polarizations of the antenna are set to make the measurement.
- d. For each suspected emission, the EUT was arranged to its worst case and then the antenna was tuned to heights from 1 meter to 4 meters and the rotatable table was turned from 0 degrees to 360 degrees to find the maximum reading.
- e. The test-receiver system was set to quasi-peak detect function and specified bandwidth with maximum hold mode when the test frequency is below 1 GHz.
- f. The test-receiver system was set to peak and average detect function and specified bandwidth with maximum hold mode when the test frequency is above 1 GHz. If the peak reading value also meets average limit, measurement with the average detector is unnecessary.

Note:

1. For emission measurements above 1 GHz, the EUT shall be placed at a height of 1.5 m above the ground at 3 meter chamber room for test
2. The resolution bandwidth and video bandwidth of test receiver/spectrum analyzer is 120kHz for Quasi-peak detection (QP) at frequency below 1GHz.
3. The resolution bandwidth of test receiver/spectrum analyzer is 1 MHz and the video bandwidth is 3 MHz for Peak detection (PK) at frequency above 1GHz.
4. The resolution bandwidth of test receiver/spectrum analyzer is 1MHz and the video bandwidth is 3MHz for RMS Average (Duty cycle < 98%) for Average detection (AV) at frequency above 1GHz, then the measurement results was added to a correction factor ($10 \log(1/\text{duty cycle})$).
5. The resolution bandwidth of test receiver/spectrum analyzer is 1MHz and the video bandwidth is 10Hz (Duty cycle $\geq 98\%$) for Average detection (AV) at frequency above 1GHz.
6. All modes of operation were investigated and the worst-case emissions are reported.

4.1.4 Deviation from Test Standard

No deviation.

4.1.5 Test Setup

<Frequency Range below 1GHz>

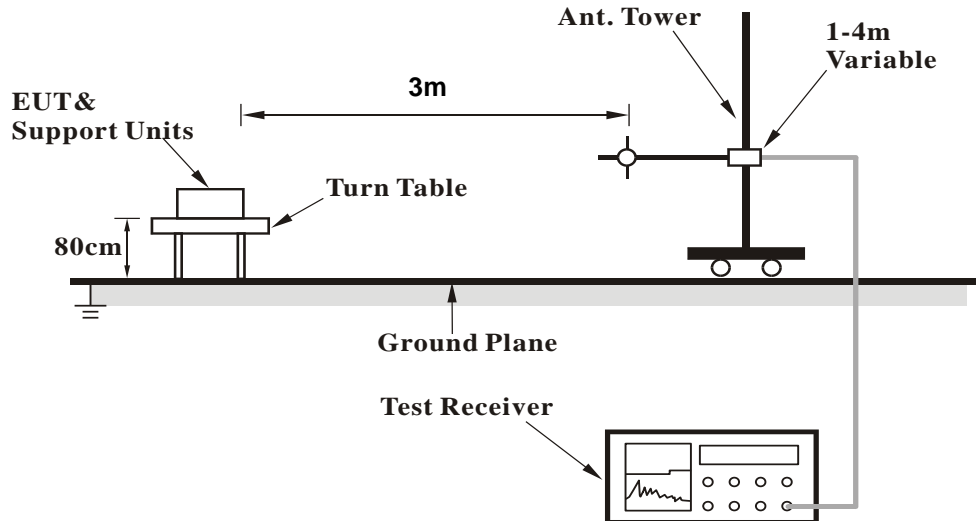

<Frequency Range above 1GHz>

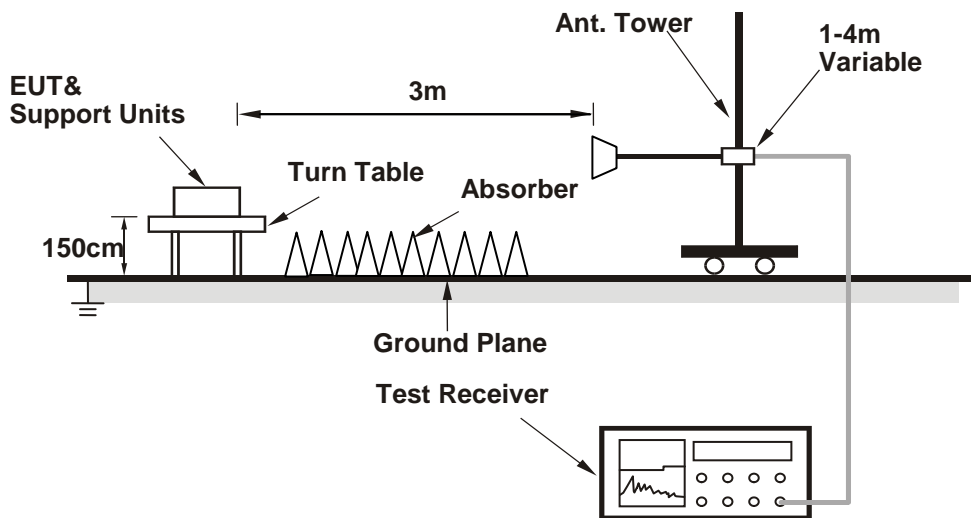

For the actual test configuration, please refer to the attached file (Test Setup Photo).

4.1.6 EUT Operating Conditions

1. Connect the EUT with the support units C-D (NOTEBOOK COMPUTER) which is placed on remote site.
2. Controlling software (Mtool.exe_2_0_2_7) has been activated to set the EUT on specific status.

4.1.7 Test Results

Above 1GHz Data (Subcontract Item):

CDD Mode

802.11b

CHANNEL	TX Channel 1	DETECTOR FUNCTION	Peak (PK)
FREQUENCY RANGE	1GHz ~ 25GHz		Average (AV)

ANTENNA POLARITY & TEST DISTANCE: HORIZONTAL AT 3 M								
NO.	FREQ. (MHz)	EMISSION LEVEL (dBuV/m)	LIMIT (dBuV/m)	MARGIN (dB)	ANTENNA HEIGHT (m)	TABLE ANGLE (Degree)	RAW VALUE (dBuV)	CORRECTION FACTOR (dB/m)
1	2390.00	54.2 PK	74.0	-19.8	1.42 H	111	57.39	-3.19
2	2390.00	41.3 AV	54.0	-12.7	1.42 H	111	44.49	-3.19
3	*2412.00	107.6 PK			1.42 H	111	110.73	-3.13
4	*2412.00	104.4 AV			1.42 H	111	107.53	-3.13
5	4824.00	53.1 PK	74.0	-20.9	1.43 H	245	47.13	5.97
6	4824.00	45.1 AV	54.0	-8.9	1.43 H	245	39.13	5.97
ANTENNA POLARITY & TEST DISTANCE: VERTICAL AT 3 M								
NO.	FREQ. (MHz)	EMISSION LEVEL (dBuV/m)	LIMIT (dBuV/m)	MARGIN (dB)	ANTENNA HEIGHT (m)	TABLE ANGLE (Degree)	RAW VALUE (dBuV)	CORRECTION FACTOR (dB/m)
1	2390.00	65.1 PK	74.0	-8.9	2.43 V	164	68.29	-3.19
2	2390.00	53.7 AV	54.0	-0.3	2.43 V	164	56.89	-3.19
3	*2412.00	120.7 PK			2.31 V	165	123.83	-3.13
4	*2412.00	118.1 AV			2.31 V	165	121.23	-3.13
5	4824.00	53.3 PK	74.0	-20.7	1.09 V	355	47.33	5.97
6	4824.00	50.4 AV	54.0	-3.6	1.09 V	355	44.43	5.97

REMARKS:

1. Emission Level(dBuV/m) = Raw Value(dBuV) + Correction Factor(dB/m)
2. Correction Factor(dB/m) = Antenna Factor(dB/m) + Cable Factor(dB) – Pre-Amplifier Factor(dB)
3. The other emission levels were very low against the limit.
4. Margin value = Emission Level – Limit value
5. " * ": Fundamental frequency.

CHANNEL	TX Channel 6	DETECTOR FUNCTION	Peak (PK)
FREQUENCY RANGE	1GHz ~ 25GHz		Average (AV)

ANTENNA POLARITY & TEST DISTANCE: HORIZONTAL AT 3 M

NO.	FREQ. (MHz)	EMISSION LEVEL (dBuV/m)	LIMIT (dBuV/m)	MARGIN (dB)	ANTENNA HEIGHT (m)	TABLE ANGLE (Degree)	RAW VALUE (dBuV)	CORRECTION FACTOR (dB/m)
1	2390.00	54.0 PK	74.0	-20.0	2.03 H	200	57.19	-3.19
2	2390.00	42.1 AV	54.0	-11.9	2.03 H	200	45.29	-3.19
3	*2437.00	107.5 PK			1.53 H	198	110.54	-3.04
4	*2437.00	104.9 AV			1.53 H	198	107.94	-3.04
5	2483.50	49.5 PK	74.0	-24.5	1.91 H	208	52.37	-2.87
6	2483.50	39.2 AV	54.0	-14.8	1.91 H	208	42.07	-2.87
7	4874.00	52.9 PK	74.0	-21.1	1.48 H	245	46.85	6.05
8	4874.00	44.8 AV	54.0	-9.2	1.48 H	245	38.75	6.05
9	7311.00	58.4 PK	74.0	-15.6	1.00 H	108	47.46	10.94
10	7311.00	45.4 AV	54.0	-8.6	1.00 H	108	34.46	10.94

ANTENNA POLARITY & TEST DISTANCE: VERTICAL AT 3 M

NO.	FREQ. (MHz)	EMISSION LEVEL (dBuV/m)	LIMIT (dBuV/m)	MARGIN (dB)	ANTENNA HEIGHT (m)	TABLE ANGLE (Degree)	RAW VALUE (dBuV)	CORRECTION FACTOR (dB/m)
1	2390.00	66.2 PK	74.0	-7.8	2.38 V	163	69.39	-3.19
2	2390.00	53.9 AV	54.0	-0.1	2.38 V	163	57.09	-3.19
3	*2437.00	126.1 PK			2.38 V	166	129.14	-3.04
4	*2437.00	123.5 AV			2.38 V	166	126.54	-3.04
5	4874.00	56.9 PK	74.0	-17.1	1.13 V	355	50.85	6.05
6	4874.00	53.6 AV	54.0	-0.4	1.13 V	355	47.55	6.05
7	7311.00	58.3 PK	74.0	-15.7	1.34 V	241	47.36	10.94
8	7311.00	46.9 AV	54.0	-7.1	1.34 V	241	35.96	10.94

REMARKS:

1. Emission Level(dBuV/m) = Raw Value(dBuV) + Correction Factor(dB/m)
2. Correction Factor(dB/m) = Antenna Factor(dB/m) + Cable Factor(dB) – Pre-Amplifier Factor(dB)
3. The other emission levels were very low against the limit.
4. Margin value = Emission Level – Limit value
5. " * ": Fundamental frequency.



CHANNEL	TX Channel 11	DETECTOR FUNCTION	Peak (PK)
FREQUENCY RANGE	1GHz ~ 25GHz		Average (AV)

ANTENNA POLARITY & TEST DISTANCE: HORIZONTAL AT 3 M

NO.	FREQ. (MHz)	EMISSION LEVEL (dBuV/m)	LIMIT (dBuV/m)	MARGIN (dB)	ANTENNA HEIGHT (m)	TABLE ANGLE (Degree)	RAW VALUE (dBuV)	CORRECTION FACTOR (dB/m)
1	*2462.00	106.2 PK			1.52 H	217	109.14	-2.94
2	*2462.00	103.0 AV			1.52 H	217	105.94	-2.94
3	2483.50	53.2 PK	74.0	-20.8	2.01 H	204	56.07	-2.87
4	2483.50	41.5 AV	54.0	-12.5	2.01 H	204	44.37	-2.87
5	4924.00	53.0 PK	74.0	-21.0	1.42 H	232	46.93	6.07
6	4924.00	45.1 AV	54.0	-8.9	1.42 H	232	39.03	6.07
7	7386.00	58.2 PK	74.0	-15.8	1.02 H	137	46.78	11.42
8	7386.00	45.3 AV	54.0	-8.7	1.02 H	137	33.88	11.42

ANTENNA POLARITY & TEST DISTANCE: VERTICAL AT 3 M

NO.	FREQ. (MHz)	EMISSION LEVEL (dBuV/m)	LIMIT (dBuV/m)	MARGIN (dB)	ANTENNA HEIGHT (m)	TABLE ANGLE (Degree)	RAW VALUE (dBuV)	CORRECTION FACTOR (dB/m)
1	*2462.00	122.5 PK			2.35 V	169	125.44	-2.94
2	*2462.00	120.1 AV			2.35 V	169	123.04	-2.94
3	2483.50	65.2 PK	74.0	-8.8	2.35 V	169	68.07	-2.87
4	2483.50	53.6 AV	54.0	-0.4	2.35 V	169	56.47	-2.87
5	4924.00	55.2 PK	74.0	-18.8	1.06 V	83	49.13	6.07
6	4924.00	51.2 AV	54.0	-2.8	1.06 V	83	45.13	6.07
7	7386.00	58.2 PK	74.0	-15.8	1.31 V	249	46.78	11.42
8	7386.00	46.8 AV	54.0	-7.2	1.31 V	249	35.38	11.42

REMARKS:

1. Emission Level(dBuV/m) = Raw Value(dBuV) + Correction Factor(dB/m)
2. Correction Factor(dB/m) = Antenna Factor(dB/m) + Cable Factor(dB) – Pre-Amplifier Factor(dB)
3. The other emission levels were very low against the limit.
4. Margin value = Emission Level – Limit value
5. " * ": Fundamental frequency.



Below 1GHz Data:

CDD MODE

802.11b

CHANNEL	TX Channel 6	DETECTOR FUNCTION	Quasi-Peak (QP)
FREQUENCY RANGE	Below 1GHz		

ANTENNA POLARITY & TEST DISTANCE: HORIZONTAL AT 3 M

NO.	FREQ. (MHz)	EMISSION LEVEL (dBuV/m)	LIMIT (dBuV/m)	MARGIN (dB)	ANTENNA HEIGHT (m)	TABLE ANGLE (Degree)	RAW VALUE (dBuV)	CORRECTION FACTOR (dB/m)
1	219.54	41.6 QP	46.0	-4.4	1.45 H	145	57.68	-16.06
2	318.75	41.8 QP	46.0	-4.2	1.24 H	241	52.94	-11.13
3	331.61	42.8 QP	46.0	-3.3	1.24 H	134	53.53	-10.78
4	379.46	41.7 QP	46.0	-4.3	1.24 H	241	51.84	-10.12
5	392.24	41.2 QP	46.0	-4.8	1.24 H	211	51.05	-9.81
6	750.15	41.7 QP	46.0	-4.3	1.24 H	64	43.70	-1.99

ANTENNA POLARITY & TEST DISTANCE: VERTICAL AT 3 M

NO.	FREQ. (MHz)	EMISSION LEVEL (dBuV/m)	LIMIT (dBuV/m)	MARGIN (dB)	ANTENNA HEIGHT (m)	TABLE ANGLE (Degree)	RAW VALUE (dBuV)	CORRECTION FACTOR (dB/m)
1	51.74	36.3 QP	40.0	-3.7	1.24 V	241	49.68	-13.36
2	62.15	35.1 QP	40.0	-4.9	1.34 V	154	49.56	-14.42
3	340.24	42.7 QP	46.0	-3.3	1.45 V	241	53.51	-10.77
4	368.25	41.8 QP	46.0	-4.3	1.34 V	204	52.03	-10.28
5	410.15	41.2 QP	46.0	-4.8	1.24 V	241	50.57	-9.33
6	749.45	41.5 QP	46.0	-4.5	1.45 V	245	43.51	-1.99

REMARKS:

1. Emission Level(dBuV/m) = Raw Value(dBuV) + Correction Factor(dB/m)
2. Correction Factor(dB/m) = Antenna Factor(dB/m) + Cable Factor(dB) – Pre-Amplifier Factor(dB)
3. The other emission levels were very low against the limit.
4. Margin value = Emission Level – Limit value

4.2 Conducted Emission Measurement

4.2.1 Limits of Conducted Emission Measurement

Frequency (MHz)	Conducted Limit (dBuV)	
	Quasi-peak	Average
0.15 - 0.5	66 - 56	56 - 46
0.50 - 5.0	56	46
5.0 - 30.0	60	50

Note: 1. The lower limit shall apply at the transition frequencies.

2. The limit decreases in line with the logarithm of the frequency in the range of 0.15 to 0.50MHz.

4.2.2 Test Instruments

DESCRIPTION & MANUFACTURER	MODEL NO.	SERIAL NO.	CALIBRATED DATE	CALIBRATED UNTIL
Test Receiver ROHDE & SCHWARZ	ESCS 30	100375	May 06, 2015	May 05, 2016
Line-Impedance Stabilization Network (for EUT) SCHWARZBECK	NSLK-8127	8127-522	Sep. 15, 2014	Sep. 14, 2015
Line-Impedance Stabilization Network (for Peripheral) ROHDE & SCHWARZ	ENV216	100071	Nov. 10, 2014	Nov. 09, 2015
RF Cable (JYEBAO)	5D-FB	COCCAB-001	Mar. 09, 2015	Mar. 08, 2016
50 ohms Terminator	N/A	EMC-03	Sep. 22, 2014	Sep. 21, 2015
50 ohms Terminator	N/A	EMC-02	Sep. 30, 2014	Sep. 29, 2015
Software ADT	BV ADT_Cond_V7.3.7.3	NA	NA	NA

Note:

1. The calibration interval of the above test instruments is 12 months and the calibrations are traceable to NML/ROC and NIST/USA.
2. The test was performed in Shielded Room No. C.
3. The VCCI Con C Registration No. is C-3611.
4. Tested Date: May 07, 2015

4.2.3 Test Procedures

- a. The EUT was placed 0.4 meters from the conducting wall of the shielded room with EUT being connected to the power mains through a line impedance stabilization network (LISN). Other support units were connected to the power mains through another LISN. The two LISNs provide 50 ohm/ 50uH of coupling impedance for the measuring instrument.
- b. Both lines of the power mains connected to the EUT were checked for maximum conducted interference.
- c. The frequency range from 150kHz to 30MHz was searched. Emission levels under (Limit - 20dB) was not recorded.

NOTE: The resolution bandwidth and video bandwidth of test receiver is 9kHz for quasi-peak detection (QP) and average detection (AV) at frequency 0.15MHz-30MHz.

4.2.4 Deviation from Test Standard

No deviation.

4.2.5 Test Setup

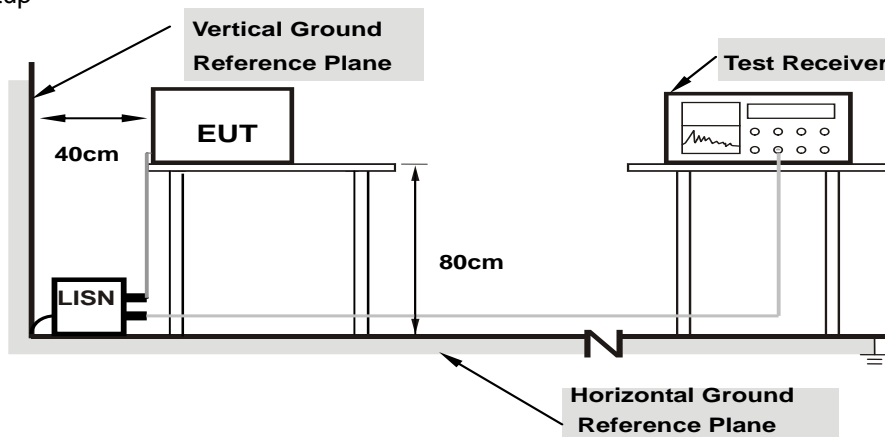

Note: 1.Support units were connected to second LISN.

For the actual test configuration, please refer to the attached file (Test Setup Photo).

4.2.6 EUT Operating Conditions

Same as 4.1.6.

4.2.7 Test Results

Phase	Line (L)	Detector Function	Quasi-Peak (QP) / Average (AV)
-------	----------	-------------------	--------------------------------

No	Freq. [MHz]	Corr.	Reading Value		Emission Level		Limit		Margin	
		Factor	[dB (uV)]		[dB (uV)]		[dB (uV)]		(dB)	
	(dB)	Q.P.	AV.	Q.P.	AV.	Q.P.	AV.	Q.P.	AV.	
1	0.15000	0.08	47.55	27.00	47.63	27.08	66.00	56.00	-18.37	-28.92
2	0.29063	0.09	40.68	33.42	40.77	33.51	60.51	50.51	-19.73	-16.99
3	0.93516	0.13	37.77	28.56	37.90	28.69	56.00	46.00	-18.10	-17.31
4	3.43359	0.21	38.00	30.55	38.21	30.76	56.00	46.00	-17.79	-15.24
5	9.38281	0.43	45.53	40.06	45.96	40.49	60.00	50.00	-14.04	-9.51
6	12.61719	0.52	43.20	38.23	43.72	38.75	60.00	50.00	-16.28	-11.25

REMARKS:

1. Q.P. and AV. are abbreviations of quasi-peak and average individually.
2. The emission levels of other frequencies were very low against the limit.
3. Margin value = Emission level - Limit value
4. Correction factor = Insertion loss + Cable loss
5. Emission Level = Correction Factor + Reading Value.

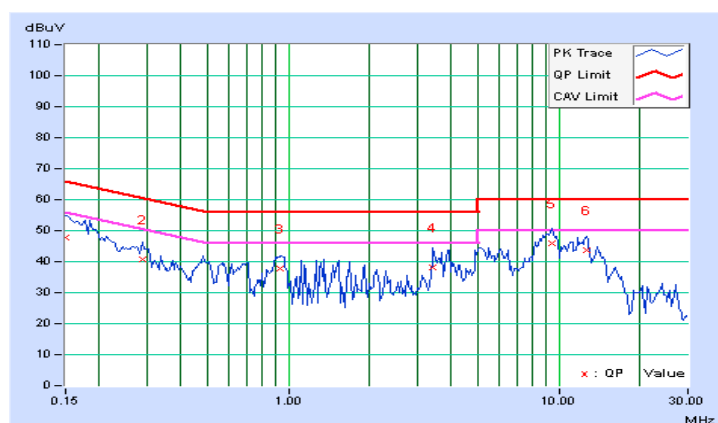

Phase	Neutral (N)	Detector Function	Quasi-Peak (QP) / Average (AV)
-------	-------------	-------------------	--------------------------------

No	Freq. [MHz]	Corr.	Reading Value		Emission Level		Limit		Margin	
		Factor	[dB (uV)]		[dB (uV)]		[dB (uV)]		(dB)	
		(dB)	Q.P.	AV.	Q.P.	AV.	Q.P.	AV.	Q.P.	AV.
1	0.15000	0.08	49.09	24.71	49.17	24.79	66.00	56.00	-16.83	-31.21
2	0.30222	0.09	40.02	30.99	40.11	31.08	60.18	50.18	-20.07	-19.10
3	1.26563	0.14	31.65	24.01	31.79	24.15	56.00	46.00	-24.21	-21.85
4	3.93359	0.23	39.09	31.19	39.32	31.42	56.00	46.00	-16.68	-14.58
5	10.27734	0.47	40.71	35.49	41.18	35.96	60.00	50.00	-18.82	-14.04
6	12.41406	0.53	42.36	37.36	42.89	37.89	60.00	50.00	-17.11	-12.11

REMARKS:

1. Q.P. and AV. are abbreviations of quasi-peak and average individually.
2. The emission levels of other frequencies were very low against the limit.
3. Margin value = Emission level - Limit value
4. Correction factor = Insertion loss + Cable loss
5. Emission Level = Correction Factor + Reading Value.

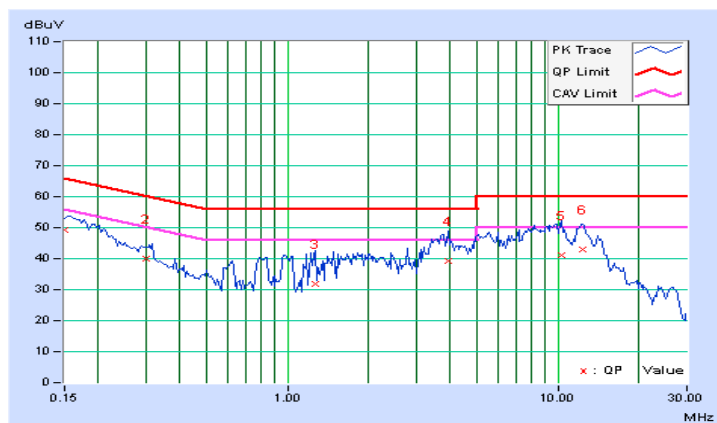

4.3 6dB Bandwidth Measurement

4.3.1 Limits of 6dB Bandwidth Measurement

The minimum of 6dB Bandwidth Measurement is 0.5 MHz.

4.3.2 Test Setup

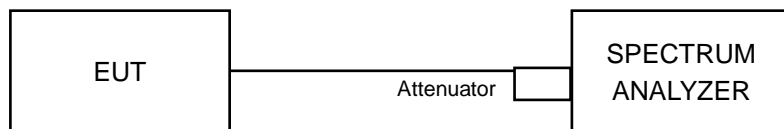

4.3.3 Test Instruments

DESCRIPTION & MANUFACTURER	MODEL NO.	SERIAL NO.	CALIBRATED DATE	CALIBRATED UNTIL
SPECTRUM ANALYZER R&S	FSV 40	100964	July 05, 2014	July 04, 2015

- NOTE:**
1. The test was performed in Oven room B.
 2. The calibration interval of the above test instruments is 12 months and the calibrations are traceable to NML/ROC and NIST/USA.
 3. Tested Date: May 16, 2015

4.3.4 Test Procedure

- a. Set resolution bandwidth (RBW) = 100kHz
- b. Set the video bandwidth (VBW) $\geq 3 \times$ RBW, Detector = Peak.
- c. Trace mode = max hold.
- d. Sweep = auto couple.
- e. Measure the maximum width of the emission that is constrained by the frequencies associated with the two amplitude points (upper and lower) that are attenuated by 6 dB relative to the maximum level measured in the fundamental emission

4.3.5 Deviation from Test Standard

No deviation.

4.3.6 EUT Operating Conditions

The software provided by client to enable the EUT under transmission condition continuously at lowest, middle and highest channel frequencies individually.

4.3.7 Test Result

CDD MODE

Channel	Frequency (MHz)	6dB Bandwidth (MHz)				Minimum Limit (MHz)	Pass / Fail
		Chain 0	Chain 1	Chain 2	Chain 3		
802.11b							
1	2412	9.05	8.14	8.59	8.13	0.5	PASS
6	2437	9.08	8.60	8.62	9.09	0.5	PASS
11	2462	8.59	8.14	8.13	8.58	0.5	PASS

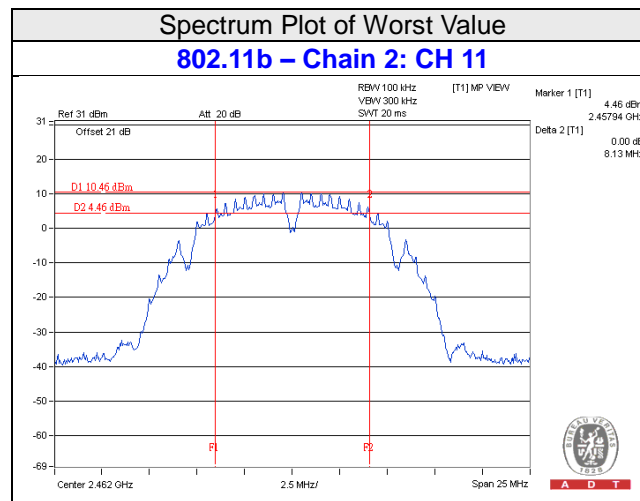

4.4 Conducted Output Power Measurement

4.4.1 Limits of Conducted Output Power Measurement

For systems using digital modulation in the 2400–2483.5 MHz bands: 1 Watt (30dBm)

Per KDB 662911 D01 Multiple Transmitter Output Method of conducted output power measurement on IEEE 802.11 devices,

Array Gain = 0 dB (i.e., no array gain) for $NANT \leq 4$;

Array Gain = 0 dB (i.e., no array gain) for channel widths ≥ 40 MHz for any NANT;

Array Gain = $5 \log(NANT/NSS)$ dB or 3 dB, whichever is less for 20-MHz channel widths with $NANT \geq 5$.

For power measurements on all other devices: Array Gain = $10 \log(NANT/NSS)$ dB.

4.4.2 Test Setup

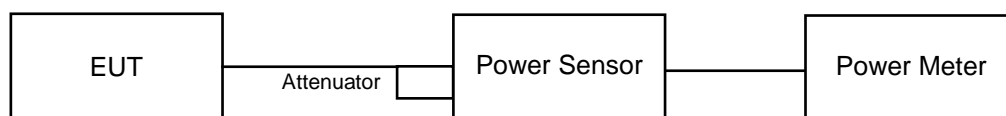

4.4.3 Test Instruments

DESCRIPTION & MANUFACTURER	MODEL NO.	SERIAL NO.	CALIBRATED DATE	CALIBRATED UNTIL
Power Meter Anritsu	ML2495A	0824006	May 22, 2014	May 21, 2015
Power Sensor Anritsu	MA2411B	0738172	May 22, 2014	May 21, 2015

- NOTE:**
1. The test was performed in Oven room B.
 2. The calibration interval of the above test instruments is 12 months and the calibrations are traceable to NML/ROC and NIST/USA.
 3. Tested Date: May 16, 2015

4.4.4 Test Procedures

A average power sensor was used on the output port of the EUT. A power meter was used to read the response of the average power sensor. Record the power level.

4.4.5 Deviation from Test Standard

No deviation.

4.4.6 EUT Operating Conditions

Same as Item 4.3.6.

4.4.7 Test Results

CDD MODE

Channel	Frequency (MHz)	Average Power (dBm)				Total Power (mW)	Total Power (dBm)	Limit (dBm)	Pass / Fail
		Chain 0	Chain 1	Chain 2	Chain 3				
802.11b									
1	2412	21.20	20.75	19.54	21.72	489.22	26.90	30	Pass
6	2437	23.91	24.05	22.47	24.56	962.497	29.83	30	Pass
11	2462	22.38	21.96	21.54	22.75	660.944	28.20	30	Pass

4.5 Power Spectral Density Measurement

4.5.1 Limits of Power Spectral Density Measurement

The Maximum of Power Spectral Density Measurement is 8dBm.

4.5.2 Test Setup

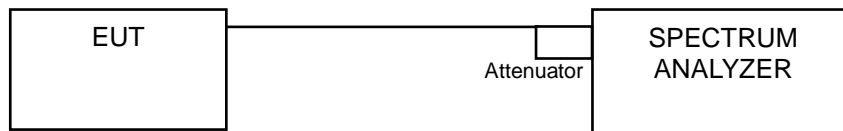

4.5.3 Test Instruments

DESCRIPTION & MANUFACTURER	MODEL NO.	SERIAL NO.	CALIBRATED DATE	CALIBRATED UNTIL
SPECTRUM ANALYZER R&S	FSV 40	100964	July 05, 2014	July 04, 2015

- NOTE:**
1. The test was performed in Oven room B.
 2. The calibration interval of the above test instruments is 12 months and the calibrations are traceable to NML/ROC and NIST/USA.
 3. Tested Date: May 16, 2015

4.5.4 Test Procedure

- a) Set instrument center frequency to DTS channel center frequency.
- b) Set span to at least 1.5 times the OBW.
- c) Set RBW to: $3 \text{ kHz} \leq \text{RBW} \leq 100 \text{ kHz}$.
- d) Set VBW $\geq 3 \times \text{RBW}$.
- e) Detector = power averaging (RMS) or sample detector (when RMS not available).
- f) Ensure that the number of measurement points in the sweep $\geq 2 \times \text{span/RBW}$.
- g) Sweep time = auto couple.
- h) Employ trace averaging (RMS) mode over a minimum of 100 traces.
- i) Use the peak marker function to determine the maximum amplitude level.

4.5.5 Deviation from Test Standard

No deviation.

4.5.6 EUT Operating Condition

Same as Item 4.3.6

4.5.7 Test Results

CDD Mode

TX chain	Channel	Freq. (MHz)	PSD (dBm)	10 log (N=4) dB	Total PSD (dBm)	Limit (dBm)	Pass /Fail
802.11b							
0	1	2412	-8.64	6.02	-2.62	7.31	Pass
	6	2437	-4.06	6.02	1.96	7.31	Pass
	11	2462	-7.35	6.02	-1.33	7.31	Pass
1	1	2412	-8.60	6.02	-2.58	7.31	Pass
	6	2437	-3.59	6.02	2.43	7.31	Pass
	11	2462	-7.15	6.02	-1.13	7.31	Pass
2	1	2412	-10.20	6.02	-4.18	7.31	Pass
	6	2437	-5.98	6.02	0.04	7.31	Pass
	11	2462	-9.14	6.02	-3.12	7.31	Pass
3	1	2412	-7.49	6.02	-1.47	7.31	Pass
	6	2437	-3.83	6.02	2.19	7.31	Pass
	11	2462	-6.65	6.02	-0.63	7.31	Pass

Note: 1. Method a) of power density measurement of KDB 662911 is using for calculating total power density. Total power density is summing entire spectra across corresponding frequency bins on the various outputs by computer.

2. Directional gain = 0.67dBi + 10log(4) = 6.69dBi > 6dBi , so the power density limit shall be reduced to 8-(6.02-6) = 7.31dBm.

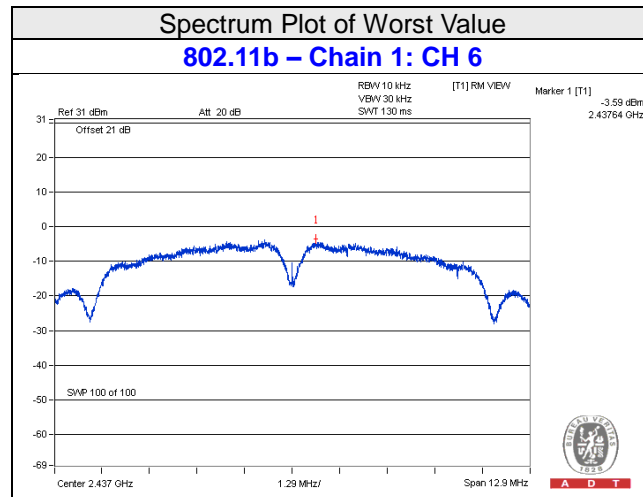

4.6 Conducted Out of Band Emission Measurement

4.6.1 Limits of Conducted Out of Band Emission Measurement

Below 30dB of the highest emission level of operating band (in 100kHz Resolution Bandwidth).

4.6.2 Test Setup

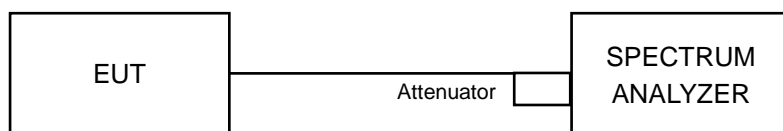

4.6.3 Test Instruments

DESCRIPTION & MANUFACTURER	MODEL NO.	SERIAL NO.	CALIBRATED DATE	CALIBRATED UNTIL
SPECTRUM ANALYZER R&S	FSV 40	100964	July 05, 2014	July 04, 2015

- NOTE:**
1. The test was performed in Oven room B.
 2. The calibration interval of the above test instruments is 12 months and the calibrations are traceable to NML/ROC and NIST/USA.
 3. Tested Date: May 16, 2015

4.6.4 Test Procedure

MEASUREMENT PROCEDURE REF

1. Set the RBW = 100 kHz.
2. Set the VBW \geq 300 kHz.
3. Detector = peak.
4. Sweep time = auto couple.
5. Trace mode = max hold.
6. Allow trace to fully stabilize.
7. Use the peak marker function to determine the maximum power level in any 100 kHz band segment within the fundamental EBW.

MEASUREMENT PROCEDURE OOB

1. Set RBW = 100 kHz.
2. Set VBW \geq 300 kHz.
3. Detector = peak.
4. Sweep = auto couple.
5. Trace Mode = max hold.
6. Allow trace to fully stabilize.
7. Use the peak marker function to determine the maximum amplitude level.

4.6.5 Deviation from Test Standard

No deviation.

4.6.6 EUT Operating Condition

Same as Item 4.3.6

4.6.7 Test Results

The spectrum plots are attached on the following pages. D1 line indicates the highest level, and D2 line indicates the 30dB offset below D1. It shows compliance with the requirement.

CDD Mode
802.11b

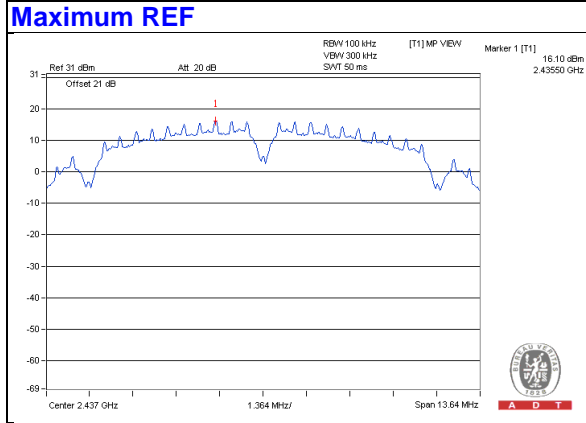

Chain 0
CH 1

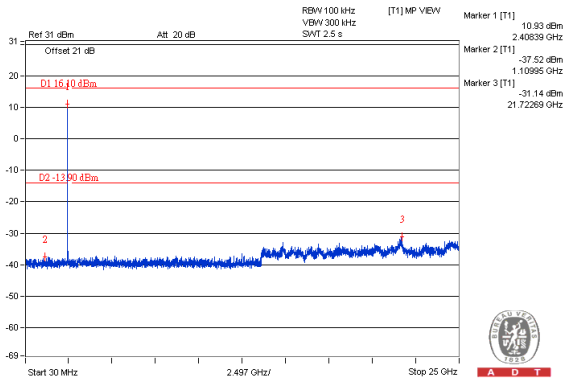

CH 6

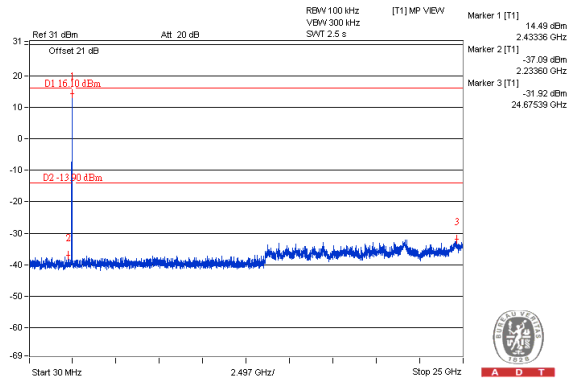

CH 11

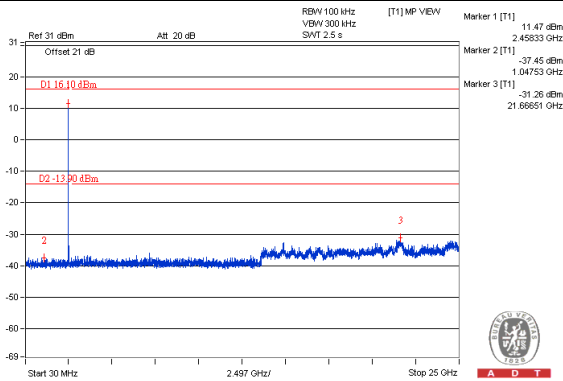

CH 1 Band edge

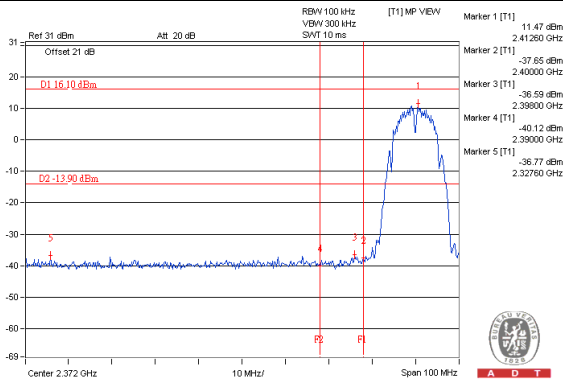

CH 11 Band edge

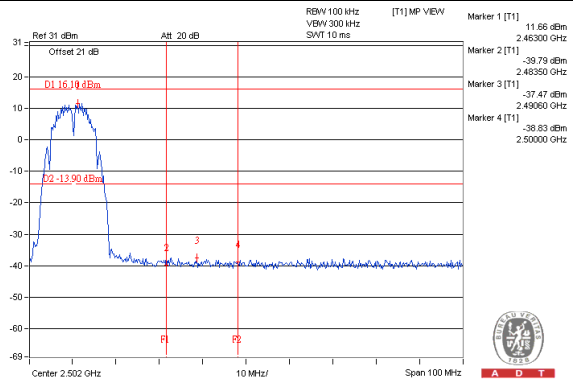

Chain 1

CH 1

CH 6

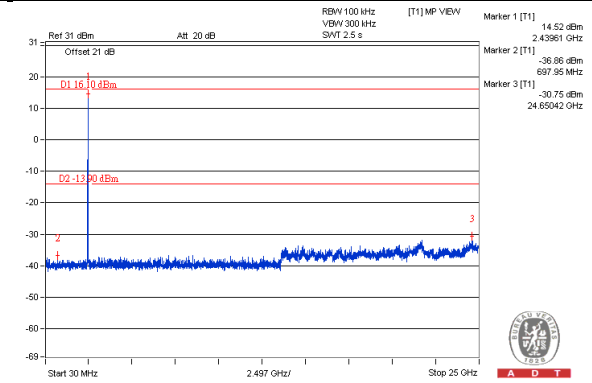
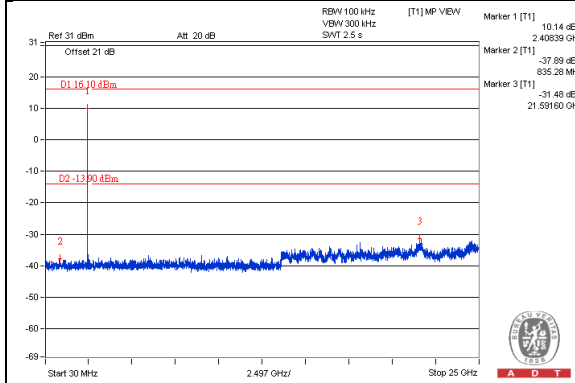

CH 11

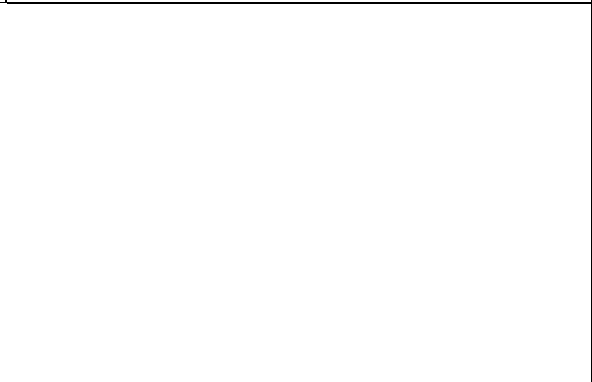
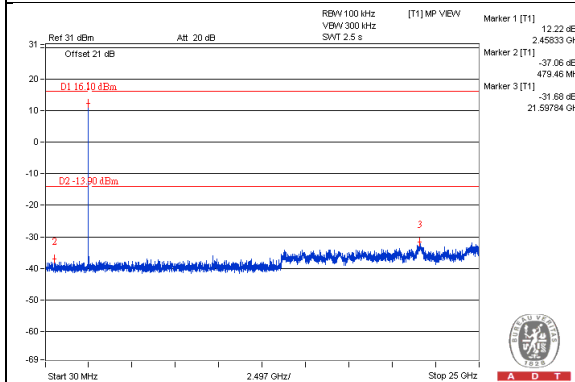

CH 1 Band edge

CH 11 Band edge

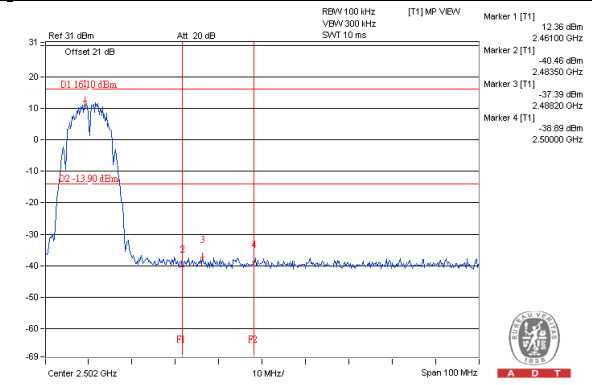
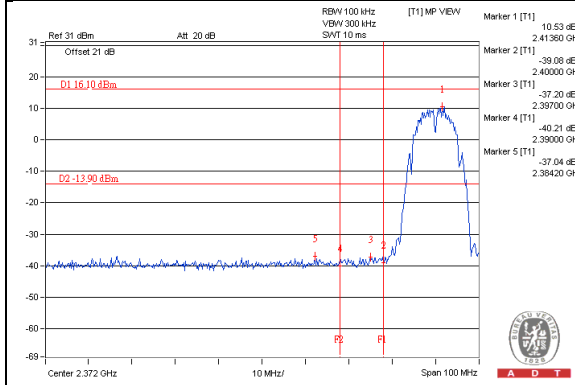

Chain 2

CH 1

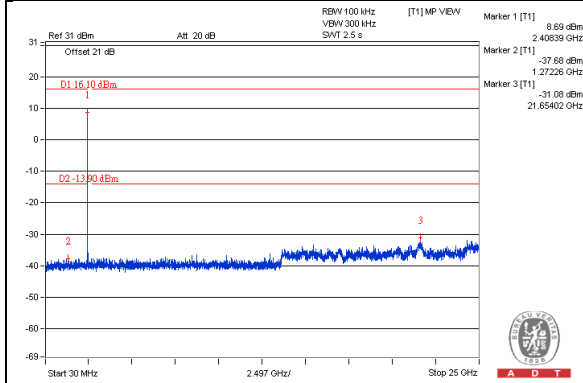

CH 6

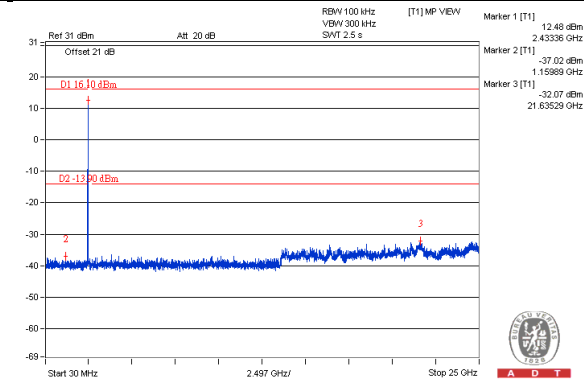

CH 11

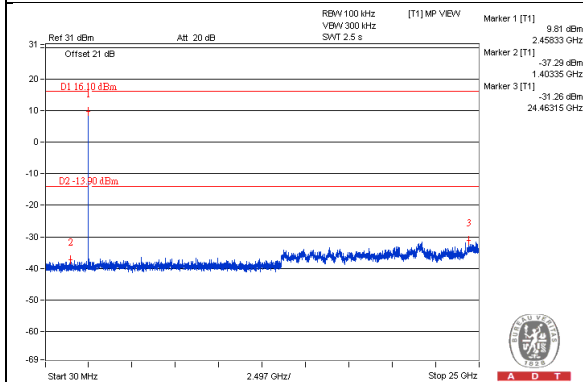

CH 1 Band edge

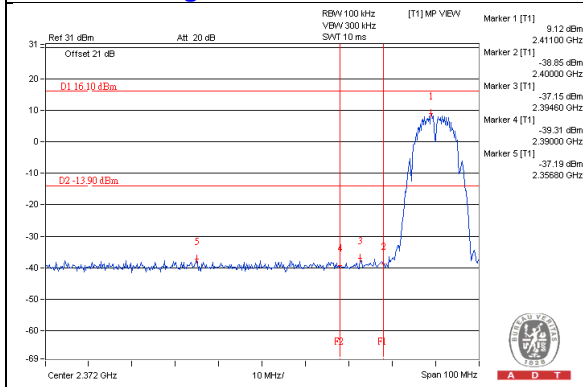

CH 11 Band edge

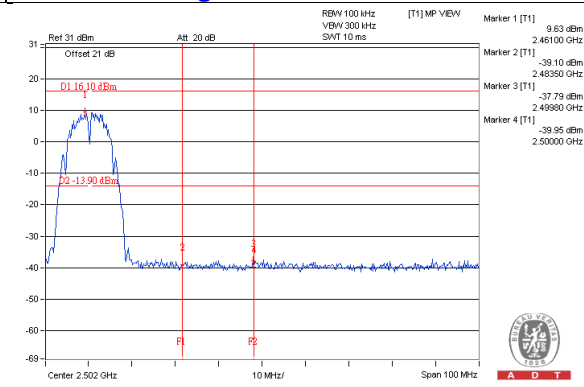

Chain 3

CH 1

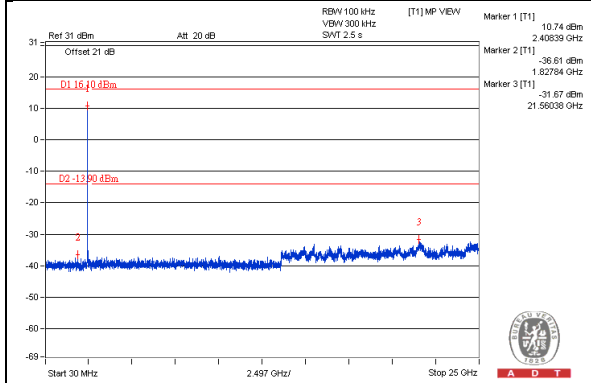

CH 6

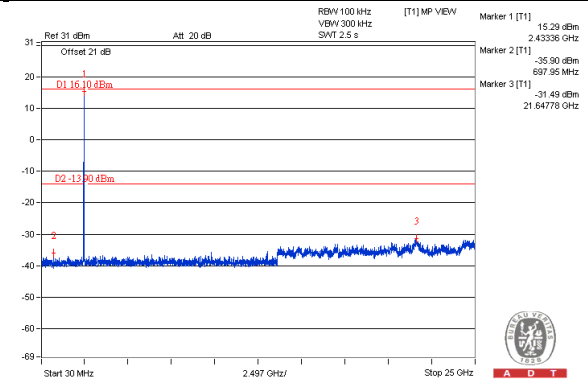

CH 11

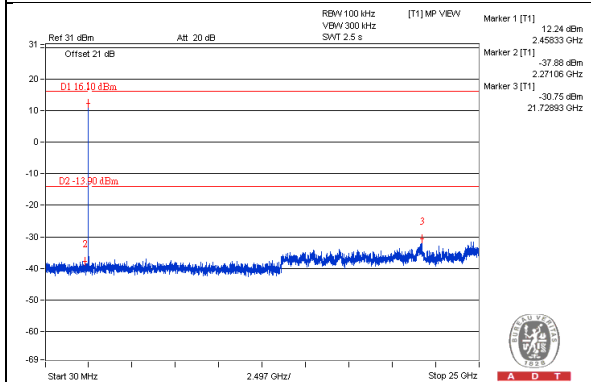

CH 1 Band edge

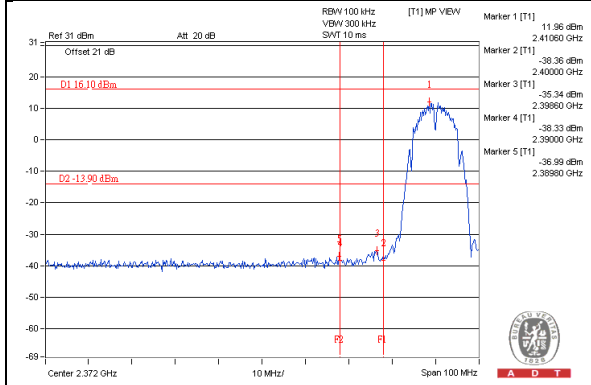

CH 11 Band edge

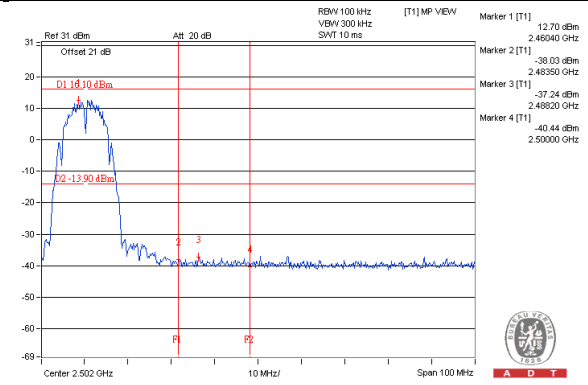

5 Test Types and Results (For 5GHz Band)

5.1 Radiated Emission and Bandedge Measurement

5.1.1 Limits of Radiated Emission and Bandedge Measurement

Radiated emissions which fall in the restricted bands must comply with the radiated emission limits specified as below table. Other emissions shall be at least 30dB below the highest level of the desired power:

Frequencies (MHz)	Field Strength (microvolts/meter)	Measurement Distance (meters)
0.009 ~ 0.490	2400/F(kHz)	300
0.490 ~ 1.705	24000/F(kHz)	30
1.705 ~ 30.0	30	30
30 ~ 88	100	3
88 ~ 216	150	3
216 ~ 960	200	3
Above 960	500	3

NOTE:

1. The lower limit shall apply at the transition frequencies.
2. Emission level (dBuV/m) = 20 log Emission level (uV/m).
3. For frequencies above 1000MHz, the field strength limits are based on average detector, however, the peak field strength of any emission shall not exceed the maximum permitted average limits, specified above by more than 20dB under any condition of modulation.



5.1.2 Test Instruments

For above 1GHz

DESCRIPTION & MANUFACTURER	MODEL NO.	SERIAL NO.	CALIBRATED DATE	CALIBRATED UNTIL
Test Receiver ROHDE & SCHWARZ	ESCI	100424	Oct. 06, 2014	Oct. 05, 2015
Spectrum Analyzer ROHDE & SCHWARZ	FSP40	100040	July 25, 2014	July 24, 2015
BILOG Antenna SCHWARZBECK	VULB9168	9168-155	Feb. 06, 2015	Feb. 05, 2016
HORN Antenna SCHWARZBECK	BBHA 9120D	9120D-1170	Feb. 05, 2015	Feb. 04, 2016
HORN Antenna SCHWARZBECK	BBHA 9170	BBHA9170241	Feb. 09, 2015	Feb. 08, 2016
Preamplifier Agilent	8449B	3008A01961	Oct. 18, 2014	Oct. 17, 2015
Preamplifier Agilent	8447D	2944A10738	Oct. 18, 2014	Oct. 17, 2015
RF signal cable HUBER+SUHNNER	SUCOFLEX 104	309220/4	Aug. 09, 2014	Aug. 08, 2015
RF signal cable HUBER+SUHNNER	SUCOFLEX 104	250724/4	Aug. 09, 2014	Aug. 08, 2015
RF signal cable HUBER+SUHNNER	SUCOFLEX 104	295012/4	Aug. 09, 2014	Aug. 08, 2015
Software BV ADT	ADT_Radiated_ V7.6.15.9.4	NA	NA	NA
Antenna Tower inn-co GmbH	MA 4000	010303	NA	NA
Antenna Tower Controller inn-co GmbH	CO2000	019303	NA	NA
Turn Table BV ADT	TT100	TT93021704	NA	NA
Turn Table Controller BV ADT	SC100	SC93021704	NA	NA
26GHz ~ 40GHz Amplifier	EM26400	815221	Oct. 18, 2014	Oct. 17, 2015

- NOTE: 1. The calibration interval of the above test instruments is 12 months and the calibrations are traceable to NML/ROC and NIST/USA.
2. The test was performed in HwaYa Chamber 4.
 3. The horn antenna and HP preamplifier (model: 8449B) are used only for the measurement of emission frequency above 1GHz if tested.
 4. The FCC Site Registration No. is 460141.
 5. The IC Site Registration No. is IC7450F-4.
 6. Tested Date: May 11, 2015

**For below 1GHz**

DESCRIPTION & MANUFACTURER	MODEL NO.	SERIAL NO.	CALIBRATED DATE	CALIBRATED UNTIL
Test Receiver Agilent	N9038A	MY50010156	Aug. 11, 2014	Aug. 10, 2015
Pre-Amplifier Mini-Circuits	ZFL-1000VH2 B	AMP-ZFL-04	Nov. 12, 2014	Nov. 11, 2015
Trilog Broadband Antenna SCHWARZBECK	VULB 9168	9168-361	Feb. 06, 2015	Feb. 05, 2016
RF Cable	NA	CHHCAB_001	Oct. 05, 2014	Oct. 04, 2015
Horn_Antenna AISI	AIH.8018	0000220091110	Feb. 06, 2015	Feb. 05, 2016
Pre-Amplifier Agilent	8449B	300801923	Oct. 28, 2014	Oct. 27, 2015
RF Cable	NA	131206 131213 131215 SNMY23685/4	Jan. 16, 2015	Jan. 15, 2016
Spectrum Analyzer R&S	FSV40	100964	July 05, 2014	July 04, 2015
Pre-Amplifier SPACEK LABS	SLKKa-48-6	9K16	Dec. 12, 2014	Dec. 11, 2015
Horn_Antenna SCHWARZBECK	BBHA 9170	9170-424	Feb. 05, 2015	Feb. 04, 2016
RF Cable	NA	329751/4 RF104-204	Dec. 11, 2014	Dec. 10, 2015
Software	ADT_Radiated _V8.7.07	NA	NA	NA
Antenna Tower & Turn Table CT	NA	NA	NA	NA

Note:

1. The calibration interval of the above test instruments is 12 months and the calibrations are traceable to NML/ROC and NIST/USA.
2. The horn antenna, preamplifier (model: 8449B) are used only for the measurement of emission frequency above 1GHz if tested.
3. The test was performed in 966 Chamber No. H.
4. The FCC Site Registration No. is 797305.
5. The CANADA Site Registration No. is IC 7450H-3.
6. Tested Date: May 12, 2015

5.1.3 Test Procedures

- a. The EUT was placed on the top of a rotating table 0.8 meters above the ground at 3 meter chamber room for test. The table was rotated 360 degrees to determine the position of the highest radiation.
- b. The EUT was set 3 meters away from the interference-receiving antenna, which was mounted on the top of a variable-height antenna tower.
- c. The height of antenna is varied from one meter to four meters above the ground to determine the maximum value of the field strength. Both horizontal and vertical polarizations of the antenna are set to make the measurement.
- d. For each suspected emission, the EUT was arranged to its worst case and then the antenna was tuned to heights from 1 meter to 4 meters and the rotatable table was turned from 0 degrees to 360 degrees to find the maximum reading.
- e. The test-receiver system was set to quasi-peak detect function and specified bandwidth with maximum hold mode when the test frequency is below 1 GHz.
- f. The test-receiver system was set to peak and average detect function and specified bandwidth with maximum hold mode when the test frequency is above 1 GHz. If the peak reading value also meets average limit, measurement with the average detector is unnecessary.

Note:

1. For emission measurements above 1 GHz, the EUT shall be placed at a height of 1.5 m above the ground at 3 meter chamber room for test
2. The resolution bandwidth and video bandwidth of test receiver/spectrum analyzer is 120kHz for Quasi-peak detection (QP) at frequency below 1GHz.
3. The resolution bandwidth of test receiver/spectrum analyzer is 1 MHz and the video bandwidth is 3 MHz for Peak detection (PK) at frequency above 1GHz.
4. The resolution bandwidth of test receiver/spectrum analyzer is 1MHz and the video bandwidth is 3MHz for RMS Average (Duty cycle < 98%) for Average detection (AV) at frequency above 1GHz, then the measurement results was added to a correction factor ($10 \log(1/\text{duty cycle})$).
5. The resolution bandwidth of test receiver/spectrum analyzer is 1MHz and the video bandwidth is 10Hz (Duty cycle $\geq 98\%$) for Average detection (AV) at frequency above 1GHz.
6. All modes of operation were investigated and the worst-case emissions are reported.

5.1.4 Deviation from Test Standard

No deviation.

5.1.5 Test Setup

<Frequency Range below 1GHz>

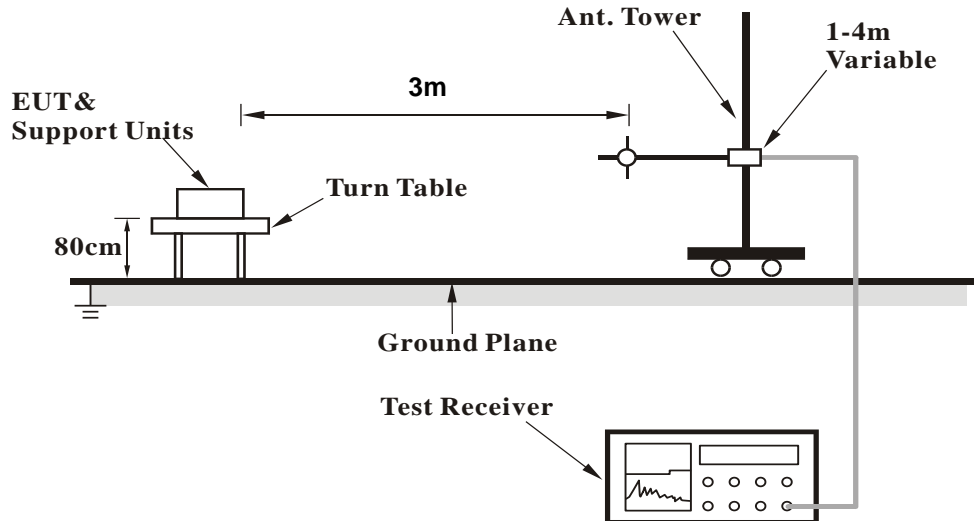

<Frequency Range above 1GHz>

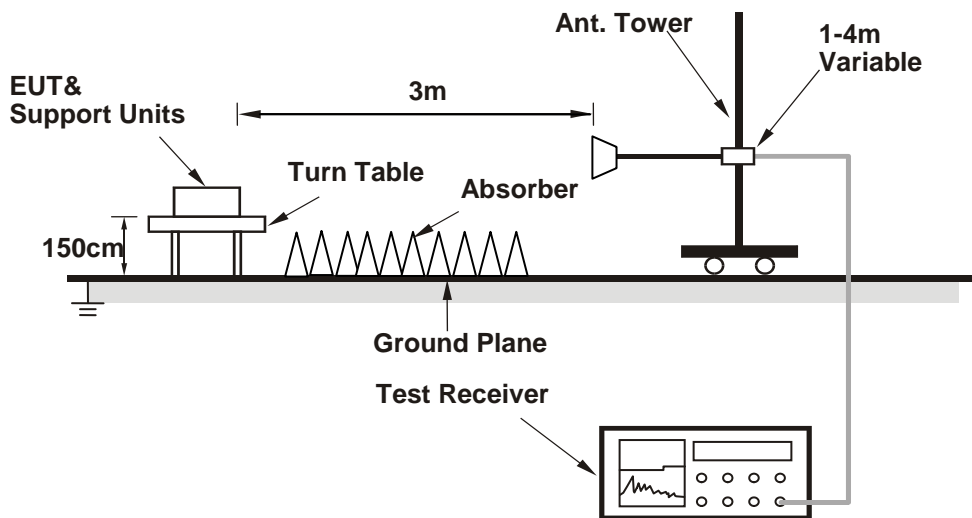

For the actual test configuration, please refer to the attached file (Test Setup Photo).

5.1.6 EUT Operating Conditions

Same as item 4.1.6.

5.1.7 Test Results
Above 1GHz Data (Subcontract Item):
CDD Mode
802.11a

CHANNEL	TX Channel 149	DETECTOR FUNCTION	Peak (PK)
FREQUENCY RANGE	1GHz ~ 40GHz		Average (AV)

ANTENNA POLARITY & TEST DISTANCE: HORIZONTAL AT 3 M								
NO.	FREQ. (MHz)	EMISSION LEVEL (dBuV/m)	LIMIT (dBuV/m)	MARGIN (dB)	ANTENNA HEIGHT (m)	TABLE ANGLE (Degree)	RAW VALUE (dBuV)	CORRECTION FACTOR (dB/m)
1	*5745.00	107.2 PK			1.04 H	37	95.57	11.63
2	*5745.00	97.7 AV			1.04 H	37	86.07	11.63
3	11490.00	56.9 PK	74.0	-17.1	1.04 H	291	39.60	17.30
4	11490.00	44.6 AV	54.0	-9.4	1.04 H	291	27.30	17.30
ANTENNA POLARITY & TEST DISTANCE: VERTICAL AT 3 M								
NO.	FREQ. (MHz)	EMISSION LEVEL (dBuV/m)	LIMIT (dBuV/m)	MARGIN (dB)	ANTENNA HEIGHT (m)	TABLE ANGLE (Degree)	RAW VALUE (dBuV)	CORRECTION FACTOR (dB/m)
1	*5745.00	123.2 PK			2.01 V	50	111.57	11.63
2	*5745.00	113.3 AV			2.01 V	50	101.67	11.63
3	11490.00	59.4 PK	74.0	-14.6	1.99 V	360	42.10	17.30
4	11490.00	46.5 AV	54.0	-7.5	1.99 V	360	29.20	17.30

REMARKS:

1. Emission Level(dBuV/m) = Raw Value(dBuV) + Correction Factor(dB/m)
2. Correction Factor(dB/m) = Antenna Factor(dB/m) + Cable Factor(dB) – Pre-Amplifier Factor(dB)
3. The other emission levels were very low against the limit.
4. Margin value = Emission Level – Limit value
5. " * ": Fundamental frequency.

CHANNEL	TX Channel 157	DETECTOR FUNCTION	Peak (PK)
FREQUENCY RANGE	1GHz ~ 40GHz		Average (AV)

ANTENNA POLARITY & TEST DISTANCE: HORIZONTAL AT 3 M

NO.	FREQ. (MHz)	EMISSION LEVEL (dBuV/m)	LIMIT (dBuV/m)	MARGIN (dB)	ANTENNA HEIGHT (m)	TABLE ANGLE (Degree)	RAW VALUE (dBuV)	CORRECTION FACTOR (dB/m)
1	*5785.00	107.0 PK			1.02 H	51	95.26	11.74
2	*5785.00	97.7 AV			1.02 H	51	85.96	11.74
3	11570.00	56.6 PK	74.0	-17.4	1.00 H	298	38.69	17.91
4	11570.00	44.6 AV	54.0	-9.4	1.00 H	298	26.69	17.91

ANTENNA POLARITY & TEST DISTANCE: VERTICAL AT 3 M

NO.	FREQ. (MHz)	EMISSION LEVEL (dBuV/m)	LIMIT (dBuV/m)	MARGIN (dB)	ANTENNA HEIGHT (m)	TABLE ANGLE (Degree)	RAW VALUE (dBuV)	CORRECTION FACTOR (dB/m)
1	*5785.00	123.6 PK			2.03 V	60	111.86	11.74
2	*5785.00	113.7 AV			2.03 V	60	101.96	11.74
3	11570.00	59.4 PK	74.0	-14.6	2.01 V	352	41.49	17.91
4	11570.00	46.4 AV	54.0	-7.6	2.01 V	352	28.49	17.91

REMARKS:

1. Emission Level(dBuV/m) = Raw Value(dBuV) + Correction Factor(dB/m)
2. Correction Factor(dB/m) = Antenna Factor(dB/m) + Cable Factor(dB) – Pre-Amplifier Factor(dB)
3. The other emission levels were very low against the limit.
4. Margin value = Emission Level – Limit value
5. " * ": Fundamental frequency.

CHANNEL	TX Channel 165	DETECTOR FUNCTION	Peak (PK)
FREQUENCY RANGE	1GHz ~ 40GHz		Average (AV)

ANTENNA POLARITY & TEST DISTANCE: HORIZONTAL AT 3 M

NO.	FREQ. (MHz)	EMISSION LEVEL (dBuV/m)	LIMIT (dBuV/m)	MARGIN (dB)	ANTENNA HEIGHT (m)	TABLE ANGLE (Degree)	RAW VALUE (dBuV)	CORRECTION FACTOR (dB/m)
1	*5825.00	107.8 PK			1.03 H	51	96.02	11.78
2	*5825.00	98.0 AV			1.03 H	51	86.22	11.78
3	11650.00	56.3 PK	74.0	-17.7	1.03 H	292	38.14	18.16
4	11650.00	44.2 AV	54.0	-9.8	1.03 H	292	26.04	18.16

ANTENNA POLARITY & TEST DISTANCE: VERTICAL AT 3 M

NO.	FREQ. (MHz)	EMISSION LEVEL (dBuV/m)	LIMIT (dBuV/m)	MARGIN (dB)	ANTENNA HEIGHT (m)	TABLE ANGLE (Degree)	RAW VALUE (dBuV)	CORRECTION FACTOR (dB/m)
1	*5825.00	123.2 PK			2.03 V	61	111.42	11.78
2	*5825.00	113.5 AV			2.03 V	61	101.72	11.78
3	11650.00	58.8 PK	74.0	-15.2	1.99 V	356	40.64	18.16
4	11650.00	46.1 AV	54.0	-7.9	1.99 V	356	27.94	18.16

REMARKS:

1. Emission Level(dBuV/m) = Raw Value(dBuV) + Correction Factor(dB/m)
2. Correction Factor(dB/m) = Antenna Factor(dB/m) + Cable Factor(dB) – Pre-Amplifier Factor(dB)
3. The other emission levels were very low against the limit.
4. Margin value = Emission Level – Limit value
5. " * ": Fundamental frequency.

Beamforming MODE

802.11ac (VHT20)

CHANNEL	TX Channel 149	DETECTOR FUNCTION	Peak (PK)
FREQUENCY RANGE	1GHz ~ 40GHz		Average (AV)

ANTENNA POLARITY & TEST DISTANCE: HORIZONTAL AT 3 M

NO.	FREQ. (MHz)	EMISSION LEVEL (dBuV/m)	LIMIT (dBuV/m)	MARGIN (dB)	ANTENNA HEIGHT (m)	TABLE ANGLE (Degree)	RAW VALUE (dBuV)	CORRECTION FACTOR (dB/m)
1	*5745.00	107.5 PK			1.05 H	40	95.87	11.63
2	*5745.00	97.9 AV			1.05 H	40	86.27	11.63
3	11490.00	56.2 PK	74.0	-17.8	1.02 H	296	38.90	17.30
4	11490.00	44.0 AV	54.0	-10.0	1.02 H	296	26.70	17.30

ANTENNA POLARITY & TEST DISTANCE: VERTICAL AT 3 M

NO.	FREQ. (MHz)	EMISSION LEVEL (dBuV/m)	LIMIT (dBuV/m)	MARGIN (dB)	ANTENNA HEIGHT (m)	TABLE ANGLE (Degree)	RAW VALUE (dBuV)	CORRECTION FACTOR (dB/m)
1	*5745.00	122.6 PK			1.99 V	36	110.97	11.63
2	*5745.00	112.9 AV			1.99 V	36	101.27	11.63
3	11490.00	59.5 PK	74.0	-14.5	1.99 V	360	42.20	17.30
4	11490.00	46.3 AV	54.0	-7.7	1.99 V	360	29.00	17.30

REMARKS:

1. Emission Level(dBuV/m) = Raw Value(dBuV) + Correction Factor(dB/m)
2. Correction Factor(dB/m) = Antenna Factor(dB/m) + Cable Factor(dB) – Pre-Amplifier Factor(dB)
3. The other emission levels were very low against the limit.
4. Margin value = Emission Level – Limit value
5. " * ": Fundamental frequency.



CHANNEL	TX Channel 157	DETECTOR FUNCTION	Peak (PK)
FREQUENCY RANGE	1GHz ~ 40GHz		Average (AV)

ANTENNA POLARITY & TEST DISTANCE: HORIZONTAL AT 3 M

NO.	FREQ. (MHz)	EMISSION LEVEL (dBuV/m)	LIMIT (dBuV/m)	MARGIN (dB)	ANTENNA HEIGHT (m)	TABLE ANGLE (Degree)	RAW VALUE (dBuV)	CORRECTION FACTOR (dB/m)
1	*5785.00	108.2 PK			1.00 H	41	96.46	11.74
2	*5785.00	98.1 AV			1.00 H	41	86.36	11.74
3	11570.00	57.0 PK	74.0	-17.0	1.05 H	288	39.09	17.91
4	11570.00	44.7 AV	54.0	-9.3	1.05 H	288	26.79	17.91

ANTENNA POLARITY & TEST DISTANCE: VERTICAL AT 3 M

NO.	FREQ. (MHz)	EMISSION LEVEL (dBuV/m)	LIMIT (dBuV/m)	MARGIN (dB)	ANTENNA HEIGHT (m)	TABLE ANGLE (Degree)	RAW VALUE (dBuV)	CORRECTION FACTOR (dB/m)
1	*5785.00	122.9 PK			2.00 V	50	111.16	11.74
2	*5785.00	113.2 AV			2.00 V	50	101.46	11.74
3	11570.00	59.3 PK	74.0	-14.7	1.96 V	350	41.39	17.91
4	11570.00	46.1 AV	54.0	-7.9	1.96 V	350	28.19	17.91

REMARKS:

1. Emission Level(dBuV/m) = Raw Value(dBuV) + Correction Factor(dB/m)
2. Correction Factor(dB/m) = Antenna Factor(dB/m) + Cable Factor(dB) – Pre-Amplifier Factor(dB)
3. The other emission levels were very low against the limit.
4. Margin value = Emission Level – Limit value
5. " * ": Fundamental frequency.



CHANNEL	TX Channel 165	DETECTOR FUNCTION	Peak (PK)
FREQUENCY RANGE	1GHz ~ 40GHz		Average (AV)

ANTENNA POLARITY & TEST DISTANCE: HORIZONTAL AT 3 M

NO.	FREQ. (MHz)	EMISSION LEVEL (dBuV/m)	LIMIT (dBuV/m)	MARGIN (dB)	ANTENNA HEIGHT (m)	TABLE ANGLE (Degree)	RAW VALUE (dBuV)	CORRECTION FACTOR (dB/m)
1	*5825.00	107.4 PK			1.04 H	51	95.62	11.78
2	*5825.00	97.8 AV			1.04 H	51	86.02	11.78
3	11650.00	56.1 PK	74.0	-17.9	1.05 H	298	37.94	18.16
4	11650.00	43.9 AV	54.0	-10.1	1.05 H	298	25.74	18.16

ANTENNA POLARITY & TEST DISTANCE: VERTICAL AT 3 M

NO.	FREQ. (MHz)	EMISSION LEVEL (dBuV/m)	LIMIT (dBuV/m)	MARGIN (dB)	ANTENNA HEIGHT (m)	TABLE ANGLE (Degree)	RAW VALUE (dBuV)	CORRECTION FACTOR (dB/m)
1	*5825.00	123.6 PK			1.95 V	36	111.82	11.78
2	*5825.00	113.5 AV			1.95 V	36	101.72	11.78
3	11650.00	59.8 PK	74.0	-14.2	1.97 V	360	41.64	18.16
4	11650.00	46.7 AV	54.0	-7.3	1.97 V	360	28.54	18.16

REMARKS:

1. Emission Level(dBuV/m) = Raw Value(dBuV) + Correction Factor(dB/m)
2. Correction Factor(dB/m) = Antenna Factor(dB/m) + Cable Factor(dB) – Pre-Amplifier Factor(dB)
3. The other emission levels were very low against the limit.
4. Margin value = Emission Level – Limit value
5. " * ": Fundamental frequency.

802.11ac (VHT40)

CHANNEL	TX Channel 151	DETECTOR FUNCTION	Peak (PK)
FREQUENCY RANGE	1GHz ~ 40GHz		Average (AV)

ANTENNA POLARITY & TEST DISTANCE: HORIZONTAL AT 3 M

NO.	FREQ. (MHz)	EMISSION LEVEL (dBuV/m)	LIMIT (dBuV/m)	MARGIN (dB)	ANTENNA HEIGHT (m)	TABLE ANGLE (Degree)	RAW VALUE (dBuV)	CORRECTION FACTOR (dB/m)
1	*5755.00	103.6 PK			1.01 H	37	91.96	11.64
2	*5755.00	93.4 AV			1.01 H	37	81.76	11.64
3	11510.00	55.8 PK	74.0	-18.2	1.09 H	306	38.50	17.30
4	11510.00	43.8 AV	54.0	-10.2	1.09 H	306	26.50	17.30

ANTENNA POLARITY & TEST DISTANCE: VERTICAL AT 3 M

NO.	FREQ. (MHz)	EMISSION LEVEL (dBuV/m)	LIMIT (dBuV/m)	MARGIN (dB)	ANTENNA HEIGHT (m)	TABLE ANGLE (Degree)	RAW VALUE (dBuV)	CORRECTION FACTOR (dB/m)
1	*5755.00	118.9 PK			1.90 V	29	107.26	11.64
2	*5755.00	109.1 AV			1.90 V	29	97.46	11.64
3	11510.00	56.6 PK	74.0	-17.4	1.96 V	36	39.30	17.30
4	11510.00	44.5 AV	54.0	-9.5	1.96 V	36	27.20	17.30

REMARKS:

1. Emission Level(dBuV/m) = Raw Value(dBuV) + Correction Factor(dB/m)
2. Correction Factor(dB/m) = Antenna Factor(dB/m) + Cable Factor(dB) – Pre-Amplifier Factor(dB)
3. The other emission levels were very low against the limit.
4. Margin value = Emission Level – Limit value
5. " * ": Fundamental frequency.

CHANNEL	TX Channel 159	DETECTOR FUNCTION	Peak (PK)
FREQUENCY RANGE	1GHz ~ 40GHz		Average (AV)

ANTENNA POLARITY & TEST DISTANCE: HORIZONTAL AT 3 M

NO.	FREQ. (MHz)	EMISSION LEVEL (dBuV/m)	LIMIT (dBuV/m)	MARGIN (dB)	ANTENNA HEIGHT (m)	TABLE ANGLE (Degree)	RAW VALUE (dBuV)	CORRECTION FACTOR (dB/m)
1	*5795.00	113.6 PK			1.03 H	43	101.82	11.78
2	*5795.00	93.7 AV			1.03 H	43	81.92	11.78
3	11590.00	56.3 PK	74.0	-17.7	1.08 H	304	38.19	18.11
4	11590.00	44.2 AV	54.0	-9.8	1.08 H	304	26.09	18.11

ANTENNA POLARITY & TEST DISTANCE: VERTICAL AT 3 M

NO.	FREQ. (MHz)	EMISSION LEVEL (dBuV/m)	LIMIT (dBuV/m)	MARGIN (dB)	ANTENNA HEIGHT (m)	TABLE ANGLE (Degree)	RAW VALUE (dBuV)	CORRECTION FACTOR (dB/m)
1	*5795.00	119.0 PK			1.90 V	34	107.22	11.78
2	*5795.00	109.0 AV			1.90 V	34	97.22	11.78
3	11590.00	56.7 PK	74.0	-17.3	1.96 V	23	38.59	18.11
4	11590.00	44.3 AV	54.0	-9.7	1.96 V	23	26.19	18.11

REMARKS:

1. Emission Level(dBuV/m) = Raw Value(dBuV) + Correction Factor(dB/m)
2. Correction Factor(dB/m) = Antenna Factor(dB/m) + Cable Factor(dB) – Pre-Amplifier Factor(dB)
3. The other emission levels were very low against the limit.
4. Margin value = Emission Level – Limit value
5. " * ": Fundamental frequency.

802.11ac (VHT80)

CHANNEL	TX Channel 155	DETECTOR FUNCTION	Peak (PK)
FREQUENCY RANGE	1GHz ~ 40GHz		Average (AV)

ANTENNA POLARITY & TEST DISTANCE: HORIZONTAL AT 3 M

NO.	FREQ. (MHz)	EMISSION LEVEL (dBuV/m)	LIMIT (dBuV/m)	MARGIN (dB)	ANTENNA HEIGHT (m)	TABLE ANGLE (Degree)	RAW VALUE (dBuV)	CORRECTION FACTOR (dB/m)
1	*5775.00	99.6 PK			1.01 H	45	87.88	11.72
2	*5775.00	89.2 AV			1.01 H	45	77.48	11.72
3	11550.00	55.8 PK	74.0	-18.2	1.02 H	300	38.09	17.71
4	11550.00	44.0 AV	54.0	-10.0	1.02 H	300	26.29	17.71

ANTENNA POLARITY & TEST DISTANCE: VERTICAL AT 3 M

NO.	FREQ. (MHz)	EMISSION LEVEL (dBuV/m)	LIMIT (dBuV/m)	MARGIN (dB)	ANTENNA HEIGHT (m)	TABLE ANGLE (Degree)	RAW VALUE (dBuV)	CORRECTION FACTOR (dB/m)
1	*5775.00	114.5 PK			1.91 V	6	102.78	11.72
2	*5775.00	104.4 AV			1.91 V	6	92.68	11.72
3	11550.00	56.3 PK	74.0	-17.7	2.01 V	47	38.59	17.71
4	11550.00	43.9 AV	54.0	-10.1	2.01 V	47	26.19	17.71

REMARKS:

1. Emission Level(dBuV/m) = Raw Value(dBuV) + Correction Factor(dB/m)
2. Correction Factor(dB/m) = Antenna Factor(dB/m) + Cable Factor(dB) – Pre-Amplifier Factor(dB)
3. The other emission levels were very low against the limit.
4. Margin value = Emission Level – Limit value
5. " * ": Fundamental frequency.



Below 1GHz Data:
Beamforming MODE
802.11ac (VHT20)

CHANNEL	TX Channel 149	DETECTOR FUNCTION	Quasi-Peak (QP)
FREQUENCY RANGE	Below 1GHz		

ANTENNA POLARITY & TEST DISTANCE: HORIZONTAL AT 3 M

NO.	FREQ. (MHz)	EMISSION LEVEL (dBuV/m)	LIMIT (dBuV/m)	MARGIN (dB)	ANTENNA HEIGHT (m)	TABLE ANGLE (Degree)	RAW VALUE (dBuV)	CORRECTION FACTOR (dB/m)
1	219.72	41.7 QP	46.0	-4.3	1.49 H	121	57.73	-16.05
2	318.90	41.9 QP	46.0	-4.1	1.10 H	132	53.03	-11.12
3	331.62	42.9 QP	46.0	-3.1	1.10 H	132	53.69	-10.78
4	379.80	41.6 QP	46.0	-4.4	1.20 H	100	51.71	-10.11
5	392.10	41.2 QP	46.0	-4.8	1.10 H	300	51.02	-9.81
6	750.03	41.9 QP	46.0	-4.1	1.10 H	100	43.90	-1.99

ANTENNA POLARITY & TEST DISTANCE: VERTICAL AT 3 M

NO.	FREQ. (MHz)	EMISSION LEVEL (dBuV/m)	LIMIT (dBuV/m)	MARGIN (dB)	ANTENNA HEIGHT (m)	TABLE ANGLE (Degree)	RAW VALUE (dBuV)	CORRECTION FACTOR (dB/m)
1	51.90	36.4 QP	40.0	-3.6	1.10 V	315	49.75	-13.35
2	62.20	35.0 QP	40.0	-5.0	1.10 V	183	49.44	-14.42
3	340.13	42.9 QP	46.0	-3.1	1.10 V	310	53.69	-10.77
4	368.12	41.9 QP	46.0	-4.1	1.10 V	115	52.20	-10.28
5	410.05	41.8 QP	46.0	-4.2	1.00 V	359	51.11	-9.34
6	749.90	41.3 QP	46.0	-4.7	1.12 V	310	43.31	-1.99

REMARKS:

1. Emission Level(dBuV/m) = Raw Value(dBuV) + Correction Factor(dB/m)
2. Correction Factor(dB/m) = Antenna Factor(dB/m) + Cable Factor(dB) – Pre-Amplifier Factor(dB)
3. The other emission levels were very low against the limit.
4. Margin value = Emission Level – Limit value

5.2 Conducted Emission Measurement

5.2.1 Limits of Conducted Emission Measurement

Frequency (MHz)	Conducted Limit (dBuV)	
	Quasi-peak	Average
0.15 - 0.5	66 - 56	56 - 46
0.50 - 5.0	56	46
5.0 - 30.0	60	50

Note: 1. The lower limit shall apply at the transition frequencies.

2. The limit decreases in line with the logarithm of the frequency in the range of 0.15 to 0.50MHz.

5.2.2 Test Instruments

DESCRIPTION & MANUFACTURER	MODEL NO.	SERIAL NO.	CALIBRATED DATE	CALIBRATED UNTIL
Test Receiver ROHDE & SCHWARZ	ESCS 30	100375	May 06, 2015	May 05, 2016
Line-Impedance Stabilization Network (for EUT) SCHWARZBECK	NSLK-8127	8127-522	Sep. 15, 2014	Sep. 14, 2015
Line-Impedance Stabilization Network (for Peripheral) ROHDE & SCHWARZ	ENV216	100071	Nov. 10, 2014	Nov. 09, 2015
RF Cable (JYEBAO)	5D-FB	COCCAB-001	Mar. 09, 2015	Mar. 08, 2016
50 ohms Terminator	N/A	EMC-03	Sep. 22, 2014	Sep. 21, 2015
50 ohms Terminator	N/A	EMC-02	Sep. 30, 2014	Sep. 29, 2015
Software ADT	BV ADT_Cond_V7.3.7.3	NA	NA	NA

Note:

1. The calibration interval of the above test instruments is 12 months and the calibrations are traceable to NML/ROC and NIST/USA.
2. The test was performed in Shielded Room No. C.
3. The VCCI Con C Registration No. is C-3611.
4. Tested Date: May 07, 2015

5.2.3 Test Procedures

- a. The EUT was placed 0.4 meters from the conducting wall of the shielded room with EUT being connected to the power mains through a line impedance stabilization network (LISN). Other support units were connected to the power mains through another LISN. The two LISNs provide 50 ohm/ 50uH of coupling impedance for the measuring instrument.
- b. Both lines of the power mains connected to the EUT were checked for maximum conducted interference.
- c. The frequency range from 150kHz to 30MHz was searched. Emission levels under (Limit - 20dB) was not recorded.

NOTE: The resolution bandwidth and video bandwidth of test receiver is 9kHz for quasi-peak detection (QP) and average detection (AV) at frequency 0.15MHz-30MHz.

5.2.4 Deviation from Test Standard

No deviation.

5.2.5 Test Setup

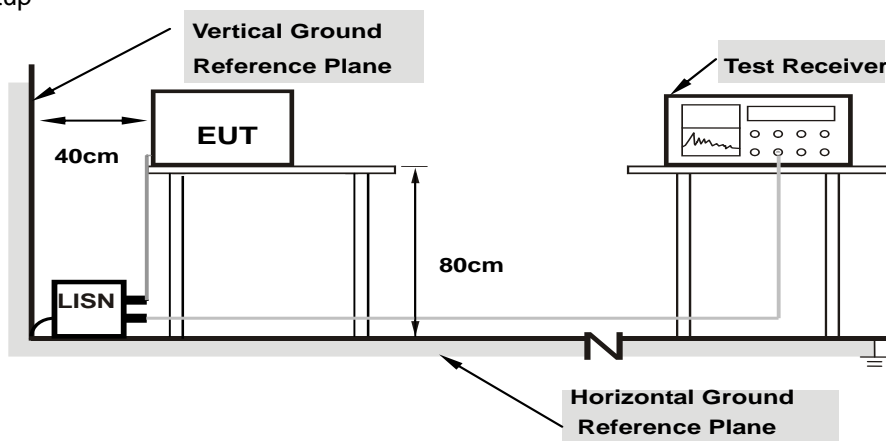

Note: 1.Support units were connected to second LISN.

For the actual test configuration, please refer to the attached file (Test Setup Photo).

5.2.6 EUT Operating Conditions

Same as 4.1.6.

5.2.7 Test Results

Phase	Line (L)	Detector Function	Quasi-Peak (QP) / Average (AV)
-------	----------	-------------------	--------------------------------

No	Freq. [MHz]	Corr. Factor	Reading Value [dB (uV)]		Emission Level [dB (uV)]		Limit [dB (uV)]		Margin (dB)	
		(dB)	Q.P.	AV.	Q.P.	AV.	Q.P.	AV.	Q.P.	AV.
	1	0.15000	0.08	47.51	24.27	47.59	24.35	66.00	56.00	-18.41
2	0.27891	0.09	41.83	35.52	41.92	35.61	60.85	50.85	-18.92	-15.23
3	0.96250	0.13	38.10	28.23	38.23	28.36	56.00	46.00	-17.77	-17.64
4	3.69141	0.21	39.97	31.39	40.18	31.60	56.00	46.00	-15.82	-14.40
5	9.20703	0.42	44.91	39.52	45.33	39.94	60.00	50.00	-14.67	-10.06
6	11.78125	0.49	44.66	38.03	45.15	38.52	60.00	50.00	-14.85	-11.48

REMARKS:

1. Q.P. and AV. are abbreviations of quasi-peak and average individually.
2. The emission levels of other frequencies were very low against the limit.
3. Margin value = Emission level - Limit value
4. Correction factor = Insertion loss + Cable loss
5. Emission Level = Correction Factor + Reading Value.

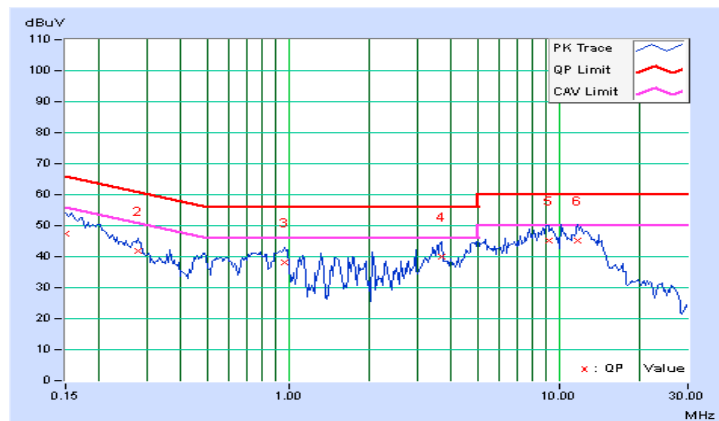

Phase	Neutral (N)	Detector Function	Quasi-Peak (QP) / Average (AV)
-------	-------------	-------------------	--------------------------------

No	Freq. [MHz]	Corr.	Reading Value		Emission Level		Limit		Margin	
		Factor	[dB (uV)]		[dB (uV)]		[dB (uV)]		(dB)	
	(dB)	Q.P.	AV.	Q.P.	AV.	Q.P.	AV.	Q.P.	AV.	
1	0.15000	0.08	47.63	25.84	47.71	25.92	66.00	56.00	-18.29	-30.08
2	0.29050	0.09	40.03	31.83	40.12	31.92	60.51	50.51	-20.39	-18.59
3	1.41406	0.15	35.14	26.41	35.29	26.56	56.00	46.00	-20.71	-19.44
4	3.53906	0.22	39.20	31.61	39.42	31.83	56.00	46.00	-16.58	-14.17
5	9.91797	0.46	43.27	37.94	43.73	38.40	60.00	50.00	-16.27	-11.60
6	12.26563	0.52	43.44	38.15	43.96	38.67	60.00	50.00	-16.04	-11.33

REMARKS:

1. Q.P. and AV. are abbreviations of quasi-peak and average individually.
2. The emission levels of other frequencies were very low against the limit.
3. Margin value = Emission level - Limit value
4. Correction factor = Insertion loss + Cable loss
5. Emission Level = Correction Factor + Reading Value.

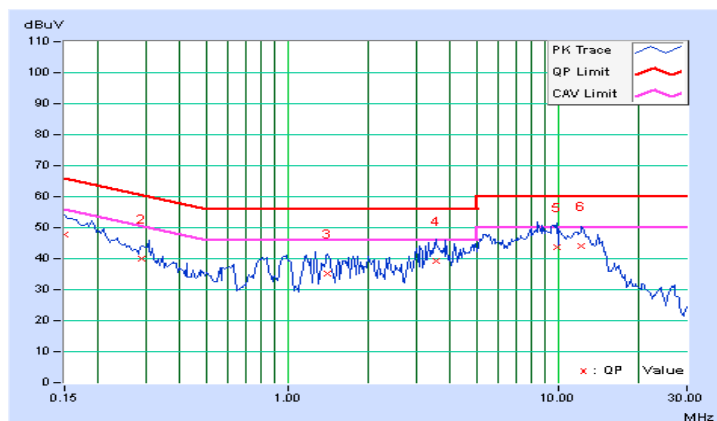

5.3 6dB Bandwidth Measurement

5.3.1 Limits of 6dB Bandwidth Measurement

The minimum of 6dB Bandwidth Measurement is 0.5 MHz.

5.3.2 Test Setup

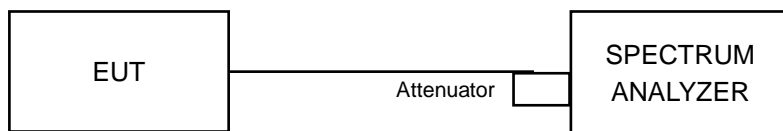

5.3.3 Test Instruments

DESCRIPTION & MANUFACTURER	MODEL NO.	SERIAL NO.	CALIBRATED DATE	CALIBRATED UNTIL
SPECTRUM ANALYZER R&S	FSV 40	100964	July 05, 2014	July 04, 2015

- NOTE:**
1. The test was performed in Oven room B.
 2. The calibration interval of the above test instruments is 12 months and the calibrations are traceable to NML/ROC and NIST/USA.
 3. Tested Date: May 14, 2015

5.3.4 Test Procedure

- a. Set resolution bandwidth (RBW) = 100kHz
- b. Set the video bandwidth (VBW) $\geq 3 \times$ RBW, Detector = Peak.
- c. Trace mode = max hold.
- d. Sweep = auto couple.
- e. Measure the maximum width of the emission that is constrained by the frequencies associated with the two amplitude points (upper and lower) that are attenuated by 6 dB relative to the maximum level measured in the fundamental emission

5.3.5 Deviation from Test Standard

No deviation.

5.3.6 EUT Operating Conditions

The software provided by client to enable the EUT under transmission condition continuously at lowest, middle and highest channel frequencies individually.

5.3.7 Test Result

CDD MODE

Channel	Frequency (MHz)	6dB Bandwidth (MHz)				Minimum Limit (MHz)	Pass / Fail
		Chain 0	Chain 1	Chain 2	Chain 3		
802.11a							
149	5745	16.45	16.46	16.42	16.44	0.5	PASS
157	5785	16.43	16.44	16.44	16.44	0.5	PASS
165	5825	16.44	16.48	16.43	16.43	0.5	PASS

Beamforming MODE

Channel	Frequency (MHz)	6dB Bandwidth (MHz)				Minimum Limit (MHz)	Pass / Fail
		Chain 0	Chain 1	Chain 2	Chain 3		
802.11ac (VHT20)							
149	5745	17.70	17.71	17.68	17.70	0.5	PASS
157	5785	17.67	17.72	17.66	17.67	0.5	PASS
165	5825	17.67	17.70	17.68	17.69	0.5	PASS
802.11ac (VHT40)							
151	5755	36.48	36.52	36.47	36.52	0.5	PASS
159	5795	36.48	36.51	36.47	36.49	0.5	PASS
802.11ac (VHT80)							
155	5775	76.52	76.58	76.50	76.60	0.5	PASS

Spectrum Plot of Worst Value

802.11a – Chain 2: CH 149

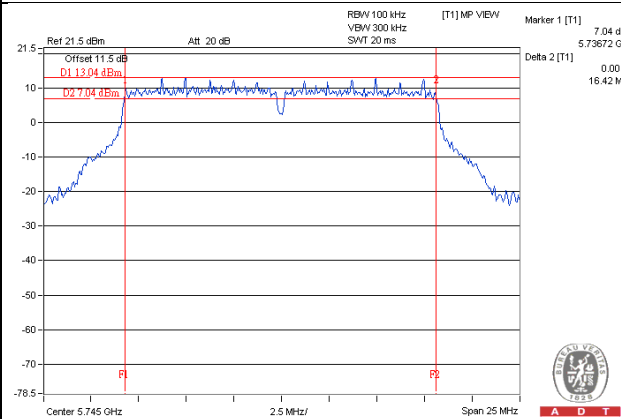

802.11ac (VHT20) – Chain 2: CH 157

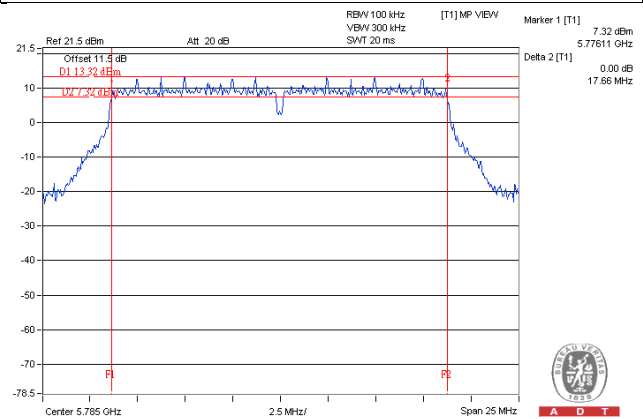

802.11ac (VHT40) – Chain 2: CH 151

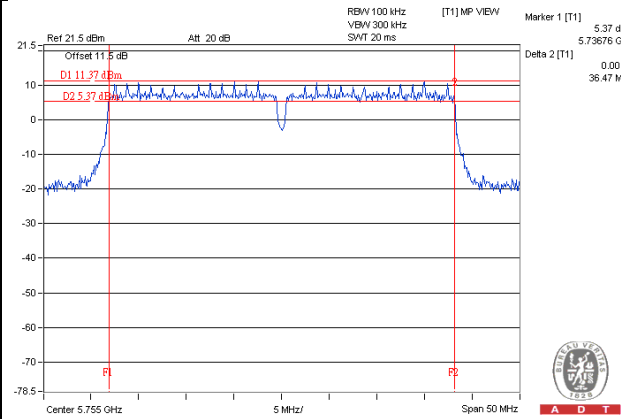

802.11ac (VHT80) – Chain 2: CH 155

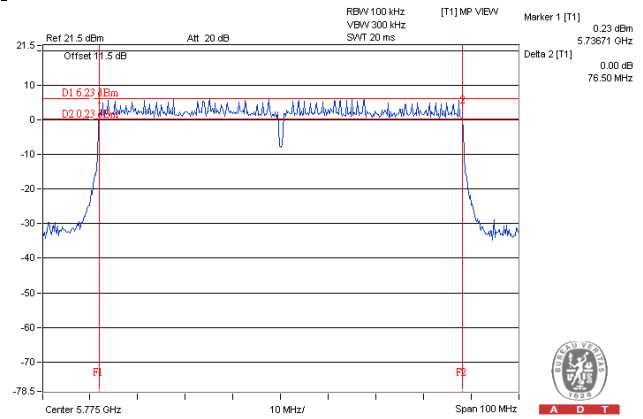

5.4 Conducted Output Power Measurement

5.4.1 Limits of Conducted Output Power Measurement

For systems using digital modulation in the 2400–2483.5 MHz bands: 1 Watt (30dBm)

Per KDB 662911 D01 Multiple Transmitter Output Method of conducted output power measurement on IEEE 802.11 devices,

Array Gain = 0 dB (i.e., no array gain) for NANT ≤ 4;

Array Gain = 0 dB (i.e., no array gain) for channel widths ≥ 40 MHz for any NANT;

Array Gain = 5 log(NANT/NSS) dB or 3 dB, whichever is less for 20-MHz channel widths with NANT ≥ 5.

For power measurements on all other devices: Array Gain = 10 log(NANT/NSS) dB.

5.4.2 Test Setup

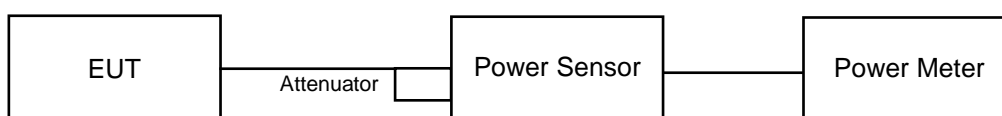

5.4.3 Test Instruments

DESCRIPTION & MANUFACTURER	MODEL NO.	SERIAL NO.	CALIBRATED DATE	CALIBRATED UNTIL
Power Meter Anritsu	ML2495A	0824006	May 22, 2014	May 21, 2015
Power Sensor Anritsu	MA2411B	0738172	May 22, 2014	May 21, 2015

- NOTE:**
1. The test was performed in Oven room B.
 2. The calibration interval of the above test instruments is 12 months and the calibrations are traceable to NML/ROC and NIST/USA.
 3. Tested Date: May 14, 2015

5.4.4 Test Procedures

A average power sensor was used on the output port of the EUT. A power meter was used to read the response of the average power sensor. Record the power level.

5.4.5 Deviation from Test Standard

No deviation.

5.4.6 EUT Operating Conditions

Same as Item 4.3.6.

5.4.7 Test Results

CDD MODE

Channel	Frequency (MHz)	Average Power (dBm)				Total Power (mW)	Total Power (dBm)	Limit (dBm)	Pass / Fail
		Chain 0	Chain 1	Chain 2	Chain 3				
802.11a									
149	5745	23.75	22.08	25.15	23.40	944.69	29.75	30	Pass
157	5785	23.34	23.92	23.80	23.55	928.725	29.68	30	Pass
165	5825	23.93	23.56	23.58	23.66	934.466	29.71	30	Pass

Beamforming MODE

Channel	Frequency (MHz)	Average Power (dBm)				Total Power (mW)	Total Power (dBm)	Limit (dBm)	Pass / Fail
		Chain 0	Chain 1	Chain 2	Chain 3				
802.11ac (VHT20)									
149	5745	23.34	23.62	24.28	23.00	913.361	29.61	29.77	Pass
157	5785	23.56	23.80	23.51	23.56	918.243	29.63	29.77	Pass
165	5825	23.41	23.81	23.66	23.89	936.896	29.72	29.77	Pass
802.11ac (VHT40)									
151	5755	23.39	23.52	23.71	23.19	886.59	29.48	29.77	Pass
159	5795	23.54	23.82	23.75	23.68	937.418	29.72	29.77	Pass
802.11ac (VHT80)									
155	5775	22.20	22.23	22.02	22.21	658.63	28.19	29.77	Pass

NOTE: Directional gain = $0.21\text{dBi} + 10\log(4) = 6.23\text{dBi} > 6\text{dBi}$, so the power limit shall be reduced to $30 - (6.23 - 6) = 29.77\text{dBm}$.

5.5 Power Spectral Density Measurement

5.5.1 Limits of Power Spectral Density Measurement

The Maximum of Power Spectral Density Measurement is 8dBm.

5.5.2 Test Setup

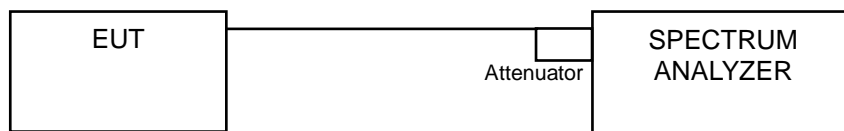

5.5.3 Test Instruments

DESCRIPTION & MANUFACTURER	MODEL NO.	SERIAL NO.	CALIBRATED DATE	CALIBRATED UNTIL
SPECTRUM ANALYZER R&S	FSV 40	100964	July 05, 2014	July 04, 2015

- NOTE:**
1. The test was performed in Oven room B.
 2. The calibration interval of the above test instruments is 12 months and the calibrations are traceable to NML/ROC and NIST/USA.
 3. Tested Date: May 14, 2015

5.5.4 Test Procedure

For 802.11a & 802.11ac (VHT20)

- a) Set instrument center frequency to DTS channel center frequency.
- b) Set span to at least 1.5 times the OBW.
- c) Set RBW to: $3 \text{ kHz} \leq \text{RBW} \leq 100 \text{ kHz}$.
- d) Set VBW $\geq 3 \times \text{RBW}$.
- e) Detector = power averaging (RMS) or sample detector (when RMS not available).
- f) Ensure that the number of measurement points in the sweep $\geq 2 \times \text{span}/\text{RBW}$.
- g) Sweep time = auto couple.
- h) Employ trace averaging (RMS) mode over a minimum of 100 traces.
- i) Use the peak marker function to determine the maximum amplitude level.

For 802.11ac (VHT40) & 802.11ac (VHT80)

- a) Measure the duty cycle (x).
- b) Set instrument center frequency to DTS channel center frequency.
- c) Set span to at least 1.5 times the OBW.
- d) Set RBW to: $3 \text{ kHz} \leq \text{RBW} \leq 100 \text{ kHz}$.
- e) Set VBW $\geq 3 \times \text{RBW}$.
- f) Detector = power averaging (RMS) or sample detector (when RMS not available).
- g) Ensure that the number of measurement points in the sweep $\geq 2 \times \text{span}/\text{RBW}$.
- h) Sweep time = auto couple.
- i) Do not use sweep triggering. Allow sweep to "free run".
- j) Employ trace averaging (RMS) mode over a minimum of 100 traces.
- k) Use the peak marker function to determine the maximum amplitude level.
- l) Add $10 \log(1/x)$, where x is the duty cycle measured in step (a), to the measured PSD to compute the average PSD during the actual transmission time.

5.5.5 Deviation from Test Standard

No deviation.

5.5.6 EUT Operating Condition

Same as Item 4.3.6

5.5.7 Test Results
CDD Mode

TX chain	Channel	Freq. (MHz)	PSD (dBm)	10 log (N=4) dB	Total PSD (dBm)	Limit (dBm)	Pass /Fail
802.11a							
0	149	5745	-6.00	6.02	0.02	7.77	Pass
	157	5785	-5.35	6.02	0.67	7.77	Pass
	165	5825	-5.89	6.02	0.13	7.77	Pass
1	149	5745	-6.84	6.02	-0.82	7.77	Pass
	157	5785	-7.47	6.02	-1.45	7.77	Pass
	165	5825	-7.44	6.02	-1.42	7.77	Pass
2	149	5745	-4.96	6.02	1.06	7.77	Pass
	157	5785	-4.78	6.02	1.24	7.77	Pass
	165	5825	-4.53	6.02	1.49	7.77	Pass
3	149	5745	-6.46	6.02	-0.44	7.77	Pass
	157	5785	-6.67	6.02	-0.65	7.77	Pass
	165	5825	-6.76	6.02	-0.74	7.77	Pass

Note: 1. Method a) of power density measurement of KDB 662911 is using for calculating total power density. Total power density is summing entire spectra across corresponding frequency bins on the various outputs by computer.

2. Directional gain = $0.21\text{dBi} + 10\log(4) = 6.23\text{dBi} > 6\text{dBi}$, so the power density limit shall be reduced to $8-(6.02-6) = 7.77\text{dBm}$.

Beamforming Mode

TX chain	Channel	Freq. (MHz)	PSD (dBm)	10 log (N=4) dB	Total PSD (dBm)	Limit (dBm)	Pass /Fail
802.11ac (VHT20)							
0	149	5745	-7.21	6.02	-1.19	7.77	Pass
	157	5785	-7.49	6.02	-1.47	7.77	Pass
	165	5825	-7.20	6.02	-1.18	7.77	Pass
1	149	5745	-8.53	6.02	-2.51	7.77	Pass
	157	5785	-8.43	6.02	-2.41	7.77	Pass
	165	5825	-8.66	6.02	-2.64	7.77	Pass
2	149	5745	-5.87	6.02	0.15	7.77	Pass
	157	5785	-5.81	6.02	0.21	7.77	Pass
	165	5825	-6.11	6.02	-0.09	7.77	Pass
3	149	5745	-7.39	6.02	-1.37	7.77	Pass
	157	5785	-7.76	6.02	-1.74	7.77	Pass
	165	5825	-7.78	6.02	-1.76	7.77	Pass

Note: 1. Method a) of power density measurement of KDB 662911 is using for calculating total power density. Total power density is summing entire spectra across corresponding frequency bins on the various outputs by computer.

2. Directional gain = $0.21\text{dBi} + 10\log(4) = 6.23\text{dBi} > 6\text{dBi}$, so the power density limit shall be reduced to $8 - (6.23 - 6) = 7.77\text{dBm}$.

TX Chain	Channel	Freq. (MHz)	PSD w/o duty factor (dBm)	10 log (N=4) dB	Duty Factor (dB)	Total PSD with Duty Factor (dBm)	Limit (dBm)	Pass /Fail
802.11ac (VHT40)								
0	151	5755	-8.34	6.02	0.10	-2.22	7.77	Pass
	159	5795	-8.76	6.02	0.10	-2.64	7.77	Pass
1	151	5755	-9.76	6.02	0.10	-3.64	7.77	Pass
	159	5795	-9.76	6.02	0.10	-3.64	7.77	Pass
2	151	5755	-7.37	6.02	0.10	-1.25	7.77	Pass
	159	5795	-7.61	6.02	0.10	-1.49	7.77	Pass
3	151	5755	-9.17	6.02	0.10	-3.05	7.77	Pass
	159	5795	-9.17	6.02	0.10	-3.05	7.77	Pass
802.11ac (VHT80)								
0	155	5775	-12.58	6.02	0.18	-6.38	7.77	Pass
1	155	5775	-14.65	6.02	0.18	-8.45	7.77	Pass
2	155	5775	-11.72	6.02	0.18	-5.52	7.77	Pass
3	155	5775	-13.35	6.02	0.18	-7.15	7.77	Pass

Note: 1. Method a) of power density measurement of KDB 662911 is using for calculating total power density. Total power density is summing entire spectra across corresponding frequency bins on the various outputs by computer.

2. Directional gain = $0.21\text{dBi} + 10\log(4) = 6.23\text{dBi} > 6\text{dBi}$, so the power density limit shall be reduced to $8 - (6.23 - 6) = 7.77\text{dBm}$.

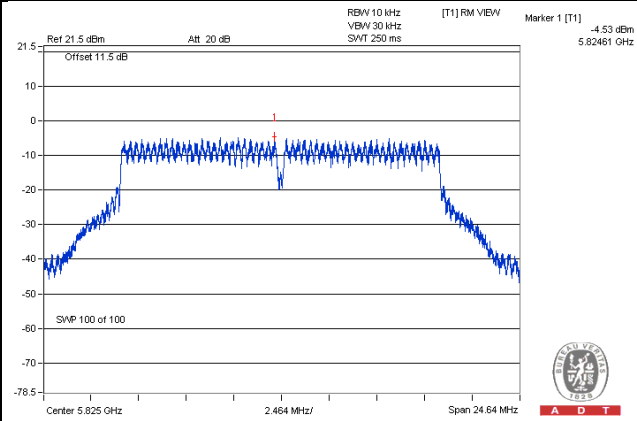
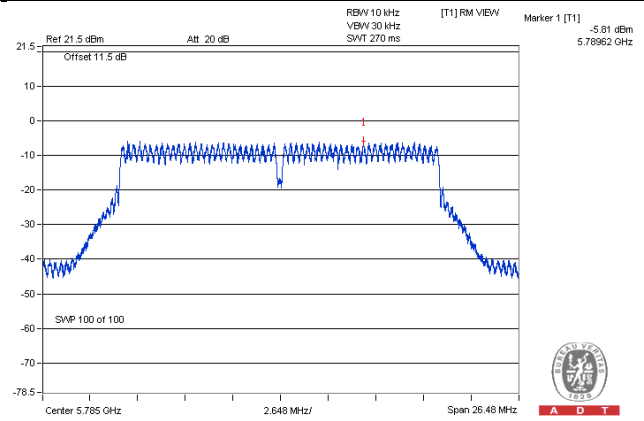
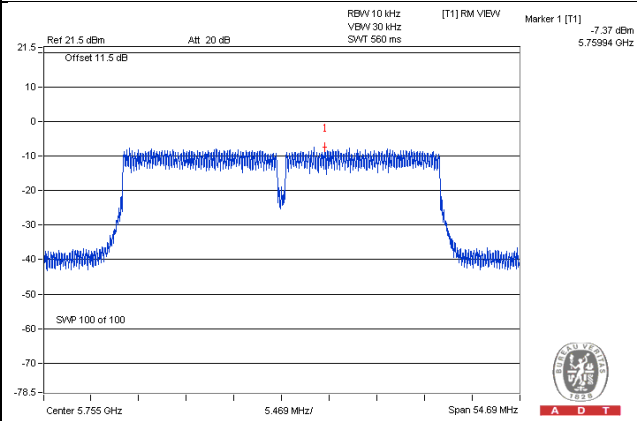
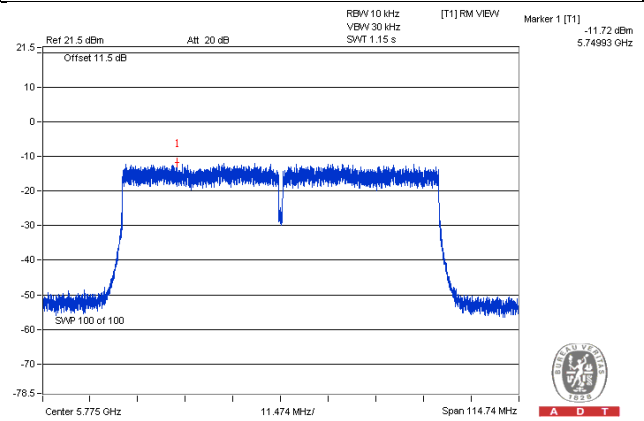
Spectrum Plot of Worst Value
802.11a – Chain 2: CH 165

802.11ac (VHT20) – Chain 2: CH 157

802.11ac (VHT40) – Chain 2: CH 151

802.11ac (VHT80) – Chain 2: CH 155

5.6 Conducted Out of Band Emission Measurement

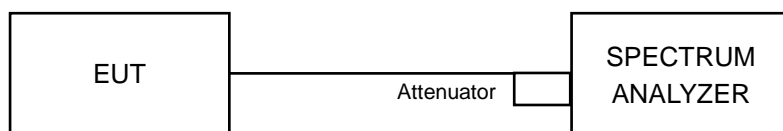
5.6.1 Limits of Conducted Out of Band Emission Measurement

Below 30dB of the highest emission level of operating band (in 100kHz Resolution Bandwidth).

5.6.2 Test Setup



5.6.3 Test Instruments

DESCRIPTION & MANUFACTURER	MODEL NO.	SERIAL NO.	CALIBRATED DATE	CALIBRATED UNTIL
SPECTRUM ANALYZER R&S	FSV 40	100964	July 05, 2014	July 04, 2015

- NOTE:**
1. The test was performed in Oven room B.
 2. The calibration interval of the above test instruments is 12 months and the calibrations are traceable to NML/ROC and NIST/USA.
 3. Tested Date: May 14, 2015

5.6.4 Test Procedure

MEASUREMENT PROCEDURE REF

1. Set the RBW = 100 kHz.
2. Set the VBW \geq 300 kHz.
3. Detector = peak.
4. Sweep time = auto couple.
5. Trace mode = max hold.
6. Allow trace to fully stabilize.
7. Use the peak marker function to determine the maximum power level in any 100 kHz band segment within the fundamental EBW.

MEASUREMENT PROCEDURE OOB

1. Set RBW = 100 kHz.
2. Set VBW \geq 300 kHz.
3. Detector = peak.
4. Sweep = auto couple.
5. Trace Mode = max hold.
6. Allow trace to fully stabilize.
7. Use the peak marker function to determine the maximum amplitude level.

5.6.5 Deviation from Test Standard

No deviation.

5.6.6 EUT Operating Condition

Same as Item 4.3.6

5.6.7 Test Results

The spectrum plots are attached on the following pages. D1 line indicates the highest level, and D2 line indicates the 30dB offset below D1. It shows compliance with the requirement.

CDD Mode
802.11a

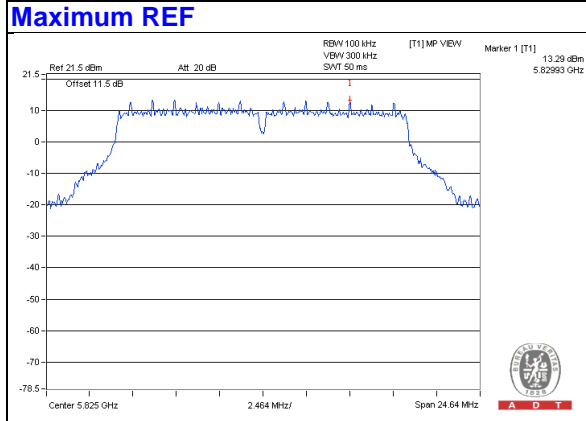

Chain 0
CH 149

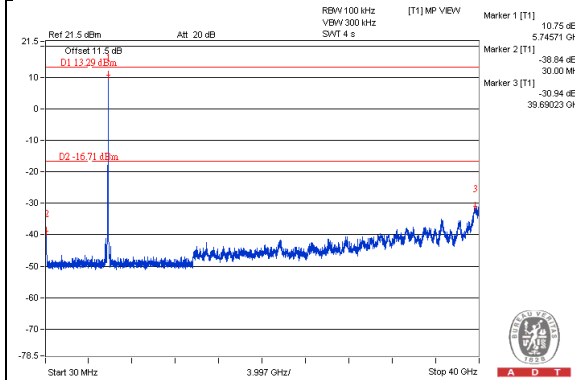

CH 157

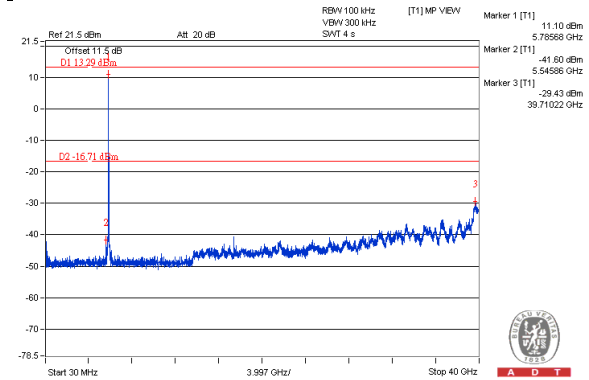

CH 165

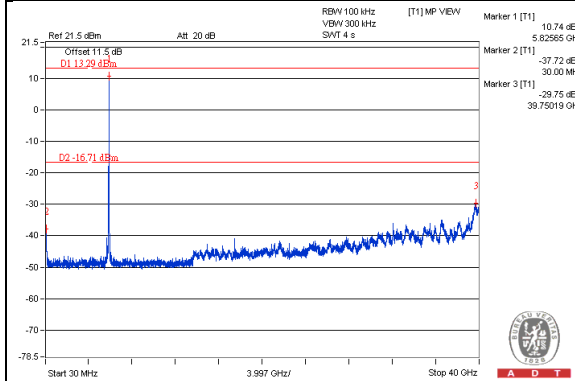

CH 149 Band edge

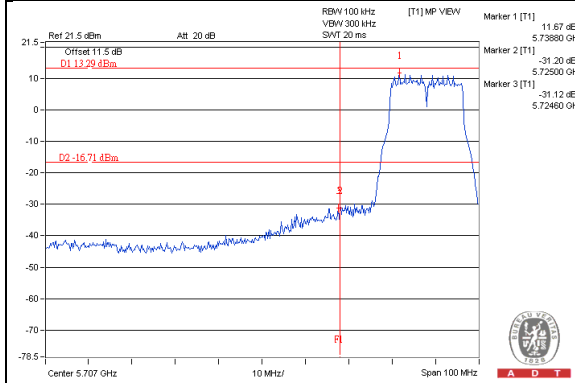

CH 165 Band edge

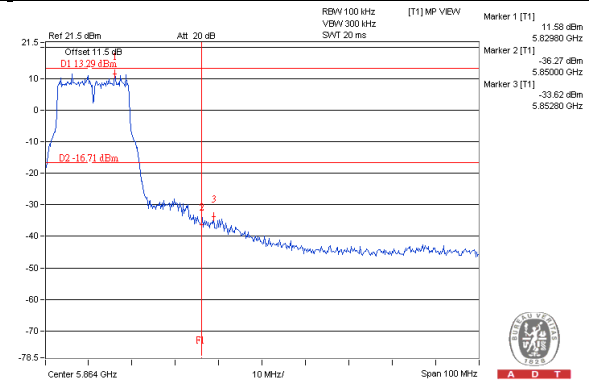

Chain 1
CH 149

CH 157

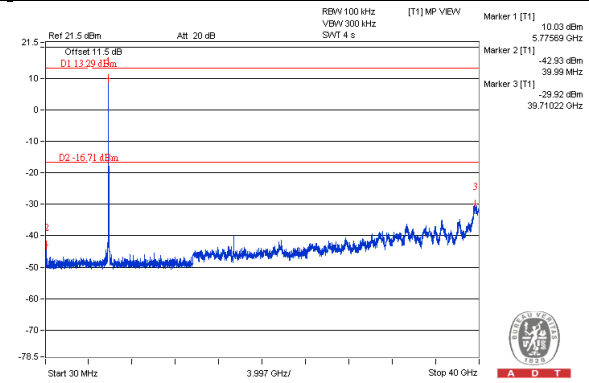
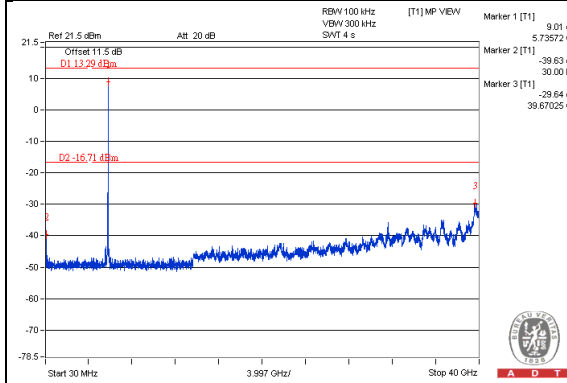

CH 165

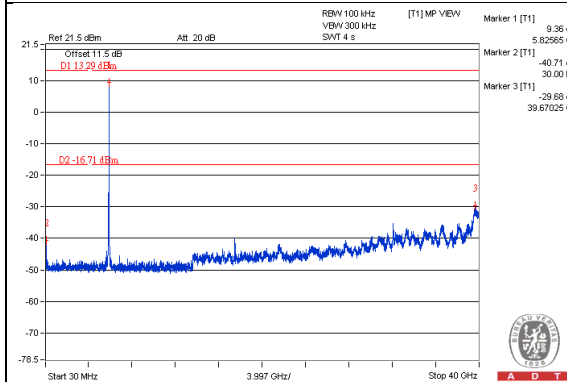

CH 149 Band edge

CH 165 Band edge

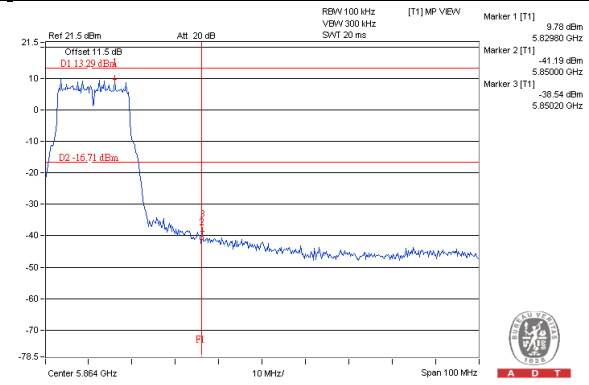
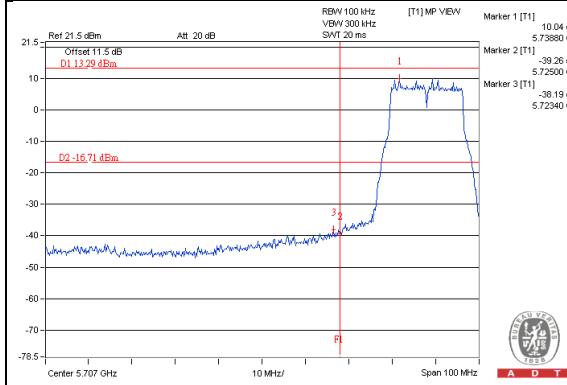

Chain 2
CH 149

CH 157

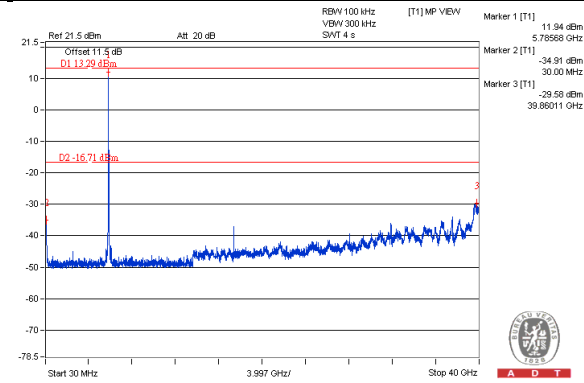
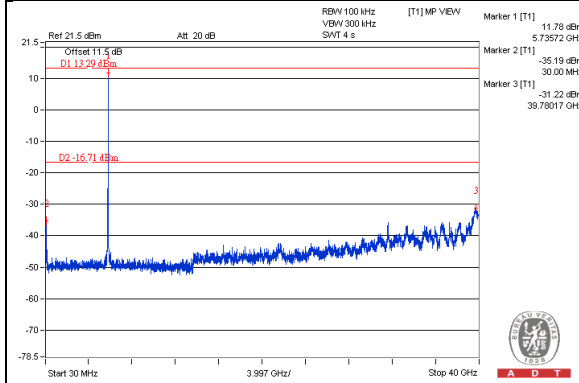

CH 165

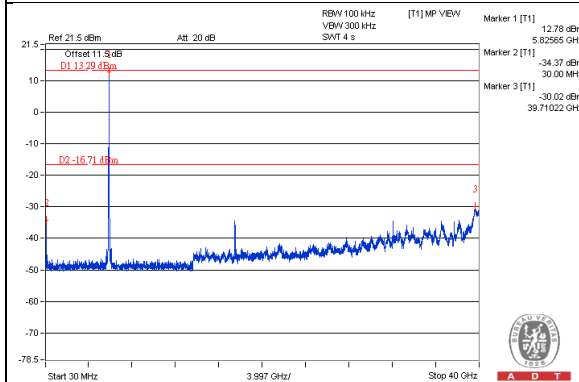

CH 149 Band edge

CH 165 Band edge

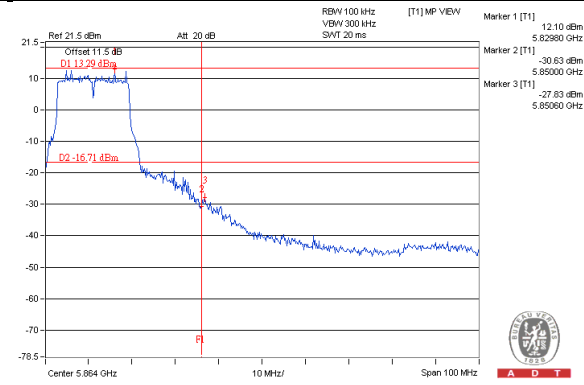
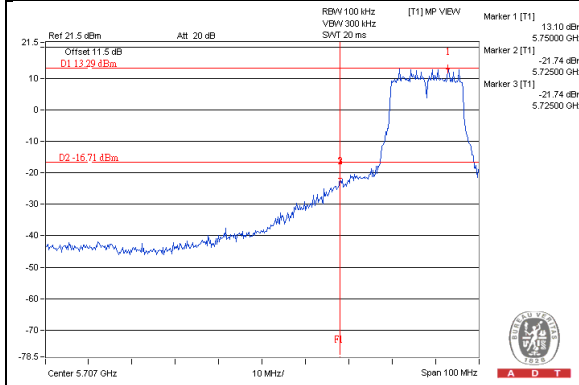

Chain 3
CH 149

CH 157

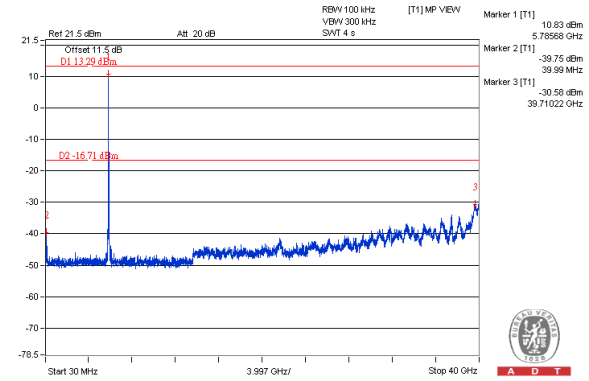
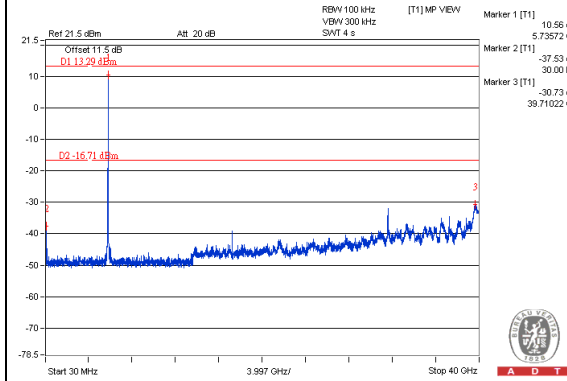

CH 165

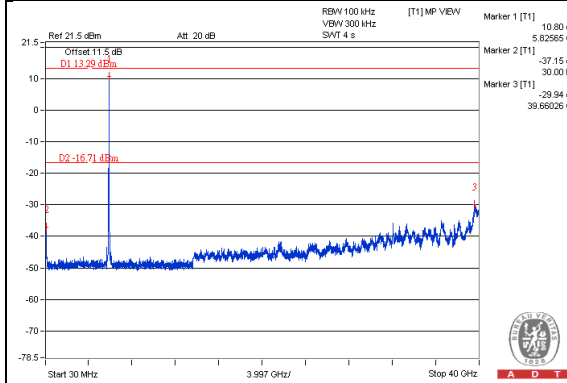

CH 149 Band edge

CH 165 Band edge

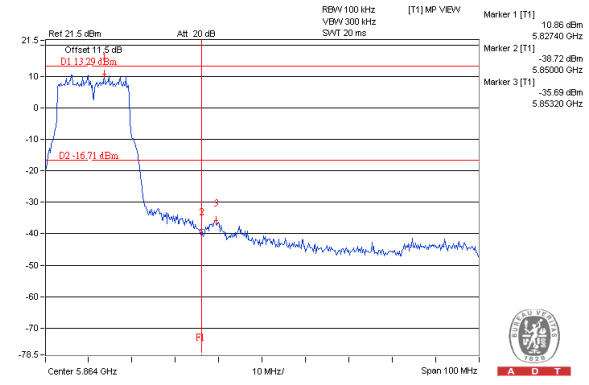
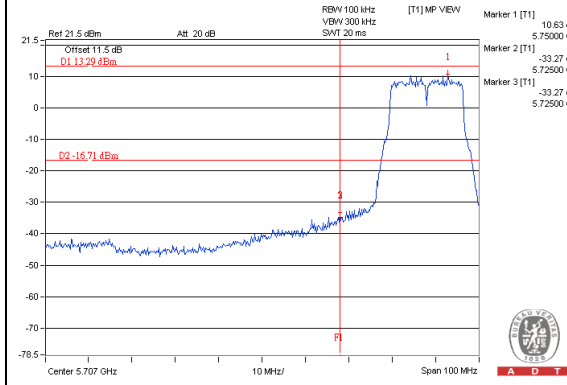

Beamforming Mode 802.11ac (VHT20)

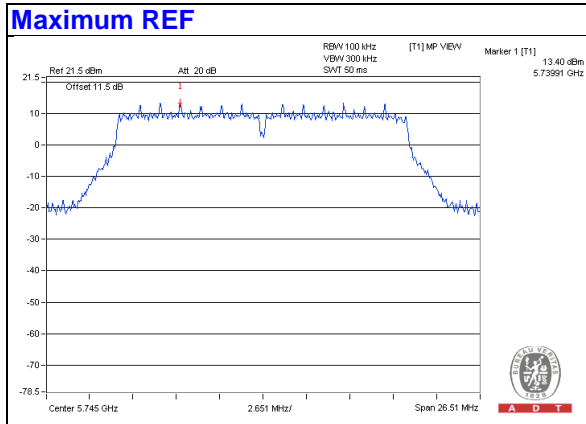

Chain 0 CH 149

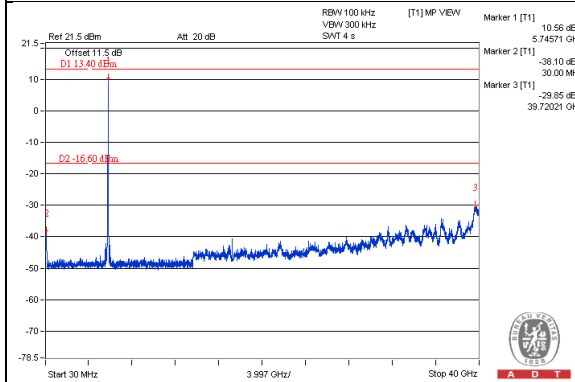

CH 157

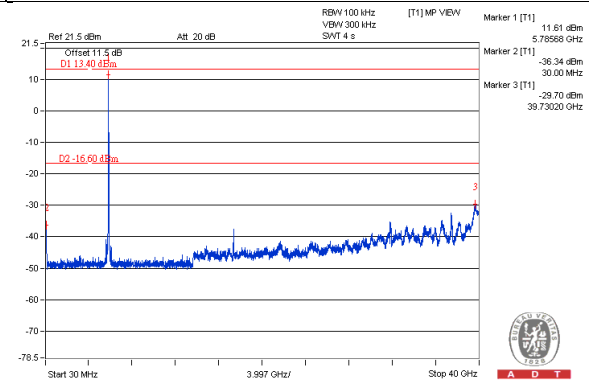

CH 165

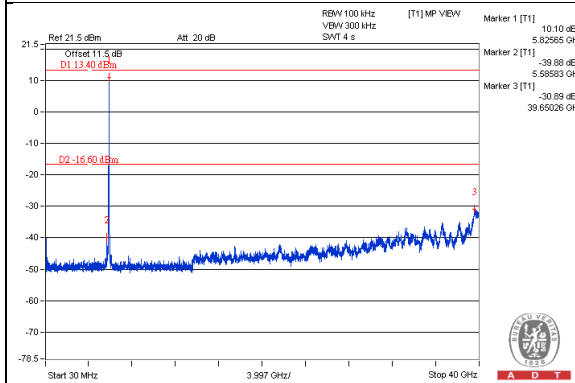

CH 149 Band edge

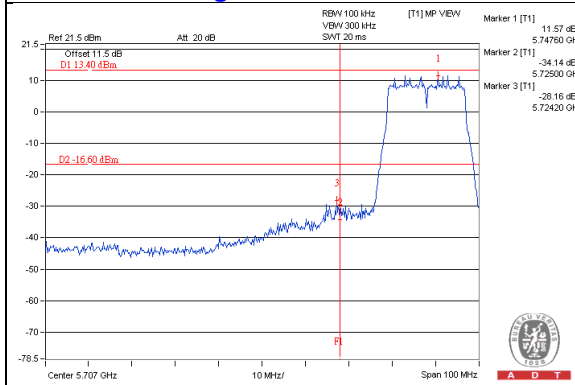

CH 165 Band edge

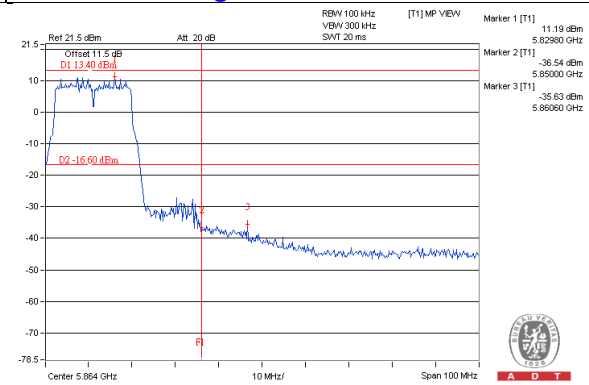

Chain 1
CH 149

CH 157

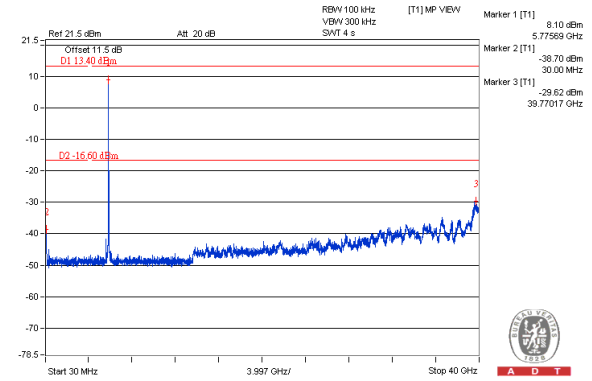
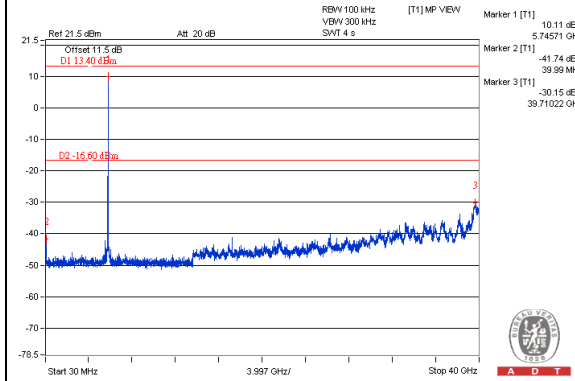

CH 165

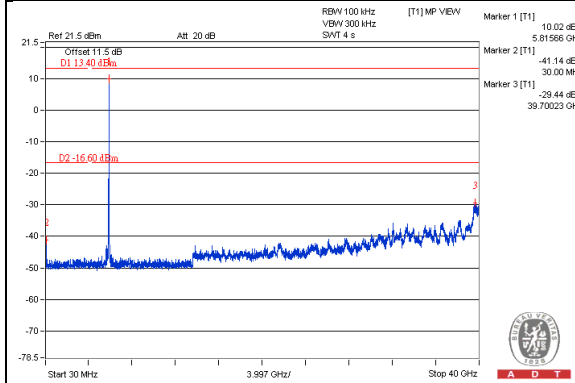

CH 149 Band edge

CH 165 Band edge

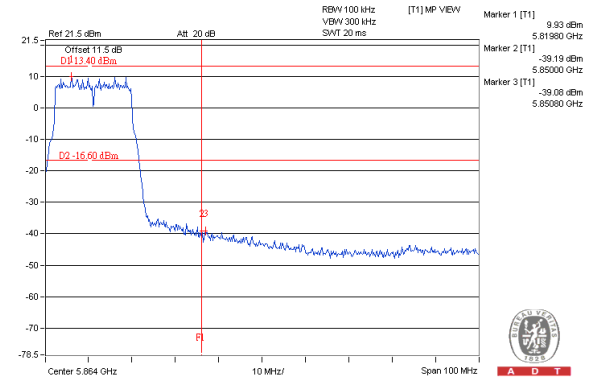
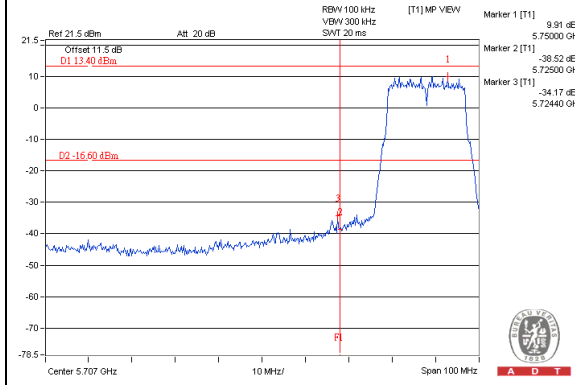

Chain 2
CH 149

CH 157

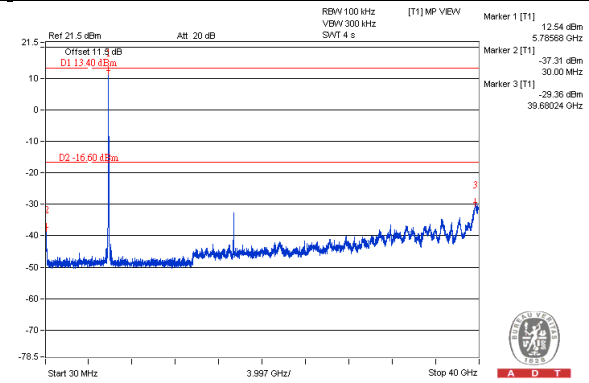
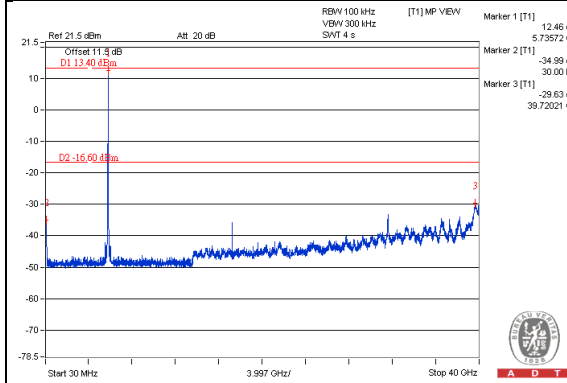

CH 165

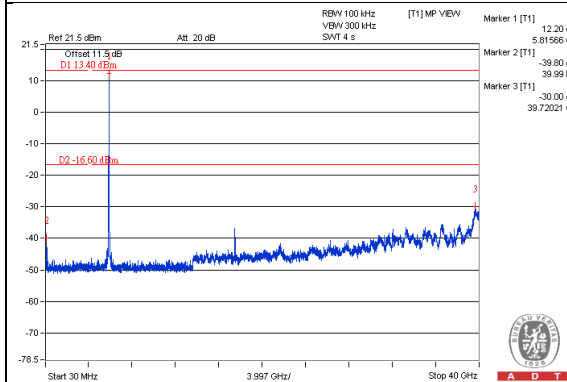

CH 149 Band edge

CH 165 Band edge

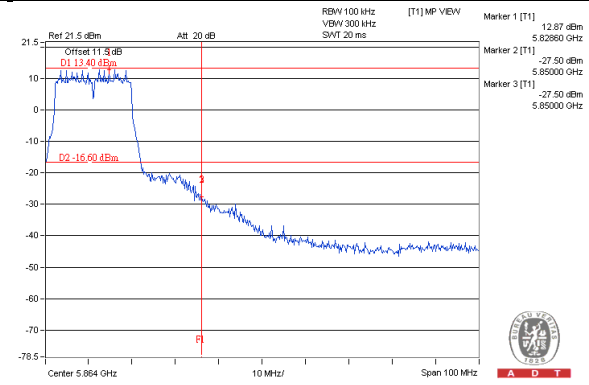
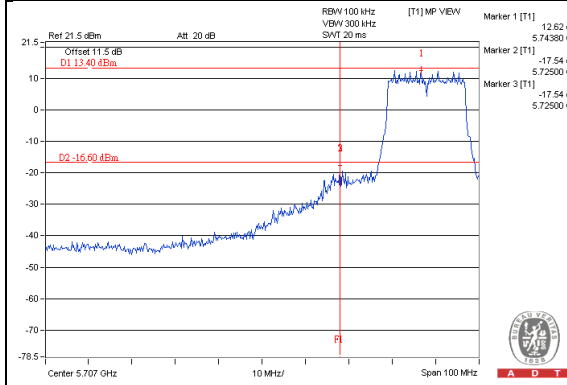

Chain 3
CH 149

CH 157

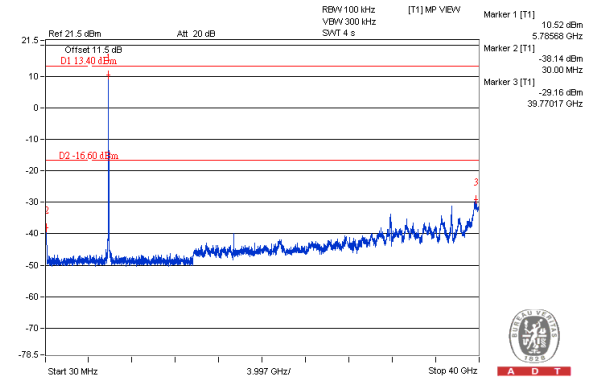
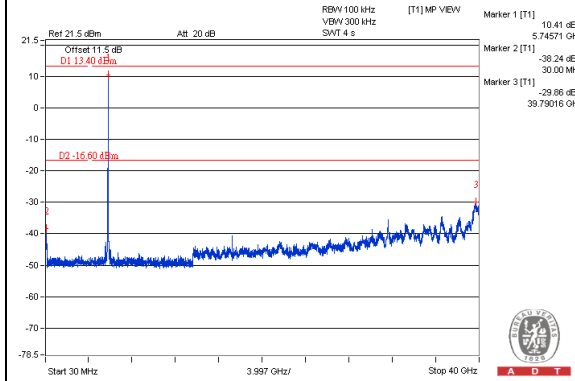

CH 165

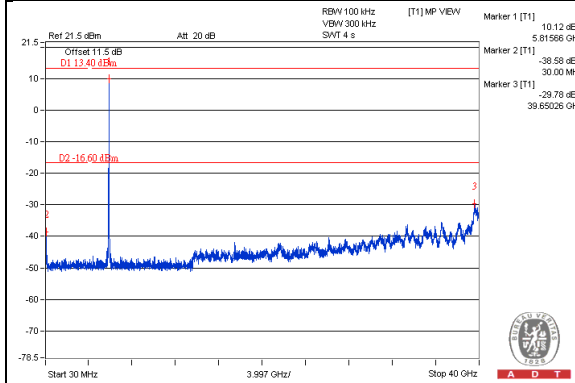

CH 149 Band edge

CH 165 Band edge

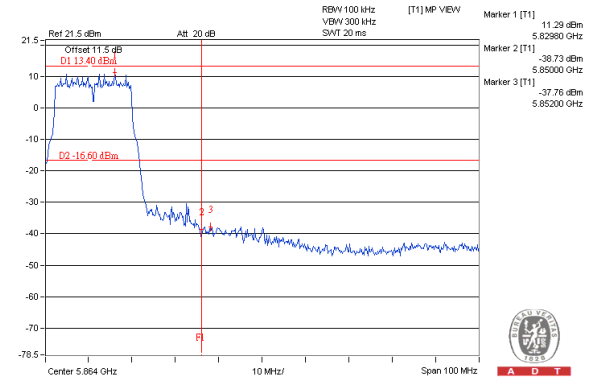
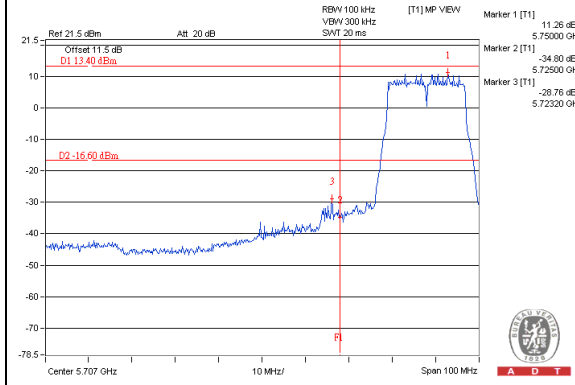

802.11ac (VHT40)

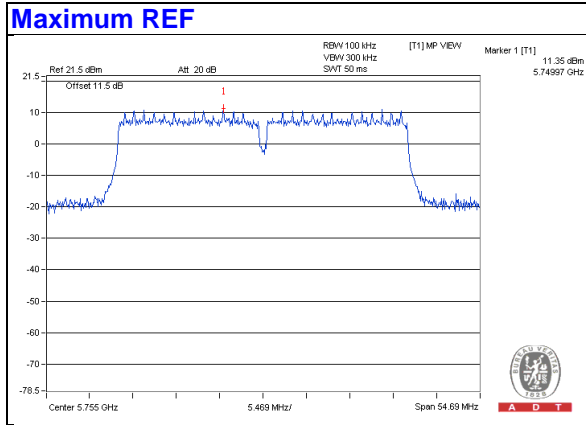

Chain 0
CH 151 **CH 159**

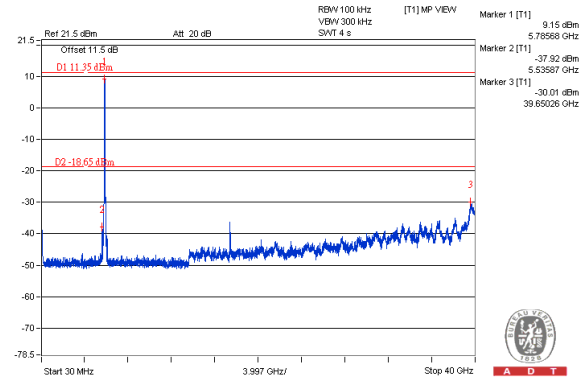
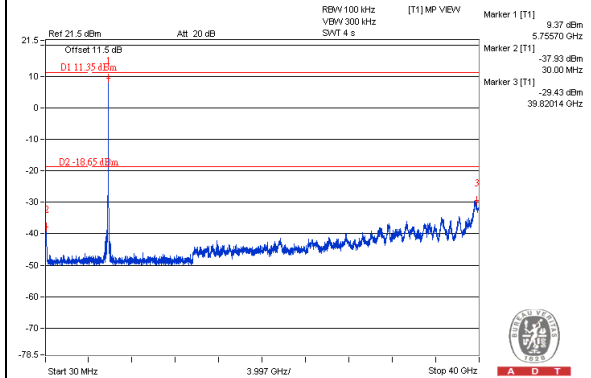

CH 151 Band edge

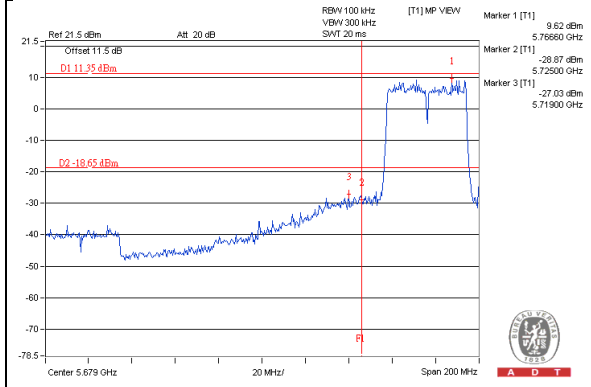

CH 159 Band edge

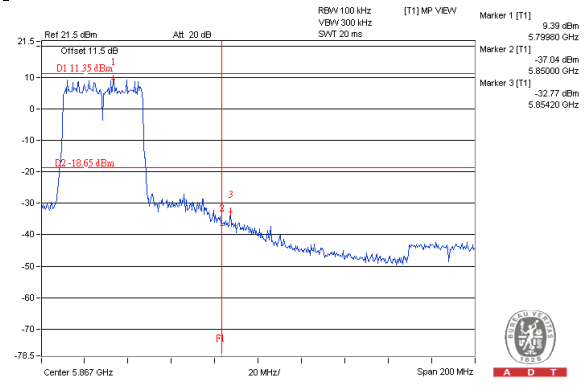

Chain 1
CH 151

CH 159

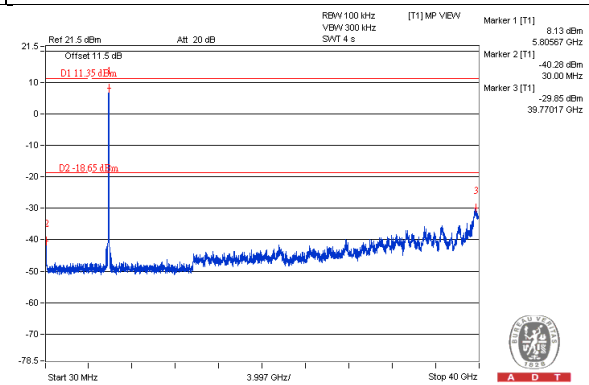
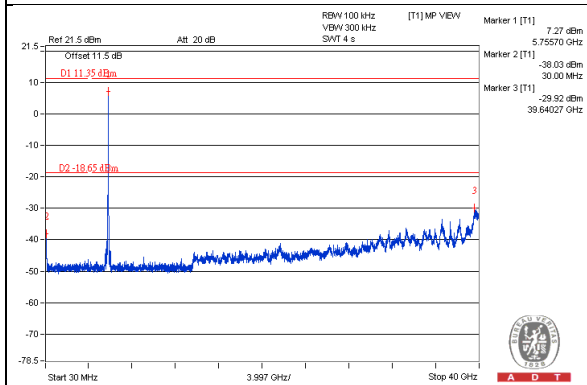

CH 151 Band edge

CH 159 Band edge

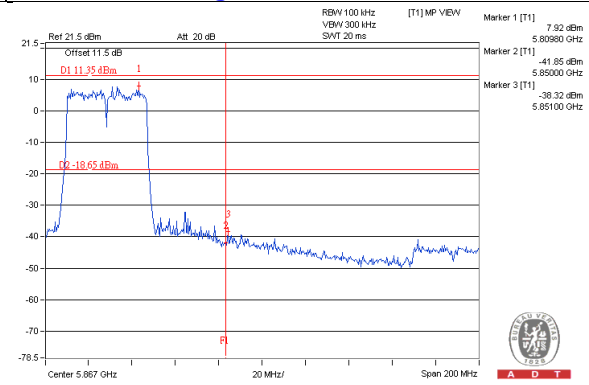
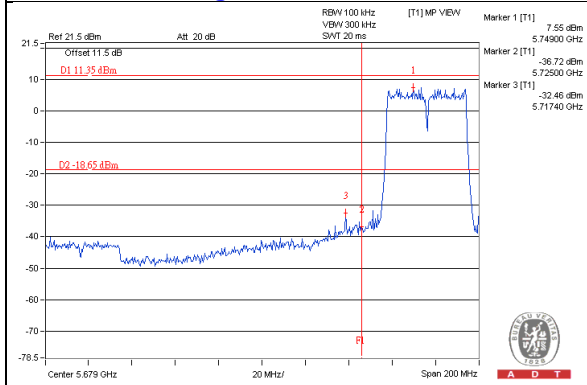

Chain 2
CH 151 **CH 159**

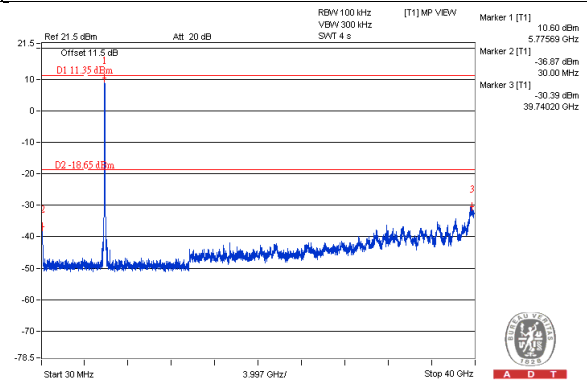
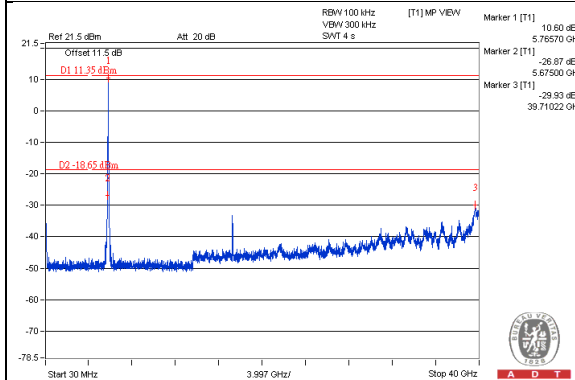

CH 151 Band edge

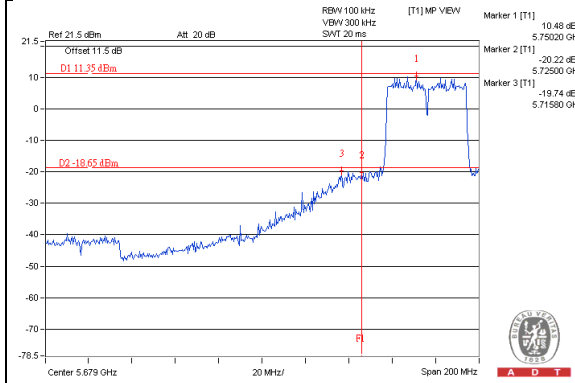

CH 159 Band edge

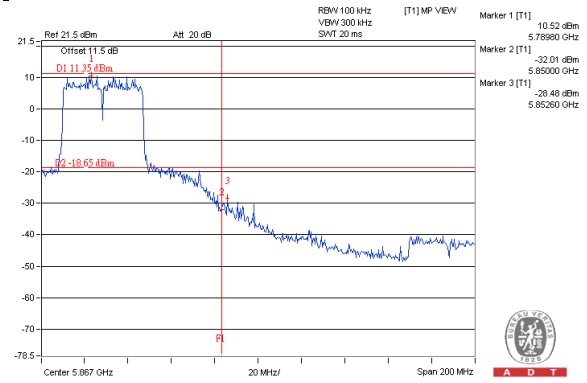

Chain 3
CH 151

CH 159

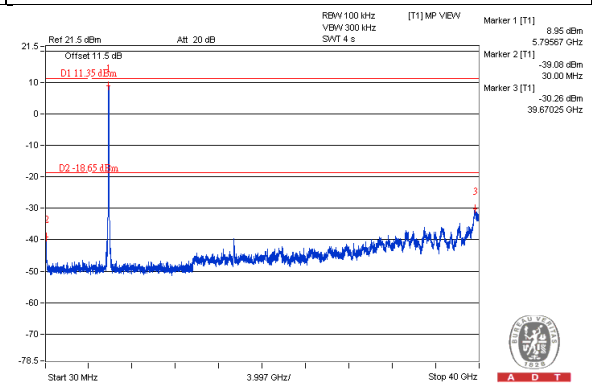
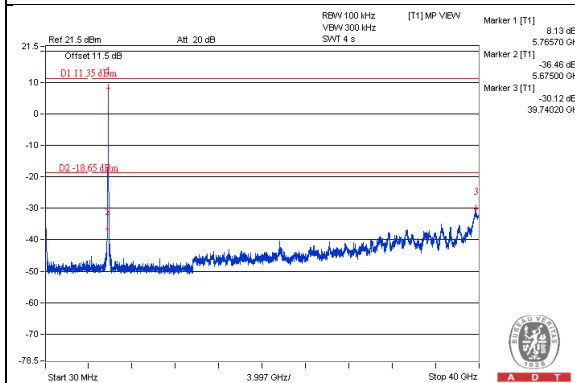

CH 151 Band edge

CH 159 Band edge

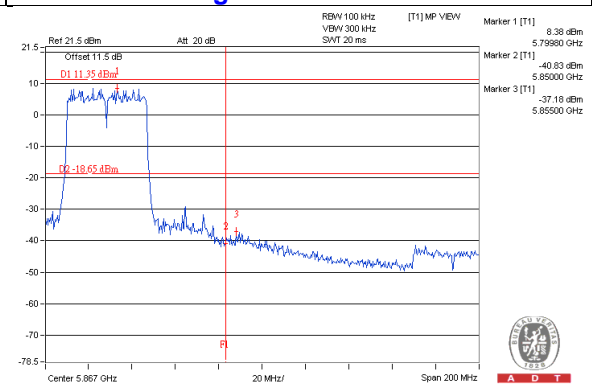
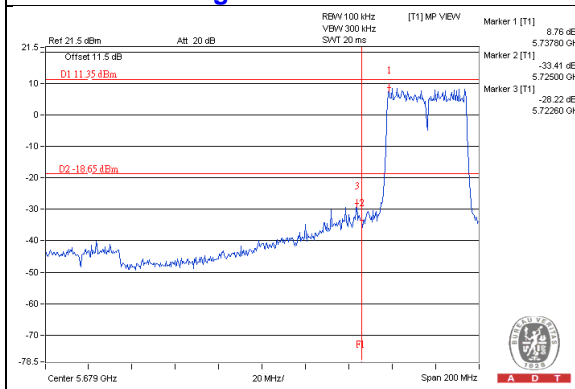

802.11ac (VHT80)

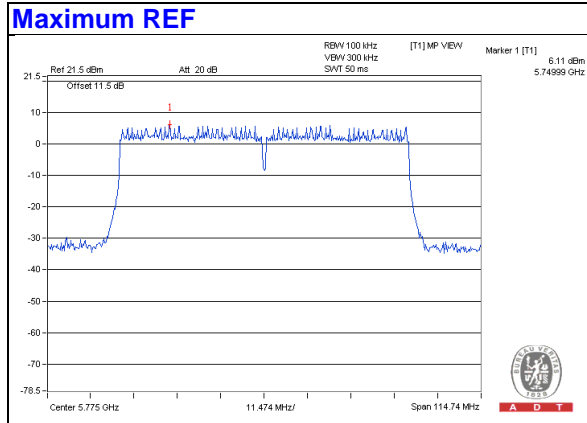

Chain 0 CH 155

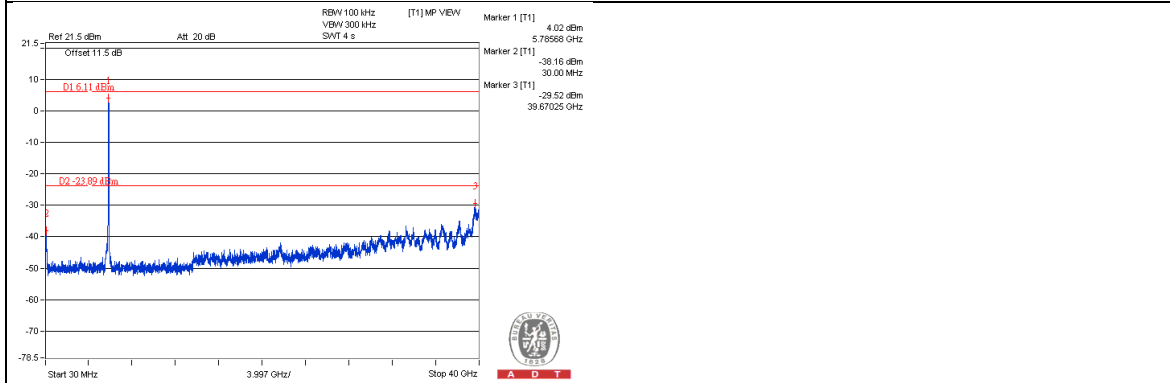

CH 155 Band edge (Left)

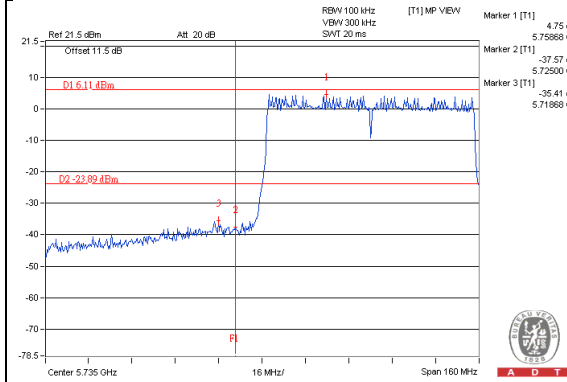

CH 155 Band edge (Right)

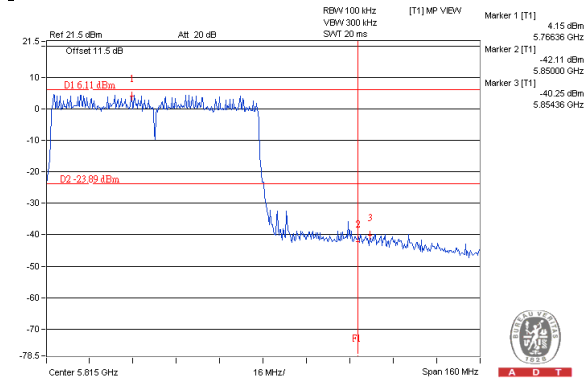

Chain 1
CH 155

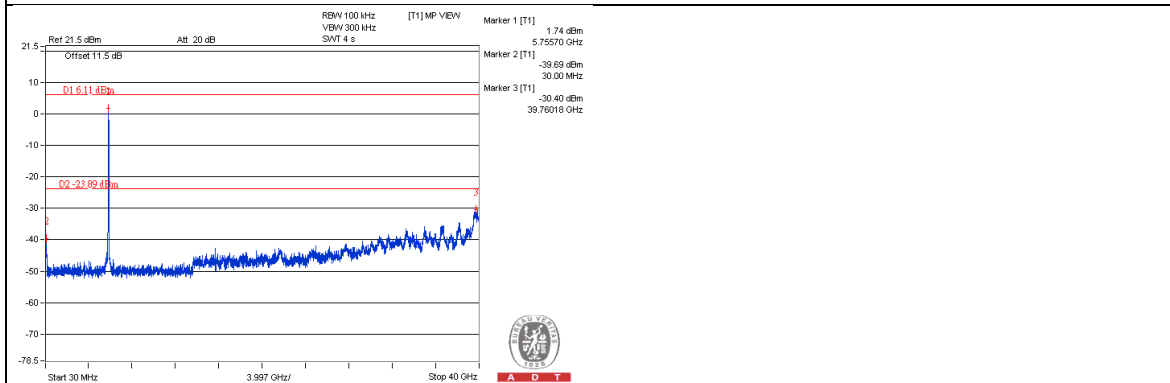

CH 155 Band edge (Left)

CH 155 Band edge (Right)

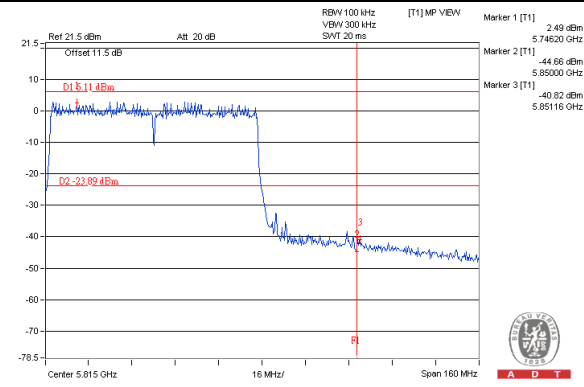
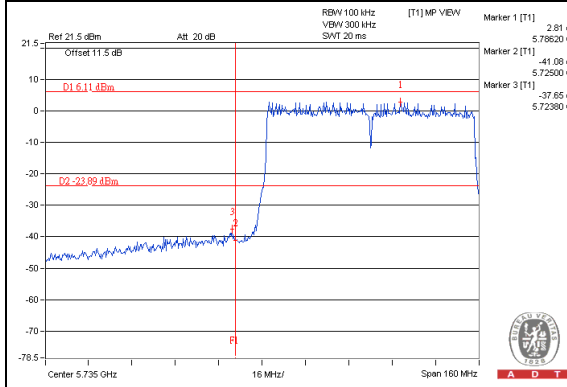

Chain 2
CH 155

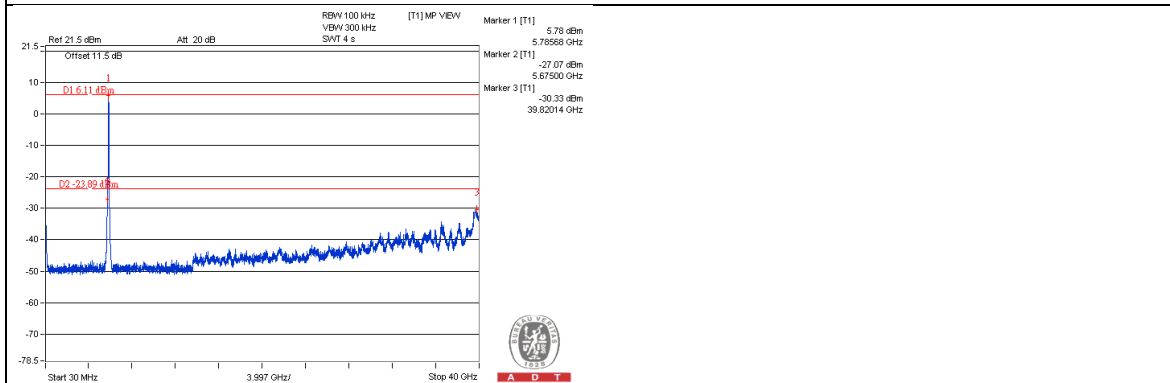

CH 155 Band edge (Left)

CH 155 Band edge (Right)

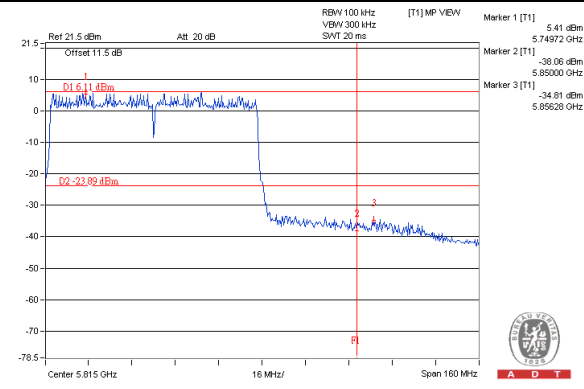
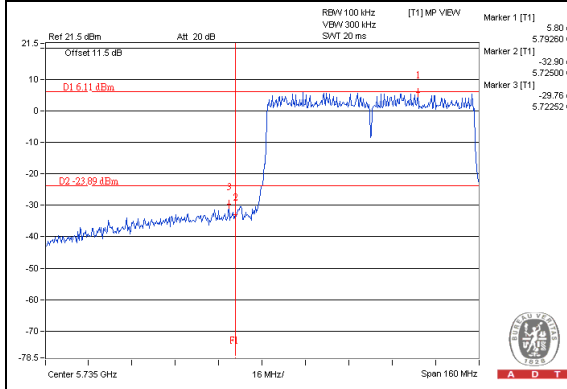

Chain 3
CH 155

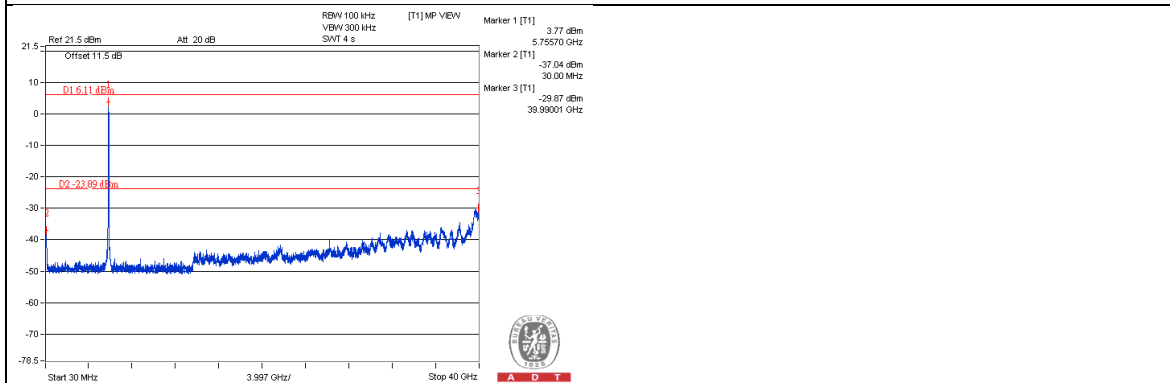

CH 155 Band edge (Left)

CH 155 Band edge (Right)

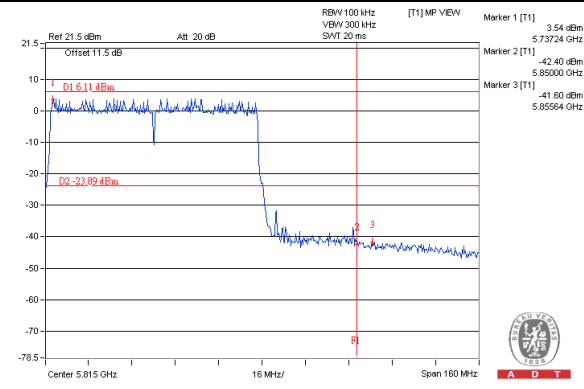
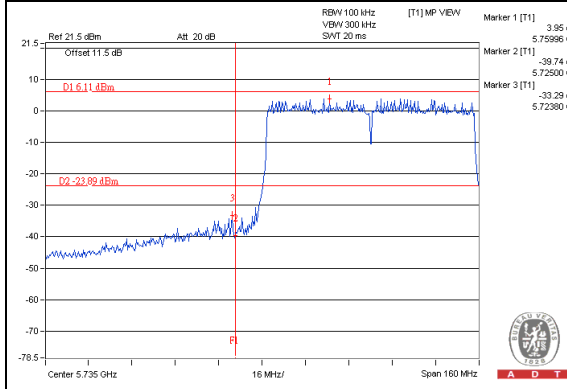

6 Pictures of Test Arrangements

Please refer to the attached file (Test Setup Photo).

Appendix – Information on the Testing Laboratories

We, Bureau Veritas Consumer Products Services (H.K.) Ltd., Taoyuan Branch, were founded in 1988 to provide our best service in EMC, Radio, Telecom and Safety consultation. Our laboratories are accredited and approved according to ISO/IEC 17025.

If you have any comments, please feel free to contact us at the following:

Linko EMC/RF Lab

Tel: 886-2-26052180

Fax: 886-2-26051924

Hsin Chu EMC/RF/Telecom Lab

Tel: 886-3-5935343

Fax: 886-3-5935342

Hwa Ya EMC/RF/Safety Lab

Tel: 886-3-3183232

Fax: 886-3-3270892

Email: service.adt@tw.bureauveritas.com

Web Site: www.bureauveritas-adt.com

The address and road map of all our labs can be found in our web site also.

--- END ---