



A D T

FCC TEST REPORT (15.247)

REPORT NO.: RF120420C08A

MODEL NO.: WNDR3700v4

FCC ID: PY312100186

RECEIVED: Apr. 20, 2012

TESTED: May 07 ~ May 23, 2012

ISSUED: Jun. 04, 2012

APPLICANT: NETGEAR, INC.

ADDRESS: 350 East Plumeria Drive San Jose, CA 95134

ISSUED BY: Bureau Veritas Consumer Products Services
(H.K.) Ltd., Taoyuan Branch

LAB ADDRESS: No. 47, 14th Ling, Chia Pau Vil., Lin Kou Dist.,
New Taipei City, Taiwan, R.O.C.

TEST LOCATION: No. 47, 14th Ling, Chia Pau Vil., Lin Kou Dist.,
New Taipei City, Taiwan, R.O.C.

No. 19, Hwa Ya 2nd Rd, Wen Hwa Tsuen, Kwei
Shan Hsiang, Taoyuan Hsien 333, Taiwan, R.O.C.

This report should not be used by the client to claim product certification, approval, or endorsement by TAF or any government agencies.



This report is for your exclusive use. Any copying or replication of this report to or for any other person or entity, or use of our name or trademark, is permitted only with our prior written permission. This report sets forth our findings solely with respect to the test samples identified herein. The results set forth in this report are not indicative or representative of the quality or characteristics of the lot from which a test sample was taken or any similar or identical product unless specifically and expressly noted. Our report includes all of the tests requested by you and the results thereof based upon the information that you provided to us. You have 60 days from date of issuance of this report to notify us of any material error or omission caused by our negligence, provided, however, that such notice shall be in writing and shall specifically address the issue you wish to raise. A failure to raise such issue within the prescribed time shall constitute your unqualified acceptance of the completeness of this report, the tests conducted and the correctness of the report contents. Unless specific mention, the uncertainty of measurement has been explicitly taken into account to declare the compliance or non-compliance to the specification.



A D T

TABLE OF CONTENTS

RELEASE CONTROL RECORD	5
1. CERTIFICATION	6
2. SUMMARY OF TEST RESULTS	7
2.1 MEASUREMENT UNCERTAINTY	7
3. GENERAL INFORMATION	8
3.1 GENERAL DESCRIPTION OF EUT	8
3.2 DESCRIPTION OF TEST MODES	10
3.2.1 TEST MODE APPLICABILITY AND TESTED CHANNEL DETAIL	11
3.3 DESCRIPTION OF SUPPORT UNITS	15
3.3.1 CONFIGURATION OF SYSTEM UNDER TEST	16
3.4 GENERAL DESCRIPTION OF APPLIED STANDARDS	17
4. TEST TYPES AND RESULTS (FOR 2.4GHz BAND)	18
4.1 RADIATED EMISSION AND BANDEDGE MEASUREMENT	18
4.1.1 LIMITS OF RADIATED EMISSION AND BANDEDGE MEASUREMENT	18
4.1.2 TEST INSTRUMENTS	19
4.1.3 TEST PROCEDURES	20
4.1.4 DEVIATION FROM TEST STANDARD	20
4.1.5 TEST SETUP	21
4.1.6 EUT OPERATING CONDITIONS	21
4.1.7 TEST RESULTS	22
4.2 CONDUCTED EMISSION MEASUREMENT	35
4.2.1 LIMITS OF CONDUCTED EMISSION MEASUREMENT	35
4.2.2 TEST INSTRUMENTS	35
4.2.3 TEST PROCEDURES	36
4.2.4 DEVIATION FROM TEST STANDARD	36
4.2.5 TEST SETUP	36
4.2.6 EUT OPERATING CONDITIONS	36
4.2.7 TEST RESULTS	37
4.3 6dB BANDWIDTH MEASUREMENT	39
4.3.1 LIMITS OF 6dB BANDWIDTH MEASUREMENT	39
4.3.2 TEST SETUP	39
4.3.3 TEST INSTRUMENTS	39
4.3.4 TEST PROCEDURE	39
4.3.5 DEVIATION FROM TEST STANDARD	39
4.3.6 EUT OPERATING CONDITIONS	39
4.3.7 TEST RESULTS	40
4.4 CONDUCTED OUTPUT POWER	41
4.4.1 LIMITS OF CONDUCTED OUTPUT POWER MEASUREMENT	41
4.4.2 TEST SETUP	41
4.4.3 TEST INSTRUMENTS	41
4.4.4 TEST PROCEDURES	41
4.4.5 DEVIATION FROM TEST STANDARD	41
4.4.6 EUT OPERATING CONDITIONS	41
4.4.7 TEST RESULTS	42
4.5 POWER SPECTRAL DENSITY MEASUREMENT	43
4.5.1 LIMITS OF POWER SPECTRAL DENSITY MEASUREMENT	43
4.5.2 TEST SETUP	43



A D T

4.5.3	TEST INSTRUMENTS	43
4.5.4	TEST PROCEDURE	43
4.5.5	DEVIATION FROM TEST STANDARD	43
4.5.6	EUT OPERATING CONDITION	43
4.5.7	TEST RESULTS	44
4.6	CONDUCTED OUT OF BAND EMISSION MEASUREMENT	45
4.6.1	LIMITS OF CONDUCTED OUT OF BAND EMISSION MEASUREMENT	45
4.6.2	TEST SETUP	45
4.6.3	TEST INSTRUMENTS	45
4.6.4	TEST PROCEDURE	45
4.6.5	DEVIATION FROM TEST STANDARD	46
4.6.6	EUT OPERATING CONDITION	46
4.6.7	TEST RESULTS	46
4.6.8	TEST RESULTS	47
5.	TEST TYPES AND RESULTS (FOR 5.0GHz BAND)	51
5.1	RADIATED EMISSION MEASUREMENT	51
5.1.1	LIMITS OF RADIATED EMISSION MEASUREMENT	51
5.1.2	TEST INSTRUMENTS	52
5.1.3	TEST PROCEDURES	52
5.1.4	DEVIATION FROM TEST STANDARD	52
5.1.5	TEST SETUP	52
5.1.6	EUT OPERATING CONDITIONS	52
5.1.7	TEST RESULTS	53
5.2	CONDUCTED EMISSION MEASUREMENT	62
5.2.1	LIMITS OF CONDUCTED EMISSION MEASUREMENT	62
5.2.2	TEST INSTRUMENTS	62
5.2.3	TEST PROCEDURES	62
5.2.4	DEVIATION FROM TEST STANDARD	62
5.2.5	TEST SETUP	62
5.2.6	EUT OPERATING CONDITIONS	62
5.2.7	TEST RESULTS	63
5.3	6dB BANDWIDTH MEASUREMENT	65
5.3.1	LIMITS OF 6dB BANDWIDTH MEASUREMENT	65
5.3.2	TEST SETUP	65
5.3.3	TEST INSTRUMENTS	65
5.3.4	TEST PROCEDURE	65
5.3.5	DEVIATION FROM TEST STANDARD	65
5.3.6	EUT OPERATING CONDITIONS	65
5.3.7	TEST RESULTS	66
5.4	CONDUCTED OUTPUT POWER	67
5.4.1	LIMITS OF CONDUCTED OUTPUT POWER MEASUREMENT	67
5.4.2	TEST SETUP	67
5.4.3	INSTRUMENTS	67
5.4.4	TEST PROCEDURES	67
5.4.5	DEVIATION FROM TEST STANDARD	67
5.4.6	EUT OPERATING CONDITIONS	67
5.4.7	TEST RESULTS	68
5.5	POWER SPECTRAL DENSITY MEASUREMENT	69
5.5.1	LIMITS OF POWER SPECTRAL DENSITY MEASUREMENT	69



A D T

5.5.2	TEST SETUP	69
5.5.3	TEST INSTRUMENTS	69
5.5.4	TEST PROCEDURE	69
5.5.5	DEVIATION FROM TEST STANDARD	69
5.5.6	EUT OPERATING CONDITION.....	69
5.5.7	TEST RESULTS	70
5.6	CONDUCTED OUT OF BAND EMISSION MEASUREMENT	71
5.6.1	LIMITS OF CONDUCTED OUT OF BAND EMISSION MEASUREMENT	71
5.6.2	TEST SETUP	71
5.6.3	TEST INSTRUMENTS	71
5.6.4	TEST PROCEDURE	71
5.6.5	DEVIATION FROM TEST STANDARD	71
5.6.6	EUT OPERATING CONDITION.....	71
5.6.7	TEST RESULTS	71
6.	PHOTOGRAPHS OF THE TEST CONFIGURATION.....	75
7.	INFORMATION ON THE TESTING LABORATORIES	76
8.	APPENDIX A - MODIFICATIONS RECORDERS FOR ENGINEERING CHANGES TO THE EUT BY THE LAB	77



A D T

RELEASE CONTROL RECORD

ISSUE NO.	REASON FOR CHANGE	DATE ISSUED
RF120420C08A	Original release	Jun. 04, 2012



A D T

1. CERTIFICATION

PRODUCT: N600 Wireless Dual Band Gigabit Router
MODEL NO.: WNDR3700v4
BRAND: NETGEAR
APPLICANT: NETGEAR, INC.
TESTED: May 07 ~ May 23, 2012
TEST SAMPLE: ENGINEERING SAMPLE
STANDARDS: **FCC Part 15, Subpart C (Section 15.247)**
ANSI C63.10-2009

The above equipment (Model: WNDR3700v4) has been tested by **Bureau Veritas Consumer Products Services (H.K.) Ltd., Taoyuan Branch**, and found compliance with the requirement of the above standards. The test record, data evaluation & Equipment Under Test (EUT) configurations represented herein are true and accurate accounts of the measurements of the sample's EMC characteristics under the conditions specified in this report.

PREPARED BY :  , DATE : Jun. 04, 2012
Joanna Wang / Senior Specialist

APPROVED BY :  , DATE : Jun. 04, 2012
Gary Chang / Technical Manager



2. SUMMARY OF TEST RESULTS

The EUT has been tested according to the following specifications:

APPLIED STANDARD: FCC PART 15, SUBPART C (SECTION 15.247)			
STANDARD SECTION	TEST TYPE	RESULT	REMARK
15.207	AC Power Conducted Emission	PASS	Meet the requirement of limit. Minimum passing margin is -5.19dB at 0.59141MHz.
15.247(d) 15.209	Radiated Emissions	PASS	Meet the requirement of limit. Minimum passing margin is -1.1dB at 5725.00MHz.
15.247(d)	Band Edge Measurement	PASS	Meet the requirement of limit.
15.247(a)(2)	6dB bandwidth	PASS	Meet the requirement of limit.
15.247(b)	Conducted power	PASS	Meet the requirement of limit.
15.247(e)	Power Spectral Density	PASS	Meet the requirement of limit.
15.203	Antenna Requirement	PASS	Antenna connector is UFL not a standard connector.

2.1 MEASUREMENT UNCERTAINTY

Where relevant, the following measurement uncertainty levels have been estimated for tests performed on the EUT as specified in CISPR 16-4-2:

MEASUREMENT	FREQUENCY	UNCERTAINTY
Conducted emissions	9kHz~30MHz	2.44dB
Radiated emissions	30MHz ~ 1GHz	3.78dB
	1GHz ~ 40GHz	3.36dB

This uncertainty represents an expanded uncertainty expressed at approximately the 95% confidence level using a coverage factor of $k = 2$.



A D T

3. GENERAL INFORMATION

3.1 GENERAL DESCRIPTION OF EUT

EUT	N600 Wireless Dual Band Gigabit Router
MODEL NO.	WNDR3700v4
POWER SUPPLY	12Vdc (Adapter)
MODULATION TYPE	CCK, DQPSK, DBPSK for DSSS 64QAM, 16QAM, QPSK, BPSK for OFDM
MODULATION TECHNOLOGY	DSSS, OFDM
TRANSFER RATE	802.11b: 11.0/ 5.5/ 2.0/ 1.0Mbps 802.11g: 54.0/ 48.0/ 36.0/ 24.0/ 18.0/ 12.0/ 9.0/ 6.0Mbps 802.11a: 54.0/ 48.0/ 36.0/ 24.0/ 18.0/ 12.0/ 9.0/ 6.0Mbps 802.11n: up to 300.0Mbps
OPERATING FREQUENCY	2.4GHz: 2412 ~ 2462MHz 5.0GHz: 5745 ~ 5825MHz
NUMBER OF CHANNEL	2.4GHz: 11 for 802.11b, 802.11g, 802.11n (20MHz) 7 for 802.11n (40MHz) 5.0GHz: 5 for 802.11a, 802.11n (20MHz) 2 for 802.11n (40MHz)
OUTPUT POWER	386.9mW for 2412 ~ 2462MHz 166.8mW for 5745 ~ 5825MHz
ANTENNA TYPE	2.4GHz: Printed antenna with 3.02dBi gain 5.0GHz: Printed antenna with 2.50dBi gain
ANTENNA CONNECTOR	UFL
DATA CABLE	N/A
I/O PORTS	RJ45, USB
ACCESSORY DEVICES	Adapter

NOTE:

1. The frequency bands used in this EUT are listed as follows:

Frequency Band (MHz)	2412~2462	5180~5240	5745~5825
802.11b	√		
802.11g	√		
802.11a		√	√
802.11n (20MHz)	√	√	√
802.11n (40MHz)	√	√	√

2. The EUT incorporates a MIMO function. Physically, the EUT provides two completed transmitters and two receivers.

MODULATION MODE	TX FUNCTION
802.11b	2TX
802.11g	2TX
802.11a	2TX
802.11n (20MHz)	2TX
802.11n (40MHz)	2TX

3. The EUT uses following adapters:

ADAPTER 1	
BRAND	NETGEAR
MODEL	MU30-5120250-A1
P/N	332-10234-01
INPUT POWER	100-240Vac, 50/60Hz, 0.8A
OUTPUT POWER	12Vdc, 2.5A
POWER LINE	1.8m non-shielded cable without core

ADAPTER 2	
BRAND	NETGEAR
MODEL	P030WF120B 11200-6LF
P/N	332-10200-02
INPUT POWER	100-240Vac, 50/60Hz, 1.0A
OUTPUT POWER	12Vdc, 2.5A
POWER LINE	1.8m non-shielded cable without core

*Adapter 1 was the worst for the final tests.

4. The above EUT information is declared by manufacturer and for more detailed features description, please refer to the manufacturer's specifications or user's manual.



3.2 DESCRIPTION OF TEST MODES

FOR 2.4GHz:

11 channels are provided for 802.11b, 802.11g and 802.11n (20MHz):

CHANNEL	FREQUENCY	CHANNEL	FREQUENCY
1	2412MHz	7	2442MHz
2	2417MHz	8	2447MHz
3	2422MHz	9	2452MHz
4	2427MHz	10	2457MHz
5	2432MHz	11	2462MHz
6	2437MHz		

7 channels are provided for 802.11n (40MHz):

CHANNEL	FREQUENCY	CHANNEL	FREQUENCY
3	2422MHz	7	2442MHz
4	2427MHz	8	2447MHz
5	2432MHz	9	2452MHz
6	2437MHz		

FOR 5.0GHz (5745 ~ 5825MHz):

5 channels are provided for 802.11a, 802.11n (20MHz):

CHANNEL	FREQUENCY	CHANNEL	FREQUENCY
149	5745MHz	161	5805MHz
153	5765MHz	165	5825MHz
157	5785MHz		

2 channels are provided for 802.11n (40MHz):

CHANNEL	FREQUENCY	CHANNEL	FREQUENCY
151	5755MHz	159	5795MHz



3.2.1 TEST MODE APPLICABILITY AND TESTED CHANNEL DETAIL

FOR 2.4GHz:

EUT CONFIGURE MODE	APPLICABLE TO				DESCRIPTION
	RE≥1G	RE<1G	PLC	APCM	
-	√	√	√	√	-

Where **RE≥1G**: Radiated Emission above 1GHz **RE<1G**: Radiated Emission below 1GHz
PLC: Power Line Conducted Emission **APCM**: Antenna Port Conducted Measurement

NOTE:

The EUT had been pre-tested on the positioned of each 3 axis. The worst case was found when positioned on **X-plane**.

RADIATED EMISSION TEST (ABOVE 1GHz):

- Pre-Scan has been conducted to determine the worst-case mode from all possible combinations between available modulations, data rates and antenna ports (if EUT with antenna diversity architecture).
- Following channel(s) was (were) selected for the final test as listed below.

EUT CONFIGURE MODE	MODE	AVAILABLE CHANNEL	TESTED CHANNEL	MODULATION TECHNOLOGY	MODULATION TYPE	DATA RATE (Mbps)
-	802.11b	1 to 11	1, 6, 11	DSSS	DBPSK	1.0
-	802.11g	1 to 11	1, 6, 11	OFDM	BPSK	6.0
-	802.11n (20MHz)	1 to 11	1, 6, 11	OFDM	BPSK	7.2
-	802.11n (40MHz)	3 to 9	3, 6, 9	OFDM	BPSK	15.0

RADIATED EMISSION TEST (BELOW 1GHz):

- Pre-Scan has been conducted to determine the worst-case mode from all possible combinations between available modulations, data rates and antenna ports (if EUT with antenna diversity architecture).
- Following channel(s) was (were) selected for the final test as listed below.

EUT CONFIGURE MODE	MODE	AVAILABLE CHANNEL	TESTED CHANNEL	MODULATION TECHNOLOGY	MODULATION TYPE	DATA RATE (Mbps)
-	802.11b	1 to 11	6	DSSS	DBPSK	1.0

POWER LINE CONDUCTED EMISSION TEST:

- Pre-Scan has been conducted to determine the worst-case mode from all possible combinations between available modulations, data rates and antenna ports (if EUT with antenna diversity architecture).
- Following channel(s) was (were) selected for the final test as listed below.

EUT CONFIGURE MODE	MODE	AVAILABLE CHANNEL	TESTED CHANNEL	MODULATION TECHNOLOGY	MODULATION TYPE	DATA RATE (Mbps)
-	802.11b	1 to 11	6	DSSS	DBPSK	1.0



BANDEDGE MEASUREMENT:

- Pre-Scan has been conducted to determine the worst-case mode from all possible combinations between available modulations, data rates and antenna ports (if EUT with antenna diversity architecture).
- Following channel(s) was (were) selected for the final test as listed below.

EUT CONFIGURE MODE	MODE	AVAILABLE CHANNEL	TESTED CHANNEL	MODULATION TECHNOLOGY	MODULATION TYPE	DATA RATE (Mbps)
-	802.11b	1 to 11	1, 11	DSSS	DBPSK	1.0
-	802.11g	1 to 11	1, 11	OFDM	BPSK	6.0
-	802.11n (20MHz)	1 to 11	1, 11	OFDM	BPSK	7.2
-	802.11n (40MHz)	3 to 9	3, 9	OFDM	BPSK	15.0

ANTENNA PORT CONDUCTED MEASUREMENT:

- This item includes all test value of each mode, but only includes spectrum plot of worst value of each mode.
- Pre-Scan has been conducted to determine the worst-case mode from all possible combinations between available modulations, data rates and antenna ports (if EUT with antenna diversity architecture).
- Following channel(s) was (were) selected for the final test as listed below.

EUT CONFIGURE MODE	MODE	AVAILABLE CHANNEL	TESTED CHANNEL	MODULATION TECHNOLOGY	MODULATION TYPE	DATA RATE (Mbps)
-	802.11b	1 to 11	1, 6, 11	DSSS	DBPSK	1.0
-	802.11g	1 to 11	1, 6, 11	OFDM	BPSK	6.0
-	802.11n (20MHz)	1 to 11	1, 6, 11	OFDM	BPSK	7.2
-	802.11n (40MHz)	3 to 9	3, 6, 9	OFDM	BPSK	15.0

TEST CONDITION:

APPLICABLE TO	ENVIRONMENTAL CONDITIONS	INPUT POWER	TESTED BY
RE≥1G	24deg. C, 68%RH	120Vac, 60Hz	Chad Lee
RE<1G	24deg. C, 64%RH	120Vac, 60Hz	Chad Lee
PLC	25deg. C, 65%RH	120Vac, 60Hz	Haru Yang
APCM	24deg. C, 68%RH	120Vac, 60Hz	Mark Liao



FOR 5.0GHz (5745 ~ 5825MHz):

EUT CONFIGURE MODE	APPLICABLE TO				DESCRIPTION
	RE≥1G	RE<1G	PLC	APCM	
-	√	√	√	√	-

Where **RE≥1G**: Radiated Emission above 1GHz **RE<1G**: Radiated Emission below 1GHz
PLC: Power Line Conducted Emission **APCM**: Antenna Port Conducted Measurement

NOTE:
The EUT had been pre-tested on the positioned of each 3 axis. The worst case was found when positioned on **X-plane**.

RADIATED EMISSION TEST (ABOVE 1GHz):

- Pre-Scan has been conducted to determine the worst-case mode from all possible combinations between available modulations, data rates and antenna ports (if EUT with antenna diversity architecture).
- Following channel(s) was (were) selected for the final test as listed below.

EUT CONFIGURE MODE	MODE	AVAILABLE CHANNEL	TESTED CHANNEL	MODULATION TECHNOLOGY	MODULATION TYPE	DATA RATE (Mbps)
-	802.11a	149 to 165	149, 157, 165	OFDM	BPSK	6.0
-	802.11n (20MHz)	149 to 165	149, 157, 165	OFDM	BPSK	7.2
-	802.11n (40MHz)	151 to 159	151, 159	OFDM	BPSK	15.0

RADIATED EMISSION TEST (BELOW 1GHz):

- Pre-Scan has been conducted to determine the worst-case mode from all possible combinations between available modulations, data rates and antenna ports (if EUT with antenna diversity architecture).
- Following channel(s) was (were) selected for the final test as listed below.

EUT CONFIGURE MODE	MODE	AVAILABLE CHANNEL	TESTED CHANNEL	MODULATION TECHNOLOGY	MODULATION TYPE	DATA RATE (Mbps)
-	802.11a	149 to 165	157	OFDM	BPSK	6.0

POWER LINE CONDUCTED EMISSION TEST:

- Pre-Scan has been conducted to determine the worst-case mode from all possible combinations between available modulations, data rates and antenna ports (if EUT with antenna diversity architecture).
- Following channel(s) was (were) selected for the final test as listed below.

EUT CONFIGURE MODE	MODE	AVAILABLE CHANNEL	TESTED CHANNEL	MODULATION TECHNOLOGY	MODULATION TYPE	DATA RATE (Mbps)
-	802.11a	149 to 165	157	OFDM	BPSK	6.0



BANDEDGE MEASUREMENT:

- Pre-Scan has been conducted to determine the worst-case mode from all possible combinations between available modulations, data rates and antenna ports (if EUT with antenna diversity architecture).
- Following channel(s) was (were) selected for the final test as listed below.

EUT CONFIGURE MODE	MODE	AVAILABLE CHANNEL	TESTED CHANNEL	MODULATION TECHNOLOGY	MODULATION TYPE	DATA RATE (Mbps)
-	802.11a	149 to 165	149, 165	OFDM	BPSK	6.0
-	802.11n (20MHz)	149 to 165	149, 165	OFDM	BPSK	7.2
-	802.11n (40MHz)	151 to 159	151, 159	OFDM	BPSK	15.0

ANTENNA PORT CONDUCTED MEASUREMENT:

- This item includes all test value of each mode, but only includes spectrum plot of worst value of each mode.
- Pre-Scan has been conducted to determine the worst-case mode from all possible combinations between available modulations, data rates and antenna ports (if EUT with antenna diversity architecture).
- Following channel(s) was (were) selected for the final test as listed below.

EUT CONFIGURE MODE	MODE	AVAILABLE CHANNEL	TESTED CHANNEL	MODULATION TECHNOLOGY	MODULATION TYPE	DATA RATE (Mbps)
-	802.11a	149 to 165	149, 157, 165	OFDM	BPSK	6.0
-	802.11n (20MHz)	149 to 165	149, 157, 165	OFDM	BPSK	7.2
-	802.11n (40MHz)	151 to 159	151, 159	OFDM	BPSK	15.0

TEST CONDITION:

APPLICABLE TO	ENVIRONMENTAL CONDITIONS	INPUT POWER	TESTED BY
RE≥1G	24deg. C, 71%RH	120Vac, 60Hz	Chad Lee
RE<1G	24deg. C, 68%RH	120Vac, 60Hz	Chad Lee
PLC	25deg. C, 65%RH	120Vac, 60Hz	Haru Yang
APCM	24deg. C, 68%RH	120Vac, 60Hz	Mark Liao



3.3 DESCRIPTION OF SUPPORT UNITS

The EUT has been tested as an independent unit together with other necessary accessories or support units. The following support units or accessories were used to form a representative test configuration during the tests.

NO.	PRODUCT	BRAND	MODEL NO.	SERIAL NO.	FCC ID
1	USB DONGLE	Transcend	N/A	N/A	N/A
2	NOTEBOOK	DELL	E5410	1HC2XM1	FCC DoC Approved
3	NOTEBOOK	DELL	E5410	6RP2YM1	FCC DoC Approved

NO.	SIGNAL CABLE DESCRIPTION OF THE ABOVE SUPPORT UNITS
1	N/A
2	10m RJ45 UTP cable
3	10m RJ45 UTP cable

NOTE:

1. All power cords of the above support units are non shielded (1.8m).
2. Items 2~3 acted as communication partners to transfer data.

3.3.1 CONFIGURATION OF SYSTEM UNDER TEST

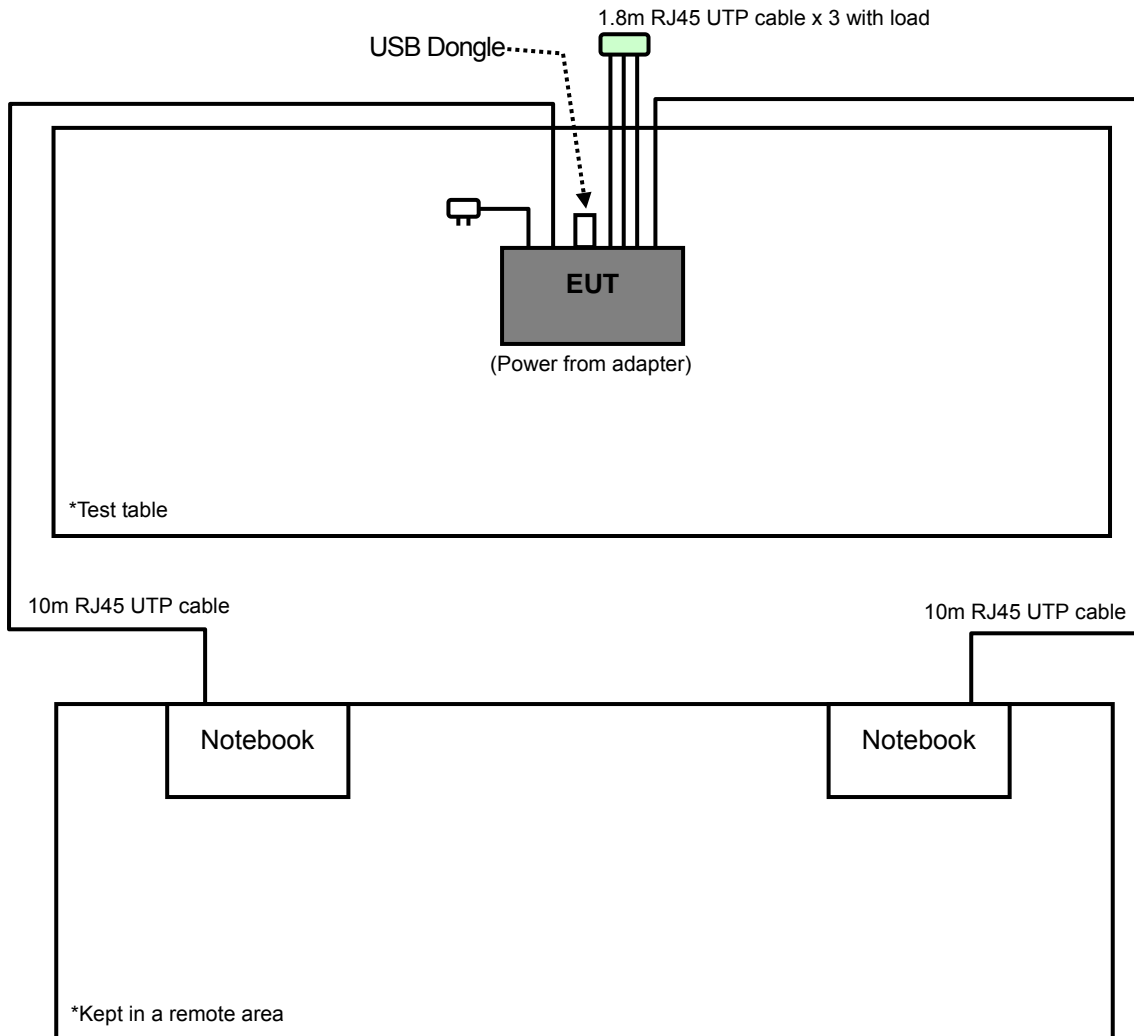



A D T

3.4 GENERAL DESCRIPTION OF APPLIED STANDARDS

The EUT is a RF Product. According to the specifications of the manufacturer, it must comply with the requirements of the following standards:

FCC Part 15, Subpart C (15.247)

558074 D01 DTS Meas Guidance v01

ANSI C63.10-2009

All test items have been performed and recorded as per the above standards.

NOTE: The EUT is also considered as a kind of computer peripheral, because the connection to computer is necessary for typical use. It has been verified to comply with the requirements of FCC Part 15, Subpart B, Class B (DoC). The test report has been issued separately.



4. TEST TYPES AND RESULTS (FOR 2.4GHz BAND)

4.1 RADIATED EMISSION AND BANDEDGE MEASUREMENT

4.1.1 LIMITS OF RADIATED EMISSION AND BANDEDGE MEASUREMENT

Radiated emissions which fall in the restricted bands must comply with the radiated emission limits specified as below table. Other emissions shall be at least 30dB below the highest level of the desired power:

FREQUENCIES (MHz)	FIELD STRENGTH (microvolts/meter)	MEASUREMENT DISTANCE (meters)
0.009 ~ 0.490	2400/F(kHz)	300
0.490 ~ 1.705	24000/F(kHz)	30
1.705 ~ 30.0	30	30
30 ~ 88	100	3
88 ~ 216	150	3
216 ~ 960	200	3
Above 960	500	3

NOTE:

1. The lower limit shall apply at the transition frequencies.
2. Emission level (dBuV/m) = 20 log Emission level (uV/m).
3. For frequencies above 1000MHz, the field strength limits are based on average detector, however, the peak field strength of any emission shall not exceed the maximum permitted average limits, specified above by more than 30dB under any condition of modulation.



A D T

4.1.2 TEST INSTRUMENTS

DESCRIPTION & MANUFACTURER	MODEL NO.	SERIAL NO.	DATE OF CALIBRATION	DUE DATE OF CALIBRATION
Agilent Preamplifier	8447D	2432A03504	Feb. 29, 2012	Feb. 28, 2013
ROHDE & SCHWARZ TEST RECEIVER	ESCI	100412	Aug. 18, 2011	Dec. 09, 2012
Schwarzbeck Antenna	VULB9168	137	Apr. 03, 2012	Apr. 02, 2013
Loop Antenna	HFH2-Z2	100070	Jan. 31, 2012	Jan. 30, 2014
ADT. Turn Table	TT100	0306	NA	NA
ADT. Tower	AT100	0306	NA	NA
Software	ADT_Radiated_V 7.6.15.9.2	NA	NA	NA
WOKEN RF cable	8D	CABLE-CH6-02	Apr. 30, 2012	Apr. 29, 2013
Agilent Spectrum	E4446A	MY46180403	Jun. 22, 2011	Jun. 21, 2012
Agilent Preamplifier	8449B	3008A01201	Feb. 29, 2012	Feb. 28, 2013
MITEQ Preamplifier	AMF-6F-260400- 33-8P	892164	Mar. 02, 2012	Mar. 01, 2013
Schwarzbeck Horn Antenna	BBHA-9170	BBHA9170190	Oct. 07, 2011	Oct. 06, 2012
Schwarzbeck Horn Antenna	BBHA-9120-D1	D130	May 18, 2012	May 17, 2013
ADT. Turn Table	TT100	0306	NA	NA
ADT. Tower	AT100	0306	NA	NA
Software	ADT_Radiated_V 7.6.15.9.2	NA	NA	NA
SUHNER RF cable	SF102	Cable-CH6	Aug. 19, 2011	Aug. 18, 2012
High Speed Peak Power Meter	ML2495A	0842014	Apr. 28, 2012	Apr. 27, 2013
Power Sensor	MA2411B	0738404	Apr. 28, 2012	Apr. 27, 2013

- NOTE:**
1. The calibration interval of the above test instruments is 12 months. And the calibrations are traceable to NML/ROC and NIST/USA.
 2. The calibration interval of the loop antenna is 24 months and the calibrations are traceable to NML/ROC and NIST/USA.
 3. The test was performed in Chamber No. 6.
 4. The Industry Canada Reference No. IC 7450E-6.
 5. The VCCI Site Registration No. G-257
 6. The FCC Site Registration No. 447212.
 7. The minimum 3dB beamwidth of antenna is 30 degrees for above 1GHz test.



A D T

4.1.3 TEST PROCEDURES

- a. The EUT was placed on the top of a rotating table 0.8 meters above the ground at a 3 meters semi-anechoic chamber. The table was rotated 360 degrees to determine the position of the highest radiation.
- b. The EUT was set 3 meters away from the interference-receiving antenna, which was mounted on the top of a variable-height antenna tower.
- c. The antenna is a broadband antenna, and its height is varied from one meter to four meters above the ground to determine the maximum value of the field strength. Both horizontal and vertical polarizations of the antenna are set to make the measurement.
- d. For each suspected emission, the EUT was arranged to its worst case and then the antenna was tuned to heights from 1 meter to 4 meters and the rotatable table was turned from 0 degrees to 360 degrees to find the maximum reading.
- e. The test-receiver system was set to Peak Detect Function and Specified Bandwidth with Maximum Hold Mode.
- f. If the emission level of the EUT in peak mode was lower than the limit specified, then testing could be stopped and the peak values of the EUT would be reported. Otherwise the emissions would be re-tested one by one using peak, quasi-peak or average method as specified and then reported in a data sheet.

NOTE:

1. The resolution bandwidth and video bandwidth of test receiver/spectrum analyzer is 120kHz for Quasi-peak detection at frequency below 1GHz.
2. The resolution bandwidth of test receiver/spectrum analyzer is 100kHz and video bandwidth is 300kHz for Peak detection at frequency above 1GHz.
3. The resolution bandwidth of test receiver/spectrum analyzer is 1MHz and the video bandwidth is 1kHz for Average detection (AV) at frequency above 1GHz.
4. All modes of operation were investigated and the worst-case emissions are reported.

4.1.4 DEVIATION FROM TEST STANDARD

No deviation.

4.1.5 TEST SETUP

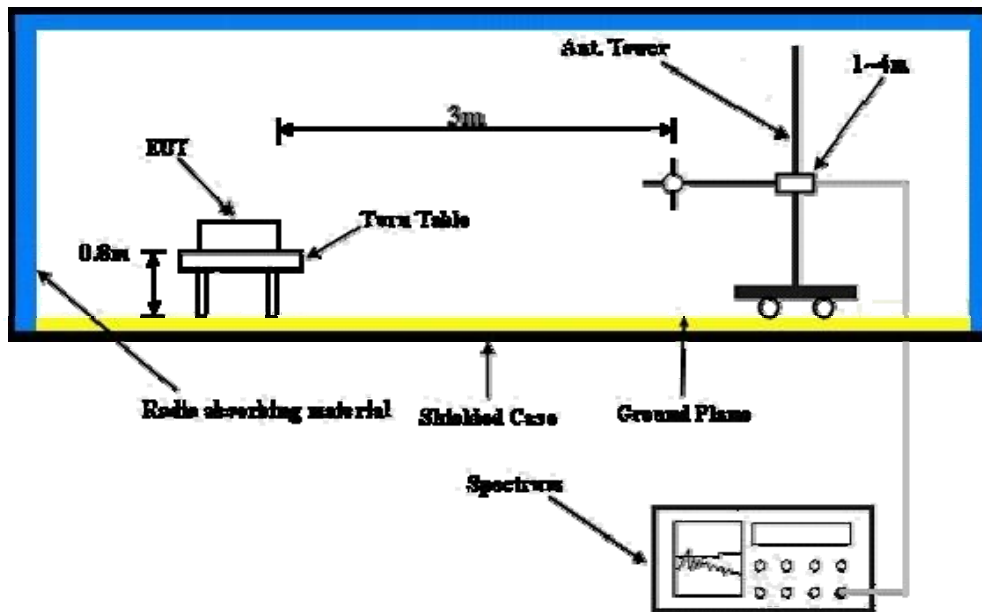

For the actual test configuration, please refer to the attached file (Test Setup Photo).

4.1.6 EUT OPERATING CONDITIONS

- Placed the EUT on the testing table.
- Prepared two notebooks to act as communication partners and placed them outside of testing area.
- The communication partner connected with EUT via a RJ45 cable and run a test program (provided by manufacturer) to enable EUT under transmission condition continuously at specific channel frequency.
- The communication partner sent data to EUT by command "PING".



A D T

4.1.7 TEST RESULTS

ABOVE 1GHz DATA :

802.11b

EUT TEST CONDITION		MEASUREMENT DETAIL	
CHANNEL	Channel 1	FREQUENCY RANGE	1 ~ 25GHz
INPUT POWER	120Vac, 60 Hz	DETECTOR FUNCTION	Peak (PK) Average (AV)
ENVIRONMENTAL CONDITIONS	24deg. C, 68%RH	TESTED BY	Chad Lee

ANTENNA POLARITY & TEST DISTANCE: HORIZONTAL AT 3 M								
NO.	FREQ. (MHz)	EMISSION LEVEL (dBuV/m)	LIMIT (dBuV/m)	MARGIN (dB)	ANTENNA HEIGHT (m)	TABLE ANGLE (Degree)	RAW VALUE (dBuV)	CORRECTION FACTOR (dB/m)
1	2390.00	64.5 PK	74.0	-9.5	1.05 H	107	34.30	30.24
2	2390.00	50.5 AV	54.0	-3.5	1.05 H	107	20.27	30.24
3	*2412.00	111.8 PK			1.05 H	107	81.47	30.33
4	*2412.00	109.0 AV			1.05 H	107	78.70	30.33
5	4824.00	47.3 PK	74.0	-26.7	1.00 H	254	10.62	36.64
6	4824.00	38.2 AV	54.0	-15.8	1.00 H	254	1.54	36.64
ANTENNA POLARITY & TEST DISTANCE: VERTICAL AT 3 M								
NO.	FREQ. (MHz)	EMISSION LEVEL (dBuV/m)	LIMIT (dBuV/m)	MARGIN (dB)	ANTENNA HEIGHT (m)	TABLE ANGLE (Degree)	RAW VALUE (dBuV)	CORRECTION FACTOR (dB/m)
1	2390.00	58.4 PK	74.0	-15.6	1.00 V	293	28.15	30.24
2	2390.00	44.9 AV	54.0	-9.1	1.00 V	293	14.63	30.24
3	*2412.00	102.0 PK			1.00 V	293	71.62	30.33
4	*2412.00	98.7 AV			1.00 V	293	68.38	30.33
5	4824.00	49.9 PK	74.0	-24.1	1.00 V	138	13.22	36.64
6	4824.00	44.6 AV	54.0	-9.5	1.00 V	138	7.91	36.64

REMARKS:

1. Emission level (dBuV/m) = Raw Value (dBuV) + Correction Factor (dB/m).
2. Correction Factor (dB/m) = Antenna Factor (dB/m) + Cable Factor (dB).
3. The other emission levels were very low against the limit.
4. Margin value = Emission level – Limit value.
5. “ * “: Fundamental frequency.



A D T

EUT TEST CONDITION		MEASUREMENT DETAIL	
CHANNEL	Channel 6	FREQUENCY RANGE	1 ~ 25GHz
INPUT POWER	120Vac, 60 Hz	DETECTOR FUNCTION	Peak (PK) Average (AV)
ENVIRONMENTAL CONDITIONS	24deg. C, 68%RH	TESTED BY	Chad Lee

ANTENNA POLARITY & TEST DISTANCE: HORIZONTAL AT 3 M								
NO.	FREQ. (MHz)	EMISSION LEVEL (dBuV/m)	LIMIT (dBuV/m)	MARGIN (dB)	ANTENNA HEIGHT (m)	TABLE ANGLE (Degree)	RAW VALUE (dBuV)	CORRECTION FACTOR (dB/m)
1	*2437.00	114.5 PK			1.06 H	80	84.08	30.42
2	*2437.00	111.5 AV			1.06 H	80	81.09	30.42
3	4874.00	51.7 PK	74.0	-22.3	1.00 H	189	14.93	36.77
4	4874.00	47.1 AV	54.0	-6.9	1.00 H	189	10.32	36.77

ANTENNA POLARITY & TEST DISTANCE: VERTICAL AT 3 M								
NO.	FREQ. (MHz)	EMISSION LEVEL (dBuV/m)	LIMIT (dBuV/m)	MARGIN (dB)	ANTENNA HEIGHT (m)	TABLE ANGLE (Degree)	RAW VALUE (dBuV)	CORRECTION FACTOR (dB/m)
1	*2437.00	108.3 PK			1.00 V	96	77.90	30.42
2	*2437.00	104.8 AV			1.00 V	96	74.33	30.42
3	4874.00	52.5 PK	74.0	-21.5	1.00 V	183	15.69	36.77
4	4874.00	50.5 AV	54.0	-3.5	1.00 V	183	13.72	36.77

REMARKS:

1. Emission level (dBuV/m) = Raw Value (dBuV) + Correction Factor (dB/m).
2. Correction Factor (dB/m) = Antenna Factor (dB/m) + Cable Factor (dB).
3. The other emission levels were very low against the limit.
4. Margin value = Emission level – Limit value.
5. “ * “: Fundamental frequency.



A D T

EUT TEST CONDITION		MEASUREMENT DETAIL	
CHANNEL	Channel 11	FREQUENCY RANGE	1 ~ 25GHz
INPUT POWER	120Vac, 60 Hz	DETECTOR FUNCTION	Peak (PK) Average (AV)
ENVIRONMENTAL CONDITIONS	24deg. C, 68%RH	TESTED BY	Chad Lee

ANTENNA POLARITY & TEST DISTANCE: HORIZONTAL AT 3 M								
NO.	FREQ. (MHz)	EMISSION LEVEL (dBuV/m)	LIMIT (dBuV/m)	MARGIN (dB)	ANTENNA HEIGHT (m)	TABLE ANGLE (Degree)	RAW VALUE (dBuV)	CORRECTION FACTOR (dB/m)
1	*2462.00	111.0 PK			1.00 H	182	80.52	30.50
2	*2462.00	107.6 AV			1.00 H	182	77.11	30.50
3	2483.50	60.8 PK	74.0	-13.2	1.00 H	182	30.26	30.57
4	2483.50	50.8 AV	54.0	-3.2	1.00 H	182	20.24	30.57
5	4924.00	43.0 PK	74.0	-31.0	1.00 H	16	6.13	36.90
6	4924.00	35.0 AV	54.0	-19.0	1.00 H	16	-1.94	36.90

ANTENNA POLARITY & TEST DISTANCE: VERTICAL AT 3 M								
NO.	FREQ. (MHz)	EMISSION LEVEL (dBuV/m)	LIMIT (dBuV/m)	MARGIN (dB)	ANTENNA HEIGHT (m)	TABLE ANGLE (Degree)	RAW VALUE (dBuV)	CORRECTION FACTOR (dB/m)
1	*2462.00	100.0 PK			1.00 V	144	69.51	30.50
2	*2462.00	96.0 AV			1.00 V	144	65.48	30.50
3	2483.50	57.4 PK	74.0	-16.6	1.00 V	144	26.79	30.57
4	2483.50	45.1 AV	54.0	-8.9	1.00 V	144	14.54	30.57
5	4924.00	48.4 PK	74.0	-25.6	1.00 V	284	11.49	36.90
6	4924.00	43.3 AV	54.0	-10.7	1.00 V	284	6.36	36.90

REMARKS:

1. Emission level (dBuV/m) = Raw Value (dBuV) + Correction Factor (dB/m).
2. Correction Factor (dB/m) = Antenna Factor (dB/m) + Cable Factor (dB).
3. The other emission levels were very low against the limit.
4. Margin value = Emission level – Limit value.
5. “ * “: Fundamental frequency.



A D T

802.11g

EUT TEST CONDITION		MEASUREMENT DETAIL	
CHANNEL	Channel 1	FREQUENCY RANGE	1 ~ 25GHz
INPUT POWER	120Vac, 60 Hz	DETECTOR FUNCTION	Peak (PK) Average (AV)
ENVIRONMENTAL CONDITIONS	24deg. C, 68%RH	TESTED BY	Chad Lee

ANTENNA POLARITY & TEST DISTANCE: HORIZONTAL AT 3 M								
NO.	FREQ. (MHz)	EMISSION LEVEL (dBuV/m)	LIMIT (dBuV/m)	MARGIN (dB)	ANTENNA HEIGHT (m)	TABLE ANGLE (Degree)	RAW VALUE (dBuV)	CORRECTION FACTOR (dB/m)
1	*2462.00	111.0 PK			1.00 H	103	80.53	30.50
2	*2462.00	98.6 AV			1.00 H	103	68.06	30.50
3	2483.50	65.9 PK	74.0	-8.1	1.00 H	103	35.35	30.57
4	2483.50	50.8 AV	54.0	-3.2	1.00 H	103	20.24	30.57
5	4924.00	45.1 PK	74.0	-28.9	1.00 H	10	8.21	36.90
6	4924.00	32.0 AV	54.0	-22.0	1.00 H	10	-4.87	36.90

ANTENNA POLARITY & TEST DISTANCE: VERTICAL AT 3 M								
NO.	FREQ. (MHz)	EMISSION LEVEL (dBuV/m)	LIMIT (dBuV/m)	MARGIN (dB)	ANTENNA HEIGHT (m)	TABLE ANGLE (Degree)	RAW VALUE (dBuV)	CORRECTION FACTOR (dB/m)
1	*2462.00	105.5 PK			1.00 V	161	75.02	30.50
2	*2462.00	91.8 AV			1.00 V	161	61.31	30.50
3	2483.50	57.9 PK	74.0	-16.1	1.00 V	161	27.34	30.57
4	2483.50	44.2 AV	54.0	-9.8	1.00 V	161	13.63	30.57
5	4924.00	45.1 PK	74.0	-28.9	1.00 V	98	8.22	36.90
6	4924.00	31.0 AV	54.0	-23.0	1.00 V	98	-5.91	36.90

REMARKS:

1. Emission level (dBuV/m) = Raw Value (dBuV) + Correction Factor (dB/m).
2. Correction Factor (dB/m) = Antenna Factor (dB/m) + Cable Factor (dB).
3. The other emission levels were very low against the limit.
4. Margin value = Emission level – Limit value.
5. “ * “: Fundamental frequency.



A D T

EUT TEST CONDITION		MEASUREMENT DETAIL	
CHANNEL	Channel 6	FREQUENCY RANGE	1 ~ 25GHz
INPUT POWER	120Vac, 60 Hz	DETECTOR FUNCTION	Peak (PK) Average (AV)
ENVIRONMENTAL CONDITIONS	24deg. C, 68%RH	TESTED BY	Chad Lee

ANTENNA POLARITY & TEST DISTANCE: HORIZONTAL AT 3 M								
NO.	FREQ. (MHz)	EMISSION LEVEL (dBuV/m)	LIMIT (dBuV/m)	MARGIN (dB)	ANTENNA HEIGHT (m)	TABLE ANGLE (Degree)	RAW VALUE (dBuV)	CORRECTION FACTOR (dB/m)
1	*2437.00	114.7 PK			1.00 H	112	84.30	30.42
2	*2437.00	101.5 AV			1.00 H	112	71.11	30.42
3	4874.00	45.0 PK	74.0	-29.1	1.00 H	69	8.18	36.77
4	4874.00	34.8 AV	54.0	-19.2	1.00 H	69	-1.96	36.77
ANTENNA POLARITY & TEST DISTANCE: VERTICAL AT 3 M								
NO.	FREQ. (MHz)	EMISSION LEVEL (dBuV/m)	LIMIT (dBuV/m)	MARGIN (dB)	ANTENNA HEIGHT (m)	TABLE ANGLE (Degree)	RAW VALUE (dBuV)	CORRECTION FACTOR (dB/m)
1	*2437.00	100.0 PK			1.00 V	93	69.54	30.42
2	*2437.00	86.8 AV			1.00 V	93	56.39	30.42
3	4874.00	43.8 PK	74.0	-30.2	1.00 V	16	7.02	36.77
4	4874.00	31.6 AV	54.0	-22.4	1.00 V	16	-5.19	36.77

REMARKS:

1. Emission level (dBuV/m) = Raw Value (dBuV) + Correction Factor (dB/m).
2. Correction Factor (dB/m) = Antenna Factor (dB/m) + Cable Factor (dB).
3. The other emission levels were very low against the limit.
4. Margin value = Emission level – Limit value.
5. “ * “: Fundamental frequency.



A D T

EUT TEST CONDITION		MEASUREMENT DETAIL	
CHANNEL	Channel 11	FREQUENCY RANGE	1 ~ 25GHz
INPUT POWER	120Vac, 60 Hz	DETECTOR FUNCTION	Peak (PK) Average (AV)
ENVIRONMENTAL CONDITIONS	24deg. C, 68%RH	TESTED BY	Chad Lee

ANTENNA POLARITY & TEST DISTANCE: HORIZONTAL AT 3 M								
NO.	FREQ. (MHz)	EMISSION LEVEL (dBuV/m)	LIMIT (dBuV/m)	MARGIN (dB)	ANTENNA HEIGHT (m)	TABLE ANGLE (Degree)	RAW VALUE (dBuV)	CORRECTION FACTOR (dB/m)
1	2390.00	68.7 PK	74.0	-5.3	1.03 H	152	38.47	30.24
2	2390.00	50.9 AV	54.0	-3.1	1.03 H	152	20.68	30.24
3	*2412.00	112.3 PK			1.03 H	152	81.92	30.33
4	*2412.00	99.0 AV			1.03 H	152	68.63	30.33
5	4824.00	45.8 PK	74.0	-28.2	1.00 H	100	9.18	36.64
6	4824.00	36.4 AV	54.0	-17.6	1.00 H	100	-0.25	36.64
ANTENNA POLARITY & TEST DISTANCE: VERTICAL AT 3 M								
NO.	FREQ. (MHz)	EMISSION LEVEL (dBuV/m)	LIMIT (dBuV/m)	MARGIN (dB)	ANTENNA HEIGHT (m)	TABLE ANGLE (Degree)	RAW VALUE (dBuV)	CORRECTION FACTOR (dB/m)
1	2390.00	64.3 PK	74.0	-9.8	1.00 V	96	34.01	30.24
2	2390.00	47.8 AV	54.0	-6.2	1.00 V	96	17.58	30.24
3	*2412.00	105.5 PK			1.00 V	96	75.19	30.33
4	*2412.00	92.5 AV			1.00 V	96	62.16	30.33
5	4824.00	43.9 PK	74.0	-30.1	1.00 V	173	7.28	36.64
6	4824.00	31.6 AV	54.0	-22.5	1.00 V	173	-5.09	36.64

REMARKS:

1. Emission level (dBuV/m) = Raw Value (dBuV) + Correction Factor (dB/m).
2. Correction Factor (dB/m) = Antenna Factor (dB/m) + Cable Factor (dB).
3. The other emission levels were very low against the limit.
4. Margin value = Emission level – Limit value.
5. “ * “: Fundamental frequency.



A D T

802.11n (20MHz)

EUT TEST CONDITION		MEASUREMENT DETAIL	
CHANNEL	Channel 1	FREQUENCY RANGE	1 ~ 25GHz
INPUT POWER	120Vac, 60 Hz	DETECTOR FUNCTION	Peak (PK) Average (AV)
ENVIRONMENTAL CONDITIONS	24deg. C, 68%RH	TESTED BY	Chad Lee

ANTENNA POLARITY & TEST DISTANCE: HORIZONTAL AT 3 M								
NO.	FREQ. (MHz)	EMISSION LEVEL (dBuV/m)	LIMIT (dBuV/m)	MARGIN (dB)	ANTENNA HEIGHT (m)	TABLE ANGLE (Degree)	RAW VALUE (dBuV)	CORRECTION FACTOR (dB/m)
1	2390.00	67.5 PK	74.0	-6.5	1.06 H	142	37.28	30.24
2	2390.00	50.2 AV	54.0	-3.8	1.06 H	142	19.92	30.24
3	*2412.00	110.5 PK			1.06 H	142	80.19	30.33
4	*2412.00	98.0 AV			1.06 H	142	67.63	30.33
5	4824.00	45.8 PK	74.0	-28.2	1.00 H	2	9.16	36.64
6	4824.00	35.6 AV	54.0	-18.4	1.00 H	2	-1.05	36.64

ANTENNA POLARITY & TEST DISTANCE: VERTICAL AT 3 M								
NO.	FREQ. (MHz)	EMISSION LEVEL (dBuV/m)	LIMIT (dBuV/m)	MARGIN (dB)	ANTENNA HEIGHT (m)	TABLE ANGLE (Degree)	RAW VALUE (dBuV)	CORRECTION FACTOR (dB/m)
1	2390.00	57.5 PK	74.0	-16.5	1.09 V	101	27.27	30.24
2	2390.00	45.8 AV	54.0	-8.2	1.09 V	101	15.59	30.24
3	*2412.00	106.2 PK			1.09 V	101	75.87	30.33
4	*2412.00	93.5 AV			1.09 V	101	63.20	30.33
5	4824.00	44.8 PK	74.0	-29.2	1.00 V	114	8.15	36.64
6	4824.00	32.0 AV	54.0	-22.0	1.00 V	114	-4.68	36.64

REMARKS:

1. Emission level (dBuV/m) = Raw Value (dBuV) + Correction Factor (dB/m).
2. Correction Factor (dB/m) = Antenna Factor (dB/m) + Cable Factor (dB).
3. The other emission levels were very low against the limit.
4. Margin value = Emission level – Limit value.
5. “ * “: Fundamental frequency.



A D T

EUT TEST CONDITION		MEASUREMENT DETAIL	
CHANNEL	Channel 6	FREQUENCY RANGE	1 ~ 25GHz
INPUT POWER	120Vac, 60 Hz	DETECTOR FUNCTION	Peak (PK) Average (AV)
ENVIRONMENTAL CONDITIONS	24deg. C, 68%RH	TESTED BY	Chad Lee

ANTENNA POLARITY & TEST DISTANCE: HORIZONTAL AT 3 M								
NO.	FREQ. (MHz)	EMISSION LEVEL (dBuV/m)	LIMIT (dBuV/m)	MARGIN (dB)	ANTENNA HEIGHT (m)	TABLE ANGLE (Degree)	RAW VALUE (dBuV)	CORRECTION FACTOR (dB/m)
1	*2437.00	117.5 PK			1.08 H	63	87.11	30.42
2	*2437.00	104.7 AV			1.08 H	63	74.27	30.42
3	4874.00	46.0 PK	74.0	-28.0	1.00 H	229	9.22	36.77
4	4874.00	36.4 AV	54.0	-17.6	1.00 H	229	-0.34	36.77
ANTENNA POLARITY & TEST DISTANCE: VERTICAL AT 3 M								
NO.	FREQ. (MHz)	EMISSION LEVEL (dBuV/m)	LIMIT (dBuV/m)	MARGIN (dB)	ANTENNA HEIGHT (m)	TABLE ANGLE (Degree)	RAW VALUE (dBuV)	CORRECTION FACTOR (dB/m)
1	*2437.00	111.3 PK			1.00 V	29	80.84	30.42
2	*2437.00	98.0 AV			1.00 V	29	67.59	30.42
3	4874.00	45.1 PK	74.0	-28.9	1.00 V	16	8.35	36.77
4	4874.00	32.0 AV	54.0	-22.0	1.00 V	16	-4.81	36.77

REMARKS:

1. Emission level (dBuV/m) = Raw Value (dBuV) + Correction Factor (dB/m).
2. Correction Factor (dB/m) = Antenna Factor (dB/m) + Cable Factor (dB).
3. The other emission levels were very low against the limit.
4. Margin value = Emission level – Limit value.
5. “ * “: Fundamental frequency.



A D T

EUT TEST CONDITION		MEASUREMENT DETAIL	
CHANNEL	Channel 11	FREQUENCY RANGE	1 ~ 25GHz
INPUT POWER	120Vac, 60 Hz	DETECTOR FUNCTION	Peak (PK) Average (AV)
ENVIRONMENTAL CONDITIONS	24deg. C, 68%RH	TESTED BY	Chad Lee

ANTENNA POLARITY & TEST DISTANCE: HORIZONTAL AT 3 M								
NO.	FREQ. (MHz)	EMISSION LEVEL (dBuV/m)	LIMIT (dBuV/m)	MARGIN (dB)	ANTENNA HEIGHT (m)	TABLE ANGLE (Degree)	RAW VALUE (dBuV)	CORRECTION FACTOR (dB/m)
1	*2462.00	113.0 PK			1.10 H	96	82.53	30.50
2	*2462.00	100.5 AV			1.10 H	96	70.02	30.50
3	2483.50	68.4 PK	74.0	-5.6	1.10 H	96	37.79	30.57
4	2483.50	50.7 AV	54.0	-3.3	1.10 H	96	20.17	30.57
5	4924.00	46.6 PK	74.0	-27.4	1.00 H	12	9.73	36.90
6	4924.00	36.7 AV	54.0	-17.3	1.00 H	12	-0.16	36.90
ANTENNA POLARITY & TEST DISTANCE: VERTICAL AT 3 M								
NO.	FREQ. (MHz)	EMISSION LEVEL (dBuV/m)	LIMIT (dBuV/m)	MARGIN (dB)	ANTENNA HEIGHT (m)	TABLE ANGLE (Degree)	RAW VALUE (dBuV)	CORRECTION FACTOR (dB/m)
1	*2462.00	108.9 PK			1.07 V	182	78.43	30.50
2	*2462.00	95.7 AV			1.07 V	182	65.24	30.50
3	2483.50	63.5 PK	74.0	-10.5	1.07 V	182	32.92	30.57
4	2483.50	46.8 AV	54.0	-7.2	1.07 V	182	16.25	30.57
5	4924.00	44.9 PK	74.0	-29.1	1.00 V	16	7.99	36.90
6	4924.00	31.9 AV	54.0	-22.1	1.00 V	16	-4.97	36.90

REMARKS:

1. Emission level (dBuV/m) = Raw Value (dBuV) + Correction Factor (dB/m).
2. Correction Factor (dB/m) = Antenna Factor (dB/m) + Cable Factor (dB).
3. The other emission levels were very low against the limit.
4. Margin value = Emission level – Limit value.
5. “ * “: Fundamental frequency.



A D T

802.11n (40MHz)

EUT TEST CONDITION		MEASUREMENT DETAIL	
CHANNEL	Channel 3	FREQUENCY RANGE	1 ~ 25GHz
INPUT POWER	120Vac, 60 Hz	DETECTOR FUNCTION	Peak (PK) Average (AV)
ENVIRONMENTAL CONDITIONS	24deg. C, 68%RH	TESTED BY	Chad Lee

ANTENNA POLARITY & TEST DISTANCE: HORIZONTAL AT 3 M								
NO.	FREQ. (MHz)	EMISSION LEVEL (dBuV/m)	LIMIT (dBuV/m)	MARGIN (dB)	ANTENNA HEIGHT (m)	TABLE ANGLE (Degree)	RAW VALUE (dBuV)	CORRECTION FACTOR (dB/m)
1	2390.00	69.1 PK	74.0	-4.9	1.00 H	166	38.88	30.24
2	2390.00	49.2 AV	54.0	-4.8	1.00 H	166	18.98	30.24
3	*2422.00	106.0 PK			1.00 H	166	75.60	30.36
4	*2422.00	90.8 AV			1.00 H	166	60.41	30.36
5	4844.00	47.0 PK	74.0	-27.0	1.00 H	253	10.27	36.69
6	4844.00	36.3 AV	54.0	-17.7	1.00 H	253	-0.43	36.69

ANTENNA POLARITY & TEST DISTANCE: VERTICAL AT 3 M								
NO.	FREQ. (MHz)	EMISSION LEVEL (dBuV/m)	LIMIT (dBuV/m)	MARGIN (dB)	ANTENNA HEIGHT (m)	TABLE ANGLE (Degree)	RAW VALUE (dBuV)	CORRECTION FACTOR (dB/m)
1	2390.00	63.5 PK	74.0	-10.5	1.11 V	86	33.29	30.24
2	2390.00	45.9 AV	54.0	-8.1	1.11 V	86	15.66	30.24
3	*2422.00	100.7 PK			1.11 V	86	70.35	30.36
4	*2422.00	85.8 AV			1.11 V	86	55.44	30.36
5	4844.00	45.8 PK	74.0	-28.2	1.00 V	16	9.14	36.69
6	4844.00	31.6 AV	54.0	-22.4	1.00 V	16	-5.06	36.69

REMARKS:

1. Emission level (dBuV/m) = Raw Value (dBuV) + Correction Factor (dB/m).
2. Correction Factor (dB/m) = Antenna Factor (dB/m) + Cable Factor (dB).
3. The other emission levels were very low against the limit.
4. Margin value = Emission level – Limit value.
5. “ * “: Fundamental frequency.



A D T

EUT TEST CONDITION		MEASUREMENT DETAIL	
CHANNEL	Channel 6	FREQUENCY RANGE	1 ~ 25GHz
INPUT POWER	120Vac, 60 Hz	DETECTOR FUNCTION	Peak (PK) Average (AV)
ENVIRONMENTAL CONDITIONS	24deg. C, 68%RH	TESTED BY	Chad Lee

ANTENNA POLARITY & TEST DISTANCE: HORIZONTAL AT 3 M								
NO.	FREQ. (MHz)	EMISSION LEVEL (dBuV/m)	LIMIT (dBuV/m)	MARGIN (dB)	ANTENNA HEIGHT (m)	TABLE ANGLE (Degree)	RAW VALUE (dBuV)	CORRECTION FACTOR (dB/m)
1	*2437.00	104.6 PK			1.07 H	169	74.14	30.42
2	*2437.00	98.9 AV			1.07 H	169	68.51	30.42
3	4874.00	46.6 PK	74.0	-27.4	1.00 H	9	9.82	36.77
4	4874.00	36.4 AV	54.0	-17.6	1.00 H	9	-0.39	36.77
ANTENNA POLARITY & TEST DISTANCE: VERTICAL AT 3 M								
NO.	FREQ. (MHz)	EMISSION LEVEL (dBuV/m)	LIMIT (dBuV/m)	MARGIN (dB)	ANTENNA HEIGHT (m)	TABLE ANGLE (Degree)	RAW VALUE (dBuV)	CORRECTION FACTOR (dB/m)
1	*2437.00	101.7 PK			1.00 V	95	71.30	30.42
2	*2437.00	86.9 AV			1.00 V	95	56.50	30.42
3	4874.00	45.0 PK	74.0	-29.0	1.00 V	16	8.19	36.77
4	4874.00	31.2 AV	54.0	-22.8	1.00 V	16	-5.54	36.77

REMARKS:

1. Emission level (dBuV/m) = Raw Value (dBuV) + Correction Factor (dB/m).
2. Correction Factor (dB/m) = Antenna Factor (dB/m) + Cable Factor (dB).
3. The other emission levels were very low against the limit.
4. Margin value = Emission level – Limit value.
5. “ * “: Fundamental frequency.



A D T

EUT TEST CONDITION		MEASUREMENT DETAIL	
CHANNEL	Channel 9	FREQUENCY RANGE	1 ~ 25GHz
INPUT POWER	120Vac, 60 Hz	DETECTOR FUNCTION	Peak (PK) Average (AV)
ENVIRONMENTAL CONDITIONS	24deg. C, 68%RH	TESTED BY	Chad Lee

ANTENNA POLARITY & TEST DISTANCE: HORIZONTAL AT 3 M								
NO.	FREQ. (MHz)	EMISSION LEVEL (dBuV/m)	LIMIT (dBuV/m)	MARGIN (dB)	ANTENNA HEIGHT (m)	TABLE ANGLE (Degree)	RAW VALUE (dBuV)	CORRECTION FACTOR (dB/m)
1	*2452.00	104.8 PK			1.00 H	159	74.32	30.47
2	*2452.00	90.1 AV			1.00 H	159	59.64	30.47
3	2483.50	68.7 PK	74.0	-5.3	1.00 H	159	38.15	30.57
4	2483.50	50.0 AV	54.0	-4.0	1.00 H	159	19.41	30.57
5	4904.00	46.1 PK	74.0	-27.9	1.00 H	19	9.28	36.85
6	4904.00	36.8 AV	54.0	-17.2	1.00 H	19	-0.03	36.85
ANTENNA POLARITY & TEST DISTANCE: VERTICAL AT 3 M								
NO.	FREQ. (MHz)	EMISSION LEVEL (dBuV/m)	LIMIT (dBuV/m)	MARGIN (dB)	ANTENNA HEIGHT (m)	TABLE ANGLE (Degree)	RAW VALUE (dBuV)	CORRECTION FACTOR (dB/m)
1	*2452.00	100.0 PK			1.00 V	182	69.49	30.47
2	*2452.00	83.7 AV			1.00 V	182	53.27	30.47
3	2483.50	66.9 PK	74.0	-7.1	1.00 V	182	36.35	30.57
4	2483.50	48.9 AV	54.0	-5.1	1.00 V	182	18.36	30.57
5	4904.00	45.4 PK	74.0	-28.6	1.00 V	12	8.51	36.85
6	4904.00	31.3 AV	54.0	-22.8	1.00 V	12	-5.60	36.85

REMARKS:

1. Emission level (dBuV/m) = Raw Value (dBuV) + Correction Factor (dB/m).
2. Correction Factor (dB/m) = Antenna Factor (dB/m) + Cable Factor (dB).
3. The other emission levels were very low against the limit.
4. Margin value = Emission level – Limit value.
5. “ * “: Fundamental frequency.



A D T

BELOW 1GHz WORST-CASE DATA : 802.11b

EUT TEST CONDITION		MEASUREMENT DETAIL	
CHANNEL	Channel 6	FREQUENCY RANGE	Below 1000MHz
INPUT POWER	120Vac, 60 Hz	DETECTOR FUNCTION	Quasi-Peak
ENVIRONMENTAL CONDITIONS	24deg. C, 64%RH	TESTED BY	Chad Lee

ANTENNA POLARITY & TEST DISTANCE: HORIZONTAL AT 3 M								
NO.	FREQ. (MHz)	EMISSION LEVEL (dBuV/m)	LIMIT (dBuV/m)	MARGIN (dB)	ANTENNA HEIGHT (m)	TABLE ANGLE (Degree)	RAW VALUE (dBuV)	CORRECTION FACTOR (dB/m)
1	125.01	33.2 QP	43.5	-10.3	1.43 H	73	21.07	12.17
2	374.66	32.6 QP	46.0	-13.4	1.00 H	226	15.00	17.64
3	599.59	38.4 QP	46.0	-7.6	1.50 H	250	15.18	23.26
4	749.87	34.2 QP	46.0	-11.8	1.25 H	262	8.77	25.41
5	894.81	37.5 QP	46.0	-8.5	1.21 H	73	9.88	27.66
6	999.52	44.5 QP	54.0	-9.5	1.00 H	106	15.72	28.74

ANTENNA POLARITY & TEST DISTANCE: VERTICAL AT 3 M								
NO.	FREQ. (MHz)	EMISSION LEVEL (dBuV/m)	LIMIT (dBuV/m)	MARGIN (dB)	ANTENNA HEIGHT (m)	TABLE ANGLE (Degree)	RAW VALUE (dBuV)	CORRECTION FACTOR (dB/m)
1	38.73	36.6 QP	40.0	-3.4	1.00 V	280	23.44	13.16
2	89.14	38.1 QP	43.5	-5.4	1.25 V	262	29.62	8.44
3	97.38	37.2 QP	43.5	-6.3	1.00 V	262	28.15	9.04
4	460.46	37.7 QP	46.0	-8.4	1.00 V	241	17.68	19.97
5	499.73	32.2 QP	46.0	-13.8	1.18 V	121	11.17	21.03
6	599.59	35.0 QP	46.0	-11.0	1.00 V	118	11.71	23.26

REMARKS:

1. Emission level (dBuV/m) = Raw Value (dBuV) + Correction Factor (dB/m).
2. Correction Factor (dB/m) = Antenna Factor (dB/m) + Cable Factor (dB).
3. The other emission levels were very low against the limit.
4. Margin value = Emission level – Limit value.



4.2 CONDUCTED EMISSION MEASUREMENT

4.2.1 LIMITS OF CONDUCTED EMISSION MEASUREMENT

FREQUENCY OF EMISSION (MHz)	CONDUCTED LIMIT (dBµV)	
	Quasi-peak	Average
0.15 ~ 0.5	66 to 56	56 to 46
0.5 ~ 5	56	46
5 ~ 30	60	50

- NOTE:**
1. The lower limit shall apply at the transition frequencies.
 2. The limit decreases in line with the logarithm of the frequency in the range of 0.15 to 0.50MHz.
 3. All emanations from a class A/B digital device or system, including any network of conductors and apparatus connected thereto, shall not exceed the level of field strengths specified above.

4.2.2 TEST INSTRUMENTS

DESCRIPTION & MANUFACTURER	MODEL NO.	SERIAL NO.	DATE OF CALIBRATION	DUE DATE OF CALIBRATION
Test Receiver ROHDE & SCHWARZ	ESCS30	100289	Nov. 19, 2011	Nov. 18, 2012
RF signal cable Woken	5D-FB	Cable-HYCO2-01	Dec. 22, 2011	Dec. 21, 2012
LISN ROHDE & SCHWARZ (EUT)	ESH2-Z5	100100	Dec. 30, 2011	Dec. 29, 2012
LISN ROHDE & SCHWARZ (Peripheral)	ESH3-Z5	100312	Jul. 07, 2011	Jul. 06, 2012
Software ADT	BV ADT_Cond_ V7.3.7.3	NA	NA	NA

- NOTE:**
1. The calibration interval of the above test instruments is 12 months and the calibrations are traceable to NML/ROC and NIST/USA.
 2. The test was performed in HwaYa Shielded Room 2.
 3. The VCCI Site Registration No. is C-2047.

4.2.3 TEST PROCEDURES

- a. The EUT was placed 0.4 meters from the conducting wall of the shielded room with EUT being connected to the power mains through a line impedance stabilization network (LISN). Other support units were connected to the power mains through another LISN. The two LISNs provide 50 ohm/ 50uH of coupling impedance for the measuring instrument.
- b. Both lines of the power mains connected to the EUT were checked for maximum conducted interference.
- c. The frequency range from 150kHz to 30MHz was searched. Emission levels under (Limit - 20dB) was not recorded.

NOTE: All modes of operation were investigated and the worst-case emissions are reported.

4.2.4 DEVIATION FROM TEST STANDARD

No deviation.

4.2.5 TEST SETUP

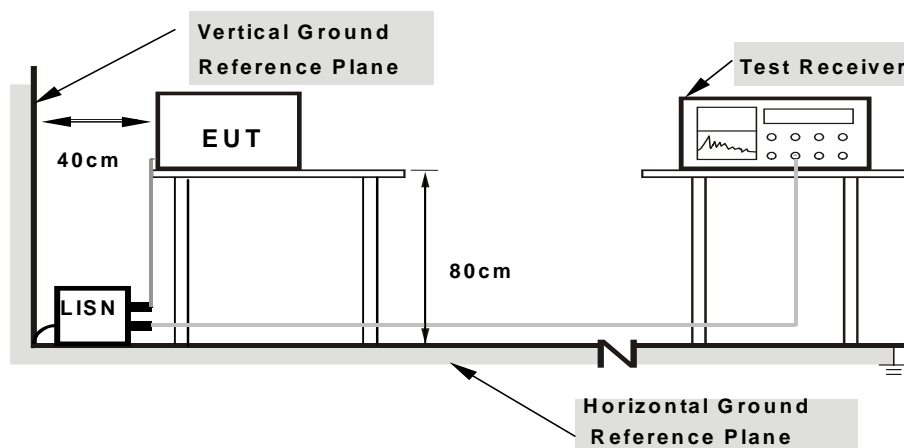

- Note:**
- 1.Support units were connected to second LISN.
 - 2.Both of LISNs (AMN) are 80 cm from EUT and at least 80 from other units and other metal planes

For the actual test configuration, please refer to the attached file (Test Setup Photo).

4.2.6 EUT OPERATING CONDITIONS

Same as 4.1.6.

4.2.7 TEST RESULTS

CONDUCTED WORST-CASE DATA : 802.11b

PHASE	Line 1	6dB BANDWIDTH	9kHz
--------------	--------	----------------------	------

No	Freq. [MHz]	Corr. Factor (dB)	Reading Value [dB (uV)]		Emission Level [dB (uV)]		Limit [dB (uV)]		Margin (dB)	
			Q.P.	AV.	Q.P.	AV.	Q.P.	AV.	Q.P.	AV.
1	0.16562	0.17	49.27	27.58	49.44	27.75	65.18	55.18	-15.74	-27.43
2	0.19297	0.17	47.18	34.69	47.35	34.86	63.91	53.91	-16.56	-19.05
3	0.58359	0.21	44.81	35.80	45.02	36.01	56.00	46.00	-10.98	-9.99
4	2.61328	0.33	30.76	23.89	31.09	24.22	56.00	46.00	-24.91	-21.78
5	6.15234	0.42	28.88	21.12	29.30	21.54	60.00	50.00	-30.70	-28.46
6	14.67578	0.60	28.38	22.46	28.98	23.06	60.00	50.00	-31.02	-26.94

REMARKS:

1. Q.P. and AV. are abbreviations of quasi-peak and average individually.
2. The emission levels of other frequencies were very low against the limit.
3. Margin value = Emission level - Limit value
4. Correction factor = Insertion loss + Cable loss
5. Emission Level = Correction Factor + Reading Value.

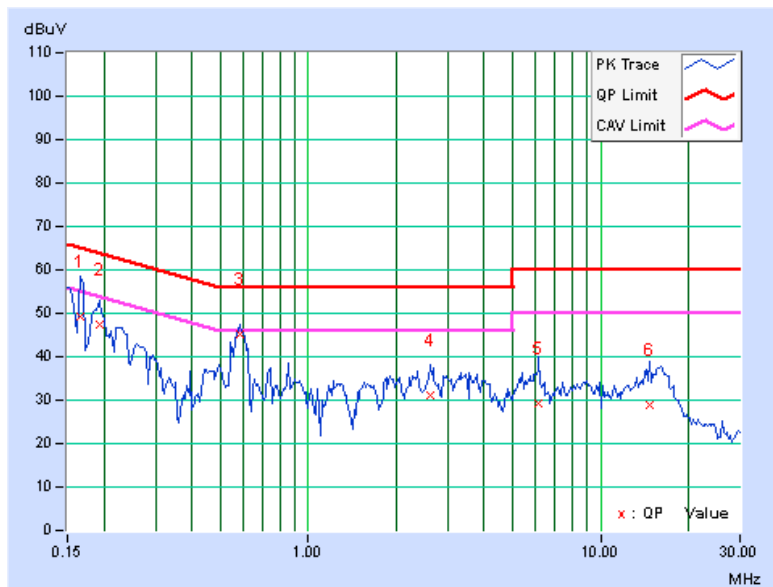

PHASE	Line 2	6dB BANDWIDTH	9kHz
-------	--------	---------------	------

No	Freq. [MHz]	Corr. Factor (dB)	Reading Value [dB (uV)]		Emission Level [dB (uV)]		Limit [dB (uV)]		Margin (dB)	
			Q.P.	AV.	Q.P.	AV.	Q.P.	AV.	Q.P.	AV.
1	0.15391	0.17	54.73	43.40	54.90	43.57	65.79	55.79	-10.89	-12.22
2	0.21641	0.15	41.17	26.05	41.32	26.20	62.96	52.96	-21.63	-26.75
3	0.59141	0.18	47.14	40.63	47.32	40.81	56.00	46.00	-8.68	-5.19
4	0.86484	0.19	32.47	23.66	32.66	23.85	56.00	46.00	-23.34	-22.15
5	7.05078	0.48	25.78	18.23	26.26	18.71	60.00	50.00	-33.74	-31.29
6	16.06250	0.72	29.05	22.87	29.77	23.59	60.00	50.00	-30.23	-26.41

REMARKS:

1. Q.P. and AV. are abbreviations of quasi-peak and average individually.
2. The emission levels of other frequencies were very low against the limit.
3. Margin value = Emission level - Limit value
4. Correction factor = Insertion loss + Cable loss
5. Emission Level = Correction Factor + Reading Value.

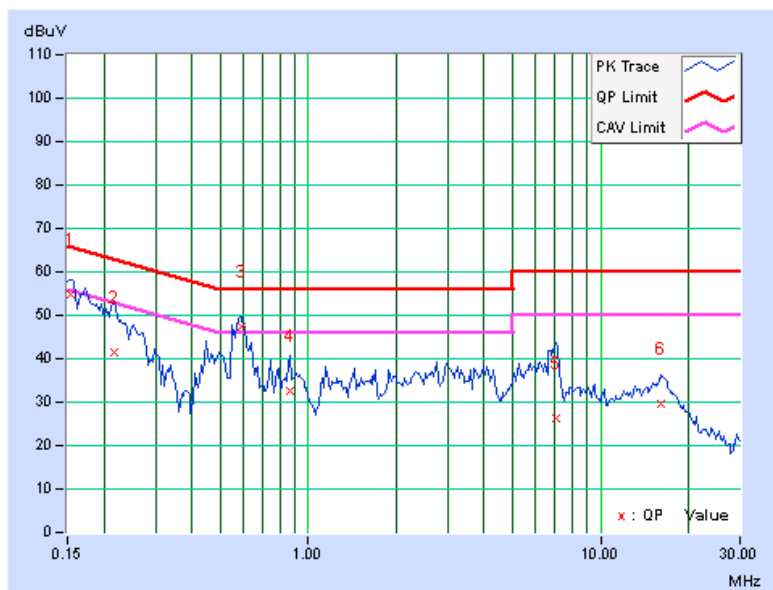

4.3 6dB BANDWIDTH MEASUREMENT

4.3.1 LIMITS OF 6dB BANDWIDTH MEASUREMENT

The minimum of 6dB Bandwidth Measurement is 0.5 MHz.

4.3.2 TEST SETUP

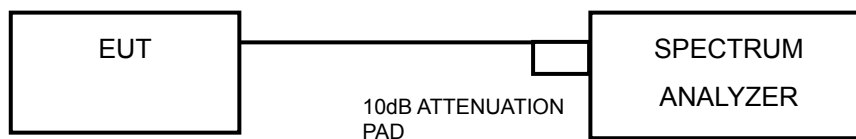

4.3.3 TEST INSTRUMENTS

Refer to section 4.1.2 to get information of above instrument.

4.3.4 TEST PROCEDURE

- a. Set resolution bandwidth (RBW) = approximately 1% of the emission bandwidth
- b. Set the video bandwidth (VBW) $\geq 3 \times$ RBW, Detector = Peak.
- c. Trace mode = max hold.
- d. Sweep = auto couple.
- e. Measure the maximum width of the emission that is constrained by the frequencies associated with the two amplitude points (upper and lower) that are attenuated by 6 dB relative to the maximum level measured in the fundamental emission

4.3.5 DEVIATION FROM TEST STANDARD

No deviation.

4.3.6 EUT OPERATING CONDITIONS

The software provided by client to enable the EUT under transmission condition continuously at lowest, middle and highest channel frequencies individually.



4.3.7 TEST RESULTS

802.11b

CHANNEL	FREQUENCY (MHz)	6dB BANDWIDTH (MHz)		MINIMUM LIMIT (MHz)	PASS / FAIL
		CHAIN 0	CHAIN 1		
1	2412	10.29	10.29	0.5	PASS
6	2437	10.27	10.26	0.5	PASS
11	2462	10.27	10.26	0.5	PASS

802.11g

CHANNEL	FREQUENCY (MHz)	6dB BANDWIDTH (MHz)		MINIMUM LIMIT (MHz)	PASS / FAIL
		CHAIN 0	CHAIN 1		
1	2412	16.43	16.58	0.5	PASS
6	2437	16.53	16.55	0.5	PASS
11	2462	16.48	16.56	0.5	PASS

802.11n (20MHz)

CHANNEL	FREQUENCY (MHz)	6dB BANDWIDTH (MHz)		MINIMUM LIMIT (MHz)	PASS / FAIL
		CHAIN 0	CHAIN 1		
1	2412	17.73	17.79	0.5	PASS
6	2437	17.71	17.79	0.5	PASS
11	2462	17.71	17.78	0.5	PASS

802.11n (40MHz)

CHANNEL	FREQUENCY (MHz)	6dB BANDWIDTH (MHz)		MINIMUM LIMIT (MHz)	PASS / FAIL
		CHAIN 0	CHAIN 1		
3	2422	37.28	36.73	0.5	PASS
6	2437	37.25	36.76	0.5	PASS
9	2452	37.04	36.73	0.5	PASS

4.4 CONDUCTED OUTPUT POWER

4.4.1 LIMITS OF CONDUCTED OUTPUT POWER MEASUREMENT

For systems using digital modulation in the 2400–2483.5 MHz bands: 1 Watt (30dBm)

4.4.2 TEST SETUP

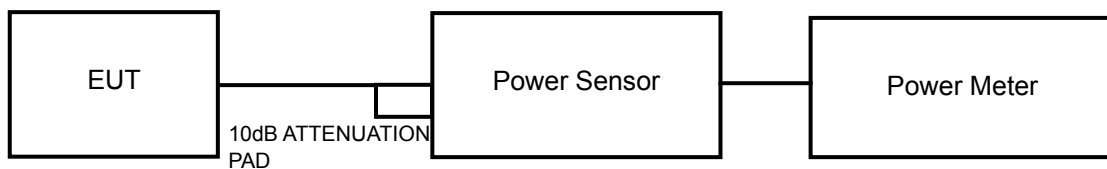

4.4.3 TEST INSTRUMENTS

Refer to section 4.1.2 to get information of above instrument.

4.4.4 TEST PROCEDURES

An average power sensor was used on the output port of the EUT. A power meter was used to read the response of the average power sensor. Record the average power level.

4.4.5 DEVIATION FROM TEST STANDARD

No deviation.

4.4.6 EUT OPERATING CONDITIONS

Same as Item 4.3.6.



A D T

4.4.7 TEST RESULTS

802.11b

CHAN.	FREQUE NCY (MHz)	AVG. POWER (dBm)		TOTAL POWER (mW)	TOTAL POWER (dBm)	LIMIT (dBm)	PASS / FAIL
		CHAIN 0	CHAIN 1				
1	2412	17.94	18.24	128.9	21.1	30	PASS
6	2437	22.81	22.92	386.9	25.9	30	PASS
11	2462	17.87	17.95	123.6	20.9	30	PASS

802.11g

CHAN.	FREQUE NCY (MHz)	AVG. POWER (dBm)		TOTAL POWER (mW)	TOTAL POWER (dBm)	LIMIT (dBm)	PASS / FAIL
		CHAIN 0	CHAIN 1				
1	2412	14.88	15.14	63.4	18.0	30	PASS
6	2437	20.86	21.09	250.4	24.0	30	PASS
11	2462	14.76	15.02	61.7	17.9	30	PASS

802.11n (20MHz)

CHAN.	FREQUE NCY (MHz)	AVG. POWER (dBm)		TOTAL POWER (mW)	TOTAL POWER (dBm)	LIMIT (dBm)	PASS / FAIL
		CHAIN 0	CHAIN 1				
1	2412	14.76	15.18	62.9	18.0	30	PASS
6	2437	20.81	20.92	244.1	23.9	30	PASS
11	2462	15.07	15.25	65.6	18.2	30	PASS

802.11n (40MHz)

CHAN.	FREQUE NCY (MHz)	AVG. POWER (dBm)		TOTAL POWER (mW)	TOTAL POWER (dBm)	LIMIT (dBm)	PASS / FAIL
		CHAIN 0	CHAIN 1				
3	2422	12.12	12.06	32.4	15.1	30	PASS
6	2437	14.82	15.08	62.5	18.0	30	PASS
9	2452	11.95	11.91	31.2	14.9	30	PASS

4.5 POWER SPECTRAL DENSITY MEASUREMENT

4.5.1 LIMITS OF POWER SPECTRAL DENSITY MEASUREMENT

The Maximum of Power Spectral Density Measurement is 8dBm.

4.5.2 TEST SETUP

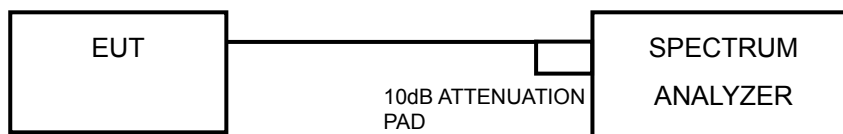

4.5.3 TEST INSTRUMENTS

Refer to section 4.1.2 to get information of above instrument.

4.5.4 TEST PROCEDURE

1. Set the RBW = 100 kHz.
2. Set the VBW \geq 300 kHz.
3. Detector = rms.
4. Sweep time = 26 second.
5. Perform the measurement over a single sweep.
6. Use the peak marker function to determine the maximum power level in any 100 kHz band segment within the fundamental EBW.
7. Scale the observed power level to an equivalent value in 3 kHz by adjusting (reducing) the measured power by a bandwidth correction factor (BWCF) where $BWCF = 10\log(3 \text{ kHz}/100\text{kHz})$.

4.5.5 DEVIATION FROM TEST STANDARD

No deviation.

4.5.6 EUT OPERATING CONDITION

Same as Item 4.3.6



A D T

4.5.7 TEST RESULTS

802.11b

TX chain	Channel	FREQ. (MHz)	PSD (dBm/100kHz)	PSD (dBm/3kHz)	10 log (N=2) dB	Total PSD (dBm/3kHz)	Limit (dBm/3kHz)	PASS /FAIL
0	1	2412	-0.26	-15.49	3.01	-12.48	8	PASS
	6	2437	4.12	-11.11	3.01	-8.10	8	PASS
	11	2462	-0.50	-15.73	3.01	-12.72	8	PASS
1	1	2412	0.02	-15.21	3.01	-12.20	8	PASS
	6	2437	4.58	-10.65	3.01	-7.64	8	PASS
	11	2462	-0.29	-15.52	3.01	-12.51	8	PASS

802.11g

TX chain	Channel	FREQ. (MHz)	PSD (dBm/100kHz)	PSD (dBm/3kHz)	10 log (N=2) dB	Total PSD (dBm/3kHz)	Limit (dBm/3kHz)	PASS /FAIL
0	1	2412	-5.77	-21.00	3.01	-17.99	8	PASS
	6	2437	0.07	-15.16	3.01	-12.15	8	PASS
	11	2462	-5.99	-21.22	3.01	-18.21	8	PASS
1	1	2412	-5.58	-20.81	3.01	-17.80	8	PASS
	6	2437	0.27	-14.96	3.01	-11.95	8	PASS
	11	2462	-5.62	-20.85	3.01	-17.84	8	PASS

802.11n (20MHz)

TX chain	Channel	FREQ. (MHz)	PSD (dBm/100kHz)	PSD (dBm/3kHz)	10 log (N=2) dB	Total PSD (dBm/3kHz)	Limit (dBm/3kHz)	PASS /FAIL
0	1	2412	-5.95	-21.18	3.01	-18.17	8	PASS
	6	2437	0.14	-15.09	3.01	-12.08	8	PASS
	11	2462	-5.82	-21.05	3.01	-18.04	8	PASS
1	1	2412	-5.69	-20.92	3.01	-17.91	8	PASS
	6	2437	0.23	-15.00	3.01	-11.99	8	PASS
	11	2462	-5.86	-21.09	3.01	-18.08	8	PASS

802.11n (40MHz)

TX chain	Channel	FREQ. (MHz)	PSD (dBm/100kHz)	PSD (dBm/3kHz)	10 log (N=2) dB	Total PSD (dBm/3kHz)	Limit (dBm/3kHz)	PASS /FAIL
0	3	2422	-11.86	-27.09	3.01	-24.08	8	PASS
	6	2437	-8.83	-24.06	3.01	-21.05	8	PASS
	9	2452	-12.01	-27.24	3.01	-24.23	8	PASS
1	3	2422	-11.43	-26.66	3.01	-23.65	8	PASS
	6	2437	-8.64	-23.87	3.01	-20.86	8	PASS
	9	2452	-11.84	-27.07	3.01	-24.06	8	PASS

4.6 CONDUCTED OUT OF BAND EMISSION MEASUREMENT

4.6.1 LIMITS OF CONDUCTED OUT OF BAND EMISSION MEASUREMENT

Below -30dB of the highest emission level of operating band (in 100kHz Resolution Bandwidth).

4.6.2 TEST SETUP

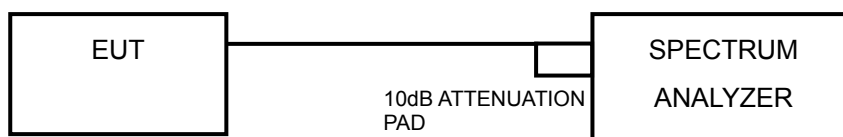

4.6.3 TEST INSTRUMENTS

Refer to section 4.1.2 to get information of above instrument.

4.6.4 TEST PROCEDURE

MEASUREMENT PROCEDURE REF

1. Set the RBW = 100 kHz.
2. Set the VBW \geq 300 kHz.
3. Detector = rms.
4. Sweep time = 26 second.
5. Perform the measurement over a single sweep.
6. Use the peak marker function to determine the maximum power level in any 100 kHz band segment within the fundamental EBW.



A D T

MEASUREMENT PROCEDURE OOB

1. Set RBW = 100 kHz.
2. Set VBW \geq 300 kHz.
3. Set span to encompass the spectrum to be examined.
4. Detector = rms.
5. Sweep time = 26 second.
6. Perform the measurement over a single sweep.

4.6.5 DEVIATION FROM TEST STANDARD

No deviation.

4.6.6 EUT OPERATING CONDITION

Same as Item 4.3.6

4.6.7 TEST RESULTS

The conducted emission test is performed on each TX port of operating mode without summing or adding $10\log(N)$ since the limit is relative emission limit. Only worst data of each operating mode is presented.

The spectrum plots are attached on the following pages. D1 line indicates the highest level, and D2 line indicates the 20dB offset below D1. It shows compliance with the requirement.

4.6.8 TEST RESULTS

802.11b

CH 1

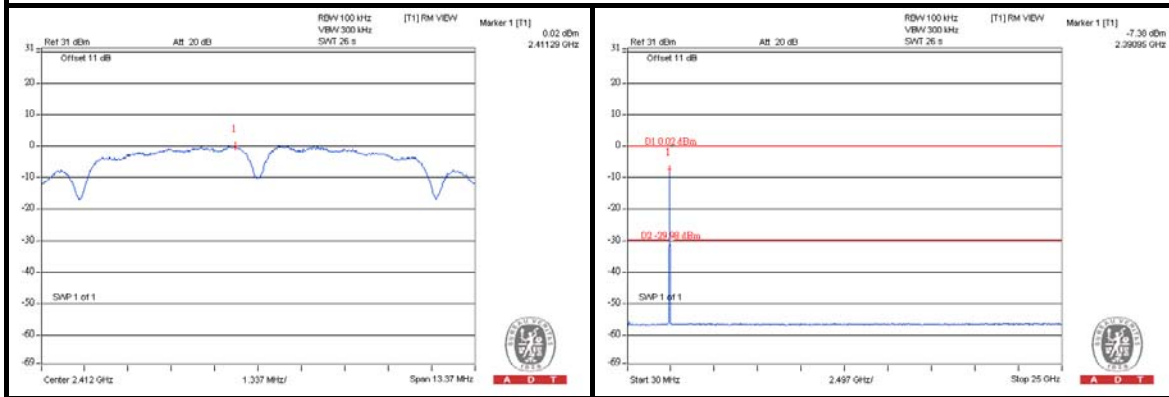

CH 6

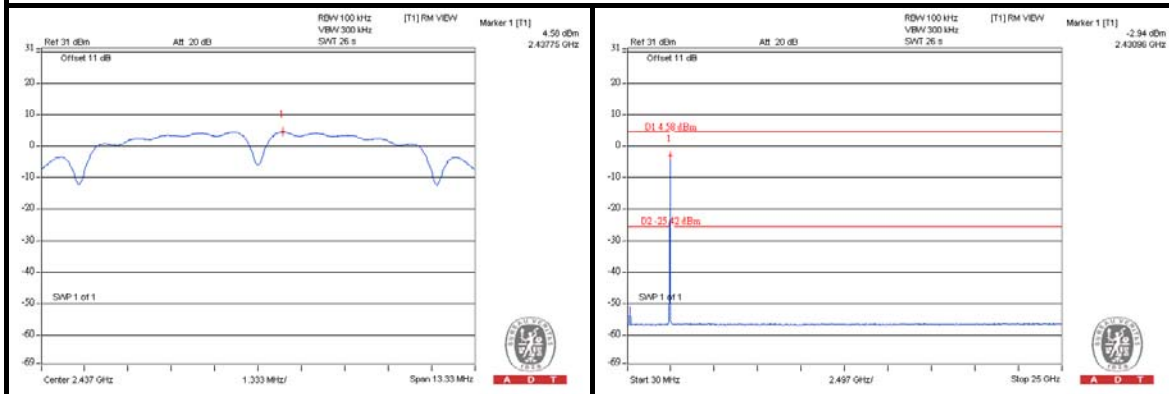

CH 11

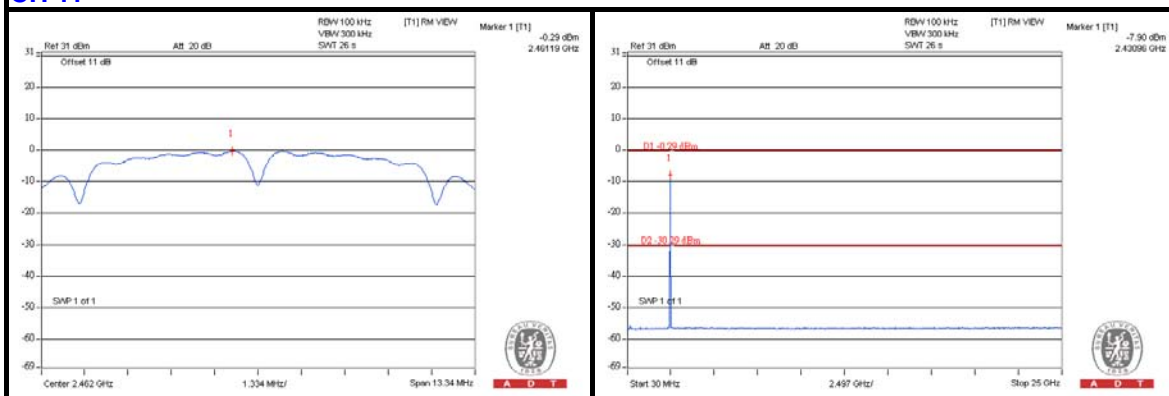

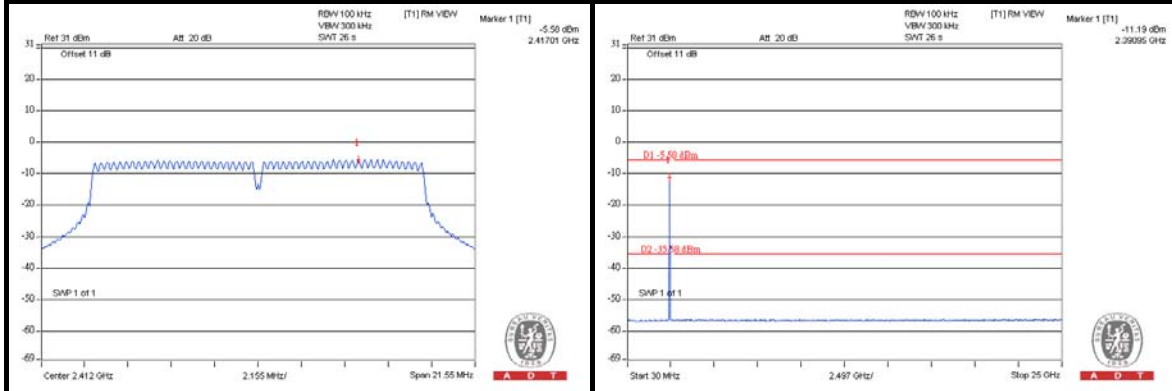
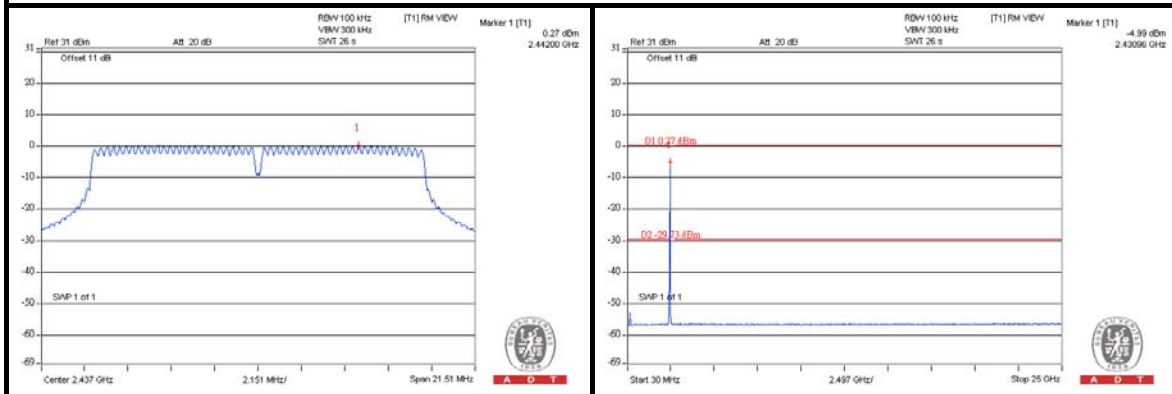
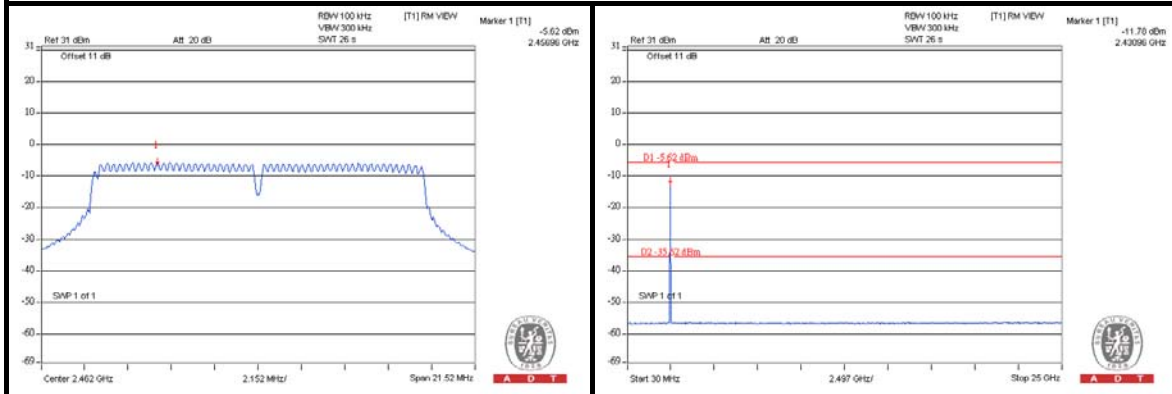
802.11g**CH 1****CH 6****CH 11**

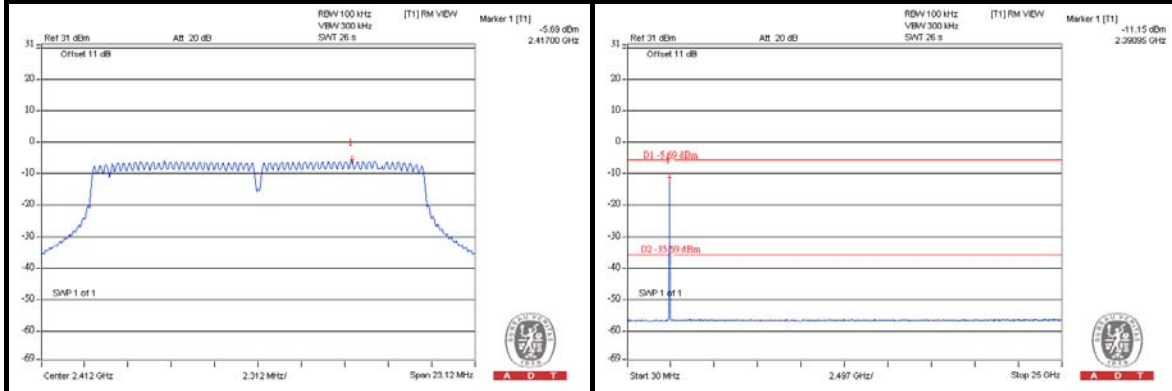
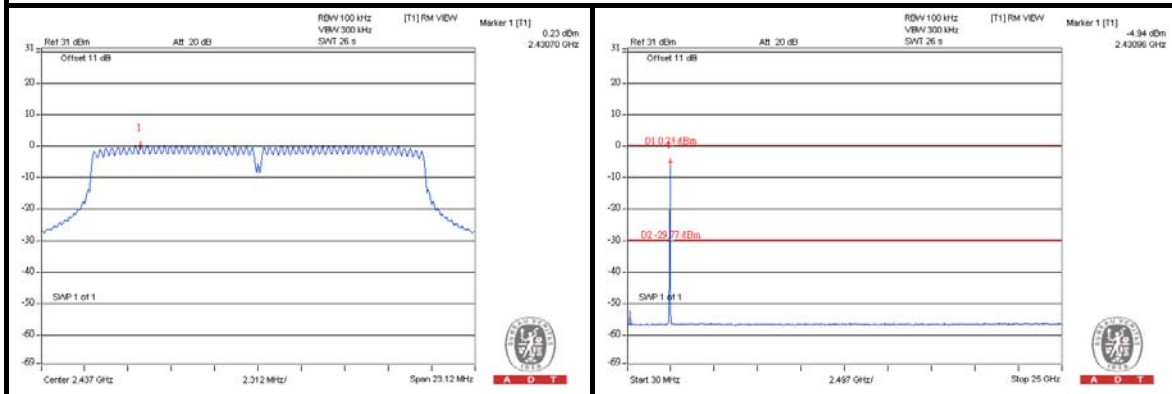
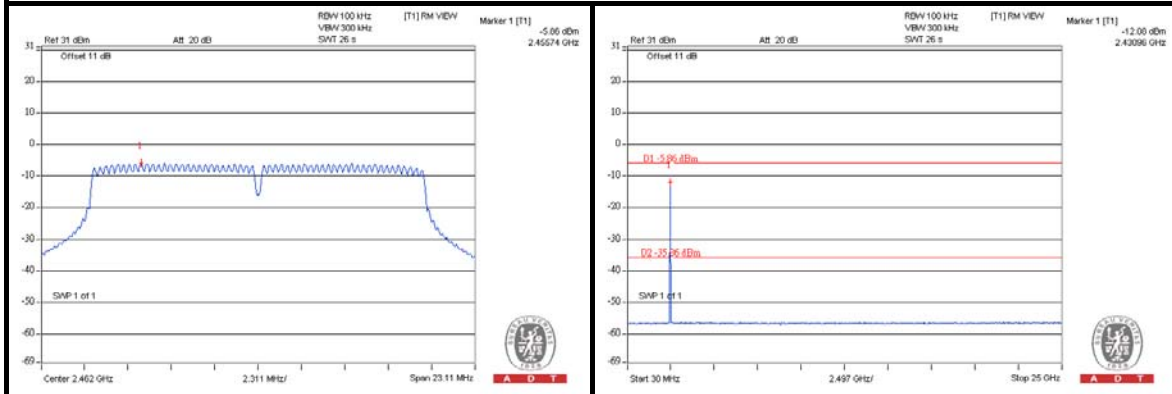
802.11n (20MHz)**CH 1****CH 6****CH 11**

802.11n (40MHz)

CH 3

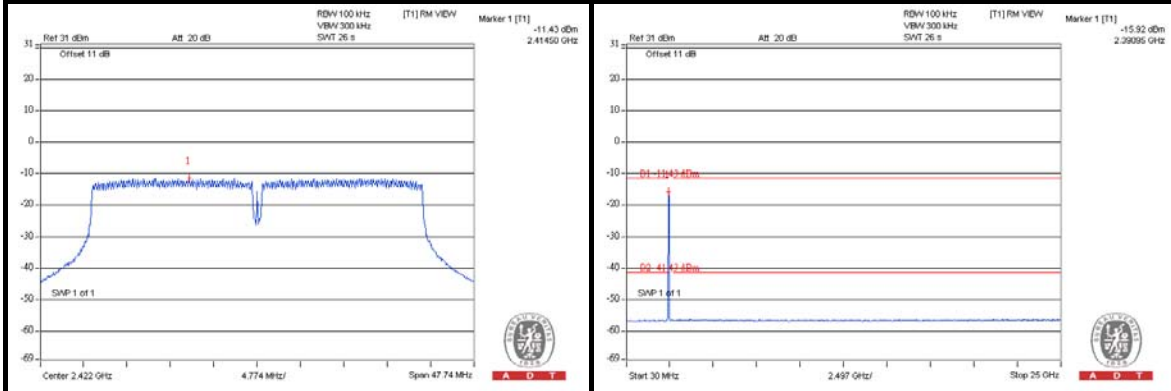

CH 6

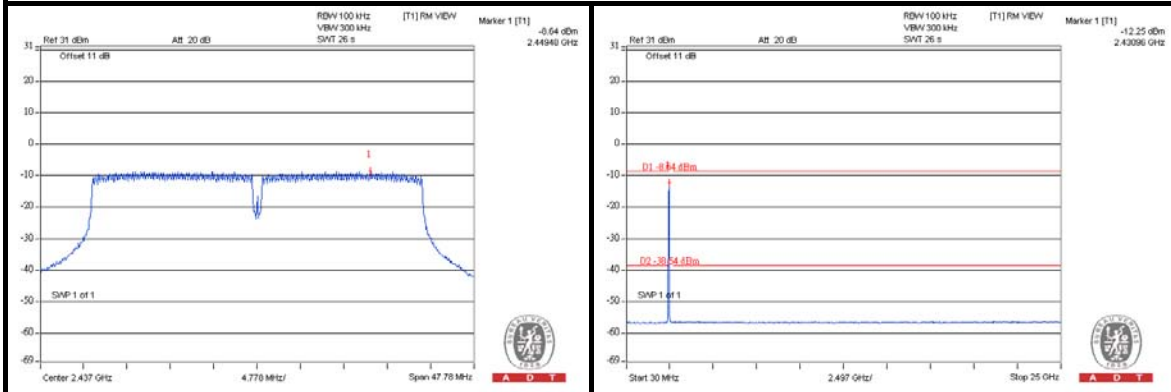

CH 9

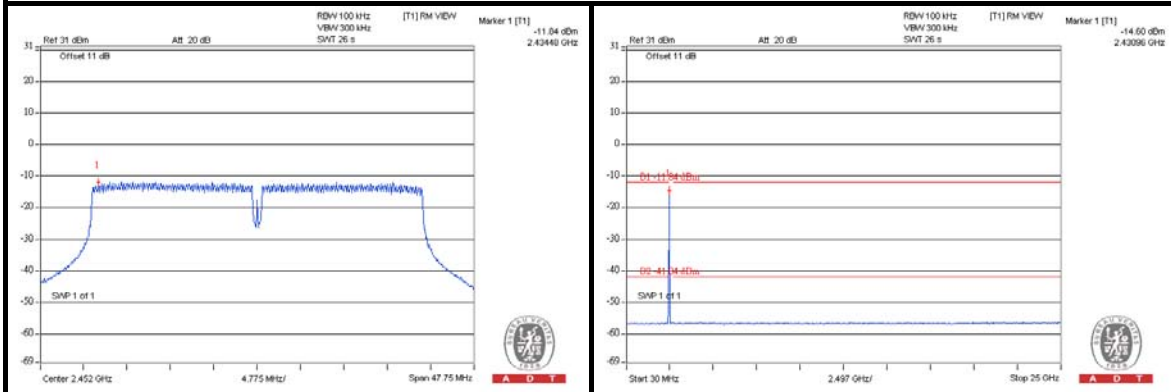



A D T

5. TEST TYPES AND RESULTS (FOR 5.0GHz BAND)

5.1 RADIATED EMISSION MEASUREMENT

5.1.1 LIMITS OF RADIATED EMISSION MEASUREMENT

Radiated emissions which fall in the restricted bands must comply with the radiated emission limits specified as below table. Other emissions shall be at least 30dB below the highest level of the desired power:

FREQUENCIES (MHz)	FIELD STRENGTH (microvolts/meter)	MEASUREMENT DISTANCE (meters)
0.009 ~ 0.490	2400/F(kHz)	300
0.490 ~ 1.705	24000/F(kHz)	30
1.705 ~ 30.0	30	30
30 ~ 88	100	3
88 ~ 216	150	3
216 ~ 960	200	3
Above 960	500	3

NOTE:

1. The lower limit shall apply at the transition frequencies.
2. Emission level (dBuV/m) = 20 log Emission level (uV/m).
3. For frequencies above 1000MHz, the field strength limits are based on average detector, however, the peak field strength of any emission shall not exceed the maximum permitted average limits, specified above by more than 30dB under any condition of modulation.



A D T

5.1.2 TEST INSTRUMENTS

Same as item 4.1.2.

5.1.3 TEST PROCEDURES

Same as item 4.1.3.

5.1.4 DEVIATION FROM TEST STANDARD

No deviation.

5.1.5 TEST SETUP

Same as item 4.1.5.

5.1.6 EUT OPERATING CONDITIONS

Same as 4.1.6.



A D T

5.1.7 TEST RESULTS

ABOVE 1GHz DATA :

802.11a

EUT TEST CONDITION		MEASUREMENT DETAIL	
CHANNEL	Channel 149	FREQUENCY RANGE	1 ~ 40GHz
INPUT POWER	120Vac, 60 Hz	DETECTOR FUNCTION	Peak (PK) Average (AV)
ENVIRONMENTAL CONDITIONS	24deg. C, 71%RH	TESTED BY	Chad Lee

ANTENNA POLARITY & TEST DISTANCE: HORIZONTAL AT 3 M								
NO.	FREQ. (MHz)	EMISSION LEVEL (dBuV/m)	LIMIT (dBuV/m)	MARGIN (dB)	ANTENNA HEIGHT (m)	TABLE ANGLE (Degree)	RAW VALUE (dBuV)	CORRECTION FACTOR (dB/m)
1	#5725.00	76.9 PK	79.3	-2.4	1.25 H	19	38.59	38.31
2	#5725.00	53.9 AV	66.8	-12.9	1.25 H	19	15.62	38.31
3	*5745.00	109.3 PK			1.25 H	19	70.98	38.33
4	*5745.00	96.8 AV			1.25 H	19	58.42	38.33
5	11490.00	55.9 PK	74.0	-18.1	1.00 H	16	7.72	48.22
6	11490.00	42.9 AV	54.0	-11.1	1.00 H	16	-5.28	48.22
ANTENNA POLARITY & TEST DISTANCE: VERTICAL AT 3 M								
NO.	FREQ. (MHz)	EMISSION LEVEL (dBuV/m)	LIMIT (dBuV/m)	MARGIN (dB)	ANTENNA HEIGHT (m)	TABLE ANGLE (Degree)	RAW VALUE (dBuV)	CORRECTION FACTOR (dB/m)
1	#5725.00	77.3 PK	82.9	-5.6	1.00 V	273	38.98	38.31
2	#5725.00	58.1 AV	69.4	-11.3	1.00 V	273	19.76	38.31
3	*5745.00	112.9 PK			1.00 V	273	74.52	38.33
4	*5745.00	99.4 AV			1.00 V	273	61.08	38.33
5	11490.00	56.7 PK	74.0	-17.3	1.00 V	18	8.49	48.22
6	11490.00	42.9 AV	54.0	-11.1	1.00 V	18	-5.32	48.22

REMARKS:

1. Emission level (dBuV/m) = Raw Value (dBuV) + Correction Factor (dB/m).
2. Correction Factor (dB/m) = Antenna Factor (dB/m) + Cable Factor (dB).
3. The other emission levels were very low against the limit.
4. Margin value = Emission level – Limit value.
5. “ * “: Fundamental frequency.
6. The limit value is defined as per 15.247.
7. "#":The radiated frequency is out the restricted band.



A D T

EUT TEST CONDITION		MEASUREMENT DETAIL	
CHANNEL	Channel 157	FREQUENCY RANGE	1 ~ 40GHz
INPUT POWER	120Vac, 60 Hz	DETECTOR FUNCTION	Peak (PK) Average (AV)
ENVIRONMENTAL CONDITIONS	24deg. C, 71%RH	TESTED BY	Chad Lee

ANTENNA POLARITY & TEST DISTANCE: HORIZONTAL AT 3 M								
NO.	FREQ. (MHz)	EMISSION LEVEL (dBuV/m)	LIMIT (dBuV/m)	MARGIN (dB)	ANTENNA HEIGHT (m)	TABLE ANGLE (Degree)	RAW VALUE (dBuV)	CORRECTION FACTOR (dB/m)
1	*5785.00	109.8 PK			1.00 H	275	71.36	38.39
2	*5785.00	96.6 AV			1.00 H	275	58.20	38.39
3	11570.00	56.2 PK	74.0	-17.8	1.00 H	303	8.01	48.21
4	11570.00	46.1 AV	54.0	-7.9	1.00 H	303	-2.10	48.21
ANTENNA POLARITY & TEST DISTANCE: VERTICAL AT 3 M								
NO.	FREQ. (MHz)	EMISSION LEVEL (dBuV/m)	LIMIT (dBuV/m)	MARGIN (dB)	ANTENNA HEIGHT (m)	TABLE ANGLE (Degree)	RAW VALUE (dBuV)	CORRECTION FACTOR (dB/m)
1	*5785.00	112.9 PK			1.00 V	283	74.53	38.39
2	*5785.00	99.9 AV			1.00 V	283	61.55	38.39
3	11490.00	55.6 PK	74.0	-18.4	1.00 V	222	7.38	48.22
4	11490.00	42.0 AV	54.0	-12.0	1.00 V	222	-6.22	48.22

REMARKS:

1. Emission level (dBuV/m) = Raw Value (dBuV) + Correction Factor (dB/m).
2. Correction Factor (dB/m) = Antenna Factor (dB/m) + Cable Factor (dB).
3. The other emission levels were very low against the limit.
4. Margin value = Emission level – Limit value.
5. “ * “: Fundamental frequency.
6. The limit value is defined as per 15.247.



A D T

EUT TEST CONDITION		MEASUREMENT DETAIL	
CHANNEL	Channel 165	FREQUENCY RANGE	1 ~ 40GHz
INPUT POWER	120Vac, 60 Hz	DETECTOR FUNCTION	Peak (PK) Average (AV)
ENVIRONMENTAL CONDITIONS	24deg. C, 71%RH	TESTED BY	Chad Lee

ANTENNA POLARITY & TEST DISTANCE: HORIZONTAL AT 3 M								
NO.	FREQ. (MHz)	EMISSION LEVEL (dBuV/m)	LIMIT (dBuV/m)	MARGIN (dB)	ANTENNA HEIGHT (m)	TABLE ANGLE (Degree)	RAW VALUE (dBuV)	CORRECTION FACTOR (dB/m)
1	*5825.00	109.2 PK			1.21 H	142	70.71	38.45
2	*5825.00	94.7 AV			1.21 H	142	56.24	38.45
3	#5850.00	59.8 PK	79.2	-19.4	1.21 H	142	21.35	38.48
4	#5850.00	41.0 AV	64.7	-23.7	1.21 H	142	2.49	38.48
5	11650.00	58.1 PK	74.0	-15.9	1.00 H	196	9.97	48.16
6	11650.00	48.3 AV	54.0	-5.7	1.00 H	196	0.16	48.16
ANTENNA POLARITY & TEST DISTANCE: VERTICAL AT 3 M								
NO.	FREQ. (MHz)	EMISSION LEVEL (dBuV/m)	LIMIT (dBuV/m)	MARGIN (dB)	ANTENNA HEIGHT (m)	TABLE ANGLE (Degree)	RAW VALUE (dBuV)	CORRECTION FACTOR (dB/m)
1	*5825.00	112.9 PK			1.00 V	274	74.42	38.45
2	*5825.00	99.0 AV			1.00 V	274	60.58	38.45
3	#5850.00	67.3 PK	82.9	-15.6	1.00 V	274	28.83	38.48
4	#5850.00	45.8 AV	69.0	-23.2	1.00 V	274	7.32	38.48
5	11650.00	56.0 PK	74.0	-18.0	1.00 V	109	7.87	48.16
6	11650.00	42.8 AV	54.0	-11.2	1.00 V	109	-5.34	48.16

REMARKS:

1. Emission level (dBuV/m) = Raw Value (dBuV) + Correction Factor (dB/m).
2. Correction Factor (dB/m) = Antenna Factor (dB/m) + Cable Factor (dB).
3. The other emission levels were very low against the limit.
4. Margin value = Emission level – Limit value.
5. “ * “: Fundamental frequency.
6. The limit value is defined as per 15.247.
7. "#":The radiated frequency is out the restricted band.



A D T

802.11n (20MHz)

EUT TEST CONDITION		MEASUREMENT DETAIL	
CHANNEL	Channel 149	FREQUENCY RANGE	1 ~ 40GHz
INPUT POWER	120Vac, 60 Hz	DETECTOR FUNCTION	Peak (PK) Average (AV)
ENVIRONMENTAL CONDITIONS	24deg. C, 71%RH	TESTED BY	Chad Lee

ANTENNA POLARITY & TEST DISTANCE: HORIZONTAL AT 3 M								
NO.	FREQ. (MHz)	EMISSION LEVEL (dBuV/m)	LIMIT (dBuV/m)	MARGIN (dB)	ANTENNA HEIGHT (m)	TABLE ANGLE (Degree)	RAW VALUE (dBuV)	CORRECTION FACTOR (dB/m)
1	#5725.00	76.8 PK	78.6	-1.8	1.00 H	180	38.47	38.31
2	#5725.00	53.0 AV	66.5	-13.5	1.00 H	180	14.68	38.31
3	*5745.00	108.6 PK			1.00 H	180	70.28	38.33
4	*5745.00	96.5 AV			1.00 H	180	58.14	38.33
5	11490.00	57.7 PK	74.0	-16.3	1.00 H	162	9.49	48.22
6	11490.00	47.0 AV	54.0	-7.0	1.00 H	162	-1.23	48.22
ANTENNA POLARITY & TEST DISTANCE: VERTICAL AT 3 M								
NO.	FREQ. (MHz)	EMISSION LEVEL (dBuV/m)	LIMIT (dBuV/m)	MARGIN (dB)	ANTENNA HEIGHT (m)	TABLE ANGLE (Degree)	RAW VALUE (dBuV)	CORRECTION FACTOR (dB/m)
1	#5725.00	79.5 PK	81.0	-1.5	1.00 V	85	41.17	38.31
2	#5725.00	59.3 AV	68.5	-9.2	1.00 V	85	21.00	38.31
3	*5745.00	111.0 PK			1.00 V	85	72.62	38.33
4	*5745.00	98.5 AV			1.00 V	85	60.15	38.33
5	11490.00	55.7 PK	74.0	-18.3	1.00 V	5	7.48	48.22
6	11490.00	42.6 AV	54.0	-11.4	1.00 V	5	-5.67	48.22

REMARKS:

1. Emission level (dBuV/m) = Raw Value (dBuV) + Correction Factor (dB/m).
2. Correction Factor (dB/m) = Antenna Factor (dB/m) + Cable Factor (dB).
3. The other emission levels were very low against the limit.
4. Margin value = Emission level – Limit value.
5. “ * “: Fundamental frequency.
6. The limit value is defined as per 15.247.
7. “#“: The radiated frequency is out the restricted band.



A D T

EUT TEST CONDITION		MEASUREMENT DETAIL	
CHANNEL	Channel 157	FREQUENCY RANGE	1 ~ 40GHz
INPUT POWER	120Vac, 60 Hz	DETECTOR FUNCTION	Peak (PK) Average (AV)
ENVIRONMENTAL CONDITIONS	24deg. C, 71%RH	TESTED BY	Chad Lee

ANTENNA POLARITY & TEST DISTANCE: HORIZONTAL AT 3 M								
NO.	FREQ. (MHz)	EMISSION LEVEL (dBuV/m)	LIMIT (dBuV/m)	MARGIN (dB)	ANTENNA HEIGHT (m)	TABLE ANGLE (Degree)	RAW VALUE (dBuV)	CORRECTION FACTOR (dB/m)
1	*5785.00	109.1 PK			1.00 H	143	70.74	38.39
2	*5785.00	96.6 AV			1.00 H	143	58.22	38.39
3	11570.00	58.2 PK	74.0	-15.8	1.00 H	174	10.01	48.21
4	11570.00	47.4 AV	54.0	-6.6	1.00 H	174	-0.80	48.21

ANTENNA POLARITY & TEST DISTANCE: VERTICAL AT 3 M								
NO.	FREQ. (MHz)	EMISSION LEVEL (dBuV/m)	LIMIT (dBuV/m)	MARGIN (dB)	ANTENNA HEIGHT (m)	TABLE ANGLE (Degree)	RAW VALUE (dBuV)	CORRECTION FACTOR (dB/m)
1	*5785.00	110.7 PK			1.00 V	274	72.29	38.39
2	*5785.00	98.4 AV			1.00 V	274	60.03	38.39
3	11570.00	58.2 PK	74.0	-15.8	1.00 V	142	10.01	48.21
4	11570.00	44.1 AV	54.0	-9.9	1.00 V	142	-4.13	48.21

REMARKS:

1. Emission level (dBuV/m) = Raw Value (dBuV) + Correction Factor (dB/m).
2. Correction Factor (dB/m) = Antenna Factor (dB/m) + Cable Factor (dB).
3. The other emission levels were very low against the limit.
4. Margin value = Emission level – Limit value.
5. “ * “: Fundamental frequency.
6. The limit value is defined as per 15.247.



A D T

EUT TEST CONDITION		MEASUREMENT DETAIL	
CHANNEL	Channel 165	FREQUENCY RANGE	1 ~ 40GHz
INPUT POWER	120Vac, 60 Hz	DETECTOR FUNCTION	Peak (PK) Average (AV)
ENVIRONMENTAL CONDITIONS	24deg. C, 71%RH	TESTED BY	Chad Lee

ANTENNA POLARITY & TEST DISTANCE: HORIZONTAL AT 3 M								
NO.	FREQ. (MHz)	EMISSION LEVEL (dBuV/m)	LIMIT (dBuV/m)	MARGIN (dB)	ANTENNA HEIGHT (m)	TABLE ANGLE (Degree)	RAW VALUE (dBuV)	CORRECTION FACTOR (dB/m)
1	*5825.00	108.8 PK			1.00 H	167	70.36	38.45
2	*5825.00	96.7 AV			1.00 H	167	58.21	38.45
3	#5850.00	64.6 PK	78.8	-14.2	1.00 H	167	26.11	38.48
4	#5850.00	44.1 AV	66.7	-22.6	1.00 H	167	5.59	38.48
5	11650.00	58.5 PK	74.0	-15.5	1.00 H	151	10.30	48.16
6	11650.00	48.6 AV	54.0	-5.4	1.00 H	151	0.48	48.16
ANTENNA POLARITY & TEST DISTANCE: VERTICAL AT 3 M								
NO.	FREQ. (MHz)	EMISSION LEVEL (dBuV/m)	LIMIT (dBuV/m)	MARGIN (dB)	ANTENNA HEIGHT (m)	TABLE ANGLE (Degree)	RAW VALUE (dBuV)	CORRECTION FACTOR (dB/m)
1	*5825.00	111.3 PK			1.00 V	274	72.84	38.45
2	*5825.00	98.7 AV			1.00 V	274	60.24	38.45
3	#5850.00	65.2 PK	81.3	-16.1	1.00 V	274	26.68	38.48
4	#5850.00	47.3 AV	68.7	-21.4	1.00 V	274	8.86	38.48
5	11650.00	56.7 PK	74.0	-17.3	1.00 V	189	8.57	48.16
6	11650.00	43.3 AV	54.0	-10.7	1.00 V	189	-4.87	48.16

REMARKS:

1. Emission level (dBuV/m) = Raw Value (dBuV) + Correction Factor (dB/m).
2. Correction Factor (dB/m) = Antenna Factor (dB/m) + Cable Factor (dB).
3. The other emission levels were very low against the limit.
4. Margin value = Emission level – Limit value.
5. “ * “: Fundamental frequency.
6. The limit value is defined as per 15.247.
7. “#”:The radiated frequency is out the restricted band.



A D T

802.11n (40MHz)

EUT TEST CONDITION		MEASUREMENT DETAIL	
CHANNEL	Channel 151	FREQUENCY RANGE	1 ~ 40GHz
INPUT POWER	120Vac, 60 Hz	DETECTOR FUNCTION	Peak (PK) Average (AV)
ENVIRONMENTAL CONDITIONS	24deg. C, 71%RH	TESTED BY	Chad Lee

ANTENNA POLARITY & TEST DISTANCE: HORIZONTAL AT 3 M								
NO.	FREQ. (MHz)	EMISSION LEVEL (dBuV/m)	LIMIT (dBuV/m)	MARGIN (dB)	ANTENNA HEIGHT (m)	TABLE ANGLE (Degree)	RAW VALUE (dBuV)	CORRECTION FACTOR (dB/m)
1	#5725.00	71.7 PK	73.2	-1.5	1.00 H	324	33.40	38.31
2	#5725.00	55.6 AV	58.7	-3.1	1.00 H	324	17.32	38.31
3	*5755.00	103.2 PK			1.00 H	324	64.85	38.35
4	*5755.00	88.7 AV			1.00 H	324	50.36	38.35
5	11510.00	57.8 PK	74.0	-16.2	1.00 H	178	9.58	48.21
6	11510.00	48.3 AV	54.0	-5.7	1.00 H	178	0.07	48.21

ANTENNA POLARITY & TEST DISTANCE: VERTICAL AT 3 M								
NO.	FREQ. (MHz)	EMISSION LEVEL (dBuV/m)	LIMIT (dBuV/m)	MARGIN (dB)	ANTENNA HEIGHT (m)	TABLE ANGLE (Degree)	RAW VALUE (dBuV)	CORRECTION FACTOR (dB/m)
1	#5725.00	75.9 PK	77.0	-1.1	1.00 V	100	37.56	38.31
2	#5725.00	60.5 AV	61.9	-1.4	1.00 V	100	22.17	38.31
3	*5755.00	107.0 PK			1.00 V	100	68.64	38.35
4	*5755.00	91.9 AV			1.00 V	100	53.57	38.35
5	11510.00	55.7 PK	74.0	-18.3	1.00 V	19	7.47	48.21
6	11510.00	42.7 AV	54.0	-11.3	1.00 V	19	-5.53	48.21

REMARKS:

1. Emission level (dBuV/m) = Raw Value (dBuV) + Correction Factor (dB/m).
2. Correction Factor (dB/m) = Antenna Factor (dB/m) + Cable Factor (dB).
3. The other emission levels were very low against the limit.
4. Margin value = Emission level – Limit value.
5. “ * “: Fundamental frequency.
6. The limit value is defined as per 15.247.
7. "#":The radiated frequency is out the restricted band.



A D T

EUT TEST CONDITION		MEASUREMENT DETAIL	
CHANNEL	Channel 159	FREQUENCY RANGE	1 ~ 40GHz
INPUT POWER	120Vac, 60 Hz	DETECTOR FUNCTION	Peak (PK) Average (AV)
ENVIRONMENTAL CONDITIONS	24deg. C, 71%RH	TESTED BY	Chad Lee

ANTENNA POLARITY & TEST DISTANCE: HORIZONTAL AT 3 M								
NO.	FREQ. (MHz)	EMISSION LEVEL (dBuV/m)	LIMIT (dBuV/m)	MARGIN (dB)	ANTENNA HEIGHT (m)	TABLE ANGLE (Degree)	RAW VALUE (dBuV)	CORRECTION FACTOR (dB/m)
1	*5795.00	103.8 PK			1.00 H	141	65.35	38.40
2	*5795.00	88.8 AV			1.00 H	141	50.36	38.40
3	#5850.00	54.8 PK	73.8	-19.0	1.00 H	141	16.34	38.48
4	#5850.00	40.1 AV	58.8	-18.7	1.00 H	141	1.56	38.48
5	11590.00	58.3 PK	74.0	-15.7	1.00 H	1	10.04	48.21
6	11590.00	47.7 AV	54.0	-6.3	1.00 H	1	-0.56	48.21
ANTENNA POLARITY & TEST DISTANCE: VERTICAL AT 3 M								
NO.	FREQ. (MHz)	EMISSION LEVEL (dBuV/m)	LIMIT (dBuV/m)	MARGIN (dB)	ANTENNA HEIGHT (m)	TABLE ANGLE (Degree)	RAW VALUE (dBuV)	CORRECTION FACTOR (dB/m)
1	*5795.00	106.4 PK			1.00 V	16	68.00	38.40
2	*5795.00	90.6 AV			1.00 V	16	52.24	38.40
3	#5850.00	54.1 PK	76.4	-22.3	1.00 V	16	15.66	38.48
4	#5850.00	39.5 AV	60.6	-21.1	1.00 V	16	0.96	38.48
5	11590.00	56.3 PK	74.0	-17.7	1.00 V	6	8.11	48.21
6	11590.00	43.0 AV	54.0	-11.0	1.00 V	6	-5.25	48.21

REMARKS:

1. Emission level (dBuV/m) = Raw Value (dBuV) + Correction Factor (dB/m).
2. Correction Factor (dB/m) = Antenna Factor (dB/m) + Cable Factor (dB).
3. The other emission levels were very low against the limit.
4. Margin value = Emission level – Limit value.
5. “ * “: Fundamental frequency.
6. The limit value is defined as per 15.247.
7. “#”:The radiated frequency is out the restricted band.



A D T

BELOW 1GHz WORST-CASE DATA : 802.11a

EUT TEST CONDITION		MEASUREMENT DETAIL	
CHANNEL	Channel 157	FREQUENCY RANGE	Below 1000MHz
INPUT POWER	120Vac, 60 Hz	DETECTOR FUNCTION	Quasi-Peak
ENVIRONMENTAL CONDITIONS	24deg. C, 64%RH	TESTED BY	Chad Lee

ANTENNA POLARITY & TEST DISTANCE: HORIZONTAL AT 3 M								
NO.	FREQ. (MHz)	EMISSION LEVEL (dBuV/m)	LIMIT (dBuV/m)	MARGIN (dB)	ANTENNA HEIGHT (m)	TABLE ANGLE (Degree)	RAW VALUE (dBuV)	CORRECTION FACTOR (dB/m)
1	39.21	27.9 QP	40.0	-12.2	1.12 H	85	14.57	13.28
2	250.08	31.0 QP	46.0	-15.0	1.00 H	220	17.50	13.50
3	599.59	38.2 QP	46.0	-7.8	1.58 H	25	14.90	23.26
4	749.87	34.9 QP	46.0	-11.1	1.48 H	241	9.50	25.41
5	874.45	34.5 QP	46.0	-11.5	1.12 H	88	7.15	27.38
6	999.52	44.7 QP	54.0	-9.3	1.33 H	106	15.95	28.74

ANTENNA POLARITY & TEST DISTANCE: VERTICAL AT 3 M								
NO.	FREQ. (MHz)	EMISSION LEVEL (dBuV/m)	LIMIT (dBuV/m)	MARGIN (dB)	ANTENNA HEIGHT (m)	TABLE ANGLE (Degree)	RAW VALUE (dBuV)	CORRECTION FACTOR (dB/m)
1	38.73	36.8 QP	40.0	-3.2	1.15 V	307	23.62	13.16
2	90.11	39.5 QP	43.5	-4.0	1.69 V	223	31.11	8.35
3	158.46	28.1 QP	43.5	-15.4	1.84 V	112	14.01	14.05
4	160.88	28.5 QP	43.5	-15.0	1.33 V	100	14.53	13.99
5	499.73	32.0 QP	46.0	-14.0	1.42 V	343	11.00	21.03
6	599.59	34.1 QP	46.0	-11.9	1.08 V	130	10.83	23.26

REMARKS:

1. Emission level (dBuV/m) = Raw Value (dBuV) + Correction Factor (dB/m).
2. Correction Factor (dB/m) = Antenna Factor (dB/m) + Cable Factor (dB).
3. The other emission levels were very low against the limit.
4. Margin value = Emission level – Limit value.

5.2 CONDUCTED EMISSION MEASUREMENT

5.2.1 LIMITS OF CONDUCTED EMISSION MEASUREMENT

FREQUENCY OF EMISSION (MHz)	CONDUCTED LIMIT (dB μ V)	
	Quasi-peak	Average
0.15 ~ 0.5	66 to 56	56 to 46
0.5 ~ 5	56	46
5 ~ 30	60	50

- NOTE:** 1. The lower limit shall apply at the transition frequencies.
2. The limit decreases in line with the logarithm of the frequency in the range of 0.15 to 0.50MHz.
3. All emanations from a class A/B digital device or system, including any network of conductors and apparatus connected thereto, shall not exceed the level of field strengths specified above.

5.2.2 TEST INSTRUMENTS

Same as item 4.2.2.

5.2.3 TEST PROCEDURES

Same as item 4.2.3.

5.2.4 DEVIATION FROM TEST STANDARD

No deviation.

5.2.5 TEST SETUP

Same as item 4.2.5.

5.2.6 EUT OPERATING CONDITIONS

Same as 4.1.6

5.2.7 TEST RESULTS

CONDUCTED WORST-CASE DATA : 802.11a

PHASE	Line 1	6dB BANDWIDTH	9kHz
--------------	--------	----------------------	------

No	Freq. [MHz]	Corr. Factor (dB)	Reading Value [dB (uV)]		Emission Level [dB (uV)]		Limit [dB (uV)]		Margin (dB)	
			Q.P.	AV.	Q.P.	AV.	Q.P.	AV.	Q.P.	AV.
1	0.15000	0.17	53.57	43.66	53.74	43.83	66.00	56.00	-12.26	-12.17
2	0.21641	0.17	42.66	31.68	42.83	31.85	62.96	52.96	-20.12	-21.10
3	0.58750	0.21	45.12	38.65	45.33	38.86	56.00	46.00	-10.67	-7.14
4	3.28516	0.36	29.90	23.36	30.26	23.72	56.00	46.00	-25.74	-22.28
5	5.84766	0.42	30.67	23.94	31.09	24.36	60.00	50.00	-28.91	-25.64
6	15.75000	0.62	31.67	25.82	32.29	26.44	60.00	50.00	-27.71	-23.56

REMARKS:

1. Q.P. and AV. are abbreviations of quasi-peak and average individually.
2. The emission levels of other frequencies were very low against the limit.
3. Margin value = Emission level - Limit value
4. Correction factor = Insertion loss + Cable loss
5. Emission Level = Correction Factor + Reading Value.

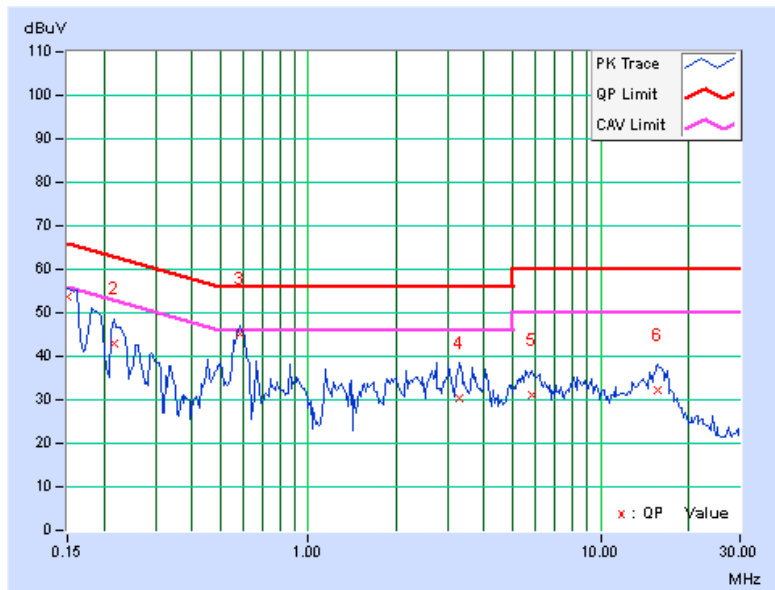

PHASE	Line 2	6dB BANDWIDTH	9kHz
-------	--------	---------------	------

No	Freq. [MHz]	Corr. Factor (dB)	Reading Value [dB (uV)]		Emission Level [dB (uV)]		Limit [dB (uV)]		Margin (dB)	
			Q.P.	AV.	Q.P.	AV.	Q.P.	AV.	Q.P.	AV.
1	0.15000	0.17	55.44	45.02	55.61	45.19	66.00	56.00	-10.39	-10.81
2	0.22422	0.15	46.16	39.15	46.31	39.30	62.66	52.66	-16.35	-13.36
3	0.58359	0.18	47.20	39.14	47.38	39.32	56.00	46.00	-8.62	-6.68
4	2.48438	0.30	28.91	20.99	29.21	21.29	56.00	46.00	-26.79	-24.71
5	5.92188	0.44	30.48	23.32	30.92	23.76	60.00	50.00	-29.08	-26.24
6	16.43359	0.73	28.56	22.02	29.29	22.75	60.00	50.00	-30.71	-27.25

REMARKS:

1. Q.P. and AV. are abbreviations of quasi-peak and average individually.
2. The emission levels of other frequencies were very low against the limit.
3. Margin value = Emission level - Limit value
4. Correction factor = Insertion loss + Cable loss
5. Emission Level = Correction Factor + Reading Value.

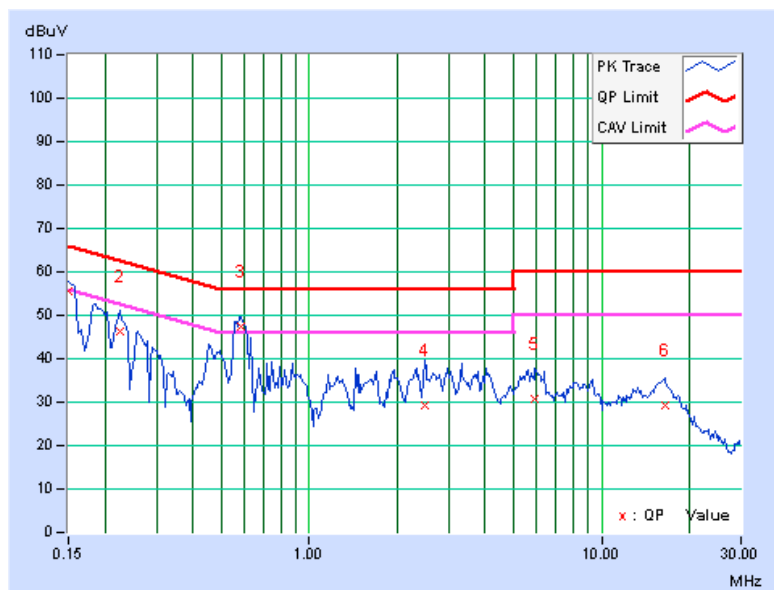



A D T

5.3 6dB BANDWIDTH MEASUREMENT

5.3.1 LIMITS OF 6dB BANDWIDTH MEASUREMENT

The minimum of 6dB Bandwidth Measurement is 0.5MHz.

5.3.2 TEST SETUP

Same as item 4.3.2.

5.3.3 TEST INSTRUMENTS

Refer to section 4.1.2 to get information of above instrument.

5.3.4 TEST PROCEDURE

Same as item 4.3.4.

5.3.5 DEVIATION FROM TEST STANDARD

No deviation.

5.3.6 EUT OPERATING CONDITIONS

Same as item 4.3.6.



5.3.7 TEST RESULTS

802.11a

CHANNEL	CHANNEL FREQUENCY (MHz)	6dB BANDWIDTH (MHz)		MINIMUM LIMIT (MHz)	PASS / FAIL
		CHAIN 0	CHAIN 1		
149	5745	16.53	16.63	0.5	PASS
157	5785	16.53	16.52	0.5	PASS
165	5825	16.52	16.49	0.5	PASS

802.11n (20MHz)

CHANNEL	CHANNEL FREQUENCY (MHz)	6dB BANDWIDTH (MHz)		MINIMUM LIMIT (MHz)	PASS / FAIL
		CHAIN 0	CHAIN 1		
149	5745	17.74	17.82	0.5	PASS
157	5785	17.76	17.69	0.5	PASS
165	5825	17.76	17.86	0.5	PASS

802.11n (40MHz)

CHANNEL	CHANNEL FREQUENCY (MHz)	6dB BANDWIDTH (MHz)		MINIMUM LIMIT (MHz)	PASS / FAIL
		CHAIN 0	CHAIN 1		
151	5755	36.98	37.11	0.5	PASS
159	5795	36.94	36.89	0.5	PASS



A D T

5.4 CONDUCTED OUTPUT POWER

5.4.1 LIMITS OF CONDUCTED OUTPUT POWER MEASUREMENT

For systems using digital modulation in the 5725 –5850 MHz bands: 1 Watt (30dBm)

5.4.2 TEST SETUP

Same as Item 4.4.2.

5.4.3 INSTRUMENTS

Refer to section 4.1.2 to get information of above instrument.

5.4.4 TEST PROCEDURES

Same as Item 4.4.4.

5.4.5 DEVIATION FROM TEST STANDARD

No deviation.

5.4.6 EUT OPERATING CONDITIONS

Same as Item 4.3.6.



5.4.7 TEST RESULTS

802.11a

CHAN.	CHAN. FREQ. (MHz)	AVG. POWER (dBm)		TOTAL POWER (mW)	TOTAL POWER (dBm)	LIMIT (dBm)	PASS / FAIL
		CHAIN 0	CHAIN 1				
149	5745	19.59	18.22	157.4	22.0	30	PASS
157	5785	19.89	18.41	166.8	22.2	30	PASS
165	5825	19.95	18.18	164.6	22.2	30	PASS

802.11n (20MHz)

CHAN.	CHAN. FREQ. (MHz)	AVG. POWER (dBm)		TOTAL POWER (mW)	TOTAL POWER (dBm)	LIMIT (dBm)	PASS / FAIL
		CHAIN 0	CHAIN 1				
149	5745	19.18	18.61	155.4	21.9	30	PASS
157	5785	19.96	18.26	166.1	22.2	30	PASS
165	5825	19.85	18.12	161.5	22.1	30	PASS

802.11n (40MHz)

CHAN.	CHAN. FREQ. (MHz)	AVG. POWER (dBm)		TOTAL POWER (mW)	TOTAL POWER (dBm)	LIMIT (dBm)	PASS / FAIL
		CHAIN 0	CHAIN 1				
151	5755	18.38	16.91	118.0	20.7	30	PASS
159	5795	19.83	18.06	160.1	22.0	30	PASS



A D T

5.5 POWER SPECTRAL DENSITY MEASUREMENT

5.5.1 LIMITS OF POWER SPECTRAL DENSITY MEASUREMENT

The Maximum of Power Spectral Density Measurement is 8dBm.

5.5.2 TEST SETUP

Same as item 4.5.2.

5.5.3 TEST INSTRUMENTS

Refer to section 4.1.2 to get information of above instrument.

5.5.4 TEST PROCEDURE.

Same as item 4.5.4.

5.5.5 DEVIATION FROM TEST STANDARD

No deviation.

5.5.6 EUT OPERATING CONDITION

Same as item 4.3.6.



A D T

5.5.7 TEST RESULTS

802.11a

TX chain	Channel	FREQ. (MHz)	PSD (dBm/100kHz)	PSD (dBm/3kHz)	10 log (N=2) dB	Total PSD (dBm/3kHz)	Limit (dBm/3kHz)	PASS /FAIL
0	149	5745	-0.23	-15.46	3.01	-12.45	8	PASS
	157	5785	0.32	-14.91	3.01	-11.90	8	PASS
	165	5825	0.61	-14.62	3.01	-11.61	8	PASS
1	149	5745	-1.32	-16.55	3.01	-13.54	8	PASS
	157	5785	-1.43	-16.66	3.01	-13.65	8	PASS
	165	5825	-0.81	-16.04	3.01	-13.03	8	PASS

802.11n (20MHz)

TX chain	Channel	FREQ. (MHz)	PSD (dBm/100kHz)	PSD (dBm/3kHz)	10 log (N=2) dB	Total PSD (dBm/3kHz)	Limit (dBm/3kHz)	PASS /FAIL
0	149	5745	-0.27	-15.50	3.01	-12.49	8	PASS
	157	5785	-0.22	-15.45	3.01	-12.44	8	PASS
	165	5825	0.42	-14.81	3.01	-11.80	8	PASS
1	149	5745	-1.70	-16.93	3.01	-13.92	8	PASS
	157	5785	-1.58	-16.81	3.01	-13.80	8	PASS
	165	5825	-1.75	-16.98	3.01	-13.97	8	PASS

802.11n (40MHz)

TX chain	Channel	FREQ. (MHz)	PSD (dBm/100kHz)	PSD (dBm/3kHz)	10 log (N=2) dB	Total PSD (dBm/3kHz)	Limit (dBm/3kHz)	PASS /FAIL
0	151	5755	-4.54	-19.77	3.01	-16.76	8	PASS
	159	5795	-3.29	-18.52	3.01	-15.51	8	PASS
1	151	5755	-5.42	-20.65	3.01	-17.64	8	PASS
	159	5795	-4.31	-19.54	3.01	-16.53	8	PASS



A D T

5.6 CONDUCTED OUT OF BAND EMISSION MEASUREMENT

5.6.1 LIMITS OF CONDUCTED OUT OF BAND EMISSION MEASUREMENT

Below -30dB of the highest emission level of operating band (in 100kHz Resolution Bandwidth).

5.6.2 TEST SETUP

Same as Item 4.6.2

5.6.3 TEST INSTRUMENTS

Refer to section 4.1.2 to get information of above instrument.

5.6.4 TEST PROCEDURE

Same as Item 4.6.4

5.6.5 DEVIATION FROM TEST STANDARD

No deviation.

5.6.6 EUT OPERATING CONDITION

Same as Item 4.3.6

5.6.7 TEST RESULTS

The conducted emission test is performed on each TX port of operating mode without summing or adding $10\log(N)$ since the limit is relative emission limit. Only worst data of each operating mode is presented.

The spectrum plots are attached on the following pages. D1 line indicates the highest level, and D2 line indicates the 20dB offset below D1. It shows compliance with the requirement.

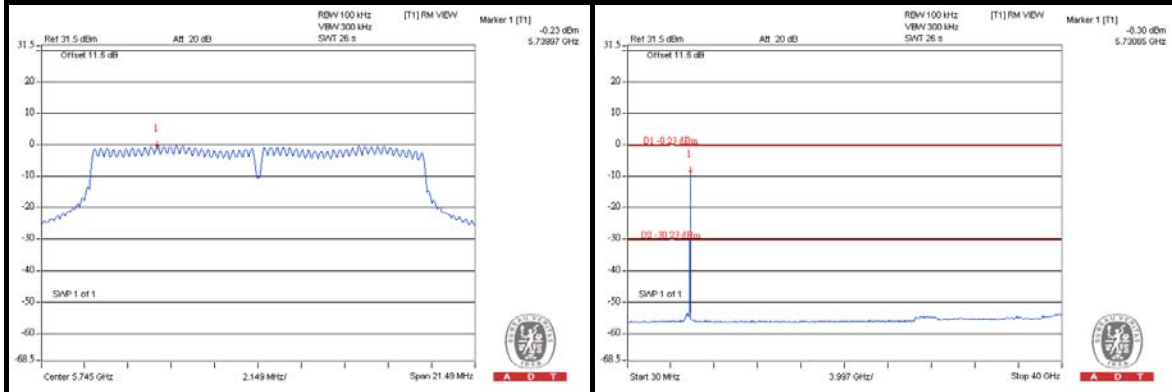
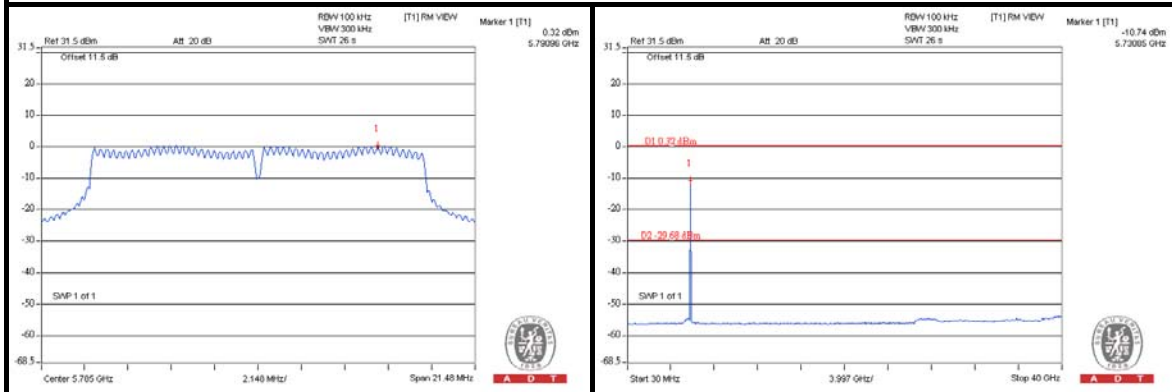
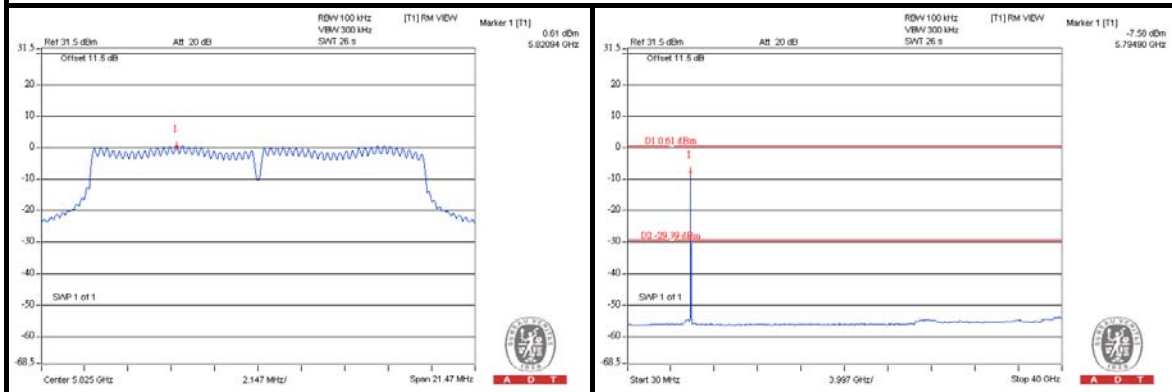
802.11a**CH 149****CH 157****CH 165**

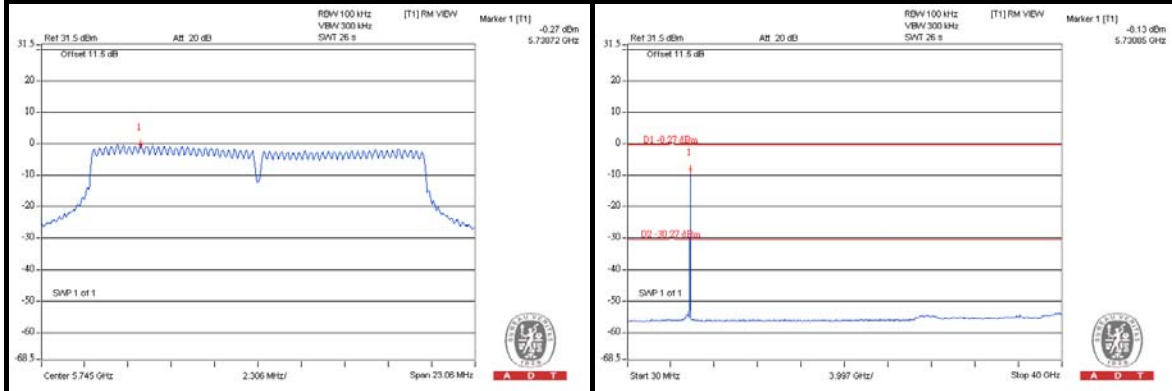
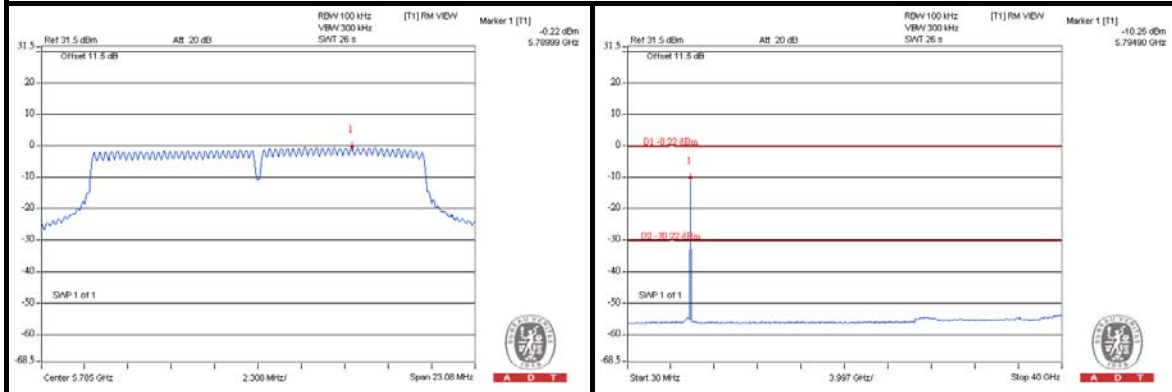
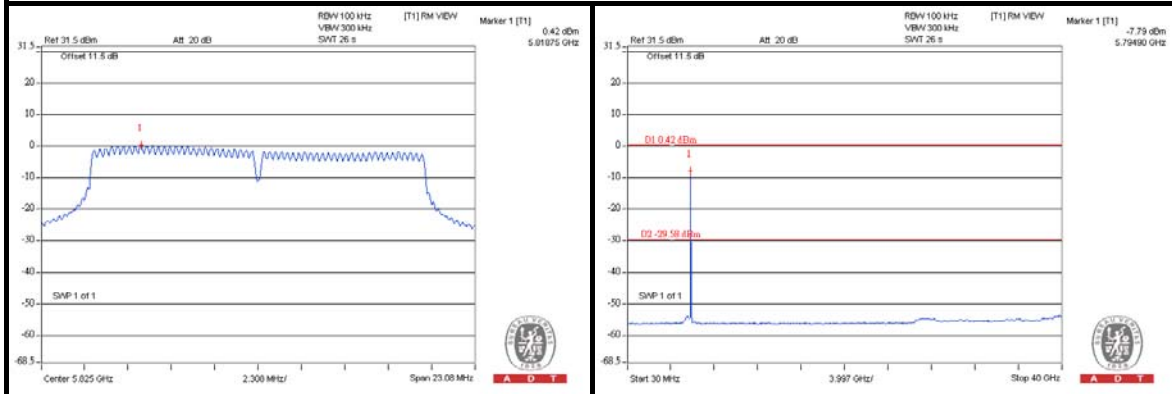
802.11n (20MHz)**CH 149****CH 157****CH 165**

802.11n (40MHz)

CH 151

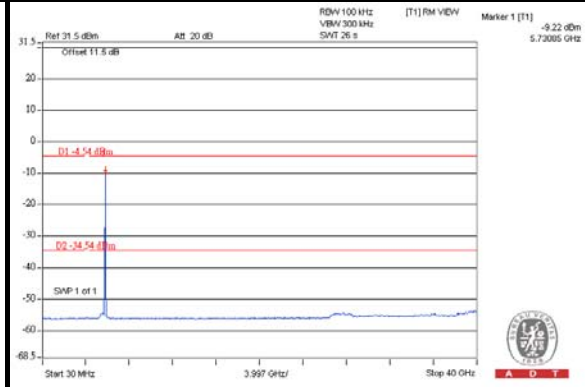
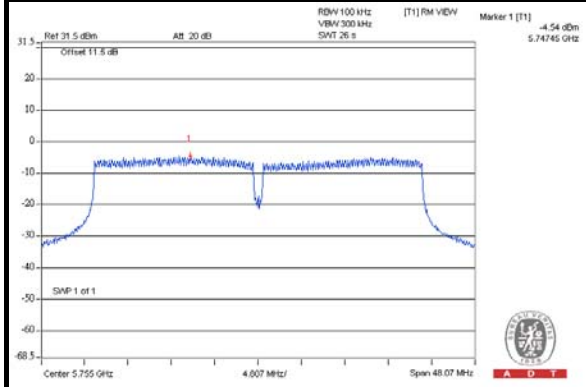

CH 159

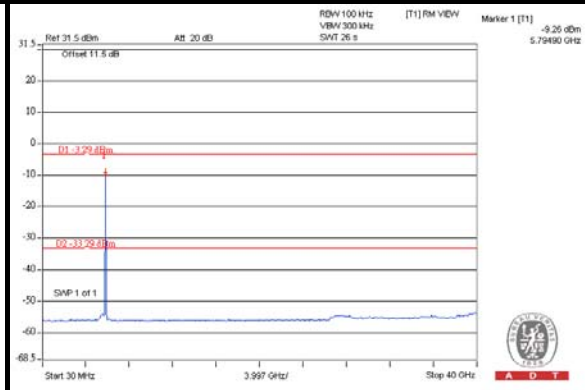
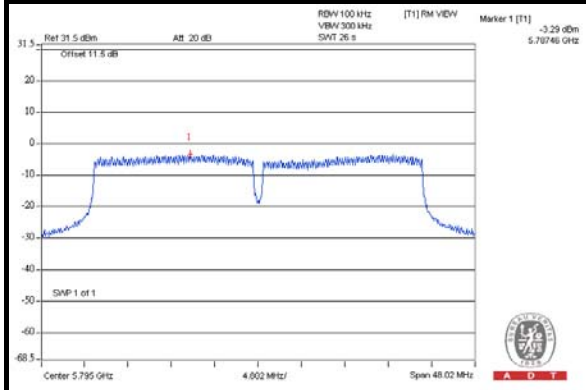



A D T

6. PHOTOGRAPHS OF THE TEST CONFIGURATION

Please refer to the attached file (Test Setup Photo).



A D T

7. INFORMATION ON THE TESTING LABORATORIES

We, Bureau Veritas Consumer Products Services (H.K.) Ltd., Taoyuan Branch, were founded in 1988 to provide our best service in EMC, Radio, Telecom and Safety consultation. Our laboratories are accredited and approved according to ISO/IEC 17025.

If you have any comments, please feel free to contact us at the following:

Linko EMC/RF Lab

Tel: 886-2-26052180

Fax: 886-2-26051924

Hsin Chu EMC/RF Lab

Tel: 886-3-5935343

Fax: 886-3-5935342

Hwa Ya EMC/RF/Safety/Telecom Lab

Tel: 886-3-3183232

Fax: 886-3-3270892

Email: service.adt@tw.bureauveritas.com

Web Site: www.adt.com.tw

The address and road map of all our labs can be found in our web site also.



A D T

8. APPENDIX A - MODIFICATIONS RECORDERS FOR ENGINEERING CHANGES TO THE EUT BY THE LAB

No modifications were made to the EUT by the lab during the test.

---END---