



# Compliance Testing, LLC

Previously Flom Test Lab

EMI, EMC, RF Testing Experts Since 1963

toll-free: (866) 311-3268

fax: (480) 926-3598

<http://www.ComplianceTesting.com>

[info@ComplianceTesting.com](mailto:info@ComplianceTesting.com)

## Test Report

Prepared for: Wilson Electronics, Inc.

Model: 2B3425

Description: Quint-Band Switchable Signal Booster

To

FCC Part 22H, 24E, 27

Date of Issue: October 2, 2012

On the behalf of the applicant:

Wilson Electronics, Inc.  
3301 E Deseret Drive  
St. George, UT 84790

Prepared By  
Compliance Testing, LLC  
3356 N San Marcos Pl, Suite 107  
Chandler, AZ 85225-7176  
(866) 311-3268 phone / (480) 926-3598 fax  
[www.compliancetesting.com](http://www.compliancetesting.com)  
Project No: p1280001

John Erhard  
Project Test Engineer

This report may not be reproduced, except in full, without written permission from Compliance Testing  
All results contained herein relate only to the sample tested



### Test Report Revision History

Revision	Date	Revised By	Reason for Revision
1.0	October 2, 2012	John Erhard	Original Document



## Table of Contents

<b><u>Description</u></b>	<b><u>Page</u></b>
Standard Test Conditions and Engineering Practices	5
Test Result Summary	6
Carrier Output Power	7
Spurious Emissions (Transmitter Conducted)	10
Spurious Emissions (Transmitter Radiated)	16
Intermodulation	20
Occupied Bandwidth	45
Out of Band Rejection	76
Test Equipment Utilized	82



## ILAC / A2LA

Compliance Testing, LLC, has been accredited in accordance with the recognized International Standard ISO/IEC 17025:2005. This accreditation demonstrates technical competence for a defined scope and the operation of a laboratory quality management system (refer joint ISO-ILAC-IAF Communiqué dated January 2009)

The tests results contained within this test report all fall within our scope of accreditation, unless noted below.

Please refer to <http://www.compliancetesting.com/labscope.html> for current scope of accreditation.

Testing Certificate Number: **2152.01**



FCC OATS Reg, #933597

IC Reg. #2044A-1

**Non-accredited tests contained in this report:**

**N/A**



**Test and Measurement Data**

Sub-part  
2.1033(c)(14):

All tests and measurement data shown were performed in accordance with FCC Rules and Regulations: Part 2, Sub-part J and the following individual Parts: 22H, 24E, 27 Signal Booster.

**Standard Test Conditions and Engineering Practices**

Except as noted herein, the following conditions and procedures were observed during the testing.

In accordance with ANSI/C63.4-2009, and unless otherwise indicated in the specific measurement results, the ambient temperature of the actual EUT was maintained within the range of 10° to 40°C (50° to 104°F) unless the particular equipment requirements specify testing over a different temperature range. Also, unless otherwise indicated, the humidity levels were in the range of 10% to 90% relative humidity.

Environmental Conditions		
Temp (°C)	Humidity (%)	Pressure (mbar)
23.0 - 27.1	41.9 - 49.5	964.2 - 967.0

Measurement results, unless otherwise noted, are worst-case measurements.

**EUT Description**

- Model:** 2B3425
- Description:** Quint-Band Switchable Signal Booster
- Firmware:** N/A
- Software:** N/A
- Accessories:** None
- Cables:** None
- Modifications:** None
- Additional Information:**

The EUT is a bi-directional amplifier for the boosting of cellular phone signals and data communication devices. The following frequency bands and emission types are utilized.

Frequency Band (MHz)					
<b>Uplink</b>	698 - 716	776 - 787	824 - 849	1850 - 1915	1710 - 1755
<b>Downlink</b>	728 - 746	746 - 757	869 - 894	1930 - 1995	2110 - 2155
<b>Modulation Type</b>	LTE		GSM, CDMA, EDGE, HSPA. EVDO, LTE		

**EUT Operation during Tests**

The EUT was in a normal operating condition.



### Test Result Summary

Specification	Test Name	Pass, Fail, N/A	Comments
Part 22H, 24E, 27	Carrier Output Power	Pass	
Part 22H, 24E, 27	Spurious Emissions (Transmitter Conducted)	Pass	
Part 22H, 24E, 27	Spurious Emissions (Transmitter Radiated)	Pass	
Part 22H, 24E, 27	Intermodulation	Pass	
Part 22H, 24E, 27	Occupied Bandwidth	Pass	
Part 22H, 24E, 27	Out of Band Rejection	Pass	
Part 22H, 24E, 27	Frequency Stability (Temperature Variation)	N/A	The EUT does not perform frequency translation
Part 22H, 24E, 27	Frequency Stability (Voltage Variation)	N/A	The EUT does not perform frequency translation



## Carrier Output Power

**Name of Test:** Carrier Output Power  
**Test Equipment Utilized:** i00331, i00348, i00347

**Engineer:** John Erhard  
**Test Date:** 9/26/2012

### Test Procedure

The EUT was connected to a spectrum analyzer through a 20 dB power attenuator. A signal generator was utilized to produce a CW input signal. The RF input level was increased while monitoring the output power. The input RF drive level was increased until the EUT output reached saturation (the output stopped increasing) whereby the maximum power level and gain was achieved. The uplink / downlink power and gain levels for the low, middle, and high channels are recorded in the following tables.

### Test Setup

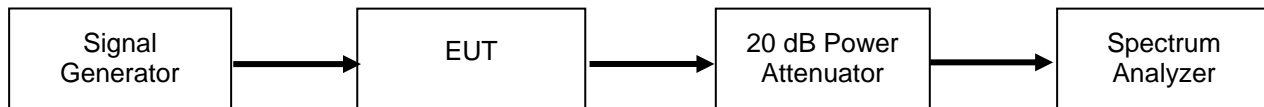



## Uplink Test Results

### 698 - 716 MHz Band

Tuned Frequency (MHz)	Input Power (dBm)	Output Power (dBm)	Gain (dB)
698	13.7	25.8	12.1
707	12.1	27.9	15.8
716	11.1	24.8	13.7

### 776 - 787 MHz Band

Tuned Frequency (MHz)	Input Power (dBm)	Output Power (dBm)	Gain (dB)
776	14.8	28	13.2
781.5	12.8	26.4	13.6
787	14.8	26.3	11.5

### 824 - 849 MHz Band

Tuned Frequency (MHz)	Input Power (dBm)	Output Power (dBm)	Gain (dB)
824	13.8	28.1	14.3
836	10.4	28.6	18.2
849	13.8	28	14.2

### 1710 - 1755 MHz Band

Tuned Frequency (MHz)	Input Power (dBm)	Output Power (dBm)	Gain (dB)
1710	11.2	25.3	14.1
1742	11.1	25.3	14.2
1755	13	26.6	13.6

### 1850 - 1915 MHz Band

Tuned Frequency (MHz)	Input Power (dBm)	Output Power (dBm)	Gain (dB)
1850	13.1	26.7	13.6
1880	14.5	28.2	13.7
1915	14.9	23.3	8.4





### Downlink Test Results

#### 728 - 746 MHz Band

Tuned Frequency (MHz)	Input Power (dBm)	Output Power (dBm)	Gain (dB)
728	-13.8	2.4	16.2
737	-12.2	3.1	15.3
746	-12.5	1.6	14.1

#### 746 - 757 MHz Band

Tuned Frequency (MHz)	Input Power (dBm)	Output Power (dBm)	Gain (dB)
746	-11.4	3.1	14.5
751.5	-10.2	3.6	13.8
757	-10.5	1.6	12.1

#### 869 - 894 MHz Band

Tuned Frequency (MHz)	Input Power (dBm)	Output Power (dBm)	Gain (dB)
869	-10.4	2.4	12.8
881	-11.3	2.4	13.7
894	-10.2	1.9	12.1

#### 1930 - 1995 MHz Band

Tuned Frequency (MHz)	Input Power (dBm)	Output Power (dBm)	Gain (dB)
1930	-6.1	6.2	12.3
1960	-4.4	9.2	13.6
1995	-2.8	8.9	11.7

#### 2110 - 2155 MHz Band

Tuned Frequency (MHz)	Input Power (dBm)	Output Power (dBm)	Gain (dB)
2110	-2.2	8.3	10.5
2132	-3.2	9.4	12.6
2155	-1.2	9.2	10.4



## Spurious Emissions (Transmitter Conducted)

**Name of Test:** Spurious Emissions (Transmitter Conducted) **Engineer:** John Erhard  
**Test Equipment Utilized:** i00266, i00331, i00348, i00347 **Test Date:** 10/01/2012

### Test Procedure

The EUT was connected to a spectrum analyzer through a 20 dB power attenuator. Two signal generators were utilized to produce a two tone signal with the channel spacing set so the intermodulation products fell within the operational band. The input signal level was increased until the intermodulation products were as close as possible to the maximum allowable level of -13 dBm without being greater than that limit. The uplink / downlink conducted spurious emissions were examined to beyond the 10<sup>th</sup> harmonic of the fundamental signal and no spurious emissions were detected. The two tones selected were near the center of the operational band and as there were no detectable emissions only a single test was performed per operational band. The worst case out of band emission for each operational band is indicated in the tables below. Plots are provided to show there are no additional emissions.

### Test Setup

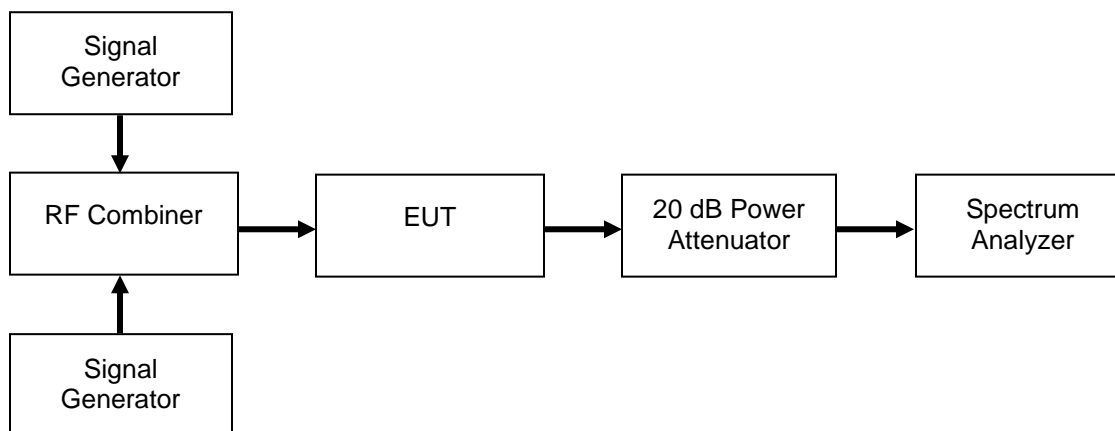

### Uplink Test Results

Frequency Band (MHz)	Measured Level (dBm)	Limit (dBm)	Margin (dB)	Result
698 - 716	-36.99	-13	-23.99	Pass
776 - 787	-45.10	-13	-32.10	Pass
824 - 849	-40.94	-13	-27.94	Pass
1710 - 1755	-46.08	-13	-33.08	Pass
1850 - 1915	-49.21	-13	-36.21	Pass

### Downlink Test Results

Frequency Band (MHz)	Measured Level (dBm)	Limit (dBm)	Margin (dB)	Result
728 - 746	-55.98	-13	-42.98	Pass
746 - 757	-55.53	-13	-42.53	Pass
869 - 894	-42.97	-13	-29.97	Pass
1930 - 1995	-56.86	-13	-43.86	Pass
2110 - 2155	-55.99	-13	-42.99	Pass



### Uplink Test Plots

#### 698 - 716 MHz Band

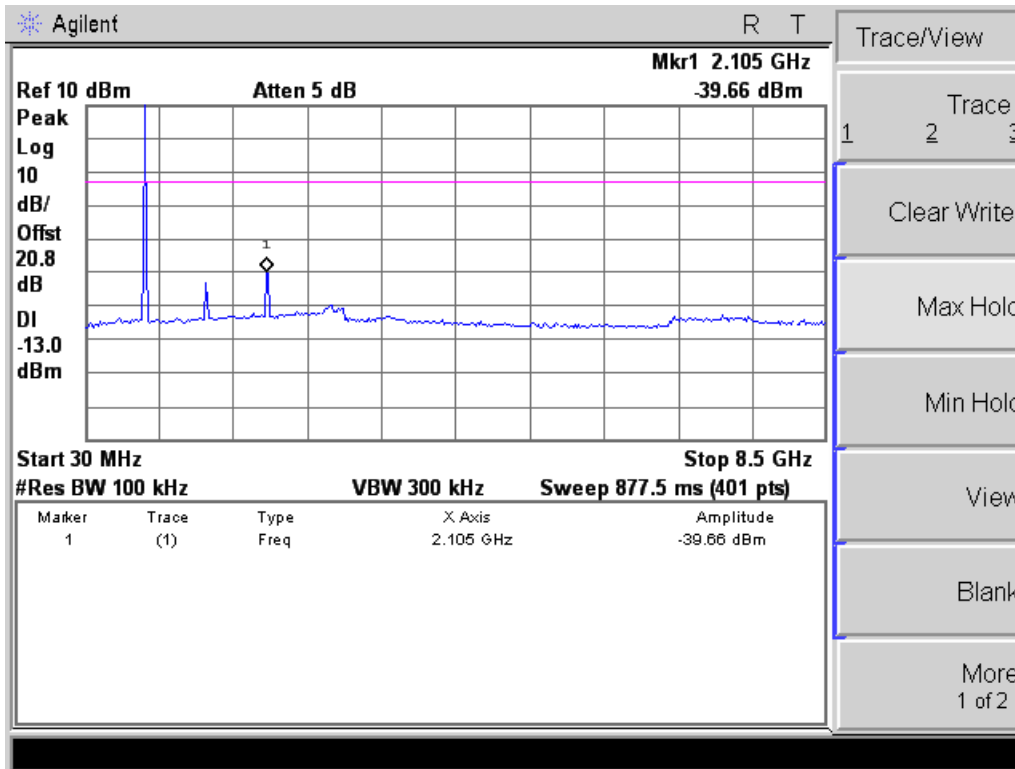

#### 776 - 787 MHz Band

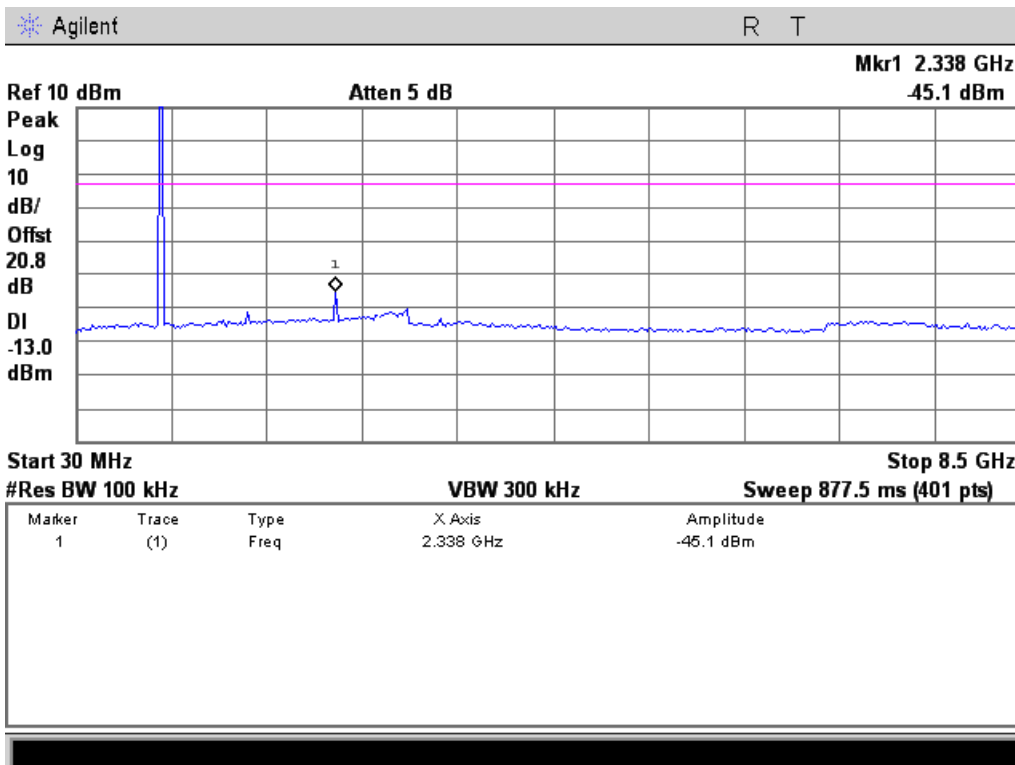



### 824 - 849 MHz Band

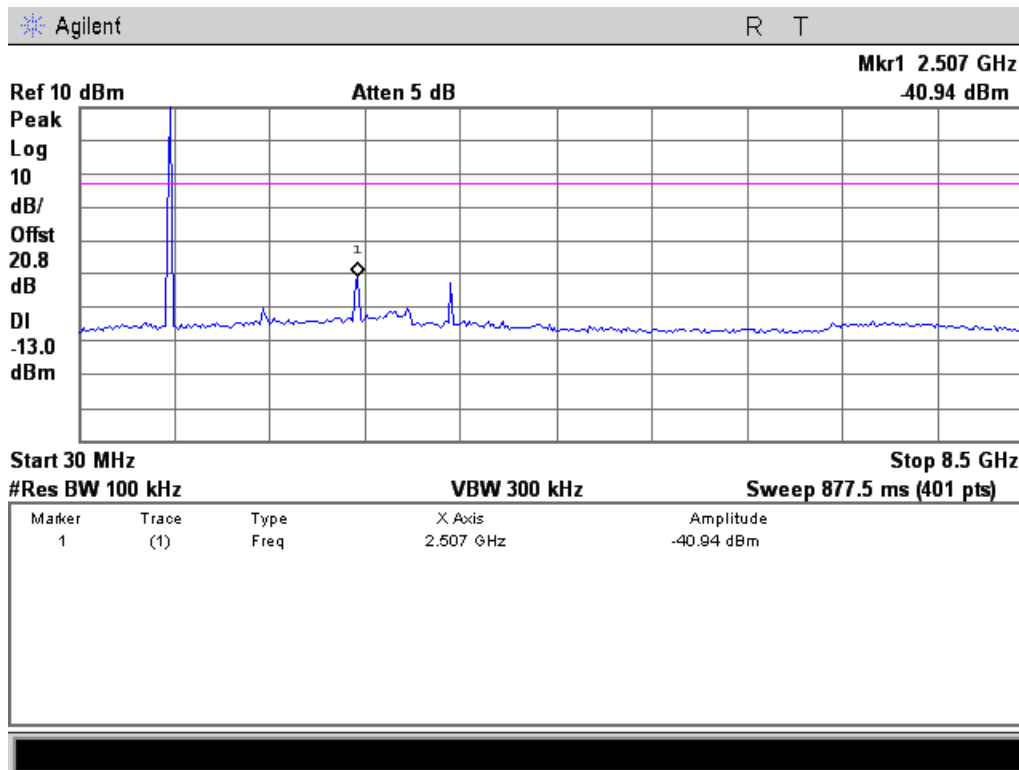

### 1710 - 1755 MHz Band

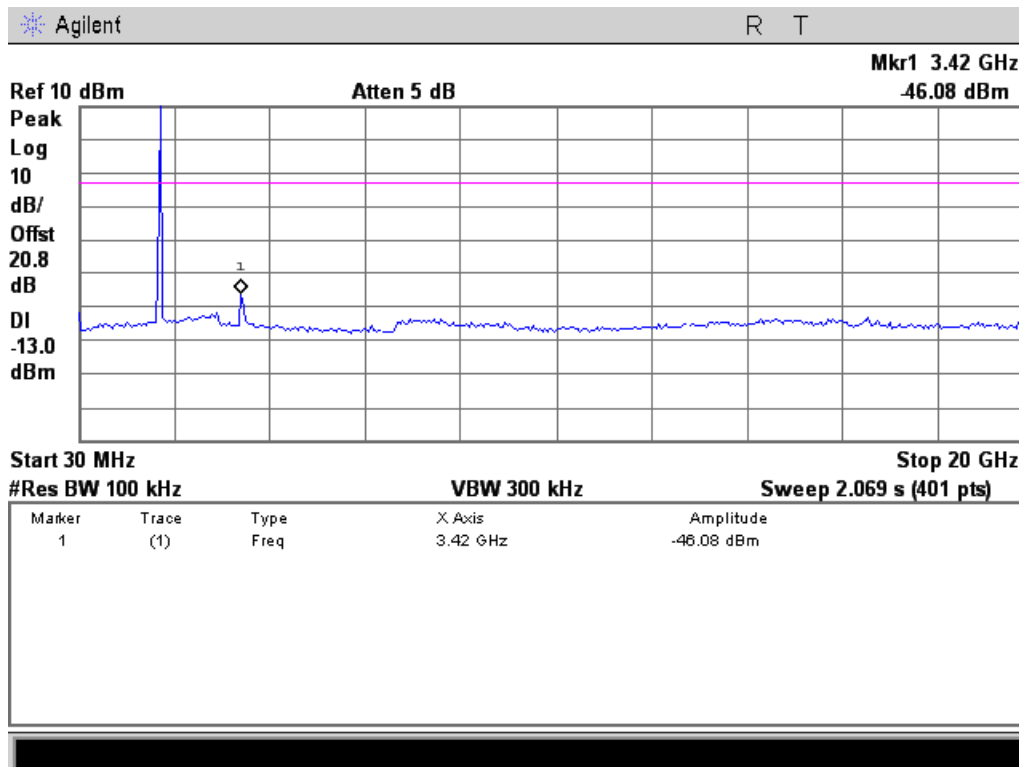



### 1850 - 1915 MHz Band

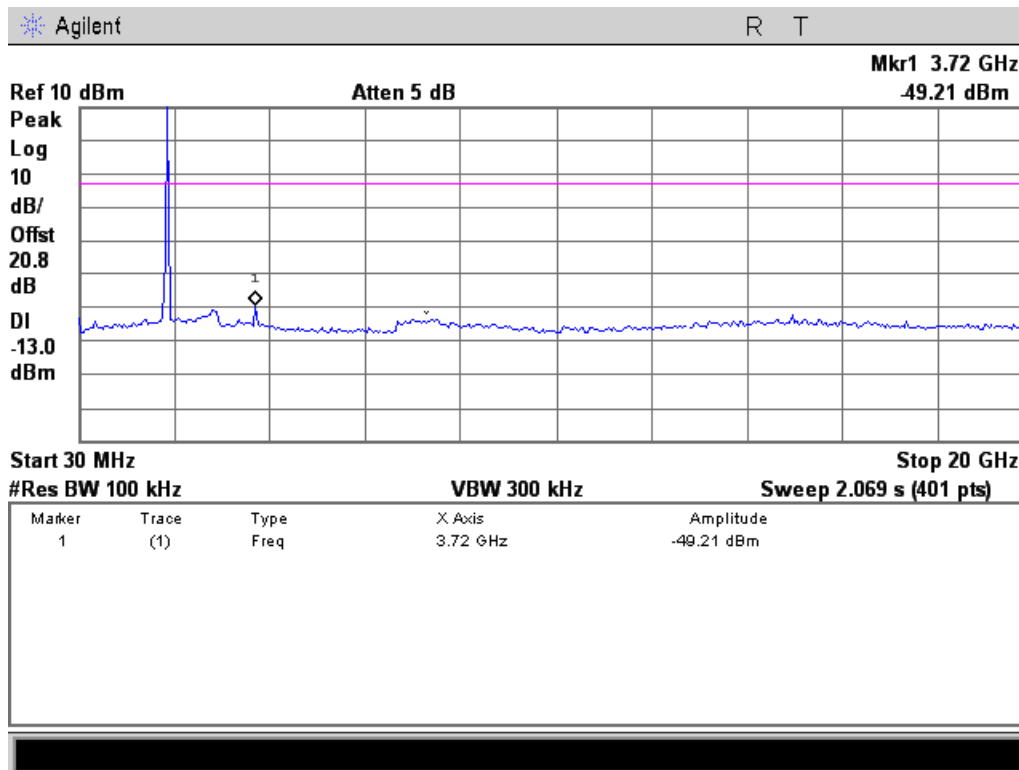

### Downlink Test Plots

### 728 - 746 MHz Band

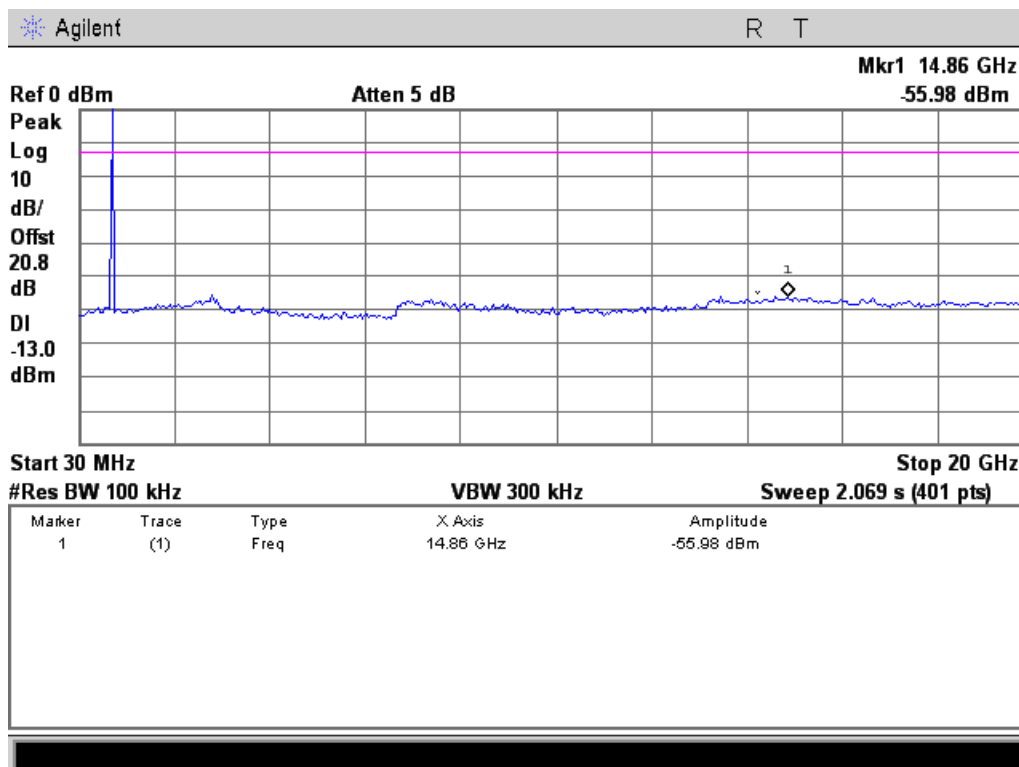



### 746 - 757 MHz Band

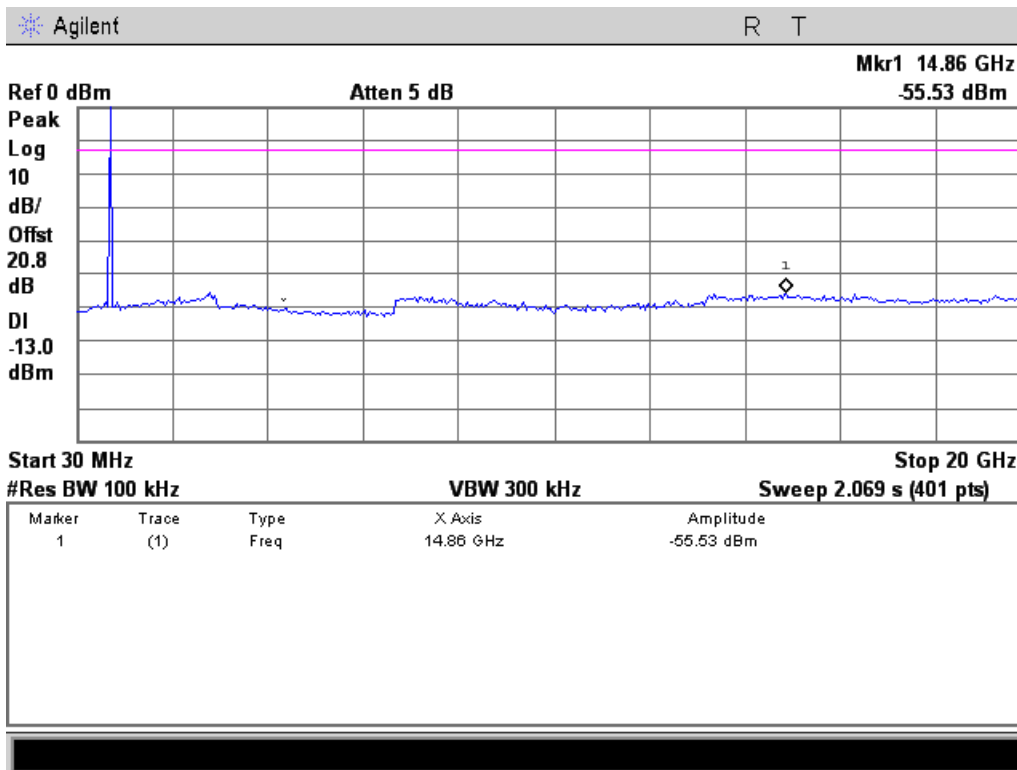

### 869 - 894 MHz Band

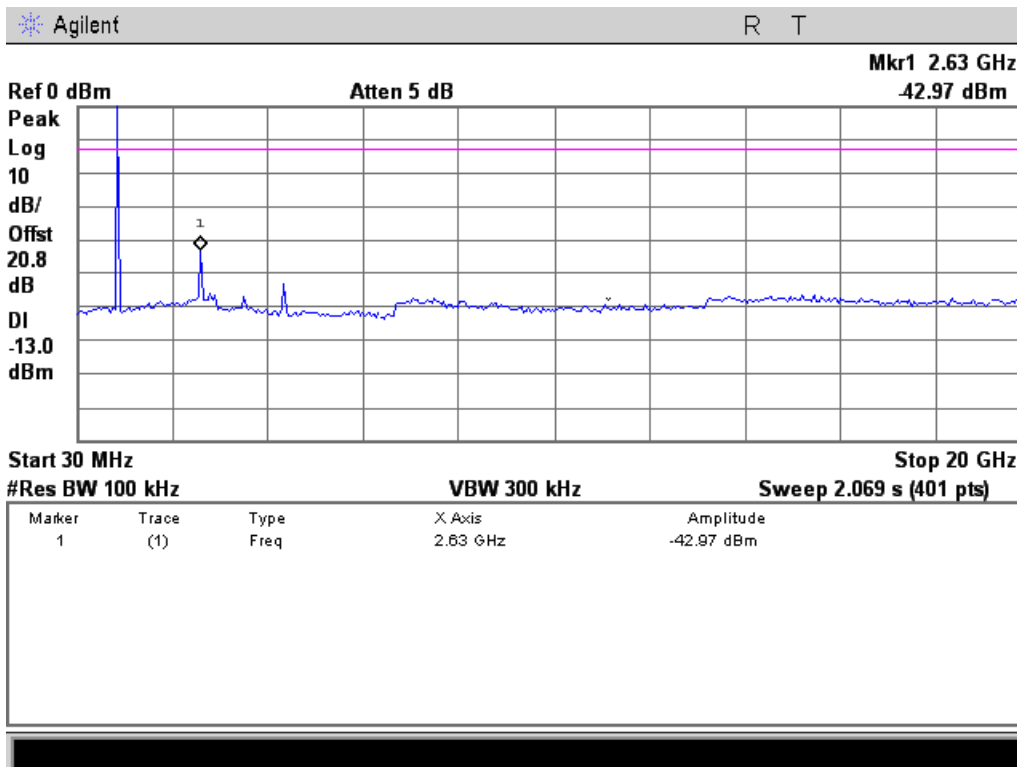



### 1930 - 1995 MHz Band

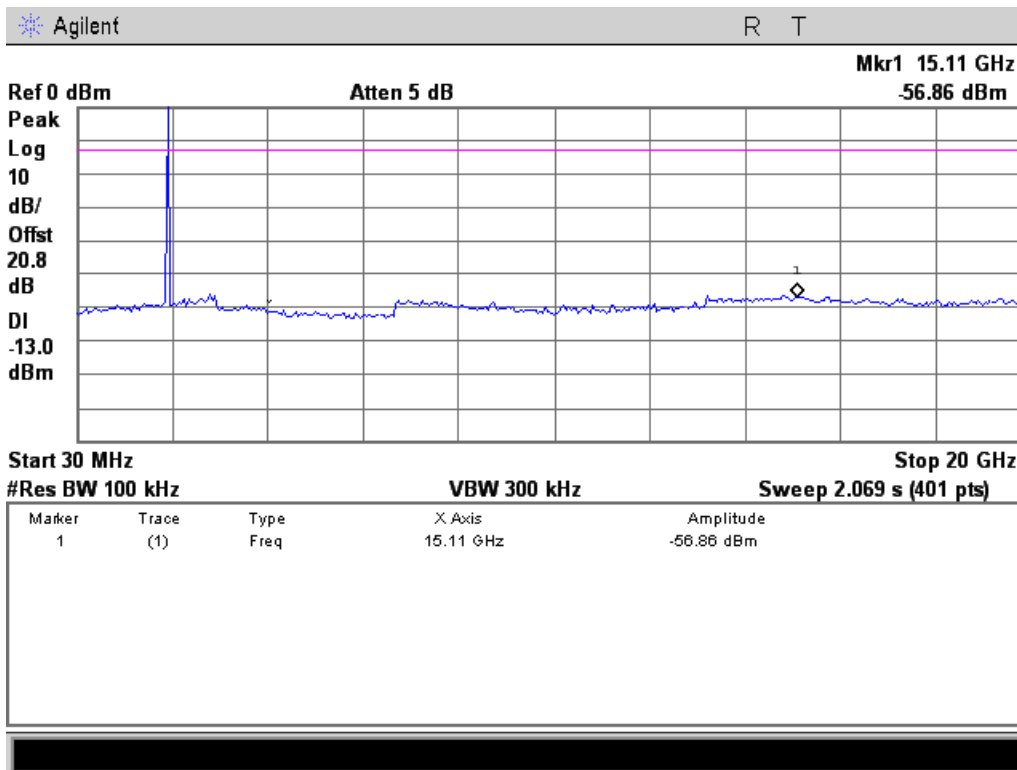

### 2110 - 2155 MHz Band

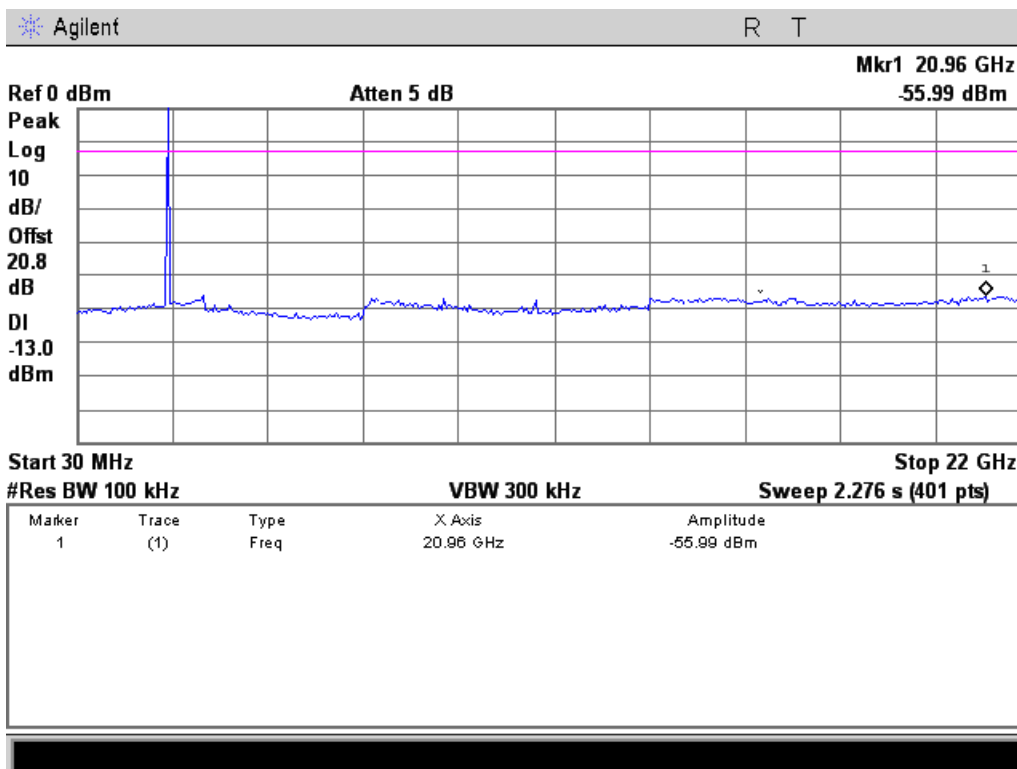



## Spurious Emissions (Transmitter Radiated)

**Name of Test:** Spurious Emissions (Transmitter Radiated)  
**Test Equipment Utilized:** i00103, i00331, i00348

**Engineer:** John Erhard  
**Test Date:** 10/01/2012

### Test Procedure

- A) Connect the equipment as illustrated below.
- B) Adjust the spectrum analyzer to the following settings:
  - 1) Resolution Bandwidth 100 kHz (< 1 GHz), 1 MHz (> 1GHz)
  - 2) Video Bandwidth  $\geq 3$  times Resolution Bandwidth, or 30 kHz
  - 3) Sweep Speed  $\leq 2000$  Hz/second
  - 4) Detector Mode = Mean or Average Power
- C) Place the transmitter to be tested on the turntable in the standard test site. The transmitter is transmitting into a non-radiating load that is placed on the turntable. The RF cable to this load should be of minimum length.
- D) For each spurious measurement the test antenna should be adjusted to the correct length for the frequency involved. This length may be determined from a calibration ruler supplied with the equipment. Measurements shall be made from the lowest radio frequency generated in the equipment to the tenth harmonic of the carrier, except for the region close to the carrier equal to  $\pm$  the test bandwidth (see Section 1.3.4.4).
- E) For each spurious frequency, raise and lower the test antenna from 1 m to 4 m to obtain a maximum reading on the spectrum analyzer with the test antenna at horizontal polarity. Repeat this procedure to obtain the highest possible reading. Record this maximum reading.
- F) Repeat Step E) for each spurious frequency with the test antenna polarized vertically.
- G) Reconnect the equipment as illustrated.
- H) Keep the spectrum analyzer adjusted as in Step B).
- I) Remove the transmitter and replace it with a substitution antenna (the antenna should be half wavelength for each frequency involved). The center of the substitution antenna should be approximately at the same location as the center of the transmitter. At lower frequencies, where the substitution antenna is very long, this will be impossible to achieve when the antenna is polarized vertically. In such case the lower end of the antenna should be 0.3 m above the ground.
- J) Feed the substitution antenna at the transmitter end with a signal generator connected to the antenna by means of a non-radiating cable. With the antennas at both ends horizontally polarized and with the signal generator tuned to a particular spurious frequency, raise and lower the test antenna to obtain a maximum reading at the spectrum analyzer. Adjust the level of the signal generator output until the previously recorded maximum reading for this set of conditions is obtained. This should be done carefully repeating the adjustment of the test antenna and generator output.
- K) Repeat Step J) with both antennas vertically polarized for each spurious frequency.
- L) Calculate power in dBm into a reference ideal half-wave dipole antenna by reducing the readings obtained in Steps J) and K) by the power loss in the cable between the generator and the antenna and further corrected for the gain of the substitution antenna used relative to an ideal half-wave dipole antenna.
- M) The levels recorded in Step L) are absolute levels of radiated spurious emissions in dBm. The radiated spurious emissions in dB can be calculated by the following:  
$$\text{Radiated spurious emissions dB} = 10\log_{10}(\text{TX power in watts}/0.001) - \text{the levels in Step I)}$$

*NOTE: It is permissible that the other antennas provided can be referenced to a dipole.*





### Test Setup

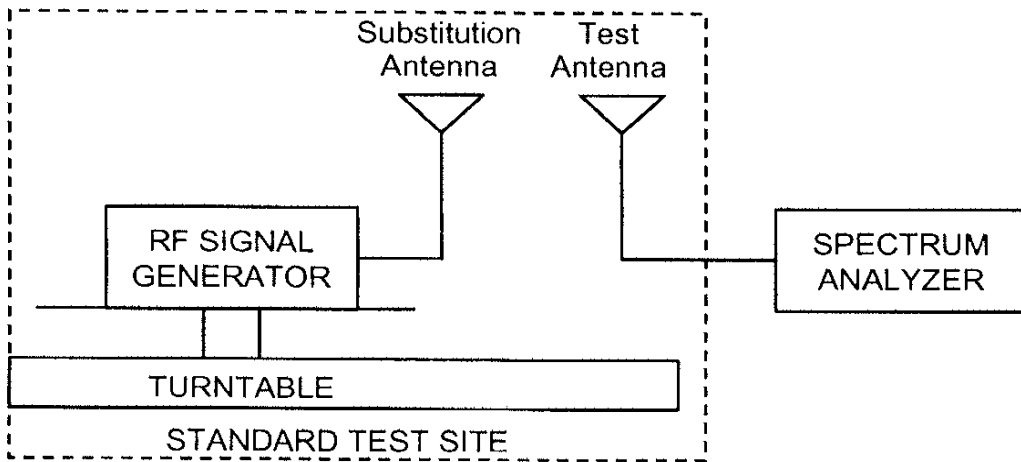
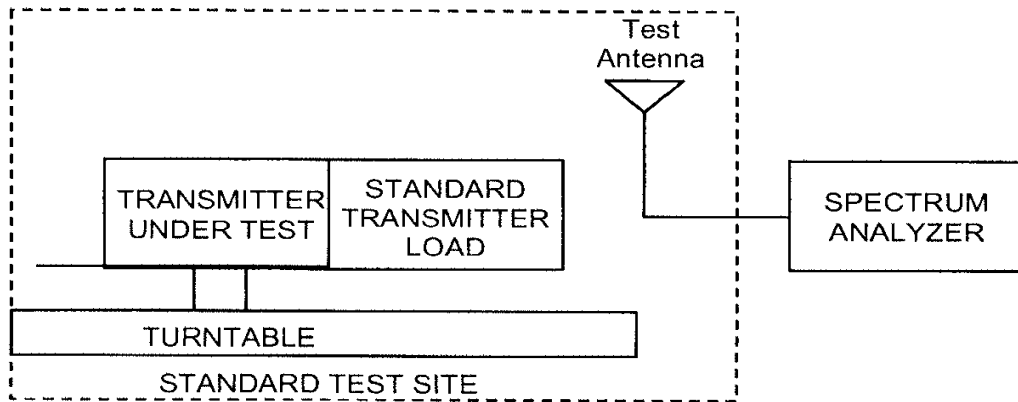



## Uplink Test Results

### 698 - 716 MHz Band 707 MHz Tuned Frequency

Measured Frequency (MHz)	Measured Level (dBm)	Limit (dBm)	Margin (dB)	Result
1414	-58.19	-13	-45.19	Pass
2121	-56.55	-13	-43.55	Pass
2828	-50.42	-13	-37.42	Pass

### 776 - 787 MHz Band 781.5 MHz Tuned Frequency

Measured Frequency (MHz)	Measured Level (dBm)	Limit (dBm)	Margin (dB)	Result
1563	-57.04	-13	-44.04	Pass
2344.5	-53.32	-13	-40.32	Pass
3126	-51.00	-13	-38	Pass

### 824 - 849 MHz Band 836 MHz Tuned Frequency

Measured Frequency (MHz)	Measured Level (dBm)	Limit (dBm)	Margin (dB)	Result
1672	-56.60	-13	-43.6	Pass
2508	-53.94	-13	-40.94	Pass
3344	-49.83	-13	-36.83	Pass

### 1710 - 1755 MHz Band 1742 MHz Tuned Frequency

Measured Frequency (MHz)	Measured Level (dBm)	Limit (dBm)	Margin (dB)	Result
3484	-48.46	-13	-35.46	Pass
5226	-53.01	-13	-40.01	Pass
6968	-45.00	-13	-32	Pass

### 1850 - 1915 MHz Band 1880 MHz Tuned Frequency

Measured Frequency (MHz)	Measured Level (dBm)	Limit (dBm)	Margin (dB)	Result
3760	-49.25	-13	-36.25	Pass
5640	-51.41	-13	-38.41	Pass
7520	-41.48	-13	-28.48	Pass

The conducted spurious emissions testing did not indicate any potential failures therefore only the center channel of each operational band was evaluated.

No other emissions were detected. All emissions were lower than -13 dBm.  
All emissions were system noise floor.



**Downlink Test Results**

**728 - 746 MHz Band 737 MHz Tuned Frequency**

Measured Frequency (MHz)	Measured Level (dBm)	Limit (dBm)	Margin (dB)	Result
1474	-60.79	-13	-47.79	Pass
2211	-54.15	-13	-41.15	Pass
2948	-48.17	-13	-35.17	Pass

**746 - 757 MHz Band 751 MHz Tuned Frequency**

Measured Frequency (MHz)	Measured Level (dBm)	Limit (dBm)	Margin (dB)	Result
1502	-53.67	-13	-40.67	Pass
2253	-57.79	-13	-44.79	Pass
3004	-53.26	-13	-40.26	Pass

**869 - 894 MHz Band 881 MHz Tuned Frequency**

Measured Frequency (MHz)	Measured Level (dBm)	Limit (dBm)	Margin (dB)	Result
1762	-59.72	-13	-46.72	Pass
2643	-53.37	-13	-40.37	Pass
3524	-53.54	-13	-40.54	Pass

**1930 - 1995 MHz Band 1960 MHz Tuned Frequency**

Measured Frequency (MHz)	Measured Level (dBm)	Limit (dBm)	Margin (dB)	Result
3920	-53.62	-13	-40.62	Pass
5880	-50.65	-13	-37.65	Pass
7840	-43.28	-13	-30.28	Pass

**2110 - 2155 MHz Band 2132 MHz Tuned Frequency**

Measured Frequency (MHz)	Measured Level (dBm)	Limit (dBm)	Margin (dB)	Result
4264	-52.28	-13	-39.28	Pass
6396	-50.56	-13	-37.56	Pass
8528	-48.46	-13	-35.46	Pass

The conducted spurious emissions testing did not indicate any potential failures therefore only the center channel of each operational band was evaluated.

No other emissions were detected. All emissions were lower than -13 dBm. All emissions were system noise floor.



## Intermodulation

**Name of Test:** Intermodulation  
**Test Equipment Utilized:** i00266, i00331, i00348, i00347

**Engineer:** John Erhard  
**Test Date:** 10/01/2012

### Test Procedure

The EUT was connected to a spectrum analyzer through a 20 dB power attenuator. Two signal generators were utilized to produce a two tone signal with the channel spacing set so the intermodulation products fell within the operational band. The input signal level was increased until the intermodulation products were as close as possible to the maximum allowable level of -13 dBm without being greater than that limit. The uplink / downlink intermodulation products within the operational band were examined. The two tones near the lower edge and the upper edge were plotted. The input signal level, peak output power, and intermodulation level are listed in the summary tables.

### Test Setup

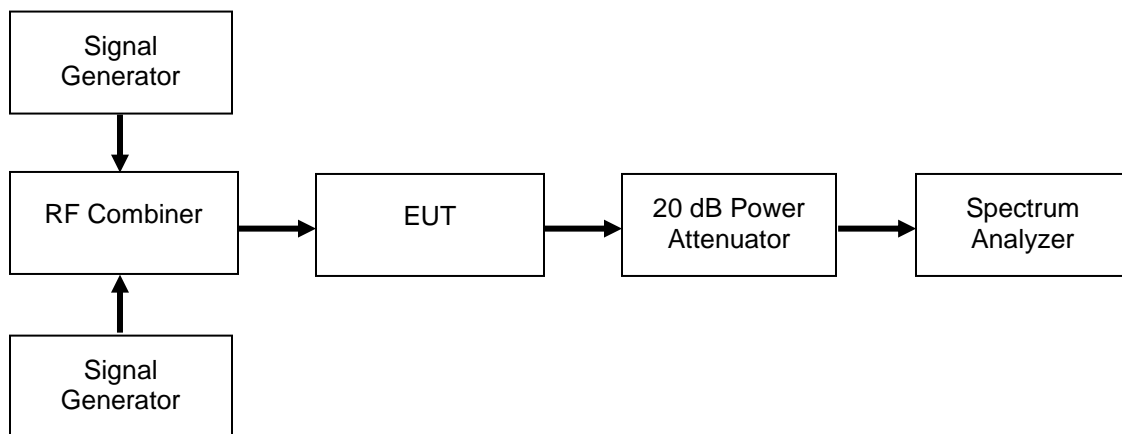



### GSM Uplink Test Results

#### 698 - 716 MHz Band

$P_{01} - P_{02}$ Frequency Pair (MHz)	Input Power (dBm)	Intermodulation Level (dBm)	$P_{01}$ (dBm)	$P_{mean}$ (dBm)	Gain (dB)
703 – 708	-6.2	1.1	-13.3	20.33	23.33
706 – 711	-6.2	2.6	-13.18	21.24	24.24

#### 776 - 787 MHz Band

$P_{01} - P_{02}$ Frequency Pair (MHz)	Input Power (dBm)	Intermodulation Level (dBm)	$P_{01}$ (dBm)	$P_{mean}$ (dBm)	Gain (dB)
779 – 782	-6.2	2.3	-13.18	19.08	22.08
781 – 784	-6.2	2.3	-13.19	19.18	22.18

#### 824 - 849 MHz Band

$P_{01} - P_{02}$ Frequency Pair (MHz)	Input Power (dBm)	Intermodulation Level (dBm)	$P_{01}$ (dBm)	$P_{mean}$ (dBm)	Gain (dB)
830 – 835	-6.8	0	-13.31	20.5	23.5
842 – 845	-6.8	0.2	-13.32	19.95	22.95

#### 1710 - 1755 MHz Band

$P_{01} - P_{02}$ Frequency Pair (MHz)	Input Power (dBm)	Intermodulation Level (dBm)	$P_{01}$ (dBm)	$P_{mean}$ (dBm)	Gain (dB)
1720 – 1725	-6.5	-1.9	-13.08	17.14	20.14
1740 – 1745	-6.5	-0.4	-13.68	18.94	21.94

#### 1850 - 1915 MHz Band

$P_{01} - P_{02}$ Frequency Pair (MHz)	Input Power (dBm)	Intermodulation Level (dBm)	$P_{01}$ (dBm)	$P_{mean}$ (dBm)	Gain (dB)
1860 – 1865	-6.6	0.8	-13.34	19.09	22.09
1895 - 1900	-6.6	1.4	-13.15	17.75	20.75



## GSM Downlink Test Results

### 728 - 746 MHz Band

<b>P<sub>01</sub> – P<sub>02</sub> Frequency Pair (MHz)</b>	<b>Input Power (dBm)</b>	<b>Intermodulation Level (dBm)</b>	<b>P<sub>01</sub> (dBm)</b>	<b>P<sub>mean</sub> (dBm)</b>	<b>Gain (dB)</b>
733 – 738	-6.2	-16.6	-13.55	-1.36	1.64
736 – 741	-6.2	-17.8	13.1	-1.25	1.75

### 746 - 757 MHz Band

<b>P<sub>01</sub> – P<sub>02</sub> Frequency Pair (MHz)</b>	<b>Input Power (dBm)</b>	<b>Intermodulation Level (dBm)</b>	<b>P<sub>01</sub> (dBm)</b>	<b>P<sub>mean</sub> (dBm)</b>	<b>Gain (dB)</b>
750 – 752	-6.2	-13.8	-13.11	0.69	3.69
752 – 754	-6.2	-14.1	-13.3	-0.65	2.35

### 869 - 894 MHz Band

<b>P<sub>01</sub> – P<sub>02</sub> Frequency Pair (MHz)</b>	<b>Input Power (dBm)</b>	<b>Intermodulation Level (dBm)</b>	<b>P<sub>01</sub> (dBm)</b>	<b>P<sub>mean</sub> (dBm)</b>	<b>Gain (dB)</b>
875 – 880	-6.8	-15.7	-13.25	-1.57	1.43
880 – 885	-6.8	-15.3	-13.1	-1.05	1.95

### 1930 - 1995 MHz Band

<b>P<sub>01</sub> – P<sub>02</sub> Frequency Pair (MHz)</b>	<b>Input Power (dBm)</b>	<b>Intermodulation Level (dBm)</b>	<b>P<sub>01</sub> (dBm)</b>	<b>P<sub>mean</sub> (dBm)</b>	<b>Gain (dB)</b>
1940 – 1945	-6.6	-10.7	-13.16	4.2	7.2
1975 - 1980	-6.6	-11.4	-13.24	5.2	8.2

### 2110 - 2155 MHz Band

<b>P<sub>01</sub> – P<sub>02</sub> Frequency Pair (MHz)</b>	<b>Input Power (dBm)</b>	<b>Intermodulation Level (dBm)</b>	<b>P<sub>01</sub> (dBm)</b>	<b>P<sub>mean</sub> (dBm)</b>	<b>Gain (dB)</b>
2120 – 2125	-6.6	-8.1	-13.16	4.7	7.7
2140 - 2145	-6.6	-14.3	-13.48	3.78	6.78



### GSM Uplink Test Plots

#### 698 - 716 MHz Band

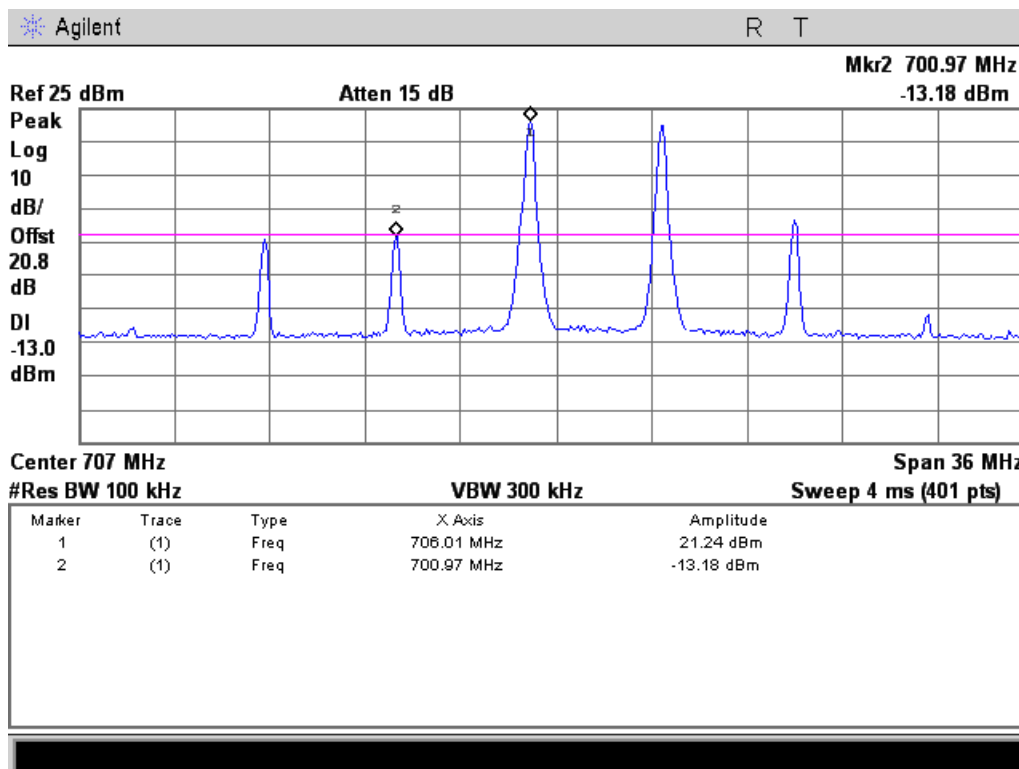
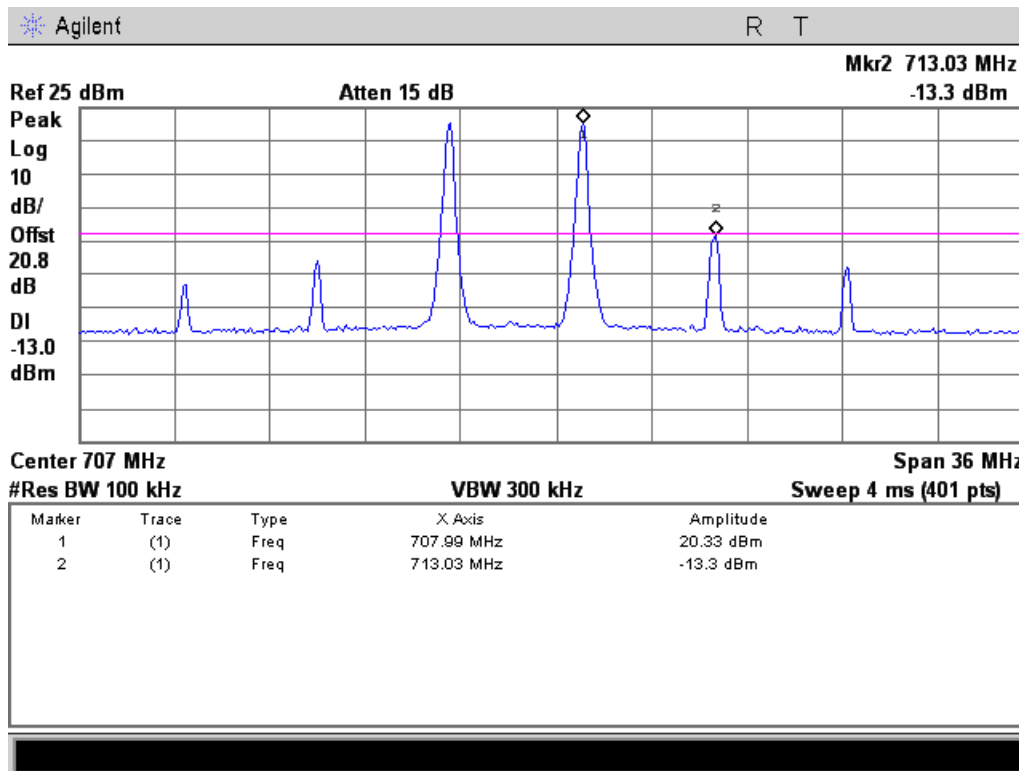



### 776 - 787 MHz Band

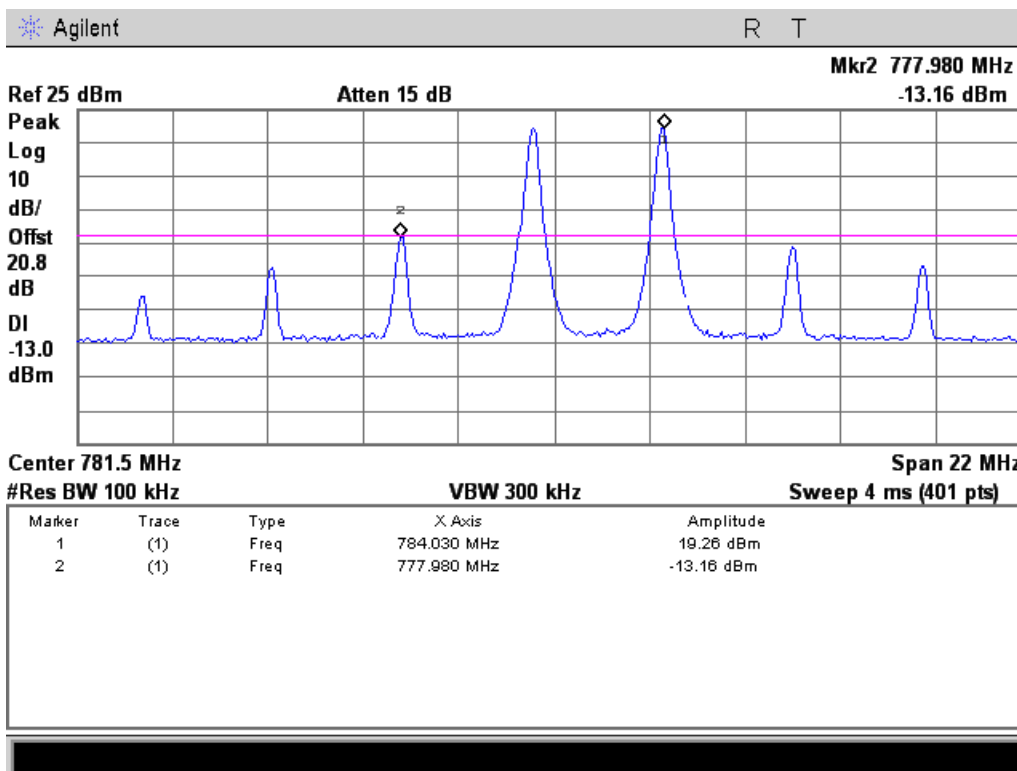
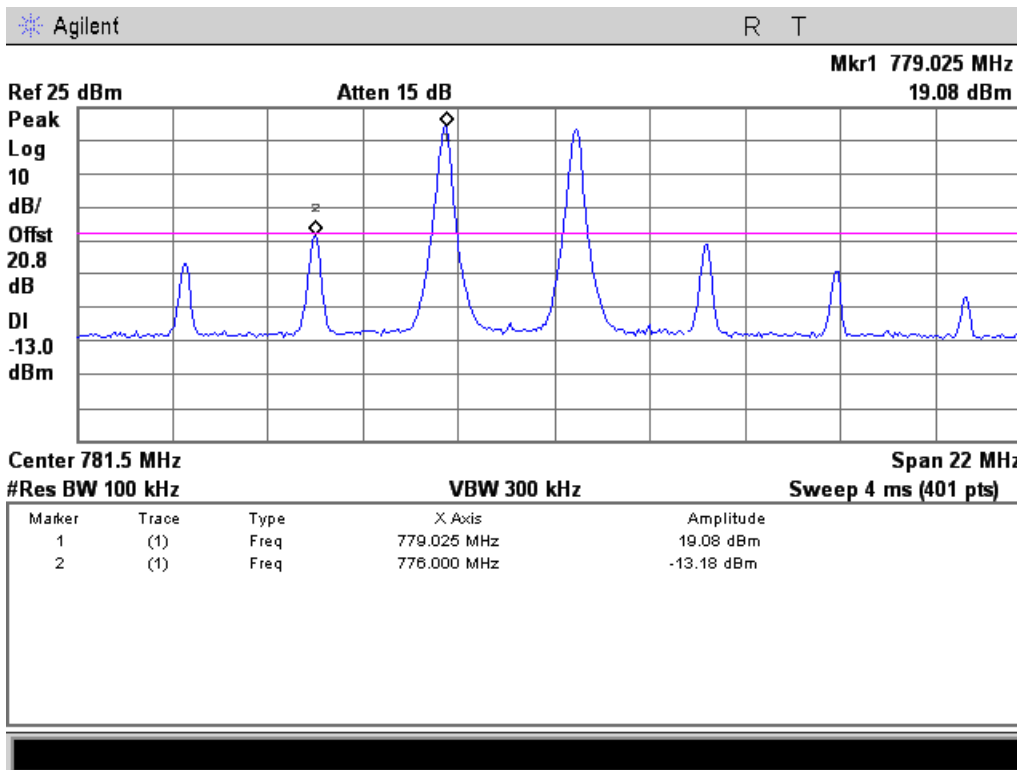





### 824 - 849 MHz Band

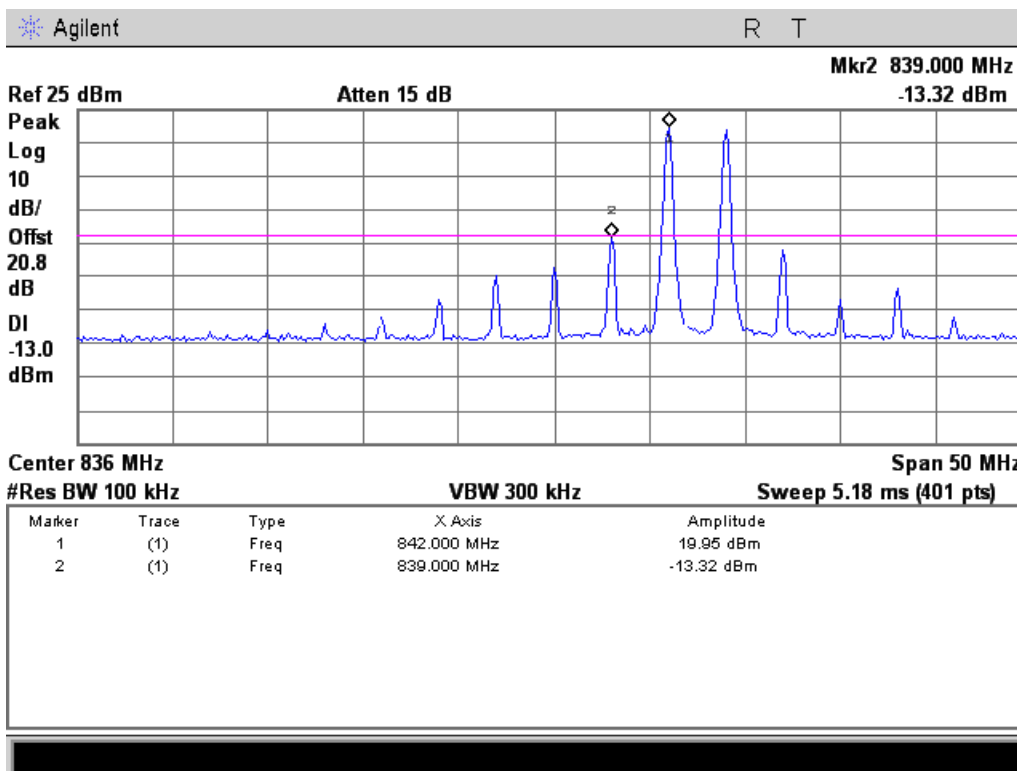
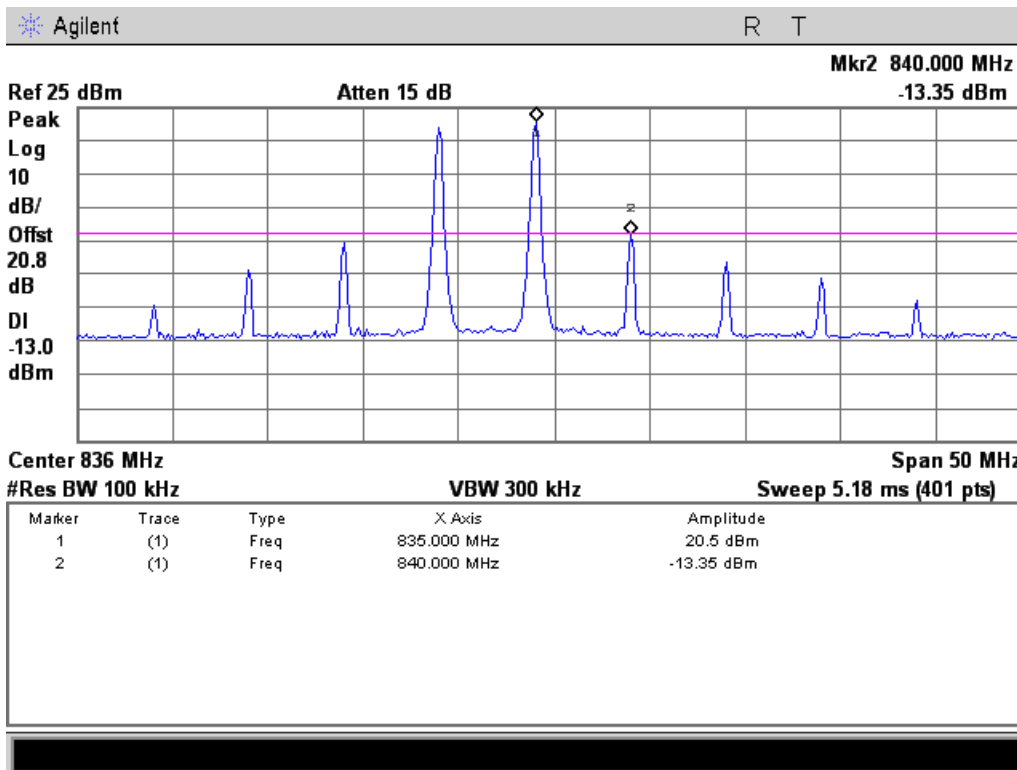



### 1710 - 1755 MHz Band

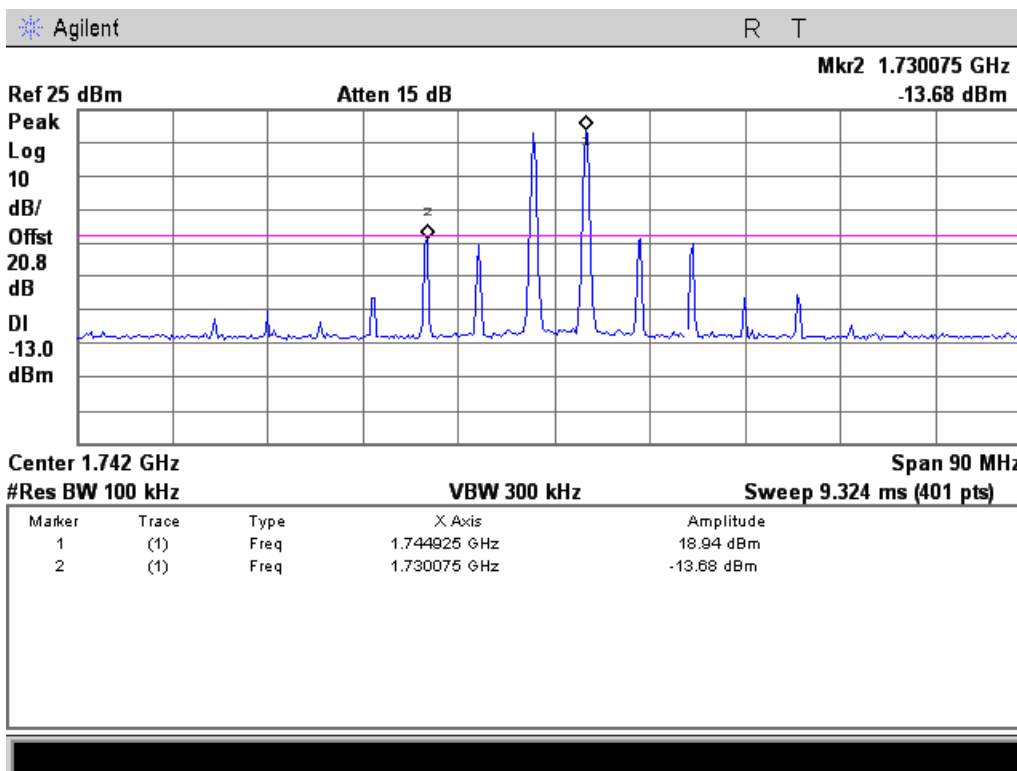
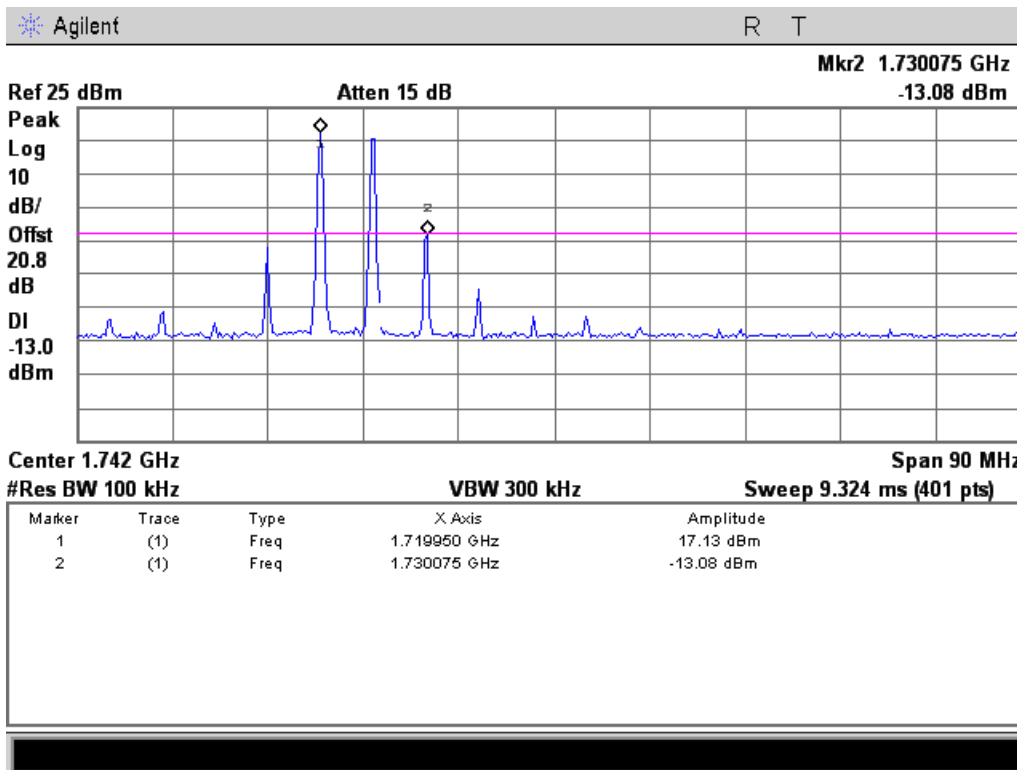



### 1850 - 1915 MHz Band

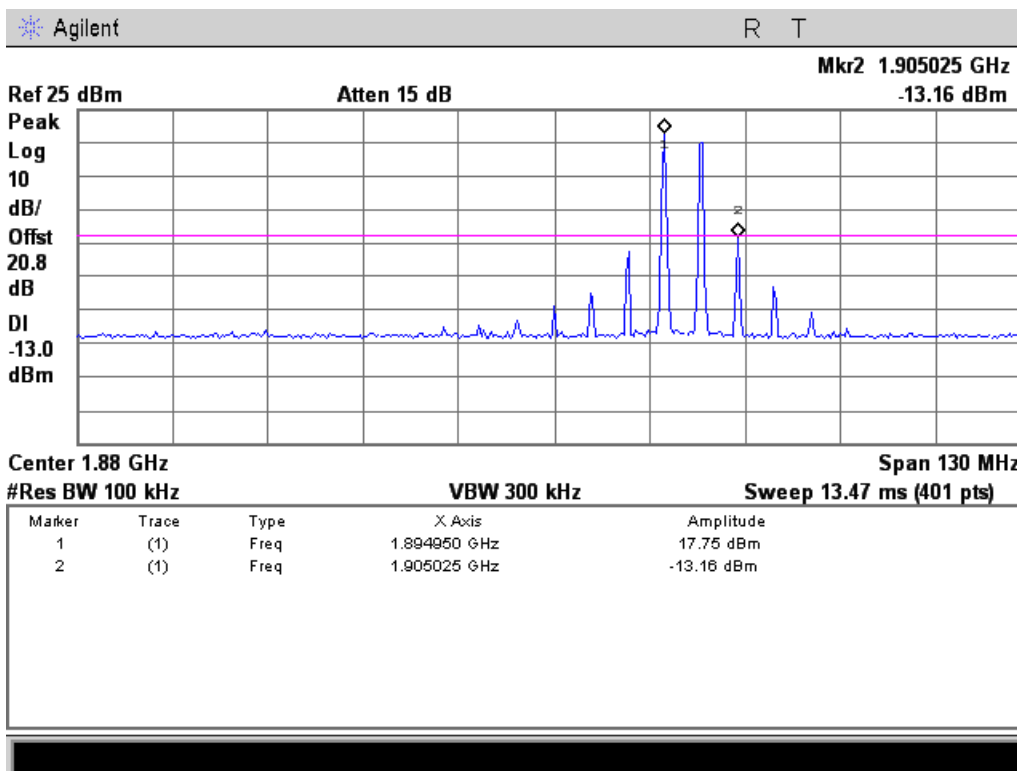
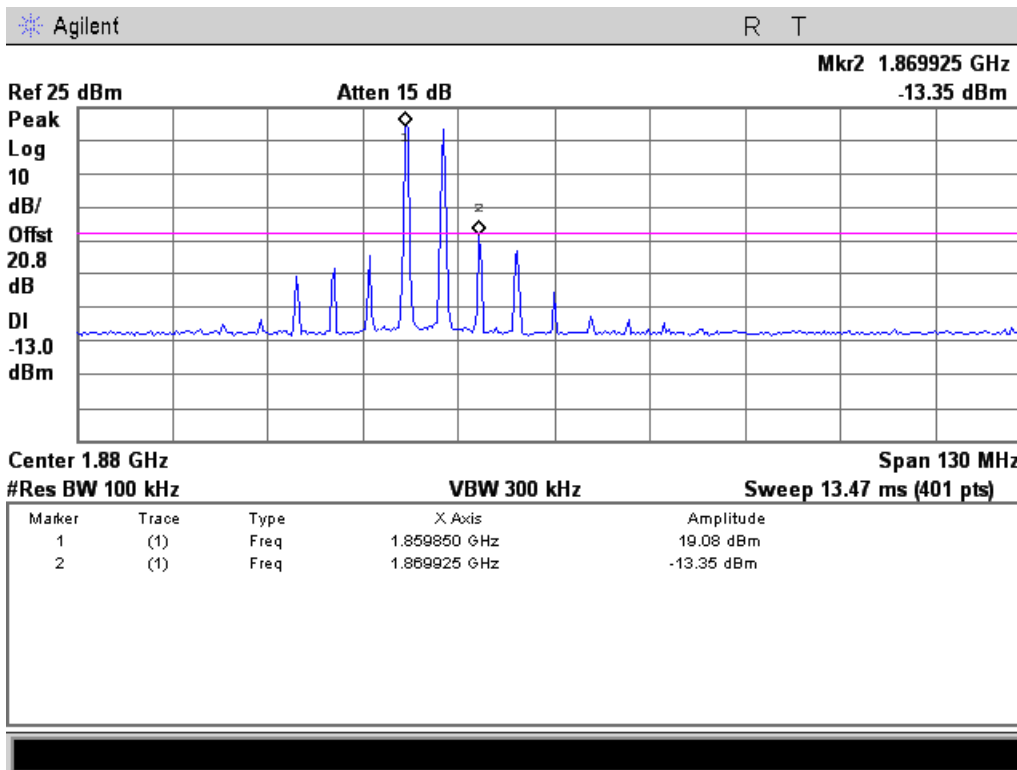



### GSM Downlink Test Plots

#### 728 - 746 MHz Band

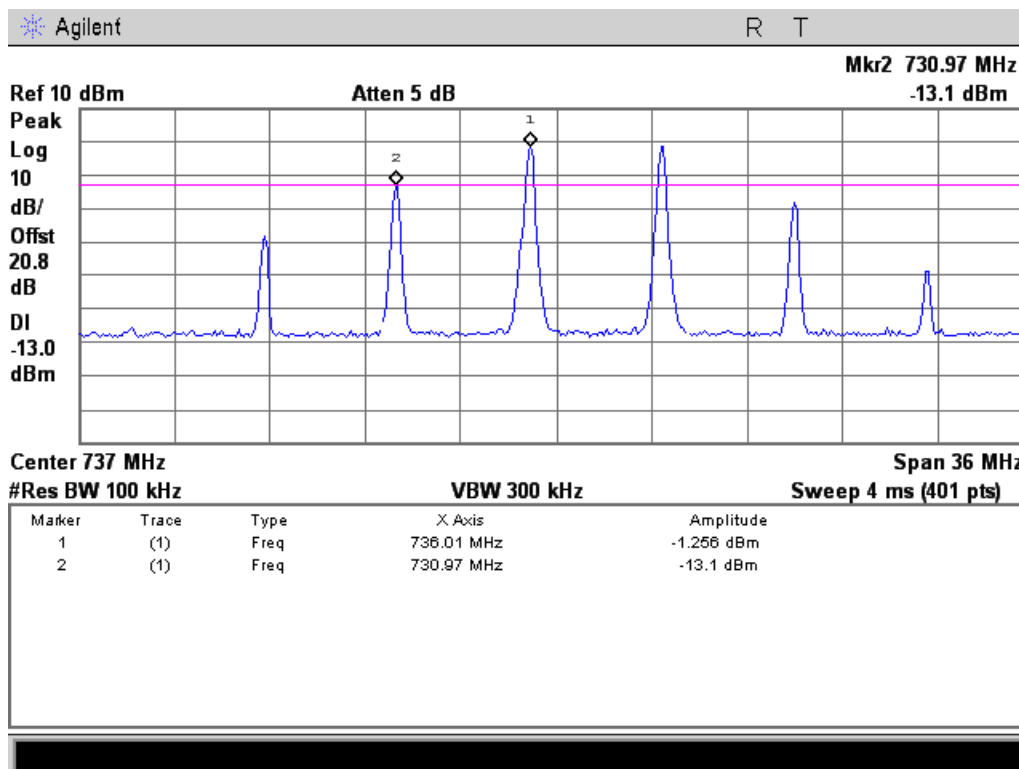
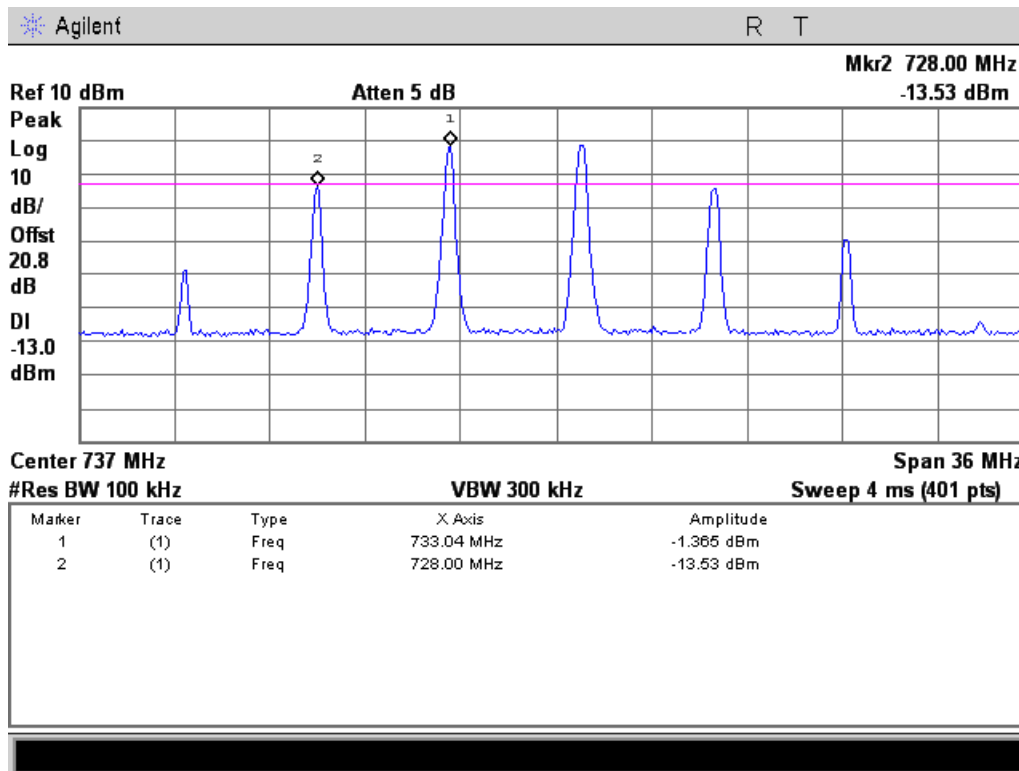



### 746 - 757 MHz Band

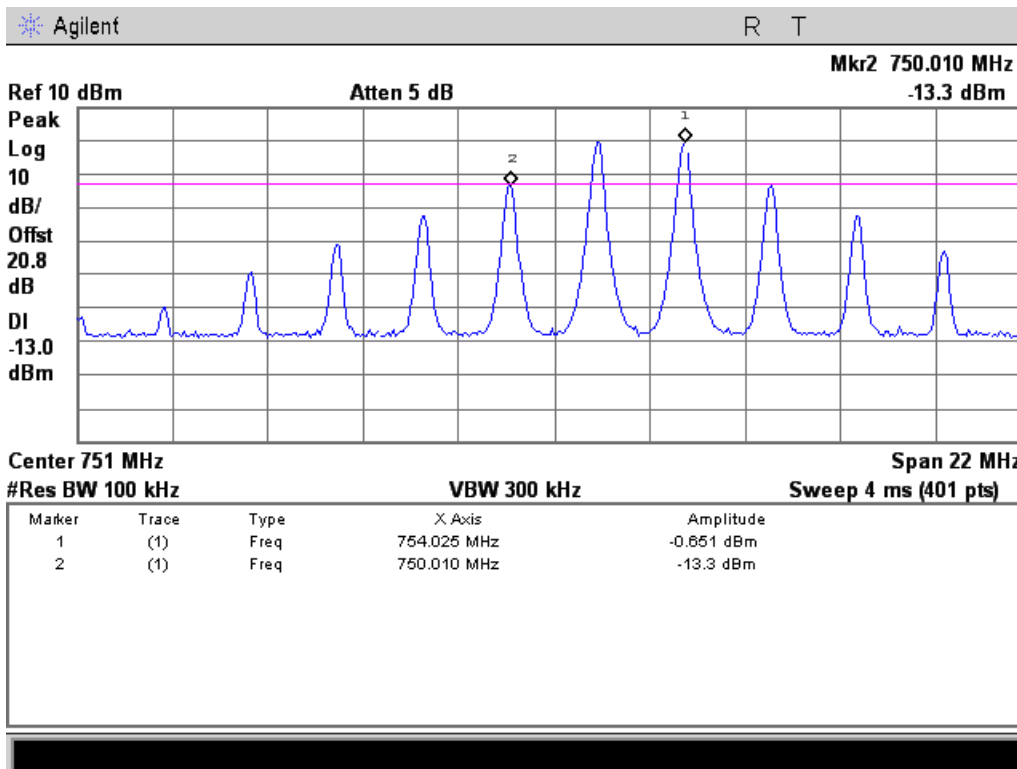
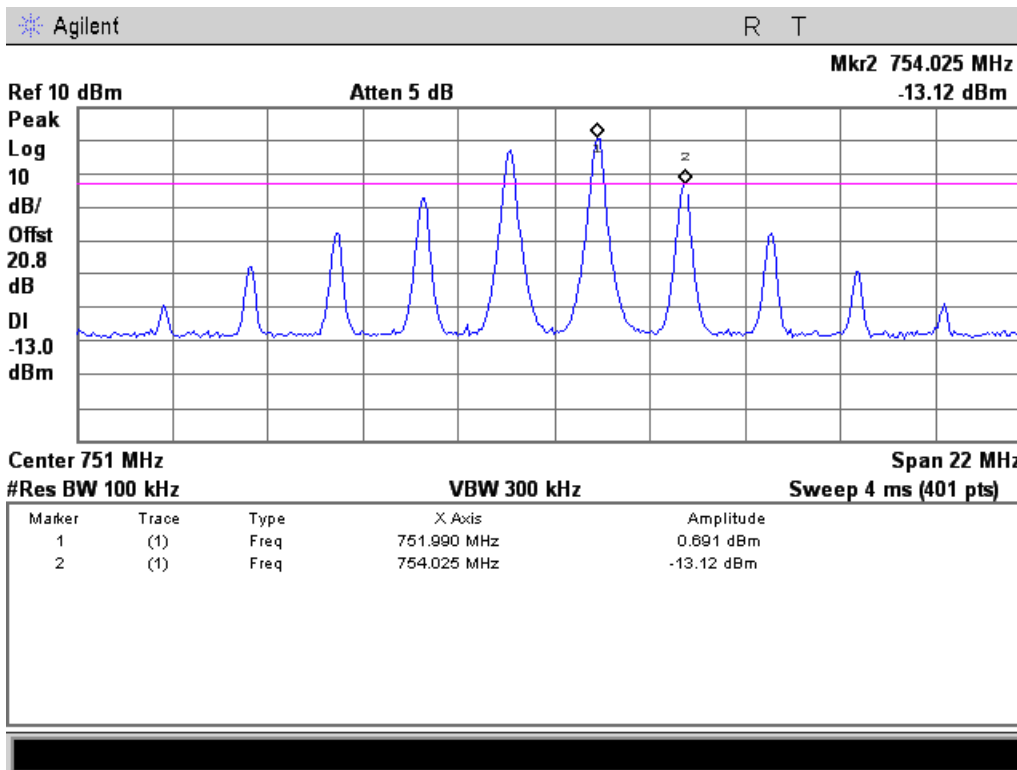



### 869 - 894 MHz Band

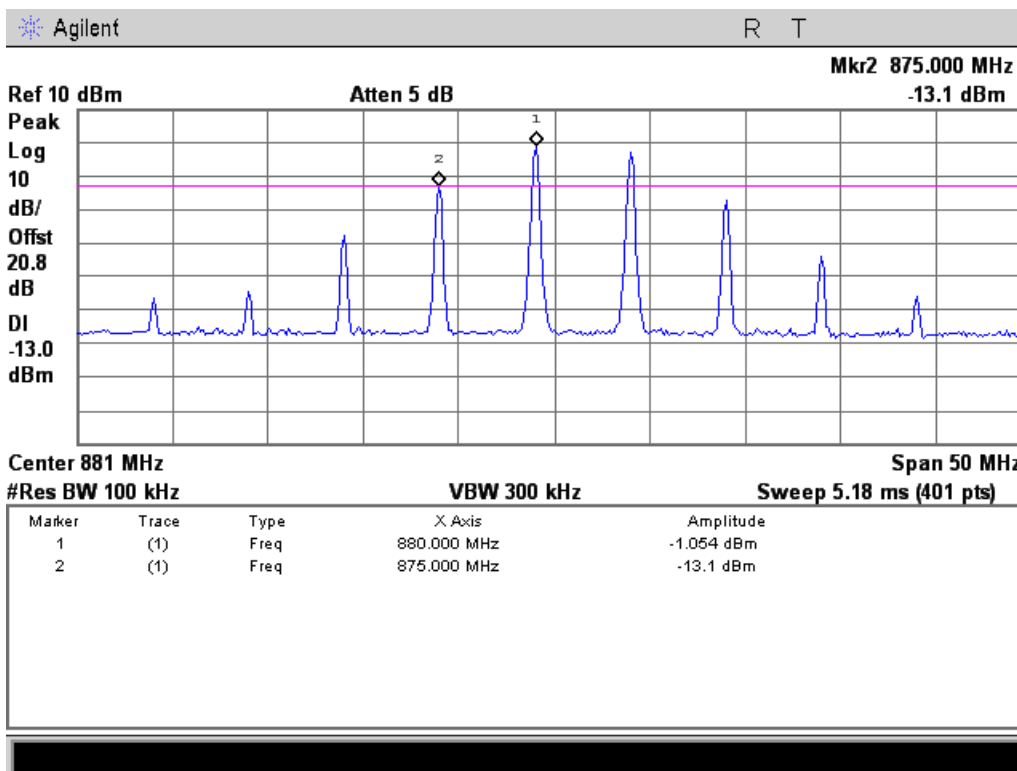
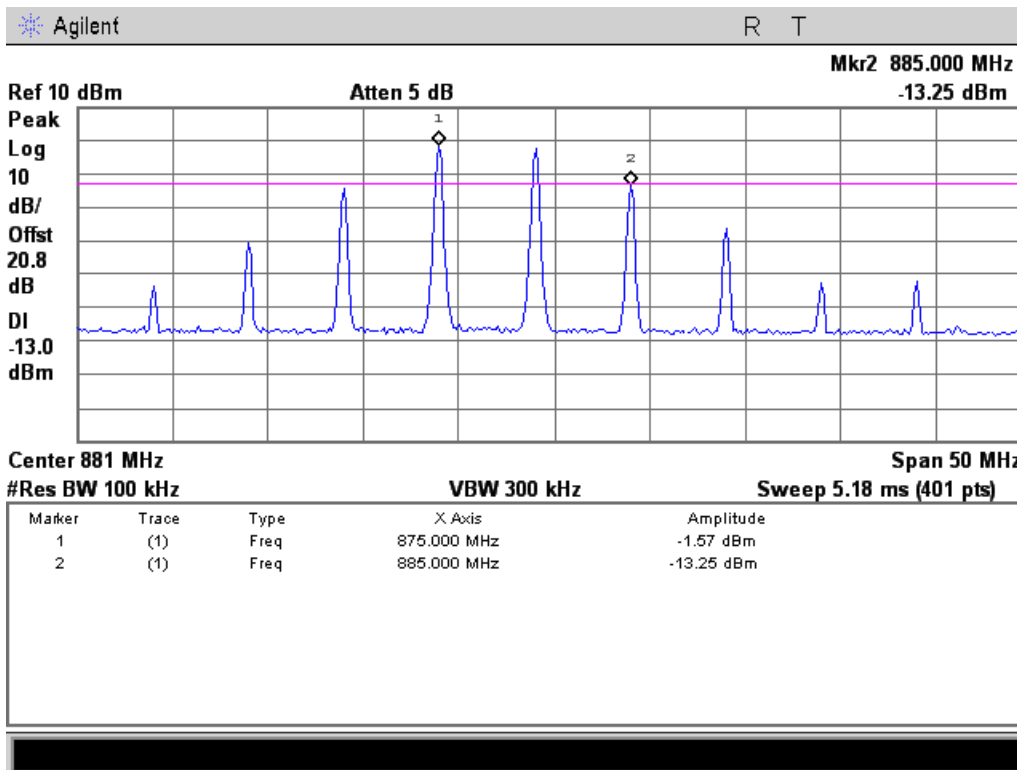



### 1930 - 1995 MHz Band

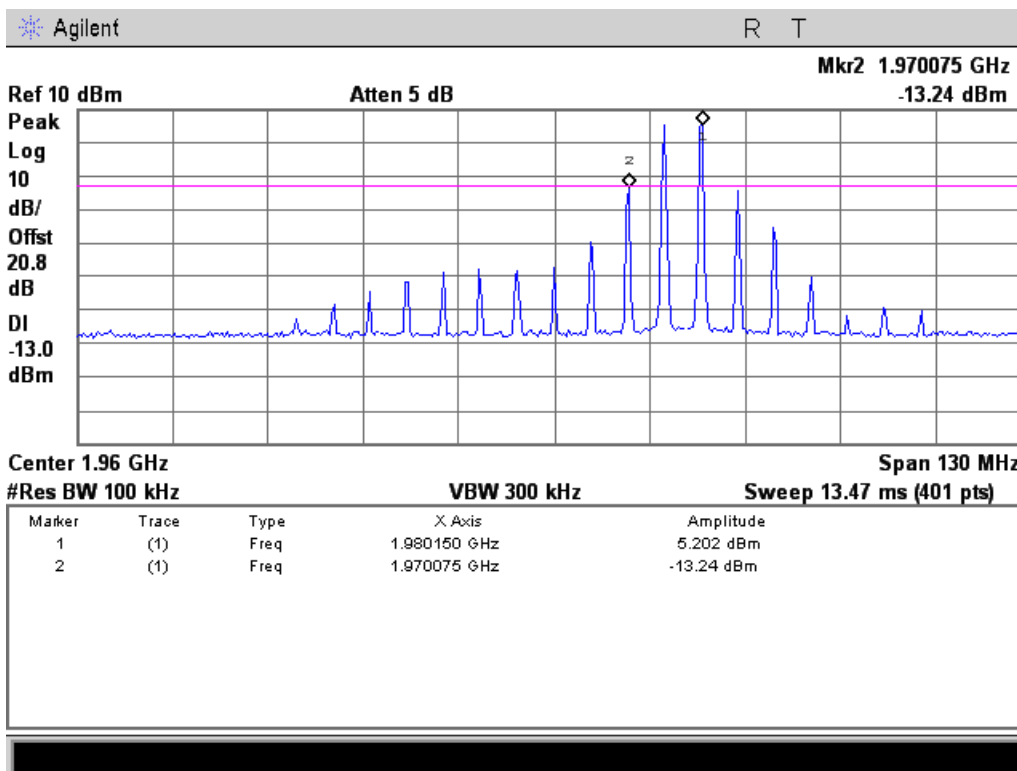
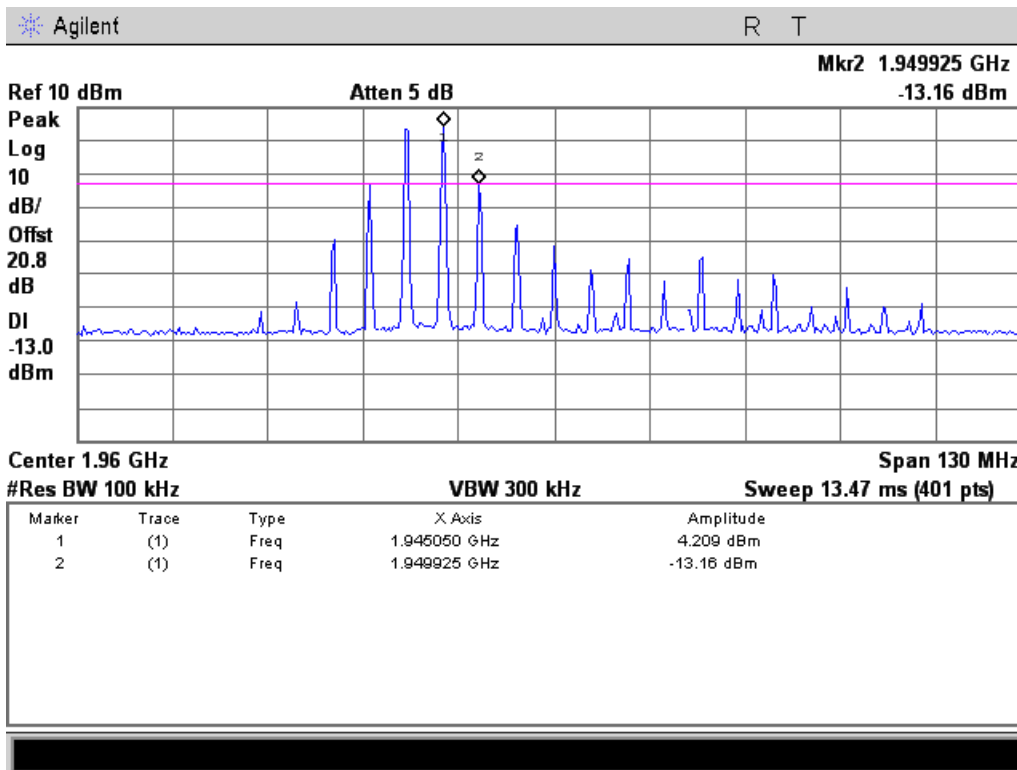



### 2110 - 2155 MHz Band

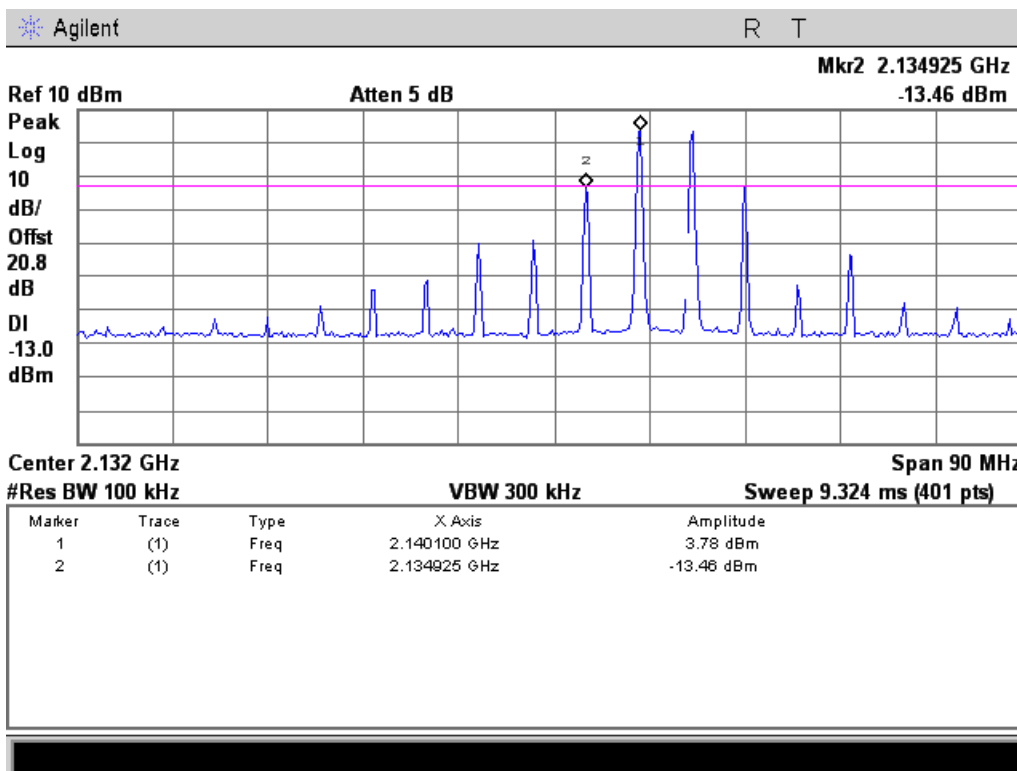
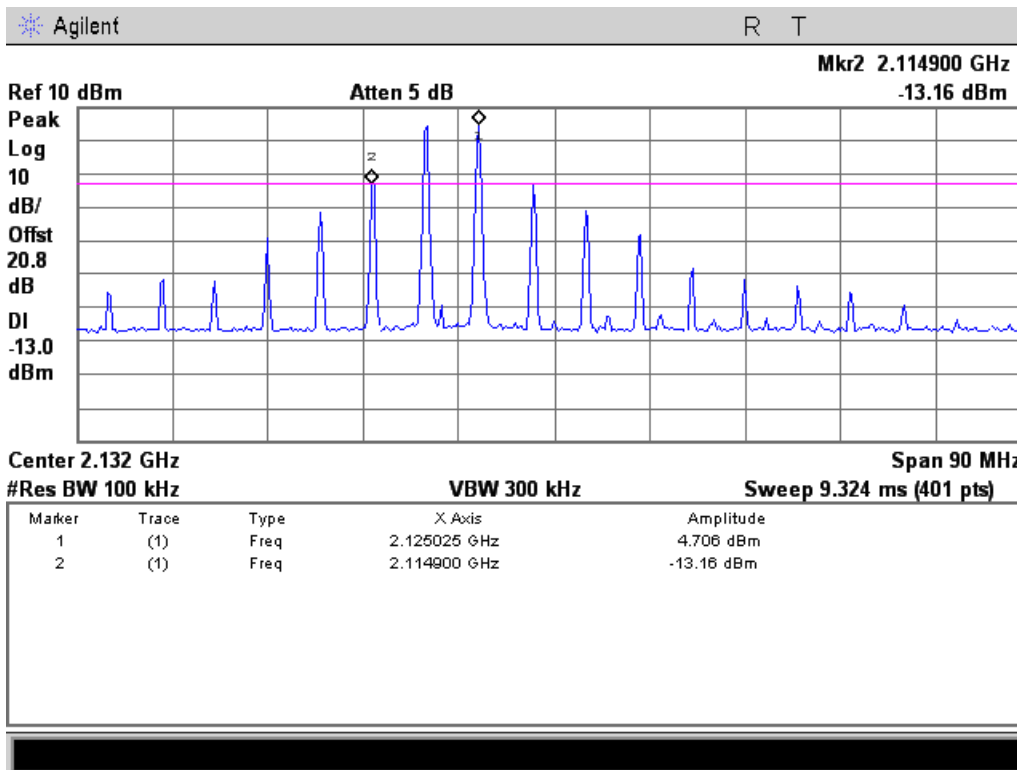





### CDMA Uplink Test Results

#### 698 - 716 MHz Band

<b>P<sub>01</sub> – P<sub>02</sub> Frequency Pair (MHz)</b>	<b>Input Power (dBm)</b>	<b>Intermodulation Level (dBm)</b>	<b>P<sub>01</sub> (dBm)</b>	<b>P<sub>mean</sub> (dBm)</b>	<b>Gain (dB)</b>
703 – 708	1	-13.89	19.74	22.74	18.74
706 – 711	0.9	-14.16	20.17	23.17	19.27

#### 776 - 787 MHz Band

<b>P<sub>01</sub> – P<sub>02</sub> Frequency Pair (MHz)</b>	<b>Input Power (dBm)</b>	<b>Intermodulation Level (dBm)</b>	<b>P<sub>01</sub> (dBm)</b>	<b>P<sub>mean</sub> (dBm)</b>	<b>Gain (dB)</b>
779 – 782	1.8	-14.18	18.56	21.56	16.76
781 – 784	2	-13.91	18.76	21.76	16.76

#### 824 - 849 MHz Band

<b>P<sub>01</sub> – P<sub>02</sub> Frequency Pair (MHz)</b>	<b>Input Power (dBm)</b>	<b>Intermodulation Level (dBm)</b>	<b>P<sub>01</sub> (dBm)</b>	<b>P<sub>mean</sub> (dBm)</b>	<b>Gain (dB)</b>
830 – 835	-1	-13.74	20.03	23.03	21.03
842 – 845	0	-13.91	20.26	23.26	20.26

#### 1710 - 1755 MHz Band

<b>P<sub>01</sub> – P<sub>02</sub> Frequency Pair (MHz)</b>	<b>Input Power (dBm)</b>	<b>Intermodulation Level (dBm)</b>	<b>P<sub>01</sub> (dBm)</b>	<b>P<sub>mean</sub> (dBm)</b>	<b>Gain (dB)</b>
1720 – 1725	0.3	-13.3	19.21	22.21	18.91
1740 – 1745	-1.4	-13.3	17.23	20.23	18.63

#### 1850 - 1915 MHz Band

<b>P<sub>01</sub> – P<sub>02</sub> Frequency Pair (MHz)</b>	<b>Input Power (dBm)</b>	<b>Intermodulation Level (dBm)</b>	<b>P<sub>01</sub> (dBm)</b>	<b>P<sub>mean</sub> (dBm)</b>	<b>Gain (dB)</b>
1860 – 1865	0.3	-13.72	18.73	21.73	18.43
1895 - 1900	0.8	-13.44	17.31	20.31	16.51



### CDMA Downlink Test Results

#### 728 - 746 MHz Band

<b>P<sub>01</sub> – P<sub>02</sub> Frequency Pair (MHz)</b>	<b>Input Power (dBm)</b>	<b>Intermodulation Level (dBm)</b>	<b>P<sub>01</sub> (dBm)</b>	<b>P<sub>mean</sub> (dBm)</b>	<b>Gain (dB)</b>
733 – 738	-12.7	-13.22	1.55	4.55	14.25
736 – 741	-14.7	-13.28	0.7	3.7	15.4

#### 746 - 757 MHz Band

<b>P<sub>01</sub> – P<sub>02</sub> Frequency Pair (MHz)</b>	<b>Input Power (dBm)</b>	<b>Intermodulation Level (dBm)</b>	<b>P<sub>01</sub> (dBm)</b>	<b>P<sub>mean</sub> (dBm)</b>	<b>Gain (dB)</b>
750 – 752	-14	-13.59	0.32	3.32	14.32
752 – 754	-13.7	-13.95	1.62	4.62	15.32

#### 869 - 894 MHz Band

<b>P<sub>01</sub> – P<sub>02</sub> Frequency Pair (MHz)</b>	<b>Input Power (dBm)</b>	<b>Intermodulation Level (dBm)</b>	<b>P<sub>01</sub> (dBm)</b>	<b>P<sub>mean</sub> (dBm)</b>	<b>Gain (dB)</b>
875 – 880	-14.3	-13.94	-0.16	2.84	14.14
880 – 885	-14.3	-13.5	0.51	3.51	14.81

#### 1930 - 1995 MHz Band

<b>P<sub>01</sub> – P<sub>02</sub> Frequency Pair (MHz)</b>	<b>Input Power (dBm)</b>	<b>Intermodulation Level (dBm)</b>	<b>P<sub>01</sub> (dBm)</b>	<b>P<sub>mean</sub> (dBm)</b>	<b>Gain (dB)</b>
1940 – 1945	-10.4	-13.83	4.78	7.78	15.18
1975 - 1980	-10.4	-13.08	6.9	9.9	17.3

#### 2110 - 2155 MHz Band

<b>P<sub>01</sub> – P<sub>02</sub> Frequency Pair (MHz)</b>	<b>Input Power (dBm)</b>	<b>Intermodulation Level (dBm)</b>	<b>P<sub>01</sub> (dBm)</b>	<b>P<sub>mean</sub> (dBm)</b>	<b>Gain (dB)</b>
2120 – 2125	-8	-13.94	5.43	8.43	13.43
2140 - 2145	-13.8	-13.81	4.61	7.61	18.41



### CDMA Uplink Test Plots

#### 698 - 716 MHz Band

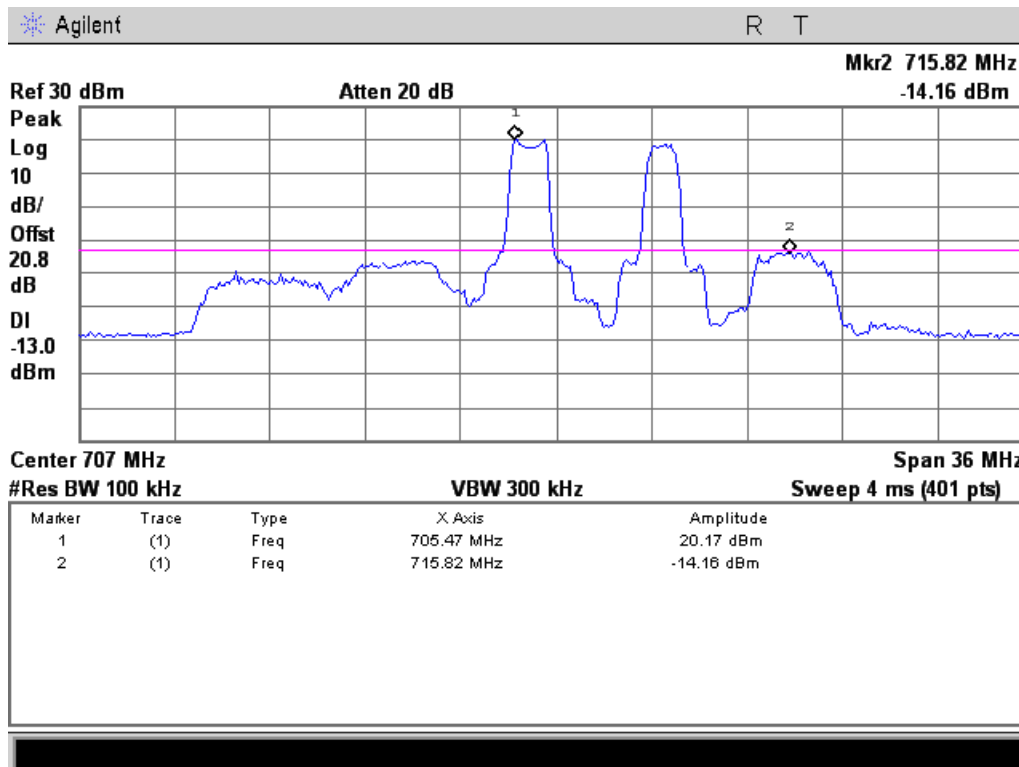
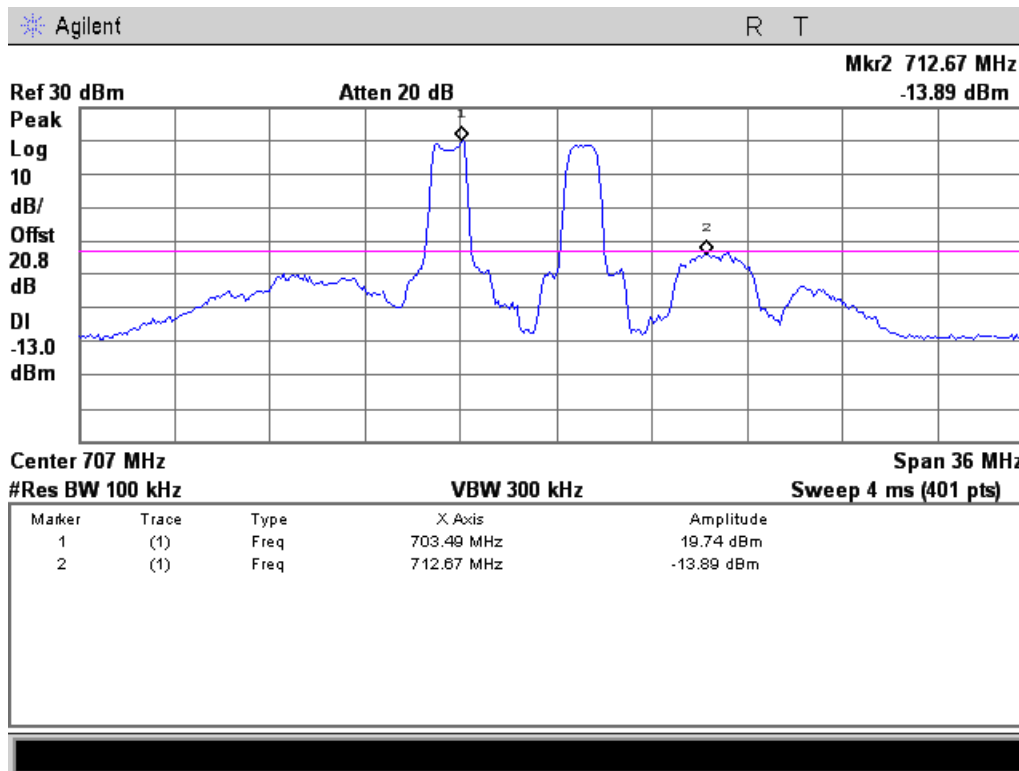



### 776 - 787 MHz Band

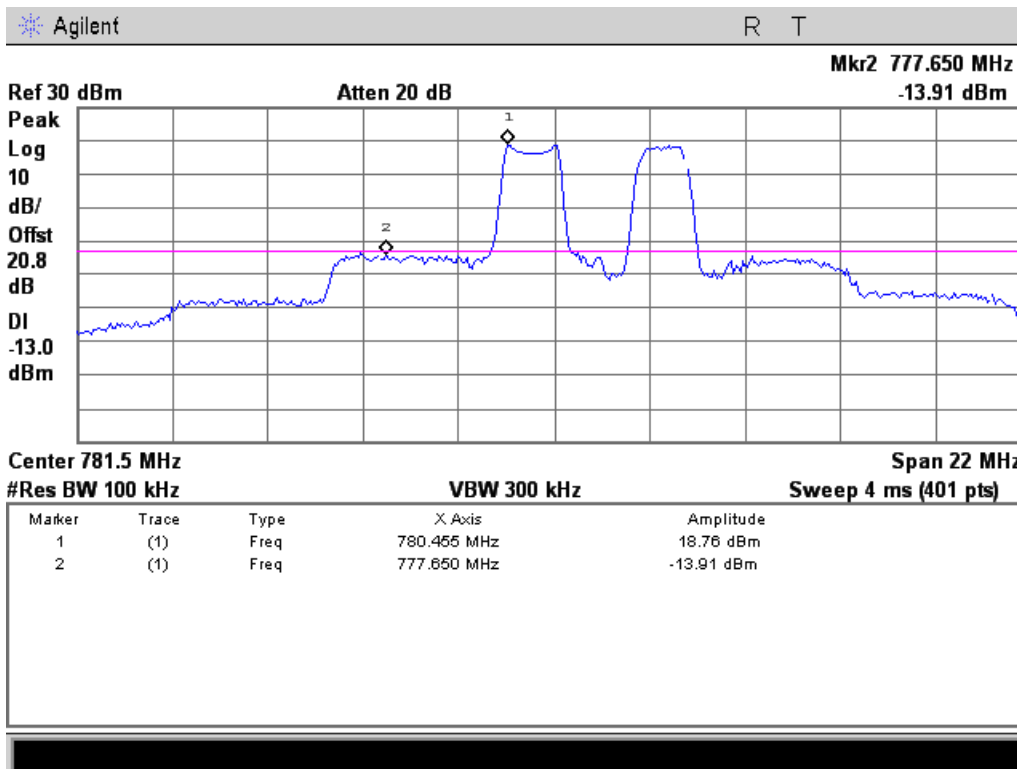
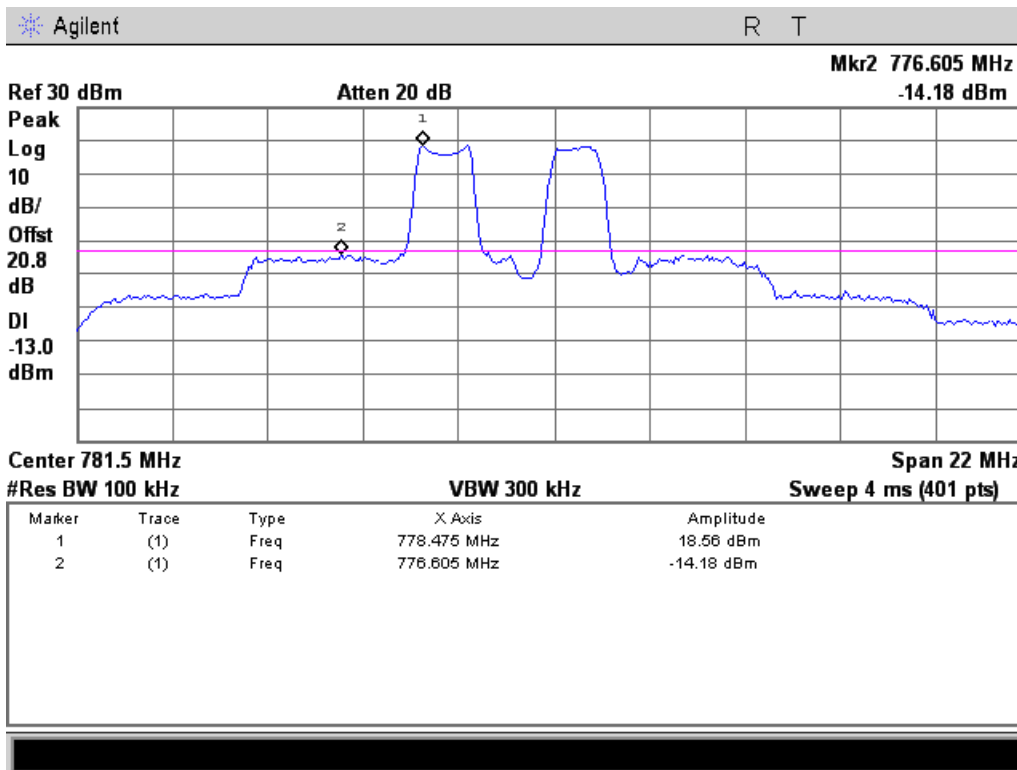



### 824 - 849 MHz Band

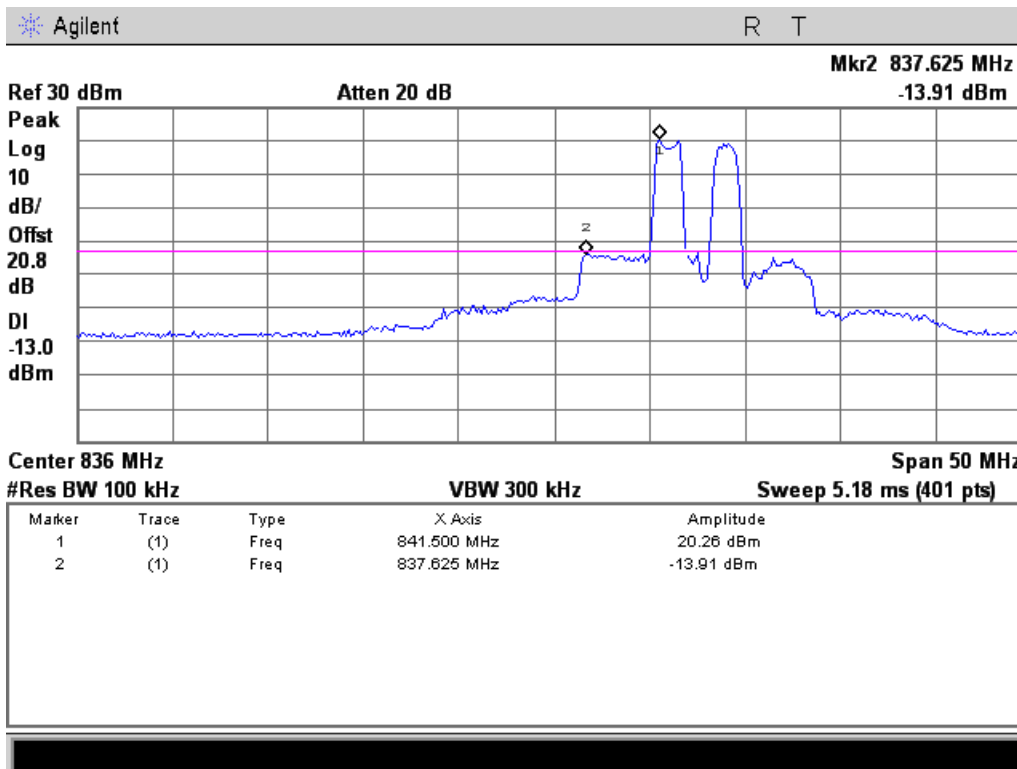
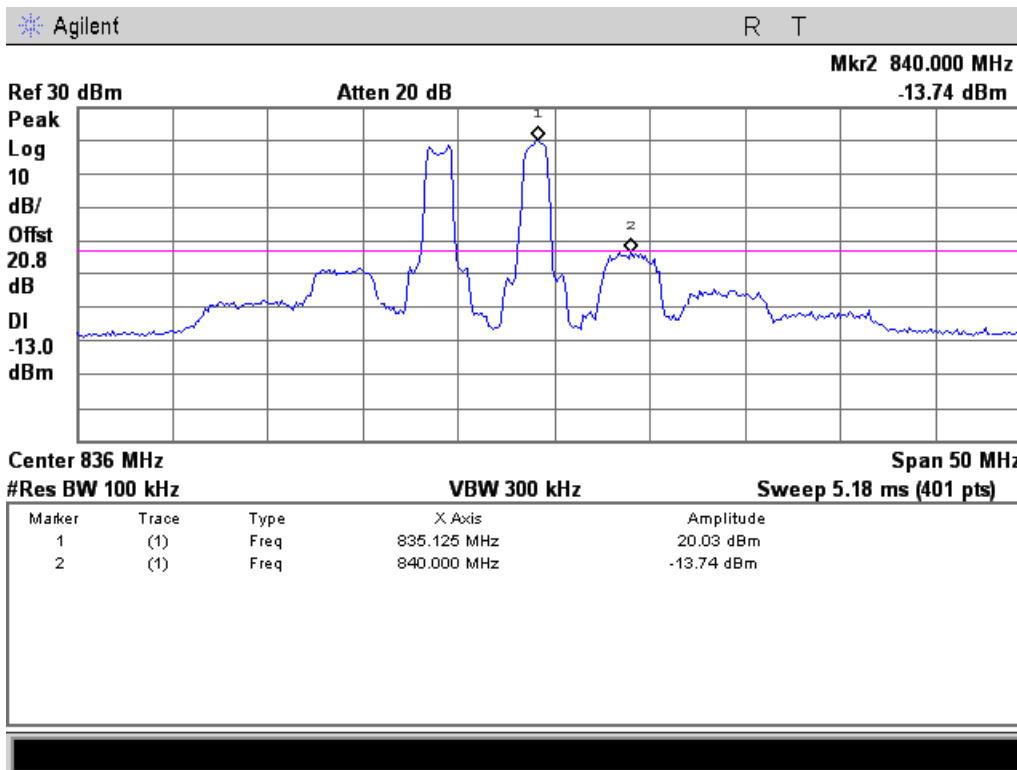



### 1710 - 1755 MHz Band

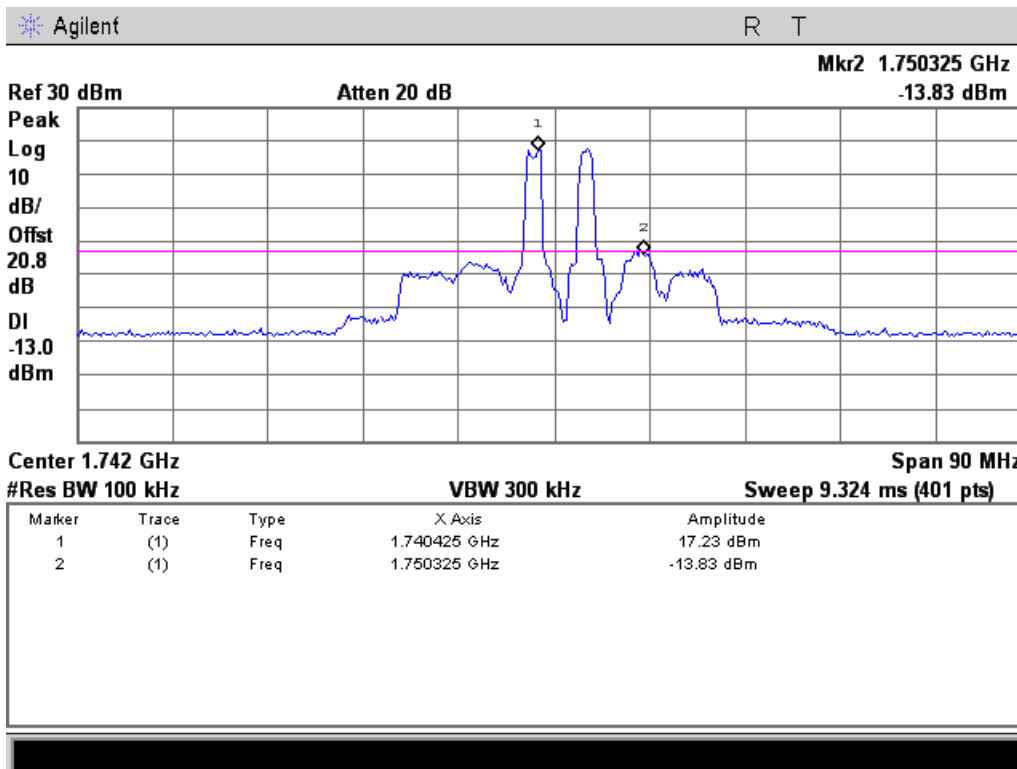
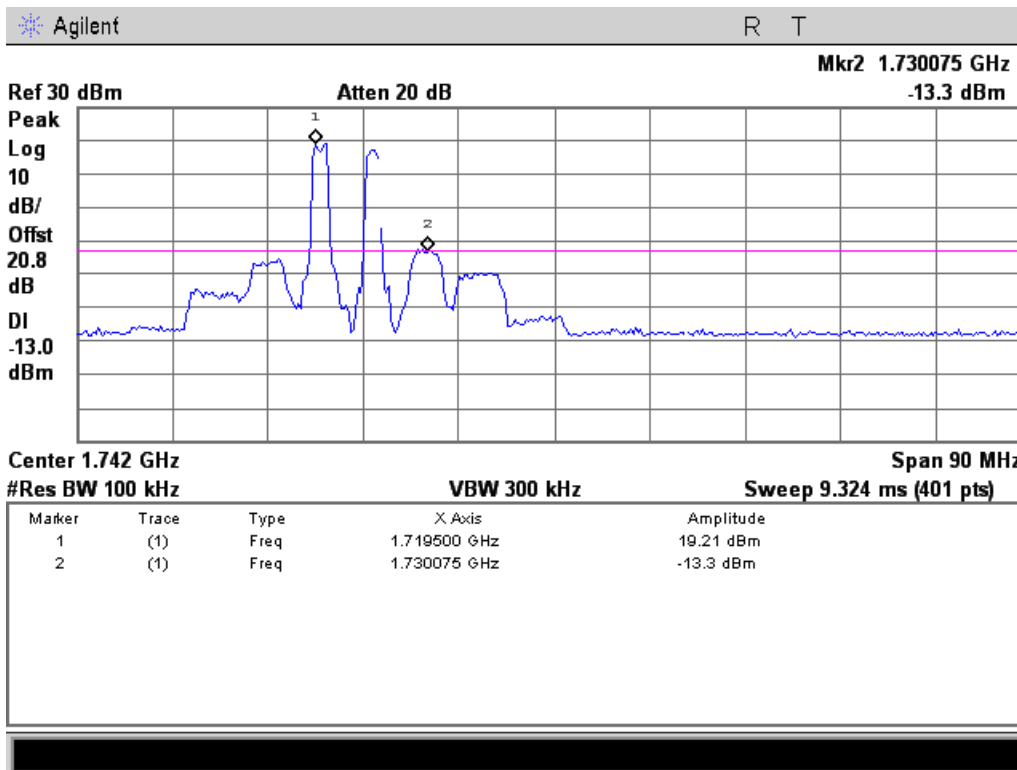



### 1850 - 1915 MHz Band

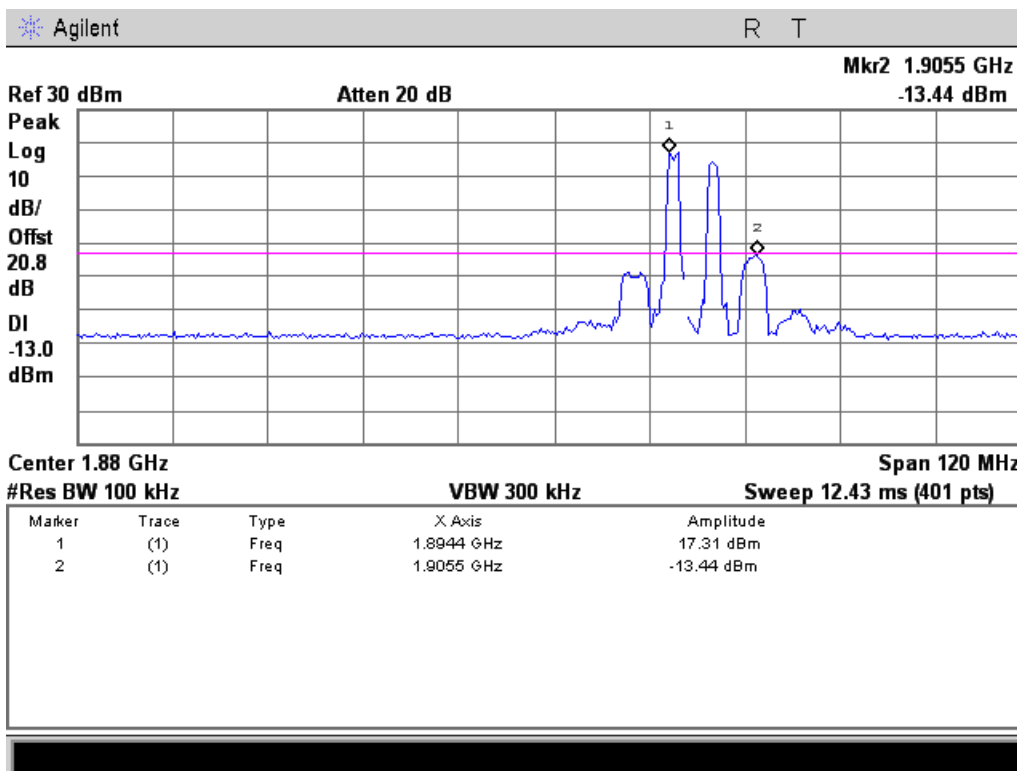
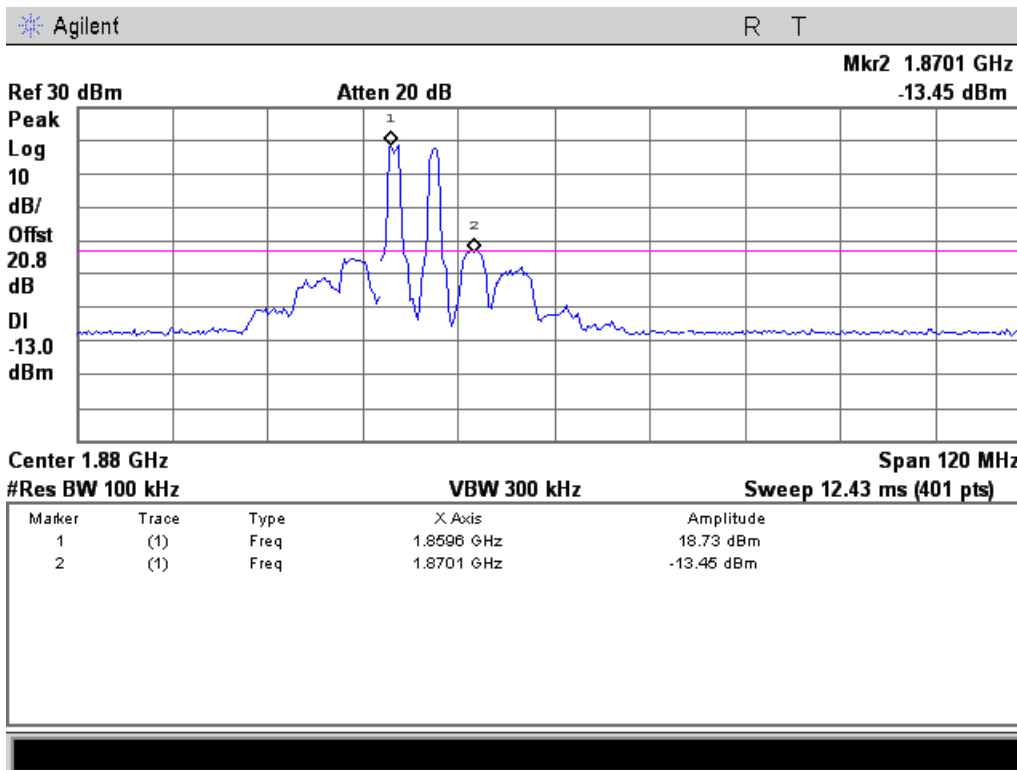



### CDMA Downlink Test Plots

#### 728 - 746 MHz Band

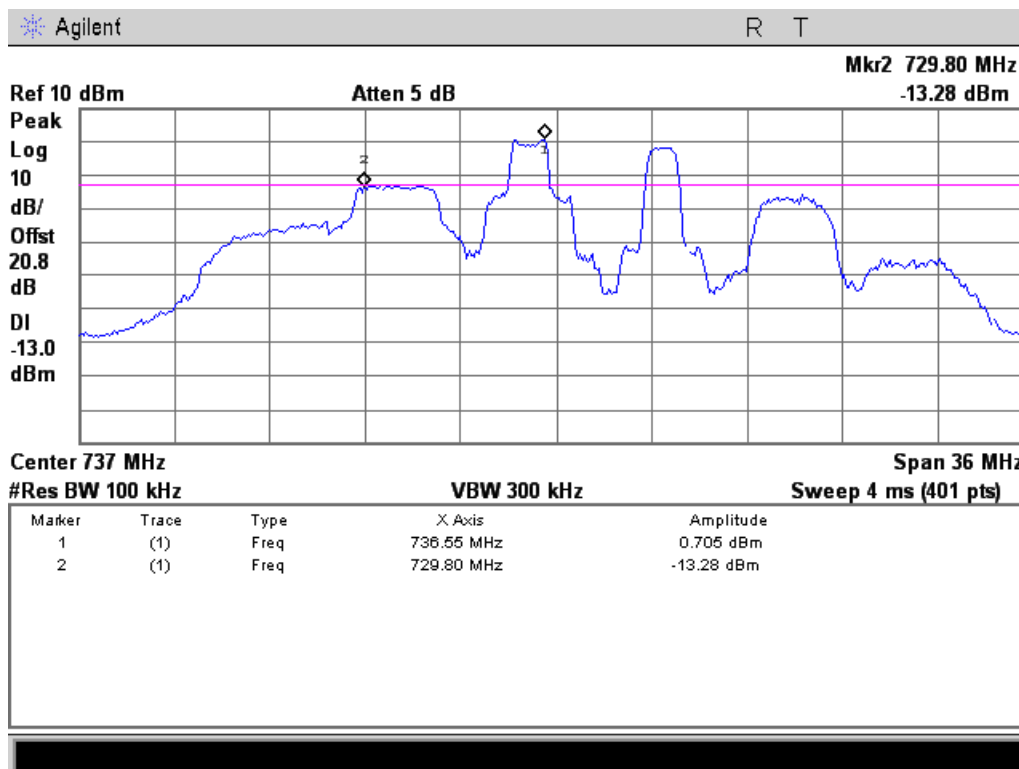
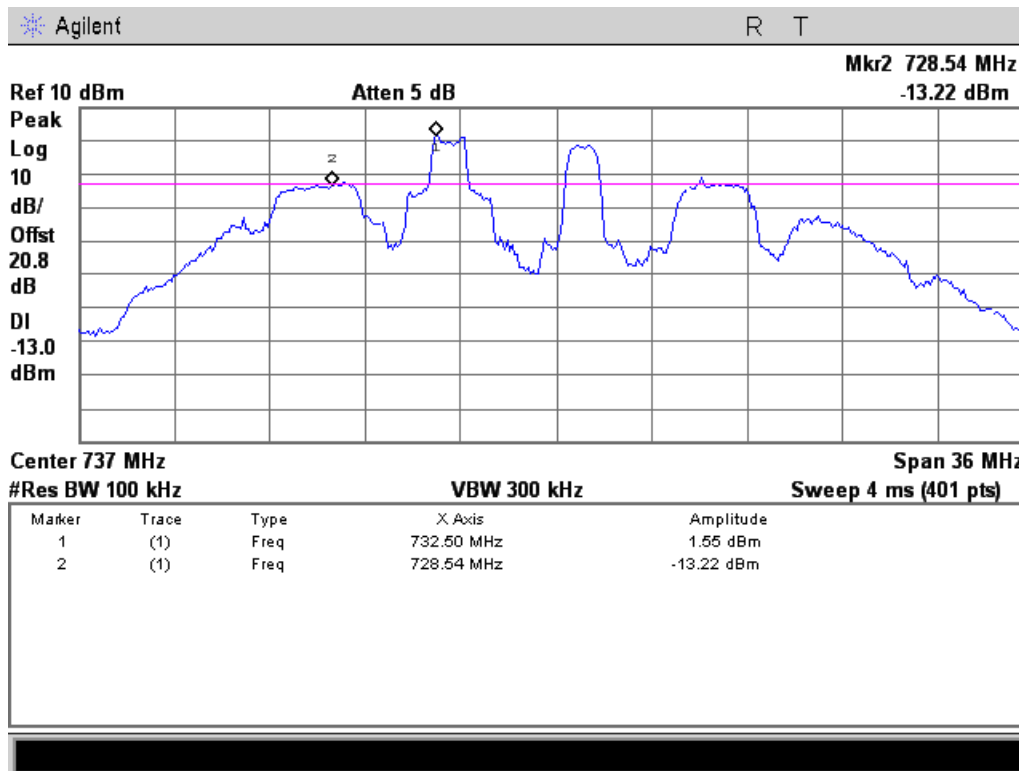





### 746 - 757 MHz Band

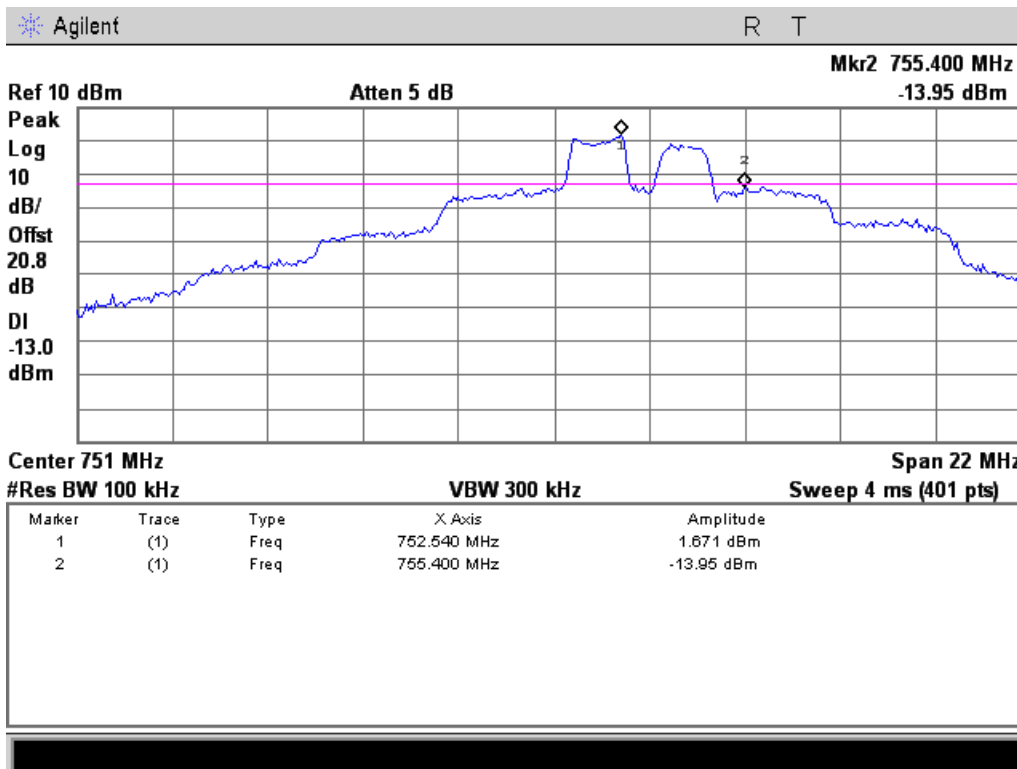
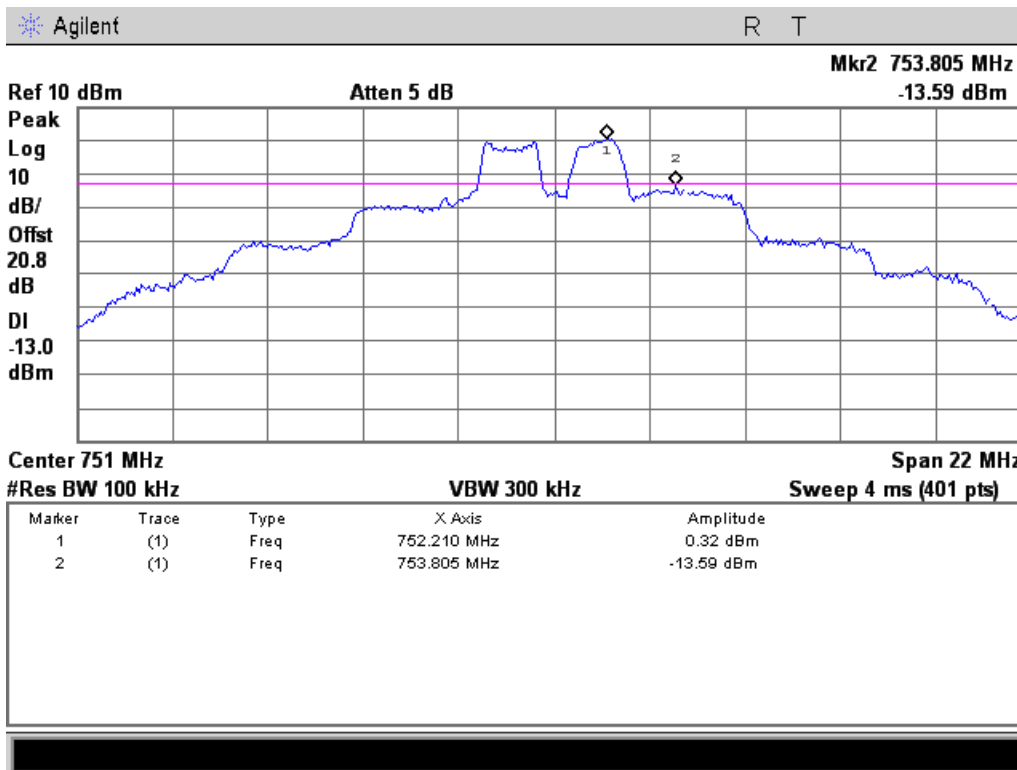



### 869 - 894 MHz Band

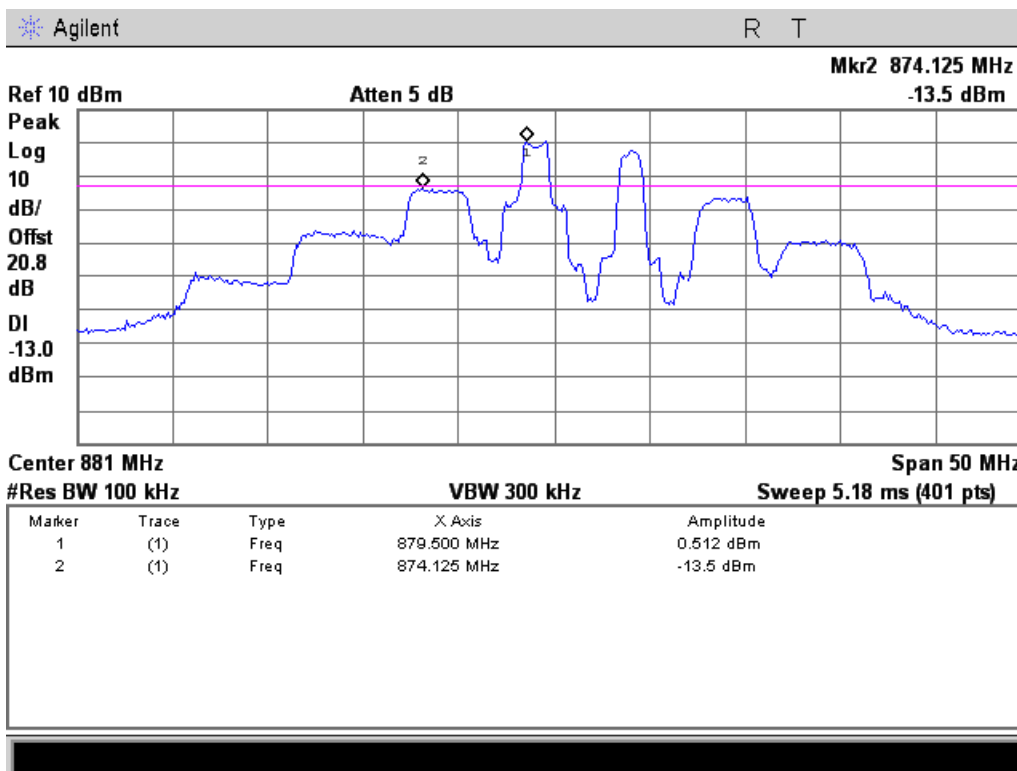
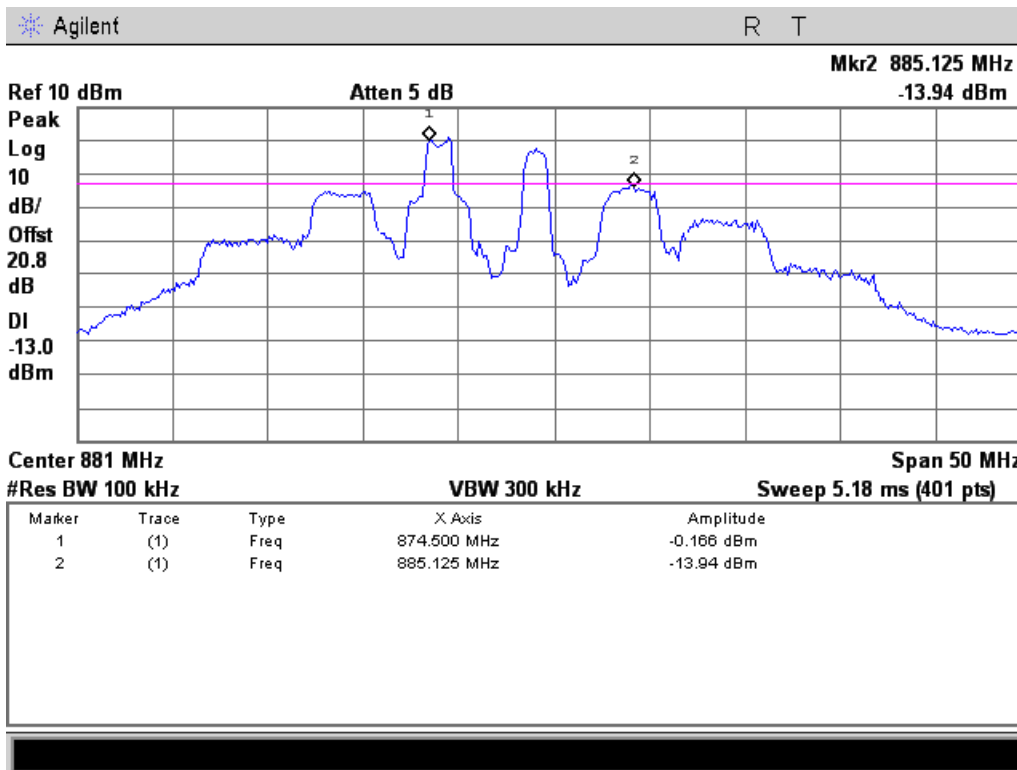



### 1930 - 1995 MHz Band

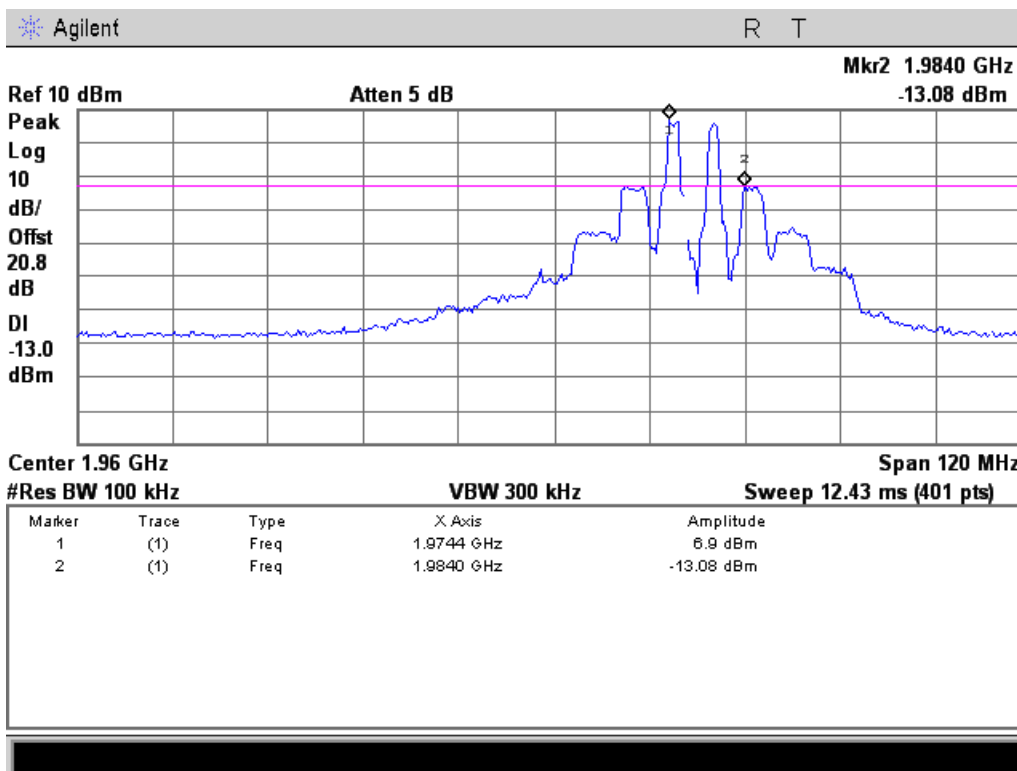
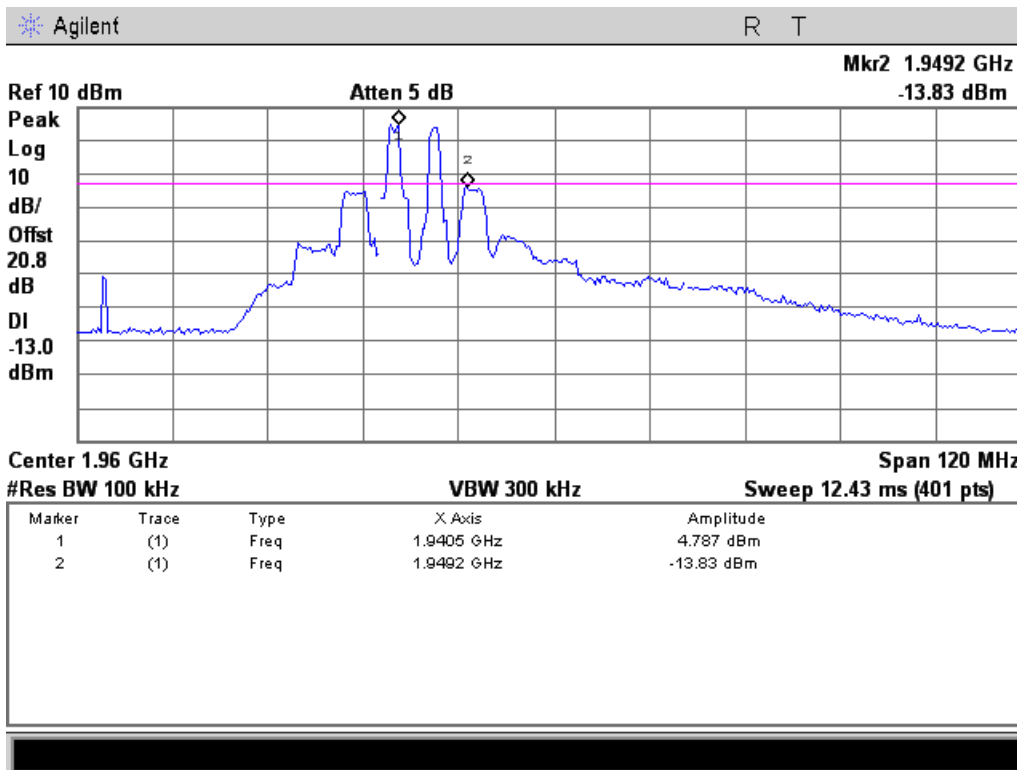



### 2110 - 2155 MHz Band

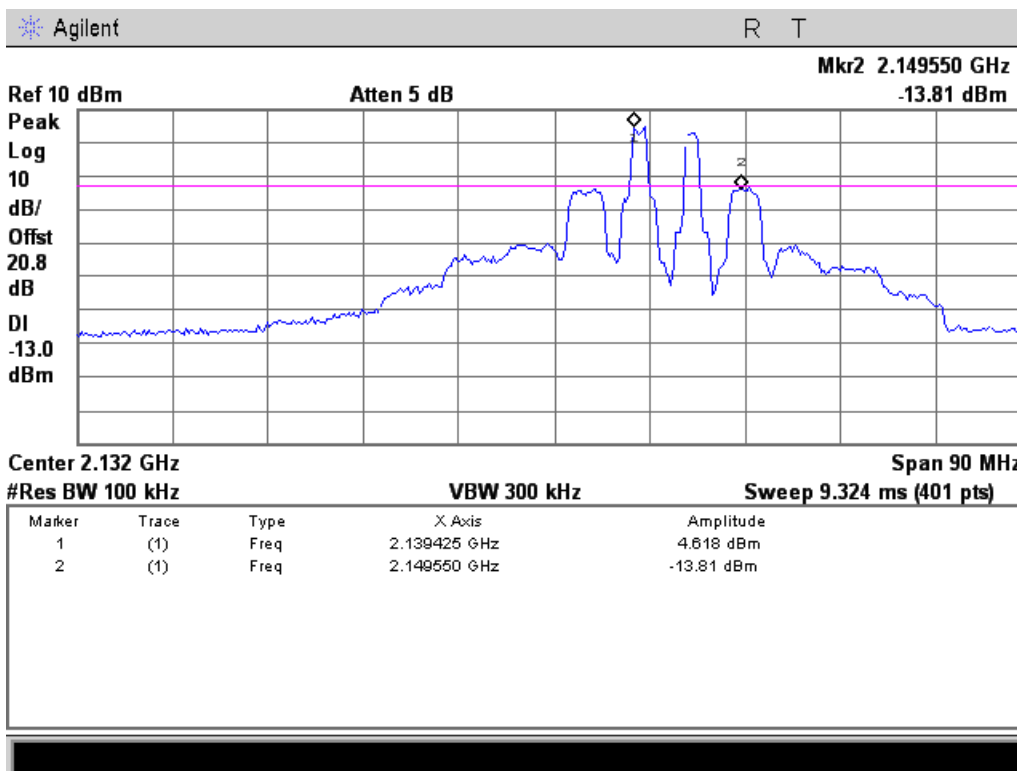
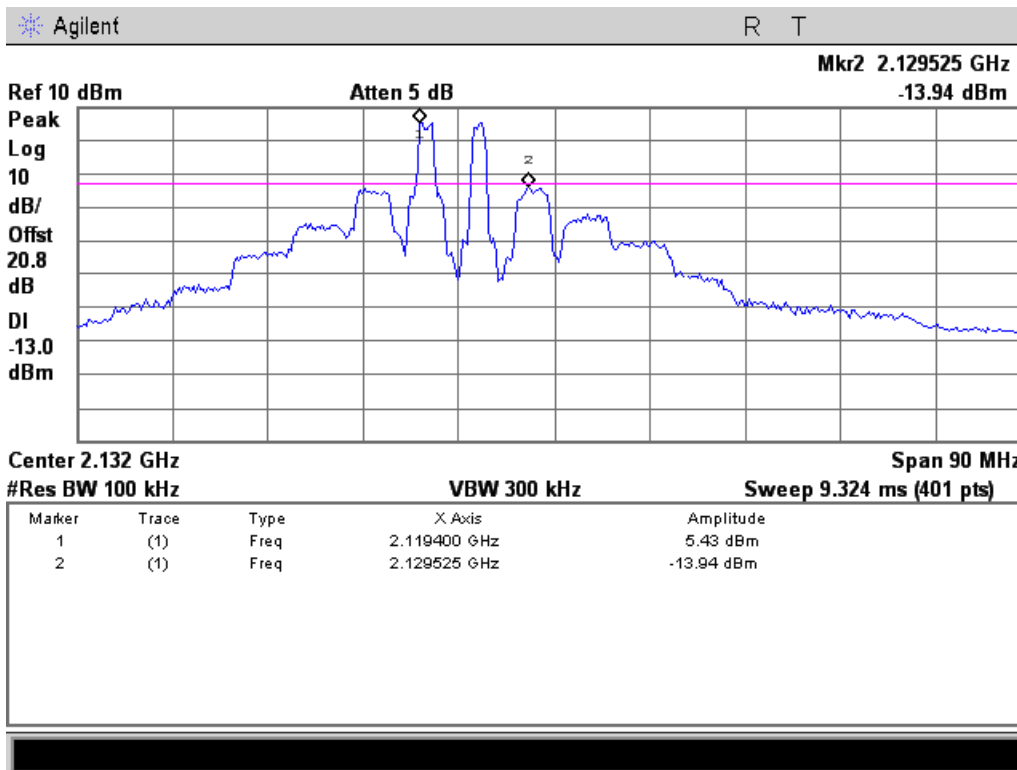



## Occupied Bandwidth

**Name of Test:** Occupied Bandwidth  
**Test Equipment Utilized:** 00266, i00331, i00348, i00347

**Engineer:** John Erhard  
**Test Date:** 9/27/2012

### Test Procedure

The EUT was connected to a spectrum analyzer through a 20 dB power attenuator. A signal generator was utilized to produce the following signals; GSM, CDMA, and WCDMA. The RF input level was set to the level as determined by the intermodulation testing requirements. The input and output spectrums were observed and the plots captured to ensure that the signals remained similar with minimal non-linearity in accordance to FCC guidelines. The center channel of each band was measured. All emissions are within the pass band.

### Test Setup

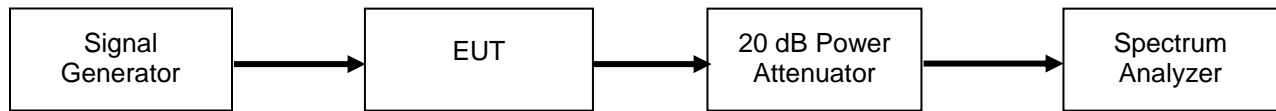



### GSM Uplink Test Plots

698 - 716 MHz Band

Input

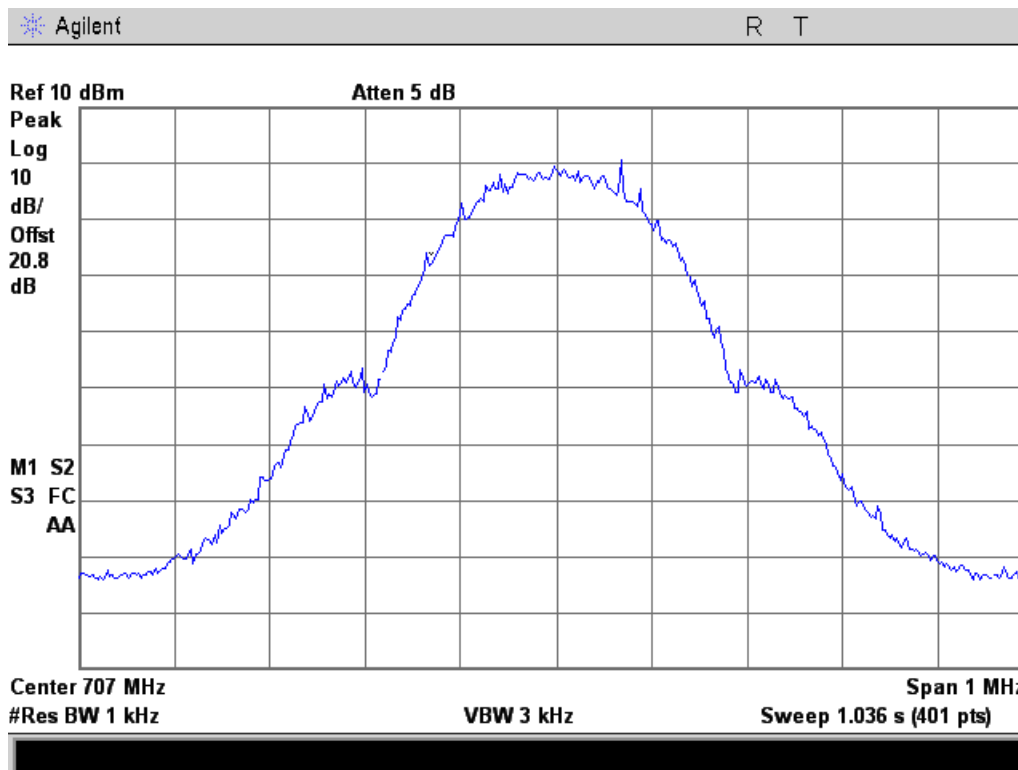

Output

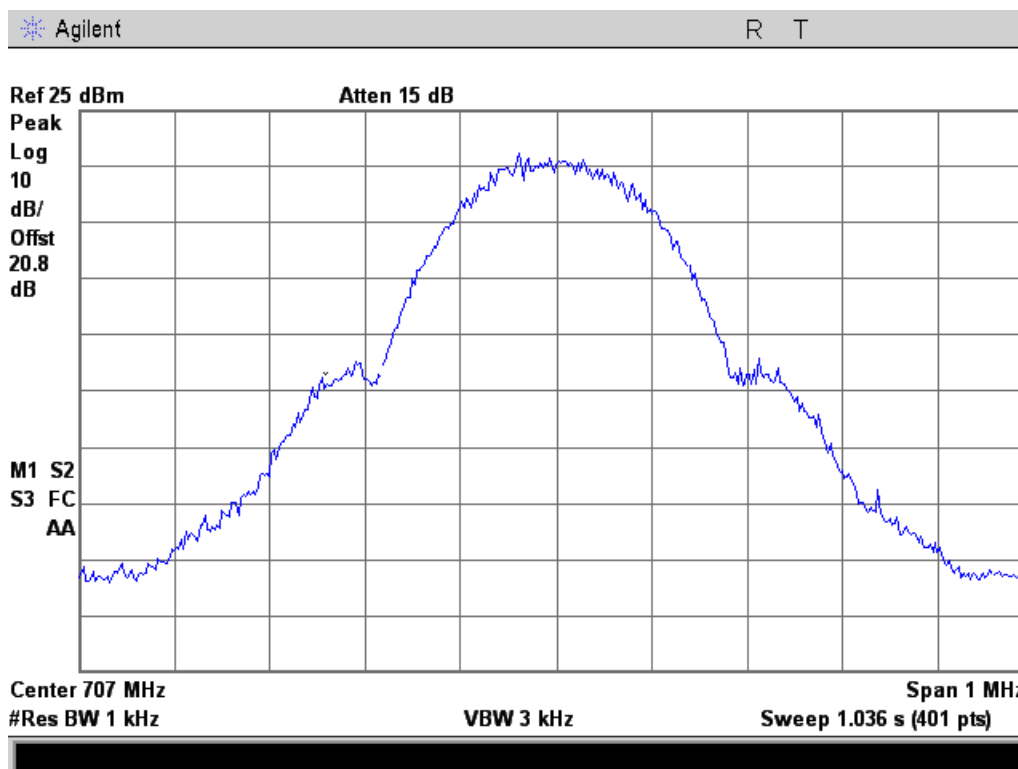



### 776 - 787 MHz Band

#### Input

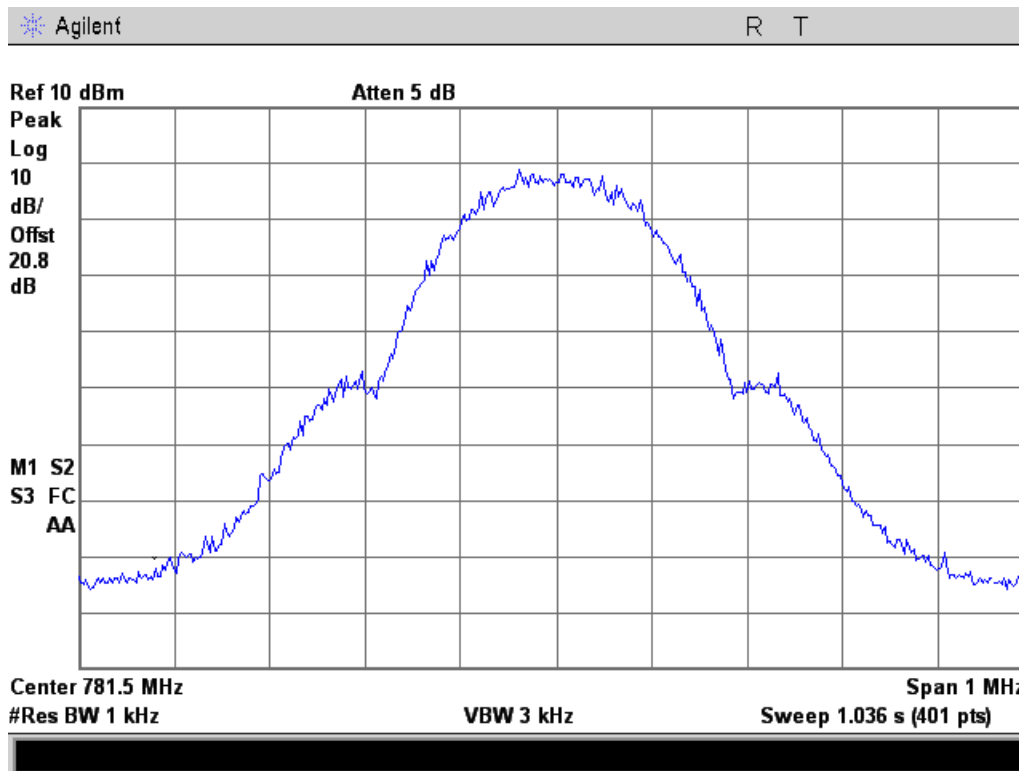

#### Output

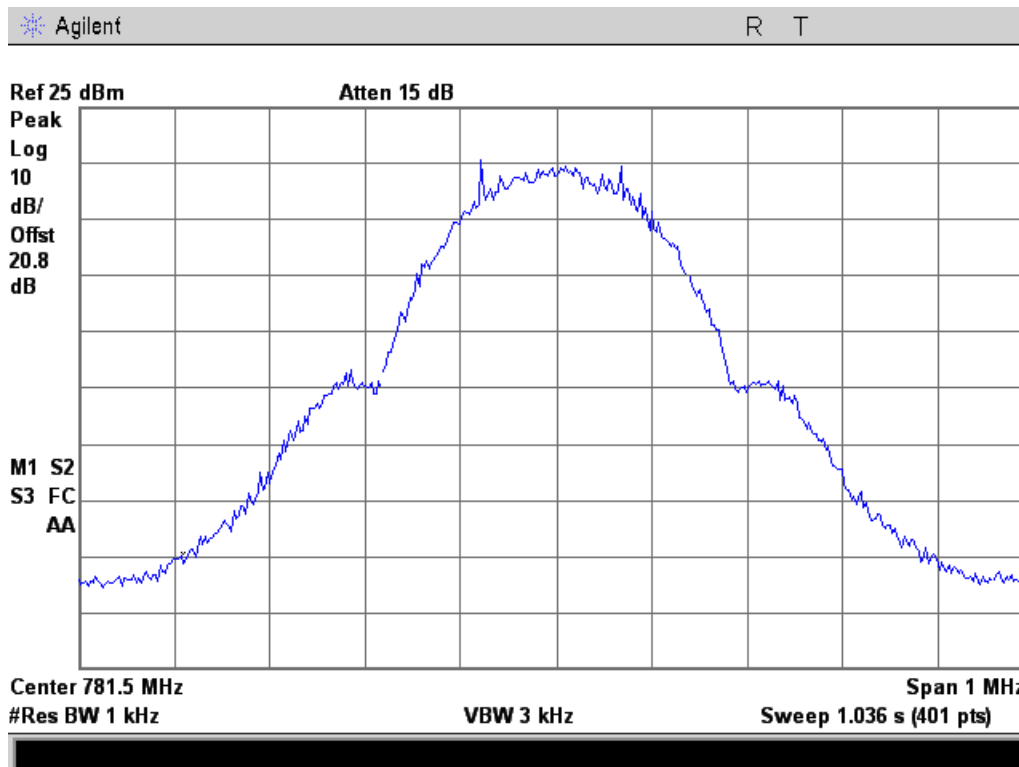



### 824 - 849 MHz Band

#### Input

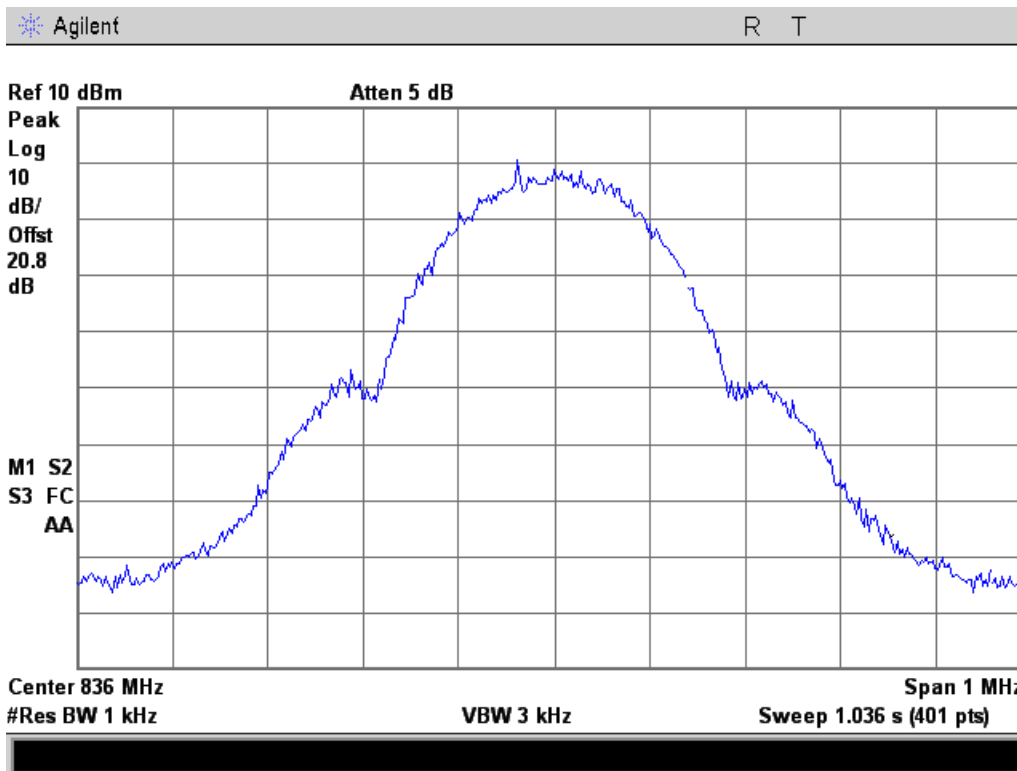

#### Output

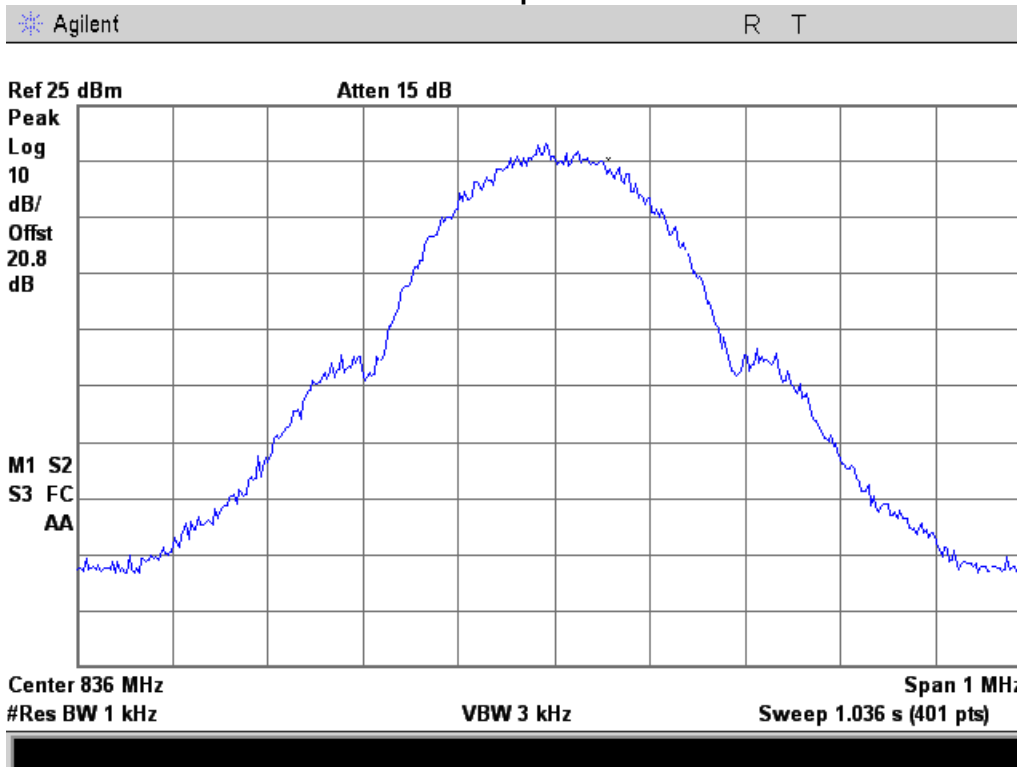





### 1710 - 1755 MHz Band

#### Input

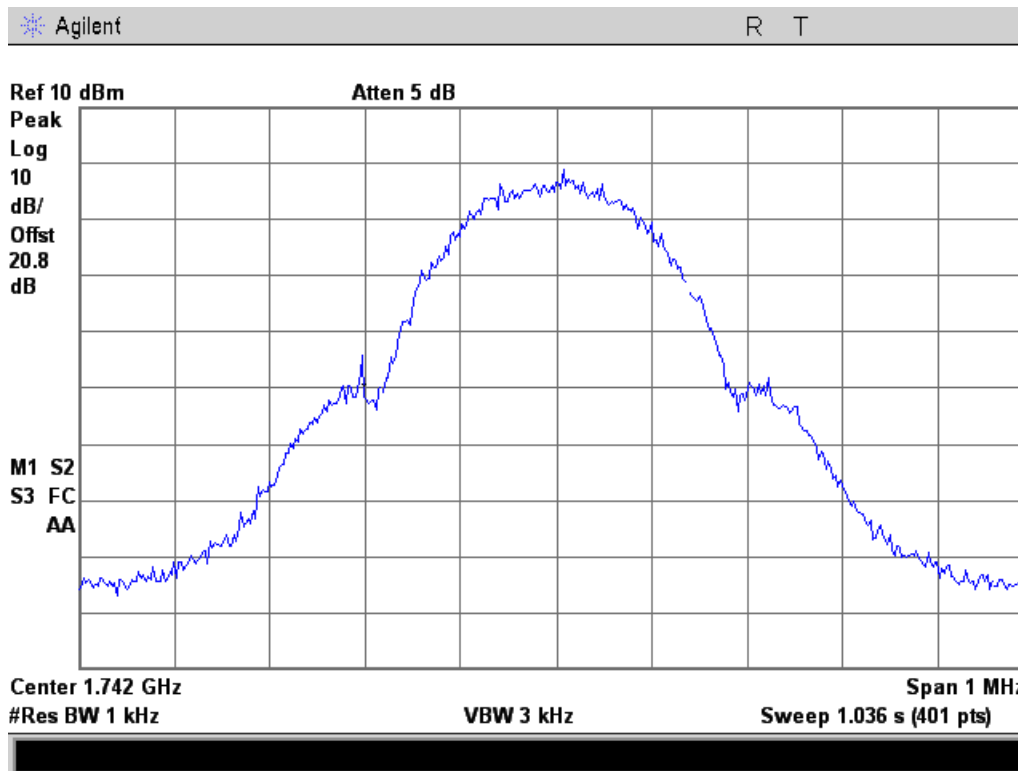

#### Output

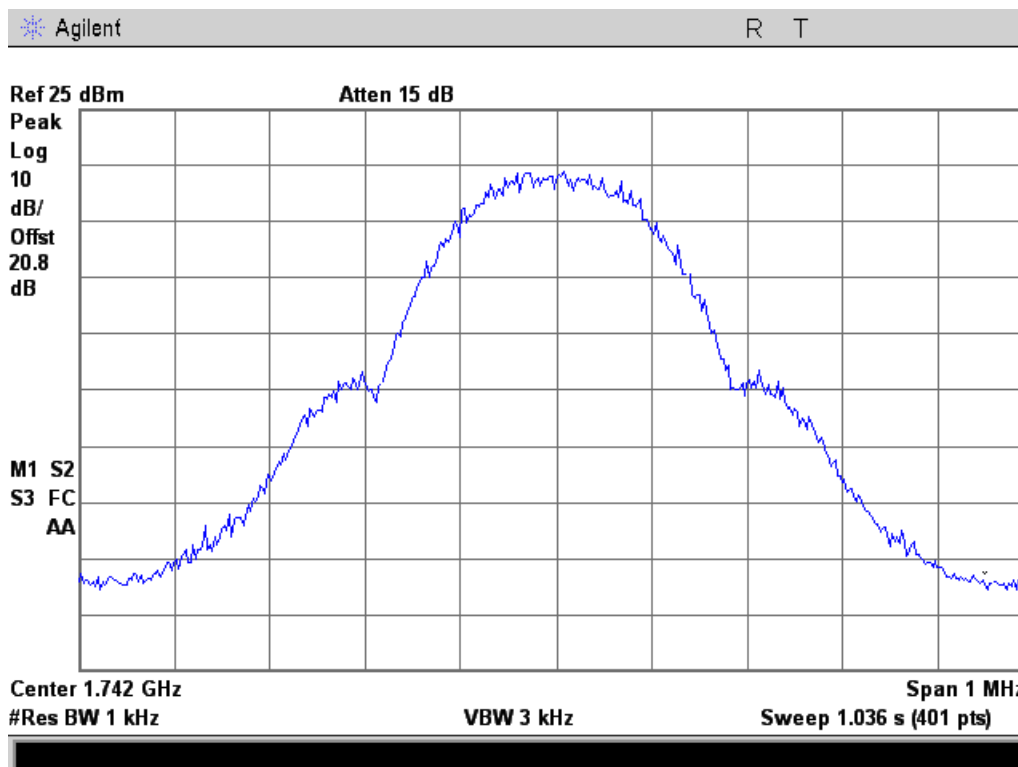



### 1850 - 1915 MHz Band

#### Input

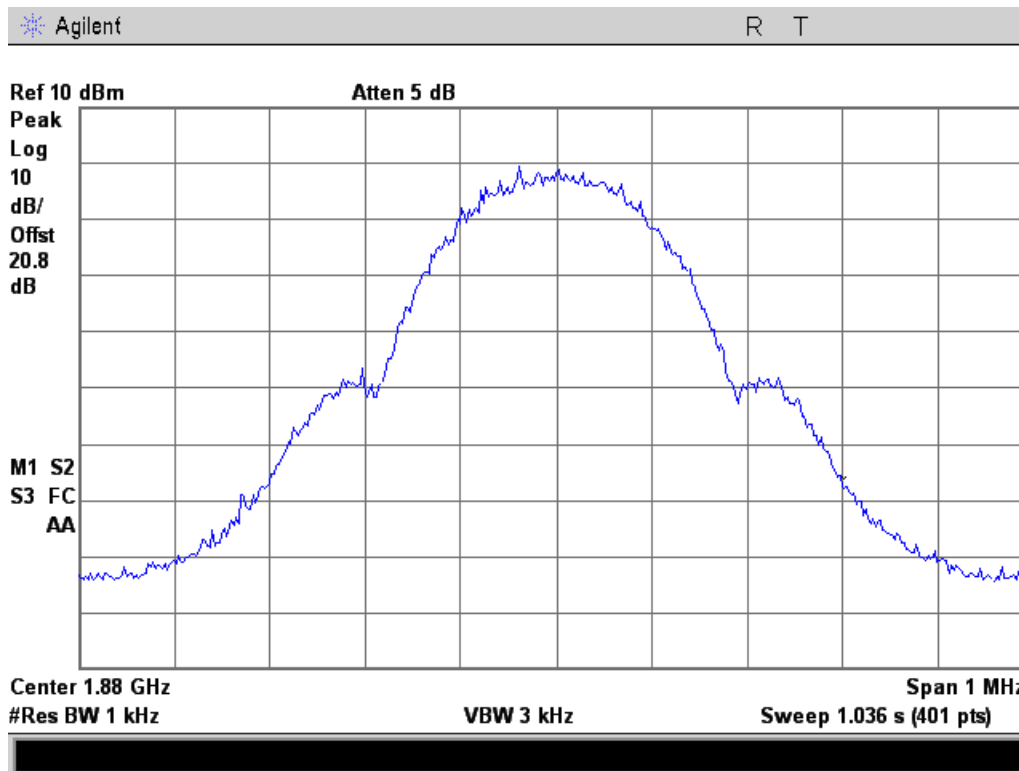

#### Output

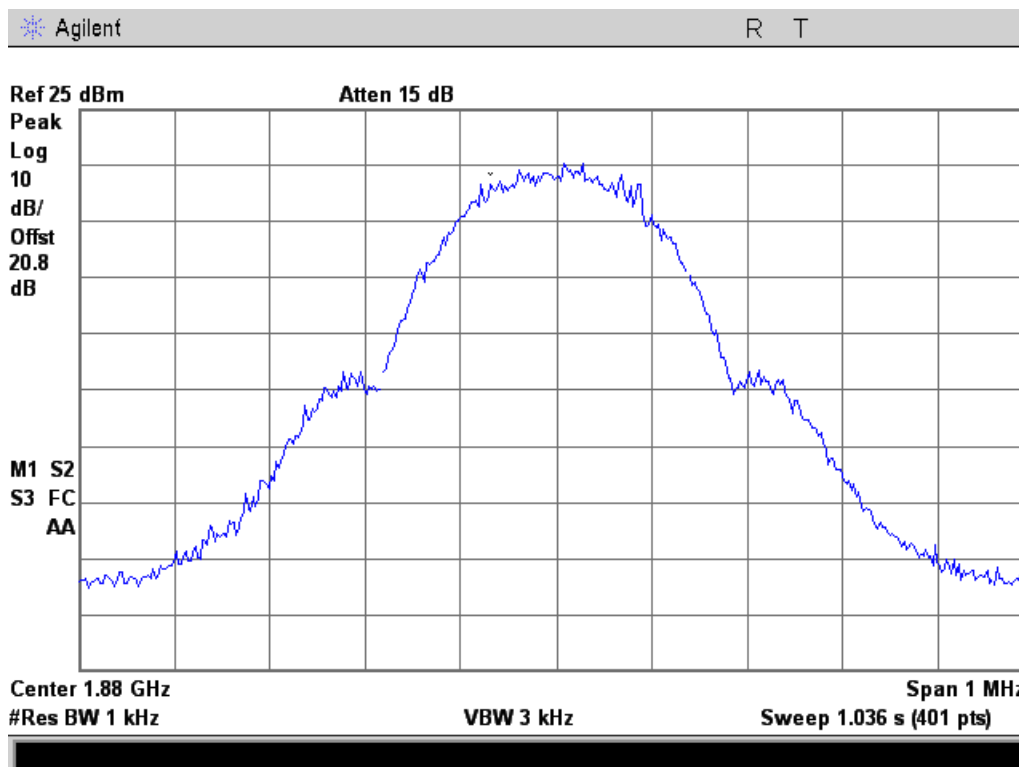



### GSM Downlink Test Plots

728 - 746 MHz Band

Input

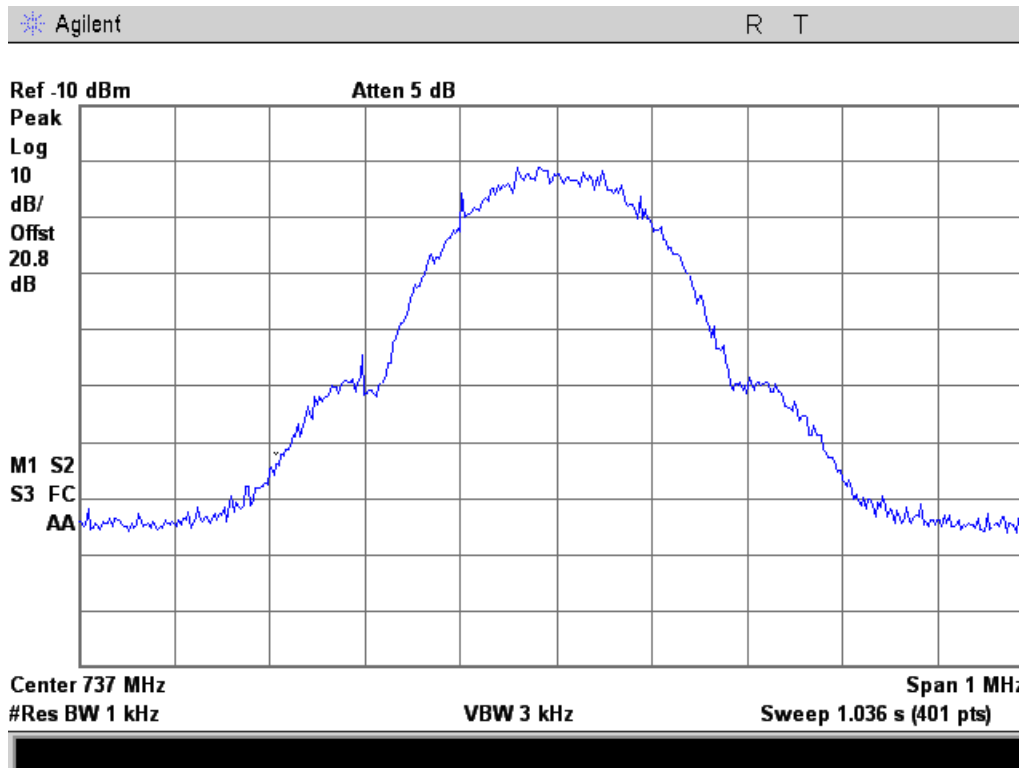

Output

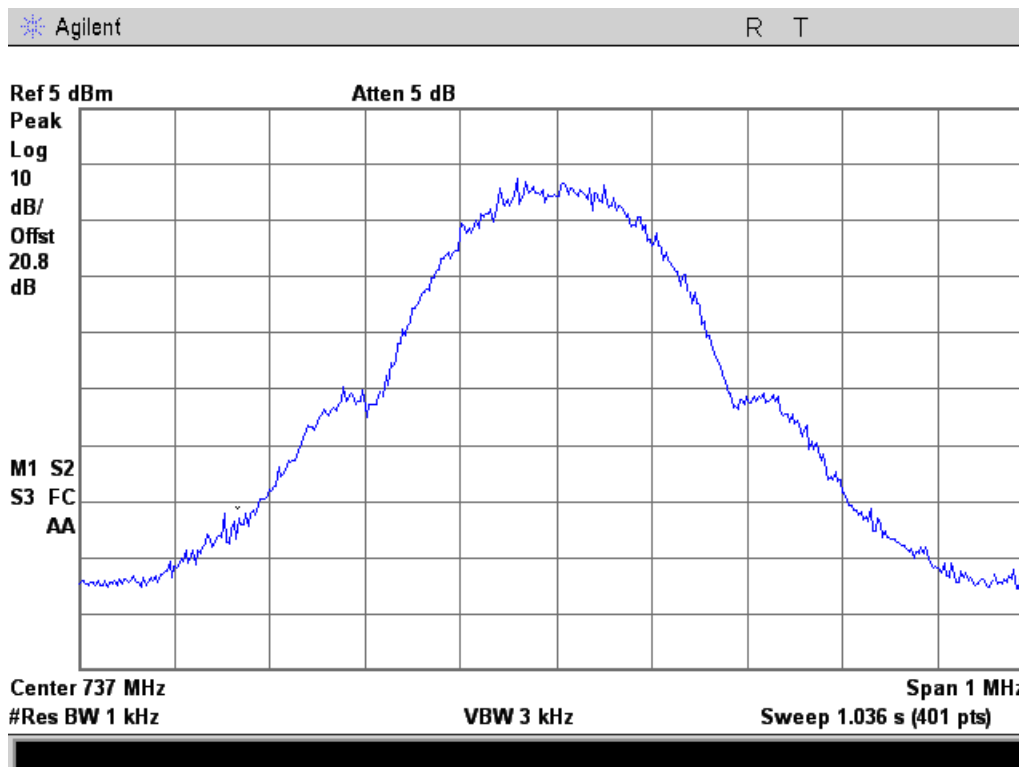



### 746 - 757 MHz Band

#### Input

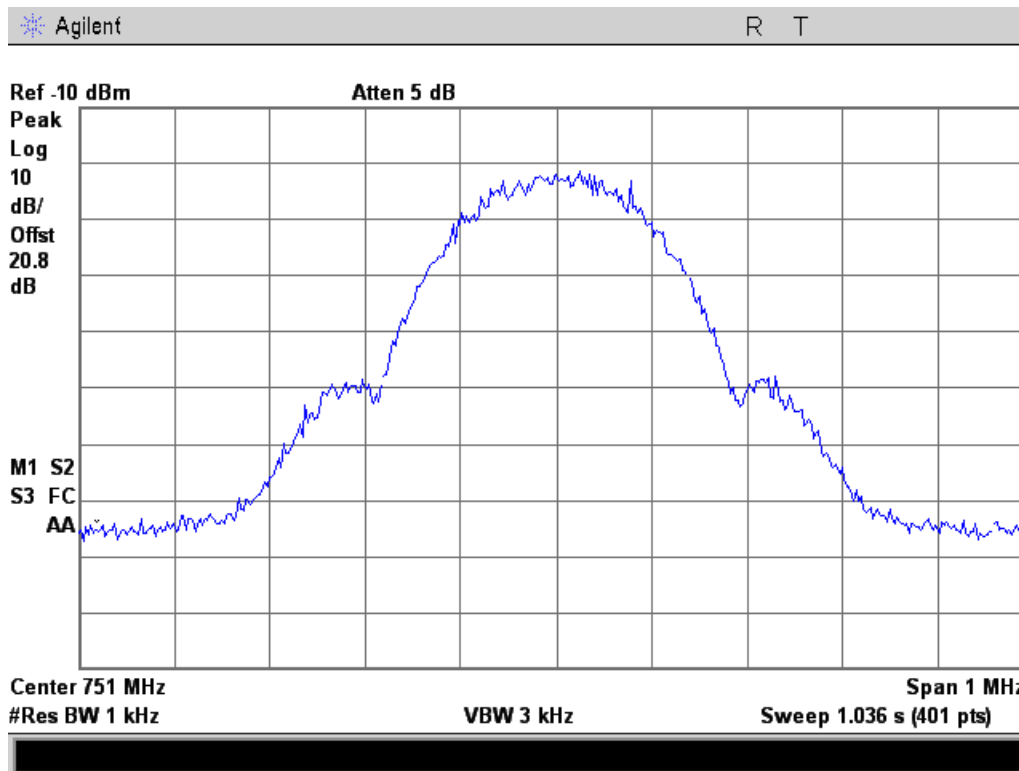

#### Output

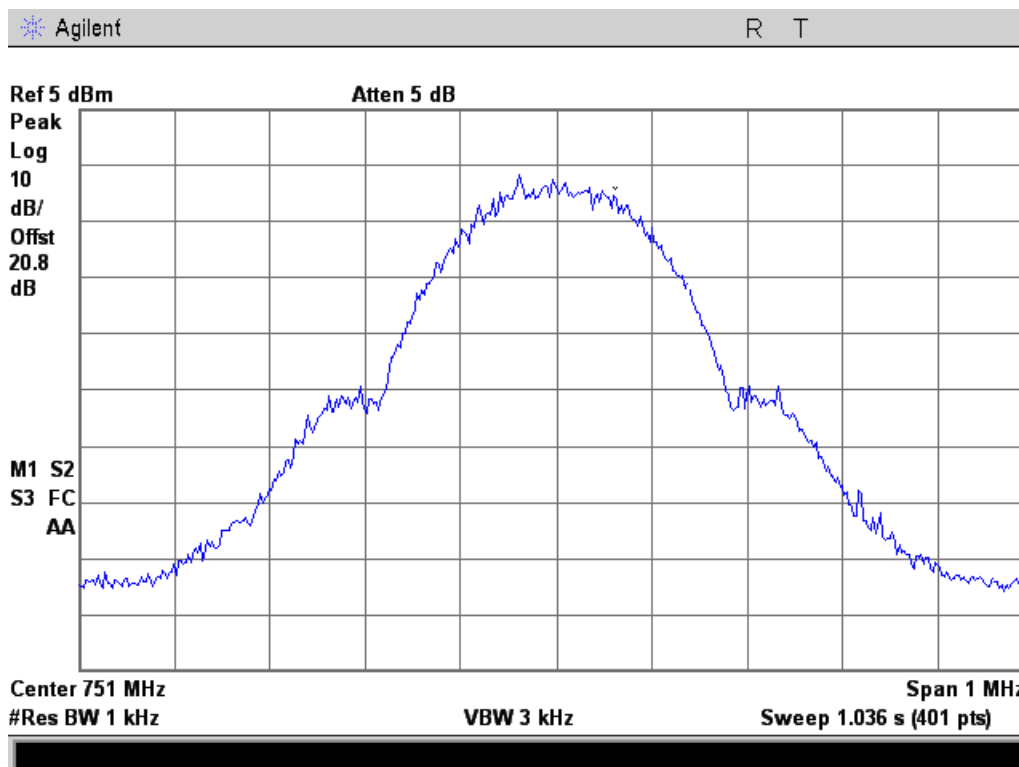



### 869 - 894 MHz Band

#### Input

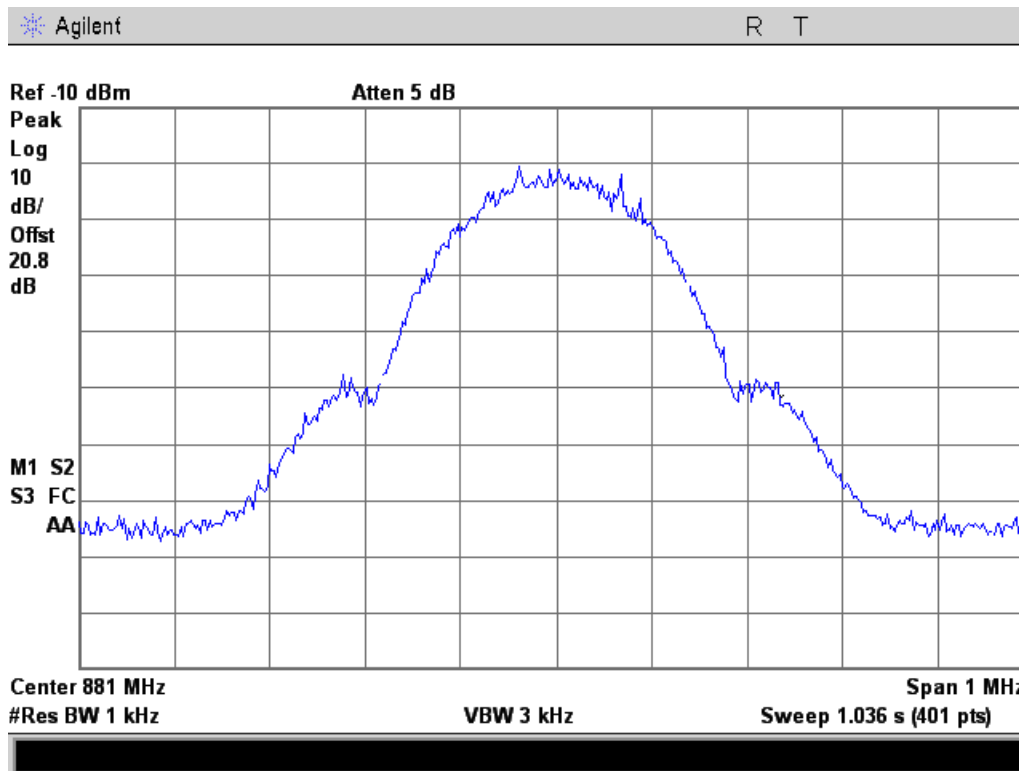

#### Output

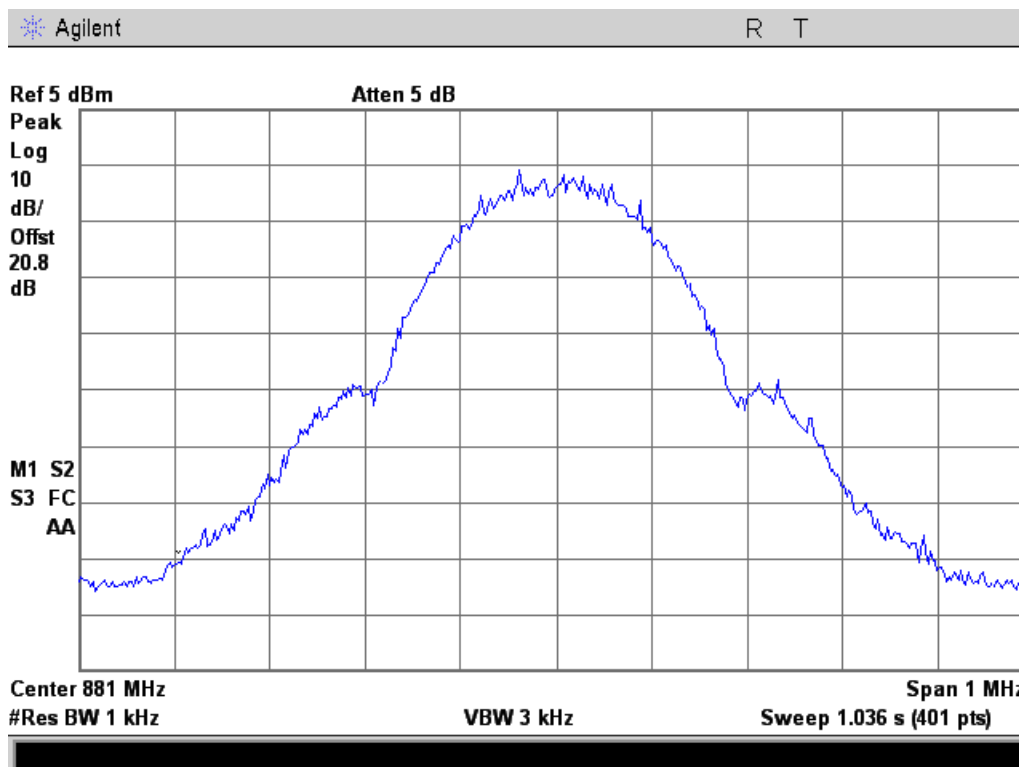



### 1930 - 1995 MHz Band

#### Input

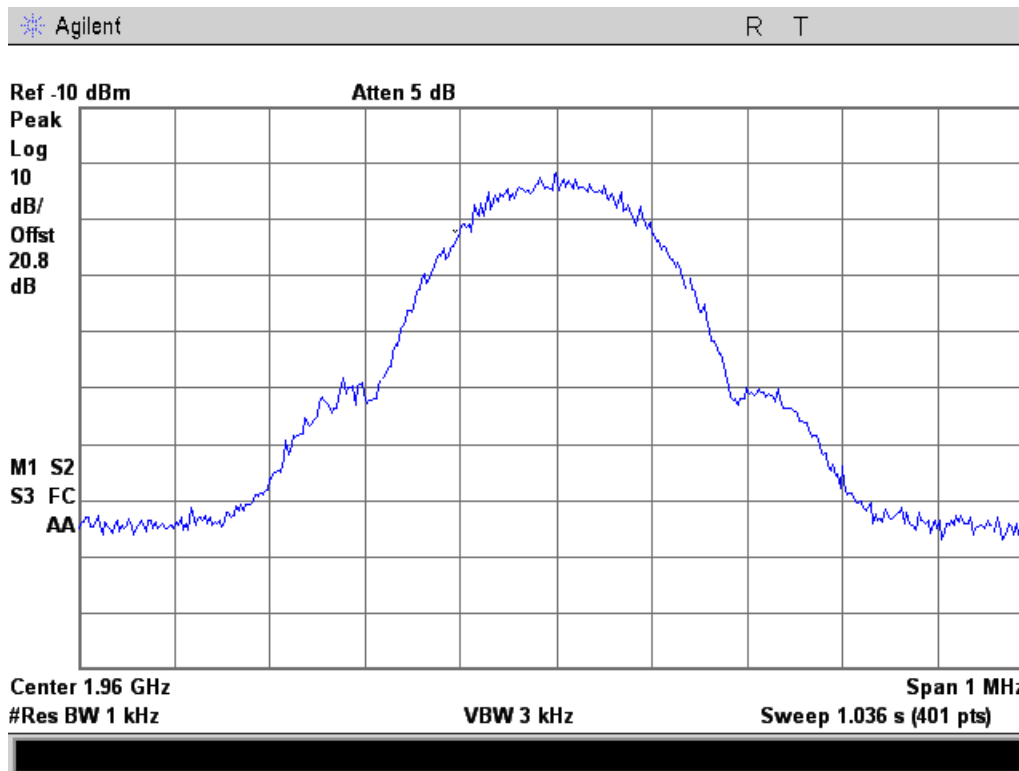

#### Output

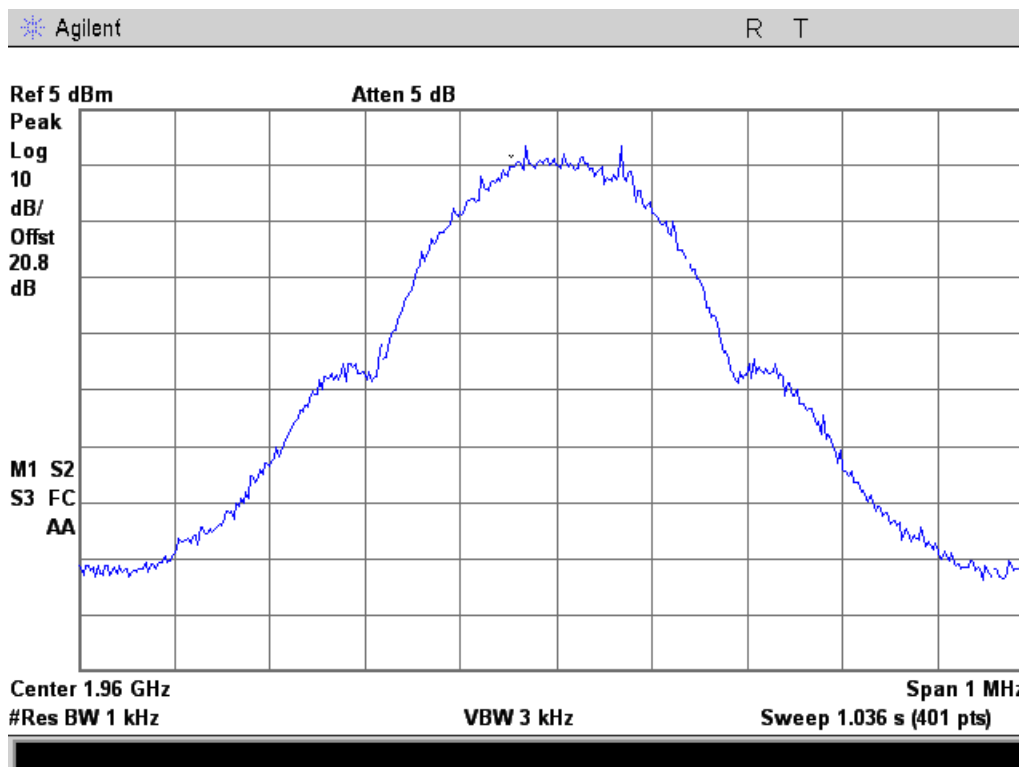



### 2110 - 2155 MHz Band

#### Input

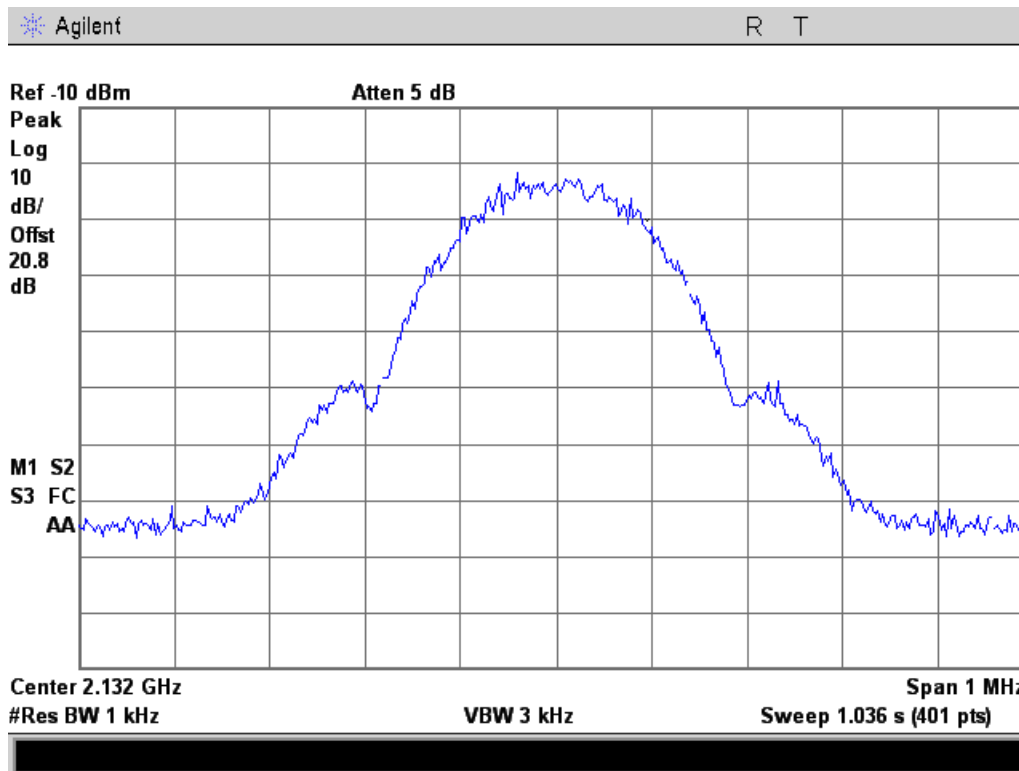

#### Output

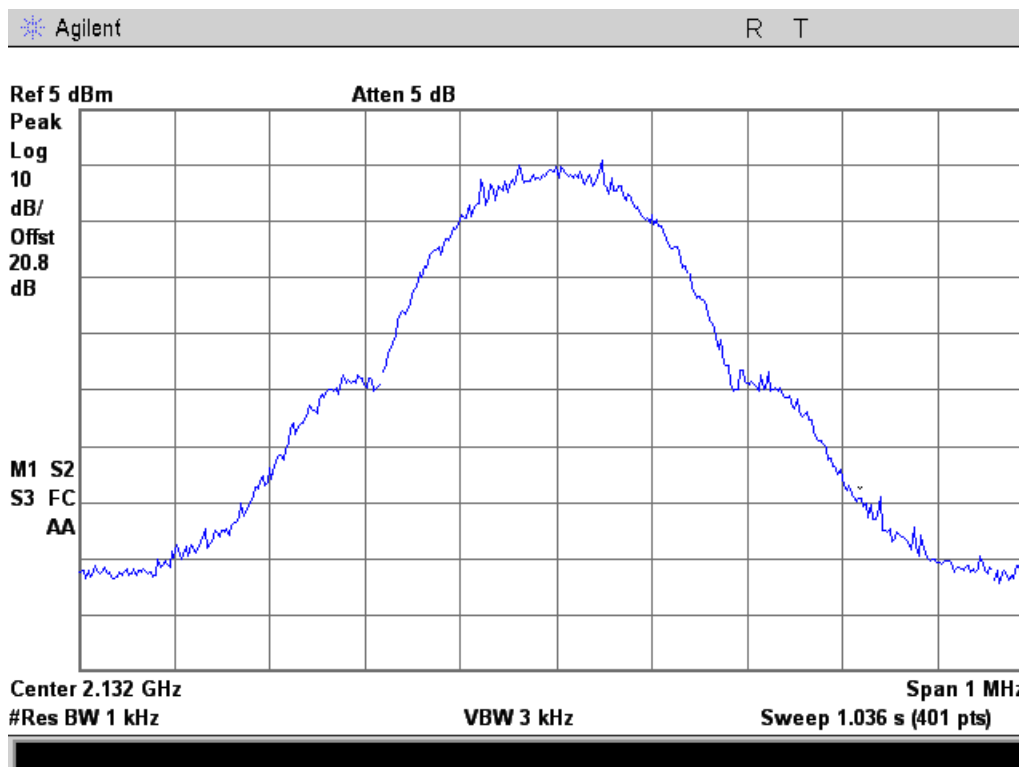



### CDMA Uplink Test Plots

698 - 716 MHz Band

Input

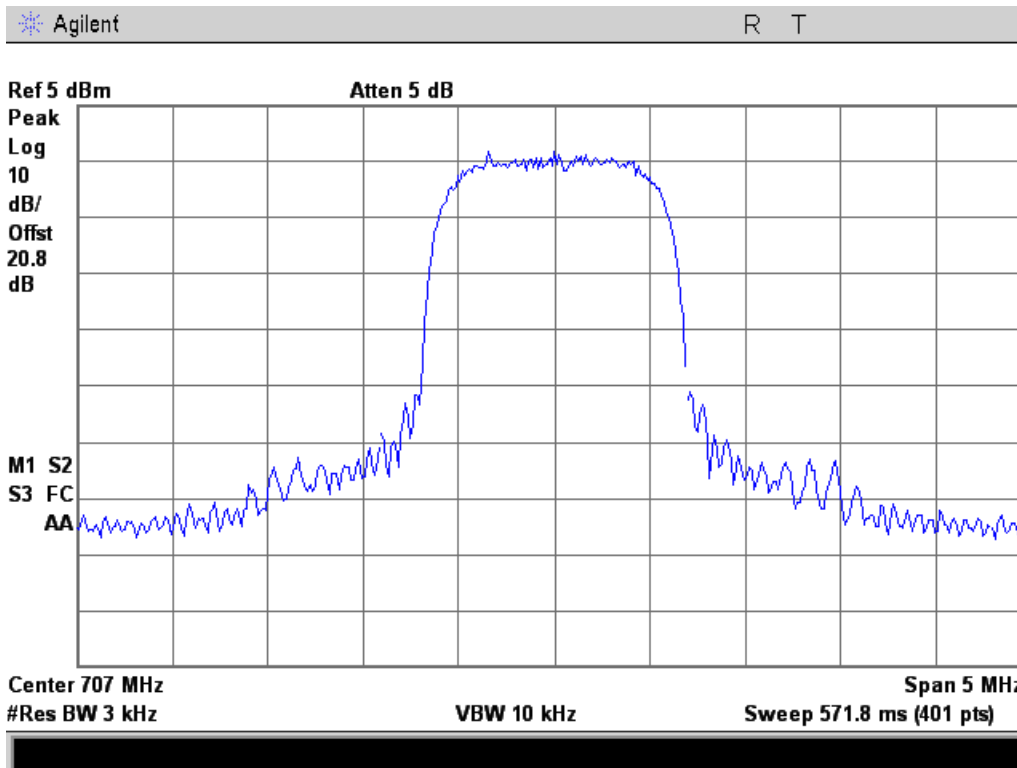

Output

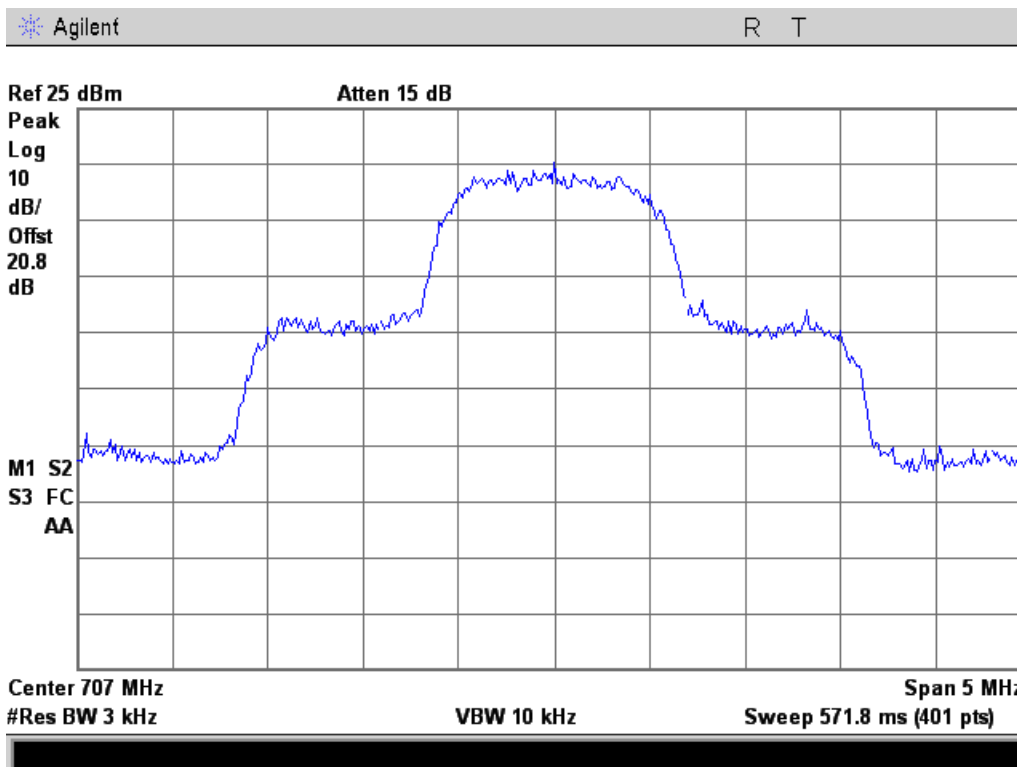





### 776 - 787 MHz Band

#### Input

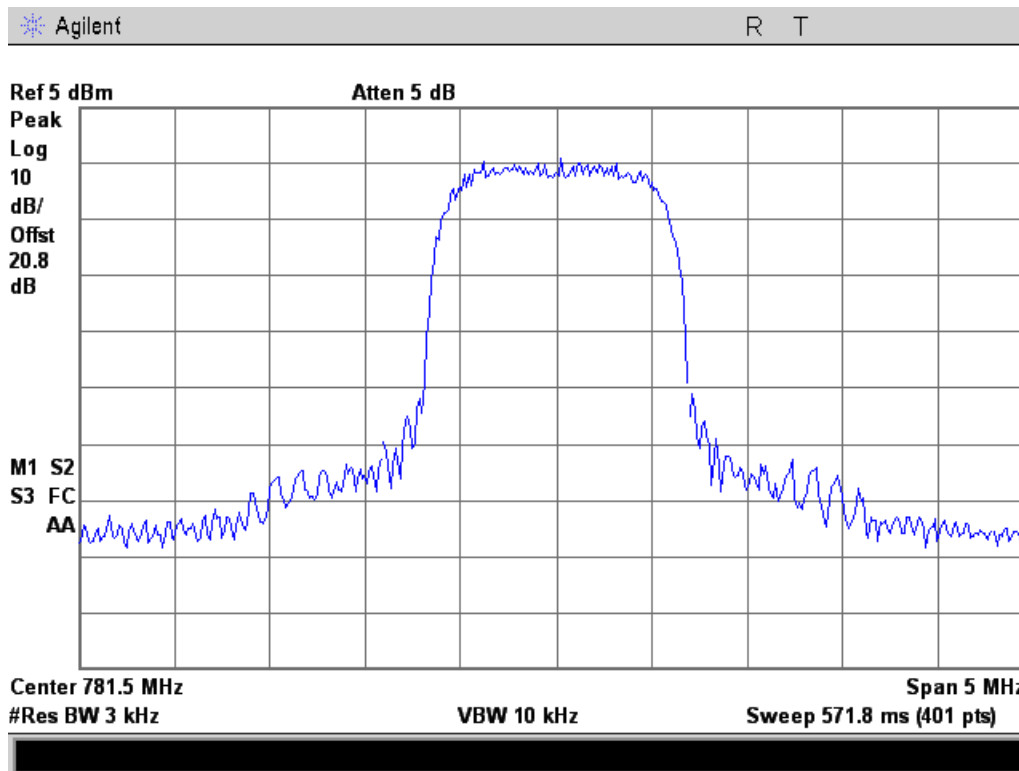

#### Output

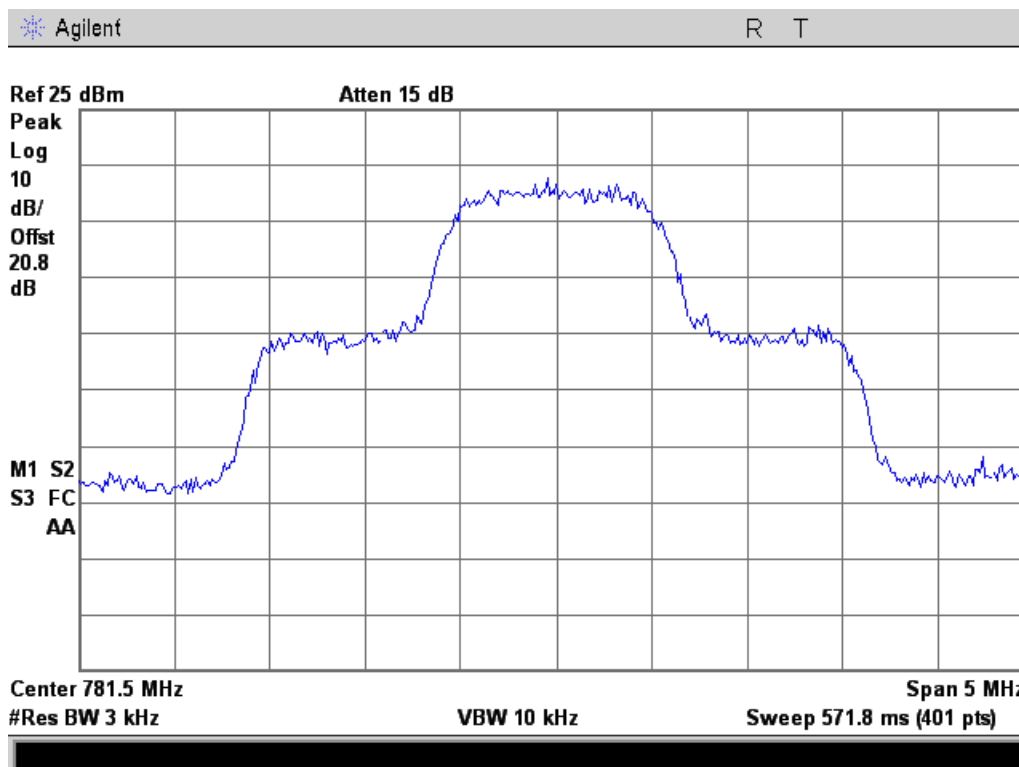



### 824 - 849 MHz Band

#### Input

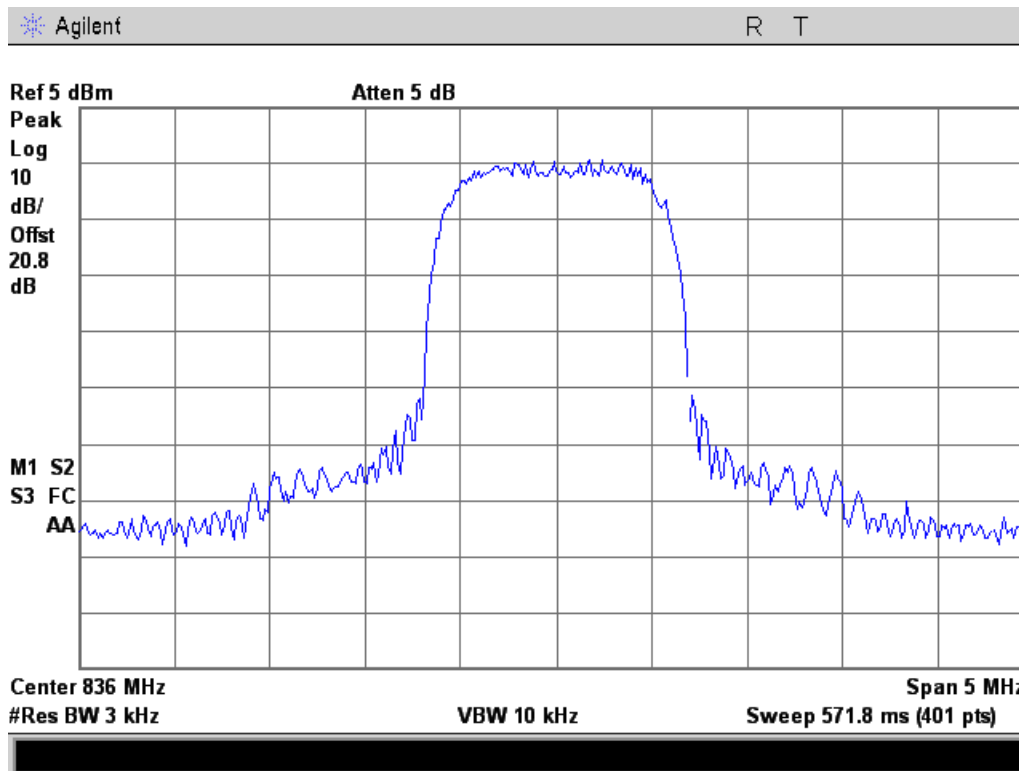

#### Output

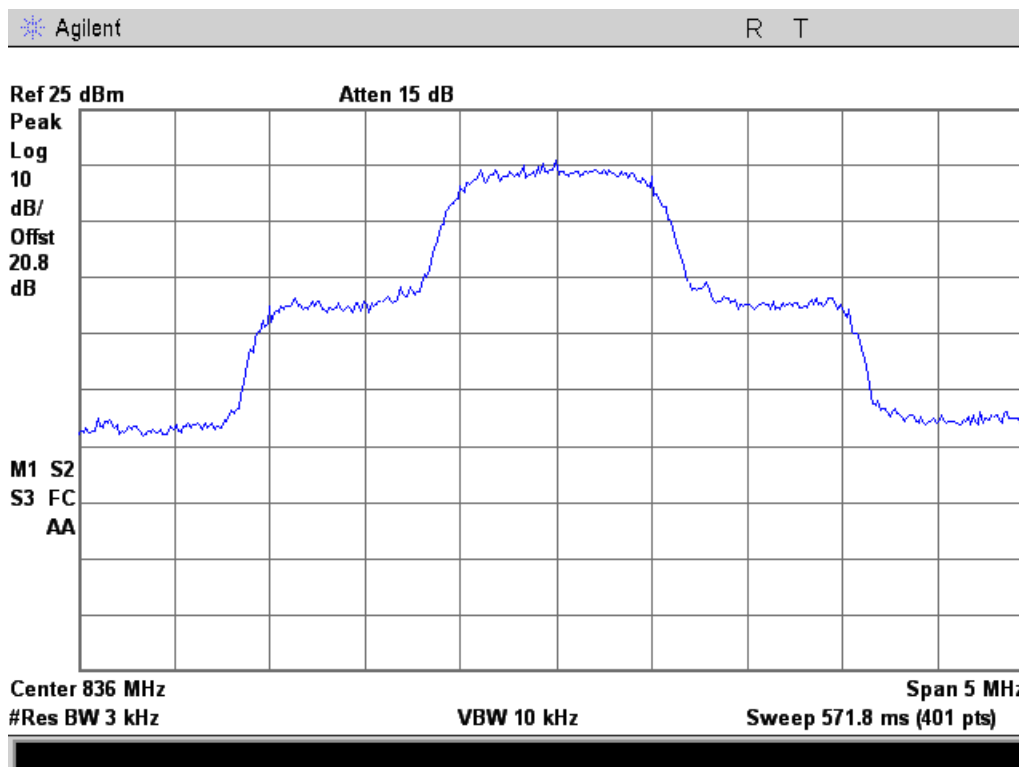



### 1710 - 1755 MHz Band

#### Input

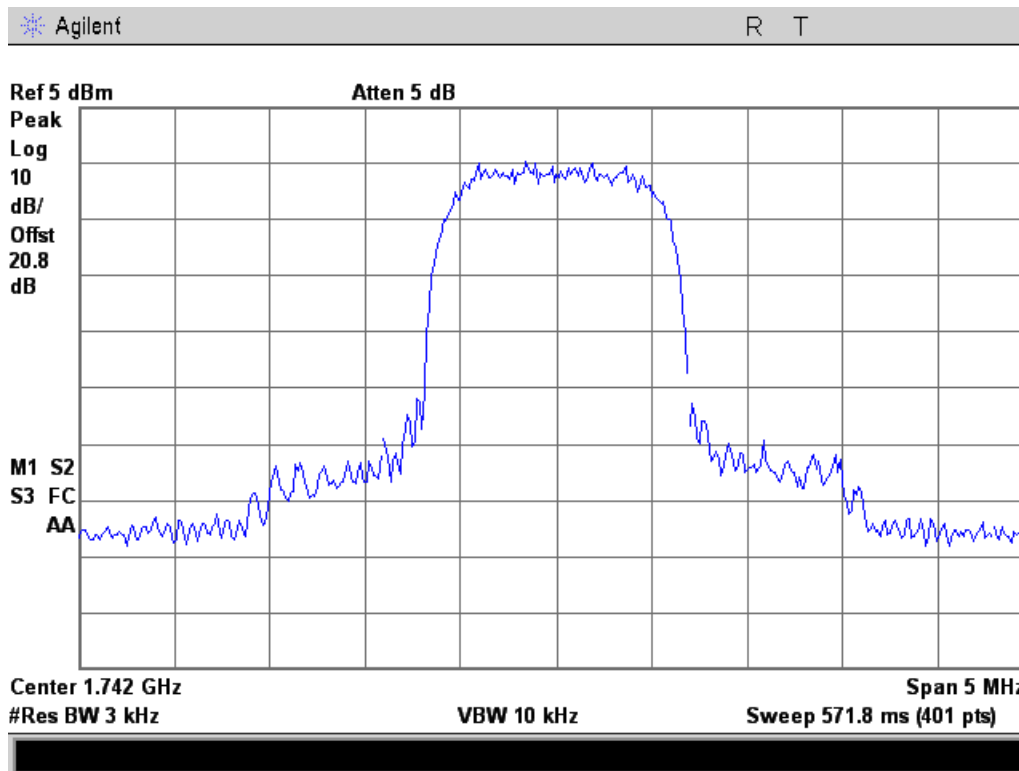

#### Output

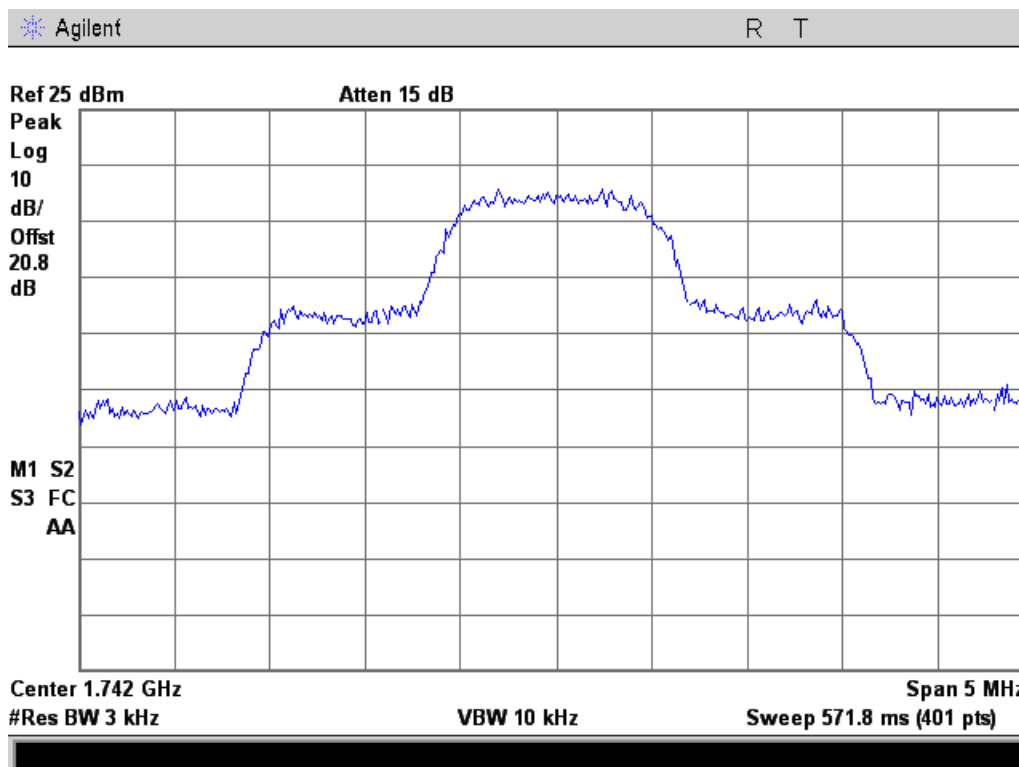



### 1850 - 1915 MHz Band

#### Input

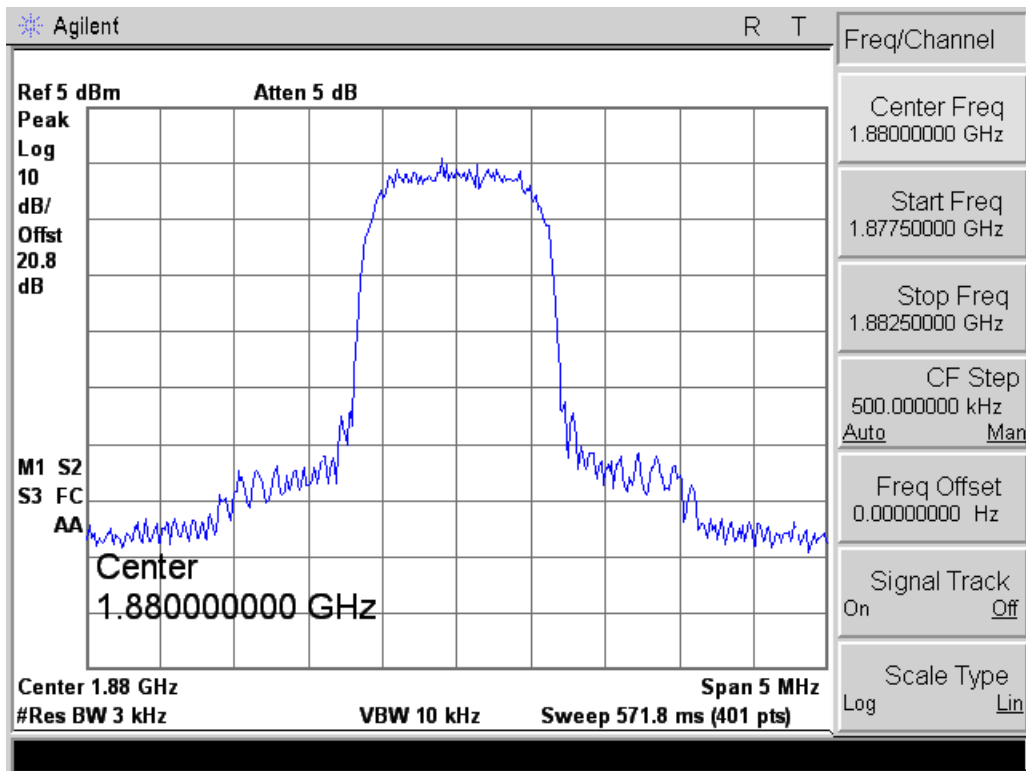

#### Output

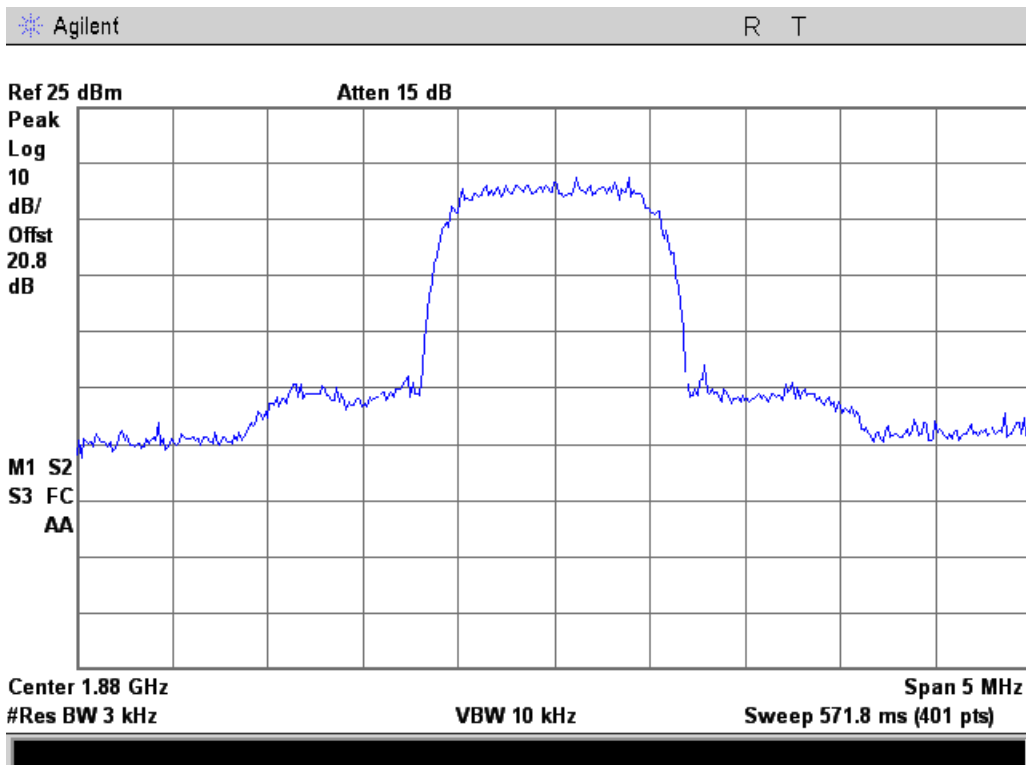



### CDMA Downlink Test Plots

728 - 746 MHz Band

Input

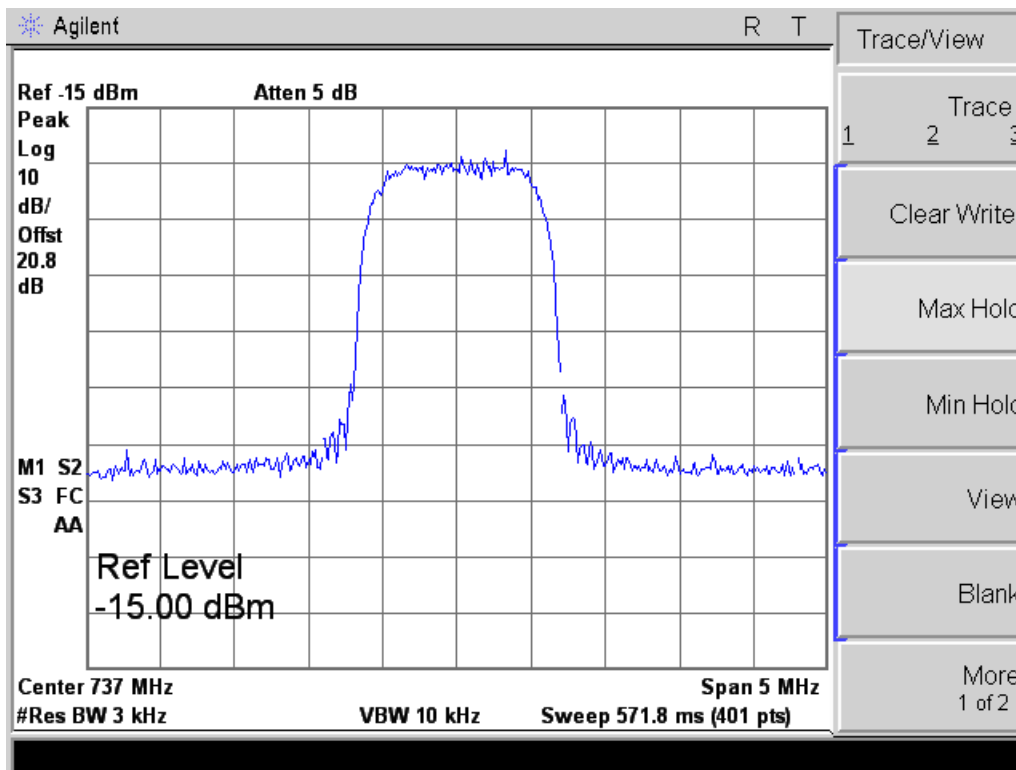

Output

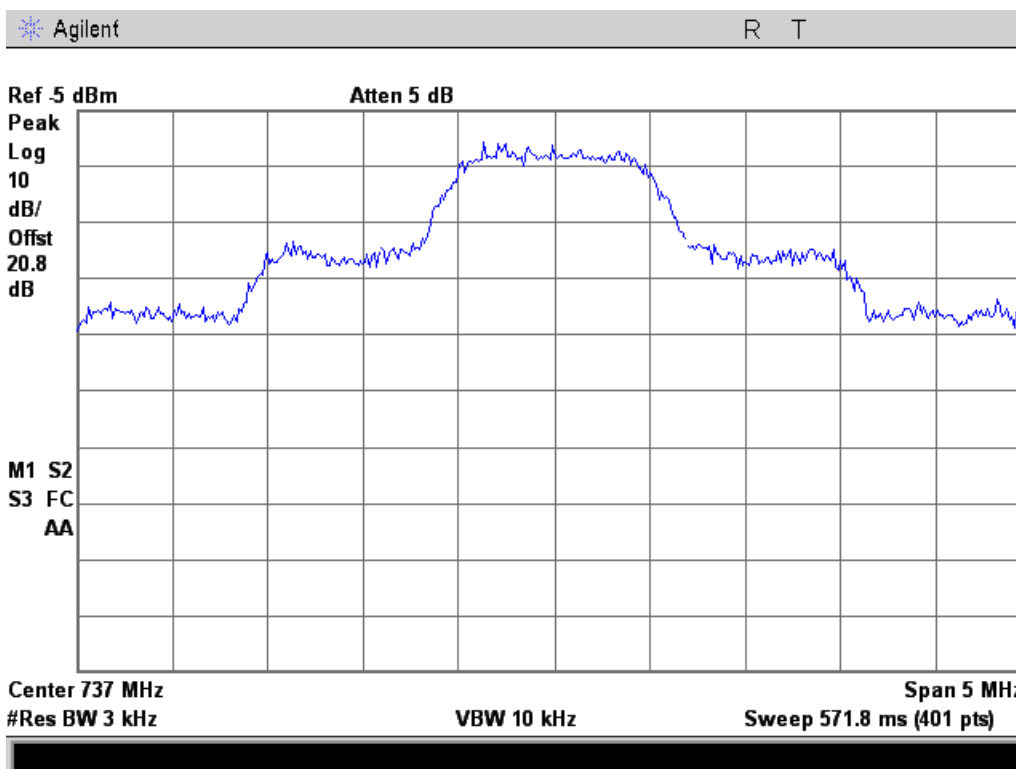



### 746 - 757 MHz Band

#### Input

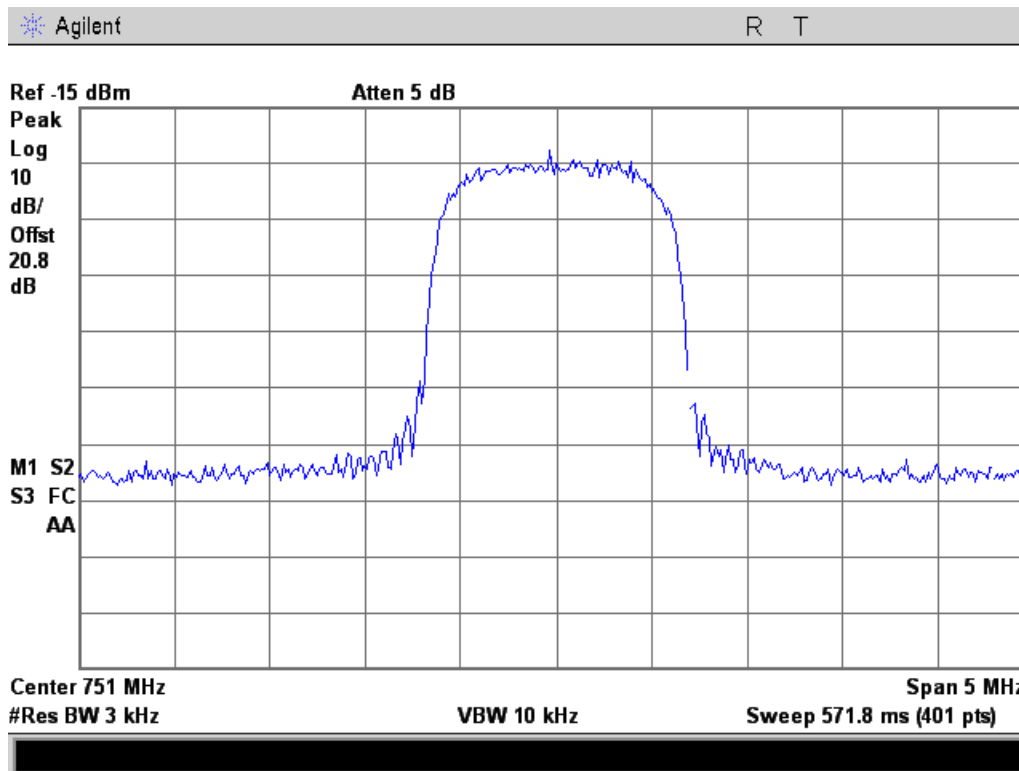

#### Output

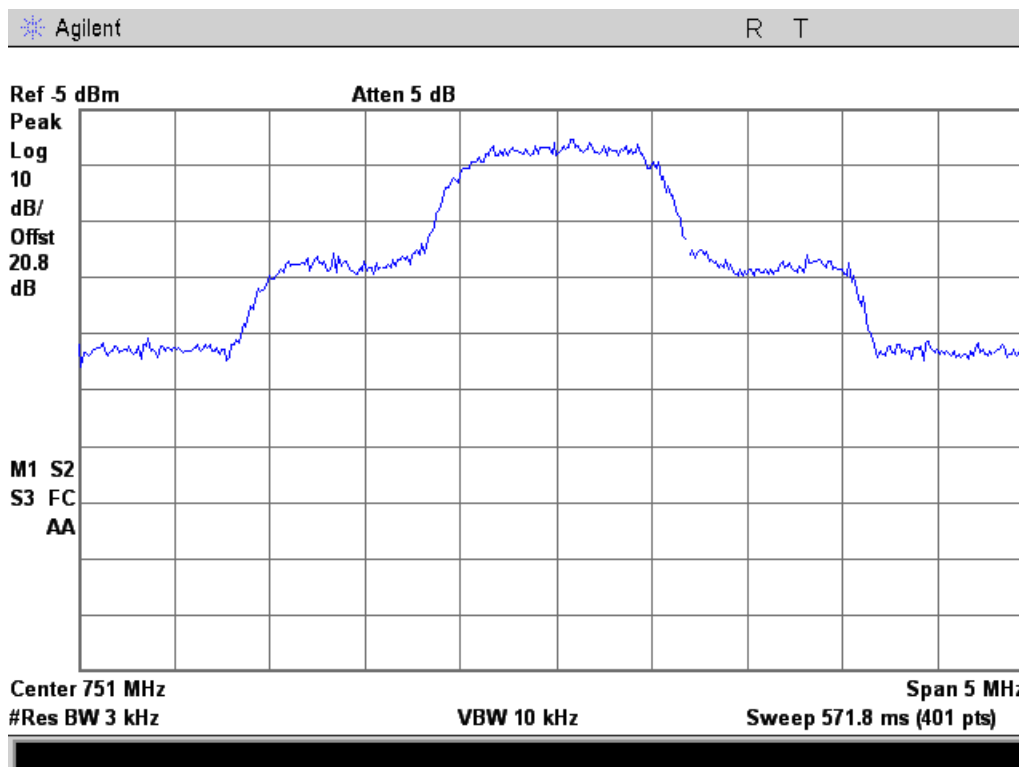



### 869 - 894 MHz Band

#### Input

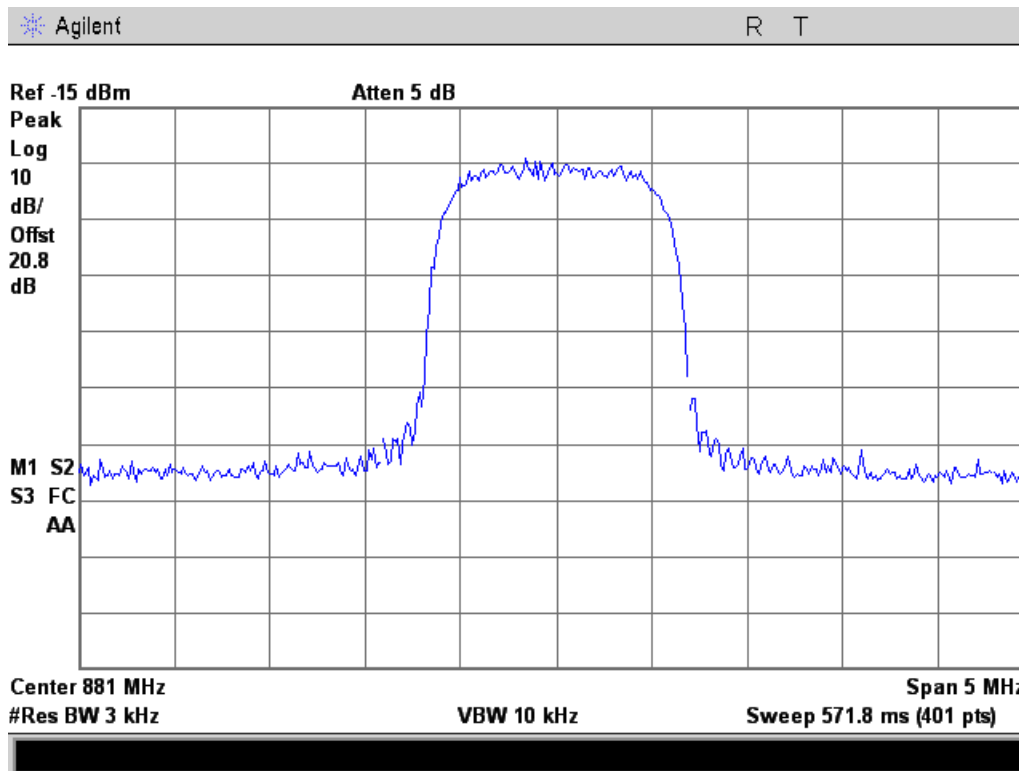

#### Output

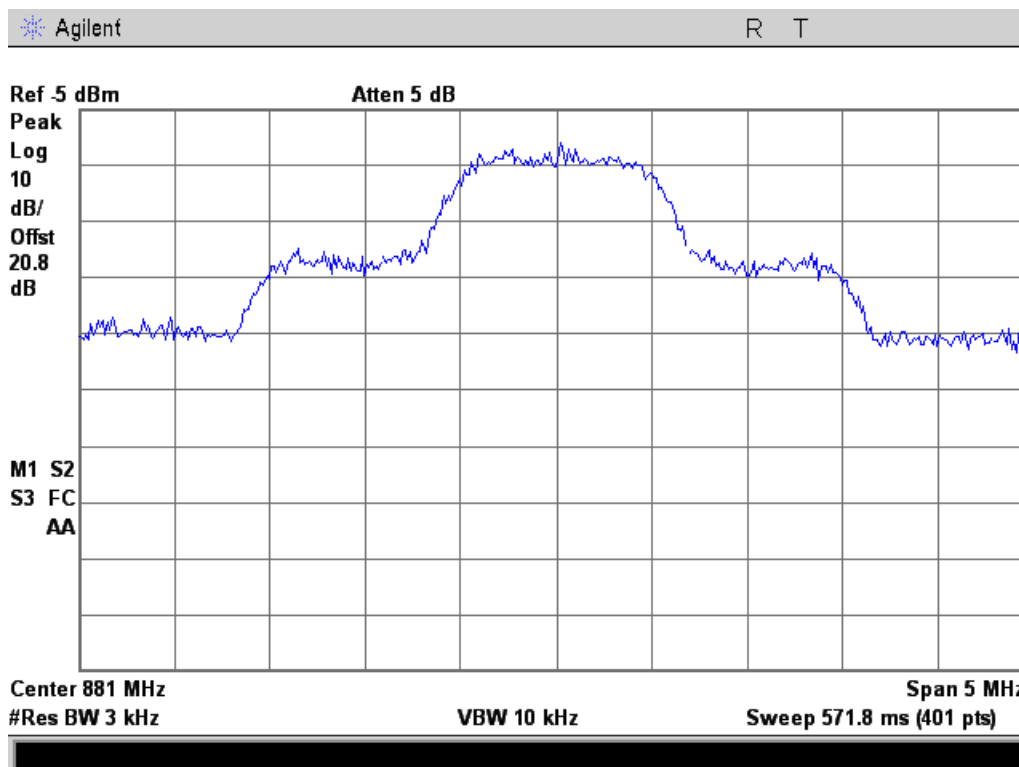



### 1930 - 1995 MHz Band

#### Input

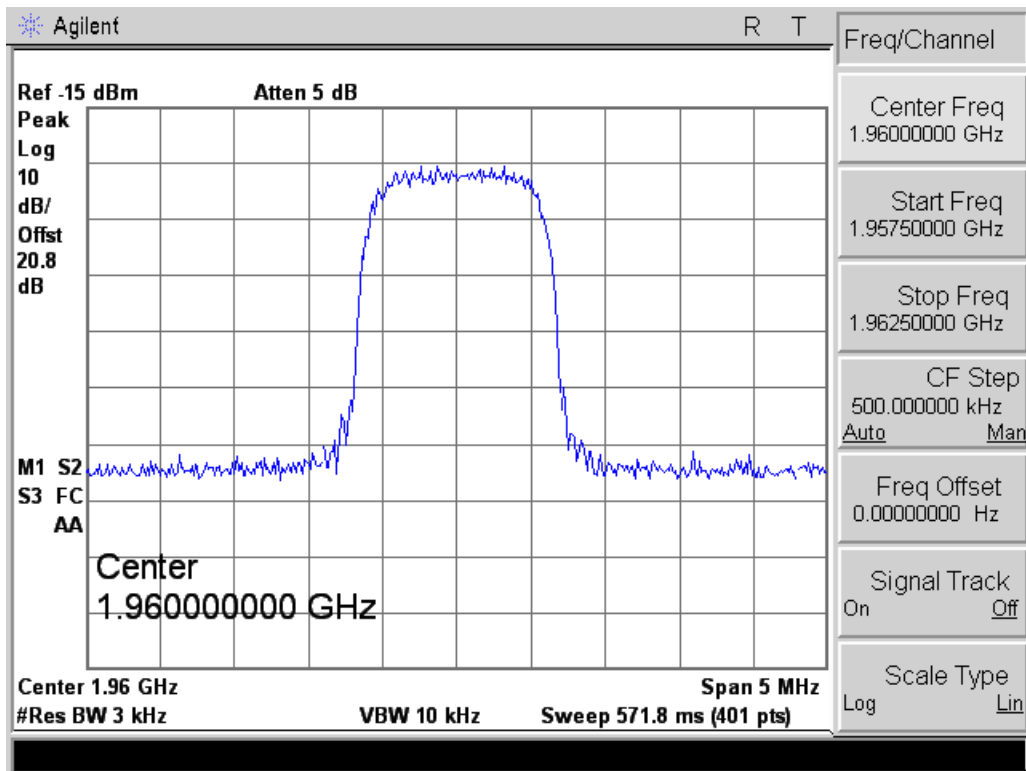

#### Output

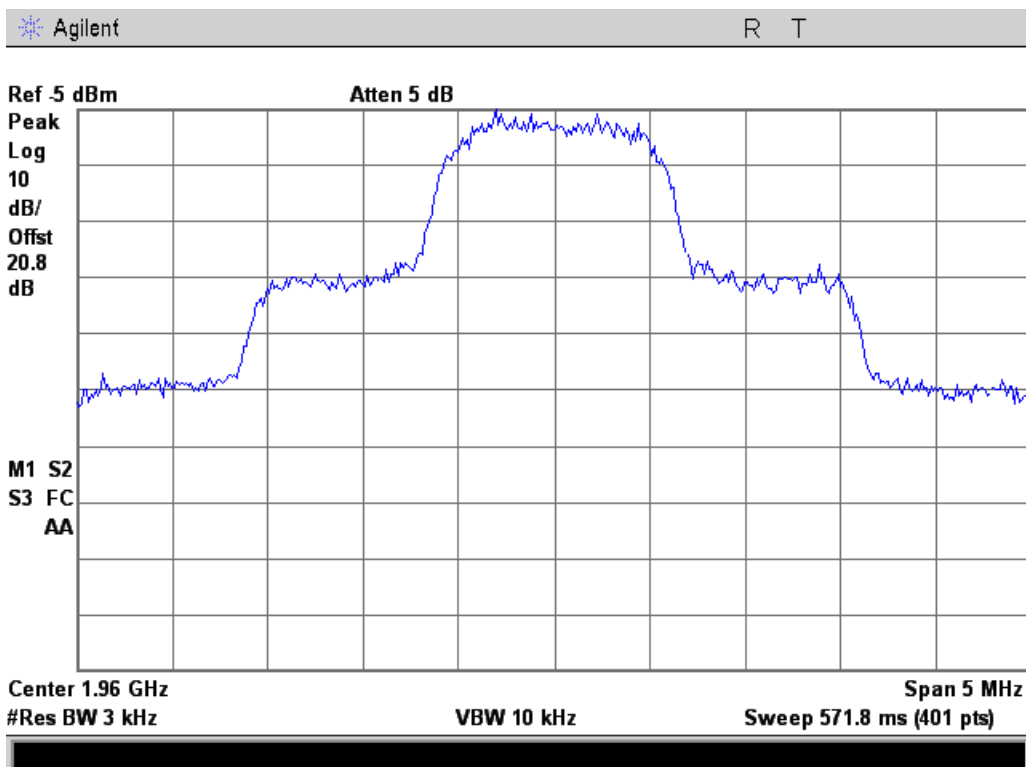





### 2110 - 2155 MHz Band

#### Input

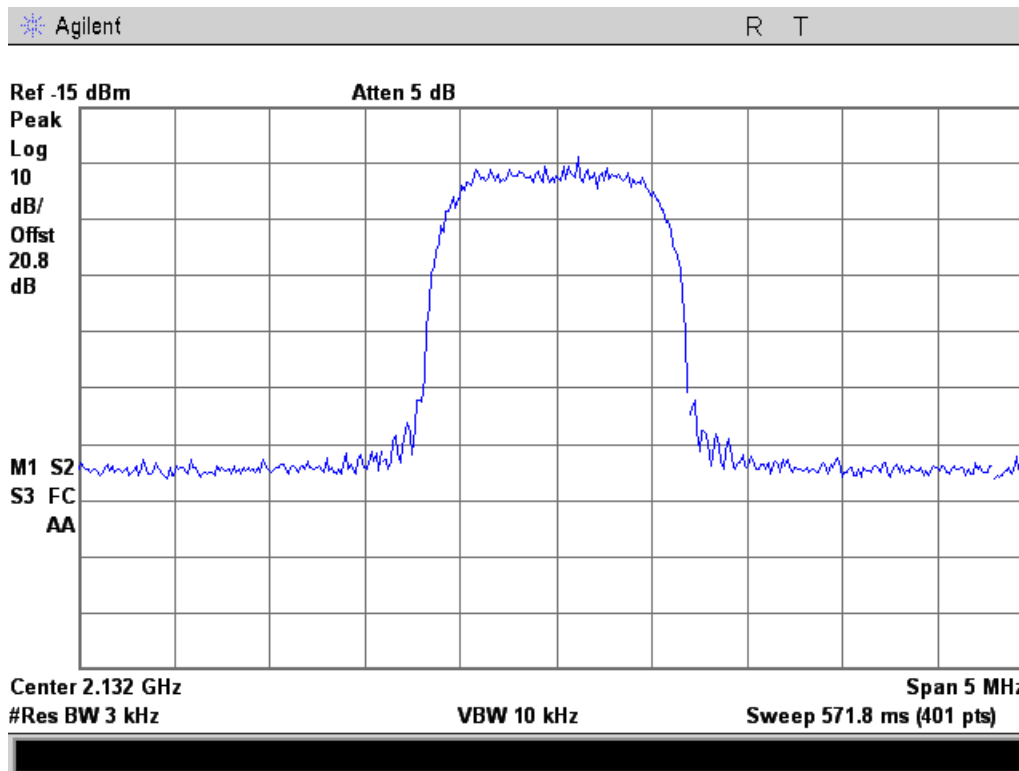

#### Output

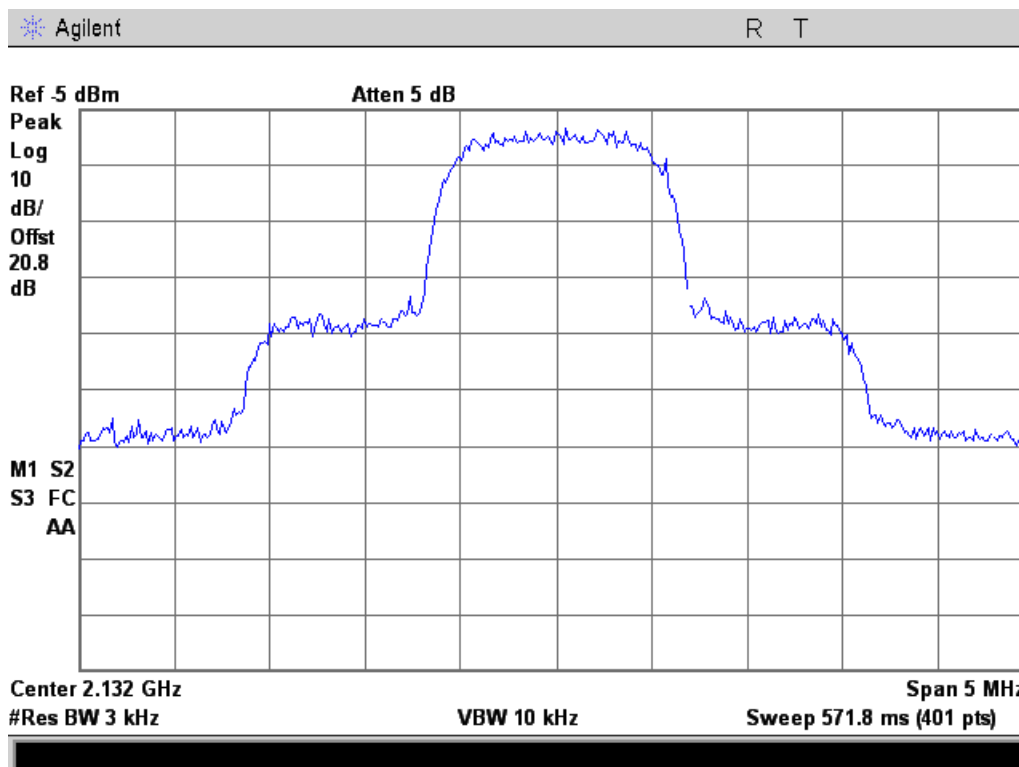



### WCDMA Uplink Test Plots

698 - 716 MHz Band

Input

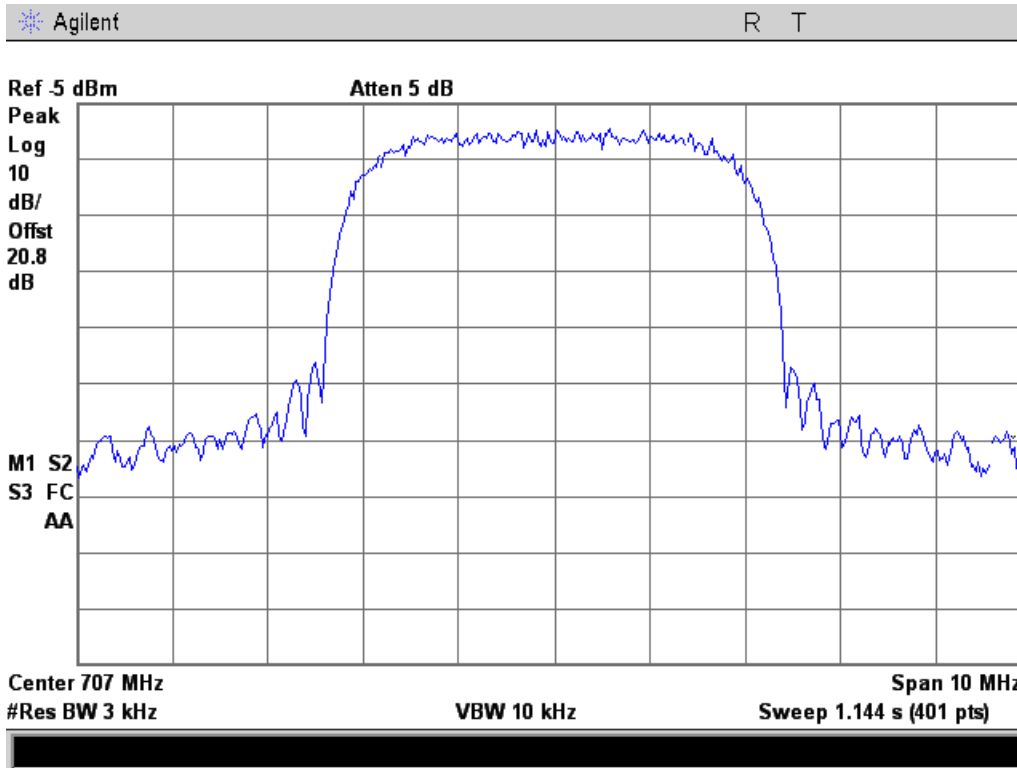

Output

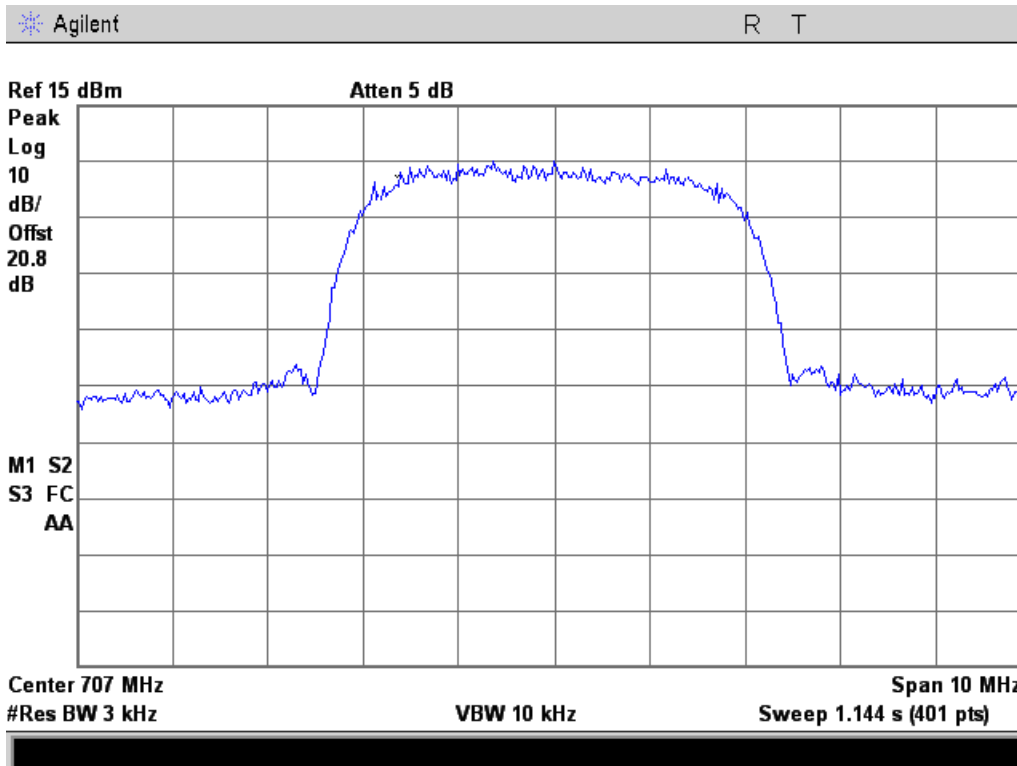



### 776 - 787 MHz Band

#### Input

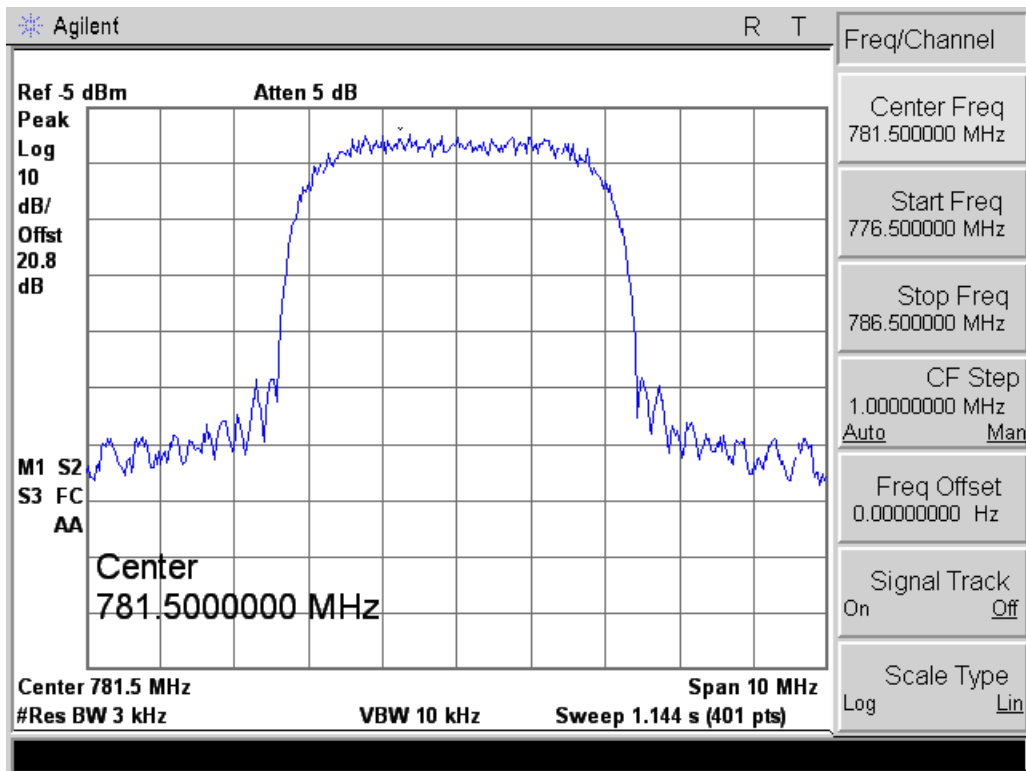

#### Output

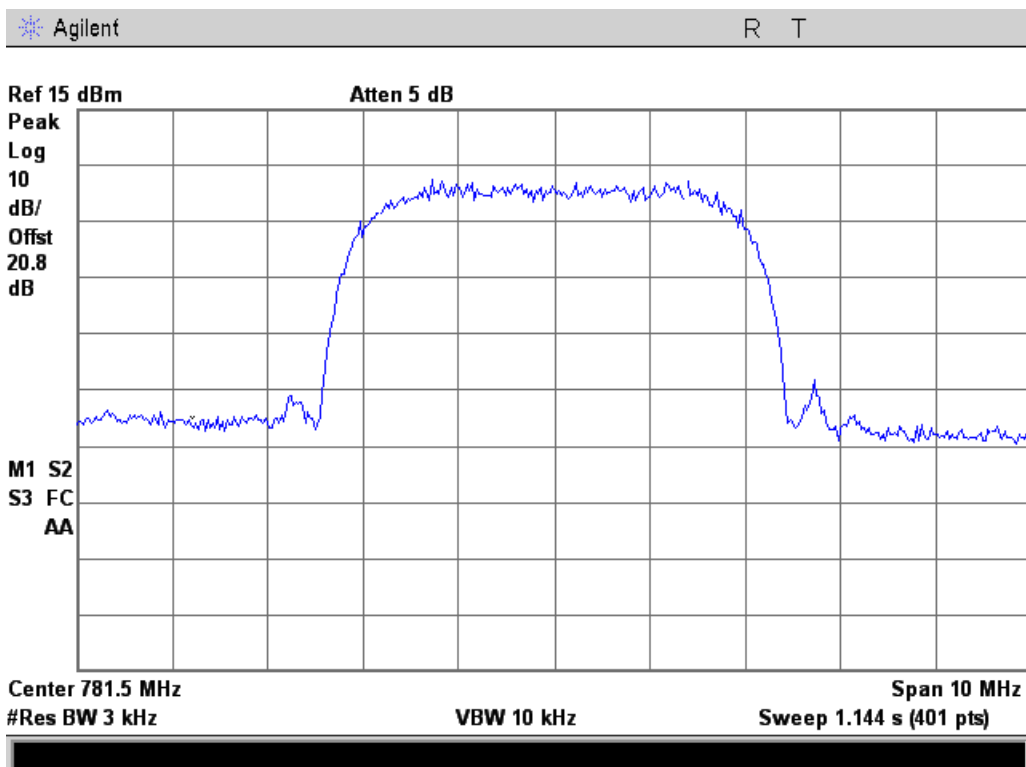



### 824 - 849 MHz Band

#### Input

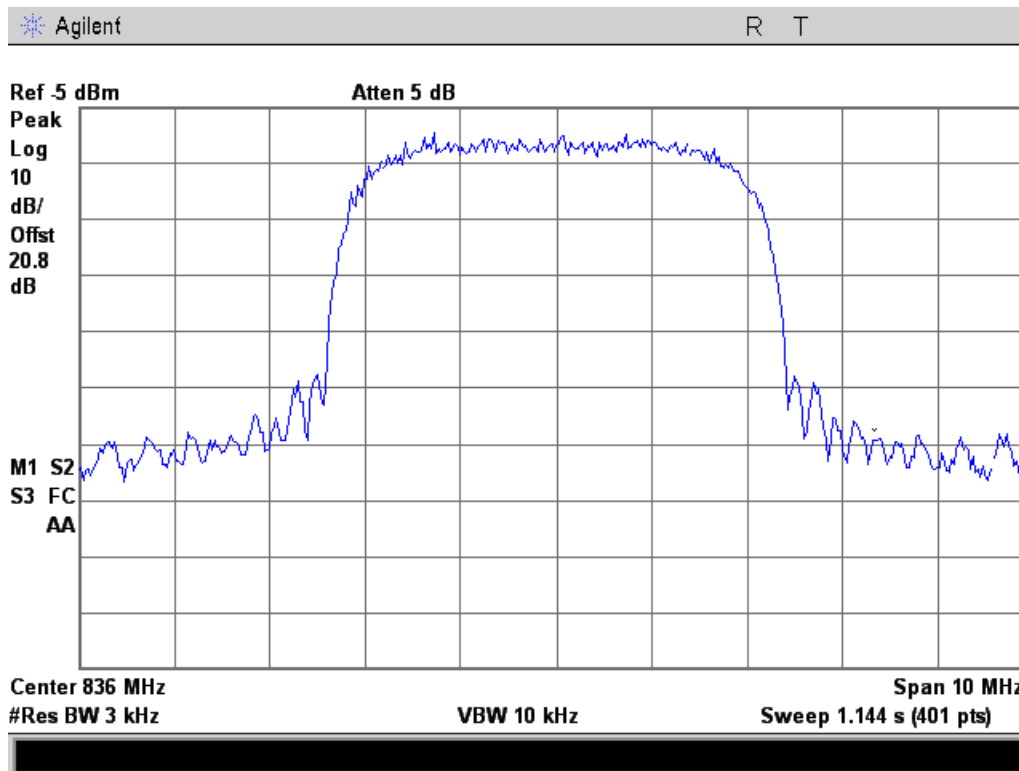

#### Output

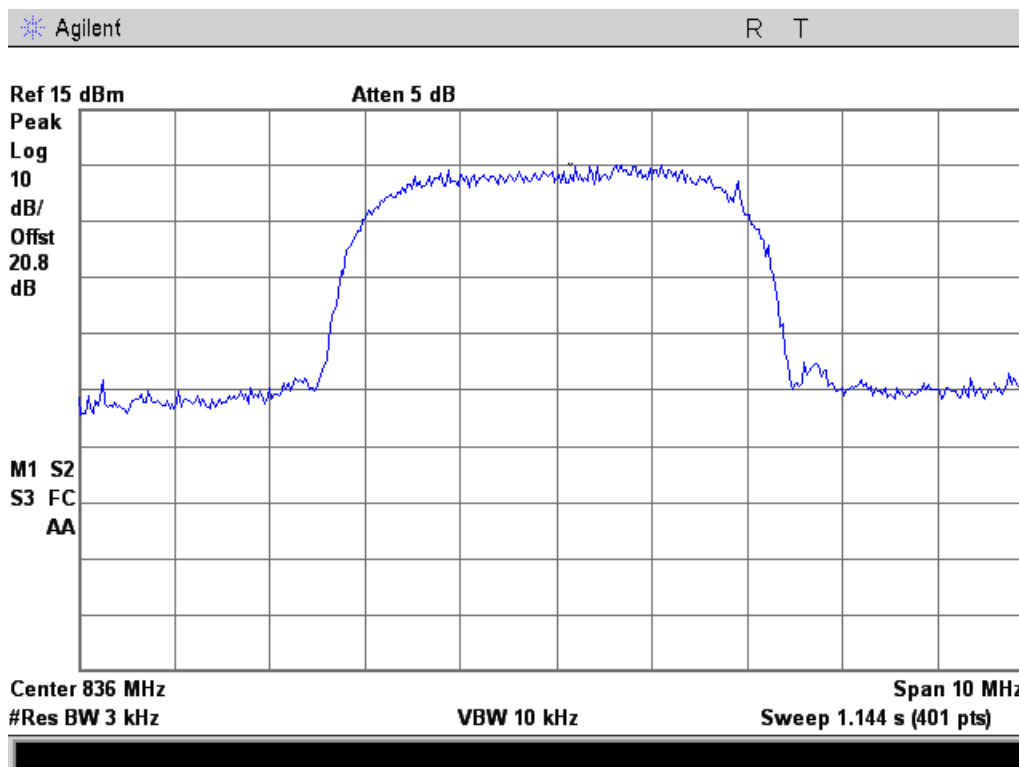



### 1710 - 1755 MHz Band

#### Input

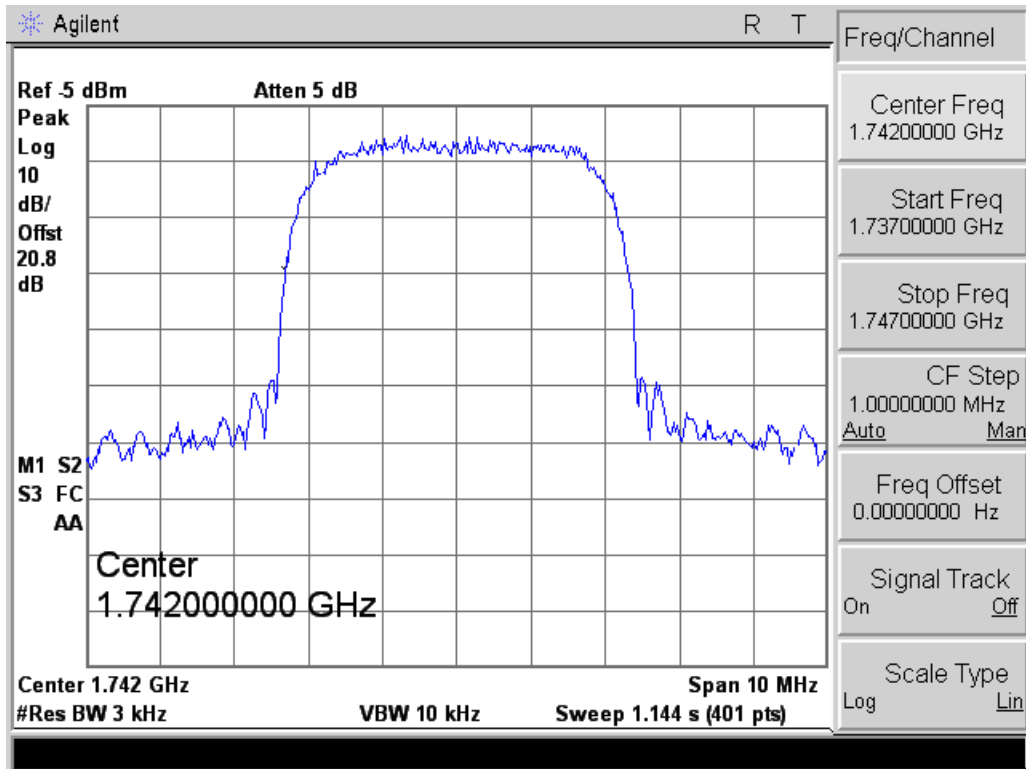

#### Output

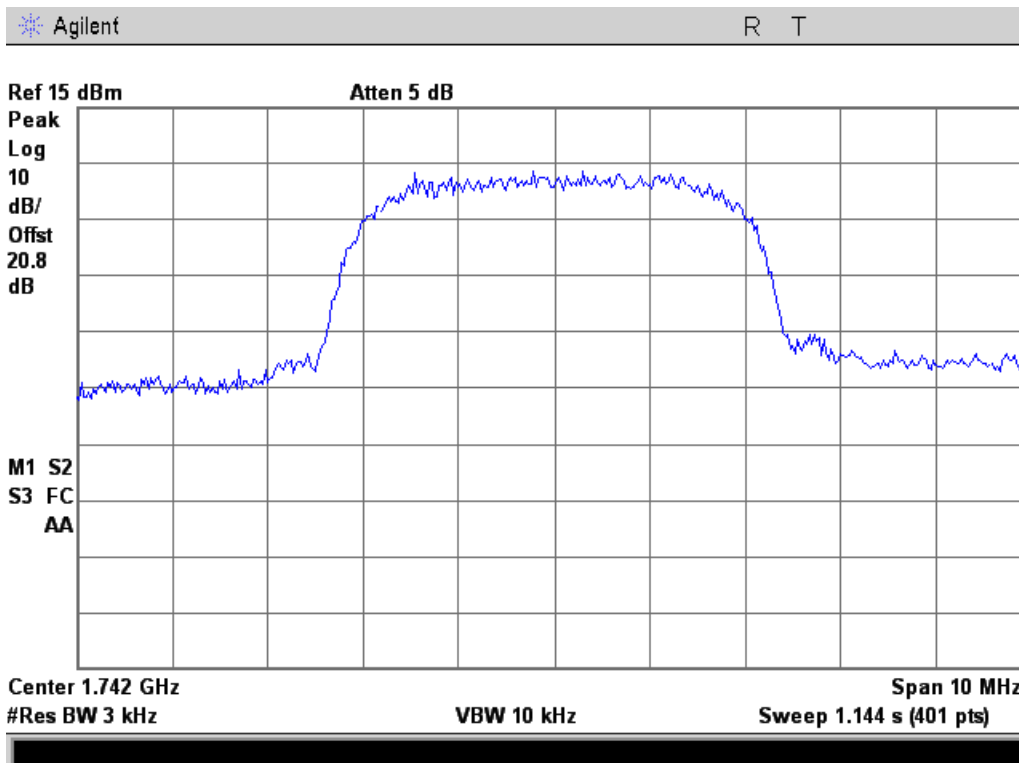



### 1850 - 1915 MHz Band

#### Input

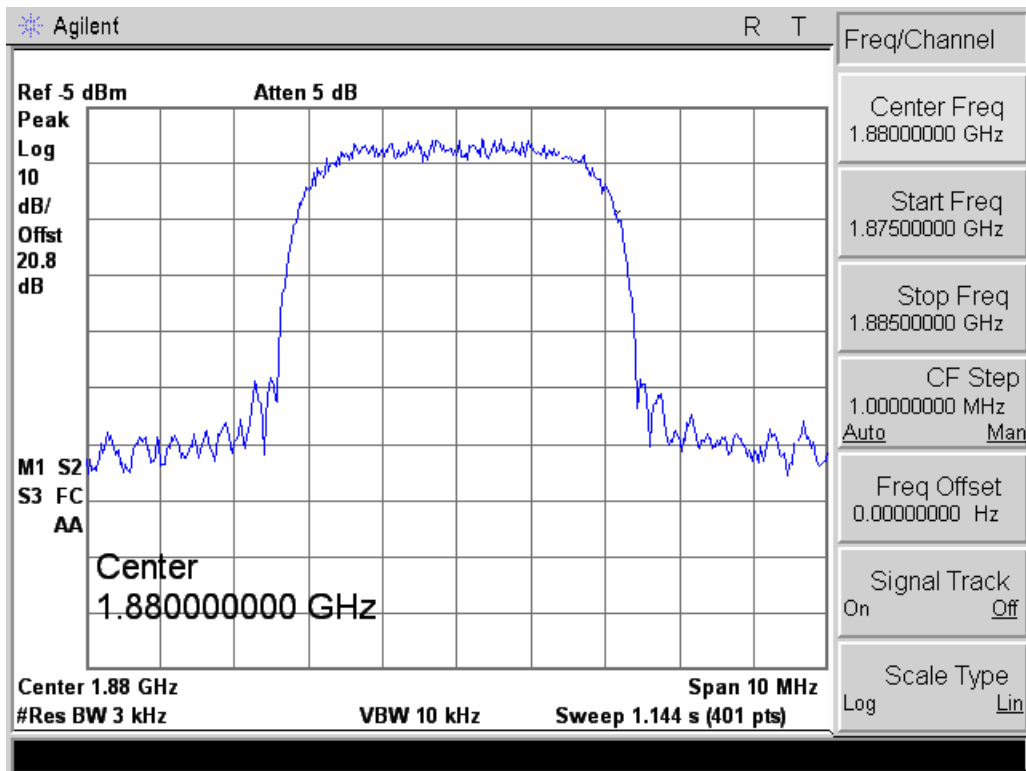

#### Output

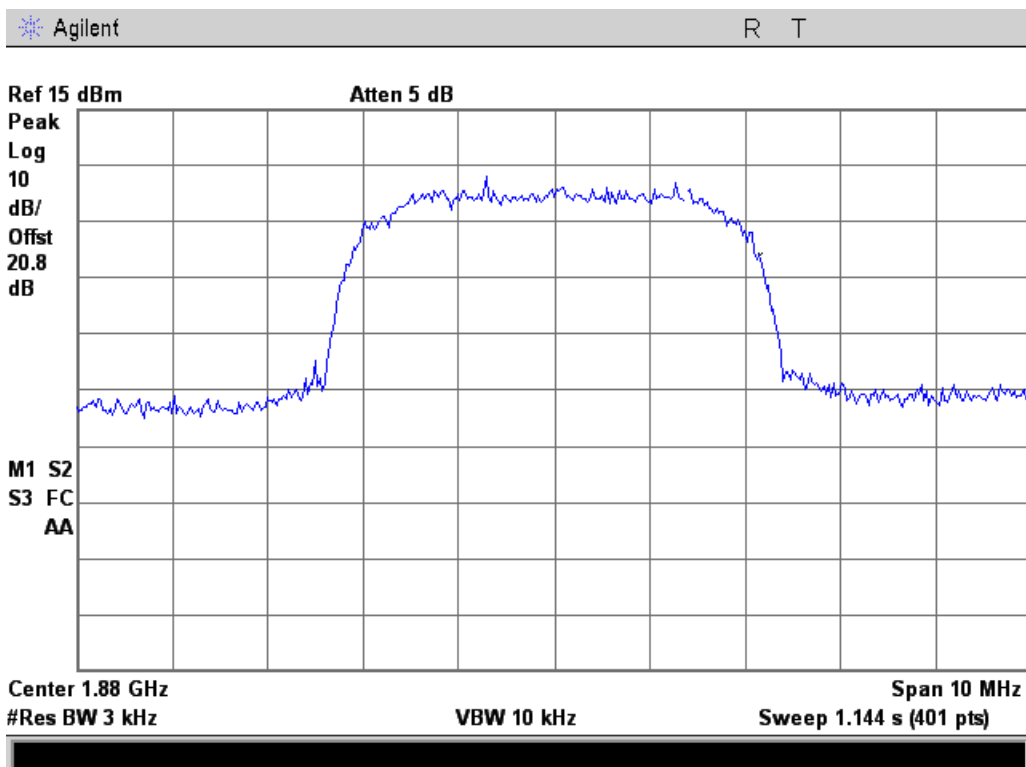



### WCDMA Downlink Test Plots

728 - 746 MHz Band

Input

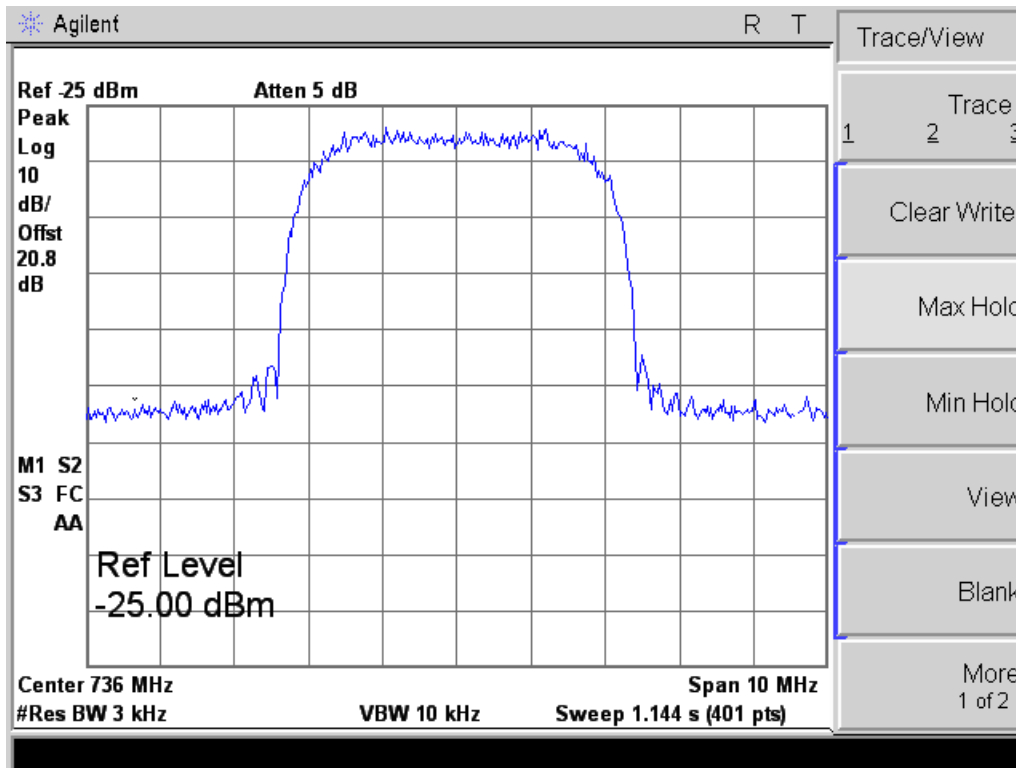

Output

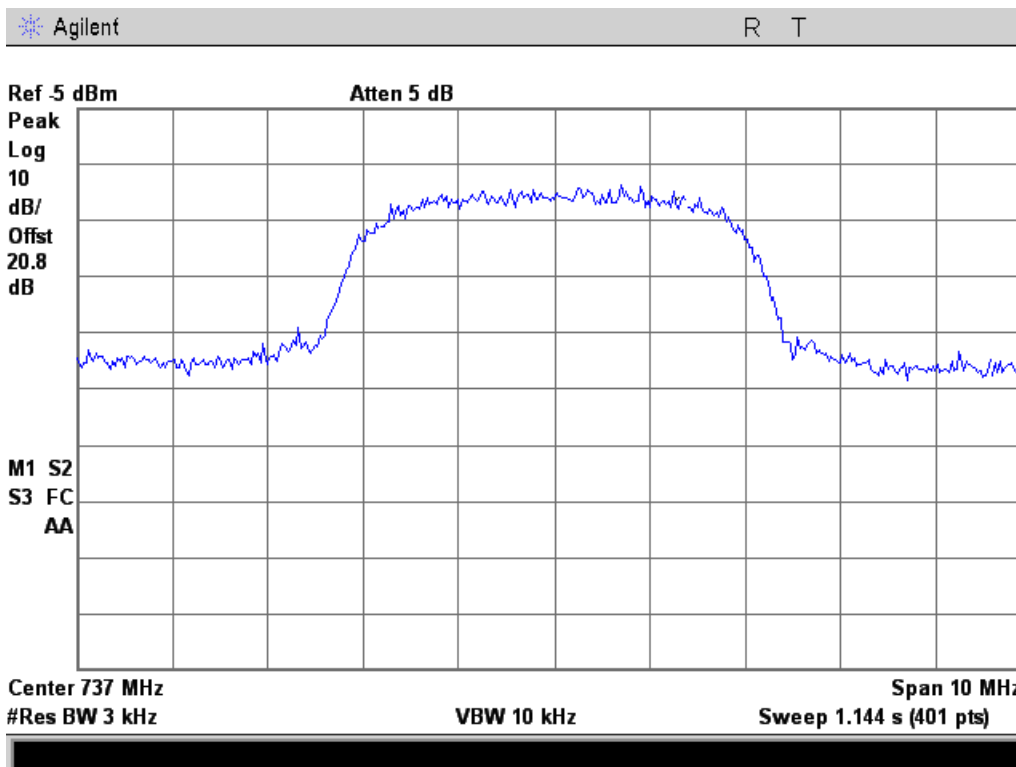



### 746 - 757 MHz Band

#### Input

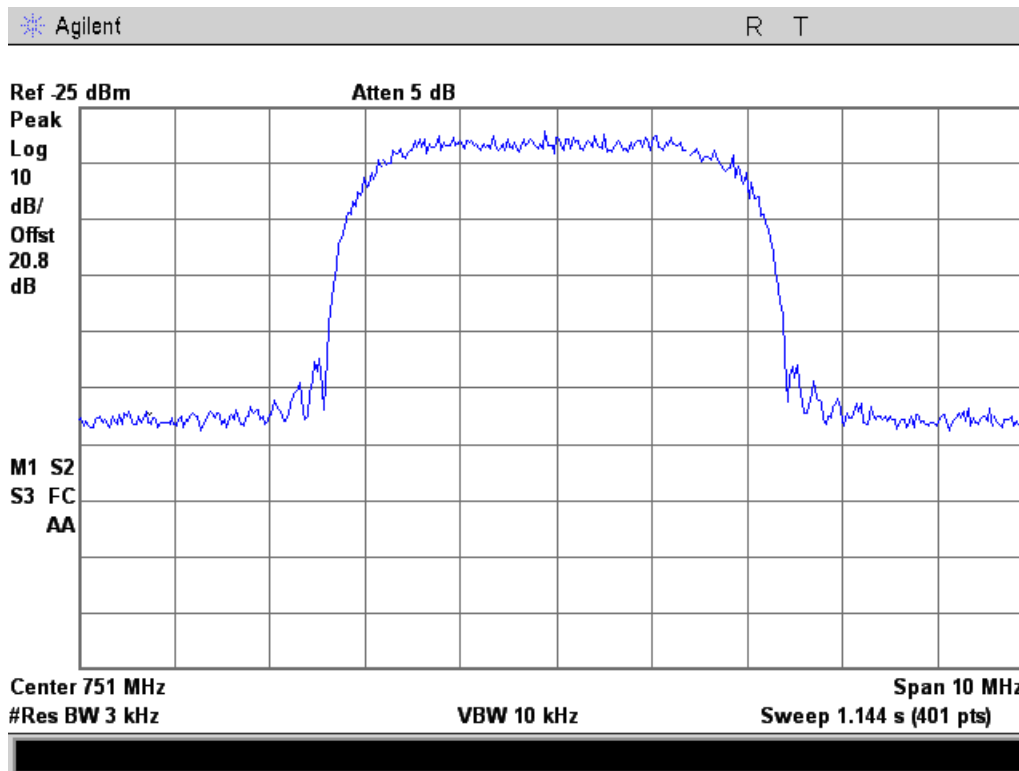

#### Output

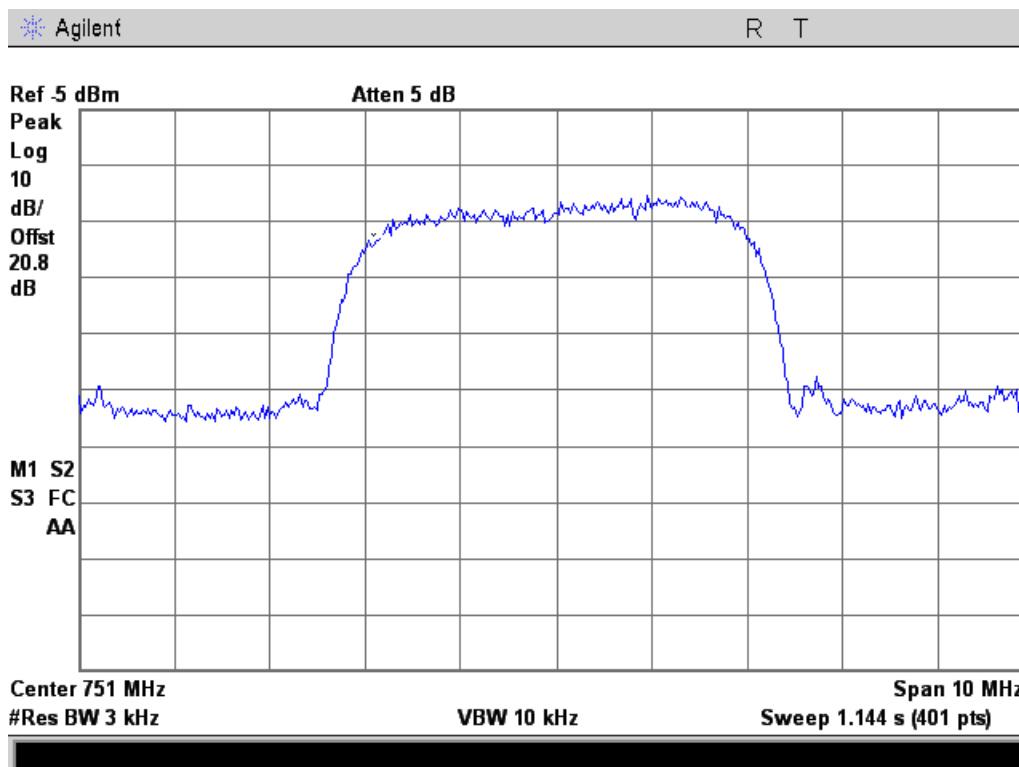





### 869 - 894 MHz Band

#### Input

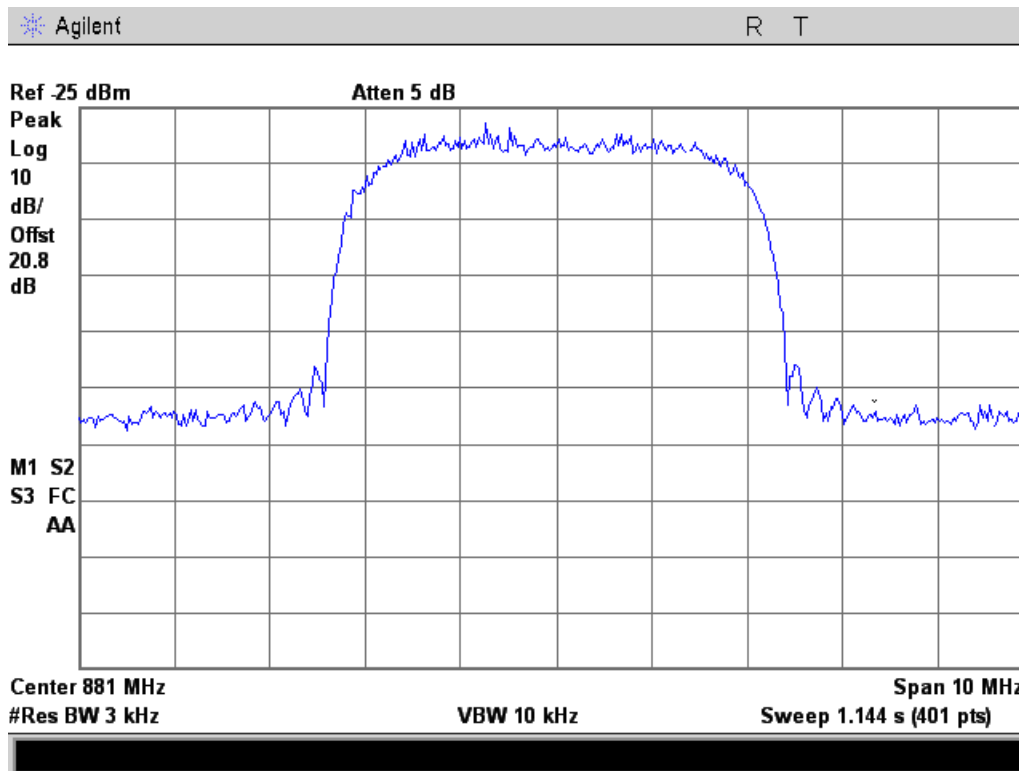

#### Output

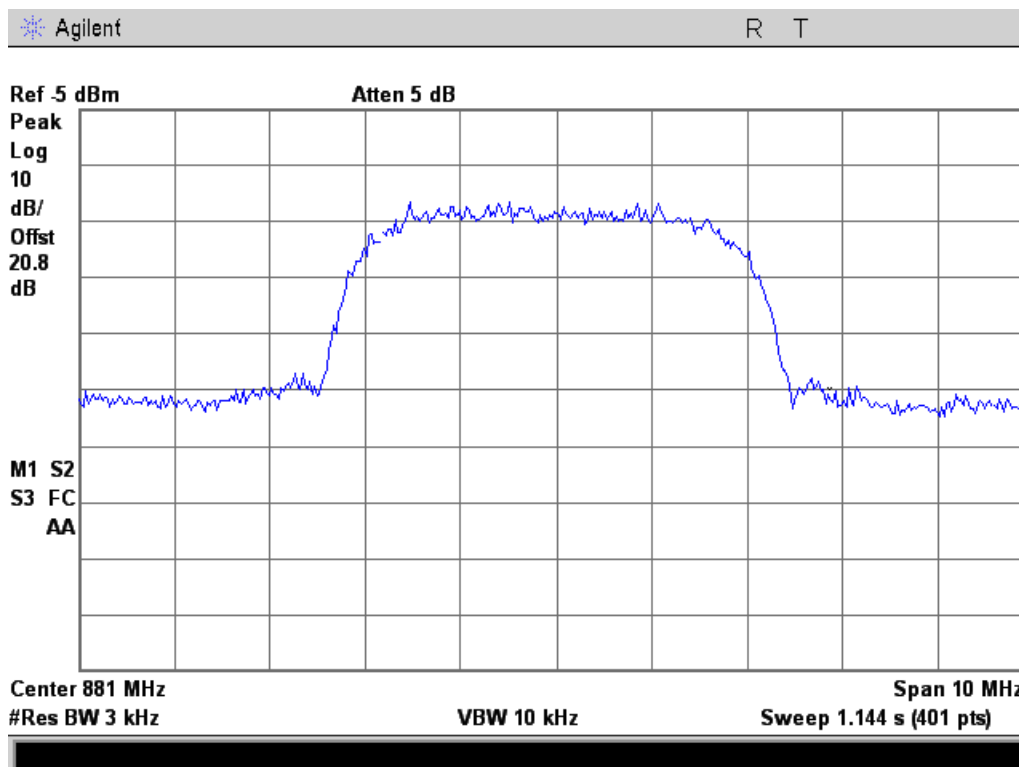



### 1930 - 1995 MHz Band

#### Input

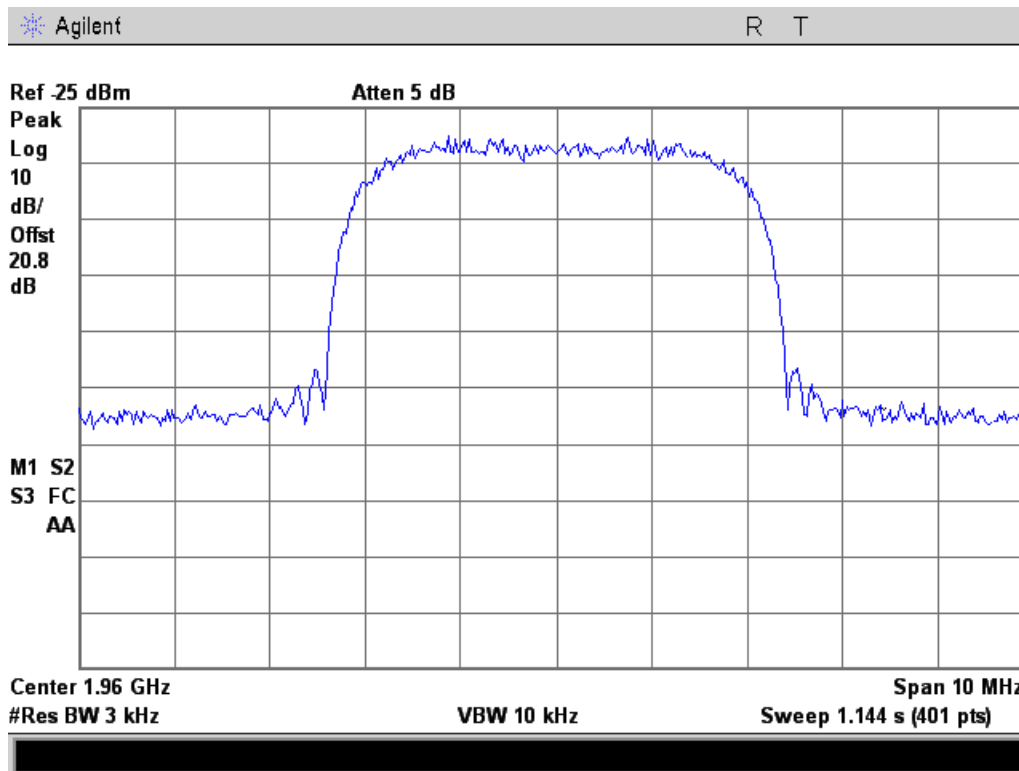

#### Output

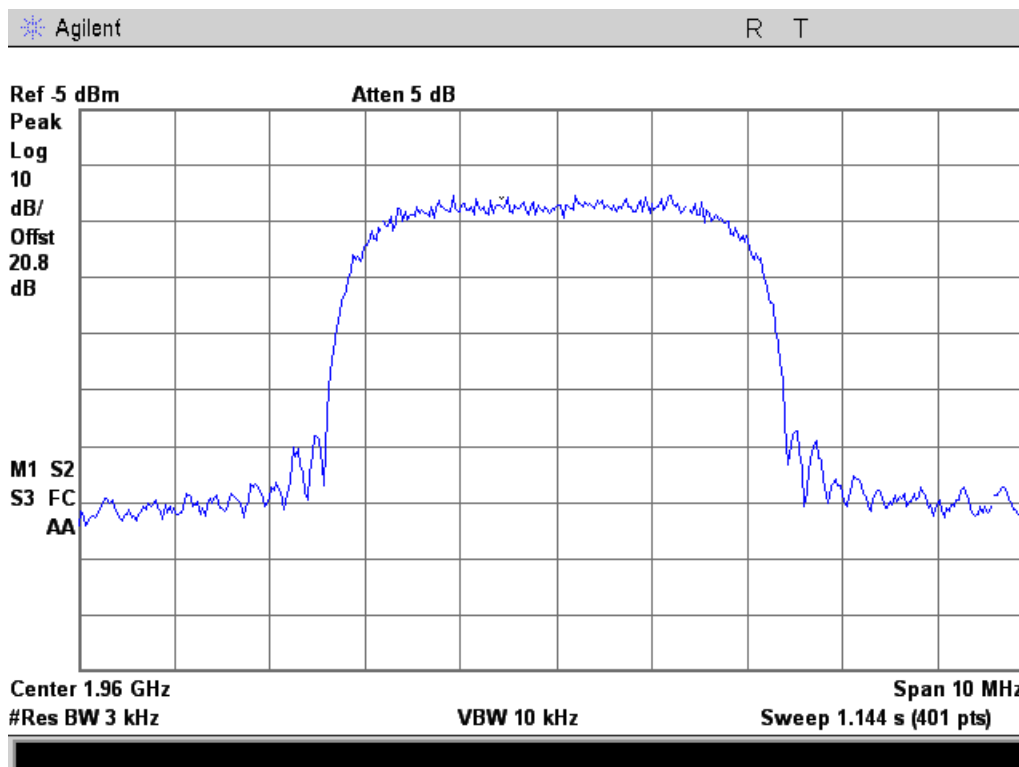



### 2110 - 2155 MHz Band

#### Input

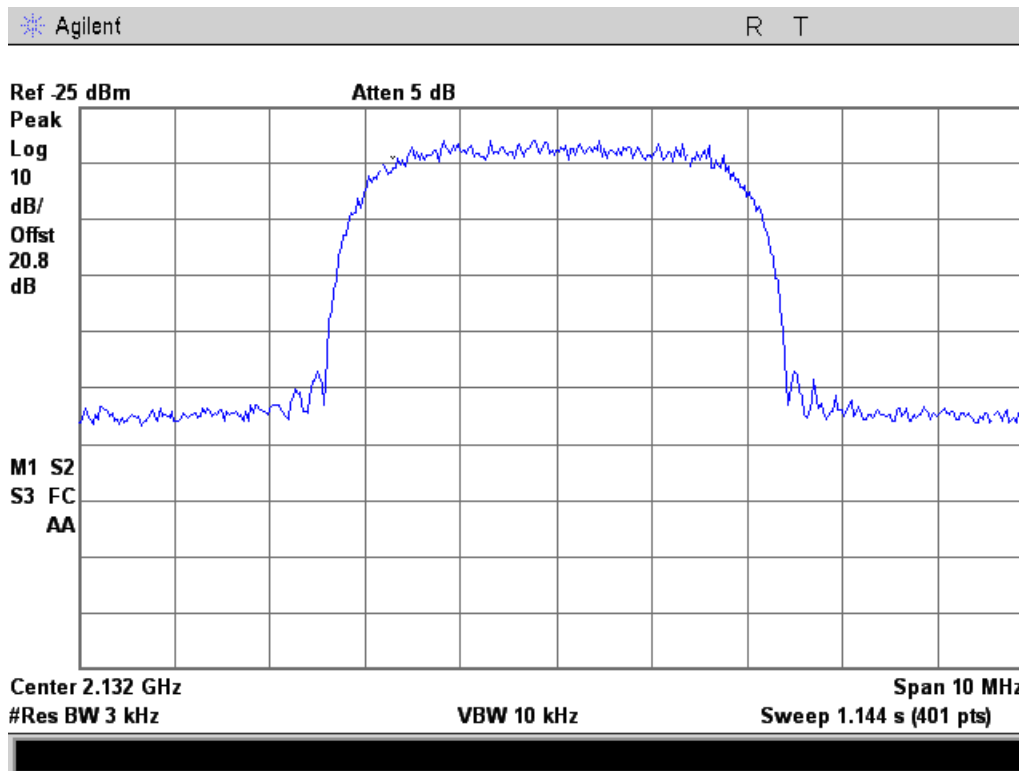

#### Output

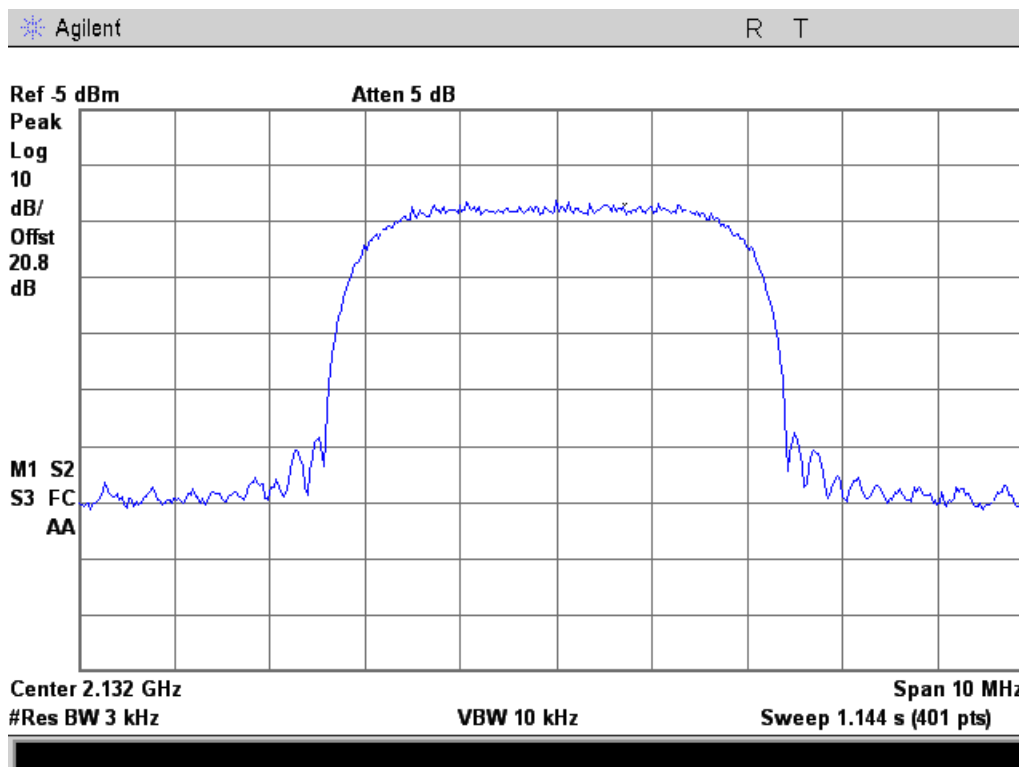



## Out of Band Rejection

**Name of Test:** Out of Band Rejection  
**Test Equipment Utilized:** i00266, i00331, i00348, i00347

**Engineer:** John Erhard  
**Test Date:** 9/27/2012

### Test Procedure

The EUT was connected to a spectrum analyzer through a 20 dB power attenuator. A signal generator was utilized to produce a swept CW signal with the RF input level set to the level determined by the intermodulation testing requirements. The uplink and downlink filter response and bandwidth were measured. The marker table function of the spectrum analyzer was used to show the band edges and the 20 dB bandwidth of the pass band filter.

### Test Setup

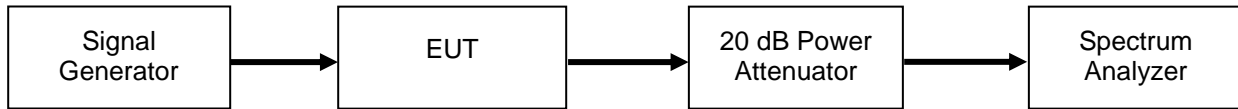



### Uplink Test Plots

#### 698 - 716 MHz Band

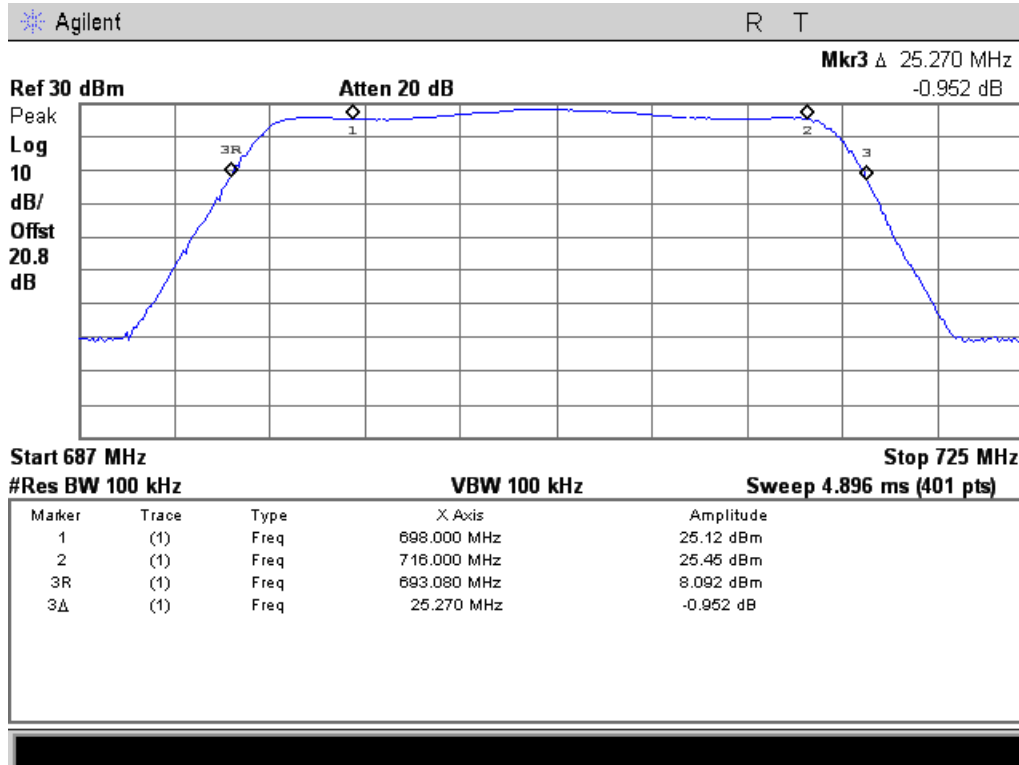

#### 776 - 787 MHz Band

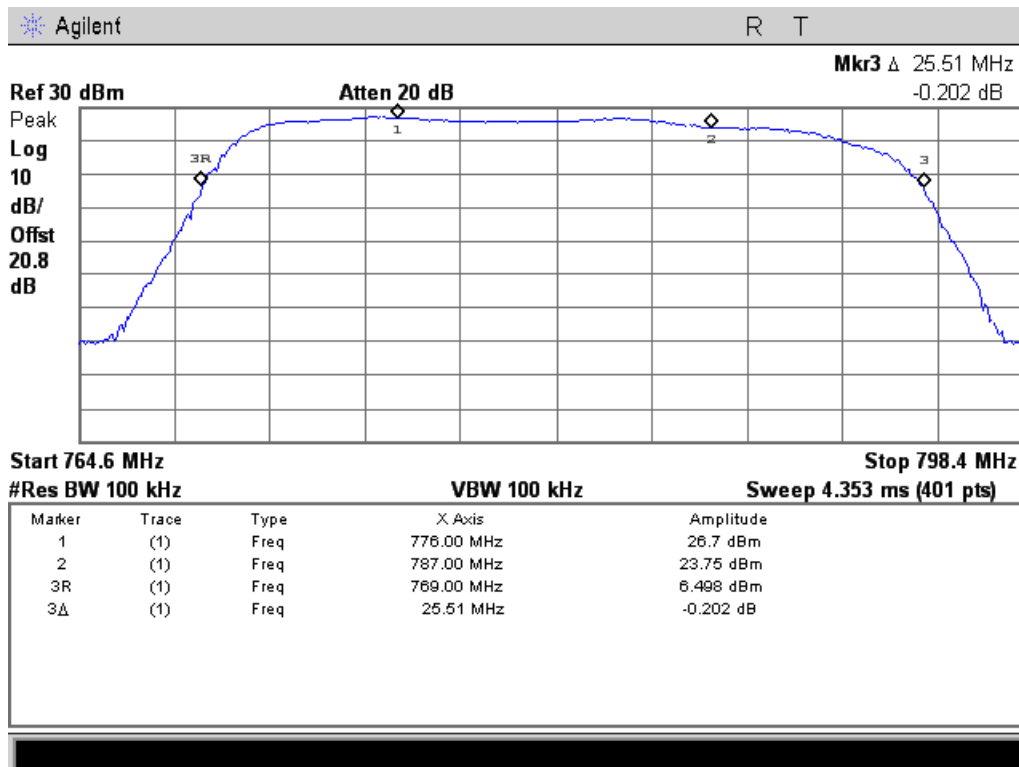



### 824 - 849 MHz Band

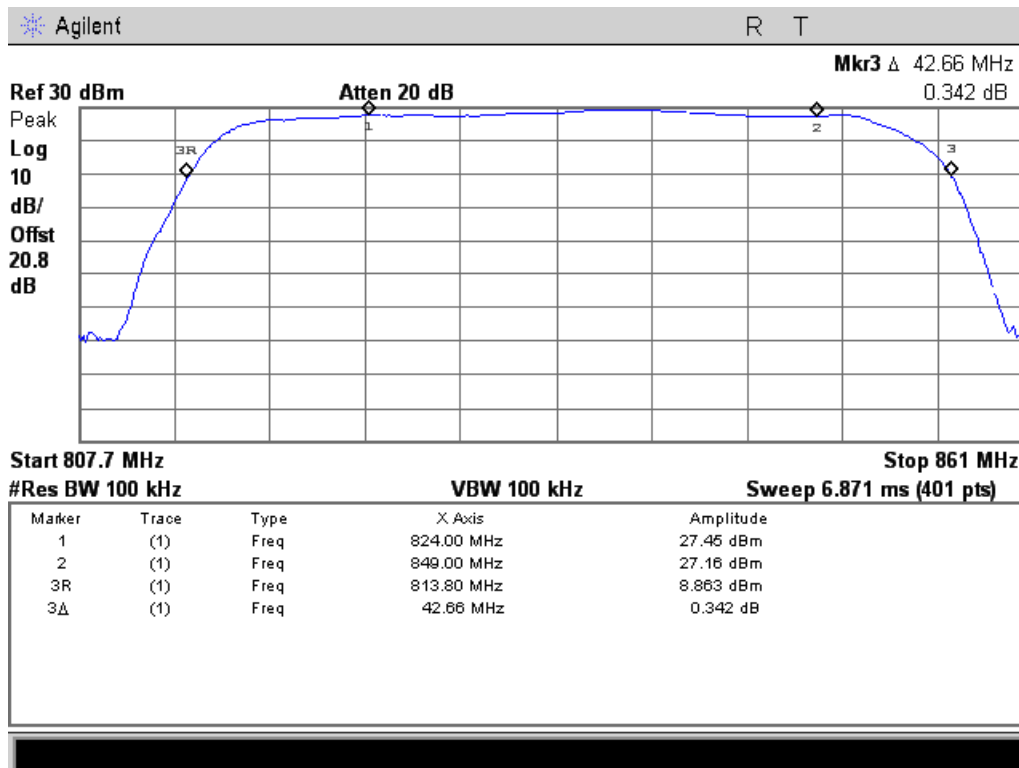

### 1710 - 1755 MHz Band

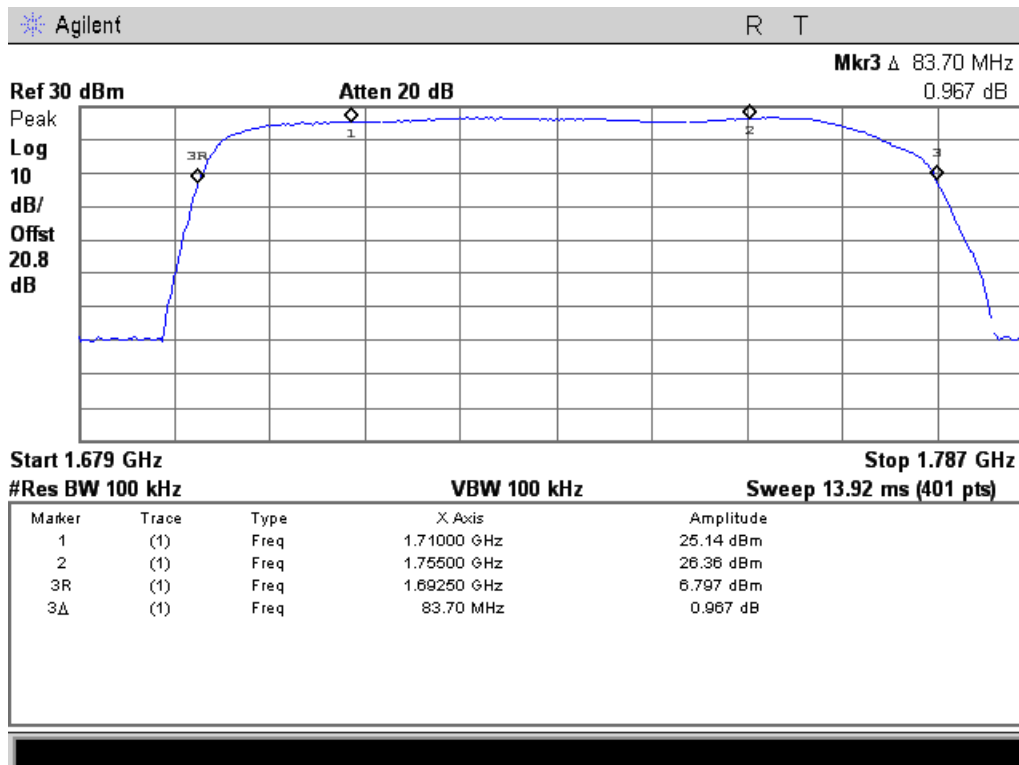



### 1850 - 1915 MHz Band

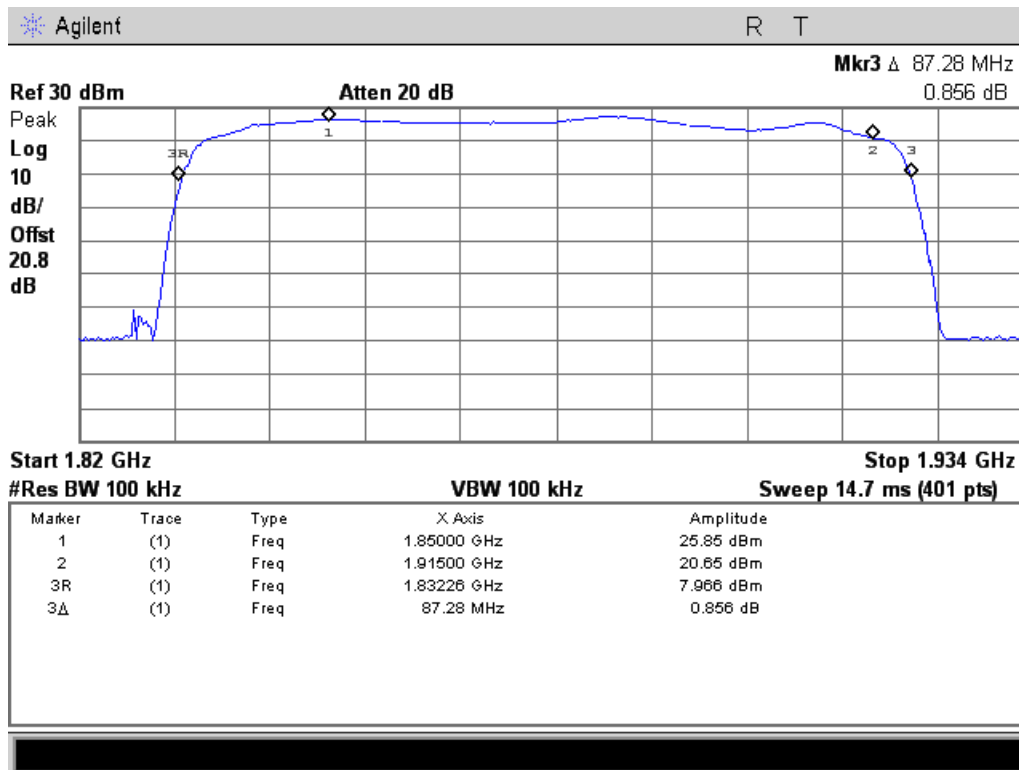

### Downlink Test Plots

### 728 - 746 MHz Band

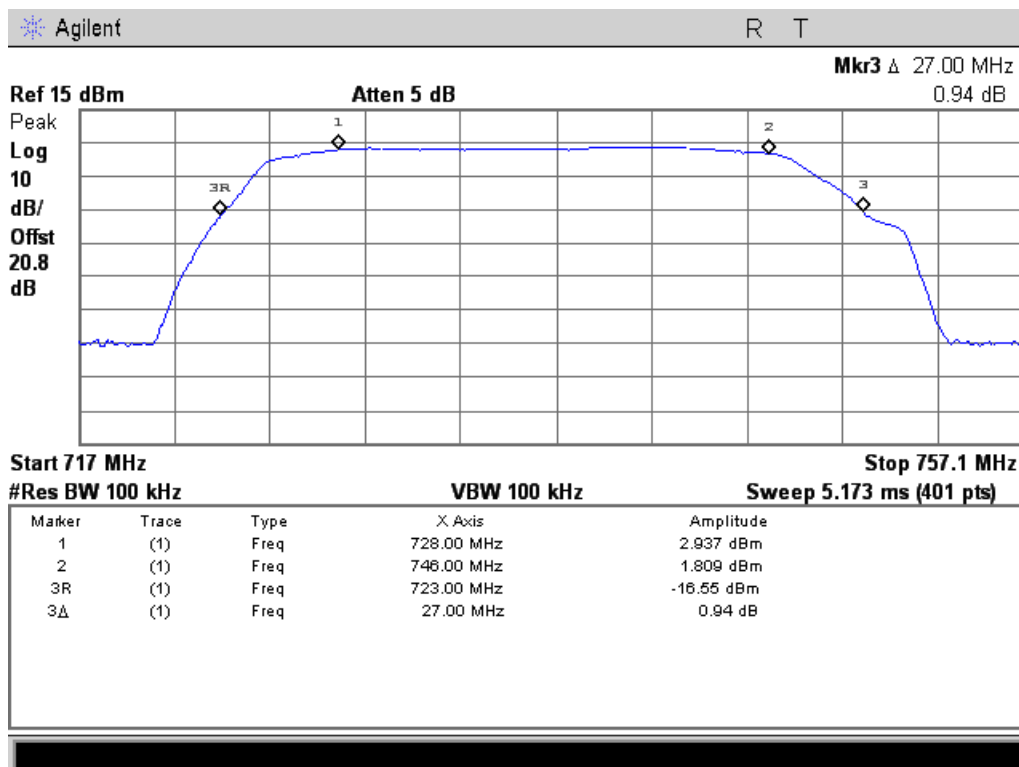



### 746 - 757 MHz Band

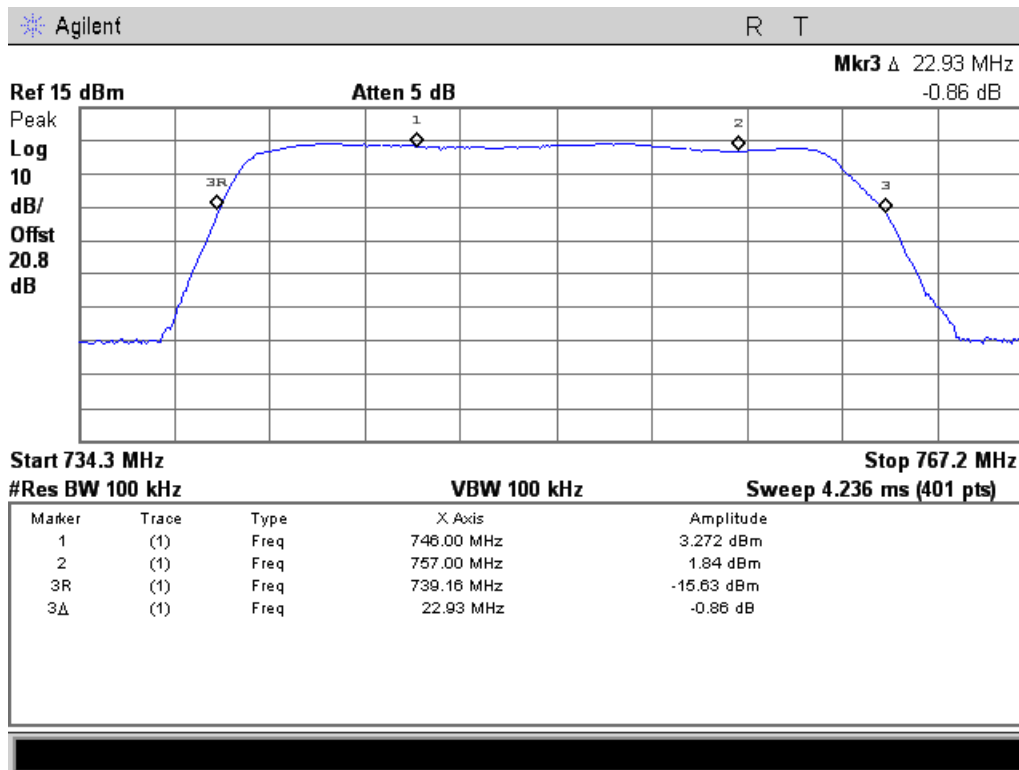

### 869 - 894 MHz Band

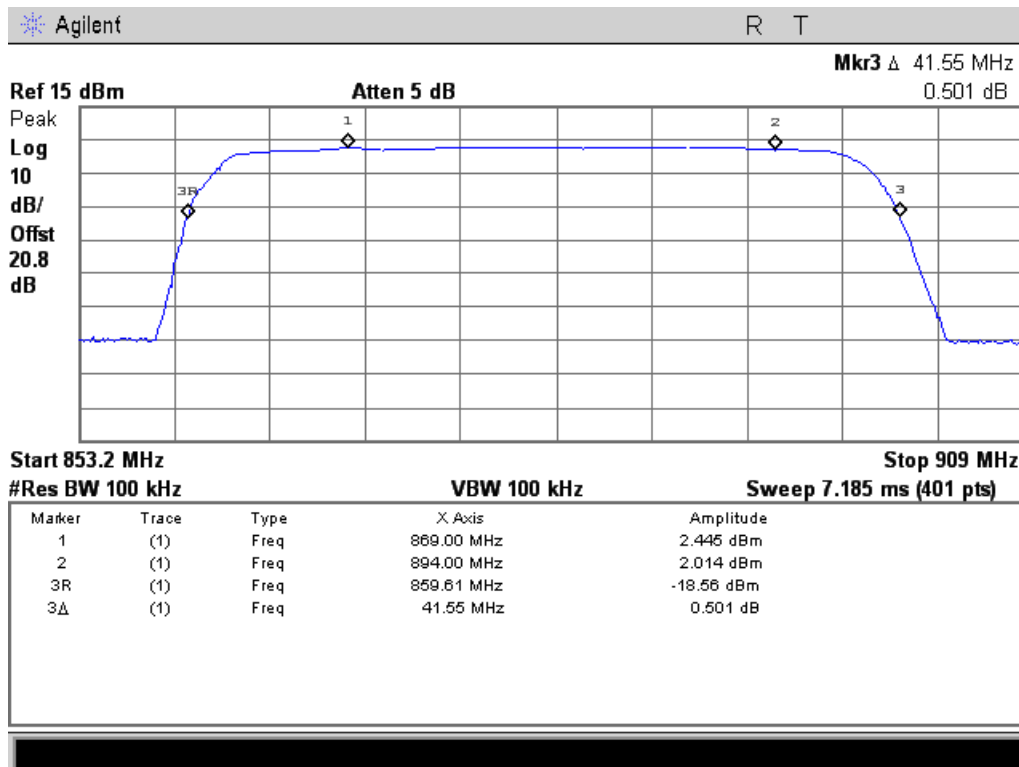





### 1930 - 1995 MHz Band

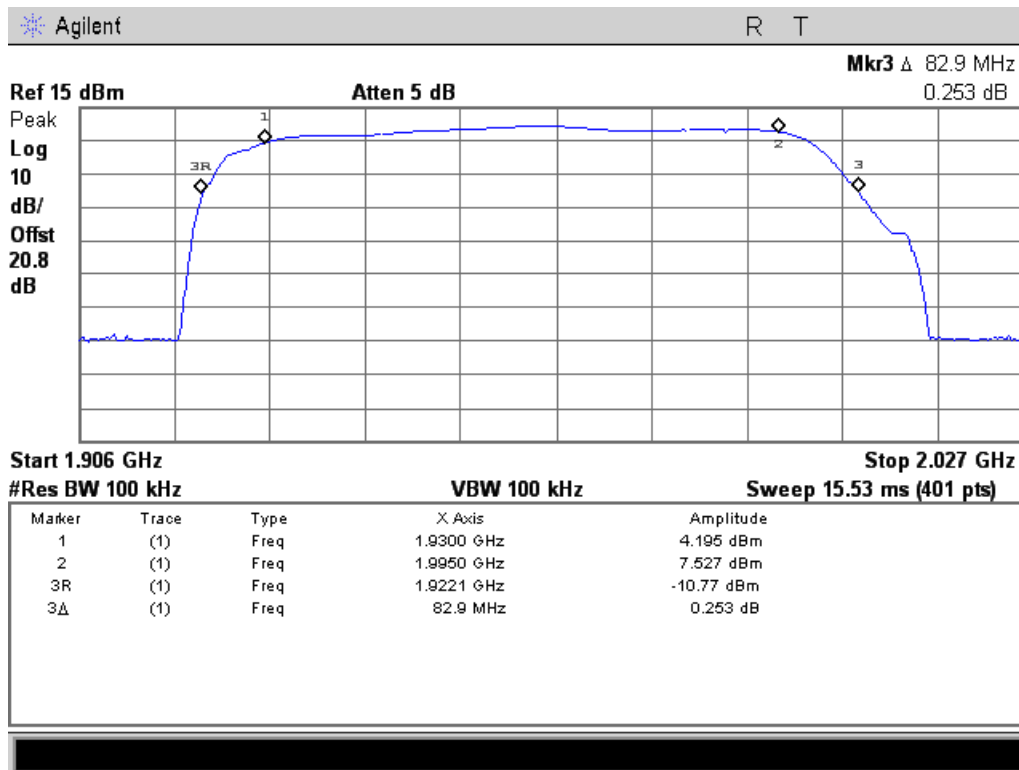

### 2110 - 2155 MHz Band

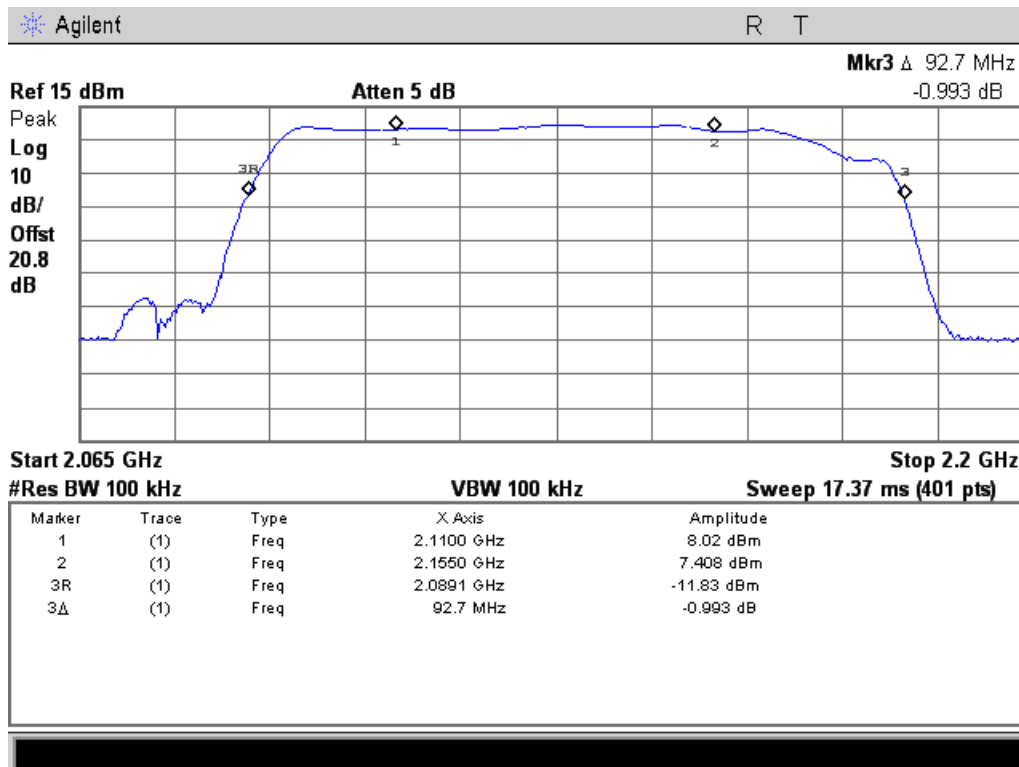



### Test Equipment Utilized

Description	Manufacturer	Model Number	CT Asset #	Last Cal Date	Cal Due Date
Horn Antenna	EMCO	3115	i00103	11/5/10	11/5/12
Signal Generator	Rohde & Schwarz	SMT-03	i00266	12/13/11	12/13/12
Humidity / Temp Meter	Newport	IBTHX-W-5	i00282	11/5/11	11/5/12
Spectrum Analyzer	Agilent	E4407B	i00331	4/20/12	4/20/13
Vector Signal Generator	Agilent	E4438C	i00348	9/27/11	9/27/12**
Humidity / Temp Meter	Control Company	4189CC	i00355	1/11/12	1/11/13
Power Attenuator	Narda	769-30	i00347	Verified on: 9/26/12	

\*\* 30-day calibration extension

In addition to the above listed equipment standard RF connectors and cables were utilized in the testing of the described equipment. Prior to testing these components were tested to verify proper operation.

END OF TEST REPORT