



# FCC/IC TEST REPORT (BLUETOOTH)

**REPORT NO.:** RF130906C26

**MODEL NO. FOR PAD:** MG101C1T\*\*\*\*\*(\*=0~9, A~Z, - or blank)

**MODEL NO. FOR DOCKING:** MG101C1D\*\*\*\*\*(\*=0~9, A~Z, - or blank)

**FCC ID:** PPD-QCWB335

**RECEIVED:** Sep. 06, 2013

**TESTED:** Sep. 16, 2013 ~ Sep. 17, 2013

**ISSUED:** Dec. 02, 2013

**APPLICANT:** Qualcomm Atheros, Inc.

**ADDRESS:** 1700 Technology Dr San Jose, CA 95110

**ISSUED BY:** Bureau Veritas Consumer Products Services (H.K.)  
Ltd., Taoyuan Branch

**LAB ADDRESS:** No. 47, 14th Ling, Chia Pau Vil., Lin Kou Dist., New  
Taipei City, Taiwan ( R.O.C )

**TEST LOCATION:** No. 19, Hwa Ya 2nd Rd, Wen Hwa Tsuen, Kwei  
Shan Hsiang, Taoyuan Hsien 333, Taiwan, R.O.C.

This report should not be used by the client to claim product certification, approval, or endorsement by TAF or any government agencies.



This report is for your exclusive use. Any copying or replication of this report to or for any other person or entity, or use of our name or trademark, is permitted only with our prior written permission. This report sets forth our findings solely with respect to the test samples identified herein. The results set forth in this report are not indicative or representative of the quality or characteristics of the lot from which a test sample was taken or any similar or identical product unless specifically and expressly noted. Our report includes all of the tests requested by you and the results thereof based upon the information that you provided to us. You have 60 days from date of issuance of this report to notify us of any material error or omission caused by our negligence, provided, however, that such notice shall be in writing and shall specifically address the issue you wish to raise. A failure to raise such issue within the prescribed time shall constitute your unqualified acceptance of the completeness of this report, the tests conducted and the correctness of the report contents. Unless specific mention, the uncertainty of measurement has been explicitly taken into account to declare the compliance or non-compliance to the specification

# Table of Contents

RELEASE CONTROL RECORD.....	4
1. CERTIFICATION.....	5
2. SUMMARY OF TEST RESULTS.....	6
2.1 MEASUREMENT UNCERTAINTY.....	7
3. GENERAL INFORMATION.....	8
3.1 GENERAL DESCRIPTION OF EUT.....	8
3.2 DESCRIPTION OF TEST MODES.....	10
3.2.1 TEST MODE APPLICABILITY AND TESTED CHANNEL DETAIL.....	<b>11</b>
3.3 GENERAL DESCRIPTION OF APPLIED STANDARDS.....	13
3.4 DESCRIPTION OF SUPPORT UNITS.....	13
3.4.1 CONFIGURATION OF SYSTEM UNDER TEST.....	<b>13</b>
4. TEST TYPES AND RESULTS (FOR Bluetooth EDR).....	14
4.1 Radiated Emission AND BANDEDGE Measurement.....	14
4.1.1 LIMITS OF RADIATED EMISSION AND BANDEDGE MEASUREMENT ...	<b>14</b>
4.1.2 TEST INSTRUMENTS.....	<b>15</b>
4.1.3 TEST PROCEDURES.....	<b>16</b>
4.1.4 DEVIATION FROM TEST STANDARD.....	<b>16</b>
4.1.5 TEST SETUP.....	<b>17</b>
4.1.6 EUT OPERATING CONDITIONS.....	<b>18</b>
4.1.7 TEST RESULTS.....	<b>19</b>
4.2 CONDUCTED EMISSION MEASUREMENT.....	21
4.2.1 LIMITS OF CONDUCTED EMISSION MEASUREMENT.....	<b>21</b>
4.2.2 TEST INSTRUMENTS.....	<b>21</b>
4.2.3 TEST PROCEDURES.....	<b>22</b>
4.2.4 DEVIATION FROM TEST STANDARD.....	<b>22</b>
4.2.5 TEST SETUP.....	<b>23</b>
4.2.6 EUT OPERATING CONDITIONS.....	<b>23</b>
4.2.7 TEST RESULTS.....	<b>24</b>
5. TEST TYPES AND RESULTS (FOR Bluetooth LE 4.0).....	26
5.1 RADIATED EMISSION AND BANDEDGE MEASUREMENT.....	26
5.1.1 LIMITS OF RADIATED EMISSION AND BANDEDGE MEASUREMENT ...	<b>26</b>
5.1.2 TEST INSTRUMENTS.....	<b>26</b>
5.1.3 TEST PROCEDURES.....	<b>27</b>
5.1.4 DEVIATION FROM TEST STANDARD.....	<b>27</b>
5.1.5 TEST SETUP.....	<b>28</b>
5.1.6 EUT OPERATING CONDITIONS.....	<b>29</b>
5.1.7 TEST RESULTS.....	<b>30</b>



**A D T**

5.2	CONDUCTED EMISSION MEASUREMENT .....	32
5.2.1	LIMITS OF CONDUCTED EMISSION MEASUREMENT .....	32
5.2.2	TEST INSTRUMENTS.....	32
5.2.3	TEST PROCEDURES .....	32
5.2.4	DEVIATION FROM TEST STANDARD.....	32
5.2.5	TEST SETUP.....	32
5.2.6	EUT OPERATING CONDITIONS .....	32
5.2.7	TEST RESULTS .....	33
6.	PHOTOGRAPHS OF THE TEST CONFIGURATION.....	35
7.	INFORMATION ON THE TESTING LABORATORIES.....	36
8.	APPENDIX A - MODIFICATIONS RECORDERS FOR ENGINEERING CHANGES TO THE EUT BY THE LAB .....	37



## RELEASE CONTROL RECORD

ISSUE NO.	REASON FOR CHANGE	DATE ISSUED
RF130906C26	Original release	Dec. 02, 2013



## 1. CERTIFICATION

**PRODUCT:** Tablet and Docking

**MODEL NO. FOR PAD:** MG101C1T\*\*\*\*\*(\*=0~9, A~Z, - or blank)

**MODEL NO. FOR DOCKING:** MG101C1D\*\*\*\*\*(\*=0~9, A~Z, - or blank)

**BRAND:** JP Sa Couto, SA

**APPLICANT:** Qualcomm Atheros, Inc.

**TESTED:** Sep. 16, 2013 ~ Sep. 17, 2013

**TEST SAMPLE:** Identical Prototype

**STANDARDS:** **FCC Part 15, Subpart C (Section 15.247)**

ANSI C63.10-2009

**Canada RSS-210 Issue 8 (2010-12)**

**Canada RSS-Gen Issue 3 (2010-12)**

The above equipment has been tested by **Bureau Veritas Consumer Products Services (H.K.) Ltd., Taoyuan Branch**, and found compliance with the requirement of the above standards. The test record, data evaluation & Equipment Under Test (EUT) configurations represented herein are true and accurate accounts of the measurements of the sample's EMC characteristics under the conditions specified in this report.

**PREPARED BY** : Vera Huang , **DATE** : Dec. 02, 2013

Vera Huang / Specialist

**APPROVED BY** : Sam chen , **DATE** : Dec. 02, 2013

Sam Chen / Assistant Manager

## 2. SUMMARY OF TEST RESULTS

The EUT has been tested according to the following specifications:

<b>(Bluetooth EDR) APPLIED STANDARD: FCC Part 15, Subpart C RSS-210; RSS-Gen</b>				
<b>STANDARD SECTION</b>		<b>TEST TYPE AND LIMIT</b>	<b>RESULT</b>	<b>REMARK</b>
<b>FCC Part 15, Subpart C</b>	<b>RSS-210; RSS-Gen</b>			
15.207	7.2.4	AC Power Conducted Emission	PASS	Meet the requirement of limit. Minimum passing margin is -13.73dB at 0.18906MHz.
15.247(a)(1) (iii)	A8.1 (d)	Number of Hopping Frequency Used	N/A	Refer to NOTE2 as below.
15.247(a)(1) (iii)	A8.1 (d)	Dwell Time on Each Channel	N/A	Refer to NOTE2 as below.
15.247(a)(1)	A8.1 (b)	1. Hopping Channel Separation 2. Spectrum Bandwidth of a Frequency Hopping Sequence Spread Spectrum System	N/A	Refer to NOTE2 as below.
15.247(b)	A8.4 (2)	Maximum Peak Output Power	N/A	Refer to NOTE2 as below.
15.247(d)	A8.5	Transmitter Radiated Emissions	PASS	Meet the requirement of limit. Minimum passing margin is -6.4dB at 43.23MHz.
15.247(d)	A8.5	Band Edge Measurement	N/A	Refer to NOTE2 as below.
15.203	-	Antenna Requirement	N/A	Refer to NOTE2 as below.

### NOTE:

1. If The Frequency Hopping System operating in 2400-2483.5MHz band and the output power less than 125mW. The hopping channel carrier frequencies separated by a minimum of 25kHz or two-thirds of the 20dB bandwidth of hopping channel whichever is greater.
2. Test items for radiated emission and conducted emission were performed for this report. Other testing data please refer to module (Brand: Qualcomm Atheros, Model: QCWB335, FCC ID: PPD- QCWB335, IC: 4104A- QCWB335) Report No.: FR240322A



<b>(Bluetooth LE 4.0) APPLIED STANDARD: FCC PART 15, SUBPART C (SECTION 15.247) RSS-210; RSS-Gen</b>				
<b>STANDARD SECTION</b>		<b>TEST TYPE AND LIMIT</b>	<b>RESULT</b>	<b>REMARK</b>
<b>FCC Part 15, Subpart C</b>	<b>RSS-210; RSS-Gen</b>			
15.207	RSS-Gen 7.2.4	AC Power Conducted Emission	PASS	Meet the requirement of limit. Minimum passing margin is -18.46dB at 0.19297MHz.
15.247(d) 15.209	RSS-210 A8.5	Radiated Emissions	PASS	Meet the requirement of limit. Minimum passing margin is -6.89dB at 43.23MHz.
15.247(d)	RSS-210 A8.5	Band Edge Measurement	N/A	Refer to NOTE as below.
15.247(a)(2)	RSS-210 A8.2 (a)	6dB bandwidth	N/A	Refer to NOTE as below.
15.247(b)	RSS-210 A8.4 (4)	Conducted power	N/A	Refer to NOTE as below.
15.247(e)	RSS-210 A8.2 (b)	Power Spectral Density	N/A	Refer to NOTE as below.
15.203	-	Antenna Requirement	N/A	Refer to NOTE as below.

**NOTE:** Test items for radiated emission and conducted emission were performed for this report. Other testing data please refer to module (Brand: Qualcomm Atheros, Model: QCWB335, FCC ID: PPD- QCWB335, IC: 4104A- QCWB335) Report No.: FR240322A

**2.1 MEASUREMENT UNCERTAINTY**

Where relevant, the following measurement uncertainty levels have been estimated for tests performed on the EUT as specified in CISPR 16-4-2:

<b>MEASUREMENT</b>	<b>FREQUENCY</b>	<b>UNCERTAINTY</b>
Conducted emissions	9kHz~30MHz	2.44 dB
Radiated emissions	30MHz ~ 200MHz	2.93 dB
	200MHz ~1000MHz	2.95 dB
	1GHz ~ 18GHz	2.26 dB
	18GHz ~ 40GHz	1.94 dB

This uncertainty represents an expanded uncertainty expressed at approximately the 95% confidence level using a coverage factor of k=2.

### 3. GENERAL INFORMATION

#### 3.1 GENERAL DESCRIPTION OF EUT

<b>EUT</b>	Tablet and Docking	
<b>MODEL NO. FOR PAD</b>	MG101C1T*****(*=0~9, A~Z, - or blank)	
<b>MODEL NO. FOR DOCKING</b>	MG101C1D*****(*=0~9, A~Z, - or blank)	
<b>POWER SUPPLY</b>	12Vdc (adapter or host equipment) 7.4Vdc (battery)	
<b>MODULATION TYPE</b>	<b>Bluetooth EDR</b>	GFSK, $\pi/4$ -DQPSK, 8DPSK
	<b>Bluetooth LE 4.0</b>	GFSK
<b>TRANSFER RATE</b>	<b>Bluetooth EDR</b>	1/2/3Mbps
	<b>Bluetooth LE 4.0</b>	1Mbps
<b>OPERATING FREQUENCY</b>	2402 ~ 2480MHz	
<b>NUMBER OF CHANNEL</b>	<b>Bluetooth EDR</b>	79
	<b>Bluetooth LE 4.0</b>	40
<b>CHANNEL SPACING</b>	<b>Bluetooth EDR</b>	1MHz
	<b>Bluetooth LE 4.0</b>	2MHz
<b>ANTENNA TYPE</b>	PIFA antenna with 1.25dBi gain	
<b>ANTENNA CONNECTOR</b>	NA	
<b>DATA CABLE</b>	Refer to Note as below	
<b>I/O PORTS</b>	Refer to user's manual	
<b>ACCESSORY DEVICES</b>	Refer to Note as below	



**NOTE:**

1. This report is prepared for FCC class II change permissive change. The transmitter module is authorized for use in specific End-product (Tablet and Docking / Brand: JP Sa Couto, SA / Model No. for Pad: MG101C1T\*\*\*\*(\*=0~9, A~Z, - or blank) / Model No. for Docking: MG101C1D\*\*\*\*(\*=0~9, A~Z, - or blank)). Thus, we re-test conducted emission and radiated emission tests.
2. The EUT contains following accessory devices.

ITEM	BRAND	MODEL	SPECIFICATION
AC Adapter	DELTA	ADP-18TB A	Input: 100-240Vac, 0.6A, 50-60Hz Output: 12Vdc, 1.5A
Battery 1	Welltech	J01	Rating: 7.4 Vdc, 4000mAh Type: Li-ion
Battery 2	SIMPLO	SQU-1310	Rating: 7.4 Vdc, 4000mAh Type: Li-ion
Docking	JP Sa Couto, SA	MG101C1D****(*=0~9, A~Z, - or blank)	--
Battery for Docking	SIMPLO	SQU-1311	Rating: 7.4 Vdc, 2260mAh Type: Li-ion
WLAN+BT Combo Module	Qualcomm Atheros	QCWB335	1T1R b/g/n + BT combo

\* Only Battery 1 was verified in this report.

3. The above EUT information is declared by the manufacturer and for more detailed features description, please refer to the manufacturer's specifications or User's Manual.

### 3.2 DESCRIPTION OF TEST MODES

#### For Bluetooth EDR:

79 channels are provided to this EUT:

CHANNEL	FREQ. (MHz)	CHANNEL	FREQ. (MHz)	CHANNEL	FREQ. (MHz)	CHANNEL	FREQ. (MHz)
0	2402	20	2422	40	2442	60	2462
1	2403	21	2423	41	2443	61	2463
2	2404	22	2424	42	2444	62	2464
3	2405	23	2425	43	2445	63	2465
4	2406	24	2426	44	2446	64	2466
5	2407	25	2427	45	2447	65	2467
6	2408	26	2428	46	2448	66	2468
7	2409	27	2429	47	2449	67	2469
8	2410	28	2430	48	2450	68	2470
9	2411	29	2431	49	2451	69	2471
10	2412	30	2432	50	2452	70	2472
11	2413	31	2433	51	2453	71	2473
12	2414	32	2434	52	2454	72	2474
13	2415	33	2435	53	2455	73	2475
14	2416	34	2436	54	2456	74	2476
15	2417	35	2437	55	2457	75	2477
16	2418	36	2438	56	2458	76	2478
17	2419	37	2439	57	2459	77	2479
18	2420	38	2440	58	2460	78	2480
19	2421	39	2441	59	2461		

#### For Bluetooth LE 4.0:

40 channels are provided to this EUT:

CHANNEL	FREQ. (MHz)	CHANNEL	FREQ. (MHz)	CHANNEL	FREQ. (MHz)	CHANNEL	FREQ. (MHz)
0	2402	10	2422	20	2442	30	2462
1	2404	11	2424	21	2444	31	2464
2	2406	12	2426	22	2446	32	2466
3	2408	13	2428	23	2448	33	2468
4	2410	14	2430	24	2450	34	2470
5	2412	15	2432	25	2452	35	2472
6	2414	16	2434	26	2454	36	2474
7	2416	17	2436	27	2456	37	2476
8	2418	18	2438	28	2458	38	2478
9	2420	19	2440	29	2460	39	2480

### 3.2.1 TEST MODE APPLICABILITY AND TESTED CHANNEL DETAIL

#### For Bluetooth EDR:

EUT CONFIGURE MODE	APPLICABLE TO			DESCRIPTION
	RE $\geq$ 1G	RE<1G	PLC	
-	√	√	√	-

Where **RE $\geq$ 1G**: Radiated Emission above 1GHz      **RE<1G**: Radiated Emission below 1GHz  
**PLC**: Power Line Conducted Emission

**NOTE:** The EUT had been pre-tested on the positioned of each 3 axis. The worst case was found when positioned on X-plane.

#### RADIATED EMISSION TEST (ABOVE 1 GHz):

- Pre-Scan has been conducted to determine the worst-case mode from all possible combinations between available modulations, antenna ports (if EUT with antenna diversity architecture) and packet type.
- Following channel(s) was (were) selected for the final test as listed below.

AVAILABLE CHANNEL	TESTED CHANNEL	MODULATION TYPE	PACKET TYPE
0 to 78	78	$\pi/4$ -DQPSK	DH5

#### RADIATED EMISSION TEST (BELOW 1 GHz):

- Pre-Scan has been conducted to determine the worst-case mode from all possible combinations between available modulations, antenna ports (if EUT with antenna diversity architecture) and packet type.
- Following channel(s) was (were) selected for the final test as listed below.

AVAILABLE CHANNEL	TESTED CHANNEL	MODULATION TYPE	PACKET TYPE
0 to 78	78	$\pi/4$ -DQPSK	DH5

#### POWER LINE CONDUCTED EMISSION TEST:

The EUT was tested with the following mode.

TEST CONDITION
BT Link + WLAN (2.4G) Link + Adapter + Earphone

#### TEST CONDITION:

APPLICABLE TO	ENVIRONMENTAL CONDITIONS	INPUT POWER	TESTED BY
RE $\geq$ 1G	25deg. C, 65%RH	120Vac, 60Hz	Anson Lin
RE<1G	25deg. C, 65%RH	120Vac, 60Hz	Anson Lin
PLC	25deg. C, 65%RH	120Vac, 60Hz	Johnson Liao

**FOR Bluetooth LE 4.0:**

EUT CONFIGURE MODE	APPLICABLE TO			DESCRIPTION
	RE $\geq$ 1G	RE<1G	PLC	
-	√	√	√	-

Where **RE $\geq$ 1G**: Radiated Emission above 1GHz      **RE<1G**: Radiated Emission below 1GHz  
**PLC**: Power Line Conducted Emission

**NOTE:** The EUT had been pre-tested on the positioned of each 3 axis. The worst case was found when positioned on **X-plane**.

**RADIATED EMISSION TEST (ABOVE 1GHz):**

- Pre-Scan has been conducted to determine the worst-case mode from all possible combinations between available modulations and antenna ports (if EUT with antenna diversity architecture).
- Following channel(s) was (were) selected for the final test as listed below.

AVAILABLE CHANNEL	TESTED CHANNEL	MODULATION TYPE	DATA RATE (Mbps)
0 to 39	39	GFSK	1.0

**RADIATED EMISSION TEST (BELOW 1GHz):**

- Pre-Scan has been conducted to determine the worst-case mode from all possible combinations between available modulations and antenna ports (if EUT with antenna diversity architecture).
- Following channel(s) was (were) selected for the final test as listed below.

AVAILABLE CHANNEL	TESTED CHANNEL	MODULATION TYPE	DATA RATE (Mbps)
0 to 39	39	GFSK	1.0

**POWER LINE CONDUCTED EMISSION TEST:**

The EUT was tested with the following mode.

TEST CONDITION
BT LE TX + WLAN (2.4G) Link + Adapter + Earphone

**TEST CONDITION:**

APPLICABLE TO	ENVIRONMENTAL CONDITIONS	INPUT POWER	TESTED BY
RE $\geq$ 1G	25deg. C, 65%RH	120Vac, 60Hz	Anson Lin
RE<1G	25deg. C, 65%RH	120Vac, 60Hz	Anson Lin
PLC	25deg. C, 65%RH	120Vac, 60Hz	Johnson Liao

### 3.3 GENERAL DESCRIPTION OF APPLIED STANDARDS

The EUT is a RF Product. According to the specifications of the manufacturer, it must comply with the requirements of the following standards:

**FCC Part 15, Subpart C (15.247)**

**ANSI C63.10-2009**

**558074 D01 DTS Meas Guidance v03r01**

**FCC Public Notice DA 00-705**

**Canada RSS-210 Issue 8 (2010-12)**

**Canada RSS-Gen Issue 3 (2010-12)**

All test items have been performed and recorded as per the above standards.

### 3.4 DESCRIPTION OF SUPPORT UNITS

The EUT has been tested as an independent unit together with other necessary accessories or support units.

#### 3.4.1 CONFIGURATION OF SYSTEM UNDER TEST

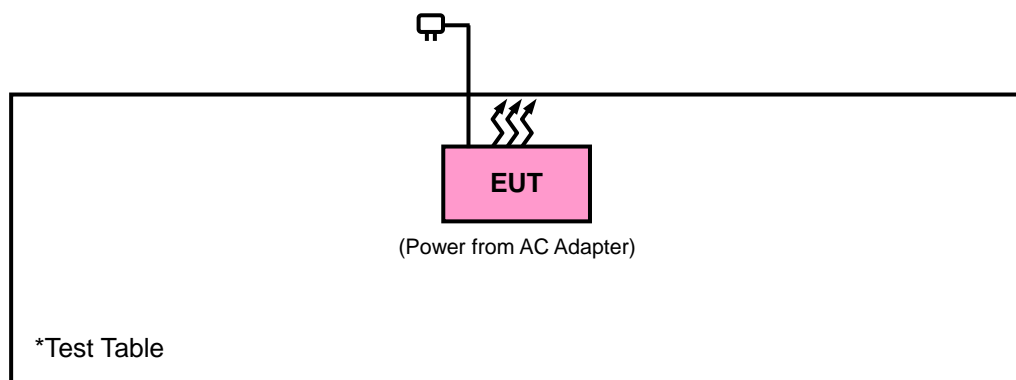

## 4. TEST TYPES AND RESULTS (FOR Bluetooth EDR)

### 4.1 RADIATED EMISSION AND BANDEDGE MEASUREMENT

#### 4.1.1 LIMITS OF RADIATED EMISSION AND BANDEDGE MEASUREMENT

Radiated emissions which fall in the restricted bands must comply with the radiated emission limits specified as below table. Other emissions shall be at least 20dB below the highest level of the desired power:

FREQUENCIES (MHz)	FIELD STRENGTH (microvolts/meter)	MEASUREMENT DISTANCE (meters)
0.009 ~ 0.490	2400/F(kHz)	300
0.490 ~ 1.705	24000/F(kHz)	30
1.705 ~ 30.0	30	30
30 ~ 88	100	3
88 ~ 216	150	3
216 ~ 960	200	3
Above 960	500	3

**NOTE:**

1. The lower limit shall apply at the transition frequencies.
2. Emission level (dBuV/m) = 20 log Emission level (uV/m).
3. For frequencies above 1000MHz, the field strength limits are based on average detector, however, the peak field strength of any emission shall not exceed the maximum permitted average limits, specified above by more than 20dB under any condition of modulation.

#### 4.1.2 TEST INSTRUMENTS

DESCRIPTION & MANUFACTURER	MODEL NO.	SERIAL NO.	DATE OF CALIBRATION	DUE DATE OF CALIBRATION
Test Receiver ROHDE & SCHWARZ	ESCI	100744	Apr. 15, 2013	Apr. 14, 2014
Spectrum Analyzer ROHDE & SCHWARZ	FSU43	101261	Dec. 17, 2012	Dec. 16, 2013
BILOG Antenna SCHWARZBECK	VULB9168	9168-472	Mar. 25, 2013	Mar. 24, 2014
HORN Antenna SCHWARZBECK	BBHA 9120 D	9120D-969	Jan. 07, 2013	Jan. 06, 2014
HORN Antenna SCHWARZBECK	BBHA 9170	9170-480	Dec. 25, 2012	Dec. 24, 2013
Loop Antenna	HFH2-Z2	100070	Jan. 31, 2012	Jan. 30, 2014
Preamplifier EMCI	EMC 012645	980115	Dec. 28, 2012	Dec. 27, 2013
Preamplifier EMCI	EMC 184045	980116	Dec. 28, 2012	Dec. 27, 2013
Preamplifier EMCI	EMC 330H	980112	Dec. 28, 2012	Dec. 27, 2013
RF signal cable HUBER+SUHNNER	SUCOFLEX 104	309219/4	Oct. 19, 2012	Oct. 18, 2013
RF signal cable HUBER+SUHNNER	SUCOFLEX 104	250130/4	Oct. 19, 2012	Oct. 18, 2013
RF signal cable Worken	RG-213	NA	Dec. 29, 2012	Dec. 28, 2013
Software BV ADT	E3 6.120103	NA	NA	NA
Antenna Tower MF	MFA-440H	NA	NA	NA
Turn Table MF	MFT-201SS	NA	NA	NA
Antenna Tower & Turn Table Controller MF	MF-7802	NA	NA	NA
Bluetooth Tester	CBT	100870	Jan. 29, 2013	Jan. 28, 2014
Power Meter	ML2488B	1141007	Jan. 09, 2013	Jan. 08, 2014
Power Sensor	E9321A	MY51200002	May 22, 2013	May 21, 2014

- NOTE:**
1. The calibration interval of the above test instruments is 12 months and the calibrations are traceable to NML/ROC and NIST/USA.
  2. The calibration interval of the loop antenna is 24 months and the calibrations are traceable to NML/ROC and NIST/USA.
  3. The test was performed in HwaYa Chamber 10.
  4. The horn antenna and HP preamplifier (model: 8449B) are used only for the measurement of emission frequency above 1GHz if tested.
  5. The FCC Site Registration No. is 690701.
  6. The IC Site Registration No. is IC 7450F-10.

#### 4.1.3 TEST PROCEDURES

- a. The EUT was placed on the top of a rotating table 0.8 meters above the ground at a 3 meter semi-anechoic chamber. The table was rotated 360 degrees to determine the position of the highest radiation.
- b. The EUT was set 3 meters away from the interference-receiving antenna, which was mounted on the top of a variable-height antenna tower.
- c. The antenna is a broadband antenna, and its height is varied from one meter to four meters above the ground to determine the maximum value of the field strength. Both horizontal and vertical polarizations of the antenna are set to make the measurement.
- d. For each suspected emission, the EUT was arranged to its worst case and then the antenna was tuned to heights from 1 meter to 4 meters and the rotatable table was turned from 0 degrees to 360 degrees to find the maximum reading.
- e. The test-receiver system was set to Peak Detect Function and Specified Bandwidth with Maximum Hold Mode.
- f. If the emission level of the EUT in peak mode was lower than the limit specified, then testing could be stopped and the peak values of the EUT would be reported. Otherwise the emissions would be re-tested one by one using peak, quasi-peak or average method as specified and then reported in a data sheet.

**NOTE:**

1. The resolution bandwidth and video bandwidth of test receiver/spectrum analyzer is 120kHz for Quasi-peak detection at frequency below 1GHz.
2. The resolution bandwidth of test receiver/spectrum analyzer is 1MHz and video bandwidth is 3MHz for Peak detection at frequency above 1GHz.
3. The resolution bandwidth of test receiver/spectrum analyzer is 1MHz and the video bandwidth is 10Hz for Average detection (AV) at frequency above 1GHz.
4. All modes of operation were investigated and the worst-case emissions are reported.

#### 4.1.4 DEVIATION FROM TEST STANDARD

No deviation.



### 4.1.5 TEST SETUP

#### Frequency Range 30MHz ~ 1GHz

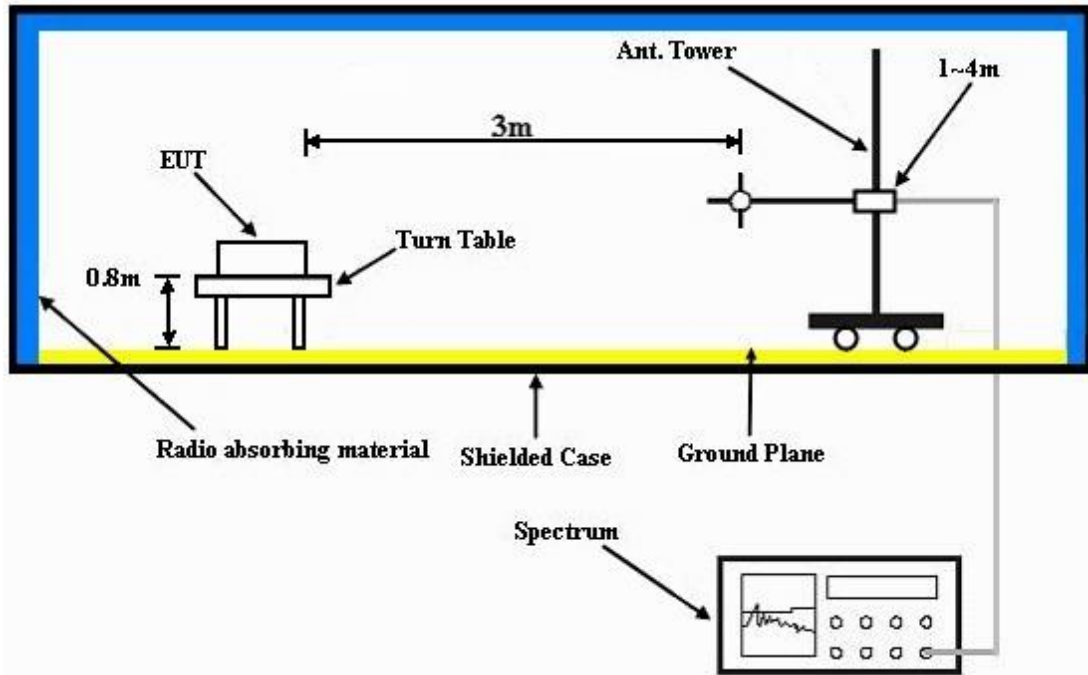

#### Frequency Range above 1GHz

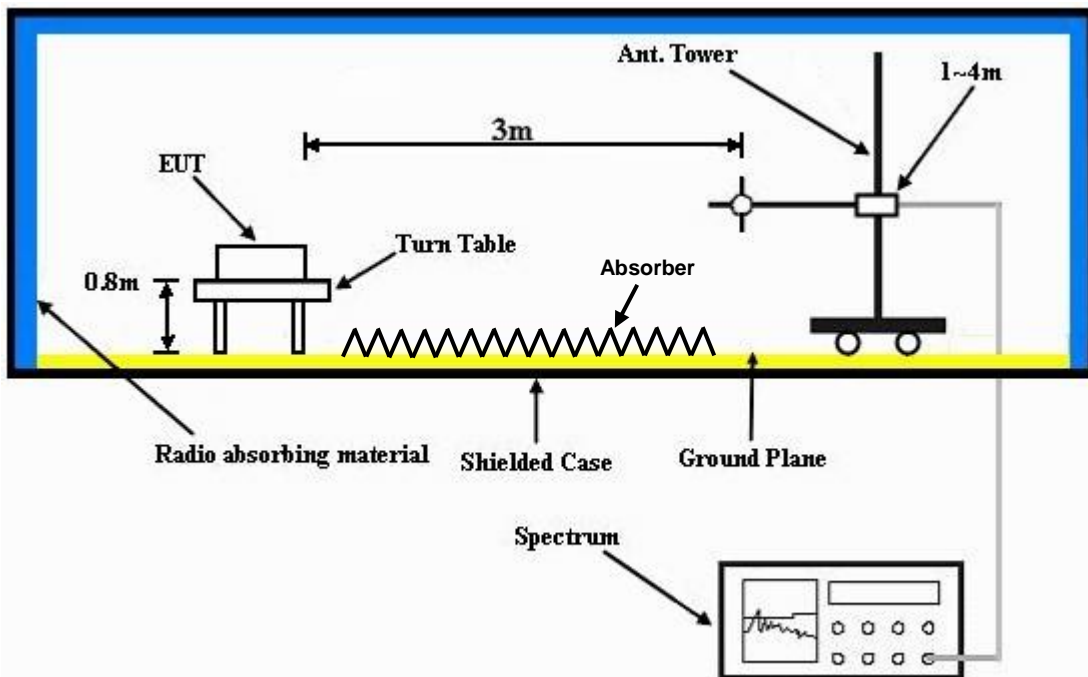

For the actual test configuration, please refer to the attached file (Test Setup Photo).

#### 4.1.6 EUT OPERATING CONDITIONS

- a. Placed the EUT on a testing table.
- b. Use the software to control the EUT under transmission condition continuously at specific channel frequency.



A D T

### 4.1.7 TEST RESULTS

#### ABOVE 1GHz WORST-CASE DATA : $\pi/4$ -DQPSK

EUT TEST CONDITION		MEASUREMENT DETAIL	
CHANNEL	Channel 78	FREQUENCY RANGE	1GHz ~ 25GHz
INPUT POWER (SYSTEM)	120Vac, 60 Hz	DETECTOR FUNCTION	Peak (PK) Average (AV)
ENVIRONMENTAL CONDITIONS	25deg. C, 65%RH	TESTED BY	Anson Lin

ANTENNA POLARITY & TEST DISTANCE: HORIZONTAL AT 3 M										
FREQ. (MHz)	EMISSION LEVEL (dBuV/m)	READ LEVEL (dBuV)	LIMIT (dBuV/m)	MARGIN (dB)	ANTENNA FACTOR (dB/m)	CABLE LOSS (dB)	PREAMP FACTOR (dB)	ANTENNA HEIGHT (cm)	TABLE ANGLE (Degree)	REMARK
2384	35.76	42.88	54	-18.24	26.86	3.52	37.5	100	230	Average
2384	47.52	54.64	74	-26.48	26.86	3.52	37.5	100	230	Peak
2480	86.12	92.69			27.15	3.6	37.32	100	230	Average
2480	101.08	107.65			27.15	3.6	37.32	100	230	Peak
2484	35.52	42.09	54	-18.48	27.15	3.6	37.32	100	230	Average
2484	55.57	62.14	74	-18.43	27.15	3.6	37.32	100	230	Peak
ANTENNA POLARITY & TEST DISTANCE: VERTICAL AT 3 M										
FREQ. (MHz)	EMISSION LEVEL (dBuV/m)	READ LEVEL (dBuV)	LIMIT (dBuV/m)	MARGIN (dB)	ANTENNA FACTOR (dB/m)	CABLE LOSS (dB)	PREAMP FACTOR (dB)	ANTENNA HEIGHT (cm)	TABLE ANGLE (Degree)	REMARK
2366	33.17	40.34	54	-20.83	26.81	3.52	37.5	102	278	Average
2366	47.45	54.62	74	-26.55	26.81	3.52	37.5	102	278	Peak
2480	80.09	86.66			27.15	3.6	37.32	102	278	Average
2480	93.45	100.02			27.15	3.6	37.32	102	278	Peak
2484	33.5	40.07	54	-20.5	27.15	3.6	37.32	102	278	Average
2484	50.02	56.59	74	-23.98	27.15	3.6	37.32	102	278	Peak

#### REMARKS:

- 2480MHz: Fundamental frequency.
- Emission Level = Read Level + Antenna Factor + Cable Loss - Preamp Factor



**BELOW 1GHz WORST-CASE DATA :  $\pi/4$ -DQPSK**

EUT TEST CONDITION		MEASUREMENT DETAIL	
CHANNEL	Channel 78	FREQUENCY RANGE	30MHz ~ 1GHz
INPUT POWER (SYSTEM)	120Vac, 60 Hz	DETECTOR FUNCTION	Peak (PK) Quasi-peak (QP)
ENVIRONMENTAL CONDITIONS	25deg. C, 65%RH	TESTED BY	Anson Lin

ANTENNA POLARITY & TEST DISTANCE: HORIZONTAL AT 3 M										
FREQ. (MHz)	EMISSION LEVEL (dBuV/m)	READ LEVEL (dBuV)	LIMIT (dBuV/m)	MARGIN (dB)	ANTENNA FACTOR (dB/m)	CABLE LOSS (dB)	PREAMP FACTOR (dB)	ANTENNA HEIGHT (cm)	TABLE ANGLE (Degree)	REMARK
43.23	33.6	50.41	40	-6.4	13.59	0.71	31.11	100	335	Peak
140.16	28.02	45.99	43.5	-15.48	12.37	1.3	31.64	102	137	Peak
226.56	31.42	51.01	46	-14.58	10.5	1.73	31.82	100	316	Peak
414.8	35.94	49.84	46	-10.06	15.64	2.48	32.02	100	147	Peak
600.3	32.75	42.3	46	-13.25	19.61	3.09	32.25	104	286	Peak
750.1	37.26	43.47	46	-8.74	21.52	3.57	31.3	100	87	Peak
ANTENNA POLARITY & TEST DISTANCE: VERTICAL AT 3 M										
FREQ. (MHz)	EMISSION LEVEL (dBuV/m)	READ LEVEL (dBuV)	LIMIT (dBuV/m)	MARGIN (dB)	ANTENNA FACTOR (dB/m)	CABLE LOSS (dB)	PREAMP FACTOR (dB)	ANTENNA HEIGHT (cm)	TABLE ANGLE (Degree)	REMARK
43.77	33.2	50.01	40	-6.8	13.59	0.71	31.11	100	250	Peak
139.08	25.35	43.45	43.5	-18.15	12.27	1.29	31.66	100	97	Peak
231.69	28.68	48.06	46	-17.32	10.71	1.75	31.84	100	26	Peak
452.6	33.81	46.77	46	-12.19	16.39	2.63	31.98	100	104	Peak
538	32.68	43.3	46	-13.32	18.19	2.91	31.72	100	230	Peak
792.1	30.33	35.94	46	-15.67	22.12	3.68	31.41	100	149	Peak

**REMARKS:**

- Emission Level = Read Level + Antenna Factor + Cable Loss - Preamp Factor

## 4.2 CONDUCTED EMISSION MEASUREMENT

### 4.2.1 LIMITS OF CONDUCTED EMISSION MEASUREMENT

FREQUENCY OF EMISSION (MHz)	CONDUCTED LIMIT (dB $\mu$ V)	
	Quasi-peak	Average
0.15 ~ 0.5	66 to 56	56 to 46
0.5 ~ 5	56	46
5 ~ 30	60	50

- NOTE:**
1. The lower limit shall apply at the transition frequencies.
  2. The limit decreases in line with the logarithm of the frequency in the range of 0.15 to 0.50 MHz.
  3. All emanations from a class A/B digital device or system, including any network of conductors and apparatus connected thereto, shall not exceed the level of field strengths specified above.

### 4.2.2 TEST INSTRUMENTS

DESCRIPTION & MANUFACTURER	MODEL NO.	SERIAL NO.	DATE OF CALIBRATION	DUE DATE OF CALIBRATION
Test Receiver ROHDE & SCHWARZ	ESCS30	100288	Nov. 09, 2012	Nov. 08, 2013
RF signal cable Woken	5D-FB	Cable-HYCO2-01	Dec. 28, 2012	Dec. 27, 2013
LISN ROHDE & SCHWARZ (EUT)	ESH2-Z5	100100	Dec. 21, 2012	Dec. 20, 2013
LISN ROHDE & SCHWARZ (Peripheral)	ESH3-Z5	100312	Jul. 02, 2013	Jul. 01, 2014
Software ADT	BV ADT_Cond_ V7.3.7.3	NA	NA	NA

- NOTE:**
1. The calibration interval of the above test instruments is 12 months and the calibrations are traceable to NML/ROC and NIST/USA.
  2. The test was performed in HwaYa Shielded Room 2.
  3. The VCCI Site Registration No. is C-2047.

### 4.2.3 TEST PROCEDURES

- a. The EUT was placed 0.4 meters from the conducting wall of the shielded room with EUT being connected to the power mains through a line impedance stabilization network (LISN). Other support units were connected to the power mains through another LISN. The two LISNs provide 50 ohm/ 50uH of coupling impedance for the measuring instrument.
- b. Both lines of the power mains connected to the EUT were checked for maximum conducted interference.
- c. The frequency range from 150kHz to 30MHz was searched. Emission levels under (Limit - 20dB) was not recorded.

**NOTE:** All modes of operation were investigated and the worst-case emissions are reported.

### 4.2.4 DEVIATION FROM TEST STANDARD

No deviation.

#### 4.2.5 TEST SETUP

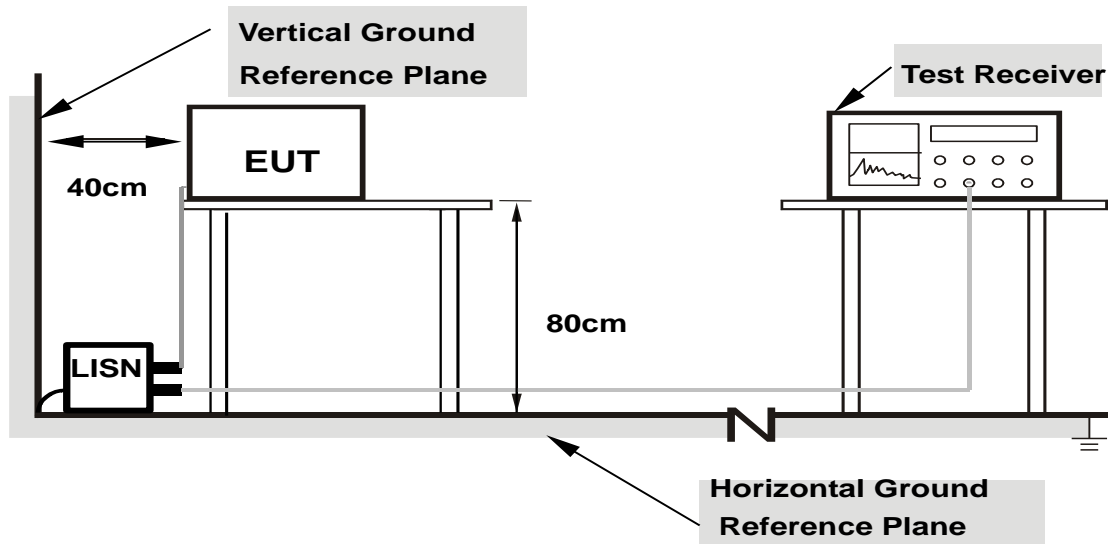

- Note:**
1. Support units were connected to second LISN.
  2. Both of LISNs (AMN) are 80 cm from EUT and at least 80 from other units and other metal planes

For the actual test configuration, please refer to the attached file (Test Setup Photo).

#### 4.2.6 EUT OPERATING CONDITIONS

Same as 4.1.6.

### 4.2.7 TEST RESULTS

**CONDUCTED WORST CASE DATA:  $\pi/4$ -DQPSK**

<b>PHASE</b>	Line 1	<b>6dB BANDWIDTH</b>	9kHz
--------------	--------	----------------------	------

No	Freq. [MHz]	Corr. Factor (dB)	Reading Value [dB (uV)]		Emission Level [dB (uV)]		Limit [dB (uV)]		Margin (dB)	
			Q.P.	AV.	Q.P.	AV.	Q.P.	AV.	Q.P.	AV.
			1	0.18906	0.17	50.18	34.98	50.35	35.15	64.08
2	0.39219	0.21	30.86	17.87	31.07	18.08	58.02	48.02	-26.95	-29.94
3	0.93125	0.26	26.44	13.38	26.70	13.64	56.00	46.00	-29.30	-32.36
4	3.43750	0.34	35.50	26.05	35.84	26.39	56.00	46.00	-20.16	-19.61
5	6.67578	0.40	32.52	26.10	32.92	26.50	60.00	50.00	-27.08	-23.50
6	16.02734	0.56	27.63	19.49	28.19	20.05	60.00	50.00	-31.81	-29.95

**REMARKS:**

1. Q.P. and AV. are abbreviations of quasi-peak and average individually.
2. The emission levels of other frequencies were very low against the limit.
3. Margin value = Emission level - Limit value
4. Correction factor = Insertion loss + Cable loss
5. Emission Level = Correction Factor + Reading Value

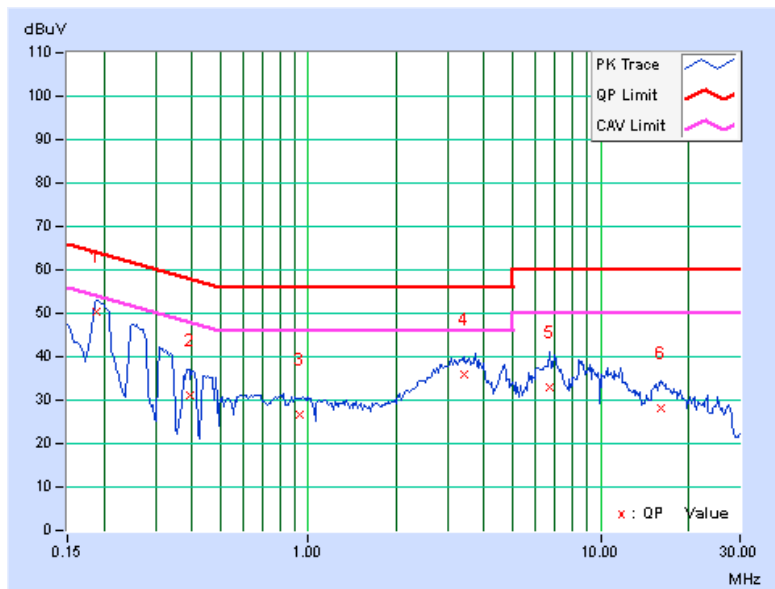



PHASE	Line 2	6dB BANDWIDTH	9kHz
-------	--------	---------------	------

No	Freq.	Corr. Factor	Reading Value		Emission Level		Limit		Margin	
	[MHz]		[dB (uV)]		[dB (uV)]		[dB (uV)]		(dB)	
			Q.P.	AV.	Q.P.	AV.	Q.P.	AV.	Q.P.	AV.
1	0.19297	0.18	47.08	35.07	47.26	35.25	63.91	53.91	-16.65	-18.66
2	0.39219	0.25	31.38	20.81	31.63	21.06	58.02	48.02	-26.39	-26.96
3	0.93125	0.23	30.15	16.56	30.38	16.79	56.00	46.00	-25.62	-29.21
4	3.46094	0.36	31.20	21.48	31.56	21.84	56.00	46.00	-24.44	-24.16
5	7.97656	0.45	32.67	26.11	33.12	26.56	60.00	50.00	-26.88	-23.44
6	16.29297	0.64	26.90	18.16	27.54	18.80	60.00	50.00	-32.46	-31.20

**REMARKS:**

1. Q.P. and AV. are abbreviations of quasi-peak and average individually.
2. The emission levels of other frequencies were very low against the limit.
3. Margin value = Emission level - Limit value
4. Correction factor = Insertion loss + Cable loss
5. Emission Level = Correction Factor + Reading Value

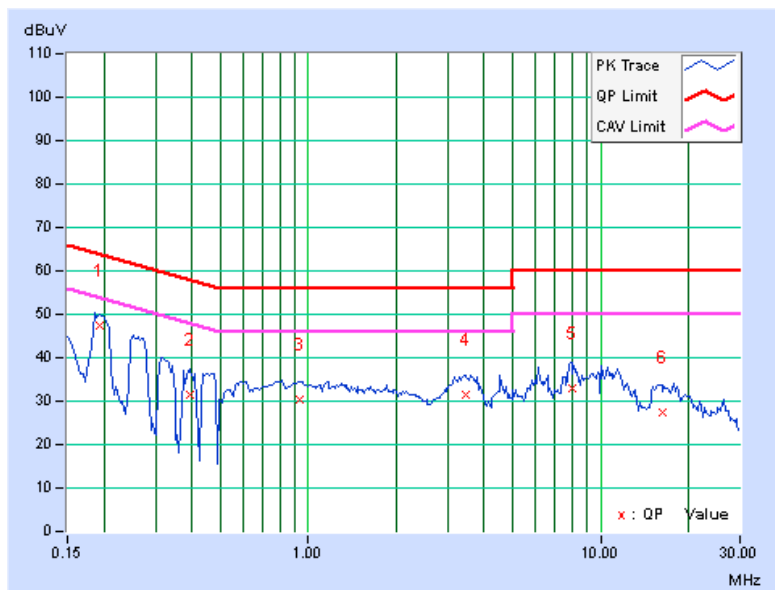

## 5. TEST TYPES AND RESULTS (FOR Bluetooth LE 4.0)

### 5.1 RADIATED EMISSION AND BANDEDGE MEASUREMENT

#### 5.1.1 LIMITS OF RADIATED EMISSION AND BANDEDGE MEASUREMENT

Radiated emissions which fall in the restricted bands must comply with the radiated emission limits specified as below table. Other emissions shall be at least 20dB below the highest level of the desired power:

FREQUENCIES (MHz)	FIELD STRENGTH (microvolts/meter)	MEASUREMENT DISTANCE (meters)
0.009 ~ 0.490	2400/F(kHz)	300
0.490 ~ 1.705	24000/F(kHz)	30
1.705 ~ 30.0	30	30
30 ~ 88	100	3
88 ~ 216	150	3
216 ~ 960	200	3
Above 960	500	3

**NOTE:**

1. The lower limit shall apply at the transition frequencies.
2. Emission level (dBuV/m) = 20 log Emission level (uV/m).
3. For frequencies above 1000MHz, the field strength limits are based on average detector, however, the peak field strength of any emission shall not exceed the maximum permitted average limits, specified above by more than 20dB under any condition of modulation.

#### 5.1.2 TEST INSTRUMENTS

Same as 4.1.2.

### 5.1.3 TEST PROCEDURES

- a. The EUT was placed on the top of a rotating table 0.8 meters above the ground at a 3 meters semi-anechoic chamber. The table was rotated 360 degrees to determine the position of the highest radiation.
- b. The EUT was set 3 meters away from the interference-receiving antenna, which was mounted on the top of a variable-height antenna tower.
- c. Height of receiving antenna is varied from one meter to four meters above the ground to determine the maximum value of the field strength. Both horizontal and vertical polarizations of the antenna are set to make the measurement.
- d. For each suspected emission, the EUT was arranged to its worst case and then the antenna was tuned to heights from 1 meter to 4 meters and the rotatable table was turned from 0 degrees to 360 degrees to find the maximum reading.
- e. The test-receiver system was set to Peak Detect Function and Specified Bandwidth with Maximum Hold Mode.
- f. If the emission level of the EUT in peak mode was lower than the limit specified, then testing could be stopped and the peak values of the EUT would be reported. Otherwise the emissions would be re-tested one by one using peak, quasi-peak or average method as specified and then reported in a data sheet.

**NOTE:**

1. The resolution bandwidth and video bandwidth of test receiver/spectrum analyzer is 120kHz for Quasi-peak detection at frequency below 1GHz.
2. The resolution bandwidth of test receiver/spectrum analyzer is 1MHz and video bandwidth is 3MHz for Peak detection at frequency above 1GHz.
3. The resolution bandwidth of test receiver/spectrum analyzer is 1MHz and the video bandwidth is 10Hz for Average detection (AV) at frequency above 1GHz.
4. All modes of operation were investigated and the worst-case emissions are reported.

### 5.1.4 DEVIATION FROM TEST STANDARD

No deviation.

### 5.1.5 TEST SETUP

Frequency Range 30MHz ~ 1GHz

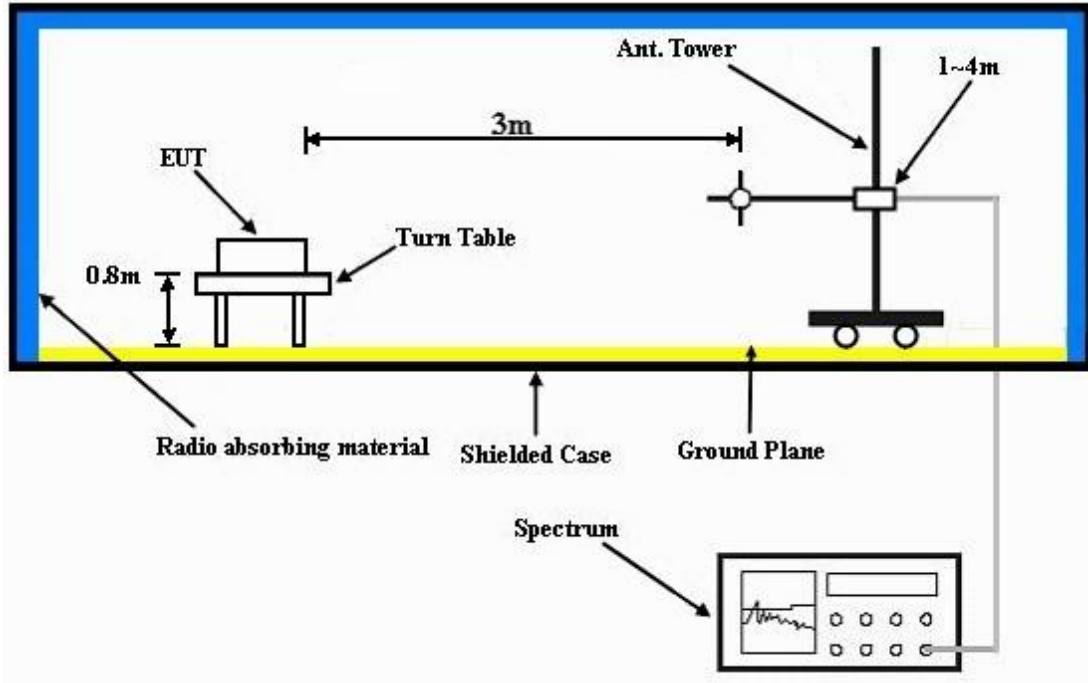

Frequency Range above 1GHz

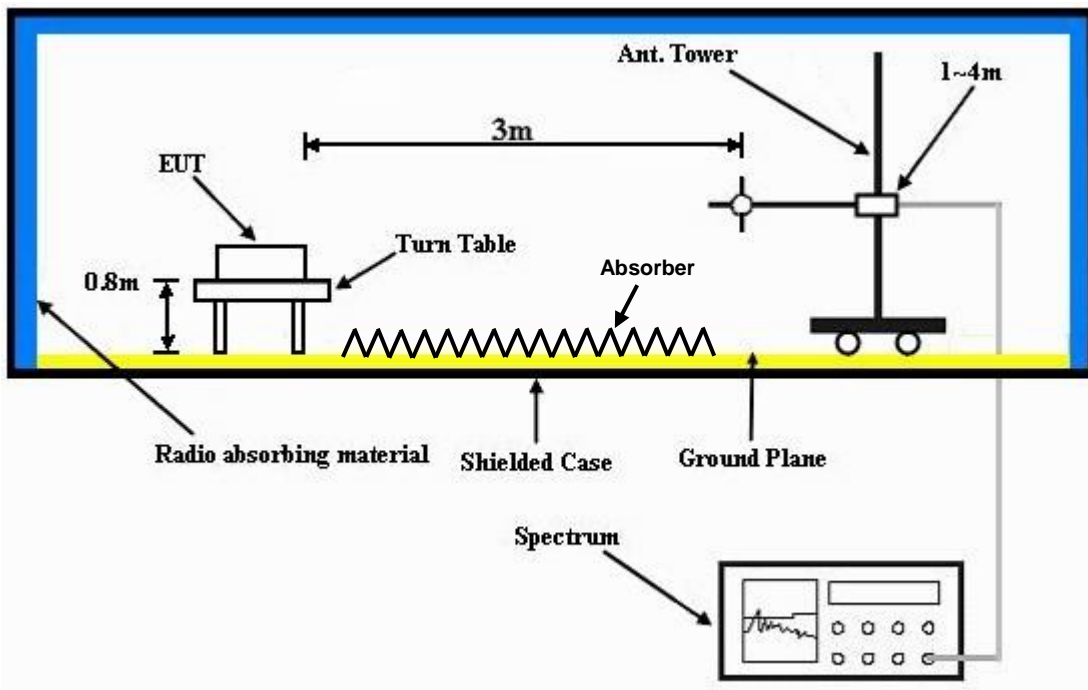

For the actual test configuration, please refer to the attached file (Test Setup Photo).

### 5.1.6 EUT OPERATING CONDITIONS

- a. Placed the EUT on a testing table.
- b. Use the software to control the EUT under transmission condition continuously at specific channel frequency.

### 5.1.7 TEST RESULTS

#### ABOVE 1GHz DATA

EUT TEST CONDITION		MEASUREMENT DETAIL	
CHANNEL	Channel 39	FREQUENCY RANGE	1GHz ~ 25GHz
INPUT POWER (SYSTEM)	120Vac, 60 Hz	DETECTOR FUNCTION	Peak (PK) Average (AV)
ENVIRONMENTAL CONDITIONS	25deg. C, 65%RH	TESTED BY	Anson Lin

ANTENNA POLARITY & TEST DISTANCE: HORIZONTAL AT 3 M										
FREQ. (MHz)	EMISSION LEVEL (dBuV/m)	READ LEVEL (dBuV)	LIMIT (dBuV/m)	MARGIN (dB)	ANTENNA FACTOR (dB/m)	CABLE LOSS (dB)	PREAMP FACTOR (dB)	ANTENNA HEIGHT (cm)	TABLE ANGLE (Degree)	REMARK
2384	39.53	46.65	54	-14.47	26.86	3.52	37.5	100	226	Average
2384	47.85	54.97	74	-26.15	26.86	3.52	37.5	100	226	Peak
2480	100.26	106.83			27.15	3.6	37.32	100	226	Average
2480	101.25	107.82			27.15	3.6	37.32	100	226	Peak
2484	38.48	45.05	54	-15.52	27.15	3.6	37.32	100	226	Average
2484	54.08	60.65	74	-19.92	27.15	3.6	37.32	100	226	Peak
ANTENNA POLARITY & TEST DISTANCE: VERTICAL AT 3 M										
FREQ. (MHz)	EMISSION LEVEL (dBuV/m)	READ LEVEL (dBuV)	LIMIT (dBuV/m)	MARGIN (dB)	ANTENNA FACTOR (dB/m)	CABLE LOSS (dB)	PREAMP FACTOR (dB)	ANTENNA HEIGHT (cm)	TABLE ANGLE (Degree)	REMARK
2348	34.7	41.92	54	-19.3	26.77	3.5	37.49	100	294	Average
2348	46.56	53.78	74	-27.44	26.77	3.5	37.49	100	294	Peak
2480	92.22	98.79			27.15	3.6	37.32	100	294	Average
2480	93.13	99.7			27.15	3.6	37.32	100	294	Peak
2484	35.28	41.85	54	-18.72	27.15	3.6	37.32	100	294	Average
2484	48.51	55.08	74	-25.49	27.15	3.6	37.32	100	294	Peak

#### REMARKS:

1. Emission Level = Read Level + Antenna Factor + Cable Loss - Preamp Factor
2. 2480MHz: Fundamental frequency.

**BELOW 1GHz WORST-CASE DATA**

EUT TEST CONDITION		MEASUREMENT DETAIL	
CHANNEL	Channel 39	FREQUENCY RANGE	1GHz ~ 25GHz
INPUT POWER (SYSTEM)	120Vac, 60 Hz	DETECTOR FUNCTION	Peak (PK) Quasi-peak (QP)
ENVIRONMENTAL CONDITIONS	25deg. C, 65%RH	TESTED BY	Anson Lin

ANTENNA POLARITY & TEST DISTANCE: HORIZONTAL AT 3 M										
FREQ. (MHz)	EMISSION LEVEL (dBuV/m)	READ LEVEL (dBuV)	LIMIT (dBuV/m)	MARGIN (dB)	ANTENNA FACTOR (dB/m)	CABLE LOSS (dB)	PREAMP FACTOR (dB)	ANTENNA HEIGHT (cm)	TABLE ANGLE (Degree)	REMARK
43.5	32.41	49.22	40	-7.59	13.59	0.71	31.11	102	135	Peak
73.74	29.82	50.79	40	-10.18	9.81	0.93	31.71	100	224	Peak
224.94	31.19	50.83	46	-14.81	10.42	1.72	31.78	100	173	Peak
404.3	36.56	50.76	46	-9.44	15.43	2.44	32.07	100	157	Peak
750.1	36.99	43.2	46	-9.01	21.52	3.57	31.3	100	206	Peak
806.8	34.02	39.43	46	-11.98	22.32	3.71	31.44	100	162	Peak
ANTENNA POLARITY & TEST DISTANCE: VERTICAL AT 3 M										
FREQ. (MHz)	EMISSION LEVEL (dBuV/m)	READ LEVEL (dBuV)	LIMIT (dBuV/m)	MARGIN (dB)	ANTENNA FACTOR (dB/m)	CABLE LOSS (dB)	PREAMP FACTOR (dB)	ANTENNA HEIGHT (cm)	TABLE ANGLE (Degree)	REMARK
43.23	33.11	49.92	40	-6.89	13.59	0.71	31.11	104	62	Peak
138.54	25.75	43.85	43.5	-17.75	12.27	1.29	31.66	100	113	Peak
237.36	28.59	47.66	46	-17.41	10.95	1.78	31.8	100	272	Peak
437.9	33.25	46.58	46	-12.75	16.1	2.57	32	100	179	Peak
538	31.99	42.61	46	-14.01	18.19	2.91	31.72	100	313	Peak
806.8	30.6	36.01	46	-15.4	22.32	3.71	31.44	100	215	Peak

**REMARKS:** Emission Level = Read Level + Antenna Factor + Cable Loss - Preamp Factor

## **5.2 CONDUCTED EMISSION MEASUREMENT**

### **5.2.1 LIMITS OF CONDUCTED EMISSION MEASUREMENT**

Same as 4.2.1.

### **5.2.2 TEST INSTRUMENTS**

Same as 4.2.2.

### **5.2.3 TEST PROCEDURES**

Same as 4.2.3.

### **5.2.4 DEVIATION FROM TEST STANDARD**

No deviation.

### **5.2.5 TEST SETUP**

Same as 4.2.5.

### **5.2.6 EUT OPERATING CONDITIONS**

Same as 4.2.6.



### 5.2.7 TEST RESULTS

#### CONDUCTED WORST CASE DATA:

PHASE	Line 1	6dB BANDWIDTH	9kHz
-------	--------	---------------	------

No	Freq. [MHz]	Corr. Factor (dB)	Reading Value [dB (uV)]		Emission Level [dB (uV)]		Limit [dB (uV)]		Margin (dB)	
			Q.P.	AV.	Q.P.	AV.	Q.P.	AV.	Q.P.	AV.
			1	0.20078	0.17	44.11	30.59	44.28	30.76	63.58
2	0.45859	0.22	28.86	15.72	29.08	15.94	56.72	46.72	-27.64	-30.78
3	0.93125	0.26	26.97	14.12	27.23	14.38	56.00	46.00	-28.77	-31.62
4	2.95313	0.32	35.26	25.32	35.58	25.64	56.00	46.00	-20.42	-20.36
5	6.32031	0.39	32.54	24.25	32.93	24.64	60.00	50.00	-27.07	-25.36
6	17.37891	0.58	26.83	17.55	27.41	18.13	60.00	50.00	-32.59	-31.87

#### REMARKS:

1. Q.P. and AV. are abbreviations of quasi-peak and average individually.
2. The emission levels of other frequencies were very low against the limit.
3. Margin value = Emission level - Limit value
4. Correction factor = Insertion loss + Cable loss
5. Emission Level = Correction Factor + Reading Value

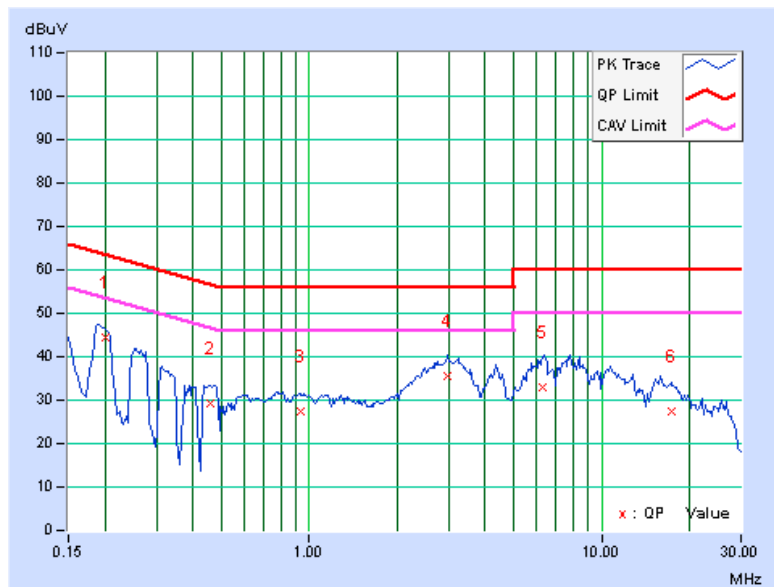

PHASE	Line 2	6dB BANDWIDTH	9kHz
-------	--------	---------------	------

No	Freq. [MHz]	Corr. Factor (dB)	Reading Value [dB (uV)]		Emission Level [dB (uV)]		Limit [dB (uV)]		Margin (dB)	
			Q.P.	AV.	Q.P.	AV.	Q.P.	AV.	Q.P.	AV.
1	0.19297	0.18	45.27	33.60	45.45	33.78	63.91	53.91	-18.46	-20.13
2	0.45859	0.25	32.07	18.43	32.32	18.68	56.72	46.72	-24.40	-28.04
3	0.95469	0.23	30.63	18.20	30.86	18.43	56.00	46.00	-25.14	-27.57
4	3.43750	0.36	31.46	22.01	31.82	22.37	56.00	46.00	-24.18	-23.63
5	7.90234	0.45	33.77	26.56	34.22	27.01	60.00	50.00	-25.78	-22.99
6	15.87500	0.63	27.31	19.24	27.94	19.87	60.00	50.00	-32.06	-30.13

**REMARKS:**

1. Q.P. and AV. are abbreviations of quasi-peak and average individually.
2. The emission levels of other frequencies were very low against the limit.
3. Margin value = Emission level - Limit value
4. Correction factor = Insertion loss + Cable loss
5. Emission Level = Correction Factor + Reading Value

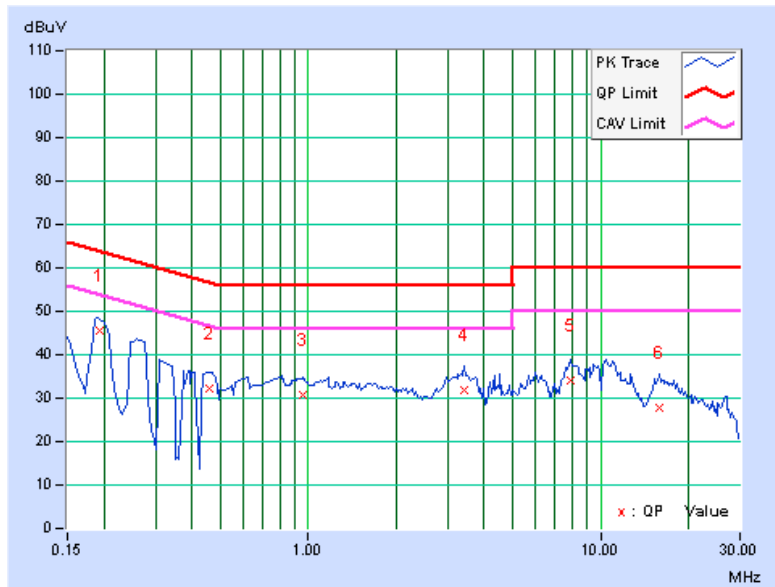



A D T

## 6. PHOTOGRAPHS OF THE TEST CONFIGURATION

Please refer to the attached file (Test Setup Photo).





## 7. INFORMATION ON THE TESTING LABORATORIES

We, Bureau Veritas Consumer Products Services (H.K.) Ltd., Taoyuan Branch, were founded in 1988 to provide our best service in EMC, Radio, Telecom and Safety consultation. Our laboratories are accredited and approved according to ISO/IEC 17025.

If you have any comments, please feel free to contact us at the following:

**Linko EMC/RF Lab:**

Tel: 886-2-26052180

Fax: 886-2-26051924

**Hsin Chu EMC/RF Lab:**

Tel: 886-3-5935343

Fax: 886-3-5935342

**Hwa Ya EMC/RF/Safety Telecom Lab:**

Tel: 886-3-3183232

Fax: 886-3-3270892

**Email:** [service.adt@tw.bureauveritas.com](mailto:service.adt@tw.bureauveritas.com)

**Web Site:** [www.bureauveritas-adt.com](http://www.bureauveritas-adt.com)

The address and road map of all our labs can be found in our web site also.



A D T

## **8. APPENDIX A - MODIFICATIONS RECORDERS FOR ENGINEERING CHANGES TO THE EUT BY THE LAB**

No modifications were made to the EUT by the lab during the test.

**--- END ---**