

Site: NS-AC1	Time: 2020/11/03 - 20:44
Limit: FCC_Part 15_15.209 RE(3m)	Engineer: Silence Liu
Probe: NS-AC1_BBHA9120D_2111	Polarity: Horizontal
EUT: MESH AP Product	Power: AC 120V/60Hz
Test Mode: Transmit by 802.11b at channel 2437MHz (CDD Mode)	

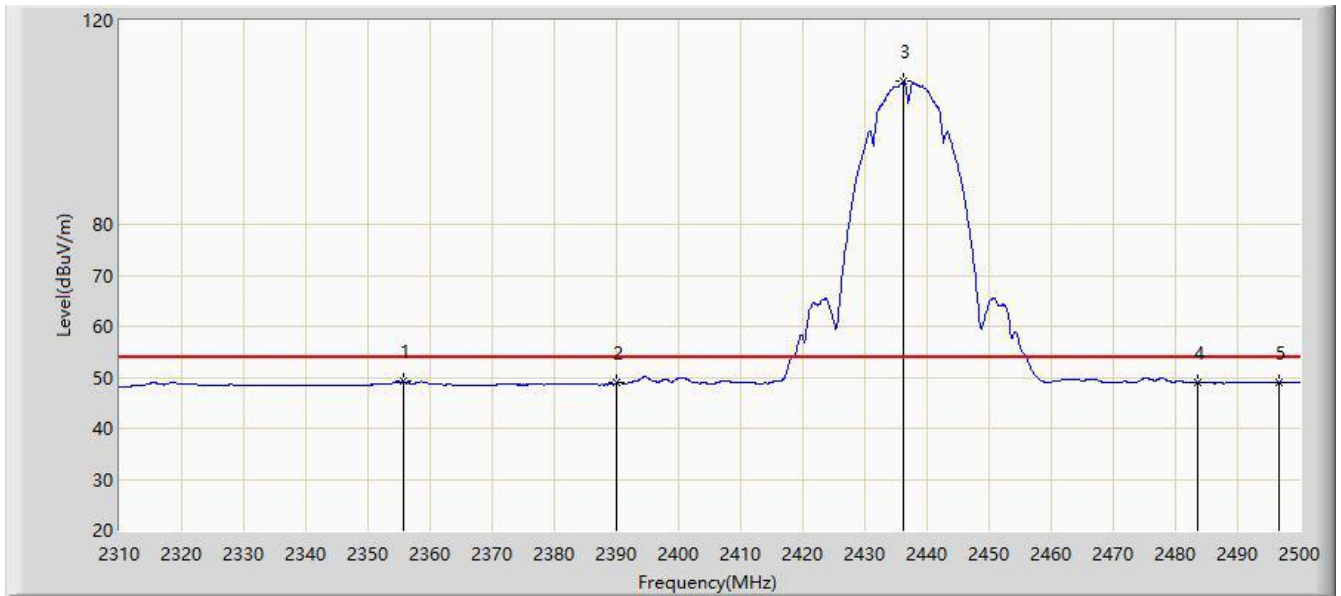

No	Flag	Mark	Frequency (MHz)	Measure Level (dBuV/m)	Reading Level (dBuV)	Margin (dB)	Limit (dBuV/m)	Factor (dB)	Type
1			2355.600	49.162	19.743	-4.838	54.000	29.420	AV
2			2390.000	48.856	19.374	-5.144	54.000	29.482	AV
3		*	2436.255	108.026	78.463	N/A	N/A	29.562	AV
4			2483.500	48.965	19.303	-5.035	54.000	29.662	AV
5			2496.580	49.070	19.403	-4.930	54.000	29.667	AV

Note: Measure Level (dB $\mu$ V/m) = Reading Level (dB $\mu$ V) + Factor (dB)

Factor (dB) = Cable Loss (dB) + Antenna Factor (dB/m).

Site: NS-AC1	Time: 2020/11/03 - 20:44
Limit: FCC_Part 15_15.209 RE(3m)	Engineer: Silence Liu
Probe: NS-AC1_BBHA9120D_2111	Polarity: Vertical
EUT: MESH AP Product	Power: AC 120V/60Hz
Test Mode: Transmit by 802.11b at channel 2437MHz (CDD Mode)	

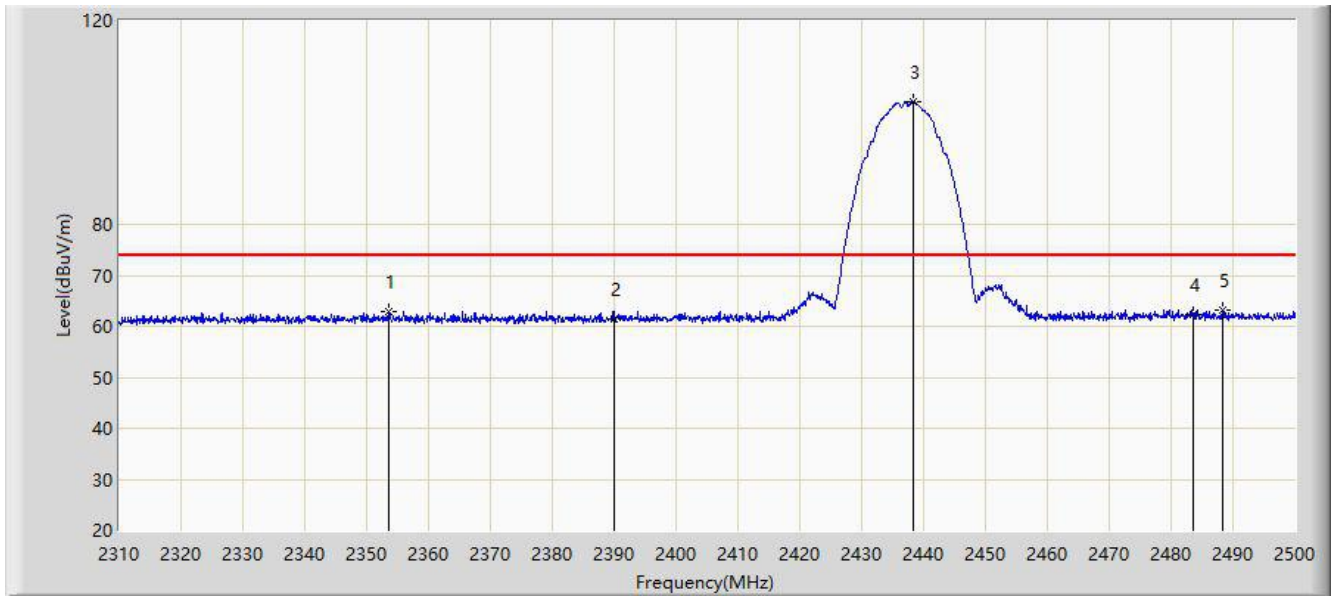

No	Flag	Mark	Frequency (MHz)	Measure Level (dBuV/m)	Reading Level (dBuV)	Margin (dB)	Limit (dBuV/m)	Factor (dB)	Type
1			2353.510	62.900	33.484	-11.100	74.000	29.417	PK
2			2390.000	61.408	31.926	-12.592	74.000	29.482	PK
3		*	2438.250	104.091	74.525	N/A	N/A	29.565	PK
4			2483.500	62.226	32.564	-11.774	74.000	29.662	PK
5			2488.220	63.134	33.471	-10.866	74.000	29.663	PK

Note: Measure Level (dB $\mu$ V/m) = Reading Level (dB $\mu$ V) + Factor (dB)

Factor (dB) = Cable Loss (dB) + Antenna Factor (dB/m).

Site: NS-AC1	Time: 2020/11/03 - 20:48
Limit: FCC_Part 15_15.209 RE(3m)	Engineer: Silence Liu
Probe: NS-AC1_BBHA9120D_2111	Polarity: Vertical
EUT: MESH AP Product	Power: AC 120V/60Hz
Test Mode: Transmit by 802.11b at channel 2437MHz (CDD Mode)	

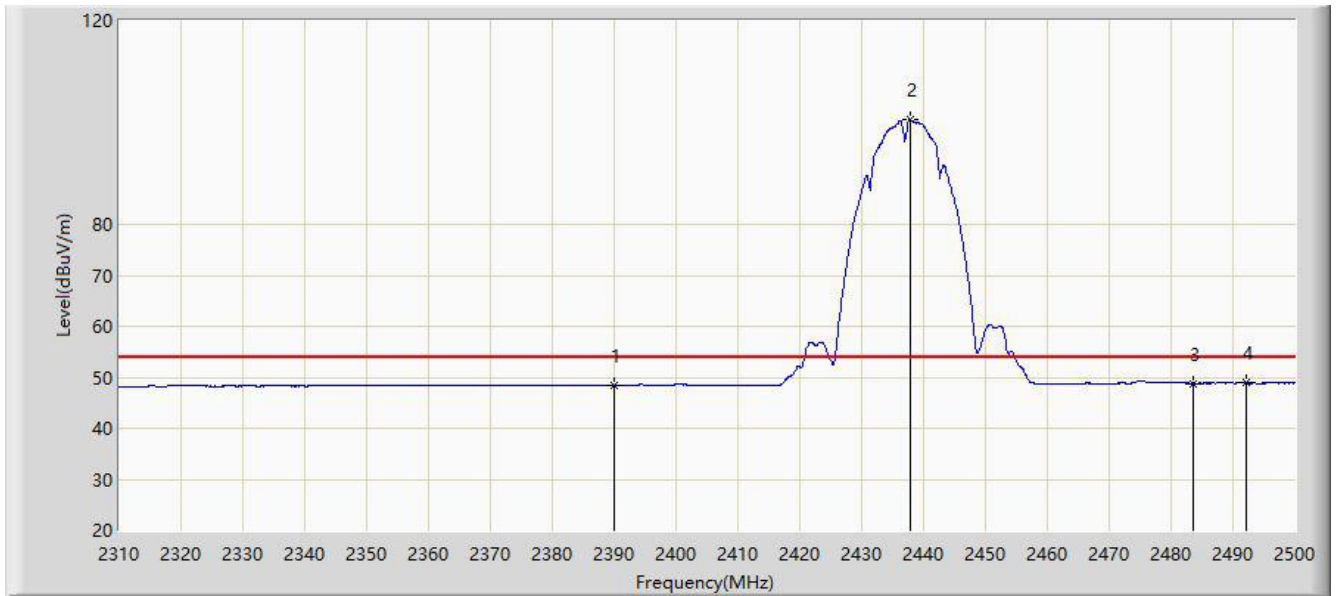

No	Flag	Mark	Frequency (MHz)	Measure Level (dBuV/m)	Reading Level (dBuV)	Margin (dB)	Limit (dBuV/m)	Factor (dB)	Type
1			2390.000	48.438	18.956	-5.562	54.000	29.482	AV
2		*	2437.775	100.518	70.953	N/A	N/A	29.565	AV
3			2483.500	48.809	19.147	-5.191	54.000	29.662	AV
4			2492.210	48.927	19.263	-5.073	54.000	29.664	AV

Note: Measure Level (dB $\mu$ V/m) = Reading Level (dB $\mu$ V) + Factor (dB)

Factor (dB) = Cable Loss (dB) + Antenna Factor (dB/m).

Site: NS-AC1	Time: 2020/11/03 - 20:49
Limit: FCC_Part 15_15.209 RE(3m)	Engineer: Silence Liu
Probe: NS-AC1_BBHA9120D_2111	Polarity: Horizontal
EUT: MESH AP Product	Power: AC 120V/60Hz
Test Mode: Transmit by 802.11b at channel 2462MHz (CDD Mode)	

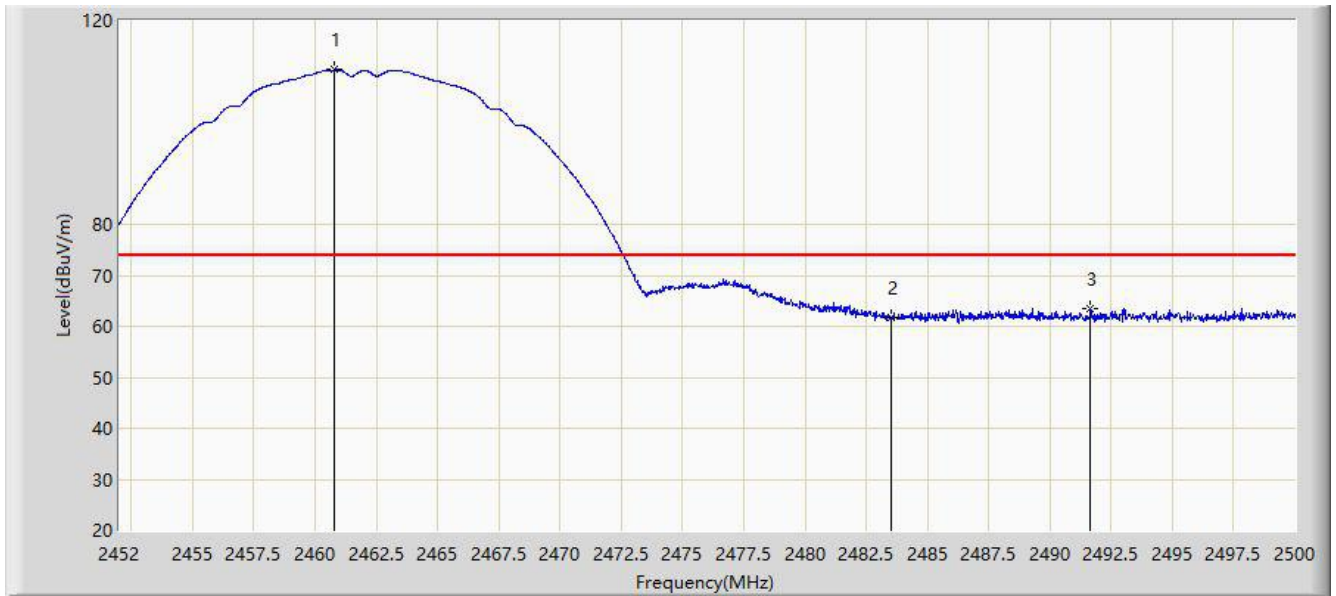

No	Flag	Mark	Frequency (MHz)	Measure Level (dBuV/m)	Reading Level (dBuV)	Margin (dB)	Limit (dBuV/m)	Factor (dB)	Type
1		*	2460.808	110.298	80.698	N/A	N/A	29.600	PK
2			2483.500	61.684	32.022	-12.316	74.000	29.662	PK
3			2491.648	63.450	33.786	-10.550	74.000	29.664	PK

Note: Measure Level (dBuV/m) = Reading Level (dBuV) + Factor (dB)

Factor (dB) = Cable Loss (dB) + Antenna Factor (dB/m).

Site: NS-AC1	Time: 2020/11/03 - 20:51
Limit: FCC_Part 15_15.209 RE(3m)	Engineer: Silence Liu
Probe: NS-AC1_BBHA9120D_2111	Polarity: Horizontal
EUT: MESH AP Product	Power: AC 120V/60Hz
Test Mode: Transmit by 802.11b at channel 2462MHz (CDD Mode)	

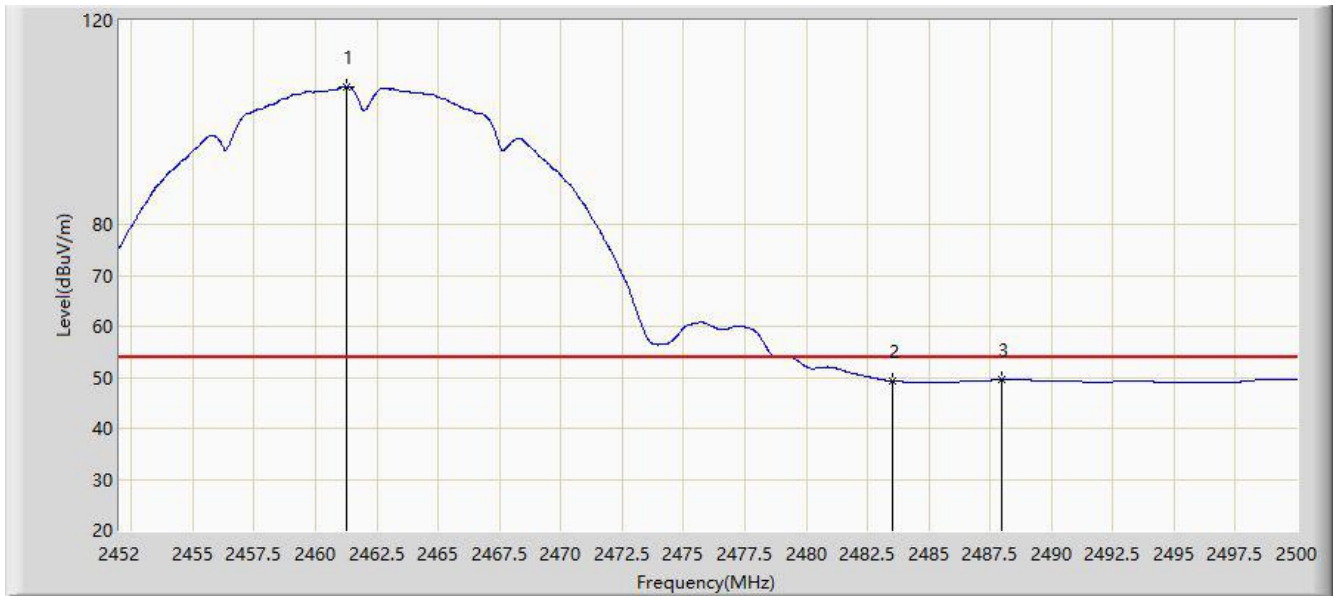

No	Flag	Mark	Frequency (MHz)	Measure Level (dBuV/m)	Reading Level (dBuV)	Margin (dB)	Limit (dBuV/m)	Factor (dB)	Type
1		*	2461.240	107.068	77.468	N/A	N/A	29.600	AV
2			2483.500	49.290	19.628	-4.710	54.000	29.662	AV
3			2487.976	49.521	19.858	-4.479	54.000	29.663	AV

Note: Measure Level (dB $\mu$ V/m) = Reading Level (dB $\mu$ V) + Factor (dB)

Factor (dB) = Cable Loss (dB) + Antenna Factor (dB/m).

Site: NS-AC1	Time: 2020/11/03 - 20:51
Limit: FCC_Part 15_15.209 RE(3m)	Engineer: Silence Liu
Probe: NS-AC1_BBHA9120D_2111	Polarity: Vertical
EUT: MESH AP Product	Power: AC 120V/60Hz
Test Mode: Transmit by 802.11b at channel 2462MHz (CDD Mode)	

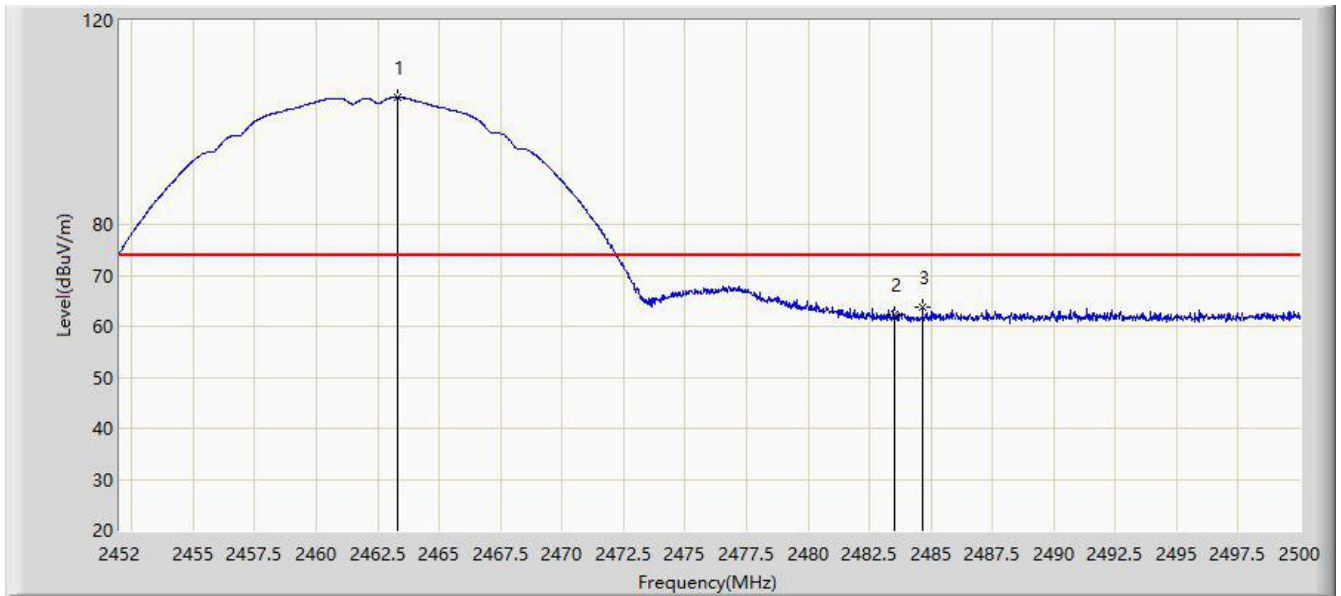

No	Flag	Mark	Frequency (MHz)	Measure Level (dBuV/m)	Reading Level (dBuV)	Margin (dB)	Limit (dBuV/m)	Factor (dB)	Type
1		*	2463.304	104.891	75.285	N/A	N/A	29.606	PK
2			2483.500	62.217	32.555	-11.783	74.000	29.662	PK
3			2484.664	63.795	34.133	-10.205	74.000	29.662	PK

Note: Measure Level (dB $\mu$ V/m) = Reading Level (dB $\mu$ V) + Factor (dB)

Factor (dB) = Cable Loss (dB) + Antenna Factor (dB/m).

Site: NS-AC1	Time: 2020/11/03 - 20:54
Limit: FCC_Part 15_15.209 RE(3m)	Engineer: Silence Liu
Probe: NS-AC1_BBHA9120D_2111	Polarity: Vertical
EUT: MESH AP Product	Power: AC 120V/60Hz
Test Mode: Transmit by 802.11b at channel 2462MHz (CDD Mode)	

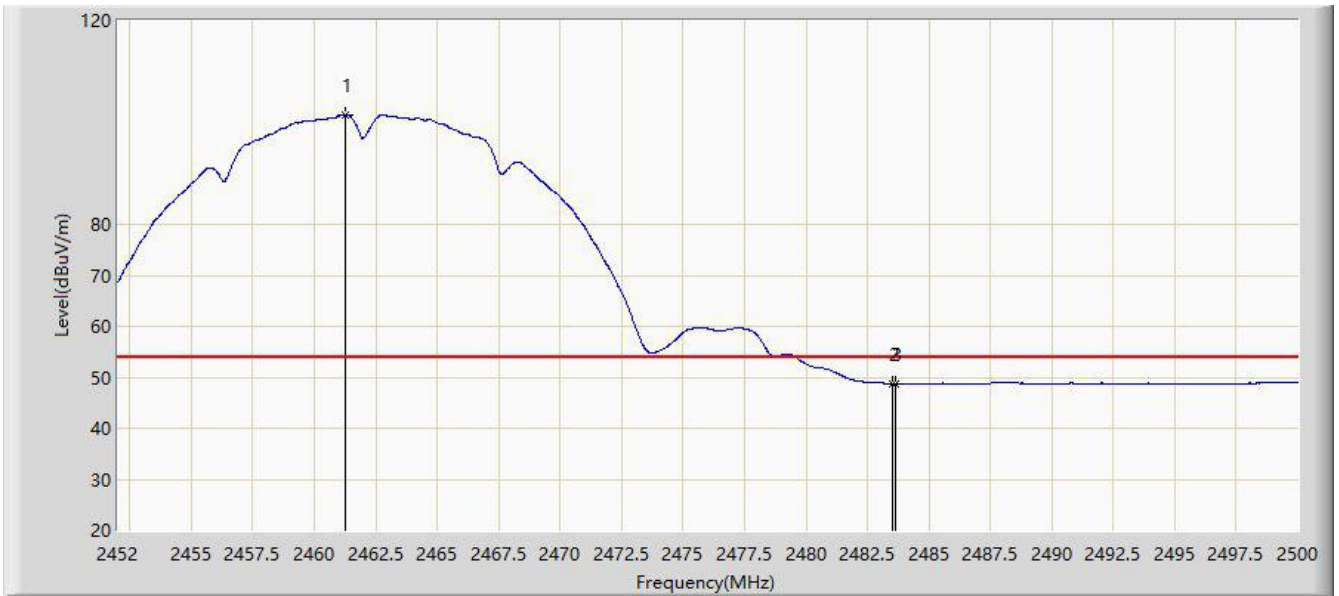

No	Flag	Mark	Frequency (MHz)	Measure Level (dBuV/m)	Reading Level (dBuV)	Margin (dB)	Limit (dBuV/m)	Factor (dB)	Type
1		*	2461.240	101.584	71.984	N/A	N/A	29.600	AV
2			2483.500	48.800	19.138	-5.200	54.000	29.662	AV
3			2483.632	48.821	19.159	-5.179	54.000	29.662	AV

Note: Measure Level (dB $\mu$ V/m) = Reading Level (dB $\mu$ V) + Factor (dB)

Factor (dB) = Cable Loss (dB) + Antenna Factor (dB/m).

Site: NS-AC1	Time: 2020/10/29 - 16:53
Limit: FCC_Part 15_15.209 RE(3m)	Engineer: Silence Liu
Probe: NS-AC1_BBHA9120D_2111	Polarity: Horizontal
EUT: MESH AP Product	Power: AC 120V/60Hz
Test Mode: Transmit by 802.11g at channel 2412MHz (CDD Mode)	

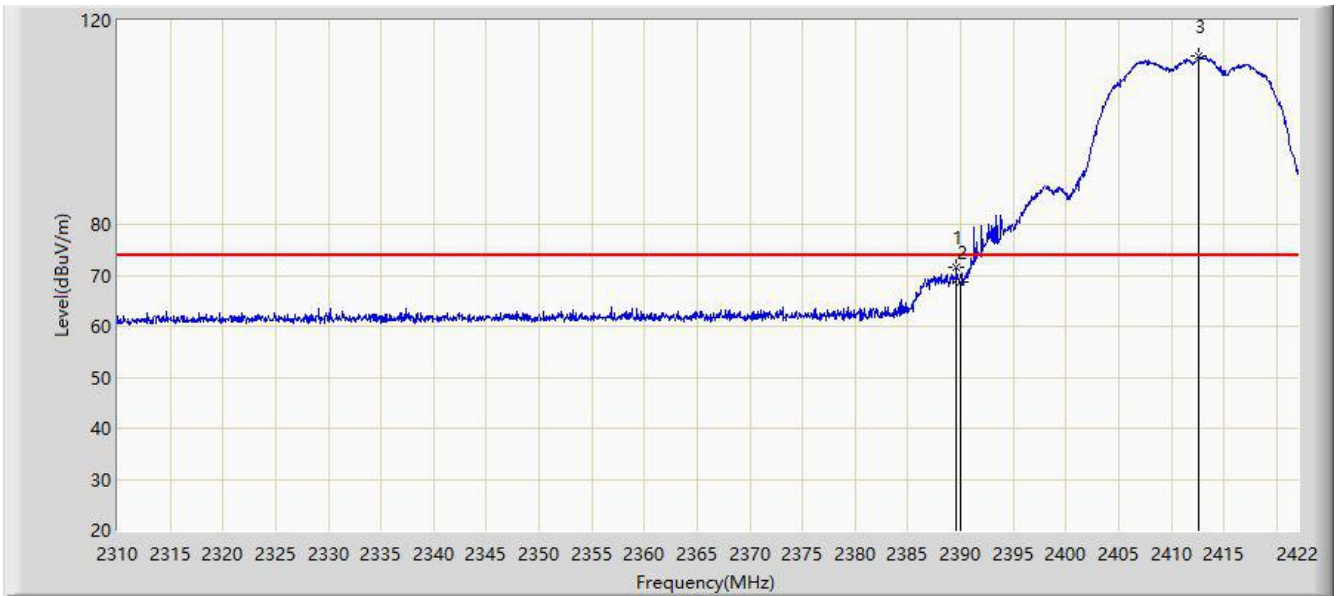

No	Flag	Mark	Frequency (MHz)	Measure Level (dBuV/m)	Reading Level (dBuV)	Margin (dB)	Limit (dBuV/m)	Factor (dB)	Type
1			2389.576	71.484	42.003	-2.516	74.000	29.482	PK
2			2390.000	68.676	39.194	-5.324	74.000	29.482	PK
3		*	2412.648	112.974	83.434	N/A	N/A	29.541	PK

Note: Measure Level (dB $\mu$ V/m) = Reading Level (dB $\mu$ V) + Factor (dB)

Factor (dB) = Cable Loss (dB) + Antenna Factor (dB/m).



Site: NS-AC1	Time: 2020/10/29 - 16:56
Limit: FCC_Part 15_15.209 RE(3m)	Engineer: Silence Liu
Probe: NS-AC1_BBHA9120D_2111	Polarity: Horizontal
EUT: MESH AP Product	Power: AC 120V/60Hz
Test Mode: Transmit by 802.11g at channel 2412MHz (CDD Mode)	

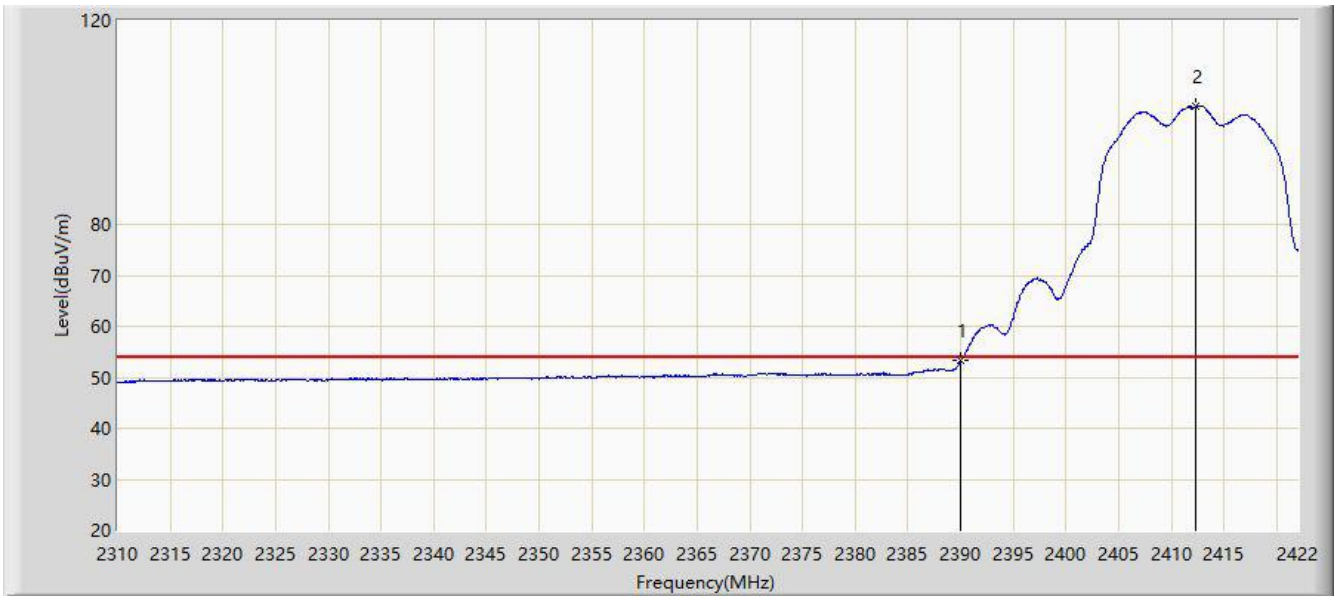

No	Flag	Mark	Frequency (MHz)	Measure Level (dBuV/m)	Reading Level (dBuV)	Margin (dB)	Limit (dBuV/m)	Factor (dB)	Type
1			2390.000	53.205	23.723	-0.795	54.000	29.482	AV
2		*	2412.368	103.086	73.546	N/A	N/A	29.540	AV

Note: Measure Level (dBμV/m) = Reading Level (dBμV) + Factor (dB)

Factor (dB) = Cable Loss (dB) + Antenna Factor (dB/m).

Site: NS-AC1	Time: 2020/10/29 - 17:22
Limit: FCC_Part 15_15.209 RE(3m)	Engineer: Silence Liu
Probe: NS-AC1_BBHA9120D_2111	Polarity: Vertical
EUT: MESH AP Product	Power: AC 120V/60Hz
Test Mode: Transmit by 802.11g at channel 2412MHz (CDD Mode)	

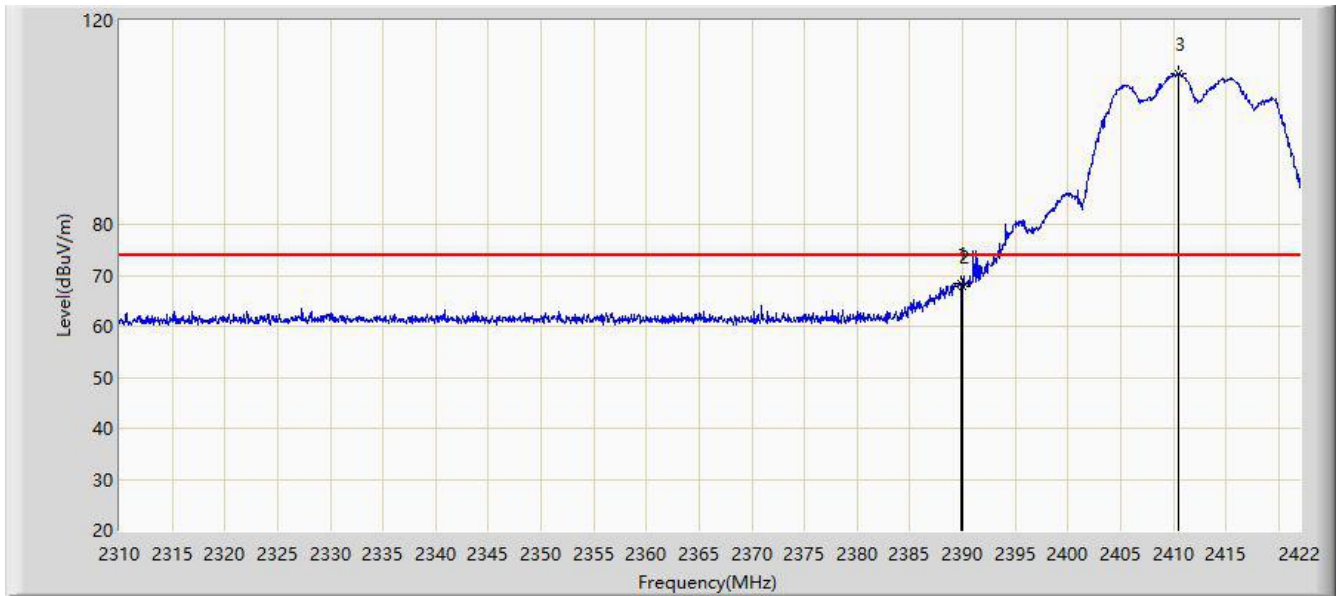

No	Flag	Mark	Frequency (MHz)	Measure Level (dBuV/m)	Reading Level (dBuV)	Margin (dB)	Limit (dBuV/m)	Factor (dB)	Type
1			2389.856	68.531	39.049	-5.469	74.000	29.482	PK
2			2390.000	67.698	38.216	-6.302	74.000	29.482	PK
3		*	2410.464	109.443	79.905	N/A	N/A	29.537	PK

Note: Measure Level (dB $\mu$ V/m) = Reading Level (dB $\mu$ V) + Factor (dB)

Factor (dB) = Cable Loss (dB) + Antenna Factor (dB/m).

Site: NS-AC1	Time: 2020/10/29 - 17:24
Limit: FCC_Part 15_15.209 RE(3m)	Engineer: Silence Liu
Probe: NS-AC1_BBHA9120D_2111	Polarity: Vertical
EUT: MESH AP Product	Power: AC 120V/60Hz
Test Mode: Transmit by 802.11g at channel 2412MHz (CDD Mode)	

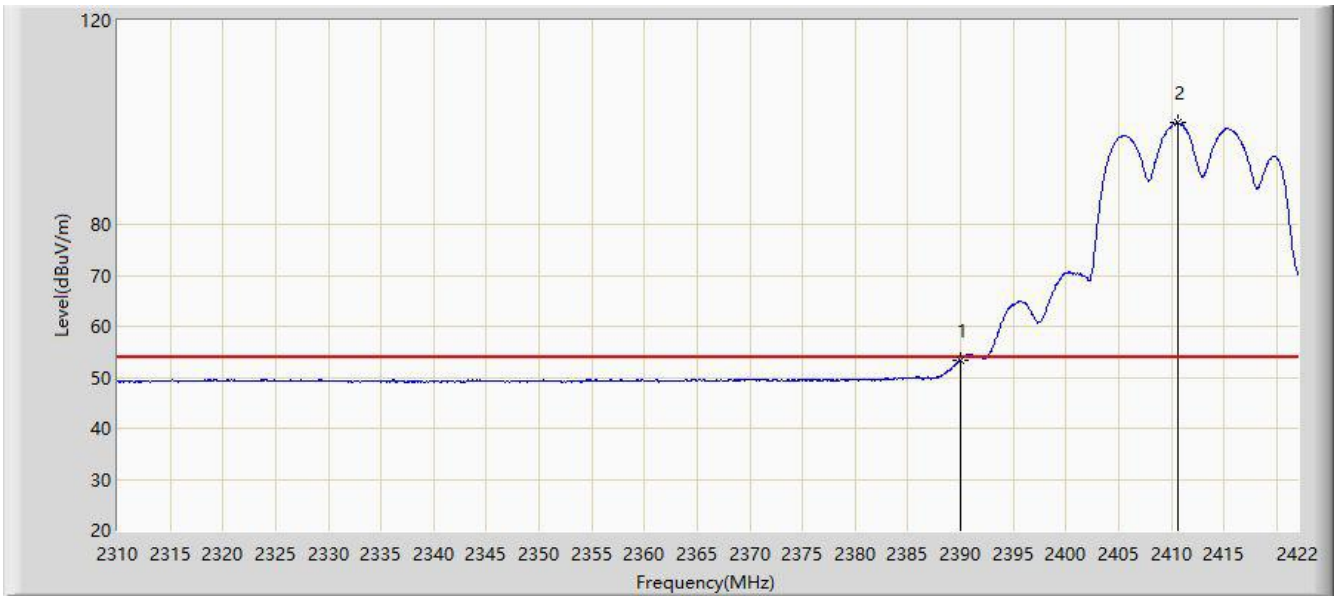

No	Flag	Mark	Frequency (MHz)	Measure Level (dBuV/m)	Reading Level (dBuV)	Margin (dB)	Limit (dBuV/m)	Factor (dB)	Type
1			2390.000	53.430	23.948	-0.570	54.000	29.482	AV
2		*	2410.632	99.939	70.401	N/A	N/A	29.538	AV

Note: Measure Level (dB $\mu$ V/m) = Reading Level (dB $\mu$ V) + Factor (dB)

Factor (dB) = Cable Loss (dB) + Antenna Factor (dB/m).

Site: NS-AC1	Time: 2020/11/03 - 17:22
Limit: FCC_Part 15_15.209 RE(3m)	Engineer: Silence Liu
Probe: NS-AC1_BBHA9120D_2111	Polarity: Horizontal
EUT: MESH AP Product	Power: AC 120V/60Hz
Test Mode: Transmit by 802.11g at channel 2417MHz (CDD Mode)	

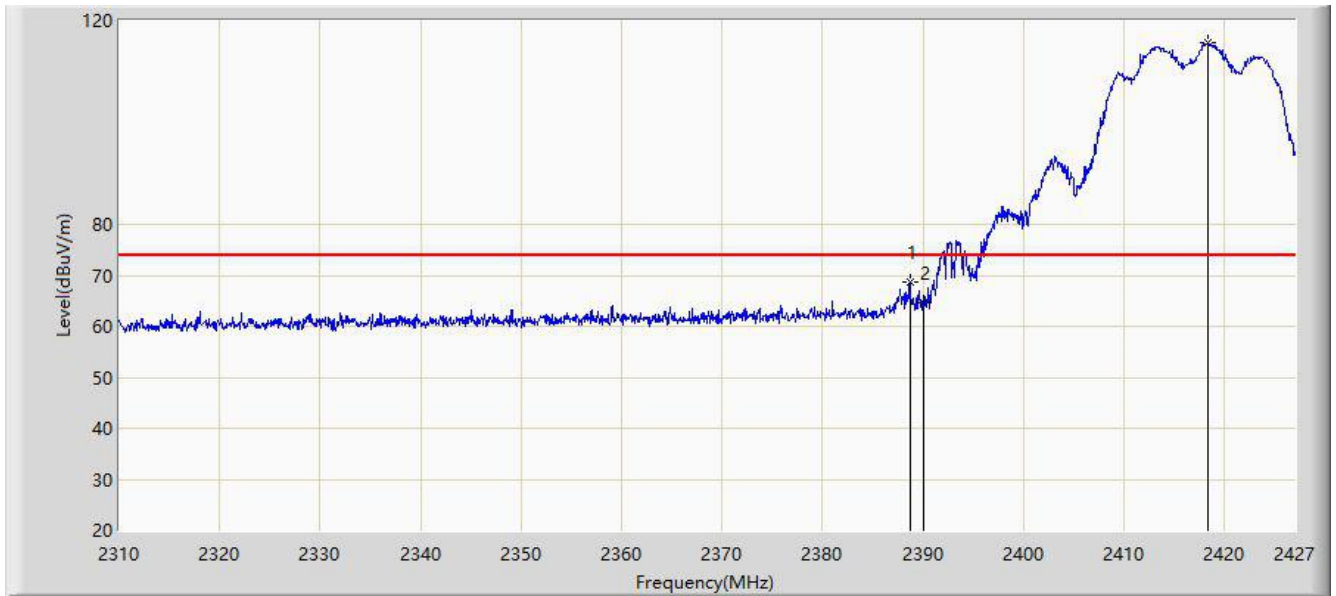

No	Flag	Mark	Frequency (MHz)	Measure Level (dBuV/m)	Reading Level (dBuV)	Margin (dB)	Limit (dBuV/m)	Factor	Type
1			2388.683	68.650	39.170	-5.350	74.000	29.480	PK
2			2390.000	64.670	35.188	-9.330	74.000	29.482	PK
3		*	2418.342	115.610	86.066	N/A	N/A	29.543	PK

Note: Measure Level (dB $\mu$ V/m) = Reading Level (dB $\mu$ V) + Factor (dB)

Factor (dB) = Cable Loss (dB) + Antenna Factor (dB/m).

Site: NS-AC1	Time: 2020/11/03 - 17:22
Limit: FCC_Part 15_15.209 RE(3m)	Engineer: Silence Liu
Probe: NS-AC1_BBHA9120D_2111	Polarity: Horizontal
EUT: MESH AP Product	Power: AC 120V/60Hz
Test Mode: Transmit by 802.11g at channel 2417MHz (CDD Mode)	

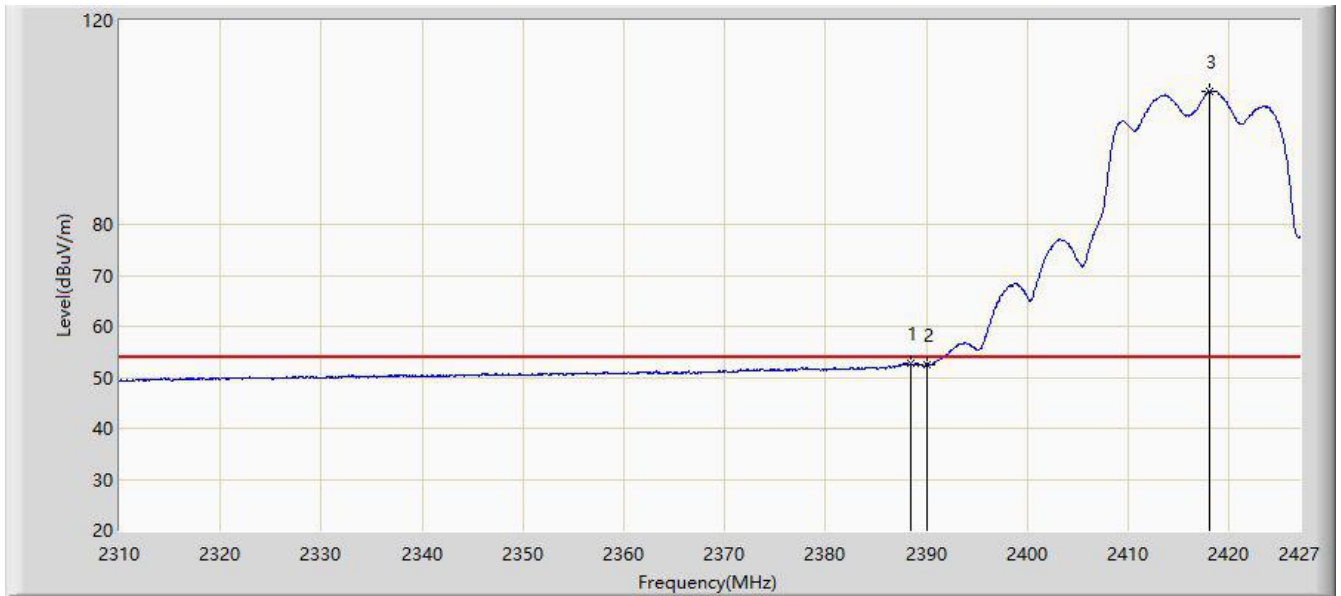

No	Flag	Mark	Frequency (MHz)	Measure Level (dBuV/m)	Reading Level (dBuV)	Margin (dB)	Limit (dBuV/m)	Factor (dB)	Type
1			2388.507	52.728	23.248	-1.272	54.000	29.480	AV
2			2390.000	52.513	23.031	-1.487	54.000	29.482	AV
3		*	2417.991	106.198	76.654	N/A	N/A	29.544	AV

Note: Measure Level (dB $\mu$ V/m) = Reading Level (dB $\mu$ V) + Factor (dB)

Factor (dB) = Cable Loss (dB) + Antenna Factor (dB/m).

Site: NS-AC1	Time: 2020/11/03 - 17:23
Limit: FCC_Part 15_15.209 RE(3m)	Engineer: Silence Liu
Probe: NS-AC1_BBHA9120D_2111	Polarity: Vertical
EUT: MESH AP Product	Power: AC 120V/60Hz
Test Mode: Transmit by 802.11g at channel 2417MHz (CDD Mode)	

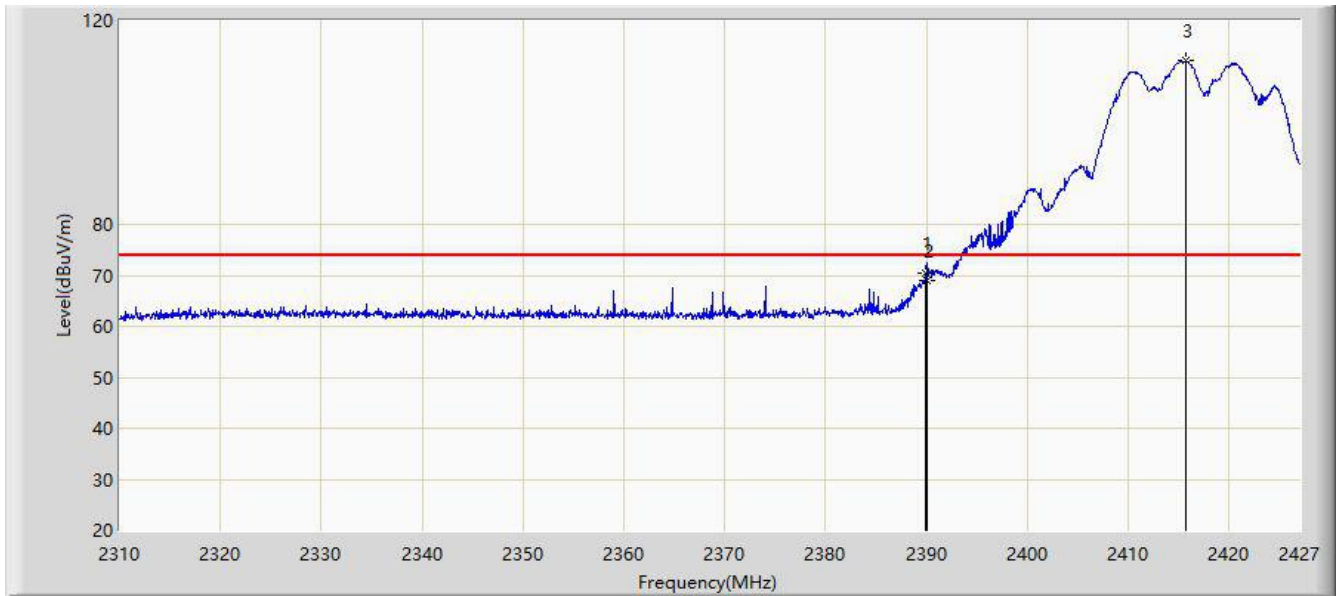

No	Flag	Mark	Frequency (MHz)	Measure Level (dBuV/m)	Reading Level (dBuV)	Margin (dB)	Limit (dBuV/m)	Factor (dB)	Type
1			2389.911	70.387	40.905	-3.613	74.000	29.482	PK
2			2390.000	69.091	39.609	-4.909	74.000	29.482	PK
3		*	2415.651	112.122	82.580	N/A	N/A	29.542	PK

Note: Measure Level (dB $\mu$ V/m) = Reading Level (dB $\mu$ V) + Factor (dB)

Factor (dB) = Cable Loss (dB) + Antenna Factor (dB/m).

Site: NS-AC1	Time: 2020/11/03 - 17:27
Limit: FCC_Part 15_15.209 RE(3m)	Engineer: Silence Liu
Probe: NS-AC1_BBHA9120D_2111	Polarity: Vertical
EUT: MESH AP Product	Power: AC 120V/60Hz
Test Mode: Transmit by 802.11g at channel 2417MHz (CDD Mode)	

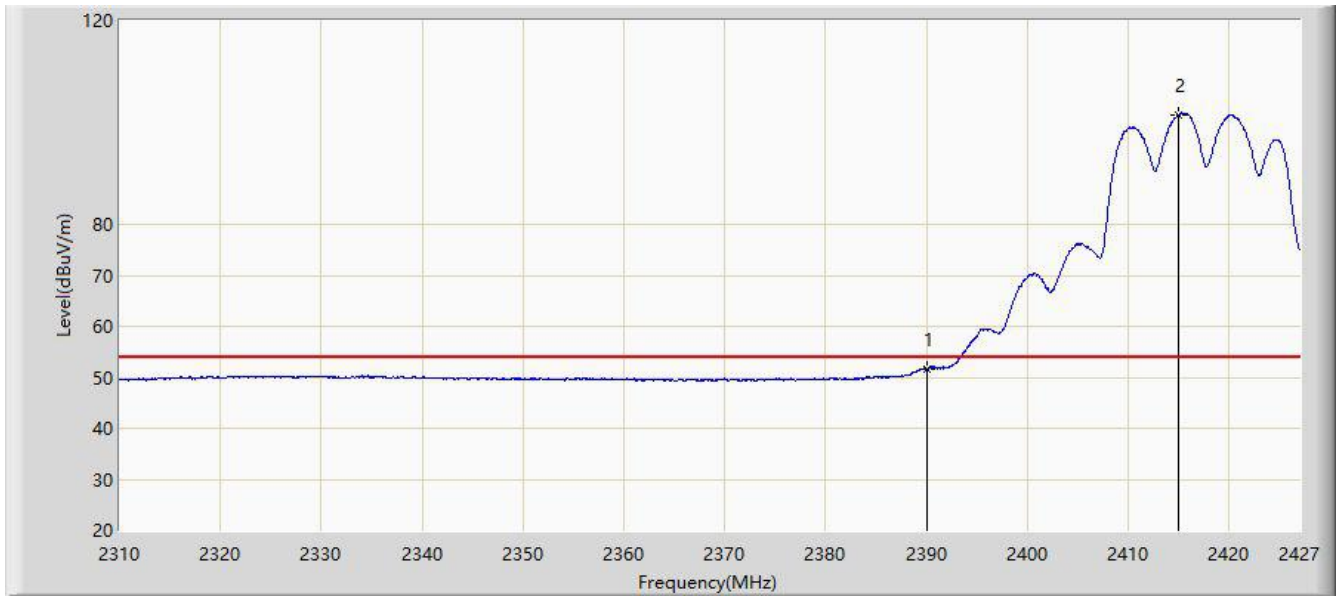

No	Flag	Mark	Frequency (MHz)	Measure Level (dBuV/m)	Reading Level (dBuV)	Margin (dB)	Limit (dBuV/m)	Factor (dB)	Type
1			2390.000	51.665	22.183	-2.335	54.000	29.482	AV
2		*	2415.008	101.530	71.988	N/A	N/A	29.542	AV

Note: Measure Level (dB $\mu$ V/m) = Reading Level (dB $\mu$ V) + Factor (dB)

Factor (dB) = Cable Loss (dB) + Antenna Factor (dB/m).

Site: NS-AC1	Time: 2020/11/03 - 17:29
Limit: FCC_Part 15_15.209 RE(3m)	Engineer: Silence Liu
Probe: NS-AC1_BBHA9120D_2111	Polarity: Horizontal
EUT: MESH AP Product	Power: AC 120V/60Hz
Test Mode: Transmit by 802.11g at channel 2437MHz (CDD Mode)	



No	Flag	Mark	Frequency (MHz)	Measure Level (dBuV/m)	Reading Level (dBuV)	Margin (dB)	Limit (dBuV/m)	Factor (dB)	Type
1			2390.000	66.189	36.707	-7.811	74.000	29.482	PK
2		*	2437.965	117.460	87.895	N/A	N/A	29.565	PK
3			2483.500	62.951	33.289	-11.049	74.000	29.662	PK
4			2483.565	64.924	35.262	-9.076	74.000	29.662	PK

Note: Measure Level (dB $\mu$ V/m) = Reading Level (dB $\mu$ V) + Factor (dB)

Factor (dB) = Cable Loss (dB) + Antenna Factor (dB/m).



Site: NS-AC1	Time: 2020/11/03 - 17:34
Limit: FCC_Part 15_15.209 RE(3m)	Engineer: Silence Liu
Probe: NS-AC1_BBHA9120D_2111	Polarity: Horizontal
EUT: MESH AP Product	Power: AC 120V/60Hz
Test Mode: Transmit by 802.11g at channel 2437MHz (CDD Mode)	

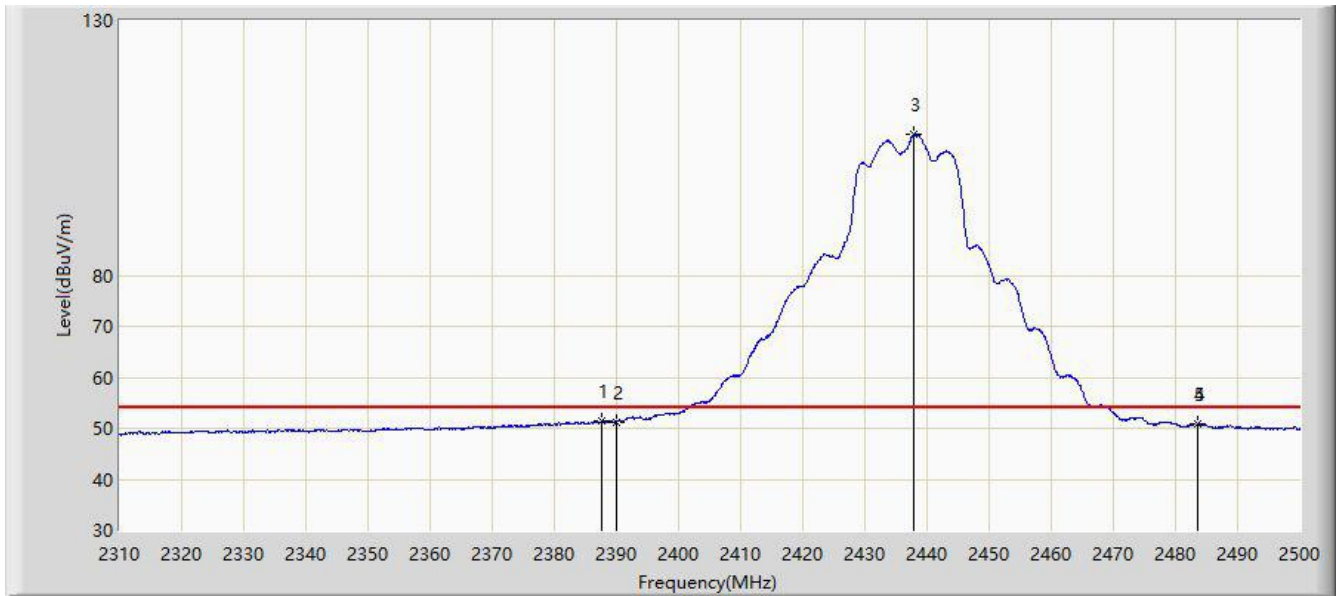

No	Flag	Mark	Frequency (MHz)	Measure Level (dBuV/m)	Reading Level (dBuV)	Margin (dB)	Limit (dBuV/m)	Factor (dB)	Type
1			2387.710	51.523	22.045	-2.477	54.000	29.479	AV
2			2390.000	51.271	21.789	-2.729	54.000	29.482	AV
3		*	2437.870	107.542	77.977	N/A	N/A	29.565	AV
4			2483.500	50.734	21.072	-3.266	54.000	29.662	AV
5			2483.660	50.926	21.264	-3.074	54.000	29.662	AV

Note: Measure Level (dBuV/m) = Reading Level (dBuV) + Factor (dB)

Factor (dB) = Cable Loss (dB) + Antenna Factor (dB/m).

Site: NS-AC1	Time: 2020/11/03 - 17:36
Limit: FCC_Part 15_15.209 RE(3m)	Engineer: Silence Liu
Probe: NS-AC1_BBHA9120D_2111	Polarity: Vertical
EUT: MESH AP Product	Power: AC 120V/60Hz
Test Mode: Transmit by 802.11g at channel 2437MHz (CDD Mode)	

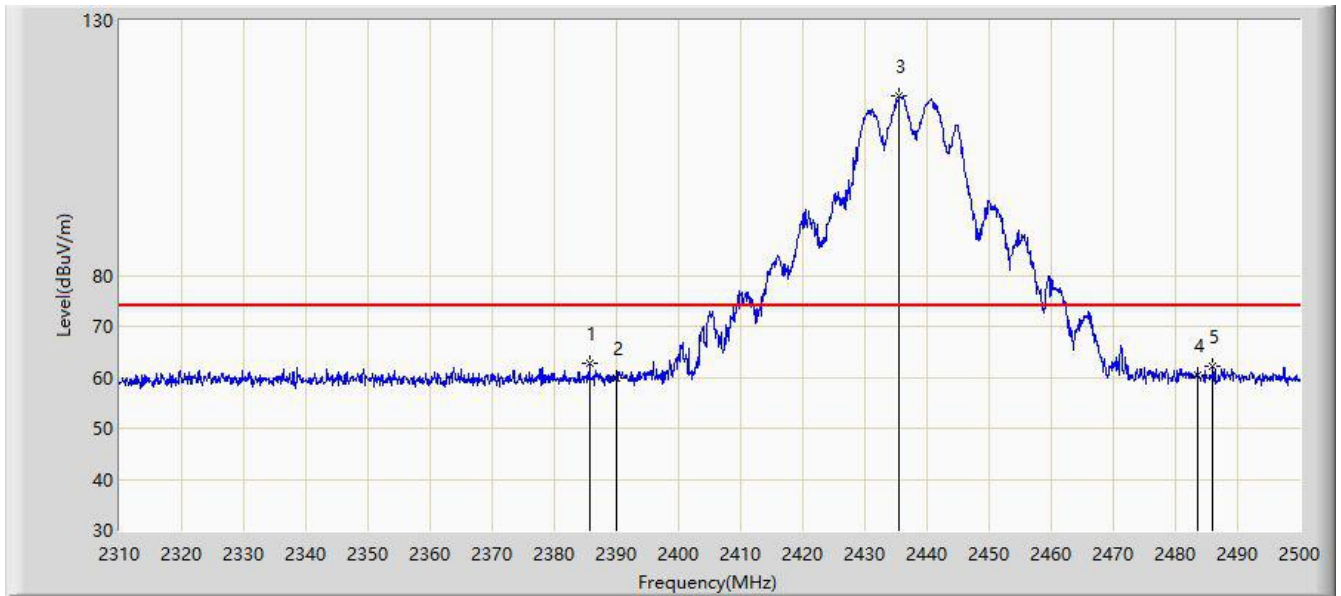

No	Flag	Mark	Frequency (MHz)	Measure Level (dBuV/m)	Reading Level (dBuV)	Margin (dB)	Limit (dBuV/m)	Factor (dB)	Type
1			2385.715	62.715	33.240	-11.285	74.000	29.476	PK
2			2390.000	59.774	30.292	-14.226	74.000	29.482	PK
3		*	2435.590	115.099	85.537	N/A	N/A	29.562	PK
4			2483.500	60.574	30.912	-13.426	74.000	29.662	PK
5			2485.940	62.235	32.573	-11.765	74.000	29.662	PK

Note: Measure Level (dBuV/m) = Reading Level (dBuV) + Factor (dB)

Factor (dB) = Cable Loss (dB) + Antenna Factor (dB/m).

Site: NS-AC1	Time: 2020/11/03 - 17:39
Limit: FCC_Part 15_15.209 RE(3m)	Engineer: Silence Liu
Probe: NS-AC1_BBHA9120D_2111	Polarity: Vertical
EUT: MESH AP Product	Power: AC 120V/60Hz
Test Mode: Transmit by 802.11g at channel 2437MHz (CDD Mode)	

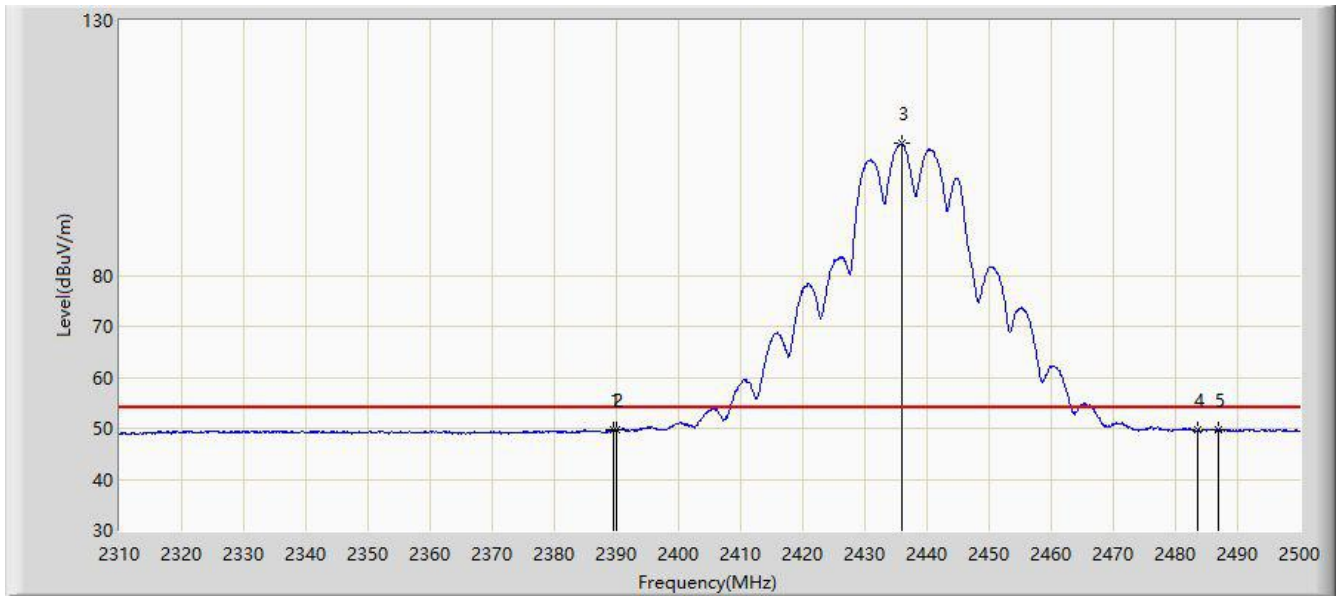

No	Flag	Mark	Frequency (MHz)	Measure Level (dBuV/m)	Reading Level (dBuV)	Margin (dB)	Limit (dBuV/m)	Factor (dB)	Type
1			2389.515	49.749	20.268	-4.251	54.000	29.482	AV
2			2390.000	49.745	20.263	-4.255	54.000	29.482	AV
3		*	2435.875	105.881	76.319	N/A	N/A	29.562	AV
4			2483.500	49.727	20.065	-4.273	54.000	29.662	AV
5			2486.985	49.821	20.158	-4.179	54.000	29.663	AV

Note: Measure Level (dBuV/m) = Reading Level (dBuV) + Factor (dB)

Factor (dB) = Cable Loss (dB) + Antenna Factor (dB/m).

Site: NS-AC1	Time: 2020/11/03 - 17:52
Limit: FCC_Part 15_15.209 RE(3m)	Engineer: Silence Liu
Probe: NS-AC1_BBHA9120D_2111	Polarity: Horizontal
EUT: MESH AP Product	Power: AC 120V/60Hz
Test Mode: Transmit by 802.11g at channel 2457MHz (CDD Mode)	

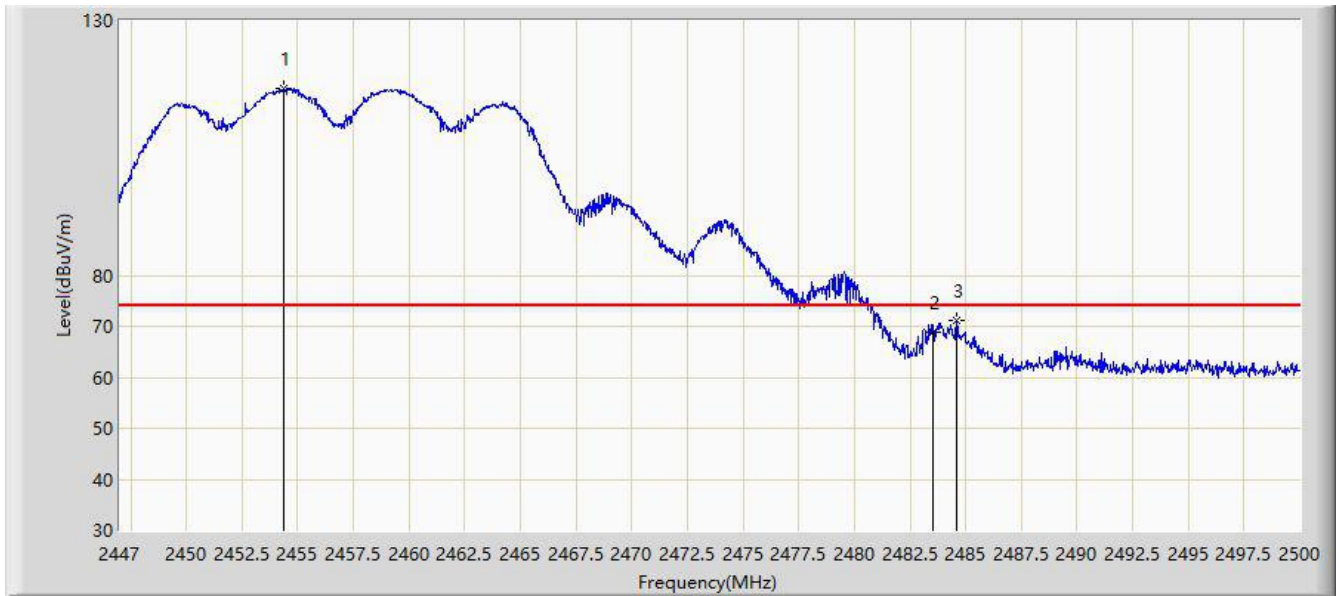

No	Flag	Mark	Frequency (MHz)	Measure Level (dBuV/m)	Reading Level (dBuV)	Margin (dB)	Limit (dBuV/m)	Factor (dB)	Type
1		*	2454.394	116.587	86.997	N/A	N/A	29.590	PK
2			2483.500	68.914	39.252	-5.086	74.000	29.662	PK
3			2484.577	71.209	41.547	-2.791	74.000	29.662	PK

Note: Measure Level (dBuV/m) = Reading Level (dBuV) + Factor (dB)

Factor (dB) = Cable Loss (dB) + Antenna Factor (dB/m).

Site: NS-AC1	Time: 2020/11/03 - 17:53
Limit: FCC_Part 15_15.209 RE(3m)	Engineer: Silence Liu
Probe: NS-AC1_BBHA9120D_2111	Polarity: Horizontal
EUT: MESH AP Product	Power: AC 120V/60Hz
Test Mode: Transmit by 802.11g at channel 2457MHz (CDD Mode)	

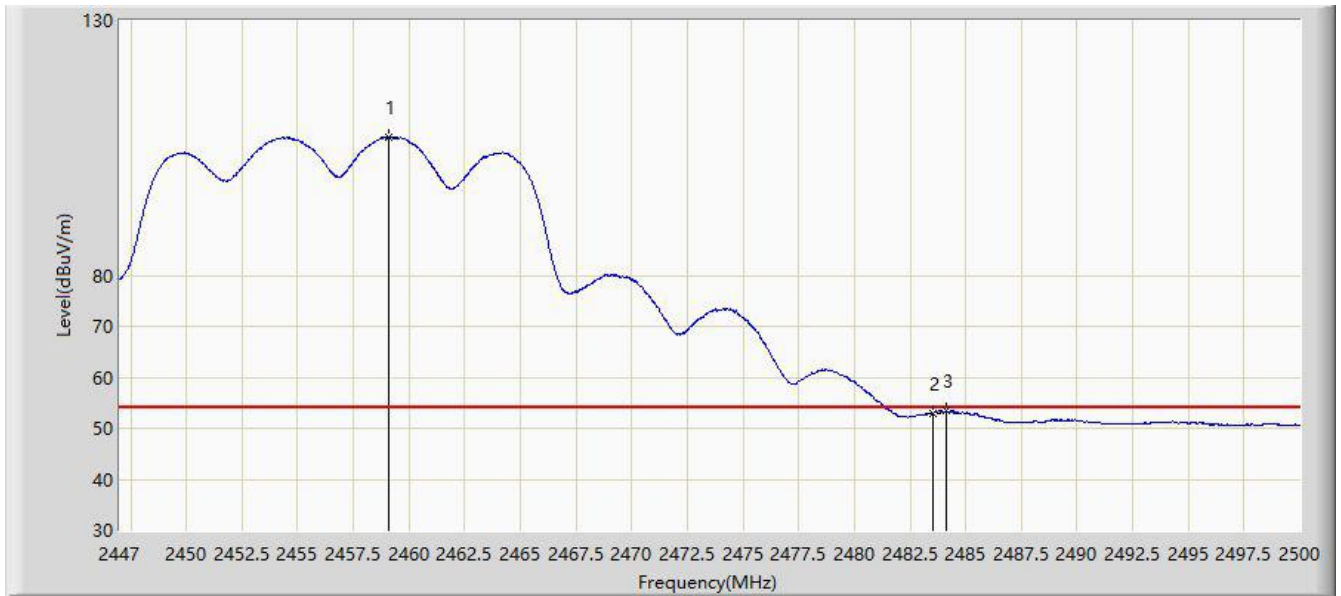

No	Flag	Mark	Frequency (MHz)	Measure Level (dBuV/m)	Reading Level (dBuV)	Margin (dB)	Limit (dBuV/m)	Factor (dB)	Type
1		*	2459.111	107.203	77.606	N/A	N/A	29.597	AV
2			2483.500	52.832	23.170	-1.168	54.000	29.662	AV
3			2484.153	53.342	23.680	-0.658	54.000	29.662	AV

Note: Measure Level (dB $\mu$ V/m) = Reading Level (dB $\mu$ V) + Factor (dB)

Factor (dB) = Cable Loss (dB) + Antenna Factor (dB/m).

Site: NS-AC1	Time: 2020/11/03 - 17:54
Limit: FCC_Part 15_15.209 RE(3m)	Engineer: Silence Liu
Probe: NS-AC1_BBHA9120D_2111	Polarity: Vertical
EUT: MESH AP Product	Power: AC 120V/60Hz
Test Mode: Transmit by 802.11g at channel 2457MHz (CDD Mode)	



No	Flag	Mark	Frequency (MHz)	Measure Level (dBuV/m)	Reading Level (dBuV)	Margin (dB)	Limit (dBuV/m)	Factor (dB)	Type
1		*	2455.745	111.119	81.527	N/A	N/A	29.592	PK
2			2483.500	61.296	31.634	-12.704	74.000	29.662	PK
3			2486.114	63.813	34.151	-10.187	74.000	29.662	PK

Note: Measure Level (dB $\mu$ V/m) = Reading Level (dB $\mu$ V) + Factor (dB)

Factor (dB) = Cable Loss (dB) + Antenna Factor (dB/m).

Site: NS-AC1	Time: 2020/11/03 - 17:57
Limit: FCC_Part 15_15.209 RE(3m)	Engineer: Silence Liu
Probe: NS-AC1_BBHA9120D_2111	Polarity: Vertical
EUT: MESH AP Product	Power: AC 120V/60Hz
Test Mode: Transmit by 802.11g at channel 2457MHz (CDD Mode)	

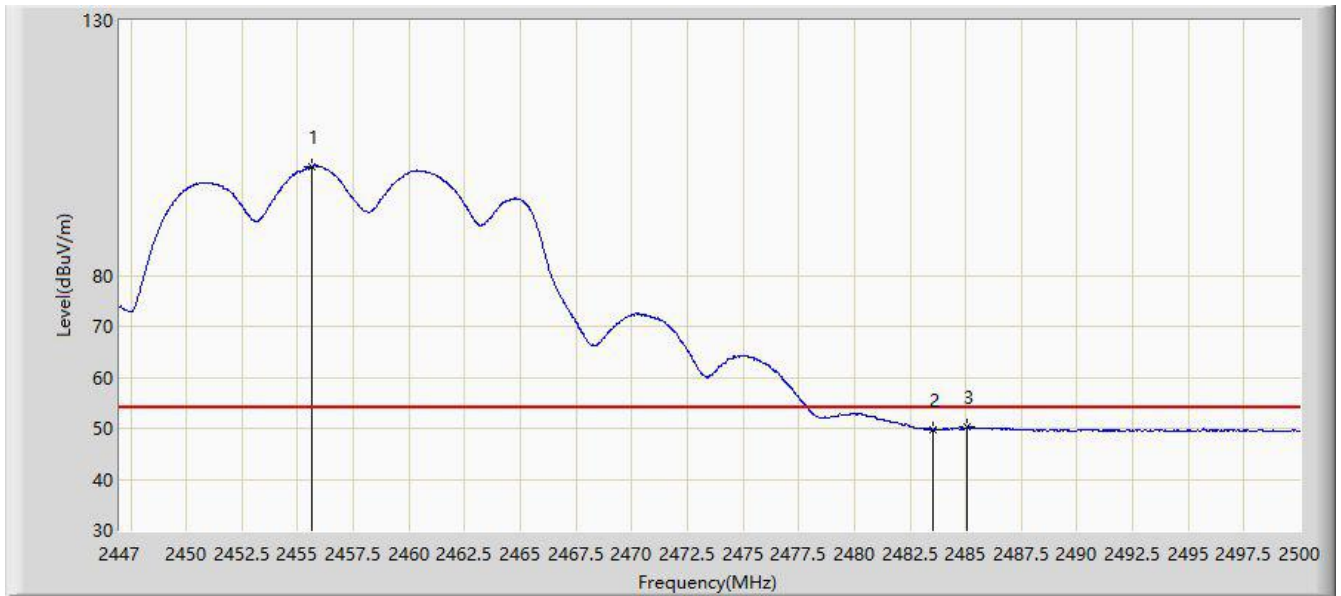

No	Flag	Mark	Frequency (MHz)	Measure Level (dBuV/m)	Reading Level (dBuV)	Margin (dB)	Limit (dBuV/m)	Factor (dB)	Type
1		*	2455.613	101.292	71.700	N/A	N/A	29.592	AV
2			2483.500	49.706	20.044	-4.294	54.000	29.662	AV
3			2485.028	50.145	20.483	-3.855	54.000	29.662	AV

Note: Measure Level (dB $\mu$ V/m) = Reading Level (dB $\mu$ V) + Factor (dB)

Factor (dB) = Cable Loss (dB) + Antenna Factor (dB/m).

Site: NS-AC1	Time: 2020/10/29 - 17:09
Limit: FCC_Part 15_15.209 RE(3m)	Engineer: Silence Liu
Probe: NS-AC1_BBHA9120D_2111	Polarity: Horizontal
EUT: MESH AP Product	Power: AC 120V/60Hz
Test Mode: Transmit by 802.11g at channel 2462MHz (CDD Mode)	

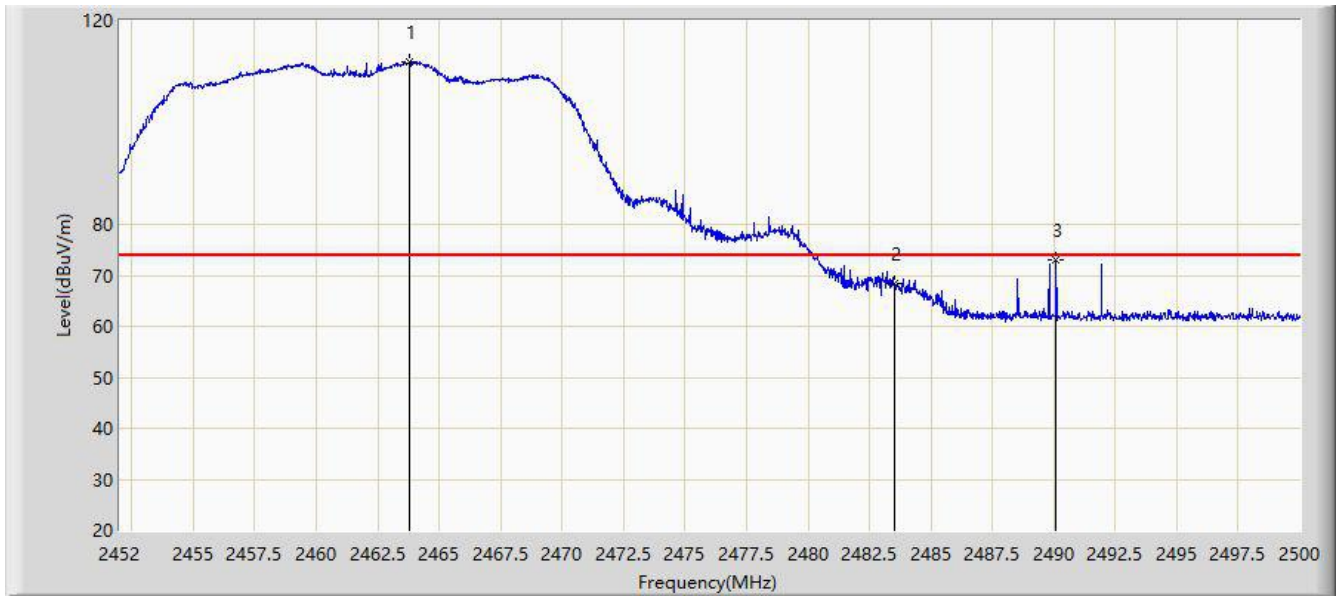

No	Flag	Mark	Frequency (MHz)	Measure Level (dBuV/m)	Reading Level (dBuV)	Margin (dB)	Limit (dBuV/m)	Factor (dB)	Type
1		*	2463.760	111.812	82.204	N/A	N/A	29.608	PK
2			2483.500	68.353	38.691	-5.647	74.000	29.662	PK
3			2490.088	73.060	43.397	-0.940	74.000	29.663	PK

Note: Measure Level (dB $\mu$ V/m) = Reading Level (dB $\mu$ V) + Factor (dB)

Factor (dB) = Cable Loss (dB) + Antenna Factor (dB/m).



Site: NS-AC1	Time: 2020/10/29 - 17:12
Limit: FCC_Part 15_15.209 RE(3m)	Engineer: Silence Liu
Probe: NS-AC1_BBHA9120D_2111	Polarity: Horizontal
EUT: MESH AP Product	Power: AC 120V/60Hz
Test Mode: Transmit by 802.11g at channel 2462MHz (CDD Mode)	

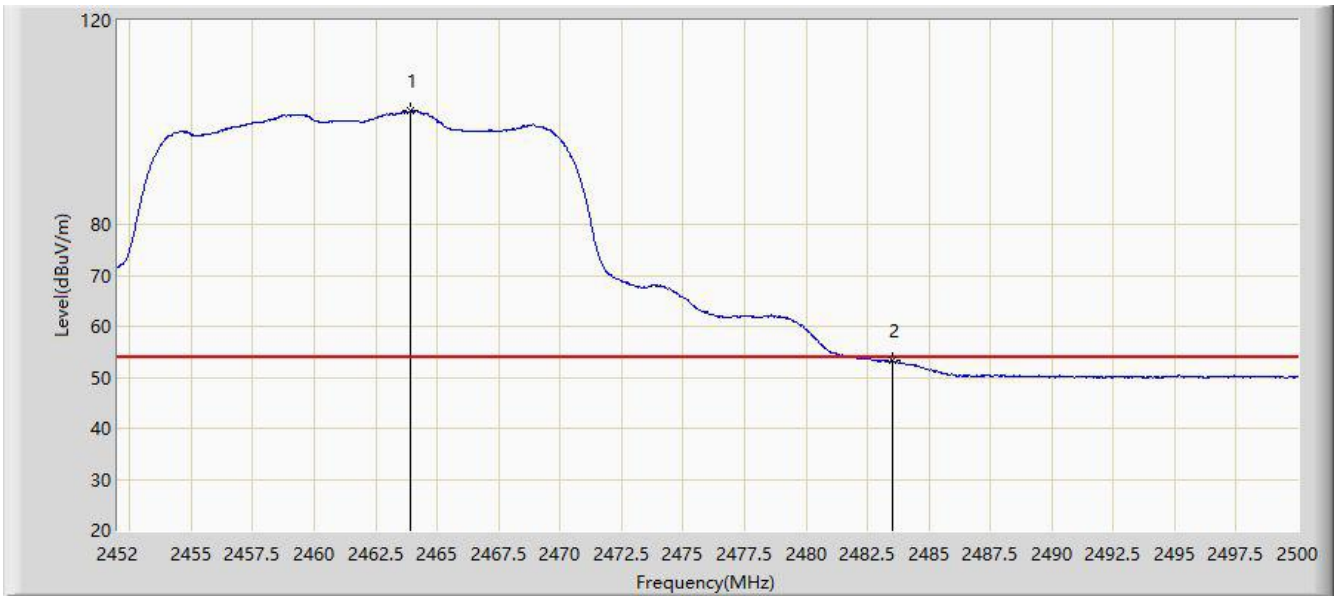

No	Flag	Mark	Frequency (MHz)	Measure Level (dBuV/m)	Reading Level (dBuV)	Margin (dB)	Limit (dBuV/m)	Factor (dB)	Type
1		*	2463.880	102.176	72.568	N/A	N/A	29.608	AV
2			2483.500	53.236	23.574	-0.764	54.000	29.662	AV

Note: Measure Level (dB $\mu$ V/m) = Reading Level (dB $\mu$ V) + Factor (dB)

Factor (dB) = Cable Loss (dB) + Antenna Factor (dB/m).

Site: NS-AC1	Time: 2020/10/29 - 17:15
Limit: FCC_Part 15_15.209 RE(3m)	Engineer: Silence Liu
Probe: NS-AC1_BBHA9120D_2111	Polarity: Vertical
EUT: MESH AP Product	Power: AC 120V/60Hz
Test Mode: Transmit by 802.11g at channel 2462MHz (CDD Mode)	

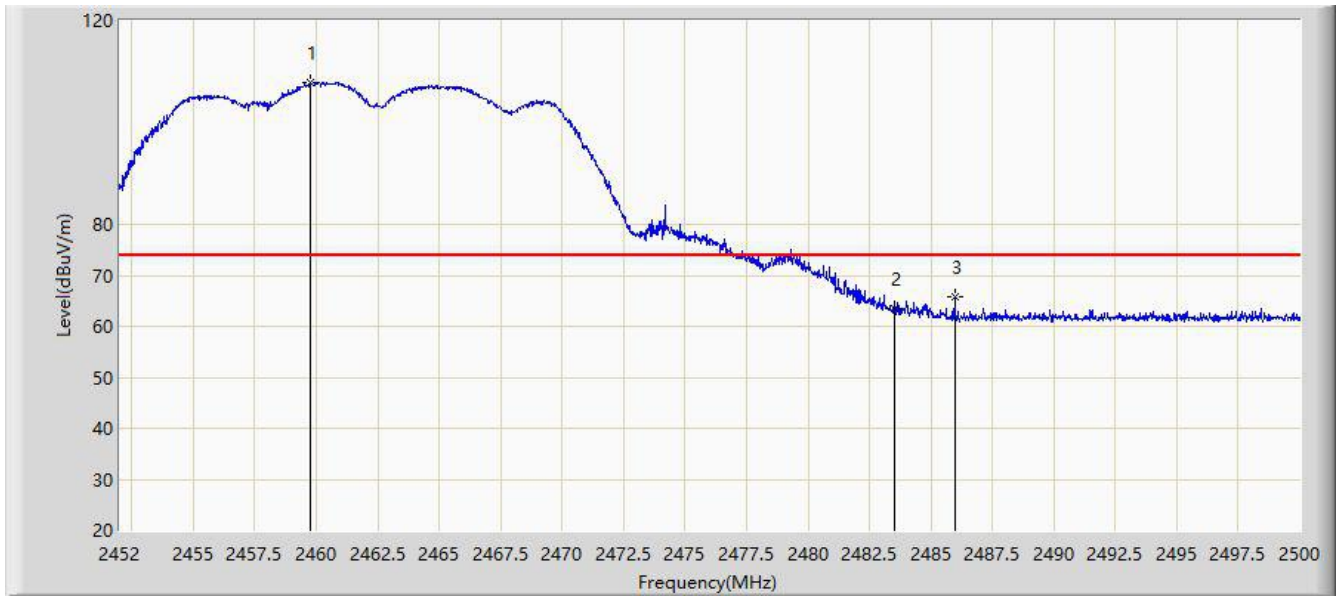

No	Flag	Mark	Frequency (MHz)	Measure Level (dBuV/m)	Reading Level (dBuV)	Margin (dB)	Limit (dBuV/m)	Factor (dB)	Type
1		*	2459.776	107.797	78.199	N/A	N/A	29.598	PK
2			2483.500	63.507	33.845	-10.493	74.000	29.662	PK
3			2485.960	65.657	35.995	-8.343	74.000	29.662	PK

Note: Measure Level (dB $\mu$ V/m) = Reading Level (dB $\mu$ V) + Factor (dB)

Factor (dB) = Cable Loss (dB) + Antenna Factor (dB/m).

Site: NS-AC1	Time: 2020/10/29 - 17:17
Limit: FCC_Part 15_15.209 RE(3m)	Engineer: Silence Liu
Probe: NS-AC1_BBHA9120D_2111	Polarity: Vertical
EUT: MESH AP Product	Power: AC 120V/60Hz
Test Mode: Transmit by 802.11g at channel 2462MHz (CDD Mode)	

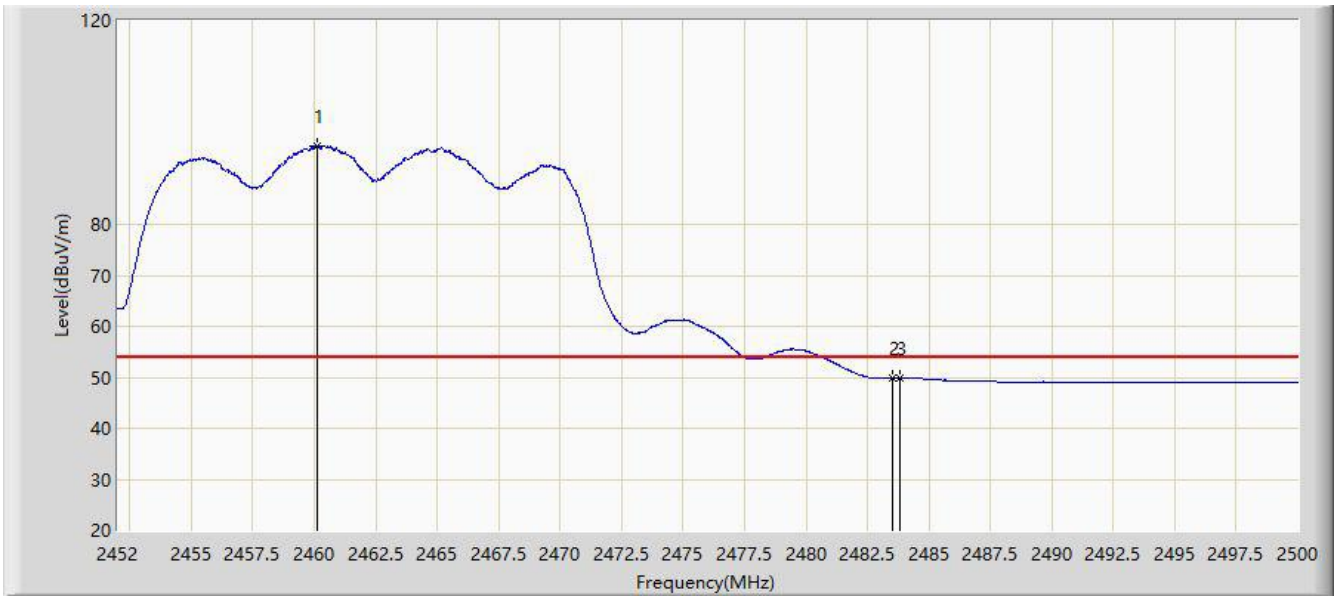

No	Flag	Mark	Frequency (MHz)	Measure Level (dBuV/m)	Reading Level (dBuV)	Margin (dB)	Limit (dBuV/m)	Factor (dB)	Type
1		*	2460.112	95.403	65.804	N/A	N/A	29.599	AV
2			2483.500	49.774	20.112	-4.226	54.000	29.662	AV
3			2483.800	49.807	20.145	-4.193	54.000	29.662	AV

Note: Measure Level (dB $\mu$ V/m) = Reading Level (dB $\mu$ V) + Factor (dB)

Factor (dB) = Cable Loss (dB) + Antenna Factor (dB/m).

Site: NS-AC1	Time: 2020/10/29 - 18:05
Limit: FCC_Part 15_15.209 RE(3m)	Engineer: Silence Liu
Probe: NS-AC1_BBHA9120D_2111	Polarity: Horizontal
EUT: MESH AP Product	Power: AC 120V/60Hz
Test Mode: Transmit by 802.11n-HT20 at channel 2412MHz (CDD Mode)	

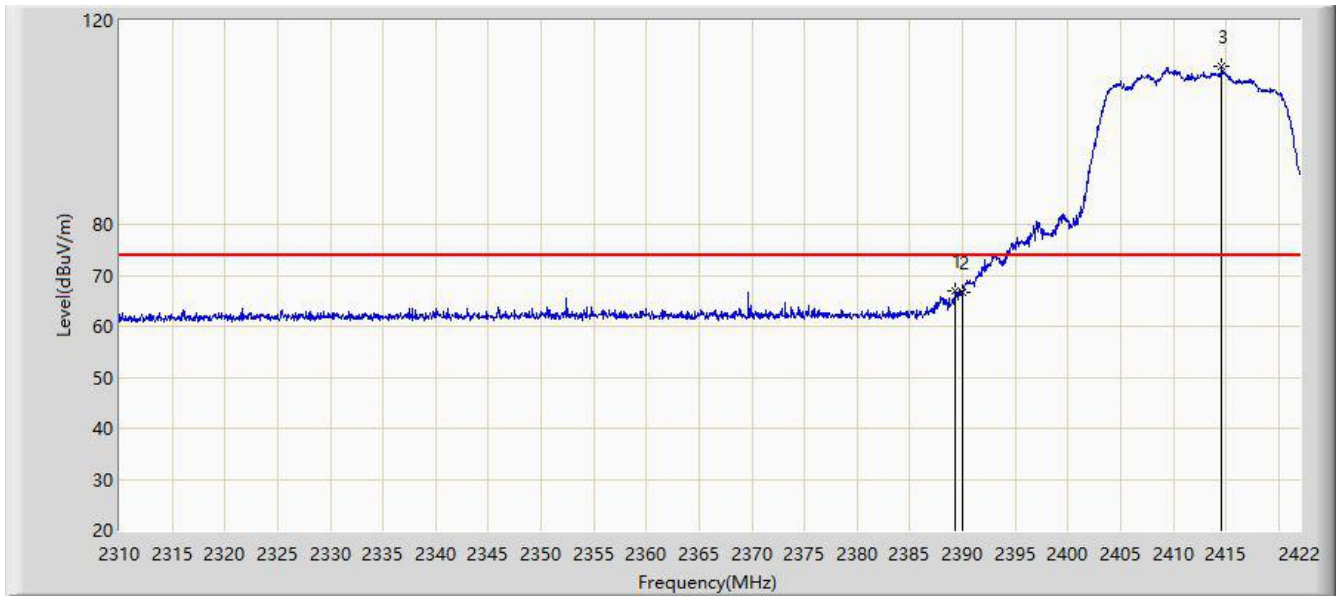

No	Flag	Mark	Frequency (MHz)	Measure Level (dBuV/m)	Reading Level (dBuV)	Margin (dB)	Limit (dBuV/m)	Factor (dB)	Type
1			2389.240	66.874	37.393	-7.126	74.000	29.481	PK
2			2390.000	66.665	37.183	-7.335	74.000	29.482	PK
3		*	2414.608	110.935	81.394	N/A	N/A	29.542	PK

Note: Measure Level (dB $\mu$ V/m) = Reading Level (dB $\mu$ V) + Factor (dB)

Factor (dB) = Cable Loss (dB) + Antenna Factor (dB/m).

Site: NS-AC1	Time: 2020/10/29 - 18:08
Limit: FCC_Part 15_15.209 RE(3m)	Engineer: Silence Liu
Probe: NS-AC1_BBHA9120D_2111	Polarity: Horizontal
EUT: MESH AP Product	Power: AC 120V/60Hz
Test Mode: Transmit by 802.11n-HT20 at channel 2412MHz (CDD Mode)	

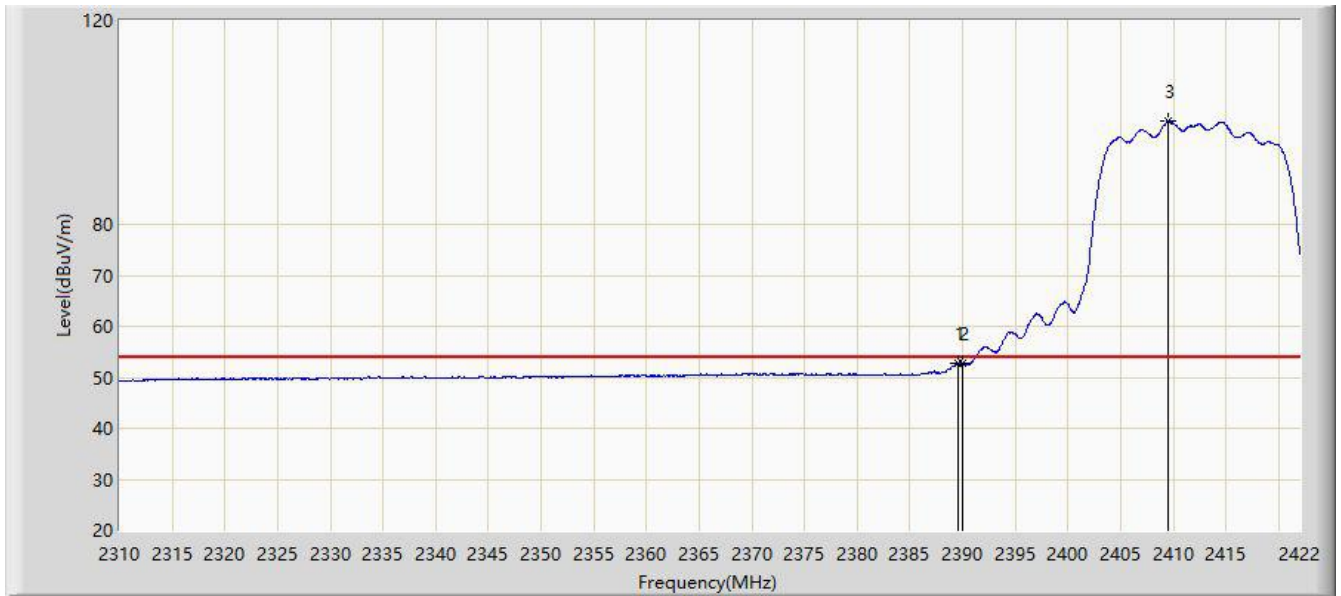

No	Flag	Mark	Frequency (MHz)	Measure Level (dBuV/m)	Reading Level (dBuV)	Margin (dB)	Limit (dBuV/m)	Factor (dB)	Type
1			2389.632	52.831	23.349	-1.169	54.000	29.482	AV
2			2390.000	52.622	23.140	-1.378	54.000	29.482	AV
3		*	2409.456	100.347	70.812	N/A	N/A	29.534	AV

Note: Measure Level (dB $\mu$ V/m) = Reading Level (dB $\mu$ V) + Factor (dB)

Factor (dB) = Cable Loss (dB) + Antenna Factor (dB/m).

Site: NS-AC1	Time: 2020/10/29 - 18:10
Limit: FCC_Part 15_15.209 RE(3m)	Engineer: Silence Liu
Probe: NS-AC1_BBHA9120D_2111	Polarity: Vertical
EUT: MESH AP Product	Power: AC 120V/60Hz
Test Mode: Transmit by 802.11n-HT20 at channel 2412MHz (CDD Mode)	

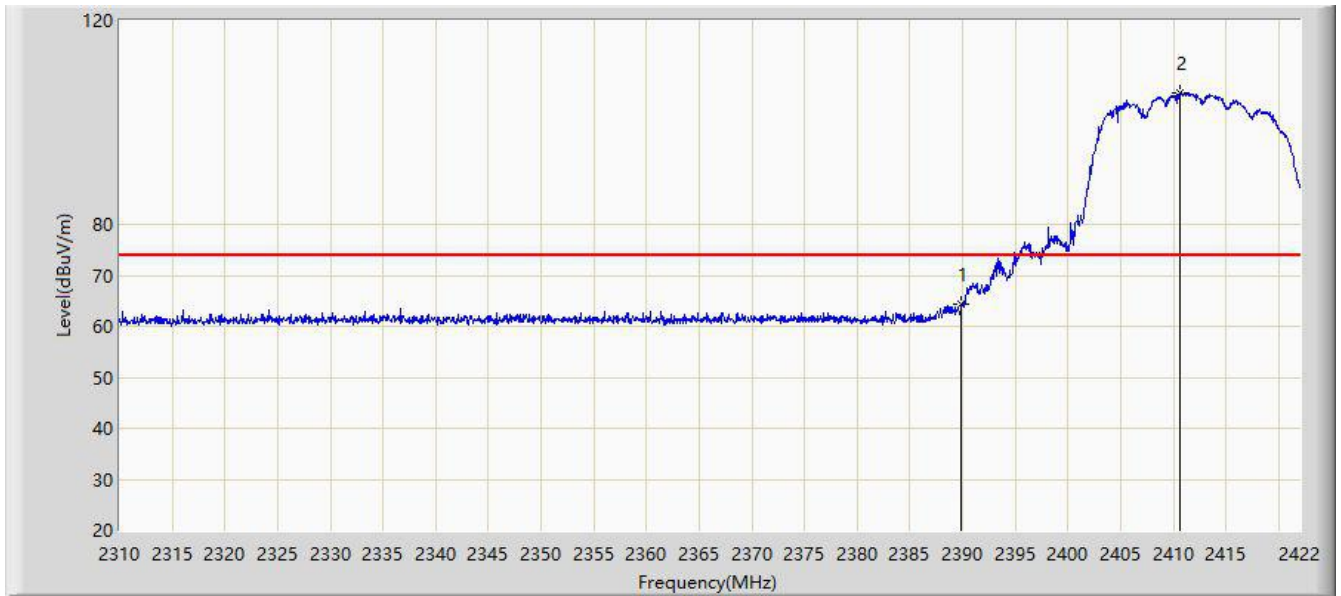

No	Flag	Mark	Frequency (MHz)	Measure Level (dBuV/m)	Reading Level (dBuV)	Margin (dB)	Limit (dBuV/m)	Factor (dB)	Type
1			2389.856	64.418	34.936	-9.582	74.000	29.482	PK
2		*	2410.632	105.871	76.333	N/A	N/A	29.538	PK

Note: Measure Level (dB $\mu$ V/m) = Reading Level (dB $\mu$ V) + Factor (dB)

Factor (dB) = Cable Loss (dB) + Antenna Factor (dB/m).

Site: NS-AC1	Time: 2020/10/29 - 18:12
Limit: FCC_Part 15_15.209 RE(3m)	Engineer: Silence Liu
Probe: NS-AC1_BBHA9120D_2111	Polarity: Vertical
EUT: MESH AP Product	Power: AC 120V/60Hz
Test Mode: Transmit by 802.11n-HT20 at channel 2412MHz (CDD Mode)	

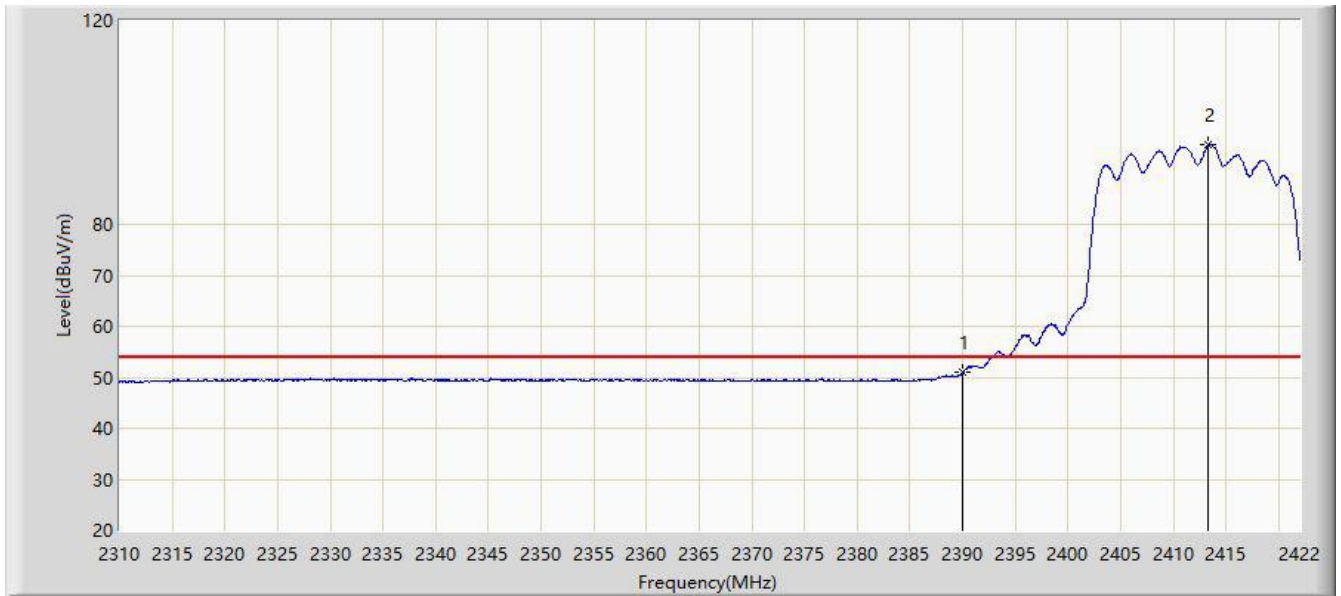

No	Flag	Mark	Frequency (MHz)	Measure Level (dBuV/m)	Reading Level (dBuV)	Margin (dB)	Limit (dBuV/m)	Factor (dB)	Type
1			2390.000	50.952	21.470	-3.048	54.000	29.482	AV
2		*	2413.320	95.721	66.180	N/A	N/A	29.540	AV

Note: Measure Level (dB $\mu$ V/m) = Reading Level (dB $\mu$ V) + Factor (dB)

Factor (dB) = Cable Loss (dB) + Antenna Factor (dB/m).

Site: NS-AC1	Time: 2020/11/03 - 18:11
Limit: FCC_Part 15_15.209 RE(3m)	Engineer: Silence Liu
Probe: NS-AC1_BBHA9120D_2111	Polarity: Horizontal
EUT: MESH AP Product	Power: AC 120V/60Hz
Test Mode: Transmit by 802.11n-HT20 at channel 2417MHz (CDD Mode)	

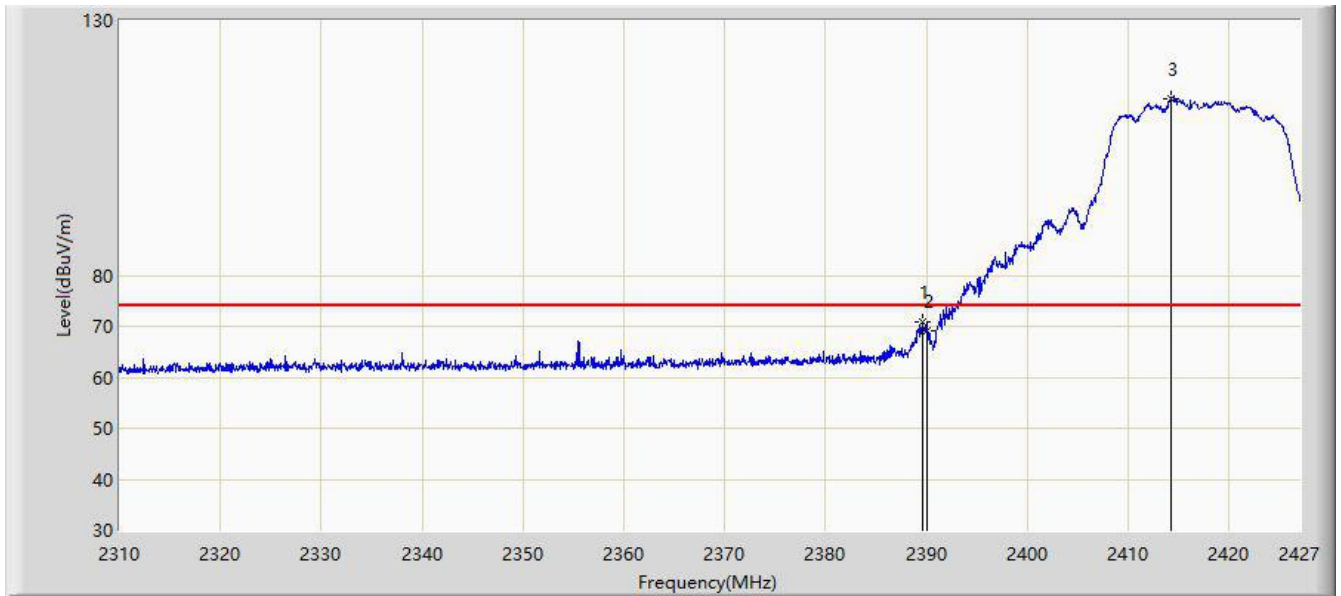

No	Flag	Mark	Frequency (MHz)	Measure Level (dBuV/m)	Reading Level (dBuV)	Margin (dB)	Limit (dBuV/m)	Factor (dB)	Type
1			2389.618	70.924	41.443	-3.076	74.000	29.482	PK
2			2390.000	69.252	39.770	-4.748	74.000	29.482	PK
3		*	2414.247	114.669	85.128	N/A	N/A	29.541	PK

Note: Measure Level (dB $\mu$ V/m) = Reading Level (dB $\mu$ V) + Factor (dB)

Factor (dB) = Cable Loss (dB) + Antenna Factor (dB/m).



Site: NS-AC1	Time: 2020/11/03 - 18:10
Limit: FCC_Part 15_15.209 RE(3m)	Engineer: Silence Liu
Probe: NS-AC1_BBHA9120D_2111	Polarity: Horizontal
EUT: MESH AP Product	Power: AC 120V/60Hz
Test Mode: Transmit by 802.11n-HT20 at channel 2417MHz (CDD Mode)	

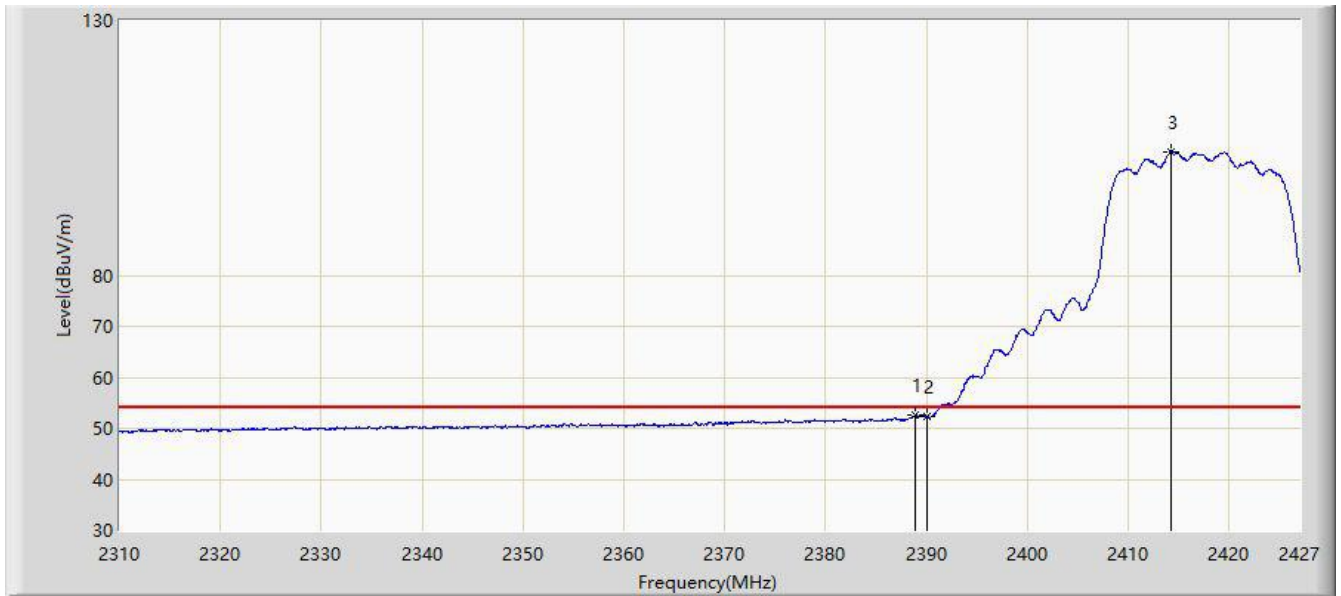

No	Flag	Mark	Frequency (MHz)	Measure Level (dBuV/m)	Reading Level (dBuV)	Margin (dB)	Limit (dBuV/m)	Factor (dB)	Type
1			2388.917	52.686	23.206	-1.314	54.000	29.480	AV
2			2390.000	52.174	22.692	-1.826	54.000	29.482	AV
3		*	2414.305	104.114	74.573	N/A	N/A	29.541	AV

Note: Measure Level (dB $\mu$ V/m) = Reading Level (dB $\mu$ V) + Factor (dB)

Factor (dB) = Cable Loss (dB) + Antenna Factor (dB/m).

Site: NS-AC1	Time: 2020/11/03 - 18:12
Limit: FCC_Part 15_15.209 RE(3m)	Engineer: Silence Liu
Probe: NS-AC1_BBHA9120D_2111	Polarity: Vertical
EUT: MESH AP Product	Power: AC 120V/60Hz
TestMode: Transmit by 802.11n-HT20 at channel 2417MHz (CDD Mode)	

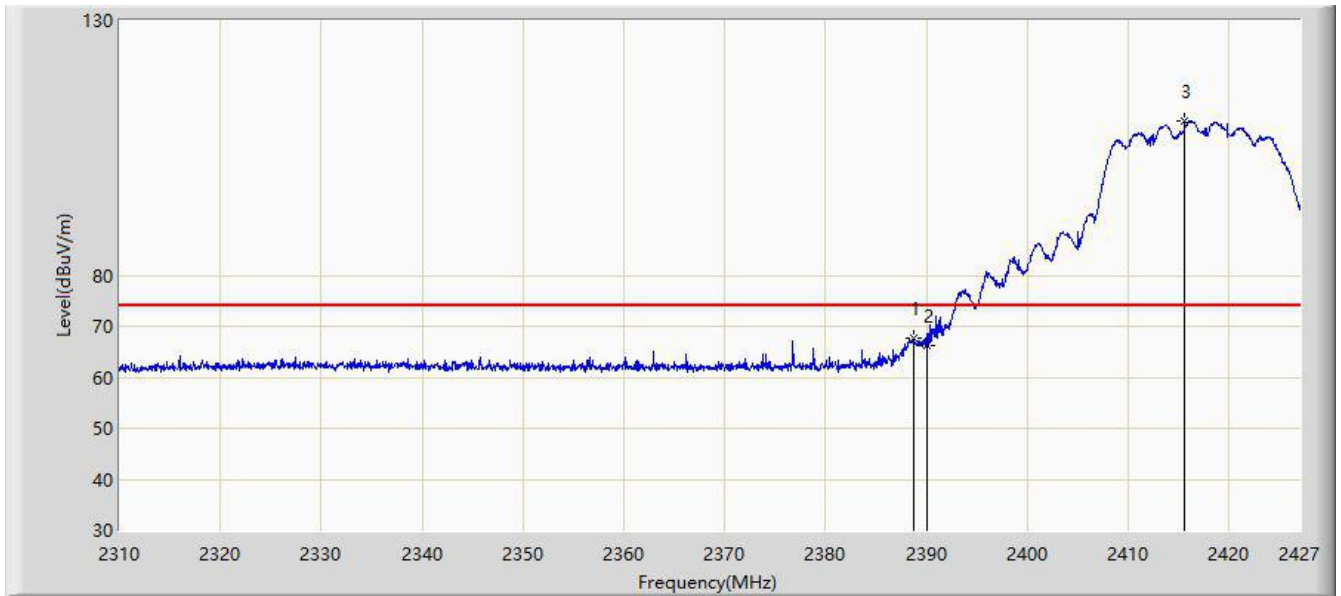

No	Flag	Mark	Frequency (MHz)	Measure Level (dBuV/m)	Reading Level (dBuV)	Margin (dB)	Limit (dBuV/m)	Factor (dB)	Type
1			2388.800	67.809	38.329	-6.191	74.000	29.480	PK
2			2390.000	66.203	36.721	-7.797	74.000	29.482	PK
3		*	2415.593	110.325	80.783	N/A	N/A	29.542	PK

Note: Measure Level (dB $\mu$ V/m) = Reading Level (dB $\mu$ V) + Factor (dB)

Factor (dB) = Cable Loss (dB) + Antenna Factor (dB/m).

Site: NS-AC1	Time: 2020/11/03 - 18:15
Limit: FCC_Part 15_15.209 RE(3m)	Engineer: Silence Liu
Probe: NS-AC1_BBHA9120D_2111	Polarity: Vertical
EUT: MESH AP Product	Power: AC 120V/60Hz
TestMode: Transmit by 802.11n-HT20 at channel 2417MHz (CDD Mode)	

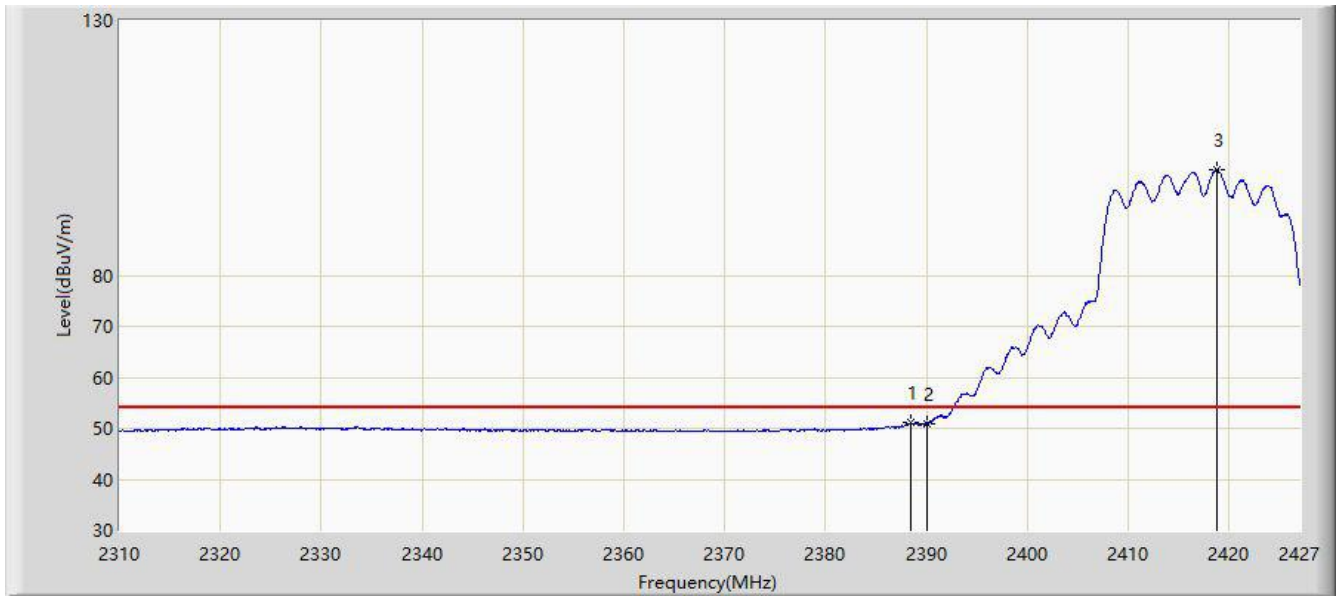

No	Flag	Mark	Frequency (MHz)	Measure Level (dBuV/m)	Reading Level (dBuV)	Margin (dB)	Limit (dBuV/m)	Factor (dB)	Type
1			2388.448	51.028	21.548	-2.972	54.000	29.479	AV
2			2390.000	50.949	21.467	-3.051	54.000	29.482	AV
3		*	2418.751	100.738	71.194	N/A	N/A	29.544	AV

Note: Measure Level (dB $\mu$ V/m) = Reading Level (dB $\mu$ V) + Factor (dB)

Factor (dB) = Cable Loss (dB) + Antenna Factor (dB/m).

Site: NS-AC1	Time: 2020/11/03 - 18:16
Limit: FCC_Part 15_15.209 RE(3m)	Engineer: Silence Liu
Probe: NS-AC1_BBHA9120D_2111	Polarity: Horizontal
EUT: MESH AP Product	Power: AC 120V/60Hz
Test Mode: Transmit by 802.11n-HT20 at channel 2437MHz (CDD Mode)	

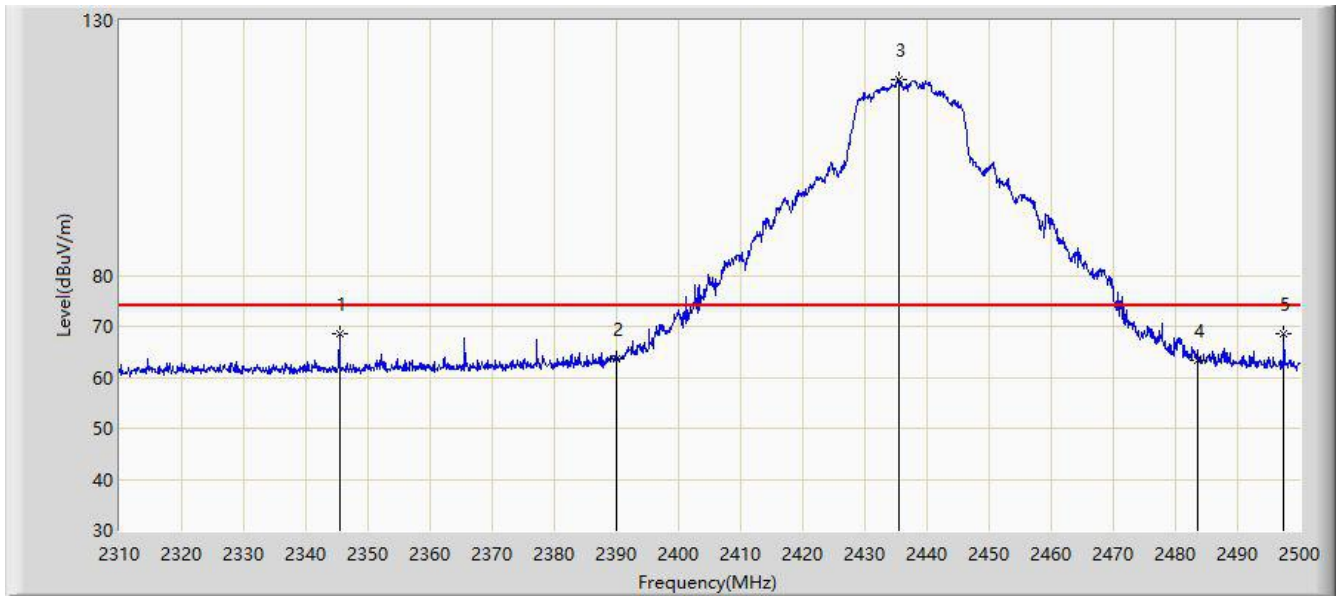

No	Flag	Mark	Frequency (MHz)	Measure Level (dBuV/m)	Reading Level (dBuV)	Margin (dB)	Limit (dBuV/m)	Factor (dB)	Type
1			2345.435	68.476	39.072	-5.524	74.000	29.403	PK
2			2390.000	63.515	34.033	-10.485	74.000	29.482	PK
3		*	2435.495	118.358	88.797	N/A	N/A	29.561	PK
4			2483.500	63.294	33.632	-10.706	74.000	29.662	PK
5			2497.435	68.668	38.998	-5.332	74.000	29.670	PK

Note: Measure Level (dBuV/m) = Reading Level (dBuV) + Factor (dB)

Factor (dB) = Cable Loss (dB) + Antenna Factor (dB/m).

Site: NS-AC1	Time: 2020/11/03 - 18:20
Limit: FCC_Part 15_15.209 RE(3m)	Engineer: Silence Liu
Probe: NS-AC1_BBHA9120D_2111	Polarity: Horizontal
EUT: MESH AP Product	Power: AC 120V/60Hz
Test Mode: Transmit by 802.11n-HT20 at channel 2437MHz (CDD Mode)	

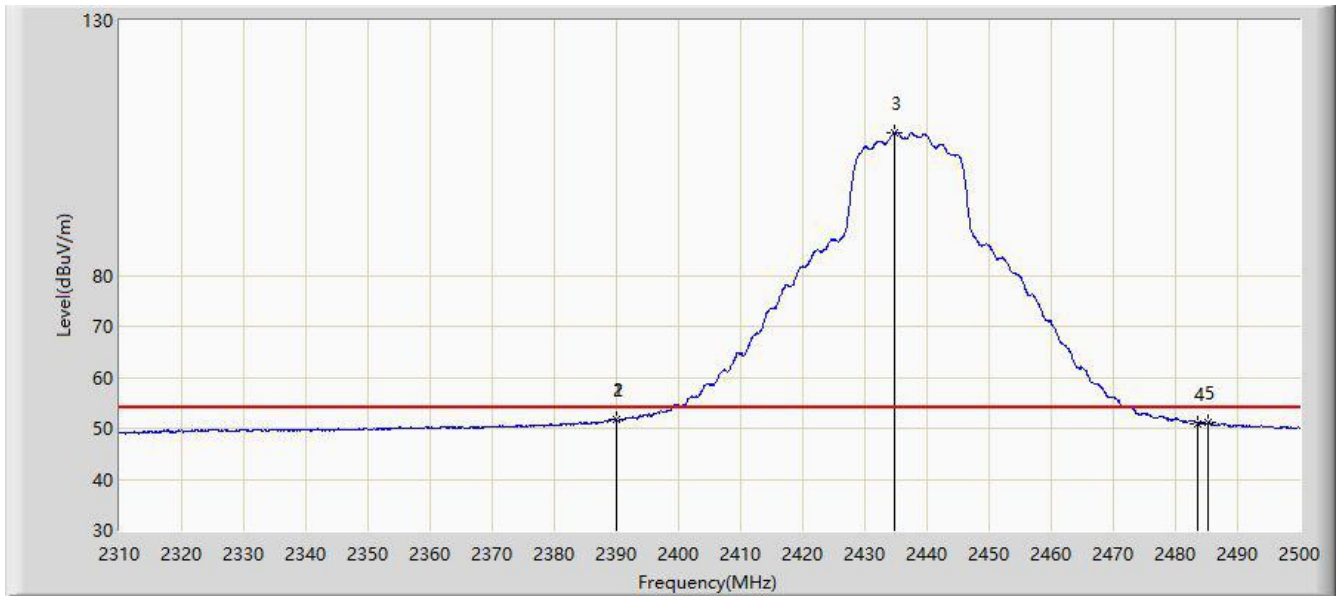

No	Flag	Mark	Frequency (MHz)	Measure Level (dBuV/m)	Reading Level (dBuV)	Margin (dB)	Limit (dBuV/m)	Factor (dB)	Type
1			2389.895	51.787	22.305	-2.213	54.000	29.482	AV
2			2390.000	51.672	22.190	-2.328	54.000	29.482	AV
3		*	2434.735	107.992	78.432	N/A	N/A	29.560	AV
4			2483.500	50.960	21.298	-3.040	54.000	29.662	AV
5			2485.275	51.103	21.441	-2.897	54.000	29.662	AV

Note: Measure Level (dB $\mu$ V/m) = Reading Level (dB $\mu$ V) + Factor (dB)

Factor (dB) = Cable Loss (dB) + Antenna Factor (dB/m).

Site: NS-AC1	Time: 2020/11/03 - 18:24
Limit: FCC_Part 15_15.209 RE(3m)	Engineer: Silence Liu
Probe: NS-AC1_BBHA9120D_2111	Polarity: Vertical
EUT: MESH AP Product	Power: AC 120V/60Hz
Test Mode: Transmit by 802.11n-HT20 at channel 2437MHz (CDD Mode)	

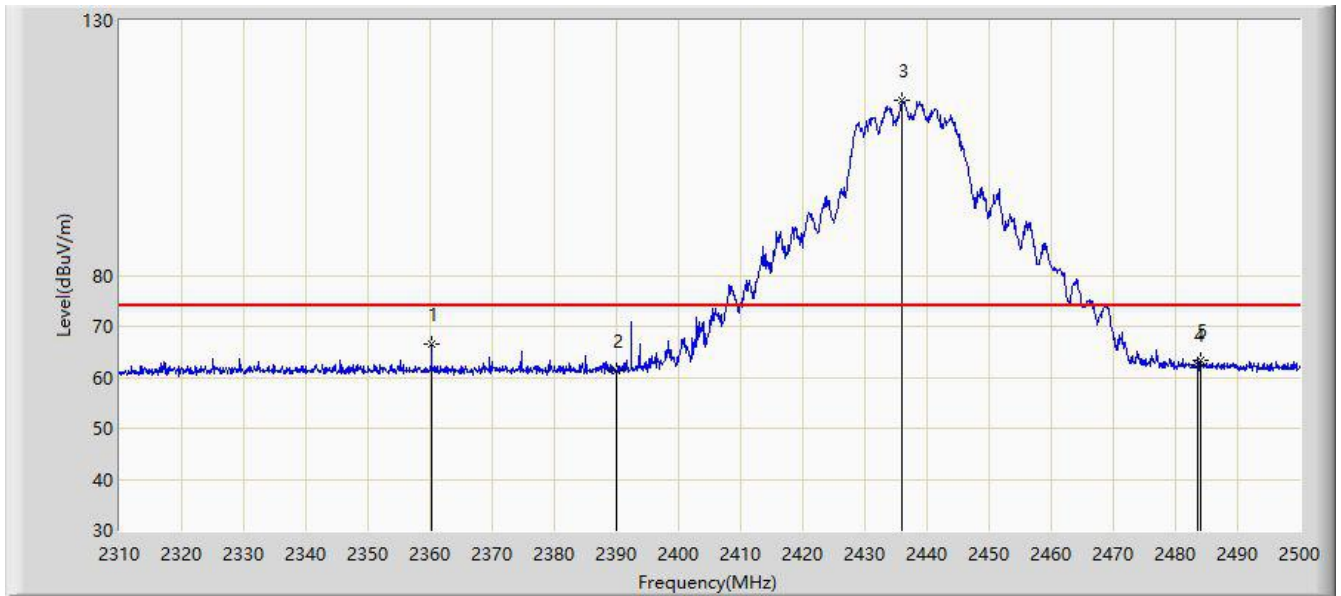

No	Flag	Mark	Frequency (MHz)	Measure Level (dBuV/m)	Reading Level (dBuV)	Margin (dB)	Limit (dBuV/m)	Factor (dB)	Type
1			2360.255	66.550	37.123	-7.450	74.000	29.426	PK
2			2390.000	61.302	31.820	-12.698	74.000	29.482	PK
3		*	2436.065	114.252	84.690	N/A	N/A	29.562	PK
4			2483.500	62.579	32.917	-11.421	74.000	29.662	PK
5			2483.945	63.395	33.733	-10.605	74.000	29.662	PK

Note: Measure Level (dBuV/m) = Reading Level (dBuV) + Factor (dB)

Factor (dB) = Cable Loss (dB) + Antenna Factor (dB/m).

Site: NS-AC1	Time: 2020/11/03 - 18:26
Limit: FCC_Part 15_15.209 RE(3m)	Engineer: Silence Liu
Probe: NS-AC1_BBHA9120D_2111	Polarity: Vertical
EUT: MESH AP Product	Power: AC 120V/60Hz
Test Mode: Transmit by 802.11n-HT20 at channel 2437MHz (CDD Mode)	

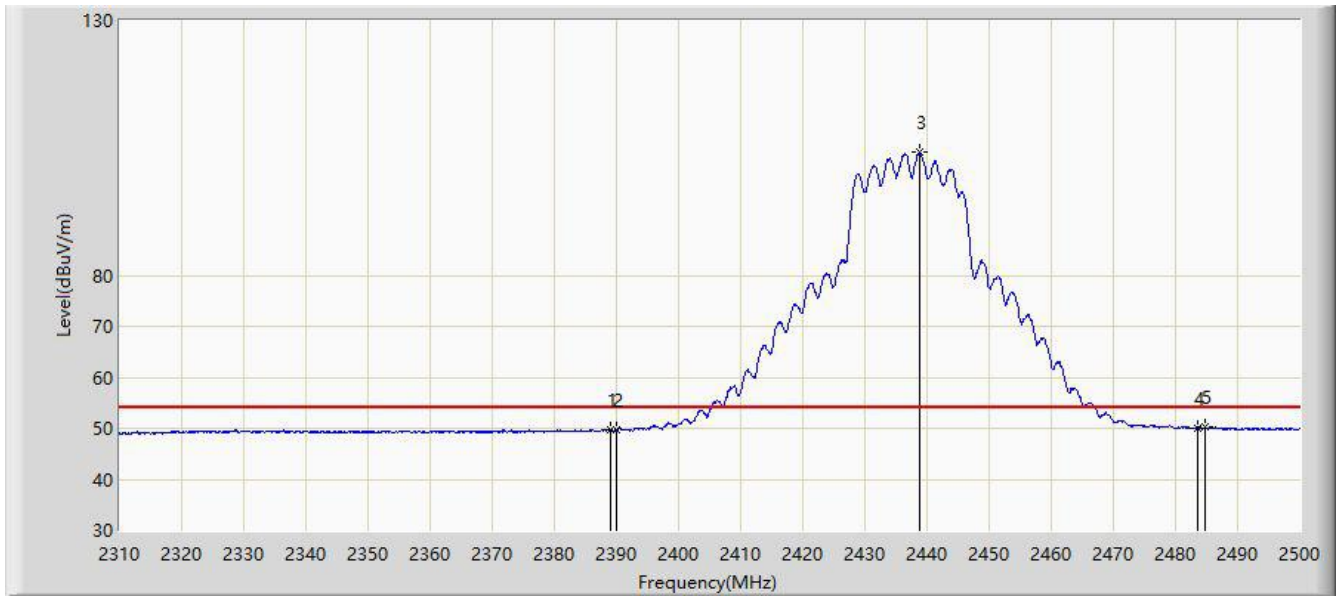

No	Flag	Mark	Frequency (MHz)	Measure Level (dBuV/m)	Reading Level (dBuV)	Margin (dB)	Limit (dBuV/m)	Factor (dB)	Type
1			2389.040	49.777	20.296	-4.223	54.000	29.481	AV
2			2390.000	49.570	20.088	-4.430	54.000	29.482	AV
3		*	2438.725	104.085	74.519	N/A	N/A	29.567	AV
4			2483.500	50.101	20.439	-3.899	54.000	29.662	AV
5			2484.705	50.331	20.669	-3.669	54.000	29.662	AV

Note: Measure Level (dB $\mu$ V/m) = Reading Level (dB $\mu$ V) + Factor (dB)

Factor (dB) = Cable Loss (dB) + Antenna Factor (dB/m).

Site: NS-AC1	Time: 2020/11/03 - 18:37
Limit: FCC_Part 15_15.209 RE(3m)	Engineer: Silence Liu
Probe: NS-AC1_BBHA9120D_2111	Polarity: Horizontal
EUT: MESH AP Product	Power: AC 120V/60Hz
Test Mode: Transmit by 802.11n-HT20 at channel 2457MHz (CDD Mode)	



No	Flag	Mark	Frequency (MHz)	Measure Level (dBuV/m)	Reading Level (dBuV)	Margin (dB)	Limit (dBuV/m)	Factor (dB)	Type
1		*	2457.547	115.536	85.941	N/A	N/A	29.595	PK
2			2483.500	69.786	40.124	-4.214	74.000	29.662	PK
3			2485.292	72.993	43.331	-1.007	74.000	29.662	PK

Note: Measure Level (dB $\mu$ V/m) = Reading Level (dB $\mu$ V) + Factor (dB)

Factor (dB) = Cable Loss (dB) + Antenna Factor (dB/m).



Site: NS-AC1	Time: 2020/11/03 - 18:36
Limit: FCC_Part 15_15.209 RE(3m)	Engineer: Silence Liu
Probe: NS-AC1_BBHA9120D_2111	Polarity: Horizontal
EUT: MESH AP Product	Power: AC 120V/60Hz
Test Mode: Transmit by 802.11n-HT20 at channel 2457MHz (CDD Mode)	

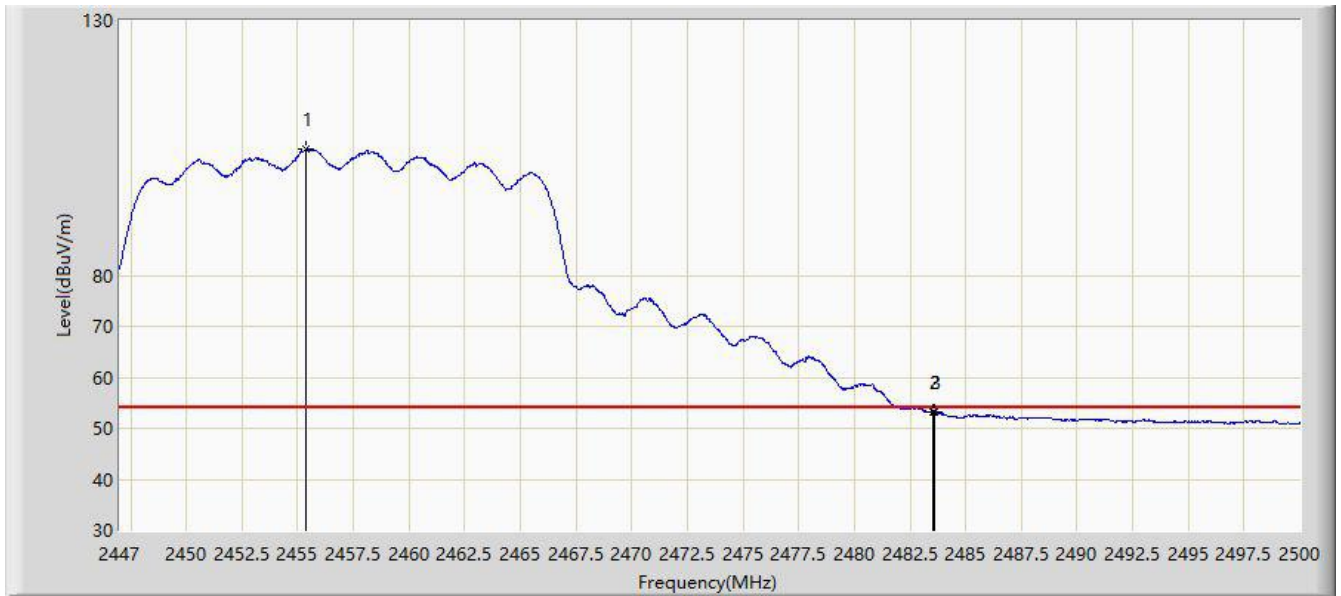

No	Flag	Mark	Frequency (MHz)	Measure Level (dBuV/m)	Reading Level (dBuV)	Margin (dB)	Limit (dBuV/m)	Factor (dB)	Type
1		*	2455.374	104.850	75.258	N/A	N/A	29.591	AV
2			2483.500	53.061	23.399	-0.939	54.000	29.662	AV
3			2483.570	53.188	23.526	-0.812	54.000	29.662	AV

Note: Measure Level (dB $\mu$ V/m) = Reading Level (dB $\mu$ V) + Factor (dB)

Factor (dB) = Cable Loss (dB) + Antenna Factor (dB/m).

Site: NS-AC1	Time: 2020/11/03 - 18:39
Limit: FCC_Part 15_15.209 RE(3m)	Engineer: Silence Liu
Probe: NS-AC1_BBHA9120D_2111	Polarity: Vertical
EUT: MESH AP Product	Power: AC 120V/60Hz
Test Mode: Transmit by 802.11n-HT20 at channel 2457MHz (CDD Mode)	



No	Flag	Mark	Frequency (MHz)	Measure Level (dBuV/m)	Reading Level (dBuV)	Margin (dB)	Limit (dBuV/m)	Factor (dB)	Type
1		*	2456.354	110.002	80.409	N/A	N/A	29.593	PK
2			2483.500	63.782	34.120	-10.218	74.000	29.662	PK
3			2483.702	65.992	36.330	-8.008	74.000	29.662	PK

Note: Measure Level (dB $\mu$ V/m) = Reading Level (dB $\mu$ V) + Factor (dB)

Factor (dB) = Cable Loss (dB) + Antenna Factor (dB/m).

Site: NS-AC1	Time: 2020/11/03 - 18:42
Limit: FCC_Part 15_15.209 RE(3m)	Engineer: Silence Liu
Probe: NS-AC1_BBHA9120D_2111	Polarity: Vertical
EUT: MESH AP Product	Power: AC 120V/60Hz
Test Mode: Transmit by 802.11n-HT20 at channel 2457MHz (CDD Mode)	

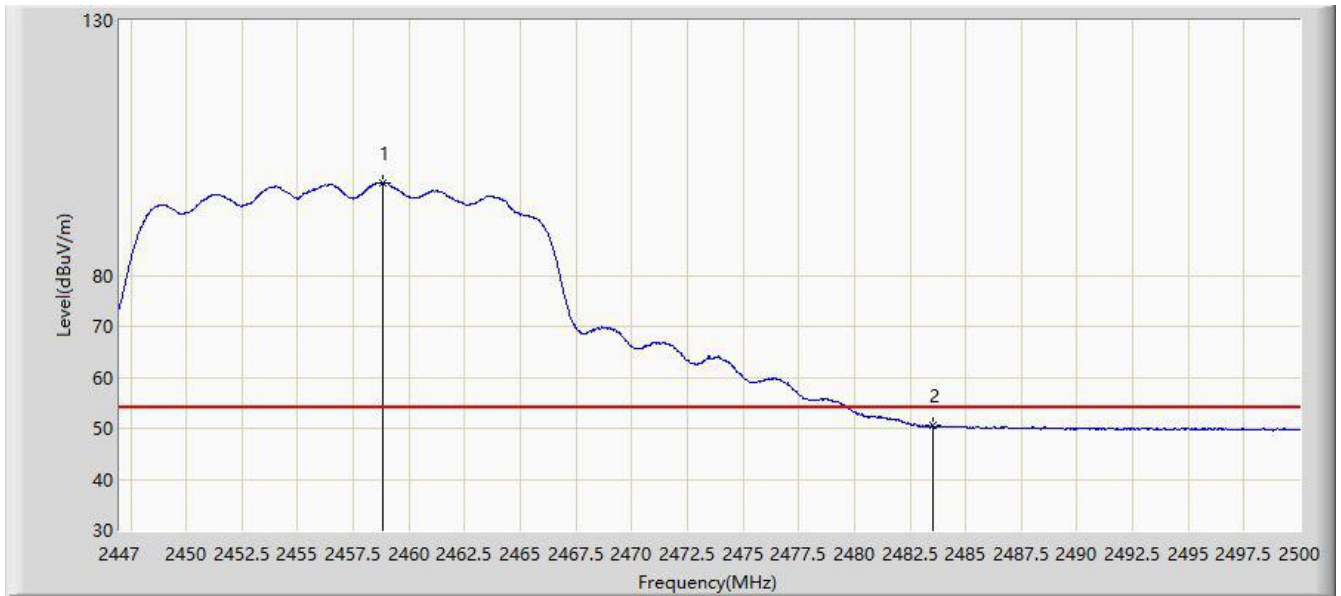

No	Flag	Mark	Frequency (MHz)	Measure Level (dBuV/m)	Reading Level (dBuV)	Margin (dB)	Limit (dBuV/m)	Factor (dB)	Type
1		*	2458.792	98.245	68.648	N/A	N/A	29.597	AV
2			2483.500	50.527	20.865	-3.473	54.000	29.662	AV

Note: Measure Level (dB $\mu$ V/m) = Reading Level (dB $\mu$ V) + Factor (dB)

Factor (dB) = Cable Loss (dB) + Antenna Factor (dB/m).

Site: NS-AC1	Time: 2020/10/30 - 09:35
Limit: FCC_Part 15_15.209 RE(3m)	Engineer: Silence Liu
Probe: NS-AC1_BBHA9120D_2111	Polarity: Horizontal
EUT: MESH AP Product	Power: AC 120V/60Hz
Test Mode: Transmit by 802.11n-HT20 at channel 2462MHz (CDD Mode)	

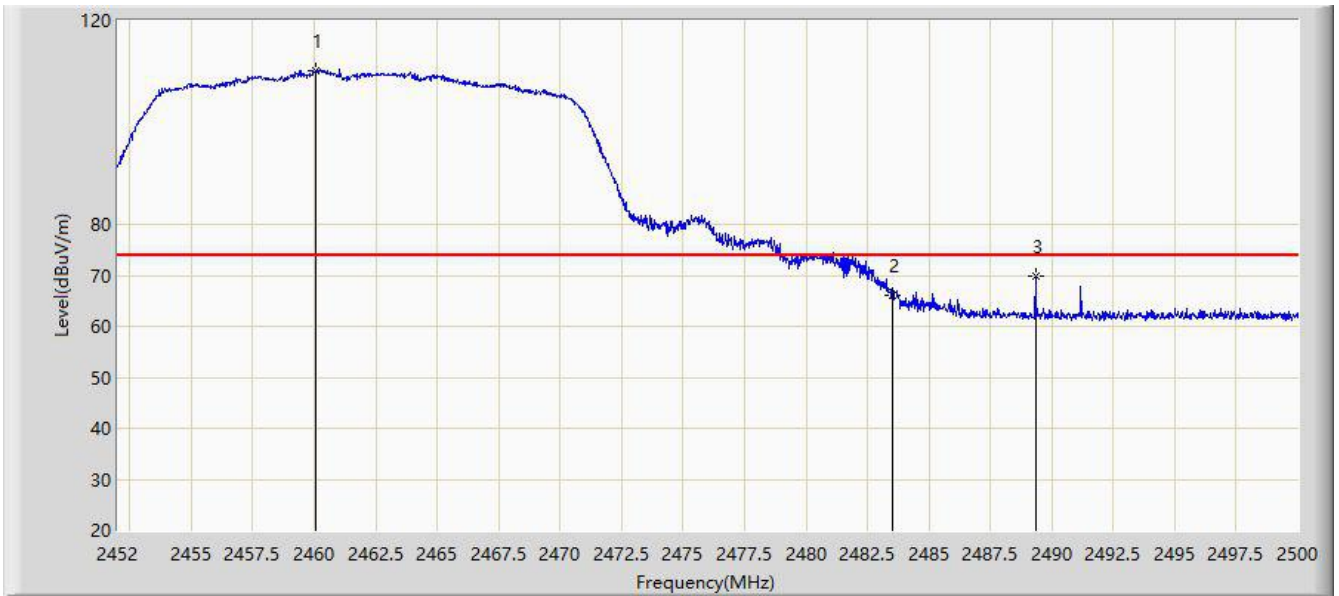

No	Flag	Mark	Frequency (MHz)	Measure Level (dBuV/m)	Reading Level (dBuV)	Margin (dB)	Limit (dBuV/m)	Factor (dB)	Type
1		*	2460.088	110.248	80.649	N/A	N/A	29.599	PK
2			2483.500	66.167	36.505	-7.833	74.000	29.662	PK
3			2489.344	69.847	40.184	-4.153	74.000	29.663	PK

Note: Measure Level (dBμV/m) = Reading Level (dBμV) + Factor (dB)

Factor (dB) = Cable Loss (dB) + Antenna Factor (dB/m).

Site: NS-AC1	Time: 2020/10/30 - 09:37
Limit: FCC_Part 15_15.209 RE(3m)	Engineer: Silence Liu
Probe: NS-AC1_BBHA9120D_2111	Polarity: Horizontal
EUT: MESH AP Product	Power: AC 120V/60Hz
Test Mode: Transmit by 802.11n-HT20 at channel 2462MHz (CDD Mode)	

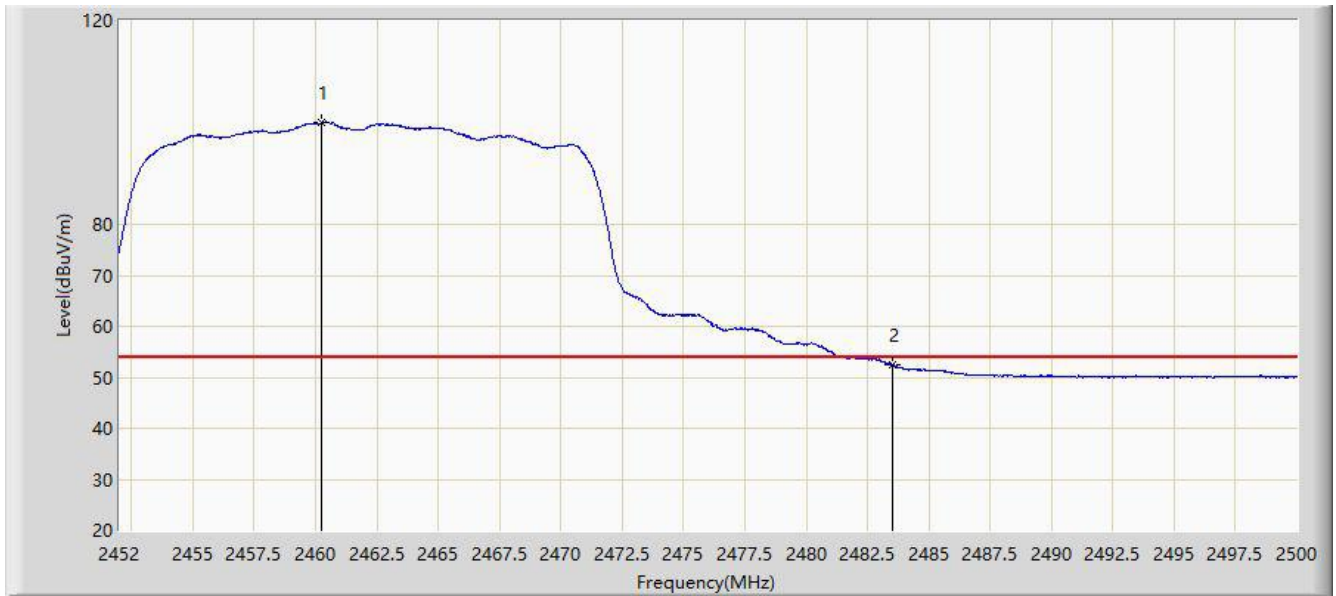

No	Flag	Mark	Frequency (MHz)	Measure Level (dBuV/m)	Reading Level (dBuV)	Margin (dB)	Limit (dBuV/m)	Factor (dB)	Type
1		*	2460.256	99.976	70.377	N/A	N/A	29.599	AV
2			2483.500	52.579	22.917	-1.421	54.000	29.662	AV

Note: Measure Level (dB $\mu$ V/m) = Reading Level (dB $\mu$ V) + Factor (dB)

Factor (dB) = Cable Loss (dB) + Antenna Factor (dB/m).

Site: NS-AC1	Time: 2020/10/30 - 09:41
Limit: FCC_Part 15_15.209 RE(3m)	Engineer: Silence Liu
Probe: NS-AC1_BBHA9120D_2111	Polarity: Vertical
EUT: MESH AP Product	Power: AC 120V/60Hz
Test Mode: Transmit by 802.11n-HT20 at channel 2462MHz (CDD Mode)	

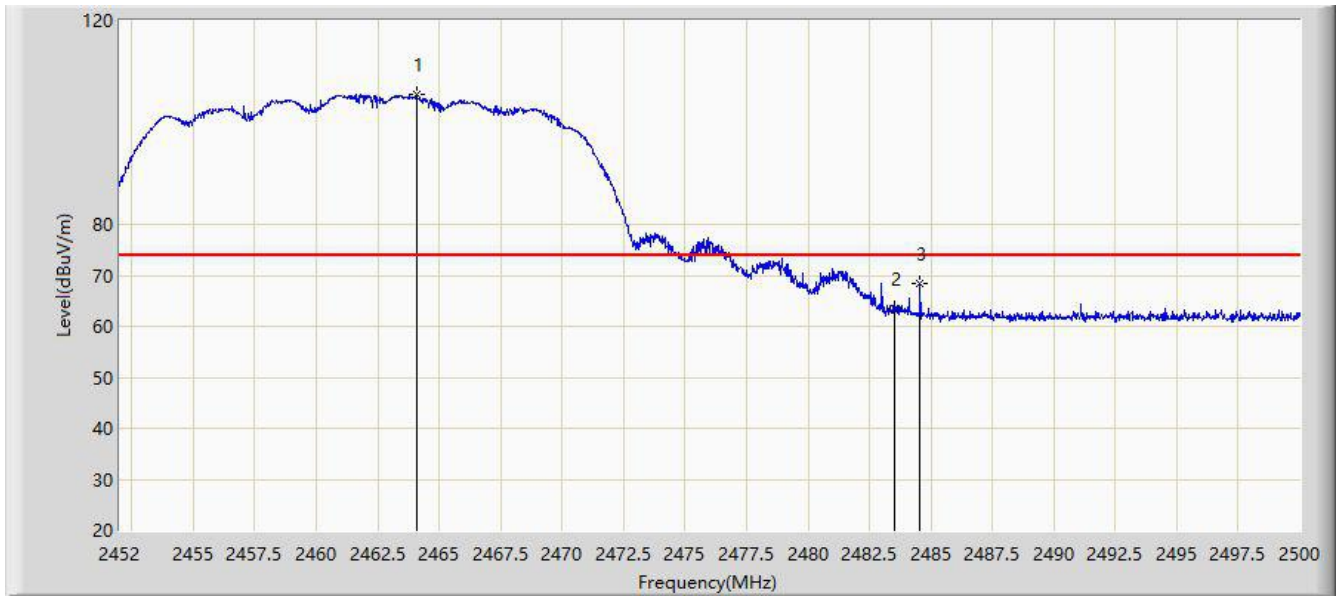

No	Flag	Mark	Frequency (MHz)	Measure Level (dBuV/m)	Reading Level (dBuV)	Margin (dB)	Limit (dBuV/m)	Factor (dB)	Type
1		*	2464.072	105.602	75.993	N/A	N/A	29.609	PK
2			2483.500	63.555	33.893	-10.445	74.000	29.662	PK
3			2484.568	68.381	38.719	-5.619	74.000	29.662	PK

Note: Measure Level (dB $\mu$ V/m) = Reading Level (dB $\mu$ V) + Factor (dB)

Factor (dB) = Cable Loss (dB) + Antenna Factor (dB/m).

Site: NS-AC1	Time: 2020/10/30 - 09:43
Limit: FCC_Part 15_15.209 RE(3m)	Engineer: Silence Liu
Probe: NS-AC1_BBHA9120D_2111	Polarity: Vertical
EUT: MESH AP Product	Power: AC 120V/60Hz
Test Mode: Transmit by 802.11n-HT20 at channel 2462MHz (CDD Mode)	

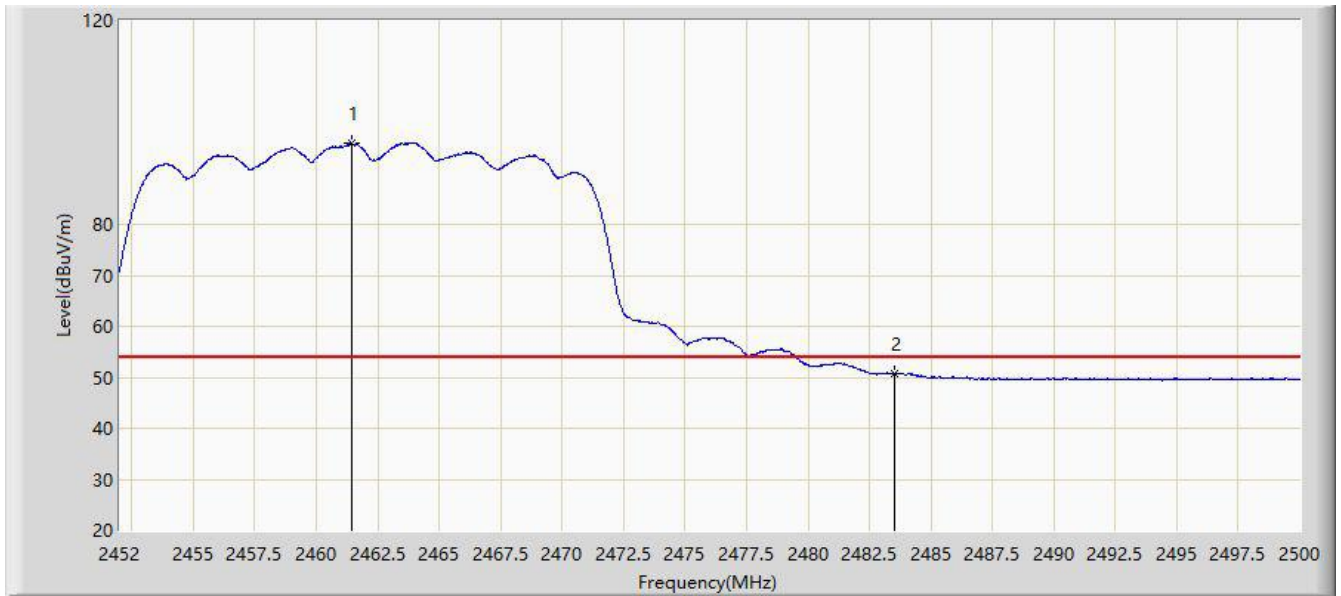

No	Flag	Mark	Frequency (MHz)	Measure Level (dBuV/m)	Reading Level (dBuV)	Margin (dB)	Limit (dBuV/m)	Factor (dB)	Type
1		*	2461.432	95.968	66.367	N/A	N/A	29.600	AV
2			2483.500	50.809	21.147	-3.191	54.000	29.662	AV

Note: Measure Level (dB $\mu$ V/m) = Reading Level (dB $\mu$ V) + Factor (dB)

Factor (dB) = Cable Loss (dB) + Antenna Factor (dB/m).

Site: NS-AC1	Time: 2020/10/31 - 18:57
Limit: FCC_Part 15_15.209 RE(3m)	Engineer: Silence Liu
Probe: NS-AC1_BBHA9120D_2111	Polarity: Horizontal
EUT: MESH AP Product	Power: AC 120V/60Hz
Test Mode: Transmit by 802.11n-HT40 at channel 2422MHz (CDD Mode)	

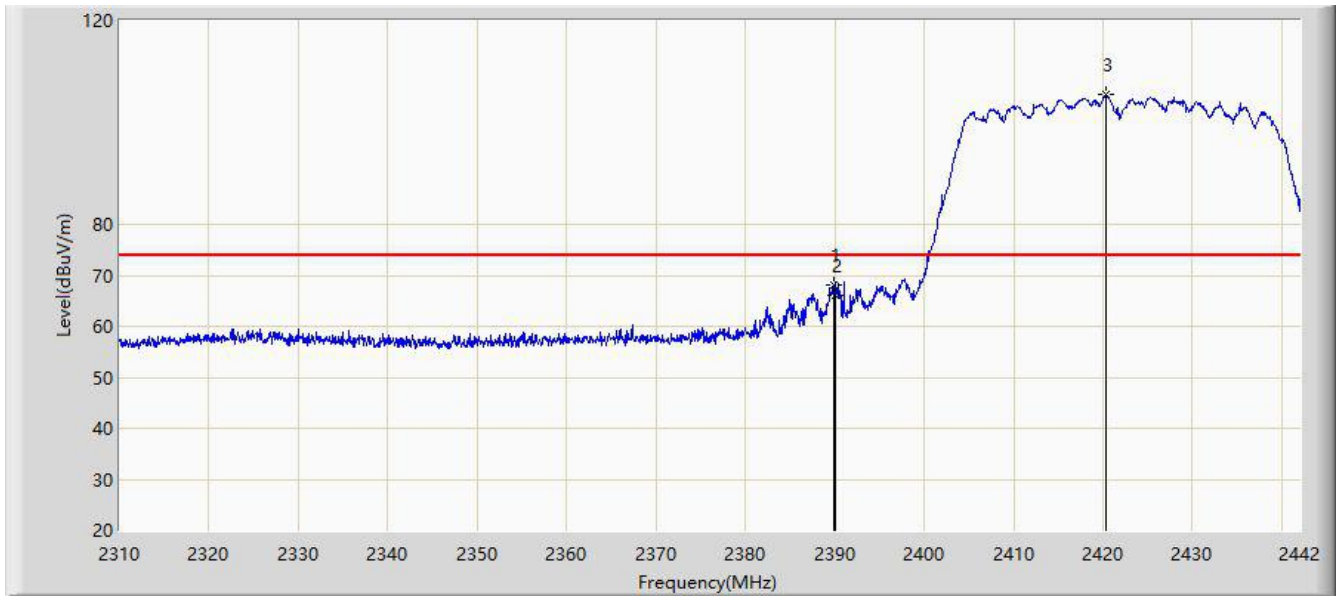

No	Flag	Mark	Frequency (MHz)	Measure Level (dBuV/m)	Reading Level (dBuV)	Margin (dB)	Limit (dBuV/m)	Factor (dB)	Type
1			2389.860	68.018	38.536	-5.982	74.000	29.482	PK
2			2390.000	66.071	36.589	-7.929	74.000	29.482	PK
3		*	2420.352	105.474	75.929	N/A	N/A	29.545	PK

Note: Measure Level (dB $\mu$ V/m) = Reading Level (dB $\mu$ V) + Factor (dB)

Factor (dB) = Cable Loss (dB) + Antenna Factor (dB/m).



Site: NS-AC1	Time: 2020/10/31 - 18:57
Limit: FCC_Part 15_15.209 RE(3m)	Engineer: Silence Liu
Probe: NS-AC1_BBHA9120D_2111	Polarity: Horizontal
EUT: MESH AP Product	Power: AC 120V/60Hz
Test Mode: Transmit by 802.11n-HT40 at channel 2422MHz (CDD Mode)	

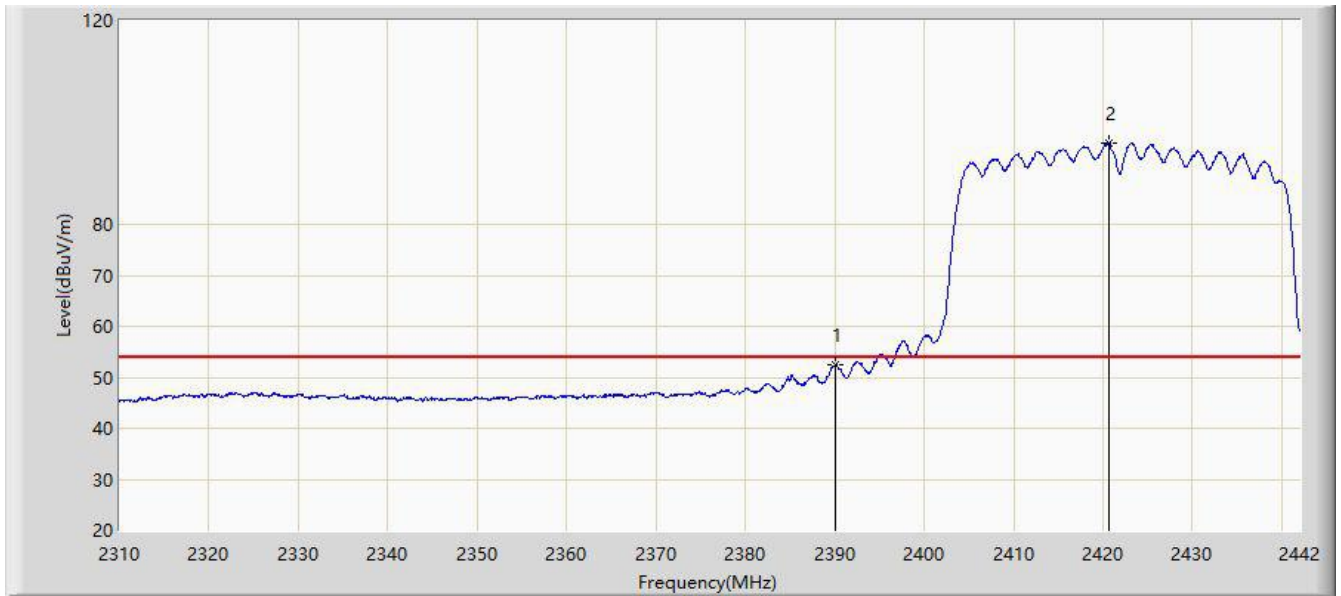

No	Flag	Mark	Frequency (MHz)	Measure Level (dBuV/m)	Reading Level (dBuV)	Margin (dB)	Limit (dBuV/m)	Factor (dB)	Type
1			2390.000	52.518	23.036	-1.482	54.000	29.482	AV
2		*	2420.616	95.933	66.388	N/A	N/A	29.546	AV

Note: Measure Level (dB $\mu$ V/m) = Reading Level (dB $\mu$ V) + Factor (dB)

Factor (dB) = Cable Loss (dB) + Antenna Factor (dB/m).

Site: NS-AC1	Time: 2020/10/31 - 19:07
Limit: FCC_Part 15_15.209 RE(3m)	Engineer: Silence Liu
Probe: NS-AC1_BBHA9120D_2111	Polarity: Vertical
EUT: MESH AP Product	Power: AC 120V/60Hz
Test Mode: Transmit by 802.11n-HT40 at channel 2422MHz (CDD Mode)	

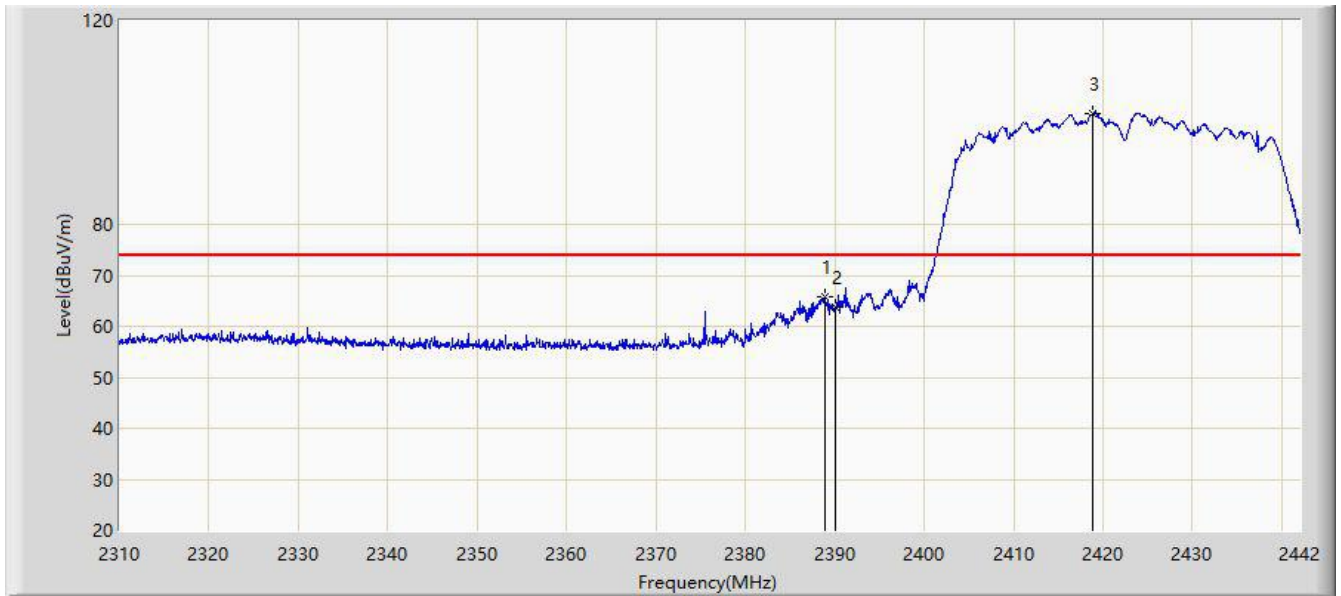

No	Flag	Mark	Frequency (MHz)	Measure Level (dBuV/m)	Reading Level (dBuV)	Margin (dB)	Limit (dBuV/m)	Factor (dB)	Type
1			2388.870	65.787	36.307	-8.213	74.000	29.480	PK
2			2390.000	63.713	34.231	-10.287	74.000	29.482	PK
3		*	2418.900	101.858	72.314	N/A	N/A	29.544	PK

Note: Measure Level (dB $\mu$ V/m) = Reading Level (dB $\mu$ V) + Factor (dB)

Factor (dB) = Cable Loss (dB) + Antenna Factor (dB/m).

Site: NS-AC1	Time: 2020/10/31 - 19:01
Limit: FCC_Part 15_15.209 RE(3m)	Engineer: Silence Liu
Probe: NS-AC1_BBHA9120D_2111	Polarity: Vertical
EUT: MESH AP Product	Power: AC 120V/60Hz
Test Mode: Transmit by 802.11n-HT40 at channel 2422MHz (CDD Mode)	

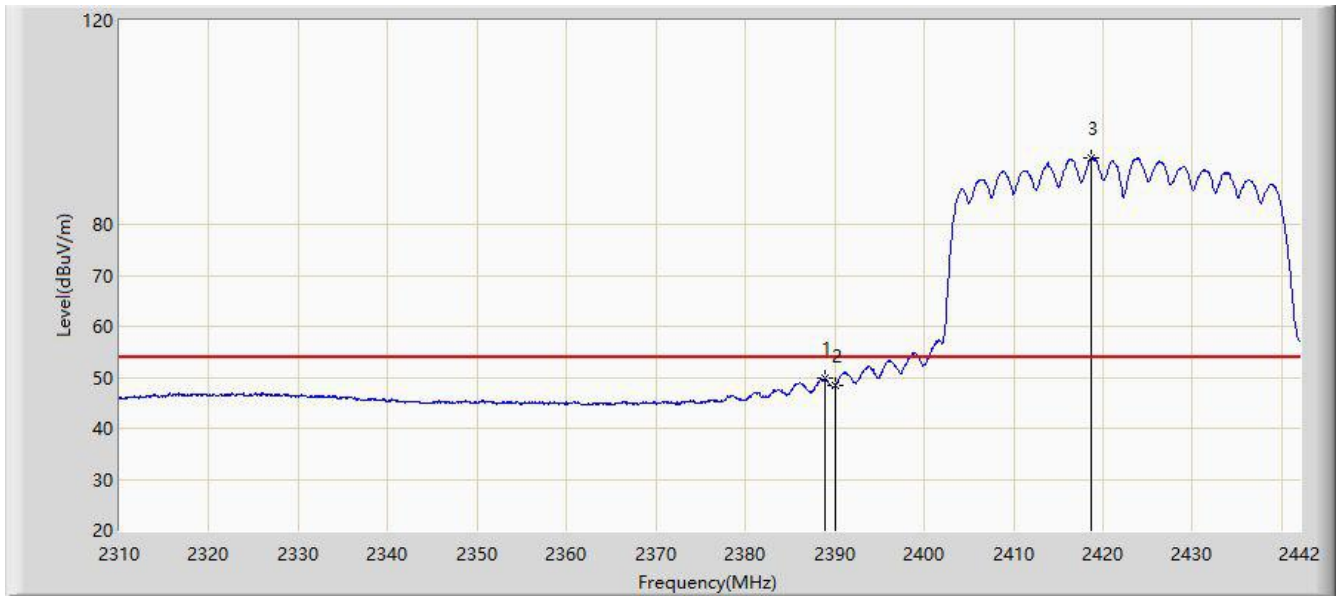

No	Flag	Mark	Frequency (MHz)	Measure Level (dBuV/m)	Reading Level (dBuV)	Margin (dB)	Limit (dBuV/m)	Factor (dB)	Type
1			2388.870	49.745	20.265	-4.255	54.000	29.480	AV
2			2390.000	48.435	18.953	-5.565	54.000	29.482	AV
3		*	2418.702	92.978	63.434	N/A	N/A	29.544	AV

Note: Measure Level (dB $\mu$ V/m) = Reading Level (dB $\mu$ V) + Factor (dB)

Factor (dB) = Cable Loss (dB) + Antenna Factor (dB/m).

Site: NS-AC1	Time: 2020/11/03 - 19:14
Limit: FCC_Part 15_15.209 RE(3m)	Engineer: Silence Liu
Probe: NS-AC1_BBHA9120D_2111	Polarity: Horizontal
EUT: MESH AP Product	Power: AC 120V/60Hz
Test Mode: Transmit by 802.11n-HT40 at channel 2427MHz (CDD Mode)	

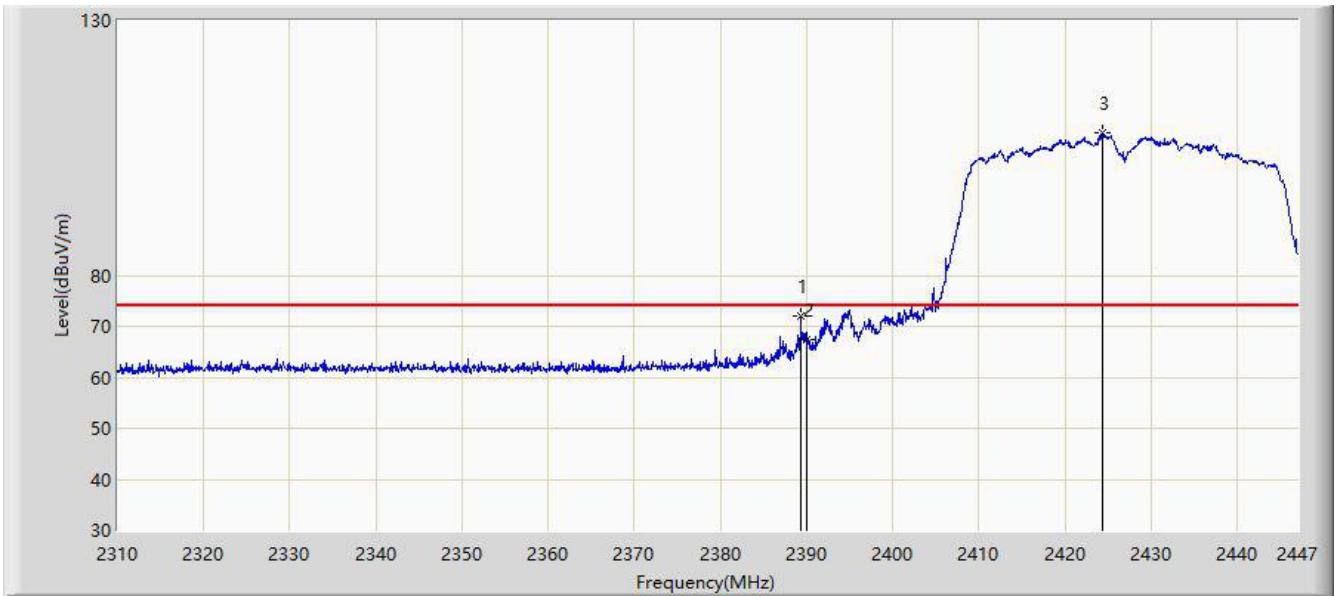

No	Flag	Mark	Frequency (MHz)	Measure Level (dBuV/m)	Reading Level (dBuV)	Margin (dB)	Limit (dBuV/m)	Factor (dB)	Type
1			2389.323	71.921	42.440	-2.079	74.000	29.481	PK
2			2390.000	67.408	37.926	-6.592	74.000	29.482	PK
3		*	2424.395	107.905	78.357	N/A	N/A	29.547	PK

Note: Measure Level (dBμV/m) = Reading Level (dBμV) + Factor (dB)

Factor (dB) = Cable Loss (dB) + Antenna Factor (dB/m).

Site: NS-AC1	Time: 2020/11/03 - 19:13
Limit: FCC_Part 15_15.209 RE(3m)	Engineer: Silence Liu
Probe: NS-AC1_BBHA9120D_2111	Polarity: Horizontal
EUT: MESH AP Product	Power: AC 120V/60Hz
Test Mode: Transmit by 802.11n-HT40 at channel 2427MHz (CDD Mode)	

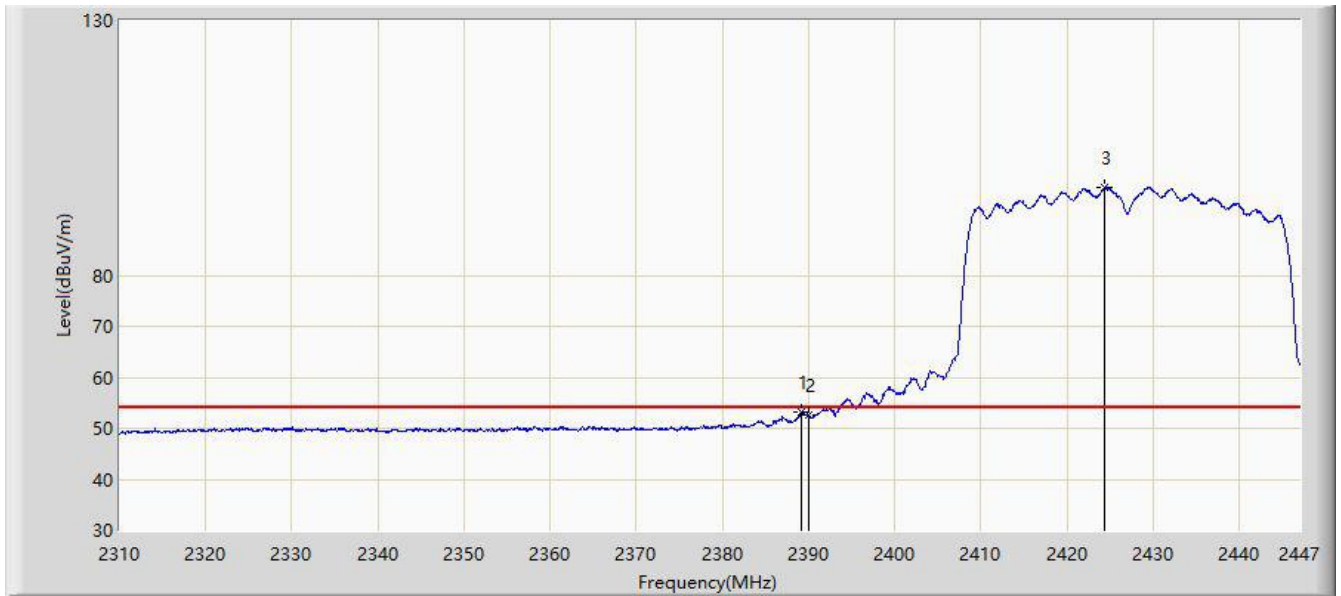

No	Flag	Mark	Frequency (MHz)	Measure Level (dBuV/m)	Reading Level (dBuV)	Margin (dB)	Limit (dBuV/m)	Factor (dB)	Type
1			2389.117	53.271	23.790	-0.729	54.000	29.481	AV
2			2390.000	52.535	23.053	-1.465	54.000	29.482	AV
3		*	2424.326	97.297	67.749	N/A	N/A	29.547	AV

Note: Measure Level (dB $\mu$ V/m) = Reading Level (dB $\mu$ V) + Factor (dB)

Factor (dB) = Cable Loss (dB) + Antenna Factor (dB/m).

Site: NS-AC1	Time: 2020/11/03 - 19:16
Limit: FCC_Part 15_15.209 RE(3m)	Engineer: Silence Liu
Probe: NS-AC1_BBHA9120D_2111	Polarity: Vertical
EUT: MESH AP Product	Power: AC 120V/60Hz
Test Mode: Transmit by 802.11n-HT40 at channel 2427MHz (CDD Mode)	

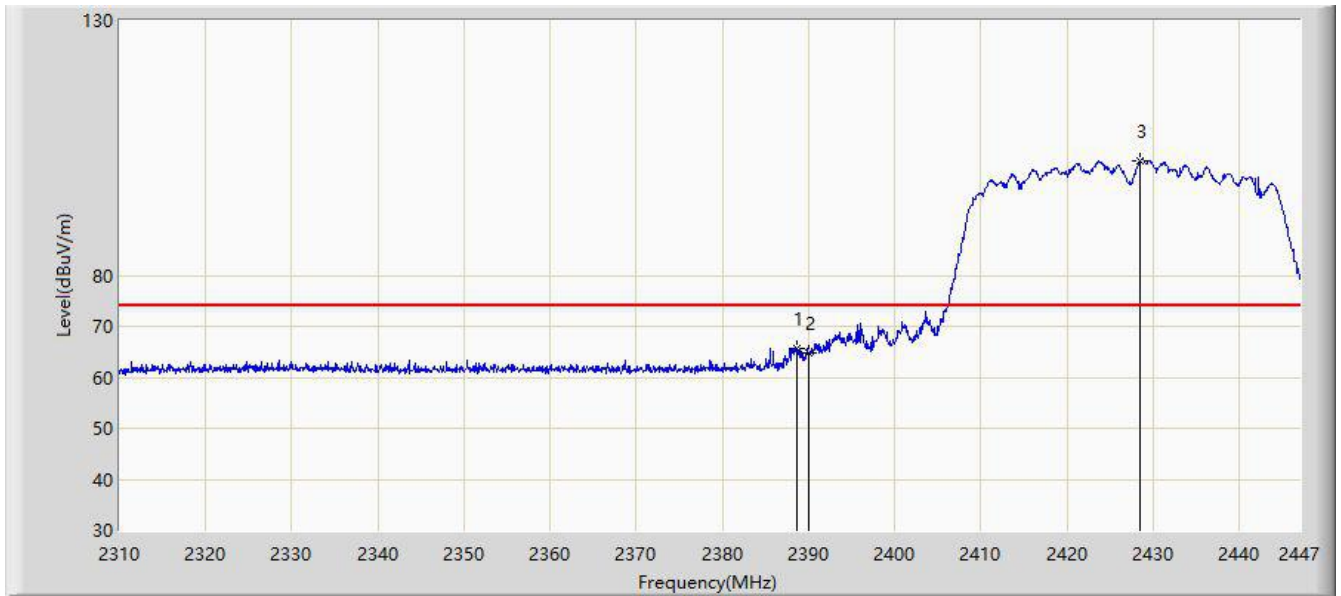

No	Flag	Mark	Frequency (MHz)	Measure Level (dBuV/m)	Reading Level (dBuV)	Margin (dB)	Limit (dBuV/m)	Factor (dB)	Type
1			2388.638	65.773	36.293	-8.227	74.000	29.480	PK
2			2390.000	64.808	35.326	-9.192	74.000	29.482	PK
3		*	2428.505	102.552	73.001	N/A	N/A	29.551	PK

Note: Measure Level (dB $\mu$ V/m) = Reading Level (dB $\mu$ V) + Factor (dB)

Factor (dB) = Cable Loss (dB) + Antenna Factor (dB/m).

Site: NS-AC1	Time: 2020/11/03 - 19:20
Limit: FCC_Part 15_15.209 RE(3m)	Engineer: Silence Liu
Probe: NS-AC1_BBHA9120D_2111	Polarity: Vertical
EUT: MESH AP Product	Power: AC 120V/60Hz
Test Mode: Transmit by 802.11n-HT40 at channel 2427MHz (CDD Mode)	

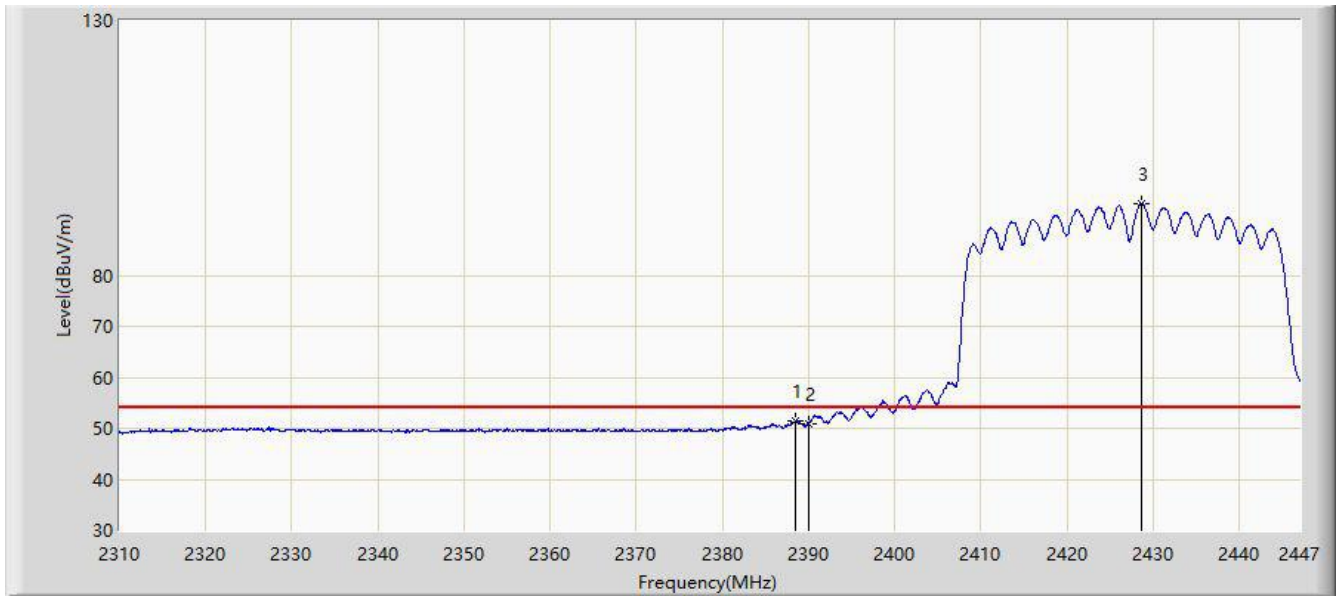

No	Flag	Mark	Frequency (MHz)	Measure Level (dBuV/m)	Reading Level (dBuV)	Margin (dB)	Limit (dBuV/m)	Factor (dB)	Type
1			2388.433	51.495	22.015	-2.505	54.000	29.479	AV
2			2390.000	50.880	21.398	-3.120	54.000	29.482	AV
3		*	2428.642	94.156	64.605	N/A	N/A	29.551	AV

Note: Measure Level (dB $\mu$ V/m) = Reading Level (dB $\mu$ V) + Factor (dB)

Factor (dB) = Cable Loss (dB) + Antenna Factor (dB/m).

Site: NS-AC1	Time: 2020/11/03 - 19:30
Limit: FCC_Part 15_15.209 RE(3m)	Engineer: Silence Liu
Probe: NS-AC1_BBHA9120D_2111	Polarity: Horizontal
EUT: MESH AP Product	Power: AC 120V/60Hz
Test Mode: Transmit by 802.11n-HT40 at channel 2437MHz (CDD Mode)	

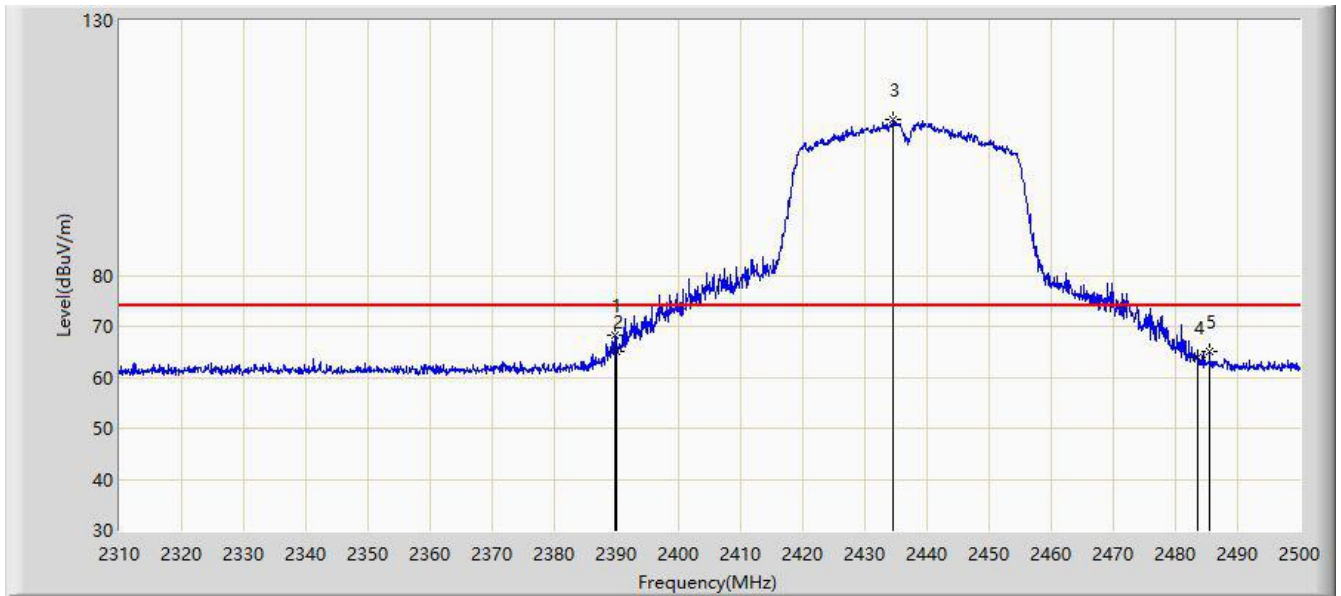

No	Flag	Mark	Frequency (MHz)	Measure Level (dBuV/m)	Reading Level (dBuV)	Margin (dB)	Limit (dBuV/m)	Factor (dB)	Type
1			2389.800	68.233	38.751	-5.767	74.000	29.482	PK
2			2390.000	65.002	35.520	-8.998	74.000	29.482	PK
3		*	2434.640	110.506	80.946	N/A	N/A	29.560	PK
4			2483.500	63.979	34.317	-10.021	74.000	29.662	PK
5			2485.465	65.046	35.384	-8.954	74.000	29.662	PK

Note: Measure Level (dBuV/m) = Reading Level (dBuV) + Factor (dB)

Factor (dB) = Cable Loss (dB) + Antenna Factor (dB/m).



Site: NS-AC1	Time: 2020/11/03 - 19:29
Limit: FCC_Part 15_15.209 RE(3m)	Engineer: Silence Liu
Probe: NS-AC1_BBHA9120D_2111	Polarity: Horizontal
EUT: MESH AP Product	Power: AC 120V/60Hz
Test Mode: Transmit by 802.11n-HT40 at channel 2437MHz (CDD Mode)	

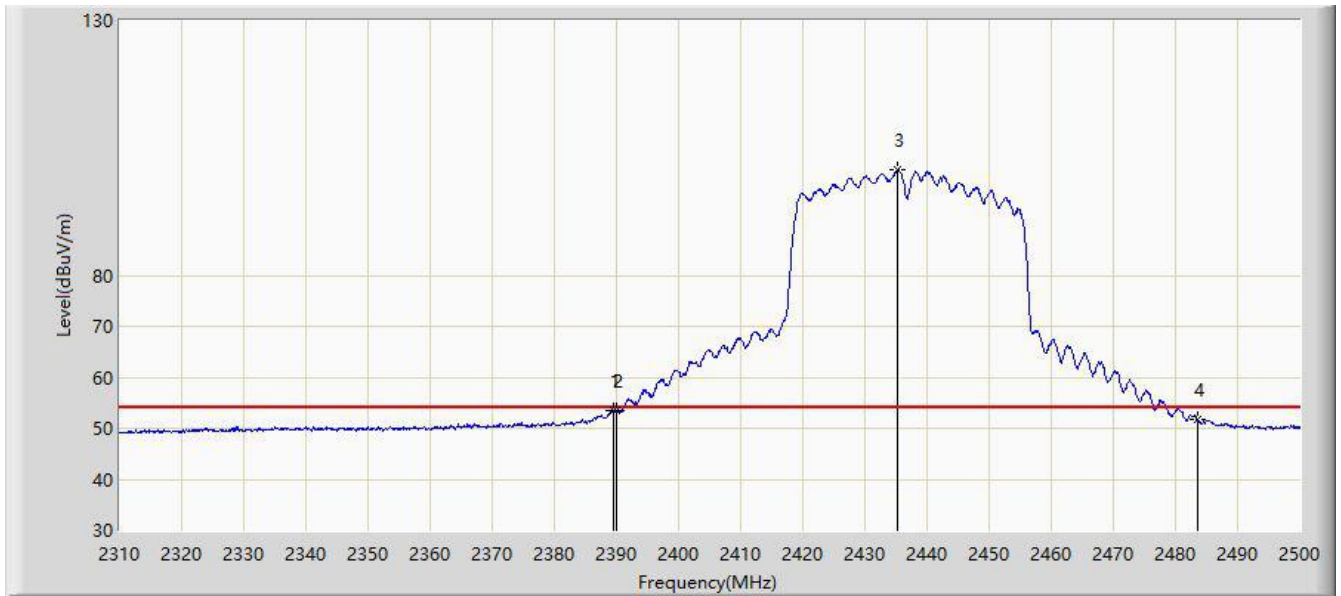

No	Flag	Mark	Frequency (MHz)	Measure Level (dBuV/m)	Reading Level (dBuV)	Margin (dB)	Limit (dBuV/m)	Factor (dB)	Type
1			2389.420	53.596	24.115	-0.404	54.000	29.481	AV
2			2390.000	53.355	23.873	-0.645	54.000	29.482	AV
3		*	2435.210	100.714	71.153	N/A	N/A	29.561	AV
4			2483.500	51.764	22.102	-2.236	54.000	29.662	AV

Note: Measure Level (dB $\mu$ V/m) = Reading Level (dB $\mu$ V) + Factor (dB)

Factor (dB) = Cable Loss (dB) + Antenna Factor (dB/m).

Site: NS-AC1	Time: 2020/11/03 - 19:43
Limit: FCC_Part 15_15.209 RE(3m)	Engineer: Silence Liu
Probe: NS-AC1_BBHA9120D_2111	Polarity: Vertical
EUT: MESH AP Product	Power: AC 120V/60Hz
Test Mode: Transmit by 802.11n-HT40 at channel 2437MHz (CDD Mode)	

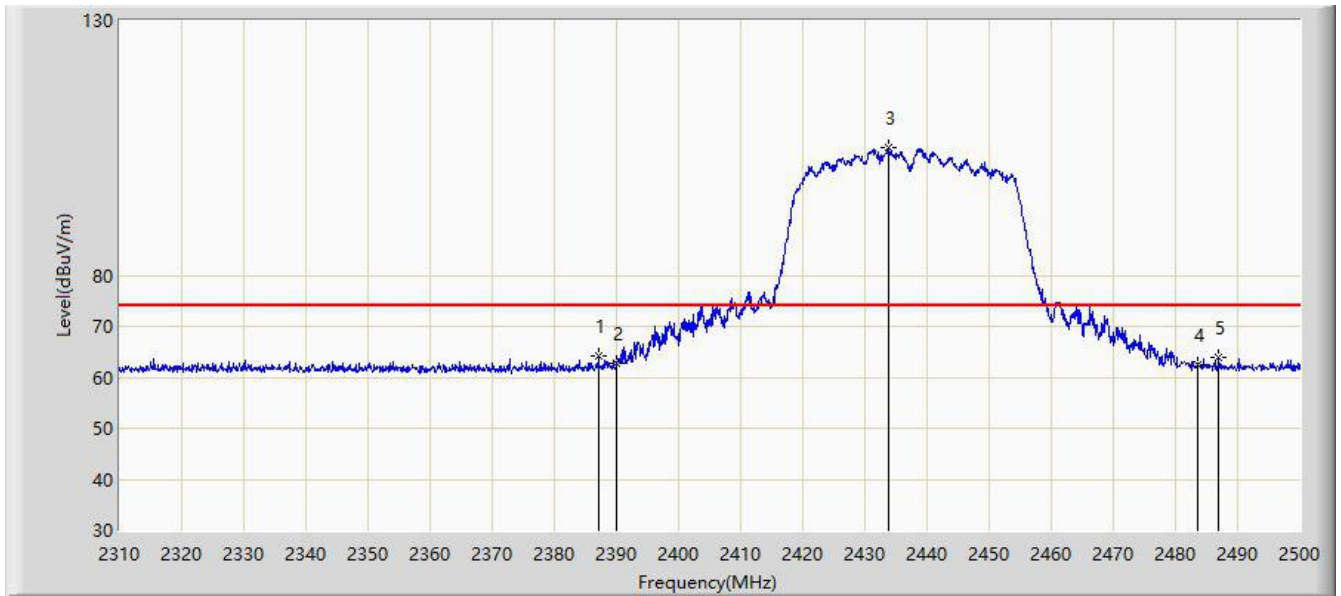

No	Flag	Mark	Frequency (MHz)	Measure Level (dBuV/m)	Reading Level (dBuV)	Margin (dB)	Limit (dBuV/m)	Factor (dB)	Type
1			2387.140	64.087	34.609	-9.913	74.000	29.477	PK
2			2390.000	62.755	33.273	-11.245	74.000	29.482	PK
3		*	2433.785	105.125	75.566	N/A	N/A	29.559	PK
4			2483.500	62.455	32.793	-11.545	74.000	29.662	PK
5			2486.985	63.913	34.250	-10.087	74.000	29.663	PK

Note: Measure Level (dB $\mu$ V/m) = Reading Level (dB $\mu$ V) + Factor (dB)

Factor (dB) = Cable Loss (dB) + Antenna Factor (dB/m).

Site: NS-AC1	Time: 2020/11/03 - 19:46
Limit: FCC_Part 15_15.209 RE(3m)	Engineer: Silence Liu
Probe: NS-AC1_BBHA9120D_2111	Polarity: Vertical
EUT: MESH AP Product	Power: AC 120V/60Hz
Test Mode: Transmit by 802.11n-HT40 at channel 2437MHz (CDD Mode)	

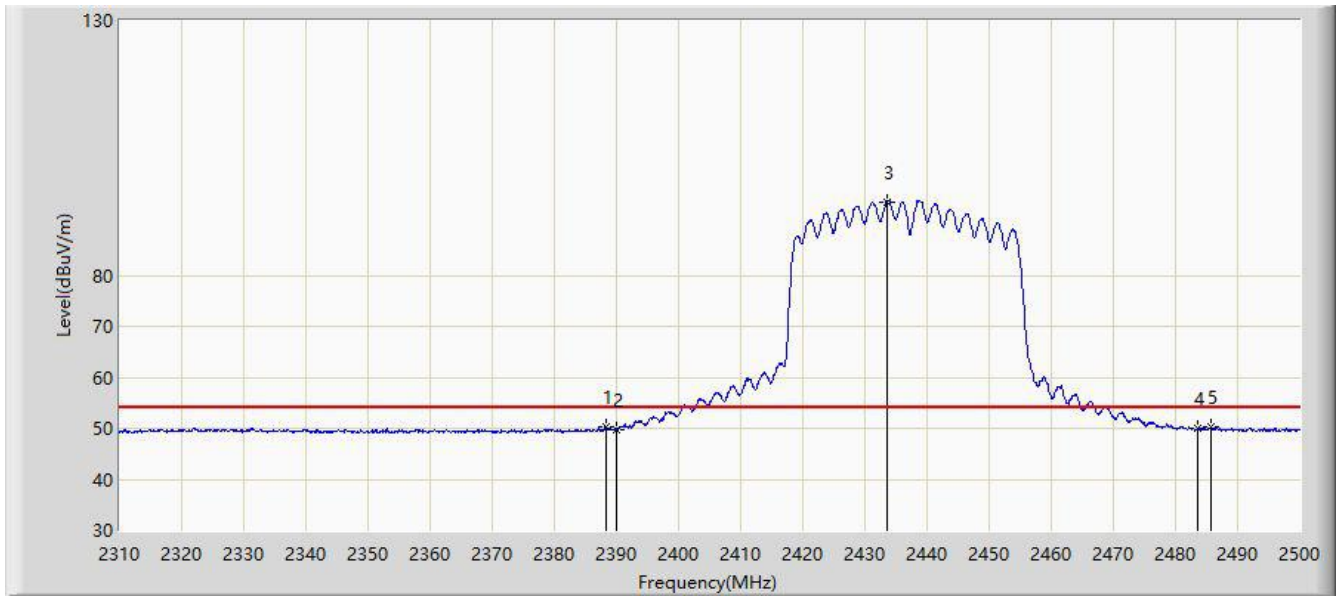

No	Flag	Mark	Frequency (MHz)	Measure Level (dBuV/m)	Reading Level (dBuV)	Margin (dB)	Limit (dBuV/m)	Factor (dB)	Type
1			2388.280	50.280	20.801	-3.720	54.000	29.479	AV
2			2390.000	49.802	20.320	-4.198	54.000	29.482	AV
3		*	2433.500	94.451	64.893	N/A	N/A	29.559	AV
4			2483.500	49.942	20.280	-4.058	54.000	29.662	AV
5			2485.655	50.182	20.520	-3.818	54.000	29.663	AV

Note: Measure Level (dBuV/m) = Reading Level (dBuV) + Factor (dB)

Factor (dB) = Cable Loss (dB) + Antenna Factor (dB/m).

Site: NS-AC1	Time: 2020/11/03 - 19:59
Limit: FCC_Part 15_15.209 RE(3m)	Engineer: Silence Liu
Probe: NS-AC1_BBHA9120D_2111	Polarity: Horizontal
EUT: MESH AP Product	Power: AC 120V/60Hz
Test Mode: Transmit by 802.11n-HT40 at channel 2447MHz (CDD Mode)	

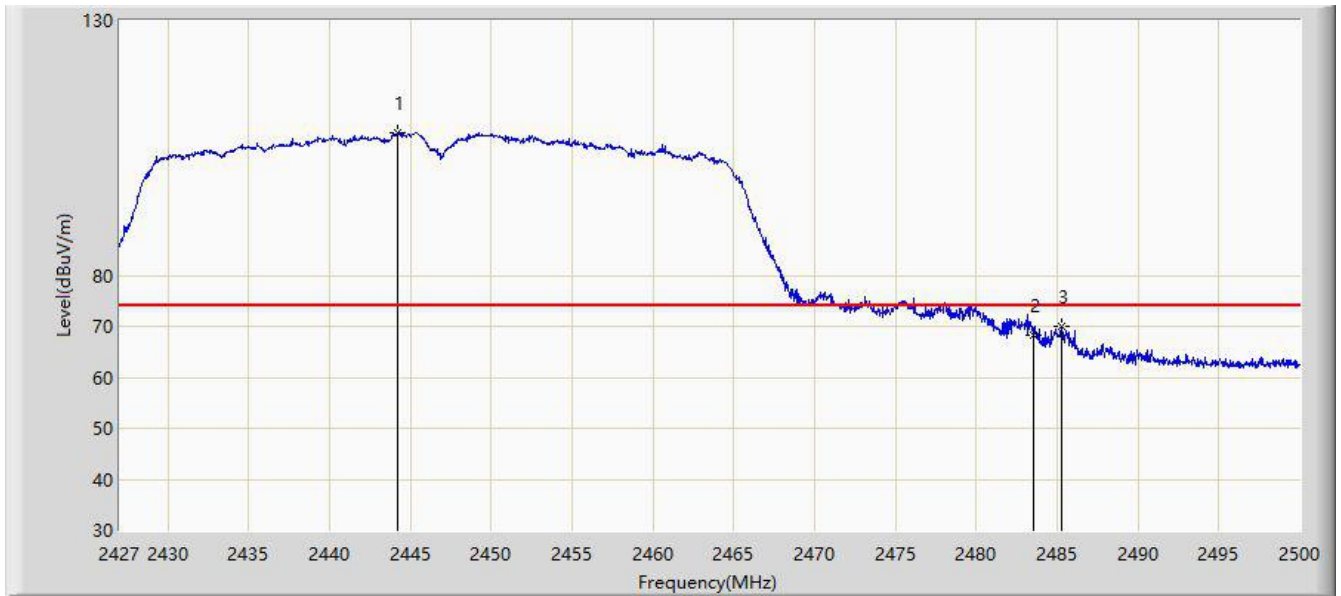

No	Flag	Mark	Frequency (MHz)	Measure Level (dBuV/m)	Reading Level (dBuV)	Margin (dB)	Limit (dBuV/m)	Factor (dB)	Type
1		*	2444.191	108.028	78.453	N/A	N/A	29.575	PK
2			2483.500	68.396	38.734	-5.604	74.000	29.662	PK
3			2485.254	69.907	40.245	-4.093	74.000	29.662	PK

Note: Measure Level (dB $\mu$ V/m) = Reading Level (dB $\mu$ V) + Factor (dB)

Factor (dB) = Cable Loss (dB) + Antenna Factor (dB/m).

Site: NS-AC1	Time: 2020/11/03 - 19:57
Limit: FCC_Part 15_15.209 RE(3m)	Engineer: Silence Liu
Probe: NS-AC1_BBHA9120D_2111	Polarity: Horizontal
EUT: MESH AP Product	Power: AC 120V/60Hz
Test Mode: Transmit by 802.11n-HT40 at channel 2447MHz (CDD Mode)	

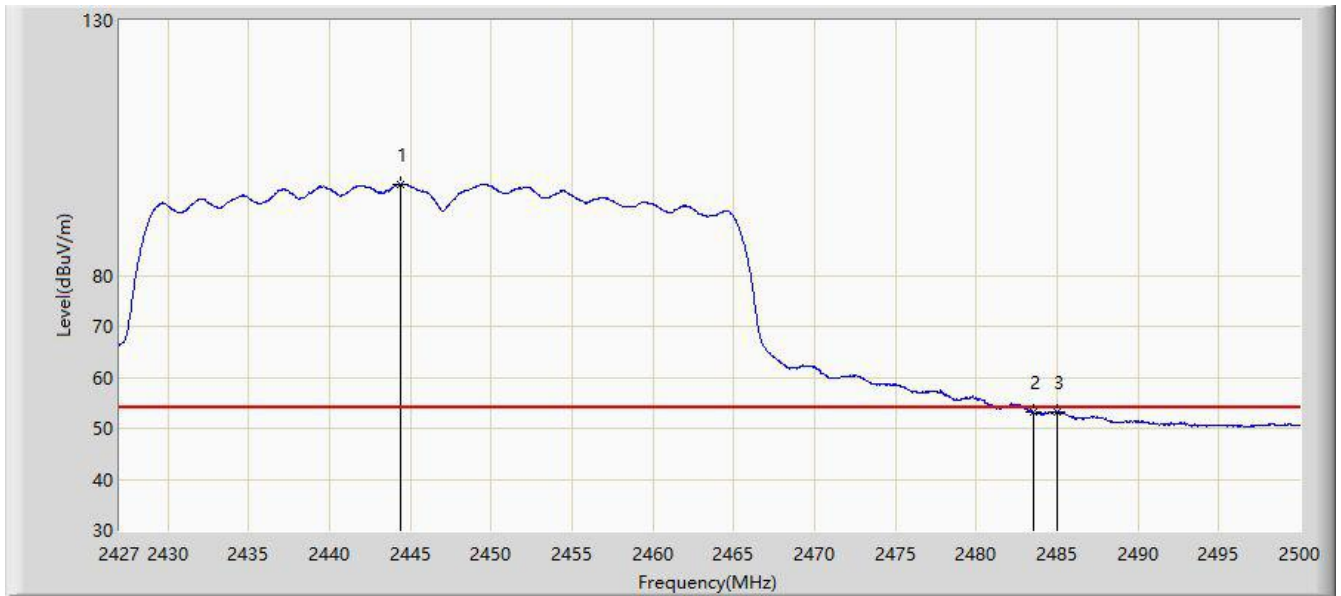

No	Flag	Mark	Frequency (MHz)	Measure Level (dBuV/m)	Reading Level (dBuV)	Margin (dB)	Limit (dBuV/m)	Factor (dB)	Type
1		*	2444.337	97.885	68.310	N/A	N/A	29.575	AV
2			2483.500	53.145	23.483	-0.855	54.000	29.662	AV
3			2485.035	53.254	23.592	-0.746	54.000	29.662	AV

Note: Measure Level (dB $\mu$ V/m) = Reading Level (dB $\mu$ V) + Factor (dB)

Factor (dB) = Cable Loss (dB) + Antenna Factor (dB/m).

Site: NS-AC1	Time: 2020/11/03 - 20:02
Limit: FCC_Part 15_15.209 RE(3m)	Engineer: Silence Liu
Probe: NS-AC1_BBHA9120D_2111	Polarity: Vertical
EUT: MESH AP Product	Power: AC 120V/60Hz
Test Mode: Transmit by 802.11n-HT40 at channel 2447MHz (CDD Mode)	

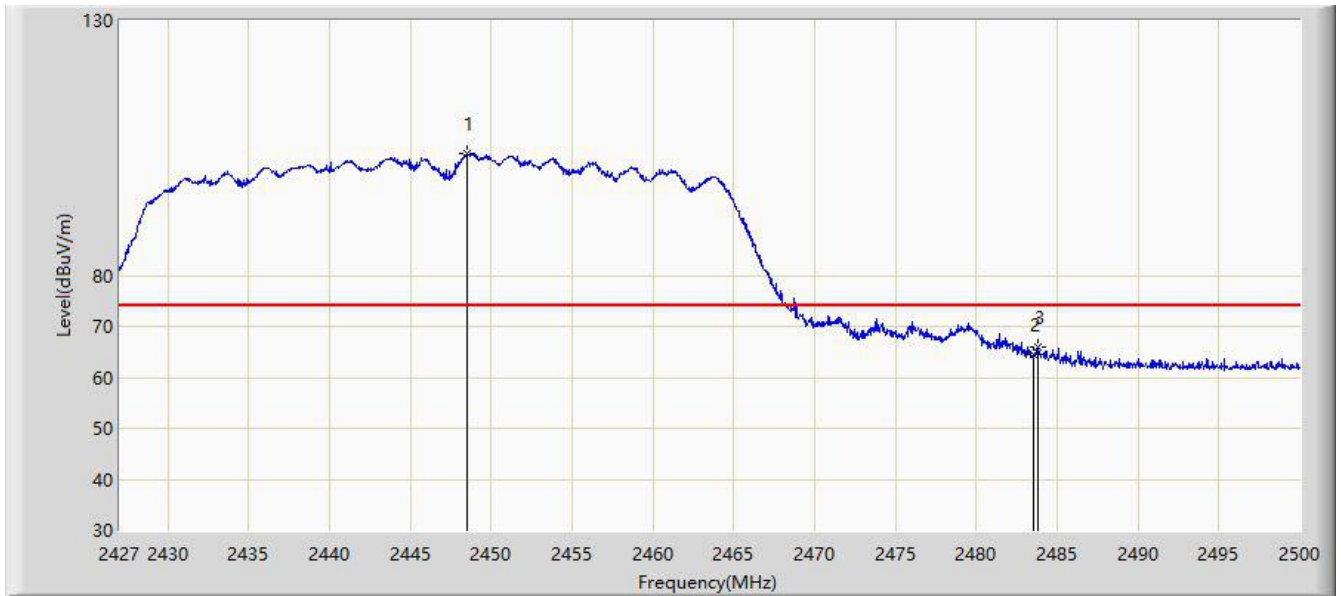

No	Flag	Mark	Frequency (MHz)	Measure Level (dBuV/m)	Reading Level (dBuV)	Margin (dB)	Limit (dBuV/m)	Factor (dB)	Type
1		*	2448.535	103.785	74.204	N/A	N/A	29.582	PK
2			2483.500	64.471	34.809	-9.529	74.000	29.662	PK
3			2483.794	65.829	36.167	-8.171	74.000	29.662	PK

Note: Measure Level (dB $\mu$ V/m) = Reading Level (dB $\mu$ V) + Factor (dB)

Factor (dB) = Cable Loss (dB) + Antenna Factor (dB/m).

Site: NS-AC1	Time: 2020/11/03 - 20:05
Limit: FCC_Part 15_15.209 RE(3m)	Engineer: Silence Liu
Probe: NS-AC1_BBHA9120D_2111	Polarity: Vertical
EUT: MESH AP Product	Power: AC 120V/60Hz
Test Mode: Transmit by 802.11n-HT40 at channel 2447MHz (CDD Mode)	

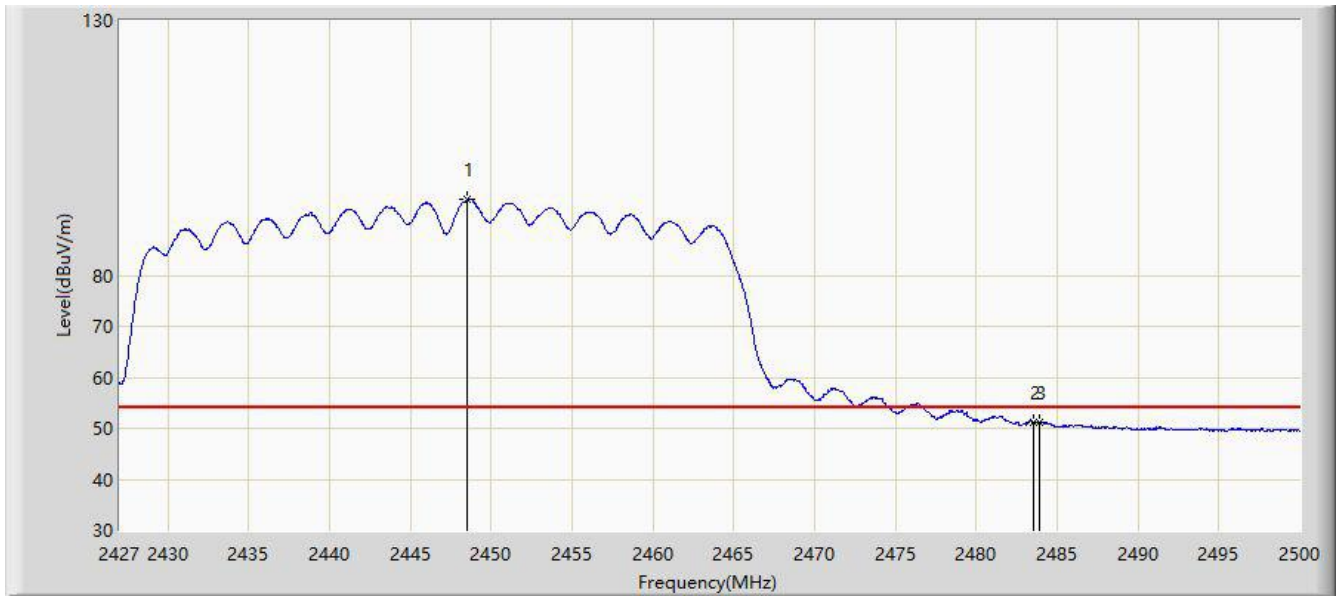

No	Flag	Mark	Frequency (MHz)	Measure Level (dBuV/m)	Reading Level (dBuV)	Margin (dB)	Limit (dBuV/m)	Factor (dB)	Type
1		*	2448.499	94.851	65.270	N/A	N/A	29.581	AV
2			2483.500	51.230	21.568	-2.770	54.000	29.662	AV
3			2483.940	51.261	21.599	-2.739	54.000	29.662	AV

Note: Measure Level (dB $\mu$ V/m) = Reading Level (dB $\mu$ V) + Factor (dB)

Factor (dB) = Cable Loss (dB) + Antenna Factor (dB/m).

Site: NS-AC1	Time: 2020/10/31 - 19:32
Limit: FCC_Part 15_15.209 RE(3m)	Engineer: Silence Liu
Probe: NS-AC1_BBHA9120D_2111	Polarity: Horizontal
EUT: MESH AP Product	Power: AC 120V/60Hz
Test Mode: Transmit by 802.11n-HT40 at channel 2452MHz (CDD Mode)	

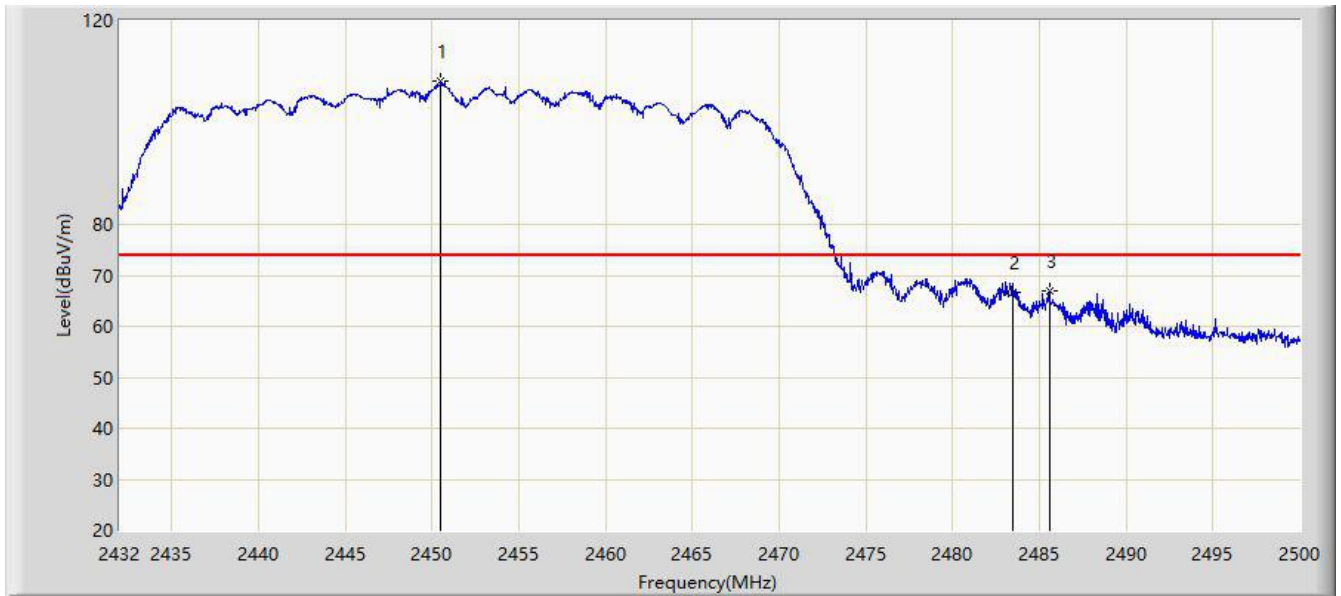

No	Flag	Mark	Frequency (MHz)	Measure Level (dBuV/m)	Reading Level (dBuV)	Margin (dB)	Limit (dBuV/m)	Factor (dB)	Type
1		*	2450.496	108.038	78.454	N/A	N/A	29.584	PK
2			2483.500	66.806	37.144	-7.194	74.000	29.662	PK
3			2485.584	66.858	37.196	-7.142	74.000	29.663	PK

Note: Measure Level (dB $\mu$ V/m) = Reading Level (dB $\mu$ V) + Factor (dB)

Factor (dB) = Cable Loss (dB) + Antenna Factor (dB/m).



Site: NS-AC1	Time: 2020/10/31 - 19:27
Limit: FCC_Part 15_15.209 RE(3m)	Engineer: Silence Liu
Probe: NS-AC1_BBHA9120D_2111	Polarity: Horizontal
EUT: MESH AP Product	Power: AC 120V/60Hz
Test Mode: Transmit by 802.11n-HT40 at channel 2452MHz (CDD Mode)	

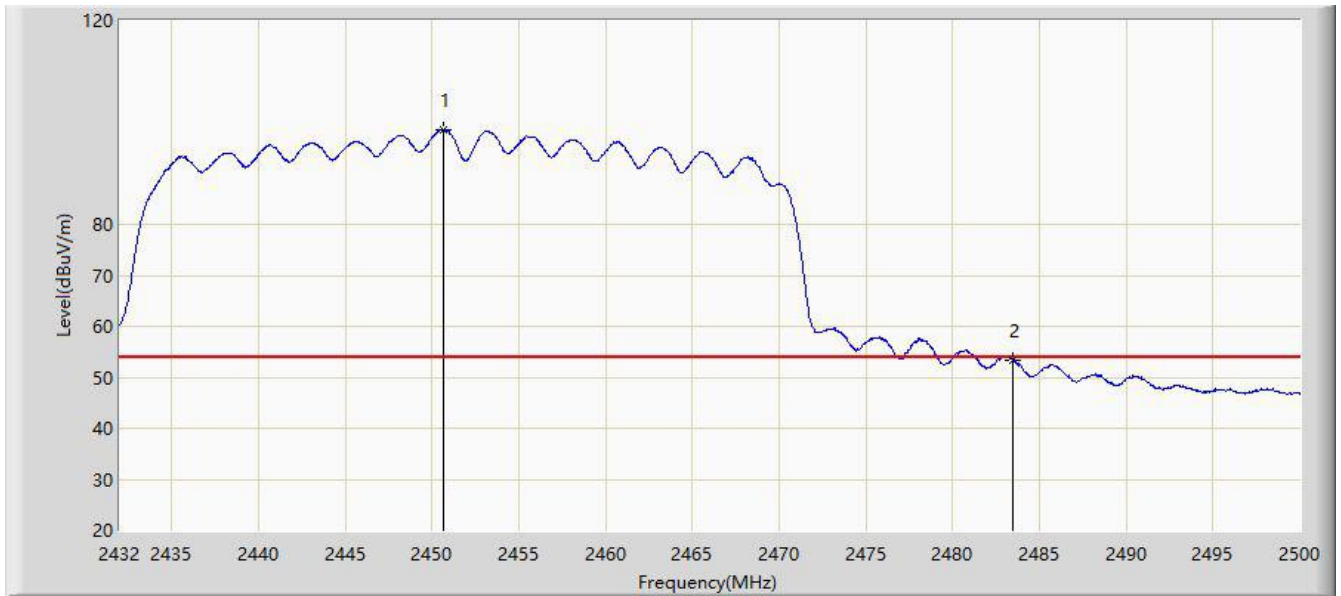

No	Flag	Mark	Frequency (MHz)	Measure Level (dBuV/m)	Reading Level (dBuV)	Margin (dB)	Limit (dBuV/m)	Factor (dB)	Type
1		*	2450.666	98.671	69.086	N/A	N/A	29.585	AV
2			2483.500	53.465	23.803	-0.535	54.000	29.662	AV

Note: Measure Level (dB $\mu$ V/m) = Reading Level (dB $\mu$ V) + Factor (dB)

Factor (dB) = Cable Loss (dB) + Antenna Factor (dB/m).

Site: NS-AC1	Time: 2020/10/31 - 19:34
Limit: FCC_Part 15_15.209 RE(3m)	Engineer: Silence Liu
Probe: NS-AC1_BBHA9120D_2111	Polarity: Vertical
EUT: MESH AP Product	Power: AC 120V/60Hz
Test Mode: Transmit by 802.11n-HT40 at channel 2452MHz (CDD Mode)	



No	Flag	Mark	Frequency (MHz)	Measure Level (dBuV/m)	Reading Level (dBuV)	Margin (dB)	Limit (dBuV/m)	Factor (dB)	Type
1		*	2448.932	101.347	71.765	N/A	N/A	29.582	PK
2			2483.500	58.982	29.320	-15.018	74.000	29.662	PK

Note: Measure Level (dB $\mu$ V/m) = Reading Level (dB $\mu$ V) + Factor (dB)

Factor (dB) = Cable Loss (dB) + Antenna Factor (dB/m).

Site: NS-AC1	Time: 2020/10/31 - 19:39
Limit: FCC_Part 15_15.209 RE(3m)	Engineer: Silence Liu
Probe: NS-AC1_BBHA9120D_2111	Polarity: Vertical
EUT: MESH AP Product	Power: AC 120V/60Hz
Test Mode: Transmit by 802.11n-HT40 at channel 2452MHz (CDD Mode)	

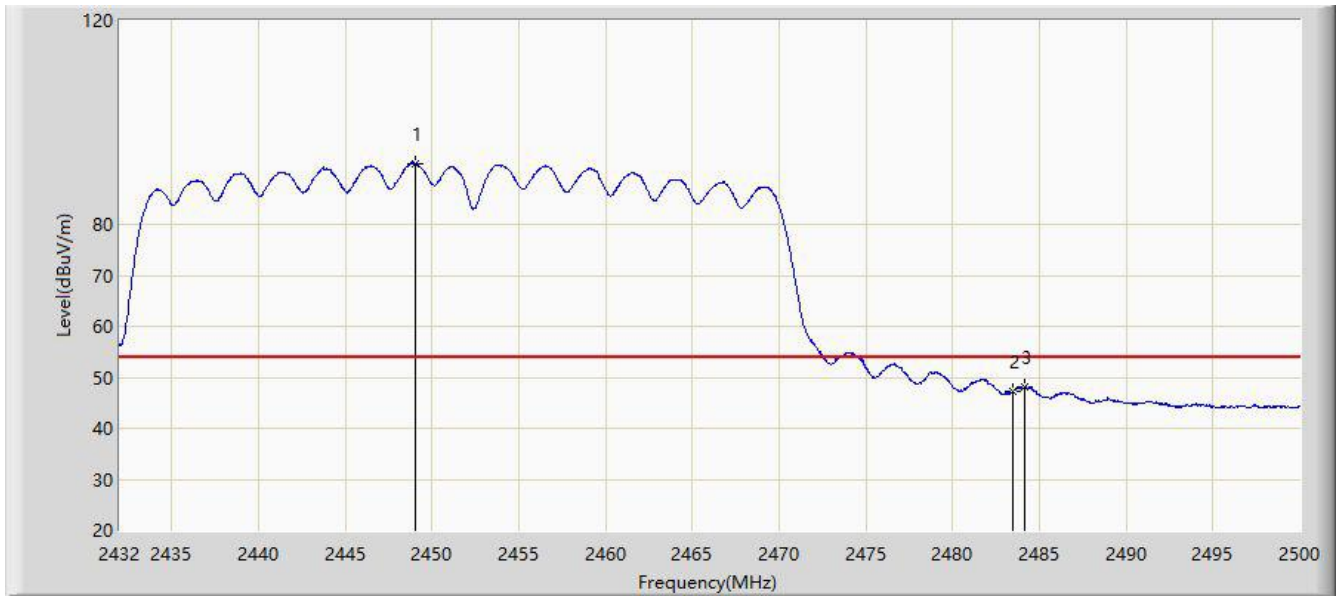

No	Flag	Mark	Frequency (MHz)	Measure Level (dBuV/m)	Reading Level (dBuV)	Margin (dB)	Limit (dBuV/m)	Factor (dB)	Type
1		*	2449.000	91.959	62.377	N/A	N/A	29.582	AV
2			2483.500	47.298	17.636	-6.702	54.000	29.662	AV
3			2484.190	48.114	18.452	-5.886	54.000	29.662	AV

Note: Measure Level (dB $\mu$ V/m) = Reading Level (dB $\mu$ V) + Factor (dB)

Factor (dB) = Cable Loss (dB) + Antenna Factor (dB/m).

## 6.8. AC Conducted Emissions Measurement

### 6.8.1. Test Limit

FCC Part 15 Subpart C Paragraph 15.207 Limits		
Frequency (MHz)	QP (dBuV)	AV (dBuV)
0.15 - 0.50	66 - 56	56 - 46
0.50 - 5.0	56	46
5.0 - 30	60	50

Note 1: The lower limit shall apply at the transition frequencies.

Note 2: The limit decreases linearly with the logarithm of the frequency in the range 0.15MHz to 0.5MHz.

### 6.8.2. Test Setup

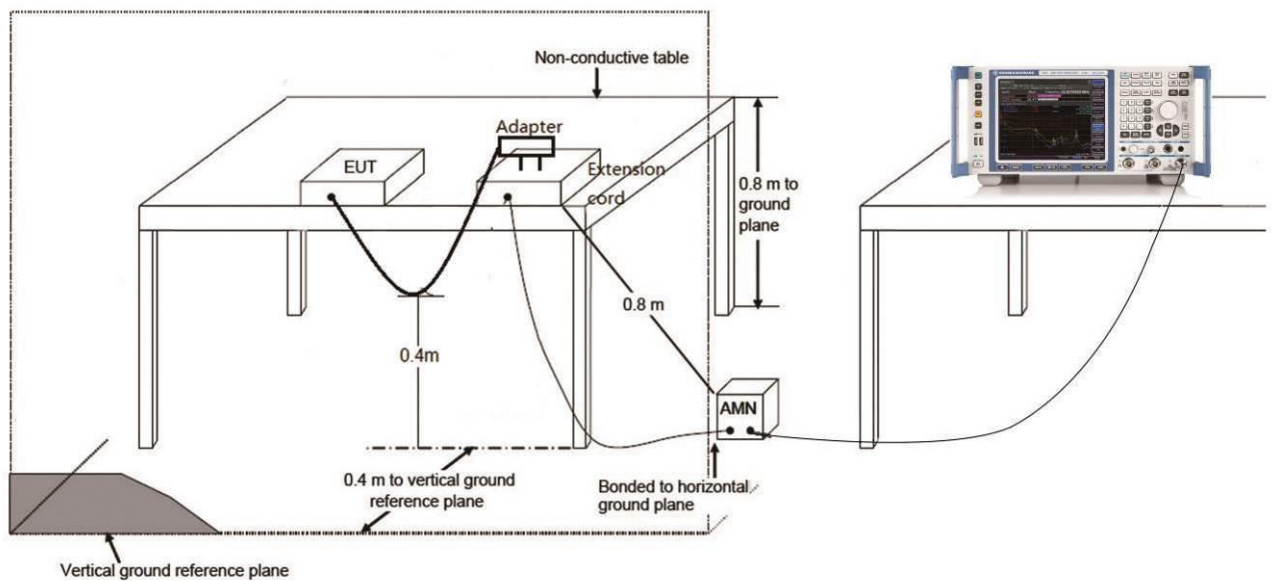

### 6.8.3. Test Result

Site: NS-SR2	Time: 2020/10/29 - 10:19
Limit: FCC_Part15.207_CE_AC Power	Engineer: Selina Zhang
Probe: ENV216_102494_Filter On	Polarity: Line
EUT: MESH AP Product	Power: AC 120V/60Hz
<b>Test Mode:</b> Transmit by 802.11n-HT20 at channel 2412MHz	

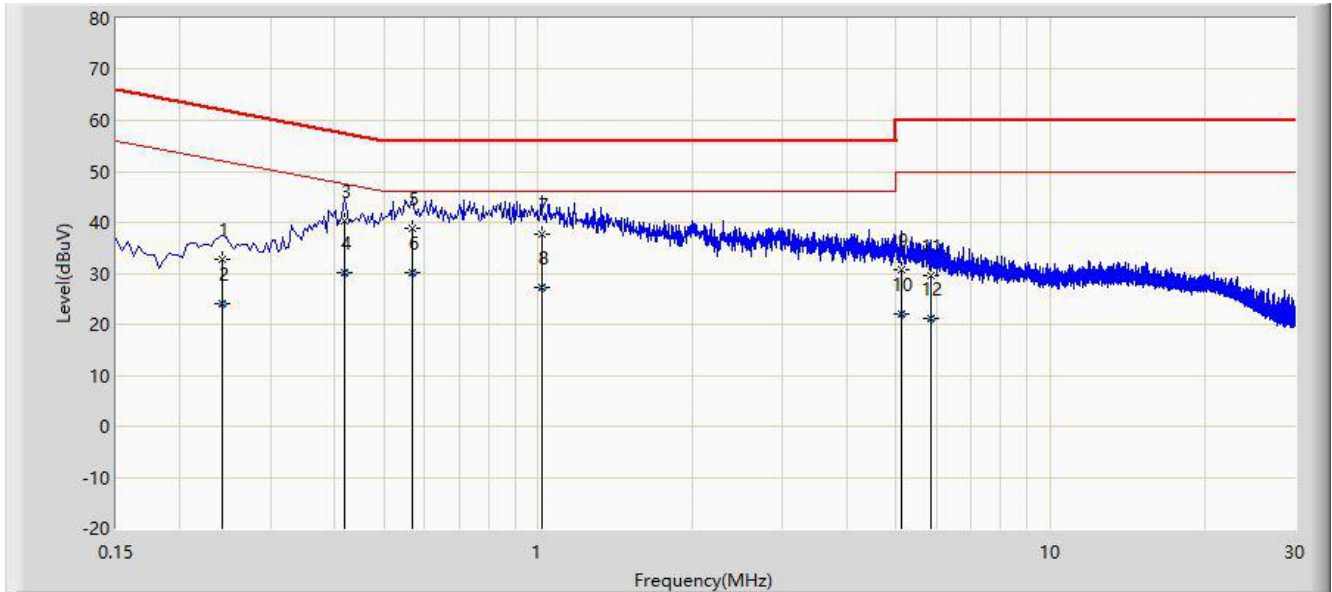

No	Flag	Mark	Frequency (MHz)	Measure Level (dBuV)	Reading Level (dBuV)	Margin (dB)	Limit (dBuV)	Factor (dB)	Type
1			0.242	32.767	23.103	-29.260	62.027	9.664	QP
2			0.242	23.963	14.299	-28.064	52.027	9.664	AV
3			0.418	40.204	30.246	-17.284	57.488	9.958	QP
4			0.418	30.108	20.151	-17.379	47.488	9.958	AV
5			0.566	38.881	28.928	-17.119	56.000	9.953	QP
6		*	0.566	30.085	20.132	-15.915	46.000	9.953	AV
7			1.014	37.779	27.990	-18.221	56.000	9.789	QP
8			1.014	27.160	17.371	-18.840	46.000	9.789	AV
9			5.130	30.710	20.996	-29.290	60.000	9.714	QP
10			5.130	21.915	12.201	-28.085	50.000	9.714	AV
11			5.838	29.700	19.968	-30.300	60.000	9.732	QP
12			5.838	21.160	11.428	-28.840	50.000	9.732	AV

Note: Measure Level (dBμV) = Reading Level (dBμV) + Factor (dB)

Factor (dB) = Cable Loss (dB) + LISN Factor (dB).

Site: NS-SR2	Time: 2020/10/29 - 10:29
Limit: FCC_Part15.207_CE_AC Power	Engineer: Selina Zhang
Probe: ENV216_102494_Filter On	Polarity: Neutral
EUT: MESH AP Product	Power: AC 120V/60Hz
<b>Test Mode:</b> Transmit by 802.11n-HT20 at channel 2412MHz	

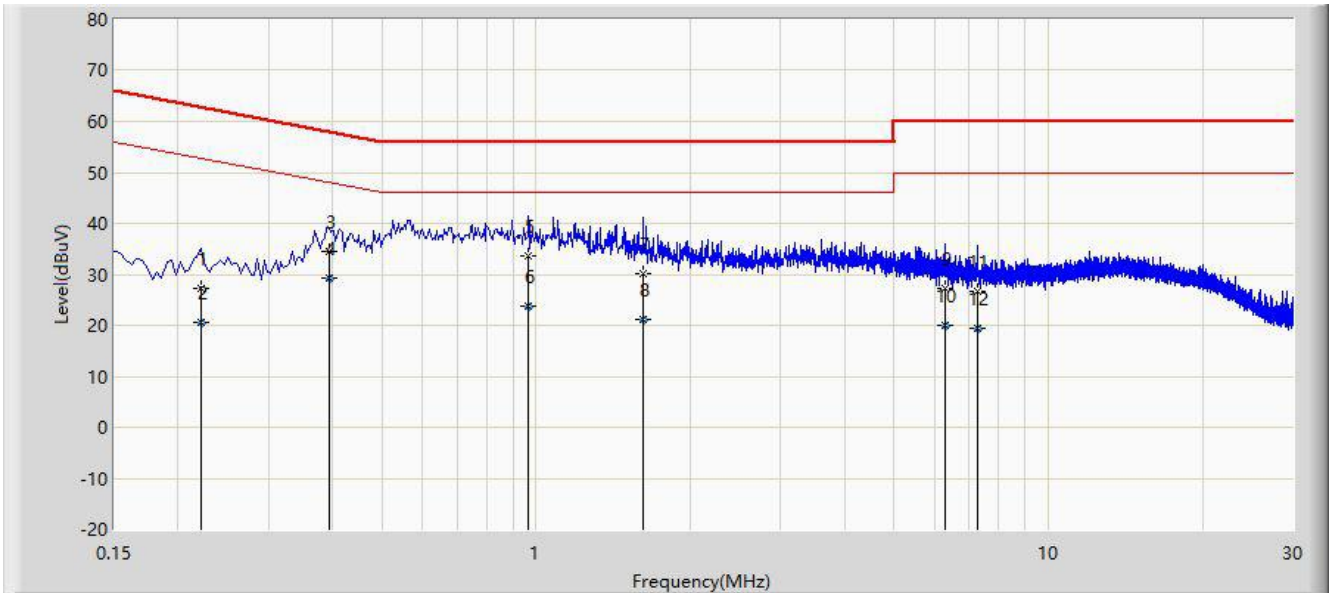

No	Flag	Mark	Frequency (MHz)	Measure Level (dBuV)	Reading Level (dBuV)	Margin (dB)	Limit (dBuV)	Factor (dB)	Type
1			0.222	27.123	17.399	-35.621	62.744	9.723	QP
2			0.222	20.441	10.717	-32.303	52.744	9.723	AV
3			0.394	34.589	24.646	-23.390	57.979	9.943	QP
4		*	0.394	29.171	19.229	-18.808	47.979	9.943	AV
5			0.966	33.603	23.806	-22.397	56.000	9.797	QP
6			0.966	23.842	14.045	-22.158	46.000	9.797	AV
7			1.618	30.247	20.549	-25.753	56.000	9.698	QP
8			1.618	21.263	11.565	-24.737	46.000	9.698	AV
9			6.266	27.324	17.579	-32.676	60.000	9.745	QP
10			6.266	19.917	10.172	-30.083	50.000	9.745	AV
11			7.290	26.735	16.975	-33.265	60.000	9.760	QP
12			7.290	19.558	9.797	-30.442	50.000	9.760	AV

Note: Measure Level (dBμV) = Reading Level (dBμV) + Factor (dB)

Factor (dB) = Cable Loss (dB) + LISN Factor (dB).

## 7. CONCLUSION

The data collected relate only the item(s) tested and show that the device is compliance with Part 15C of the FCC rules.

---

The End

## **Appendix A - Test Setup Photograph**

Refer to "2010RSZ077-UT" file.



## **Appendix B - EUT Photograph**

Refer to "2010RSU077-UE" file.