



# TEST REPORT

<p><b>KCTL Inc.</b>                  65, Sinwon-ro, Yeongtong-gu,                  Suwon-si, Gyeonggi-do, 16677, Korea                  TEL: 82-31-285-0894 FAX: 82-505-299-8311  <a href="http://www.kctl.co.kr">www.kctl.co.kr</a></p>	<p>Report No.:                  KR19-SPF0028                  Page (1) of (131)</p>	
----------------------------------------------------------------------------------------------------------------------------------------------------------------------------------------------------------------------------------------------------------	---------------------------------------------------------------------------------------------	-------------------------------------------------------------------------------------

**1. Client**

- Name : Intel Mobile Communications
- Address : 100 Center Point Circle, Suite 200 Columbia, South Carolina  
29210 USA
- Date of Receipt : 2019-07-25

**2. Use of Report** : Class II Permissive change

**3. Name of Product and Model** : WLAN and BT, 2x2 PCIe M.2 SD 1216 adapter card  
 ◦ Model Number : AX201D2W  
 ◦ Manufacturer and Country of Origin: Intel Mobile Communications / USA

**4. Host Product Name** : Notebook PC  
 ◦ Host Model Number : NP930QCG  
 ◦ Manufacturer : Samsung Electronics Co., Ltd.

**5. FCC ID Number** : PD9AX201D2

**6. Date of Test** : 2019-09-04 ~ 2019-09-11

**7. Test Standards** : IEEE 1528-2013, ANSI/IEEE C95.1, KDB Publication

**8. Test Results** : Refer to the test result in the test report

Affirmation	Tested by	Technical Manager
	Name : Choongki Lee (Signature)	Name : Jongwon Ma (Signature)

2019-10-24

**KCTL Inc.**

As a test result of the sample which was submitted from the client, this report does not guarantee the whole product quality. This test report should not be used and copied without a written agreement by KCTL Inc.

**KCTL Inc.**

65, Sinwon-ro, Yeongtong-gu,  
Suwon-si, Gyeonggi-do, 16677, Korea  
TEL: 82-31-285-0894 FAX: 82-505-299-8311  
[www.kctl.co.kr](http://www.kctl.co.kr)

Report No.:  
KR19-SPF0028  
Page (2) of (131)

**Report revision history**

Date	Revision	Page No
2019-10-24	Initial report	-

*This report shall not be reproduced except in full, without the written approval of KCTL Inc. This document may be altered or revised by KCTL Inc. personnel only, and shall be noted in the revision section of the document. Any alteration of this document not carried out by KCTL Inc. will constitute fraud and shall nullify the document.*

This test report is a general report that does not use the KOLAS accreditation mark and is not related to KOLAS accreditation.



## CONTENTS

1. General information.....	4
2. Device information.....	5
3. Specific Absorption Rate .....	17
4. SAR Measurement Procedures.....	18
5. RF Exposure Limits.....	19
6. FCC SAR General Measurement Procedures.....	20
7. RF Average Conducted Output Power.....	23
8. System Verification .....	26
9. SAR Test Results .....	28
10. Simultaneous Transmission .....	33
11. SAR Measurement Variability.....	35
12. Measurement Uncertainty.....	36
13. Test Equipment Information .....	37
14. Test System Verification Results.....	38
15. Test Results .....	43
Appendixes List.....	69
Appendix A. Calibration certificate .....	70
Appendix B. SAR Tissue Specification.....	106
Appendix C. IEEE 802.11ax SAR Power .....	107
Appendix D. Antenna Location & Distance.....	125
Appendix E. EUT Photo .....	126
Appendix F. Test Setup Photo.....	130
End of test report .....	131

## KCTL Inc.

65, Sinwon-ro, Yeongtong-gu,  
Suwon-si, Gyeonggi-do, 16677, Korea  
TEL: 82-31-285-0894 FAX: 82-505-299-8311  
[www.kctl.co.kr](http://www.kctl.co.kr)

Report No.:  
KR19-SPF0028  
Page (4) of (131)



## 1. General information

Client : Intel Mobile Communications  
Address : 100 Center Point Circle, Suite 200 Columbia, South Carolina 29210 USA  
Manufacturer : Intel Mobile Communications  
Address : 100 Center Point Circle, Suite 200 Columbia, South Carolina 29210 USA  
Contact Person : Steven Hackett / Steven.c.hackett@intel.com  
Laboratory : KCTL Inc.  
Address : 65, Sinwon-ro, Yeongtong-gu, Suwon-si, Gyeonggi-do, 16677, Korea  
Accreditations : FCC Site Designation No: KR0040, FCC Site Registration No: 687132  
VCCI Registration No. : R-3327, G-198, C-3706, T-1849  
Industry Canada Registration No. : 8035A  
KOLAS No.: KT231

### 1.1 Report Overview

This report details the results of testing carried out on the samples listed in section 2, the results contained in this test report do not relate to other samples of the same product. The manufacturer should ensure that all products in series production are in conformity with the product sample detailed in this report.

This report may only be reproduced and distributed in full. If the product in this test report is used in any configuration other than that detailed in the test report, the manufacturer must ensure the new configuration complies with all relevant standards and certification requirements. Any mention of KCTL Inc. Wireless lab or testing done by KCTL Inc. Wireless lab made in connection with the distribution or use of the tested product must be approved in writing by KCTL Inc. Wireless lab.

## 2. Device information

### 2.1 Basic description

Product Name		WLAN and BT, 2x2 PCIe M.2 SD 1216 adapter card		
Product Model Number		AX201D2W		
Product Manufacturer		Intel Mobile Communications		
Host Product Name		Notebook PC		
Host Model Number		NP930QCG		
Host Manufacturer		Samsung Electronics Co., Ltd.		
Host Product Serial Number	Radiation	1BP591ZM80073M		
	Conduction	1BP591ZM80073M		
Device Overview		Band	Operating Modes	Tx Frequency (MHz)
		WLAN 2.4 GHz	Data	2 412.0 ~ 2 462.0
		U-NII-2A	Data	5 260.0 ~ 5 320.0
		U-NII-2C	Data	5 500.0 ~ 5 720.0
		U-NII-3	Data	5 745.0 ~ 5 825.0
		Bluetooth	Data	2 402.0 ~ 2 480.0
TDWR Information		5.60 GHz ~ 5.65 GHz band (TDWR) is supported by the device.		

### 2.2 Summary of SAR Test Results

Band	Equipment Class	Highest Reported
		1g SAR (W/kg)
WLAN 2.4 GHz	DTS	0.75
U-NII-2A	NII	1.08
U-NII-2C	NII	<b>1.36</b>
U-NII-3	NII	1.21
Bluetooth	DSS/DTS	0.14
Simultaneous SAR per KDB 690783 D01v01r03		1.45

**KCTL Inc.**

65, Sinwon-ro, Yeongtong-gu,  
Suwon-si, Gyeonggi-do, 16677, Korea  
TEL: 82-31-285-0894 FAX: 82-505-299-8311  
[www.kctl.co.kr](http://www.kctl.co.kr)

Report No.:  
KR19-SPF0028  
Page (6) of (131)



## 2.3 Maximum Tune-up power

This device operates using the following maximum output power specifications. SAR values were scaled to the maximum allowed power to determine compliance per KDB Publication 447498 D01v06

### 2.3.1 Maximum WLAN Output Power (Notebook)

Band	Ant	Mode	Channel	Output Power (dBm)			
				Target	Max. Allowed	SAR Test	
WLAN 2.4 GHz	Ant 0	802.11b	All Channel	17.50	18.00	Yes	
			1	16.50	17.00	No	
		802.11g	6	17.50	18.00		
			11	14.50	15.00		
			802.11n(BW20)	1	16.50	17.00	No
		6		17.50	18.00		
		11		14.50	15.00		
		802.11n(BW40)	3	16.00	16.50	No	
			6	15.50	16.00		
			9	15.00	15.50		
		802.11ax - 20 MHz (SU_HE0)	1	16.50	17.00	No	
			6	17.50	18.00		
			11	14.50	15.00		
		802.11ax - 40 MHz (SU_HE0)	3	16.00	16.50	No	
			6	15.50	16.00		
			9	15.00	15.50		
		Ant 1	802.11b	All Channel	17.50	18.00	Yes
				1	16.25	16.75	No
	802.11g		6	17.50	18.00		
			11	15.00	15.50		
			802.11n(BW20)	1	16.25	16.75	No
	6			17.50	18.00		
	11			15.00	15.50		
	802.11n(BW40)		3	16.00	16.50	No	
			6	15.50	16.00		
			9	14.00	14.50		
	802.11ax - 20 MHz (SU_HE0)		1	16.25	16.75	No	
			6	17.50	18.00		
			11	15.00	15.50		
	802.11ax - 40 MHz (SU_HE0)		3	16.00	16.50	No	
6			15.50	16.00			
9			14.00	14.50			
MIMO	802.11n(BW20)		1	13.50	14.00	Yes	
			6	15.00	15.50		
		11	13.00	13.50			
	802.11n(BW-40)	3	13.75	14.25	No		
		6	14.00	14.50			
		9	12.50	13.00			
	802.11ax - 20 MHz (SU_HE0)	1	13.50	14.00	No		
		6	15.00	15.50			
		11	13.00	13.50			
	802.11ax - 40 MHz (SU_HE0)	3	13.50	14.00	No		
		6	13.00	13.50			
		9	12.50	13.00			

This test report shall not be reproduced, except in full, without the written approval

**KCTL Inc.**

65, Sinwon-ro, Yeongtong-gu,  
Suwon-si, Gyeonggi-do, 16677, Korea  
TEL: 82-31-285-0894 FAX: 82-505-299-8311  
[www.kctl.co.kr](http://www.kctl.co.kr)

Report No.:  
KR19-SPF0028  
Page (7) of (131)



Band	Ant	Mode	Channel	Output Power (dBm)		
				Target	Max. Allowed	SAR Test
U-NII-1 U-NII-2A	Ant 0	802.11a	All Channel	15.00	15.50	No
		802.11n(BW20)	All Channel	15.00	15.50	No
		802.11n(BW40)	All Channel	15.00	15.50	No
		802.11ac(BW20)	All Channel	15.00	15.50	No
		802.11ac(BW40)	All Channel	15.00	15.50	No
		802.11ac(BW80)	All Channel	15.00	15.50	Yes
		802.11ac(BW160)	All Channel	14.75	15.25	No
		802.11ax - 20 MHz (SU_HE0)	All Channel	15.00	15.50	No
		802.11ax - 40 MHz (SU_HE0)	All Channel	15.00	15.50	No
		802.11ax - 80 MHz (SU_HE0)	All Channel	15.00	15.50	No
	802.11ax - 160MHz (SU_HE0)	50	14.75	15.25	No	
	Ant 1	802.11a	All Channel	15.00	15.50	No
		802.11n(BW20)	All Channel	15.00	15.50	No
		802.11n(BW40)	All Channel	15.00	15.50	No
		802.11ac(BW20)	All Channel	15.00	15.50	No
		802.11ac(BW40)	All Channel	15.00	15.50	No
		802.11ac(BW80)	All Channel	15.00	15.50	Yes
		802.11ac(BW160)	All Channel	14.25	14.75	No
		802.11ax - 20 MHz (SU_HE0)	All Channel	15.00	15.50	No
		802.11ax - 40 MHz (SU_HE0)	All Channel	15.00	15.50	No
		802.11ax - 80 MHz (SU_HE0)	All Channel	15.00	15.50	No
	802.11ax - 160MHz (SU_HE0)	50	14.25	14.75	No	
	MIMO	802.11n(BW20)	All Channel	12.50	13.00	No
		802.11n(BW40)	All Channel	12.50	13.00	No
		802.11ac(BW20)	All Channel	12.50	13.00	No
		802.11an(BW40)	All Channel	12.50	13.00	No
		802.11ac(BW80)	All Channel	12.50	13.00	Yes
		802.11ac(BW160)	All Channel	12.25	12.75	No
		802.11ax - 20 MHz (SU_HE0)	All Channel	12.50	13.00	No
		802.11ax - 40 MHz (SU_HE0)	All Channel	12.50	13.00	No
		802.11ax - 80 MHz (SU_HE0)	All Channel	12.50	13.00	No
		802.11ax - 160MHz (SU_HE0)	50	12.25	12.75	No

**KCTL Inc.**

65, Sinwon-ro, Yeongtong-gu,  
Suwon-si, Gyeonggi-do, 16677, Korea  
TEL: 82-31-285-0894 FAX: 82-505-299-8311  
[www.kctl.co.kr](http://www.kctl.co.kr)

Report No.:  
KR19-SPF0028  
Page (8) of (131)



Band	Ant	Mode	Channel	Output Power (dBm)		
				Target	Max. Allowed	SAR Test
U-NII-2C	Ant 0	802.11a	All Channel	15.00	15.50	No
		802.11n(BW20)	All Channel	15.00	15.50	No
		802.11n(BW40)	All Channel	15.00	15.50	No
		802.11ac(BW20)	All Channel	15.00	15.50	No
		802.11ac(BW40)	All Channel	15.00	15.50	No
		802.11ac(BW80)	All Channel	15.00	15.50	Yes
		802.11ac(BW160)	All Channel	14.00	14.50	No
		802.11ax - 20 MHz (SU_HE0)	All Channel	15.00	15.50	No
		802.11ax - 40 MHz (SU_HE0)	All Channel	15.00	15.50	No
		802.11ax - 80 MHz (SU_HE0)	All Channel	15.00	15.50	No
	802.11ax - 160MHz (SU_HE0)	114	14.00	14.50	No	
	Ant 1	802.11a	All Channel	15.00	15.50	No
		802.11n(BW20)	All Channel	15.00	15.50	No
		802.11n(BW40)	All Channel	15.00	15.50	No
		802.11ac(BW20)	All Channel	15.00	15.50	No
		802.11ac(BW40)	All Channel	15.00	15.50	No
		802.11ac(BW80)	All Channel	15.00	15.50	Yes
		802.11ac(BW160)	All Channel	13.75	14.25	No
		802.11ax - 20 MHz (SU_HE0)	All Channel	15.00	15.50	No
		802.11ax - 40 MHz (SU_HE0)	All Channel	15.00	15.50	No
		802.11ax - 80 MHz (SU_HE0)	All Channel	15.00	15.50	No
	802.11ax - 160MHz (SU_HE0)	114	13.75	14.25	No	
	MIMO	802.11n(BW20)	All Channel	12.50	13.00	No
		802.11n(BW40)	All Channel	12.50	13.00	No
		802.11ac(BW20)	All Channel	12.50	13.00	No
		802.11an(BW40)	All Channel	12.50	13.00	No
		802.11ac(BW80)	All Channel	12.50	13.00	No
		802.11ac(BW160)	All Channel	12.75	13.25	Yes
		802.11ax - 20 MHz (SU_HE0)	All Channel	12.50	13.00	No
		802.11ax - 40 MHz (SU_HE0)	All Channel	12.50	13.00	No
		802.11ax - 80 MHz (SU_HE0)	All Channel	12.50	13.00	No
		802.11ax - 160MHz (SU_HE0)	114	12.50	13.00	No



**KCTL Inc.**

65, Sinwon-ro, Yeongtong-gu,  
Suwon-si, Gyeonggi-do, 16677, Korea  
TEL: 82-31-285-0894 FAX: 82-505-299-8311  
[www.kctl.co.kr](http://www.kctl.co.kr)

Report No.:  
KR19-SPF0028  
Page (9) of (131)



Band	Ant	Mode	Channel	Output Power (dB m)		
				Target	Max. Allowed	SAR Test
U-NII-3	Ant 0	802.11a	All Channel	15.00	15.50	No
		802.11n(BW20)	All Channel	15.00	15.50	No
		802.11n(BW40)	All Channel	15.00	15.50	No
		802.11ac(BW20)	All Channel	15.00	15.50	No
		802.11ac(BW40)	All Channel	15.00	15.50	No
		802.11ac(BW80)	All Channel	15.00	15.50	Yes
		802.11ax - 20 MHz (SU_HE0)	All Channel	15.00	15.50	No
		802.11ax - 40 MHz (SU_HE0)	All Channel	15.00	15.50	No
	802.11ax - 80 MHz (SU_HE0)	All Channel	15.00	15.50	No	
	Ant 1	802.11a	All Channel	15.00	15.50	No
		802.11n(BW20)	All Channel	15.00	15.50	No
		802.11n(BW40)	All Channel	15.00	15.50	No
		802.11ac(BW20)	All Channel	15.00	15.50	No
		802.11ac(BW40)	All Channel	15.00	15.50	No
		802.11ac(BW80)	All Channel	15.00	15.50	Yes
		802.11ax - 20 MHz (SU_HE0)	All Channel	15.00	15.50	No
		802.11ax - 40 MHz (SU_HE0)	All Channel	15.00	15.50	No
	802.11ax - 80 MHz (SU_HE0)	All Channel	15.00	15.50	No	
	MIMO	802.11n(BW20)	All Channel	12.50	13.00	No
		802.11n(BW40)	All Channel	12.50	13.00	No
		802.11ac(BW20)	All Channel	12.50	13.00	No
		802.11an(BW40)	All Channel	12.50	13.00	No
		802.11ac(BW80)	All Channel	12.50	13.00	Yes
		802.11ax - 20 MHz (SU_HE0)	All Channel	12.50	13.00	No
		802.11ax - 40 MHz (SU_HE0)	All Channel	12.50	13.00	No
	802.11ax - 80 MHz (SU_HE0)	All Channel	12.50	13.00	No	

**KCTL Inc.**

65, Sinwon-ro, Yeongtong-gu,  
Suwon-si, Gyeonggi-do, 16677, Korea  
TEL: 82-31-285-0894 FAX: 82-505-299-8311  
[www.kctl.co.kr](http://www.kctl.co.kr)

Report No.:  
KR19-SPF0028  
Page (10) of (131)



### 2.3.2 Maximum WLAN Output Power (Tablet)

Band	Ant	Mode	Channel	Output Power (dB m)		
				Target	Max. Allowed	SAR Test
WLAN 2.4 GHz	Ant 0	802.11b	All Channel	15.50	<b>16.00</b>	<b>Yes</b>
		802.11g	11	14.50	<b>15.00</b>	No
			Except 11	15.50	<b>16.00</b>	No
		802.11n(BW20)	11	14.50	<b>15.00</b>	No
			Except 11	15.50	<b>16.00</b>	No
		802.11n(BW40)	9	15.00	<b>15.50</b>	No
	Except 9		15.50	<b>16.00</b>	No	
	Ant 1	802.11ax - 20 MHz (SU_HE0)	11	14.50	<b>15.00</b>	No
			Except 11	15.50	<b>16.00</b>	No
		802.11ax - 40 MHz (SU_HE0)	9	15.00	<b>15.50</b>	No
			Except 11	15.50	<b>16.00</b>	No
		802.11n(BW20)	All Channel	15.50	<b>16.00</b>	<b>Yes</b>
			6	15.50	<b>15.50</b>	No
	Except 6		15.00	<b>16.00</b>	No	
	6		15.50	<b>15.50</b>	No	
	802.11n(BW40)	9	14.00	<b>14.50</b>	No	
		Except 9	15.50	<b>16.00</b>	No	
	802.11ax - 20 MHz (SU_HE0)	11	15.00	<b>15.50</b>	No	
		Except 11	15.50	<b>16.00</b>	No	
	802.11ax - 40 MHz (SU_HE0)	9	14.00	<b>14.50</b>	No	
Except 9		15.50	<b>16.00</b>	No		
MIMO	802.11n(BW20)	All Channel	13.00	<b>13.50</b>	No	
		3	13.00	<b>13.50</b>	No	
		3	13.00	<b>13.50</b>	No	
	802.11n(BW40)	6	14.00	<b>14.50</b>	<b>Yes</b>	
		9	12.50	<b>13.00</b>	No	
	802.11ax - 20 MHz (SU_HE0)	All Channel	13.00	<b>13.50</b>	No	
802.11ax - 40 MHz (SU_HE0)	9	12.50	<b>13.00</b>	No		
	Except 9	13.00	<b>13.50</b>	No		

**KCTL Inc.**

65, Sinwon-ro, Yeongtong-gu,  
Suwon-si, Gyeonggi-do, 16677, Korea  
TEL: 82-31-285-0894 FAX: 82-505-299-8311  
[www.kctl.co.kr](http://www.kctl.co.kr)

Report No.:  
KR19-SPF0028  
Page (11) of (131)



Band	Ant	Mode	Channel	Output Power (dB m)		
				Target	Max. Allowed	SAR Test
U-NII-1 U-NII-2A	Ant 0	802.11a	All Channel	10.00	10.50	No
		802.11n(BW20)	All Channel	10.00	10.50	No
		802.11n(BW40)	All Channel	10.00	10.50	No
		802.11ac(BW20)	All Channel	10.00	10.50	No
		802.11ac(BW40)	All Channel	10.00	10.50	No
		802.11ac(BW80)	All Channel	10.00	10.50	Yes
		802.11ac(BW160)	All Channel	10.00	10.50	No
		802.11ax - 20 MHz (SU_HE0)	All Channel	10.00	10.50	No
		802.11ax - 40 MHz (SU_HE0)	All Channel	10.00	10.50	No
		802.11ax - 80 MHz (SU_HE0)	All Channel	10.00	10.50	No
	802.11ax - 160MHz (SU_HE0)	50	10.00	10.50	No	
	Ant 1	802.11a	All Channel	12.00	12.50	No
		802.11n(BW20)	All Channel	12.00	12.50	No
		802.11n(BW40)	All Channel	12.00	12.50	No
		802.11ac(BW20)	All Channel	12.00	12.50	No
		802.11ac(BW40)	All Channel	12.00	12.50	No
		802.11ac(BW80)	All Channel	12.00	12.50	Yes
		802.11ac(BW160)	All Channel	12.00	12.50	No
		802.11ax - 20 MHz (SU_HE0)	All Channel	12.00	12.50	No
		802.11ax - 40 MHz (SU_HE0)	All Channel	12.00	12.50	No
		802.11ax - 80 MHz (SU_HE0)	All Channel	12.00	12.50	No
	802.11ax - 160MHz (SU_HE0)	50	12.00	12.50	No	
	MIMO	802.11n(BW20)	All Channel	8.50	9.00	No
		802.11n(BW40)	All Channel	8.50	9.00	No
		802.11ac(BW20)	All Channel	8.50	9.00	No
		802.11an(BW40)	All Channel	8.50	9.00	No
		802.11ac(BW80)	All Channel	8.50	9.00	Yes
		802.11ac(BW160)	All Channel	8.50	9.00	No
		802.11ax - 20 MHz (SU_HE0)	All Channel	8.50	9.00	No
		802.11ax - 40 MHz (SU_HE0)	All Channel	8.50	9.00	No
		802.11ax - 80 MHz (SU_HE0)	All Channel	8.50	9.00	No
		802.11ax - 160MHz (SU_HE0)	50	8.50	9.00	No

**KCTL Inc.**

65, Sinwon-ro, Yeongtong-gu,  
Suwon-si, Gyeonggi-do, 16677, Korea  
TEL: 82-31-285-0894 FAX: 82-505-299-8311  
[www.kctl.co.kr](http://www.kctl.co.kr)

Report No.:  
KR19-SPF0028  
Page (12) of (131)



Band	Ant	Mode	Channel	Output Power (dB m)		
				Target	Max. Allowed	SAR Test
U-NII-2C	Ant 0	802.11a	All Channel	9.00	9.50	No
		802.11n(BW20)	All Channel	9.00	9.50	No
		802.11n(BW40)	All Channel	9.00	9.50	No
		802.11ac(BW20)	All Channel	9.00	9.50	No
		802.11ac(BW40)	All Channel	9.00	9.50	No
		802.11ac(BW80)	All Channel	9.00	9.50	Yes
		802.11ac(BW160)	All Channel	9.00	9.50	No
		802.11ax - 20 MHz (SU_HE0)	All Channel	9.00	9.50	No
		802.11ax - 40 MHz (SU_HE0)	All Channel	9.00	9.50	No
		802.11ax - 80 MHz (SU_HE0)	All Channel	9.00	9.50	No
	802.11ax - 160 MHz (SU_HE0)	114	9.00	9.50	No	
	Ant 1	802.11a	All Channel	12.00	12.50	No
		802.11n(BW20)	All Channel	12.00	12.50	No
		802.11n(BW40)	All Channel	12.00	12.50	No
		802.11ac(BW20)	All Channel	12.00	12.50	No
		802.11ac(BW40)	All Channel	12.00	12.50	No
		802.11ac(BW80)	All Channel	12.00	12.50	Yes
		802.11ac(BW160)	All Channel	12.00	12.50	No
		802.11ax - 20 MHz (SU_HE0)	All Channel	12.00	12.50	No
		802.11ax - 40 MHz (SU_HE0)	All Channel	12.00	12.50	No
		802.11ax - 80 MHz (SU_HE0)	All Channel	12.00	12.50	No
	802.11ax - 160MHz (SU_HE0)	114	12.00	12.50	No	
	MIMO	802.11n(BW20)	All Channel	8.00	8.50	No
		802.11n(BW40)	All Channel	8.00	8.50	No
		802.11ac(BW20)	All Channel	8.00	8.50	No
		802.11an(BW40)	All Channel	8.00	8.50	No
		802.11ac(BW80)	All Channel	8.00	8.50	Yes
		802.11ac(BW160)	All Channel	8.00	8.50	No
		802.11ax - 20 MHz (SU_HE0)	All Channel	8.00	8.50	No
		802.11ax - 40 MHz (SU_HE0)	All Channel	8.00	8.50	No
		802.11ax - 80 MHz (SU_HE0)	All Channel	8.00	8.50	No
		802.11ax - 160MHz (SU_HE0)	114	8.00	8.50	No

**KCTL Inc.**

65, Sinwon-ro, Yeongtong-gu,  
Suwon-si, Gyeonggi-do, 16677, Korea  
TEL: 82-31-285-0894 FAX: 82-505-299-8311  
[www.kctl.co.kr](http://www.kctl.co.kr)

Report No.:  
KR19-SPF0028  
Page (13) of (131)



Band	Ant	Mode	Channel	Output Power (dB m)		
				Target	Max. Allowed	SAR Test
U-NII-3	Ant 0	802.11a	All Channel	10.00	10.50	No
		802.11n(BW20)	All Channel	10.00	10.50	No
		802.11n(BW40)	All Channel	10.00	10.50	No
		802.11ac(BW20)	All Channel	10.00	10.50	No
		802.11ac(BW40)	All Channel	10.00	10.50	No
		802.11ac(BW80)	All Channel	10.00	10.50	Yes
		802.11ax - 20 MHz (SU_HE0)	All Channel	10.00	10.50	No
		802.11ax - 40 MHz (SU_HE0)	All Channel	10.00	10.50	No
	802.11ax - 80 MHz (SU_HE0)	All Channel	10.00	10.50	No	
	Ant 1	802.11a	All Channel	12.00	12.50	No
		802.11n(BW20)	All Channel	12.00	12.50	No
		802.11n(BW40)	All Channel	12.00	12.50	No
		802.11ac(BW20)	All Channel	12.00	12.50	No
		802.11ac(BW40)	All Channel	12.00	12.50	No
		802.11ac(BW80)	All Channel	12.00	12.50	Yes
		802.11ax - 20 MHz (SU_HE0)	All Channel	12.00	12.50	No
		802.11ax - 40 MHz (SU_HE0)	All Channel	12.00	12.50	No
	802.11ax - 80 MHz (SU_HE0)	All Channel	12.00	12.50	No	
	MIMO	802.11n(BW20)	All Channel	8.50	9.00	No
		802.11n(BW40)	All Channel	8.50	9.00	No
		802.11ac(BW20)	All Channel	8.50	9.00	No
		802.11ac(BW40)	All Channel	8.50	9.00	No
		802.11ac(BW80)	All Channel	8.50	9.00	Yes
		802.11ax - 20 MHz (SU_HE0)	All Channel	8.50	9.00	No
802.11ax - 40 MHz (SU_HE0)		All Channel	8.50	9.00	No	
802.11ax - 80 MHz (SU_HE0)	All Channel	8.50	9.00	No		

### 2.3.3 Maximum Bluetooth Output Power (Notebook & Tablet)

Band	Ant	Mode	Channel	Output Power (dB m)		
				Target	Max. Allowed	SAR Test
Bluetooth	Ant 1	BDR(GFSK)	All Channel	9.50	11.00	Yes
		EDR ( $\pi/4$ DQPSK)	All Channel	5.50	7.00	No
		EDR(8DPSK)	All Channel	5.50	7.00	No
		LE(GFSK)	All Channel	5.50	7.00	No

# KCTL Inc.

65, Sinwon-ro, Yeongtong-gu,  
Suwon-si, Gyeonggi-do, 16677, Korea  
TEL: 82-31-285-0894 FAX: 82-505-299-8311  
[www.kctl.co.kr](http://www.kctl.co.kr)

Report No.:  
KR19-SPF0028  
Page (14) of (131)



## 2.3.3.1 Bluetooth Duty Factor

Mode	Packet	On Time (ms)	On-Off Time (ms)	Duty Cycle (%)	Duty Cycle Compensate Factor
BDR(GFSK)	DH5	2.88	3.75	76.8	1.302

## 2.3.3.2 Bluetooth Power Measurement Setup



## 2.3.3.3 Bluetooth Duty Plot

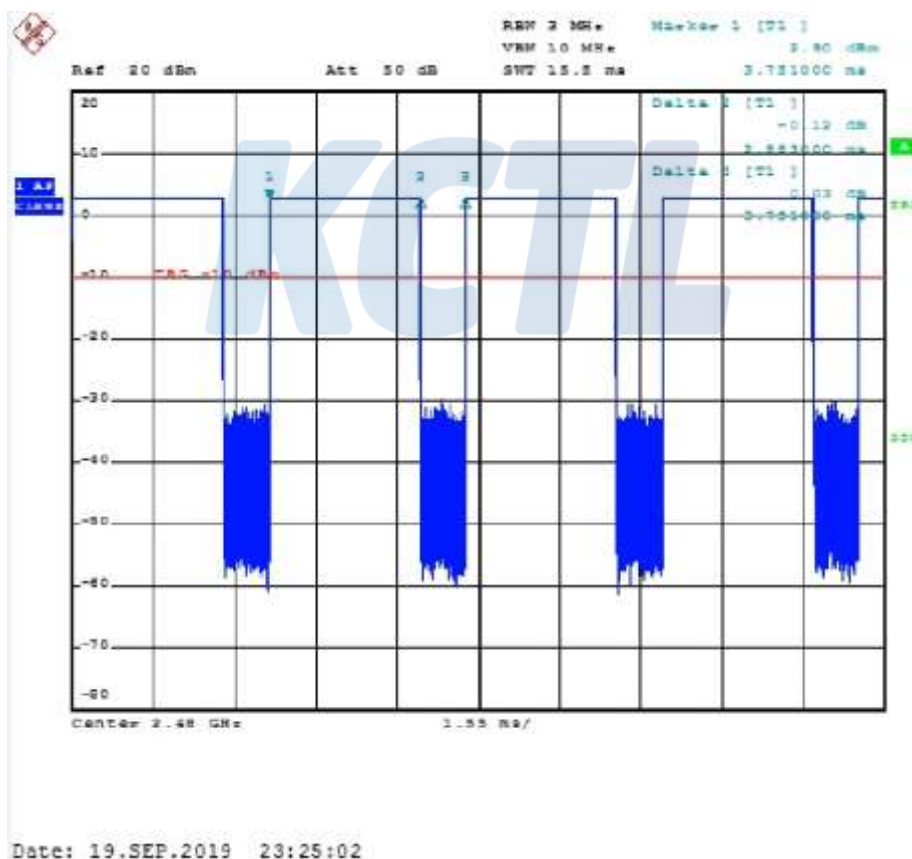

## 2.4 SAR Test Configurations

### 2.4.1 DUT Antenna Locations

The device is a 2-in-1 model that operations as a laptop when folded 90 degrees and as a tablet when folded 360 degrees.

When in tablet mode the overall dimensions of this device are > 20 cm.

A diagram showing the location of the device antennas can be found in Appendix D.

### 2.4.2 SAR Test Exclusion Considerations(Tablet Mode)

Band / Ant.	Freq. [MHz]	Output Power		Separation distances [mm]					SAR Exemption				
		dBm	mW	Rear	Left	Right	Top	Bot.	Rear	Left	Right	Top	Bot.
2.4 GHz Main	2 462	16.0	40	5	5	290.01	64.835	91.865	12.55 Measure	12.55 Measure	N/A	244mW EXEMPT	514mW EXEMPT
U-NII-2A Main	5 320	10.5	11	5	5	290.01	64.835	91.865	5.07 Measure	5.07 Measure	N/A	213mW EXEMPT	484mW EXEMPT
U-NII-2C Main	5 720	9.5	9	5	5	290.01	64.835	91.865	4.30 Measure	4.30 Measure	N/A	211mW EXEMPT	481mW EXEMPT
U-NII-3 Main	5 825	10.5	11	5	5	290.01	64.835	91.865	5.31 Measure	5.31 Measure	N/A	211mW EXEMPT	481mW EXEMPT
2.4 GHz Aux	2 462	16.0	40	5	290.01	5	64.835	91.865	12.55 Measure	N/A	12.55 Measure	244mW EXEMPT	514mW EXEMPT
U-NII-2A Aux	5 320	12.5	18	5	290.01	5	64.835	91.865	8.30 Measure	N/A	8.30 Measure	213mW EXEMPT	484mW EXEMPT
U-NII-2C Aux	5 720	12.5	18	5	290.01	5	64.835	91.865	8.61 Measure	N/A	8.61 Measure	211mW EXEMPT	481mW EXEMPT
U-NII-3 Aux	5 825	12.5	18	5	290.01	5	64.835	91.865	8.69 Measure	N/A	8.69 Measure	211mW EXEMPT	481mW EXEMPT
Bluetooth Aux	2 480	11.0	13	5	290.01	5	64.835	91.865	4.09 Measure	N/A	4.09 Measure	244mW EXEMPT	514mW EXEMPT

Note 1: For distances < 5mm, a distance of 5mm is used to determine SAR exclusion and estimated SAR value.

Note 2: Output power is the maximum rated power (including tune-up or manufacturing tolerances) and includes source-based averaging.

Note 3: If the antenna separation distance is > 50mm then the value listed is the output power threshold, above which SAR measurement is required. For separation <= 50mm the value is the KDB 447498 calculated value and must be less than 3.0 for SAR exemption.

Note 4: Formulas round separation distance to nearest mm and power to nearest mW before calculating thresholds or exemption values.

Device Type	Band / Ant.	Device Edge for SAR Testing					
		Front	Rear	Left Edge	Right Edge	Top	Bottom
Notebook	WLAN & Bluetooth	No	Yes	No	No	No	No
Tablet	WLAN Main	No	Yes	Yes	No	No	No
	WLAN Aux	No	Yes	No	Yes	No	No
	WLAN MIMO	No	Yes	Yes	Yes	No	No
	Bluetooth Aux	No	Yes	No	Yes	No	No

**KCTL Inc.**

65, Sinwon-ro, Yeongtong-gu,  
Suwon-si, Gyeonggi-do, 16677, Korea  
TEL: 82-31-285-0894 FAX: 82-505-299-8311  
[www.kctl.co.kr](http://www.kctl.co.kr)

Report No.:  
KR19-SPF0028  
Page (16) of (131)



## 2.5 SAR Test Methods and Procedures

The tests documented in this report were performed in accordance with IEEE 1528-2013 and the following published KDB procedures:

- IEEE 1528-2013
- 248227 D01 802.11 Wi-Fi SAR v02r02
- 447498 D01 General RF Exposure Guidance v06
- 865664 D01 SAR measurement 100 MHz to 6 GHz v01r04
- 865664 D02 RF Exposure Reporting v01r02
- 616217 D04 SAR for laptop and tablets v01r02
- October 2016 TCB Workshop Notes (Bluetooth Duty Factor)
- April 2019 TCB Workshop Notes (Tissue Simulating Liquids)





### 3. Specific Absorption Rate

#### 3.1 Introduction

The SAR is related to the rate at which energy is absorbed per unit mass in an object exposed to a radio field. The SAR distribution in a biological body is complicated and is usually carried out by experimental techniques or numerical modeling. The standard recommends limits for two tiers of groups, occupational / controlled and general population/uncontrolled, based on a person's awareness and ability to exercise control over his or her exposure. In general, occupational/controlled exposure limits are higher than the limits for general population/uncontrolled.

#### 3.2 SAR Definition

The SAR definition is the time derivative (rate) of the incremental energy (dW) absorbed by (dissipated in) an incremental mass (dm) contained in a volume element (dv) of a given density ( $\rho$ ). The equation description is as below:

$$\text{SAR} = \frac{d}{dt} \left( \frac{dW}{dm} \right) = \frac{d}{dt} \left( \frac{dW}{\rho dv} \right)$$

SAR is expressed in units of Watts per kilogram (W/kg)

SAR measurement can be either related to the temperature elevation in tissue by

$$\text{SAR} = C \left( \frac{\delta T}{\delta t} \right)$$

Where: C is the specific heat capacity,  $\delta T$  is the temperature rise and  $\delta t$  is the exposure duration, or related to the electrical field in the tissue by

$$\text{SAR} = \frac{\sigma |E|^2}{\rho}$$

Where:  $\sigma$  is the conductivity of the tissue,  $\rho$  is the mass density of the tissue and E is the RMS electrical field strength. However for evaluating SAR of low power transmitter, electrical field measurement is typically applied.

## 4. SAR Measurement Procedures

### 4.1 SAR Scan Procedures

#### Step 1: Power Reference Measurement

The Power Reference Measurement and Power Drift Measurements are for monitoring the power drift of the device under test in the batch process. The Minimum distance of probe sensors to surface determines the closest measurement point to phantom surface. The minimum distance of probe sensors to surface is 1.4 mm. This distance cannot be smaller than the Distance of sensor calibration points to probe tip as defined in the probe properties.

#### Step 2: Area Scan & Zoom Scan

The Area Scan is used as a fast scan in two dimensions to find the area of high field values, before doing a fine measurement around the hot spot and Zoom Scans are used to assess the peak spatial SAR values within a cubic averaging volume containing 1 g and 10 g of simulated tissue. If only one Zoom Scan follows the Area Scan, then only the absolute maximum will be taken as reference. For cases where multiple maximums are detected, the number of Zoom Scans has to be increased accordingly. Area Scan & Zoom Scan Parameters extracted from KDB 865664 D01 SAR Measurement 100 MHz to 6 GHz v01r04.

		≤ 3 GHz	> 3 GHz
Maximum distance from closest measurement point (geometric center of probe sensors) to phantom surface		5 mm ± 1 mm	$\frac{1}{2} \cdot \delta \cdot \ln(2)$ mm 0.5 mm
Maximum probe angle from probe axis to phantom surface normal at the measurement location		$30^\circ \pm 1^\circ$	$20^\circ \pm 1^\circ$
Maximum area scan spatial resolution: $\Delta x_{Area}, \Delta y_{Area}$		$\leq 2$ GHz: ≤ 15 mm 2 – 3 GHz: ≤ 12 mm	3 – 4 GHz: ≤ 12 mm 4 – 6 GHz: ≤ 10 mm
		When the x or y dimension of the test device, in the measurement plane orientation, is smaller than the above, the measurement resolution must be ≤ the corresponding x or y dimension of the test device with at least one measurement point on the test device.	
Maximum zoom scan spatial resolution: $\Delta x_{Zoom}, \Delta y_{Zoom}$		$\leq 2$ GHz: ≤ 8 mm 2 – 3 GHz: ≤ 5 mm*	3 – 4 GHz: ≤ 5 mm* 4 – 6 GHz: ≤ 4 mm*
Maximum zoom scan spatial resolution, normal to phantom surface	uniform grid: $\Delta z_{Zoom}(n)$	≤ 5 mm	3 – 4 GHz: ≤ 4 mm 4 – 5 GHz: ≤ 3 mm 5 – 6 GHz: ≤ 2 mm
	graded grid	≤ 4 mm	3 – 4 GHz: ≤ 3 mm 4 – 5 GHz: ≤ 2.5 mm 5 – 6 GHz: ≤ 2 mm
	$\Delta z_{Zoom}(1)$ : between 1st two points closest to phantom surface  $\Delta z_{Zoom}(n>1)$ : between subsequent points	≤ 1.5 · $\Delta z_{Zoom}(n-1)$ mm	
Minimum zoom scan volume	x, y, z	≥ 30 mm	3 – 4 GHz: ≥ 28 mm 4 – 5 GHz: ≥ 25 mm 5 – 6 GHz: ≥ 22 mm
Note: $\delta$ is the penetration depth of a plane-wave at normal incidence to the tissue medium; see IEEE Std 1528-2013 for details. * When zoom scan is required and the reported SAR from the area scan based 1-g SAR estimation procedures of KDB Publication 447498 is ≤ 1.4 W/kg, ≤ 8 mm, ≤ 7 mm and ≤ 5 mm zoom scan resolution may be applied, respectively, for 2 GHz to 3 GHz, 3 GHz to 4 GHz and 4 GHz to 6 GHz.			

#### Step 3: Power drift measurement

The Power Drift Measurement measures the field at the same location as the most recent power reference measurement within the same procedure, and with the same settings. The Power Drift Measurement gives the field difference in dB from the reading conducted within the last Power Reference Measurement. This allows a user to monitor the power drift of the device under test within a batch process. The measurement procedure is the same as Step 1.

## 5. RF Exposure Limits

**UNCONTROLLED ENVIRONMENTS** are defined as locations where there is the exposure of individuals who have no knowledge or control of their exposure. The general population/uncontrolled exposure limits are applicable to situations in which the general public may be exposed or in which persons who are exposed as a consequence of their employment may not be made fully aware of the potential for exposure or cannot exercise control over their exposure. Members of the general public would come under this category when exposure is not employment-related; for example, in the case of a wireless transmitter that exposes persons in its vicinity.

**CONTROLLED ENVIRONMENTS** are defined as locations where there is exposure that may be incurred by persons who are aware of the potential for exposure, (i.e. as a result of employment or occupation). In general, occupational/controlled exposure limits are applicable to situations in which persons are exposed as a consequence of their employment, who have been made fully aware of the potential for exposure and can exercise control over their exposure. This exposure category is also applicable when the exposure is of a transient nature due to incidental passage through a location where the exposure levels may be higher than the general population/uncontrolled limits, but the exposed person is fully aware of the potential for exposure and can exercise control over his or her exposure by leaving the area or by some other appropriate means.

Human Exposure	Uncontrolled Environment General Population	Controlled Environment Occupational
<b>Partial Peak SAR</b> <sup>1)</sup> (Partial)	1.60 mW/g	8.00 mW/g
<b>Partial Average SAR</b> <sup>2)</sup> (Whole Body)	0.08 mW/g	0.40 mW/g
<b>Partial Peak SAR</b> <sup>3)</sup> (Hands/Feet/Ankle/Wrist)	4.00 mW/g	20.00 mW/g

- 1) The spatial Peak value of the SAR averaged over any 1g gram of tissue (defined as a tissue volume in the shape of a cube) and over the appropriate averaging time.
- 2) The spatial Average value of the SAR averaged over the whole body.
- 3) The Spatial Peak value of the SAR averaged over any 10 grams of tissue (defined as a tissue volume in the shape of a cube) and over the appropriate averaging time.

## KCTL Inc.

65, Sinwon-ro, Yeongtong-gu,  
Suwon-si, Gyeonggi-do, 16677, Korea  
TEL: 82-31-285-0894 FAX: 82-505-299-8311  
[www.kctl.co.kr](http://www.kctl.co.kr)

Report No.:  
KR19-SPF0028  
Page (20) of (131)



## 6. FCC SAR General Measurement Procedures

### 6.1 Measured and Reported SAR

Per FCC KDB Publication 447498 D01v06, When SAR is not measured at the maximum power level allowed for production units, the results must be scaled to the maximum tune-up tolerance limit according to the power applied to the individual channels tested to determine compliance. For simultaneous transmission, the measured aggregate SAR must be scaled according to the sum of the differences between the maximum tune-up tolerance and actual power used to test each transmitter. When SAR is measured at or scaled to the maximum tune-up tolerance limit, the results are referred to as reported SAR. Test highest reported SAR results are identified on the grant of equipment authorization according to procedures in KDB 690783 D01v01r03.

### 6.2 SAR Testing with 802.11 Transmitters

The normal network operating configurations are not suitable for measuring the SAR of 802.11 a/b/g transmitters. Unpredictable fluctuations in network traffic and antenna diversity conditions can introduce undesirable variations in SAR results. The SAR for these devices should be measured using chipset based test mode software to ensure the results are consistent and reliable.

#### 6.2.1 General Device Setup

Chipset based test mode software is hardware dependent and generally varies among manufacturers. The device operating parameters established in test mode for SAR measurements must be identical to those programmed in production units, including output power levels, amplifier gain settings and other RF performance tuning parameters. A periodic duty factor is required for current generation SAR systems to measure SAR. When 802.11 frame gaps are accounted for in the transmission, a maximum transmission duty factor of 92 – 96% is typically achievable in most test mode configurations. A minimum transmission duty factor of 85% is required to avoid certain hardware and device implementation issues related to wide range SAR scaling. The reported SAR is scaled to 100% transmission duty factor to determine compliance at the maximum tune-up tolerance limit.

#### 6.2.2 U-NII-1 and U-NII-2A

For devices that operate in both U-NII-1 and U-NII-2A bands, when the same maximum output power is specified for both bands, SAR measurement using OFDM SAR test procedures is not required for U-NII-1 unless the highest reported SAR for U-NII-2A is  $> 1.2$  W/kg. When different maximum output powers is not required unless the highest reported SAR for the U-NII band with the higher maximum output power, adjusted by the ratio of lower to higher specified maximum output power for the two bands, is  $> 1.2$  W/kg. When 10g SAR measurement is considered, a factor of 2.5 is applied to the thresholds above.

#### 6.2.3 U-NII-2C and U-NII-3

The frequency range covered by U-NII-2C and U-NII-3 is 380 MHz (5.47 – 5.85 GHz), which requires a minimum of at least two SAR probe calibration frequency points to support SAR measurements. When Terminal Doppler Weather Radar (TDWR) restriction applies, the channels at 5.60 – 5.65 GHz in U-NII-2C band must be disabled with acceptable mechanisms and documented in the equipment certification. Unless band gap channels are permanently disabled, SAR must be considered for

these channels. When band gap channels are disabled, each band is tested independently according to the normally required OFDM SAR measurement and probe calibration frequency point requirements.

#### **6.2.4 Initial Test Position Procedure**

For exposure conditions with multiple test positions, such as handset operating next to the ear, devices with hotspot mode or UMPC mini-tablet, procedures for initial test position can be applied. Using the transmission mode determined by the DSSS procedure or initial test configuration, area scans are measured for all positions in an exposure condition. The test position with the highest extrapolated (peak) SAR is used as the initial test position. When reported SAR for the initial test position is  $\leq 0.4$  W/kg, no additional testing for the remaining test positions is required. Otherwise, SAR is evaluated at the subsequent highest peak SAR positions until the reported SAR result is  $\leq 0.8$  W/kg or all test positions are measured.

#### **6.2.5 2.4 GHz SAR Test Requirement**

SAR is measured for 2.4 GHz 802.11b DSSS using either the fixed test position or, when applicable, the initial test position procedure. SAR test reduction is determined according to the following.

- 1) When the reported SAR of the highest measured maximum output power channel for the exposure configuration is  $\leq 0.8$  W/kg, no further SAR testing is required for 802.11b DSSS in that exposure configuration.
- 2) When the reported SAR is  $> 0.8$  W/kg, SAR is required for that position using the next highest measured output power channel; i.e., all channels require testing.

2.4 GHz 802.11g/n OFDM are additionally evaluated for SAR if highest reported SAR for 802.11b, adjusted by the ratio of the OFDM to DSSS specified maximum output power, is  $> 1.2$  W/kg. When SAR is required for OFDM modes in 2.4 GHz band, the Initial Test Configuration Procedures should be followed.

#### **6.2.6 OFDM Transmission Mode and SAR Test Channel Selection**

For the 2.4 GHz and 5 GHz band, when the same maximum output power was specified for multiple OFDM transmission mode configurations in a frequency band or aggregated band, SAR is measured using the configuration with the largest channel bandwidth, lowest order modulation and lowest data rate. When the maximum output power of a channel is the same for equivalent OFDM configurations; for example, 802.11a, 802.11n and 802.11ac or 802.11g and 802.11n with the same channel bandwidth, modulation and data rate etc., the lower order 802.11 mode i.e., 802.11a, then 802.11n and 802.11ac or 802.11g then 802.11n, is used for SAR measurement. When maximum output power are the same for multiple test channels, either according to the default or additional power measurement requirements, SAR is measured using the channel closest to the middle of the frequency band or aggregated band. When there are multiple channels with the same maximum output power, SAR is measured using the higher number channel.

#### **6.2.7 Initial Test Configuration Procedure**

For OFDM, in both 2.4 and 5 GHz bands, an initial test configuration is determined for each frequency band and aggregated band, according to the transmission mode with the highest maximum output power specified for SAR measurements. When the same maximum output power is specified for multiple OFDM transmission mode configurations in a frequency band or aggregated band, SAR is measured using the configuration(s) with the largest channel bandwidth, lowest order modulation, and lowest data rate. If the average RF output powers of the highest identical transmission modes

are within 0.25 dB of each other, mid channel of the transmission mode with highest average RF output power is the initial test channel. Otherwise, the channel of the transmission mode with the highest average RF output conducted power will be the initial test configuration.

When the reported SAR is  $\leq 0.8$  W/kg, no additional measurements on other test channels are required. Otherwise, SAR is evaluated using the subsequent highest average RF output channel until the reported SAR result is  $\leq 1.2$  W/kg or all channels are measured. When there are multiple untested channels having the same subsequent highest average RF output power, the channel with higher frequency from the lowest 802.11 mode is considered for SAR measurements.

### **6.2.8 Subsequent Test Configuration Procedures**

For OFDM configurations in each frequency band and aggregated band, SAR is evaluated for initial test configuration using the fixed test position or the initial test position procedure. When the highest reported SAR (for the initial test configuration), adjusted by the ratio of the specified maximum output power of the subsequent test configuration to initial test configuration, is  $\leq 1.2$  W/kg, no additional SAR tests for the subsequent test configurations are required. When 10g SAR measurement is considered, a factor of 2.5 is applied to the thresholds above.

**KCTL**

**KCTL Inc.**

65, Sinwon-ro, Yeongtong-gu,  
Suwon-si, Gyeonggi-do, 16677, Korea  
TEL: 82-31-285-0894 FAX: 82-505-299-8311  
[www.kctl.co.kr](http://www.kctl.co.kr)

Report No.:  
KR19-SPF0028  
Page (23) of (131)



## 7. RF Average Conducted Output Power

### 7.1.1 WLAN Average Conducted Output Power (Notebook)

Band	Ant.	Mode	Conducted Powers (dBm)		
			Low	Mid	High
WLAN 2.4 GHz	Ant.0	802.11b	17.72	17.92	17.82
	Ant.1	802.11b	17.62	17.62	17.72
	Ant.0 MIMO	802.11n(BW20)	13.65	15.15	13.25
	Ant.1 MIMO	802.11n(BW20)	13.65	15.25	13.15

Band	Ant	Mode	Conducted Powers (dBm)		
			Low	Mid.	High
U-NII-1 U-NII-2A	Ant.0	802.11ac(BW80)	15.45	-	15.45
	Ant.1	802.11ac(BW80)	15.35	-	15.35
	Ant.0 MIMO	802.11ac(BW80)	12.95	-	12.95
	Ant.1 MIMO	802.11ac(BW80)	12.75	-	12.95
U-NII-2C	Ant.0	802.11ac(BW80)	15.35	15.25	15.45
	Ant.1	802.11ac(BW80)	15.45	15.35	15.35
	Ant.0 MIMO	802.11ac(BW160)	-	13.07	-
	Ant.1 MIMO	802.11ac(BW160)	-	13.07	-
U-NII-3	Ant.0	802.11ac(BW80)	-	15.35	-
	Ant.1	802.11ac(BW80)	-	15.25	-
	Ant.0 MIMO	802.11ac(BW80)	-	12.65	-
	Ant.1 MIMO	802.11ac(BW80)	-	12.75	-

**7.1.2 WLAN Average Conducted Output Power (Tablet)**

Band	Ant.	Mode	Conducted Powers (dBm)		
			Low	Mid	High
WLAN 2.4 GHz	Ant.0	802.11b	15.92	15.82	15.82
	Ant.1	802.11b	15.32	15.82	15.92
	Ant.0 MIMO	802.11n(BW20)	13.25	14.25	12.85
	Ant.1 MIMO	802.11n(BW20)	13.25	14.25	12.75

Band	Ant	Mode	Conducted Powers (dBm)		
			Low	Mid.	High
U-NII-1 U-NII-2A	Ant.0	802.11ac(BW80)	10.25	-	10.35
	Ant.1	802.11ac(BW80)	12.35	-	12.25
	Ant.0 MIMO	802.11ac(BW80)	8.85	-	8.75
	Ant.1 MIMO	802.11ac(BW80)	8.65	-	8.85
U-NII-2C	Ant.0	802.11ac(BW80)	9.45	9.35	9.25
	Ant.1	802.11ac(BW80)	12.45	12.35	12.25
	Ant.0 MIMO	802.11ac(BW80)	8.35	8.15	8.15
	Ant.1 MIMO	802.11ac(BW80)	8.25	8.35	8.25
U-NII-3	Ant.0	802.11ac(BW80)	-	10.25	-
	Ant.1	802.11ac(BW80)	-	12.25	-
	Ant.0 MIMO	802.11ac(BW80)	-	8.75	-
	Ant.1 MIMO	802.11ac(BW80)	-	8.75	-

Justification for test configurations for WLAN per KDB Publication 248227 D01v02r02:

- Power measurements were performed for the transmission mode configuration with the highest maximum output power specified for production units.
- For transmission modes with the same maximum output power specification, powers were measured for the largest channel bandwidth, lowest order modulation and lowest data rate.
- For transmission modes with identical maximum specified output power, channel bandwidth, modulation and data rates, power measurements were required for all identical configurations.
- For each transmission mode configuration, powers were measured for the highest and lowest channels; and at the mid-band channel(s) when there were at least 3 channels supported.

## Power Measurement Setup





**KCTL Inc.**

65, Sinwon-ro, Yeongtong-gu,  
Suwon-si, Gyeonggi-do, 16677, Korea  
TEL: 82-31-285-0894 FAX: 82-505-299-8311  
[www.kctl.co.kr](http://www.kctl.co.kr)

Report No.:  
KR19-SPF0028  
Page (25) of (131)

**7.2 Bluetooth Average Conducted Output Power**

Mode	Freq. [MHz]	Channel	Conducted Powers
			(dBm)
BDR_DH5 (1 Mbps)	2 402.0	0	9.20
	2 441.0	39	9.95
	2 480.0	78	10.52
BDR_2-DH5 (2 Mbps)	2 402.0	0	6.09
	2 441.0	39	6.42
	2 480.0	78	5.88
EDR_3-DH5 (3 Mbps)	2 402.0	0	6.07
	2 441.0	39	6.42
	2 480.0	78	5.89
LE	2 402.0	0	4.79
	2 440.0	19	5.19
	2 480.0	39	4.89

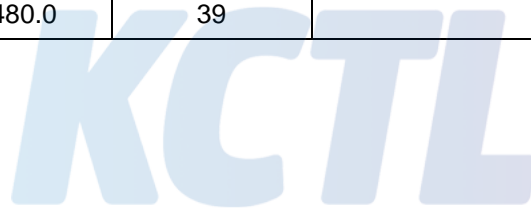

## 8. System Verification

### 8.1 Tissue Verification

The dielectric properties for this Tissue Simulant Liquids were measured by using the SPEAG Model DAK3.5 Dielectric Probe in conjunction with Agilent E5071B Network Analyzer (300 kHz – 8 500 MHz). The Conductivity ( $\sigma$ ) and Permittivity ( $\rho$ ) are listed in Table 1. For the SAR measurement given in this report. The temperature variation of the Tissue Simulant Liquids was  $(22 \pm 2)$  °C.

Freq. (MHz)	Limit/Measured	Permittivity ( $\rho$ )	Conductivity ( $\sigma$ )	Temp. (°C)
2 450.0	Recommended Limit	$39.20 \pm 5 \%$ (37.24 ~ 41.16)	$1.80 \pm 5 \%$ (1.71 ~ 1.89)	$22 \pm 2$
	Measured   2019-09-04	39.21	1.83	20.18
5 300.0	Recommended Limit	$35.90 \pm 5 \%$ (34.11 ~ 37.70)	$4.76 \pm 5 \%$ (4.52 ~ 5.00)	$22 \pm 2$
	Measure,   2019-09-05	35.28	4.82	20.75
5 600.0	Recommended Limit	$35.50 \pm 5 \%$ (33.73 ~ 37.28)	$5.07 \pm 5 \%$ (4.82 ~ 5.32)	$22 \pm 2$
	Measured   2019-09-06	34.94	5.06	20.40
5 600.0	Recommended Limit	$35.50 \pm 5 \%$ (33.73 ~ 37.28)	$5.07 \pm 5 \%$ (4.82 ~ 5.32)	$22 \pm 2$
	Measured   2019-09-11	34.87	5.16	20.73
5 800.0	Recommended Limit	$35.30 \pm 5 \%$ (33.54 ~ 37.07)	$5.27 \pm 5 \%$ (5.01 ~ 5.53)	$22 \pm 2$
	Measured   2019-09-10	36.29	5.26	20.88

<Table 1. Measurement result of Head Tissue electric parameters>

## 8.2 Test System Verification

The microwave circuit arrangement for system verification is sketched below picture. The daily system accuracy verification occurs within the flat section of the SAM phantom. A SAR measurement was performed to see if the measured SAR was within  $\pm 10\%$  from the target SAR values. The tests were conducted on the same days as the measurement of the EUT. The obtained results from the system accuracy verification are displayed in the Table 2. During the tests, the ambient temperature of the laboratory was in the range  $(22 \pm 2) ^\circ\text{C}$ , the relative humidity was in the range  $(50 \pm 20)\%$  and the liquid depth Above the ear/grid reference points was above 15 cm in all the cases. It is seen that the system is operating within its specification, as the results are within acceptable tolerance of the reference values.

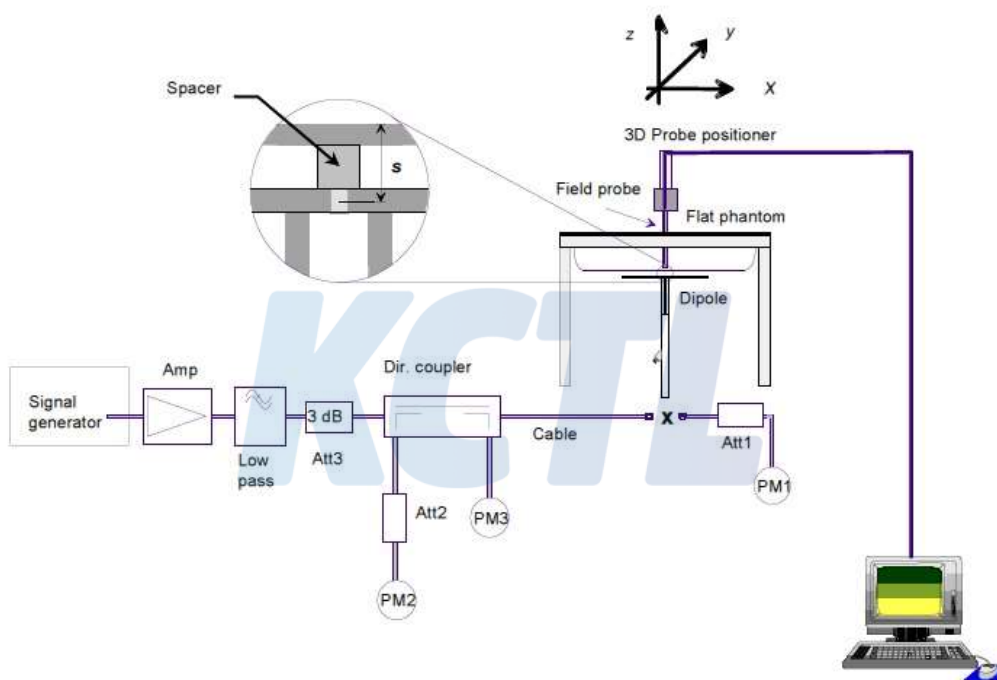

Verification Kit	Probe S/N	Frequency (MHz)	Tissue Type	Limit/Measured (Normalized to 1 W)	
				Limit	Measured
D2450V2 SN: 895	EX3DV4 SN: 3928	2 450.0	HSL	Recommended Limit 1g (Normalized)	51.30 $\pm$ 10 % (46.17 ~ 56.43)
				Measured   2019-09-04	51.80
D5GHzV2 SN: 1134	EX3DV4 SN: 3928	5 300.0	HSL	Recommended Limit 1g (Normalized)	82.30 $\pm$ 10 % (74.07 ~ 90.53)
				Measured   2019-09-05	83.30
D5GHzV2 SN: 1134	EX3DV4 SN: 3928	5 600.0	HSL	Recommended Limit 1g (Normalized)	85.30 $\pm$ 10 % (76.77 ~ 93.83)
				Measured   2019-09-06	88.00
D5GHzV2 SN: 1134	EX3DV4 SN: 3928	5 600.0	HSL	Recommended Limit 1g (Normalized)	85.30 $\pm$ 10 % (76.77 ~ 93.83)
				Measured   2019-09-11	89.40
D5GHzV2 SN: 1134	EX3DV4 SN: 3928	5 800.0	HSL	Recommended Limit 1g (Normalized)	79.20 $\pm$ 10 % (71.28 ~ 87.12)
				Measured   2019-09-10	79.90

<Table 2. Head Test System Verification Result>

**KCTL Inc.**

65, Sinwon-ro, Yeongtong-gu,  
Suwon-si, Gyeonggi-do, 16677, Korea  
TEL: 82-31-285-0894 FAX: 82-505-299-8311  
[www.kctl.co.kr](http://www.kctl.co.kr)

Report No.:  
KR19-SPF0028  
Page (28) of (131)

**9. SAR Test Results****9.1 Standalone Body SAR Test Results(Notebook)**

WLAN 2.4 GHz Band										
Mode	EUT Position	Distance (mm)	Frequency (MHz)	Measured Conducted Power (dBm)	Max. Tune-up Power (dBm)	Power Scaling Factor	Duty Cycle Compensate Factor	Measured 1g SAR (W/kg)	Scaled 1g SAR (W/kg)	Plot No.
Ant.0 802.11b	Rear	0	2437.0	17.92	18.00	1.019	1.005	0.613	<b>0.628</b>	#1
Ant.1 802.11b	Rear	0	2462.0	17.72	18.00	1.067	1.005	0.540	0.579	#2
MIMO 802.11n(BW20)	Rear	0	2437.0	15.15	15.50	1.084	1.011	0.406	0.445	#3

U-NII-2A										
Mode	EUT Position	Distance (mm)	Frequency (MHz)	Measured Conducted Power (dBm)	Max. Tune-up Power (dBm)	Power Scaling Factor	Duty Cycle Compensate Factor	Measured 1g SAR (W/kg)	Scaled 1g SAR (W/kg)	Plot No.
Ant.0 802.11 ac(BW80)	Rear	0	5290.0	15.45	15.50	1.012	1.011	0.724	0.741	#4
Ant.1 802.11 ac(BW80)	Rear	0	5290.0	15.35	15.50	1.035	1.011	0.775	<b>0.811</b>	#5
MIMO 802.11 ac(BW80)	Rear	0	5290.0	12.95	13.00	1.012	1.011	0.482	0.493	#6

U-NII-2C										
Mode	EUT Position	Distance (mm)	Frequency (MHz)	Measured Conducted Power (dBm)	Max. Tune-up Power (dBm)	Power Scaling Factor	Duty Cycle Compensate Factor	Measured 1g SAR (W/kg)	Scaled 1g SAR (W/kg)	Plot No.
Ant.0 802.11 ac(BW80)	Rear	0	5690.0	15.45	15.50	1.012	1.011	1.330	<b>1.360</b>	#7
	Rear	0	5530.0	15.35	15.50	1.035	1.011	0.903	0.945	
	Rear	0	5610.0	15.25	15.50	1.059	1.011	1.170	1.253	
Ant.1 802.11 ac(BW80)	Rear	0	5530.0	15.45	15.50	1.012	1.011	0.388	0.397	#8
MIMO 802.11ac(BW160)	Rear	0	5570.0	13.07	13.25	1.042	1.015	0.647	0.685	#9
Repeated (See Section 11)										
Ant.0 802.11 ac(BW80)	Rear	0	5690.0	15.45	15.50	1.012	1.011	1.300	1.330	

This test report shall not be reproduced, except in full, without the written approval

**KCTL Inc.**

65, Sinwon-ro, Yeongtong-gu,  
Suwon-si, Gyeonggi-do, 16677, Korea  
TEL: 82-31-285-0894 FAX: 82-505-299-8311  
[www.kctl.co.kr](http://www.kctl.co.kr)

Report No.:  
KR19-SPF0028  
Page (29) of (131)

**U-NII-3**

Mode	EUT Position	Distance (mm)	Frequency (MHz)	Measured Conducted Power (dBm)	Max. Tune-up Power (dBm)	Power Scaling Factor	Duty Cycle Compensate Factor	Measured 1g SAR (W/kg)	Scaled 1g SAR (W/kg)	Plot No.
Ant.0 802.11 ac(BW80)	Rear	0	5775.0	15.35	15.50	1.035	1.011	1.160	<b>1.214</b>	#10
Ant.1 802.11 ac(BW80)	Rear	0	5775.0	15.25	15.50	1.059	1.011	0.398	0.426	#11
MIMO 802.11 ac(BW80)	Rear	0	5775.0	12.65	13.00	1.084	1.011	0.669	0.733	#12
Repeated (See Section 11)										
Ant.0 802.11 ac(BW80)	Rear	0	5775.0	15.35	15.50	1.035	1.011	1.140	1.193	

**Bluetooth**

Mode	EUT Position	Distance (mm)	Frequency (MHz)	Measured Conducted Power (dBm)	Max. Tune-up Power (dBm)	Power Scaling Factor	Duty Cycle Compensate Factor	Measured 1g SAR (W/kg)	Scaled 1g SAR (W/kg)	Plot No.
BDR_DH5	Rear	0	2480.0	10.52	11.00	1.119	1.302	0.065	<b>0.094</b>	#13



**KCTL Inc.**

65, Sinwon-ro, Yeongtong-gu,  
Suwon-si, Gyeonggi-do, 16677, Korea  
TEL: 82-31-285-0894 FAX: 82-505-299-8311  
[www.kctl.co.kr](http://www.kctl.co.kr)

Report No.:  
KR19-SPF0028  
Page (30) of (131)



## 9.2 Standalone Body SAR Test Results (Tablet)

WLAN 2.4 GHz Band										
Mode	EUT Position	Distance (mm)	Frequency (MHz)	Measured Conducted Power (dBm)	Max. Tune-up Power (dBm)	Power Scaling Factor	Duty Cycle Compensate Factor	Measured 1g SAR (W/kg)	Scaled 1g SAR (W/kg)	Plot No.
Ant.0 802.11b	Rear	0	2412.0	15.92	16.00	1.019	1.005	0.483	0.494	#14
	Left	0	2412.0	15.92	16.00	1.019	1.005	0.483	0.494	
Ant.1 802.11b	Rear	0	2462.0	15.92	16.00	1.019	1.005	0.341	0.349	
	Right	0	2462.0	15.92	16.00	1.019	1.005	0.732	<b>0.749</b>	#15
MIMO 802.11n(BW 40)	Rear	0	2437.0	14.25	14.50	1.059	1.011	0.211	0.226	
	Left	0	2437.0	14.25	14.50	1.059	1.011	0.285	0.305	
	Right	0	2437.0	14.25	14.50	1.059	1.011	0.305	0.327	#16

U-NII-2A										
Mode	EUT Position	Distance (mm)	Frequency (MHz)	Measured Conducted Power (dBm)	Max. Tune-up Power (dBm)	Power Scaling Factor	Duty Cycle Compensate Factor	Measured 1g SAR (W/kg)	Scaled 1g SAR (W/kg)	Plot No.
Ant.0 802.11 ac(BW80)	Rear	0	5290.0	10.35	10.50	1.035	1.011	0.235	0.246	
	Left	0	5290.0	10.35	10.50	1.035	1.011	1.030	<b>1.078</b>	#17
Ant.1 802.11 ac_(BW80)	Rear	0	5290.0	12.25	12.50	1.059	1.011	0.127	0.136	
	Right	0	5290.0	12.25	12.50	1.059	1.011	0.918	0.983	
MIMO 802.11 ac(BW80)	Rear	0	5290.0	8.75	9.00	1.059	1.011	0.129	0.138	
	Left	0	5290.0	8.75	9.00	1.059	1.011	0.898	0.962	#18
	Right	0	5290.0	8.75	9.00	1.059	1.011	0.447	0.479	
Repeated (See Section 11)										
Ant.0 802.11 ac(BW80))	Left	0	5290.0	10.35	10.50	1.035	1.011	0.952	0.996	
Ant.1 802.11 ac(BW80)	Right	0	5290.0	12.25	12.50	1.059	1.011	0.937	1.004	#19
MIMO 802.11 ac(BW80)	Left	0	5290.0	8.75	9.00	1.059	1.011	0.896	0.960	

This test report shall not be reproduced, except in full, without the written approval

**KCTL Inc.**

65, Sinwon-ro, Yeongtong-gu,  
Suwon-si, Gyeonggi-do, 16677, Korea  
TEL: 82-31-285-0894 FAX: 82-505-299-8311  
[www.kctl.co.kr](http://www.kctl.co.kr)

Report No.:  
KR19-SPF0028  
Page (31) of (131)

**U-NII-2C**

Mode	EUT Position	Distance (mm)	Frequency (MHz)	Measured Conducted Power (dBm)	Max. Tune-up Power (dBm)	Power Scaling Factor	Duty Cycle Compensate Factor	Measured 1g SAR (W/kg)	Scaled 1g SAR (W/kg)	Plot No.
Ant.0 802.11 ac(BW80)	Rear	0	5 530.0	9.45	9.50	1.012	1.011	0.192	0.196	
	Left	0	5 530.0	9.45	9.50	1.012	1.011	1.140	<b>1.166</b>	#20
	Left	0	5 610.0	9.35	9.50	1.035	1.011	1.070	1.120	
	Left	0	5 690.0	9.25	9.50	1.059	1.011	0.959	1.027	
Ant.1 802.11 ac(BW80)	Rear	0	5 530.0	12.45	12.50	1.012	1.011	0.249	0.255	
	Right	0	5 530.0	12.45	12.50	1.012	1.011	0.852	0.871	
	Right	0	5 610.0	12.35	12.50	1.035	1.011	0.972	1.017	
MIMO 802.11 ac(BW80)	Rear	0	5 530.0	8.25	8.50	1.059	1.011	0.177	0.190	
	Left	0	5 530.0	8.25	8.50	1.059	1.011	0.996	1.067	#21
	Left	0	5 610.0	8.15	8.50	1.084	1.011	0.795	0.871	
	Left	0	5 690.0	8.15	8.50	1.084	1.011	0.700	0.767	
	Right	0	5 530.0	8.25	8.50	1.059	1.011	0.339	0.363	
Repeated (See Section 11)										
Ant.0 802.11 ac(BW80)	Left	0	5 530.0	9.45	9.50	1.012	1.011	1.130	1.156	
Ant.1 802.11 ac(BW80)	Right	0	5 690.0	12.25	12.50	1.059	1.011	1.030	1.103	#22
MIMO 802.11 ac(BW80)	Left	0	5 530.0	8.25	8.50	1.059	1.011	0.963	1.031	

**U-NII-3**

Mode	EUT Position	Distance (mm)	Frequency (MHz)	Measured Conducted Power (dBm)	Max. Tune-up Power (dBm)	Power Scaling Factor	Duty Cycle Compensate Factor	Measured 1g SAR (W/kg)	Scaled 1g SAR (W/kg)	Plot No.
Ant.0 802.11 ac(BW80)	Rear	0	5 775.0	10.25	10.50	1.059	1.011	0.204	0.218	
	Left	0	5 775.0	10.25	10.50	1.059	1.011	0.999	1.070	
Ant.1 802.11 ac(BW80)	Rear	0	5 775.0	12.25	12.50	1.059	1.011	0.310	0.332	
	Right	0	5 775.0	12.25	12.50	1.059	1.011	0.795	0.851	#23
MIMO 802.11 ac(BW80)	Rear	0	5 775.0	8.75	9.00	1.059	1.011	0.115	0.123	
	Left	0	5 775.0	8.75	9.00	1.059	1.011	0.771	0.826	#24
	Right	0	5 775.0	8.75	9.00	1.059	1.011	0.330	0.353	
Repeated (See Section 11)										
Ant.0 802.11 ac(BW80)	Left	0	5 775.0	10.25	10.50	1.059	1.011	1.020	<b>1.092</b>	#25

This test report shall not be reproduced, except in full, without the written approval

KCTL-TIA002-004/2

**KCTL Inc.**

65, Sinwon-ro, Yeongtong-gu,  
Suwon-si, Gyeonggi-do, 16677, Korea  
TEL: 82-31-285-0894 FAX: 82-505-299-8311  
[www.kctl.co.kr](http://www.kctl.co.kr)

Report No.:  
KR19-SPF0028  
Page (32) of (131)

**Bluetooth**

Mode	EUT Position	Distance (mm)	Frequency (MHz)	Measured Conducted Power (dBm)	Max. Tune-up Power (dBm)	Power Scaling Factor	Duty Cycle Compensate Factor	Measured 1g SAR (W/kg)	Scaled 1g SAR (W/kg)	Plot No.
BDR_DH5	Rear	0	2480.0	10.52	11.00	1.119	1.302	0.039	0.057	
	Right	0	2480.0	10.52	11.00	1.119	1.302	0.093	<b>0.136</b>	#26

**General Notes:**

1. The test data reported are the worst-case SAR values according to test procedures specified in IEEE 1528-2013, and FCC KDB Publication 447498 D01v06.
2. All modes of operation were investigated, and worst-case results are reported.
3. Battery is fully charged for all readings and the standard batteries are the only options.
4. Liquid tissue depth was at least 15 cm.
5. The manufacturer has confirmed that the device(s) tested have the same physical, mechanical and thermal characteristics and are within operational tolerances expected for production units.
6. SAR results were scaled to the maximum allowed power to demonstrate compliance per FCC KDB Publication 447498 D01v06.

**WLAN & Bluetooth Notes:**

1. Justification for test configurations for WLAN per KDB Publication 248227 D01v02r02 for 2.4GHz WIFI operations, the highest measured maximum output power channel for DSSS was selected for SAR measurement. SAR for OFDM modes (2.4GHz 802.11g/n) was not required due to the maximum allowed powers and the highest reported DSSS SAR.
2. The device was configured to transmit continuously at the required data rate, channel bandwidth and signal modulation, using the highest transmission duty factor supported by the test mode tools. The reported SAR was scaled to the 100% transmission duty factor to determine compliance.
3. When the same transmission mode configurations have the same maximum output power on the same channel for the 802.11 a/g/n/ac modes, the channel in the lower order/sequence 802.11 mode (i.e. a, g, n then ac) is selected.
4. When the specified maximum output power is the same for both UNII Band1 and UNII Band 2A, begins SAR measurement in UNII band 2A; and if the highest reported SAR for UNII band 2A is  $\leq 1.2W/kg$ , SAR is not required for UNII band1  $> 1.2W/kg$ , both bands should be tested independently for SAR.
5. When the maximum reported 1g averaged SAR is  $\leq 0.8 W/kg$ , SAR testing on additional channels was not required. Otherwise, SAR for the next highest output power channel was required until the reported SAR result was  $\leq 1.20 W/kg$  for 1g evaluations or all test channels were measured.
6. WLAN & Bluetooth transmission was verified using a spectrum analyzer



## 10. Simultaneous Transmission

### 10.1 Simultaneous Transmission Configurations

No	Scenario	Operation
1	WLAN 2.4 GHz Main (Ant.0) + Bluetooth Aux (Ant.1)	Yes
2	WLAN 5 GHz Main (Ant.0) + Bluetooth Aux (Ant.1)	Yes
3	WLAN 5 GHz Aux (Ant.1) + Bluetooth Aux (Ant.1)	Yes
4	WLAN 5 GHz MIMO (Ant.0, Ant.1) + Bluetooth Aux (Ant.1)	Yes

#### Notes

- It does not to transmit simultaneously the Bluetooth and WLAN 2.4 GHz Aux (Ant. 1)

### 10.2 Estimated SAR

When standalone SAR is not required to be measured, SAR must also be estimated to determine simultaneous transmission SAR test exclusion.

Band / Ant.	Freq. [MHz]	Output Power		Separation distances [mm]					Estimated 1g SAR Value (W/kg)				
		dBm	mW	Rear	Left	Right	Top	Bot.	Rear	Left	Right	Top	Bot.
2.4 GHz Main	2 462	16.0	40	5	5	290.01	64.835	91.865	Measure	Measure	N/A	0.400	0.400
U-NII-2A Main	5 320	10.5	11	5	5	290.01	64.835	91.865	Measure	Measure	N/A	0.400	0.400
U-NII-2C Main	5 720	9.5	9	5	5	290.01	64.835	91.865	Measure	Measure	N/A	0.400	0.400
U-NII-3 Main	5 825	10.5	11	5	5	290.01	64.835	91.865	Measure	Measure	N/A	0.400	0.400
2.4 GHz Aux	2 462	16.0	40	5	290.01	5	64.835	91.865	Measure	N/A	Measure	0.400	0.400
U-NII-2A Aux	5 320	12.5	18	5	290.01	5	64.835	91.865	Measure	N/A	Measure	0.400	0.400
U-NII-2C Aux	5 720	12.5	18	5	290.01	5	64.835	91.865	Measure	N/A	Measure	0.400	0.400
U-NII-3 Aux	5 825	12.5	18	5	290.01	5	64.835	91.865	Measure	N/A	Measure	0.400	0.400
Bluetooth Aux	2 480	11.0	13	5	290.01	5	64.835	91.865	Measure	N/A	Measure	0.400	0.400

#### Note:

- For distances < 5mm, a distance of 5mm is used to determine SAR exclusion and estimated SAR value.
- Output power is the maximum rated power (including tune-up or manufacturing tolerances) and includes source-based averaging.
- If the antenna separation distance is > 50mm then the estimated SAR value is 0.4 W/Kg.
- Formulas round separation distance to nearest mm and power to nearest mW before calculating estimated SAR or determining if SAR is excluded.

**KCTL Inc.**

65, Sinwon-ro, Yeongtong-gu,  
Suwon-si, Gyeonggi-do, 16677, Korea  
TEL: 82-31-285-0894 FAX: 82-505-299-8311  
[www.kctl.co.kr](http://www.kctl.co.kr)

Report No.:  
KR19-SPF0028  
Page (34) of (131)



### 10.3 Simultaneous Transmission Analysis

Exposure Condition /Position		WLAN				Bluetooth Ant.1	Summation			
		2.4 GHz Ant. 0	5 GHz Ant. 0	5 GHz Ant. 1	5 GHz MIMO		[①+⑤]	[②+⑤]	[③+⑤]	[④+⑤]
		[①]	[②]	[③]	[④]		[⑤]	[①+⑤]	[②+⑤]	[③+⑤]
<b>Body (Notebook)</b>	Rear	0.628	1.360	0.811	0.902	0.094	0.722	<b>1.454</b>	0.905	0.996
<b>Body (Tablet)</b>	Rear	0.494	0.246	0.332	0.226	0.057	0.551	0.303	0.389	0.283
	Left	0.494	1.166	> 20 cm	1.067	> 20 cm	0.494	1.166	> 20 cm	1.067
	Right	> 20 cm	> 20 cm	1.103	0.479	0.136	0.136	0.136	1.239	0.615
	Top	0.400	0.400	0.400	0.400	0.400	0.800	0.800	0.800	0.800
	Bottom	0.400	0.400	0.400	0.400	0.400	0.800	0.800	0.800	0.800

#### Notes

- Simultaneous transmission SAR test exclusion considerations  
Simultaneous transmission SAR test exclusion is determined for each operating configuration and exposure condition according to the reported standalone SAR of each applicable simultaneously transmitting antenna. When the sum of 1-g or 10-g SAR of all simultaneously transmitting antennas in an operating mode and exposure condition combination is within the SAR limit, SAR test exclusion applies to that simultaneous transmission configuration. Per KDB Publication 447498 D01v06.
- When the sum of SAR1g of all simultaneously transmitting antennas in an operating mode and exposure condition combination is within the SAR limit (SAR1g 1.6 W/kg), the SPLSR procedures is not required. When the sum of SAR1g is greater than the SAR limit (SAR1g 1.6 W/kg), SAR test exclusion is determined by the SPLSR.

## 11. SAR Measurement Variability

Per FCC KDB Publication 865664 D01v01r04, SAR measurement variability was assessed for each frequency band, which was determined by the SAR probe calibration point and tissue-equivalent medium used for the device measurements. When both head and body tissue-equivalent media were required for SAR measurements in a frequency band, the variability measurement procedures were applied to the tissue medium with the highest measured SAR, using the highest measured SAR configuration for that tissue-equivalent medium. These additional measurements were repeated after the completion of all measurements requiring the same head or body tissue equivalent medium in a frequency band. The test device was returned to ambient conditions (normal room temperature) with the battery fully charged before it was re-mounted on the device holder for the repeated measurement(s) to minimize any unexpected variations in the repeated results.

SAR Measurement Variability was assessed using the following procedures for each frequency band:

- 1) Repeated measurements are not required when the original highest measured SAR is < 0.80 W/kg.
- 2) **When the original highest measured SAR is  $\geq 0.80$  W/kg, the measurement was repeated once.**
- 3) A second repeated measurement was performed only if the ratio of largest to smallest SAR for the original and first repeated measurements was > 1.20 or when the original or repeated measurement was  $\geq 1.45$  W/kg (~ 10% from the 1-g SAR limit).
- 4) A third repeated measurement was performed only if the original, first or second repeated measurement was  $\geq 1.5$  W/kg and the ratio of largest to smallest SAR for the original, first and second repeated measurements is > 1.20.

RF Exposure Conditions	Band	Mode	Frequency (MHz)	EUT Position	Separation Distance (mm)	Measured 1 g SAR (W/kg)	Repeated 1g SAR (W/kg)	Ratio
Notebook	U-NII-2C	Ant.0 802.11ac(BW80)	5 690.0	Rear	0	1.330	1.300	0.98
	U-NII-3	Ant.0 802.11ac(BW80)	5 775.0	Rear	0	0.160	0.140	0.88
Tablet	U-NII-2A	Ant.0 802.11ac(BW80)	5 290.0	Left	0	1.030	0.952	0.92
	U-NII-2A	Ant.1 802.11ac(BW80)	5 290.0	Right	0	0.918	0.937	1.02
	U-NII-2A	MIMO 802.11ac(BW80)	5 290.0	Left	0	0.898	0.896	1.00
	U-NII-2C	Ant.0 802.11ac(BW80)	5 530.0	Left	0	1.140	1.130	0.99
	U-NII-2C	Ant.1 802.11ac(BW80)	5 690.0	Right	0	1.030	1.030	1.00
	U-NII-2C	MIMO 802.11ac(BW80)	5 530.0	Left	0	0.996	0.963	0.97
	U-NII-3	Ant.0 802.11ac(BW80)	5 775.0	Left	0	0.999	1.020	1.02

**KCTL Inc.**

65, Sinwon-ro, Yeongtong-gu,  
Suwon-si, Gyeonggi-do, 16677, Korea  
TEL: 82-31-285-0894 FAX: 82-505-299-8311  
[www.kctl.co.kr](http://www.kctl.co.kr)

Report No.:  
KR19-SPF0028  
Page (36) of (131)

**KCTL****12. Measurement Uncertainty**

Per KDB 865664 D01 SAR measurement 100MHz to 6GHz, when the highest measured 1-g SAR within a frequency band is  $< 1.5$  W/kg and the measured 10-g SAR within a frequency band is  $< 3.75$  W/kg. The expanded SAR measurement uncertainty must be  $\leq 30\%$ , for a confidence interval of  $k = 2$ . If these conditions are met, extensive SAR measurement uncertainty analysis described in IEEE Standard 1528-2013 is not required in SAR reports submitted for equipment approval. For this device, the highest measured 1-g SAR is less 1.5W/kg and highest measured 10-g SAR is less 3.75W/kg. Therefore, the measurement uncertainty table is not required in this report.

**KCTL**

**KCTL Inc.**

65, Sinwon-ro, Yeongtong-gu,  
Suwon-si, Gyeonggi-do, 16677, Korea  
TEL: 82-31-285-0894 FAX: 82-505-299-8311  
[www.kctl.co.kr](http://www.kctl.co.kr)

Report No.:  
KR19-SPF0028  
Page (37) of (131)



### 13. Test Equipment Information

Test Platform	SPEAG DASY5 System			
Version	DASY52: 52.10.2.1495 / SEMCAD: 14.6.12 (7450)			
Location	KCTL Inc, 65, Sinwon-ro, Yeongtong-gu, Suwon-si, Gyeonggi-do, Korea			
Manufacture	SPEAG			
Hardware Reference				
Equipment	Model	Serial Number	Date of Calibration	Due date of next Calibration
Shield Room	-	8F - #1	N/A	N/A
DASY5 Robot	TX90XL speag	F07/554JA1/A/01	N/A	N/A
Phantom	2mm Oval Phantom ELI5	1173	N/A	N/A
Phantom	2mm Oval Phantom ELI5	1220	N/A	N/A
Mounting Device	Laptop Holder	-	N/A	N/A
DAE	DAE4	1342	2019-05-23	2020-05-23
Probe	EX3DV4	3928	2019-01-31	2020-01-31
ESG Vector Signal Generator	E4438C	MY42080486	2019-05-13	2020-05-13
Dual Power Meter	E4419B	GB43312301	2019-05-13	2020-05-13
Power Sensor	8481H	3318A 19379	2019-05-13	2020-05-13
Power Sensor	8481H	3318A 19377	2019-05-13	2020-05-13
Attenuator	8491B 3dB	17387	2019-05-13	2020-05-13
Attenuator	8491B-6dB	MY39270294	2019-05-13	2020-05-13
Attenuator	8491B 10dB	29425	2019-05-13	2020-05-13
Power Amplifier	2055-BBS3Q7E9I	1005D/C0521	2019-03-08	2020-03-08
Power Amplifier	5190FE	1012	2019-05-14	2020-05-14
Dual Directional Coupler	772D	2839A00719	2019-05-13	2020-05-13
Low Pass Filter	LA-30N	40058	2019-05-13	2020-05-13
Low Pass Filter	LA-60N	40059	2019-05-13	2020-05-13
Dipole Validation Kits	D2450V2	895	2018-07-24	2020-07-24
Dipole Validation Kits	D5GHzV2	1134	2019-05-23	2021-05-23
Network Analyzer	E5071B	MY42403524	2019-01-04	2020-01-04
Dielectric Assessment Kit	DAK-3.5	1078	2019-05-22	2020-05-22
Humidity/Temp	MHB-382SD	73871	2019-04-10	2020-04-10
Spectrum Analyzer	FSP7	100289	2019-01-04	2020-01-04
Wireless Communications Test Set	CMW270	100999	2019-05-14	2020-05-14

## 14. Test System Verification Results

Date: 2019-09-04

Test Laboratory: KCTL Inc.

File Name: [2450 MHz Verification Input Power 100 mW 2019-09-04.da5:0](#)

DUT: Dipole 2450 MHz D2450V2, Type: D2450V2, Serial: D2450V2 - SN:895

Communication System: UID 0, CW (0); Frequency: 2450 MHz; Duty Cycle: 1:1  
Medium parameters used (interpolated):  $f = 2450$  MHz;  $\sigma = 1.832$  S/m;  $\epsilon_r = 39.213$ ;  $\rho = 1000$  kg/m<sup>3</sup>  
Phantom section: Flat Section

DASY5 Configuration:

- Probe: EX3DV4 - SN3928; ConvF(7.21, 7.21, 7.21) @ 2450 MHz; Calibrated: 2019-01-31
- Sensor-Surface: 1.4mm (Mechanical Surface Detection)
- Electronics: DAE4 Sn1342; Calibrated: 2019-05-23
- Phantom: ELI V5.0 (20deg probe tilt)\_3\_20180808; Type: QD OVA 002 AA; Serial: 1173
- Measurement SW: DASY52, Version 52.10 (2);

**Configuration/2450 MHz Verification Input Power 100 mW 2019-09-04/Area Scan (11x13x1):**

Measurement grid: dx=12mm, dy=12mm

Info: Interpolated medium parameters used for SAR evaluation.

Maximum value of SAR (measured) = 7.19 W/kg

**Configuration/2450 MHz Verification Input Power 100 mW 2019-09-04/Zoom Scan (7x7x7)/Cube**

0: Measurement grid: dx=5mm, dy=5mm, dz=5mm

Reference Value = 64.44 V/m; Power Drift = 0.14 dB

Peak SAR (extrapolated) = 11.0 W/kg

**SAR(1 g) = 5.18 W/kg; SAR(10 g) = 2.39 W/kg**

Info: Interpolated medium parameters used for SAR evaluation.

Maximum value of SAR (measured) = 8.75 W/kg

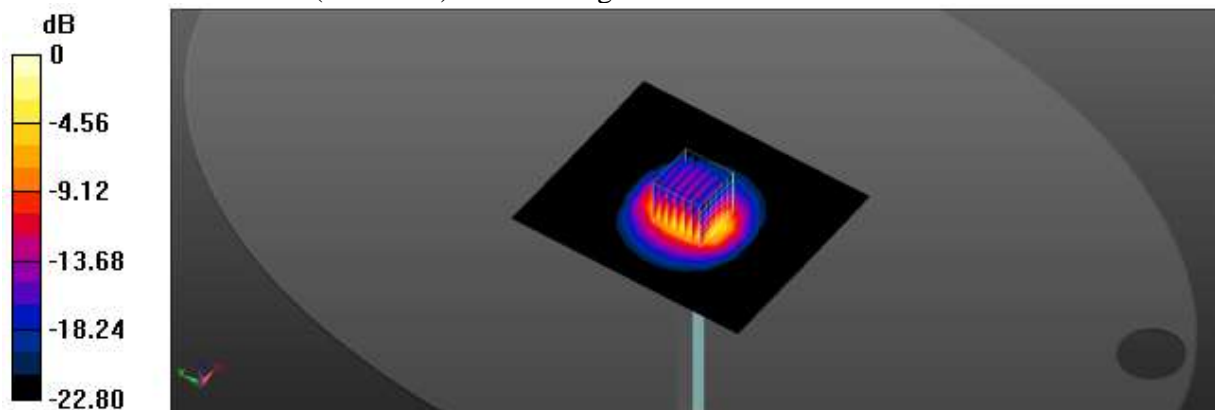

0 dB = 8.75 W/kg = 9.42 dBW/kg

Date: 2019-09-05

Test Laboratory: KCTL Inc.

**File Name:** [5300 MHz Verification Input Power 100 mW 2019-09-05.da5:0](#)**DUT: Dipole D5GHzV2, Type: D5GHzV2, Serial: D5GHzV2 - SN:1134**Communication System: UID 0, CW (0); Frequency: 5300 MHz; Duty Cycle: 1:1  
Medium parameters used (interpolated):  $f = 5300$  MHz;  $\sigma = 4.821$  S/m;  $\epsilon_r = 35.275$ ;  $\rho = 1000$  kg/m<sup>3</sup>  
Phantom section: Flat Section

DASY5 Configuration:

- Probe: EX3DV4 - SN3928; ConvF(4.95, 4.95, 4.95) @ 5300 MHz; Calibrated: 2019-01-31
- Sensor-Surface: 1.4mm (Mechanical Surface Detection)
- Electronics: DAE4 Sn1342; Calibrated: 2019-05-23
- Phantom: ELI V5.0 (20deg probe tilt)\_2\_20180808; Type: QD OVA 002 BB; Serial: 1220
- Measurement SW: DASY52, Version 52.10 (2);

**Configuration/5300 MHz Verification Input Power 100 mW 2019-09-05/Area Scan (10x13x1):**

Measurement grid: dx=10mm, dy=10mm

**Info:** [Interpolated medium parameters used for SAR evaluation.](#)

Maximum value of SAR (measured) = 17.9 W/kg

**Configuration/5300 MHz Verification Input Power 100 mW 2019-09-05/Zoom Scan (8x8x7)/Cube**

0: Measurement grid: dx=4mm, dy=4mm, dz=1.4mm

Reference Value = 74.54 V/m; Power Drift = 0.01 dB

Peak SAR (extrapolated) = 37.2 W/kg

**SAR(1 g) = 8.33 W/kg; SAR(10 g) = 2.38 W/kg****Info:** [Interpolated medium parameters used for SAR evaluation.](#)

Maximum value of SAR (measured) = 21.8 W/kg

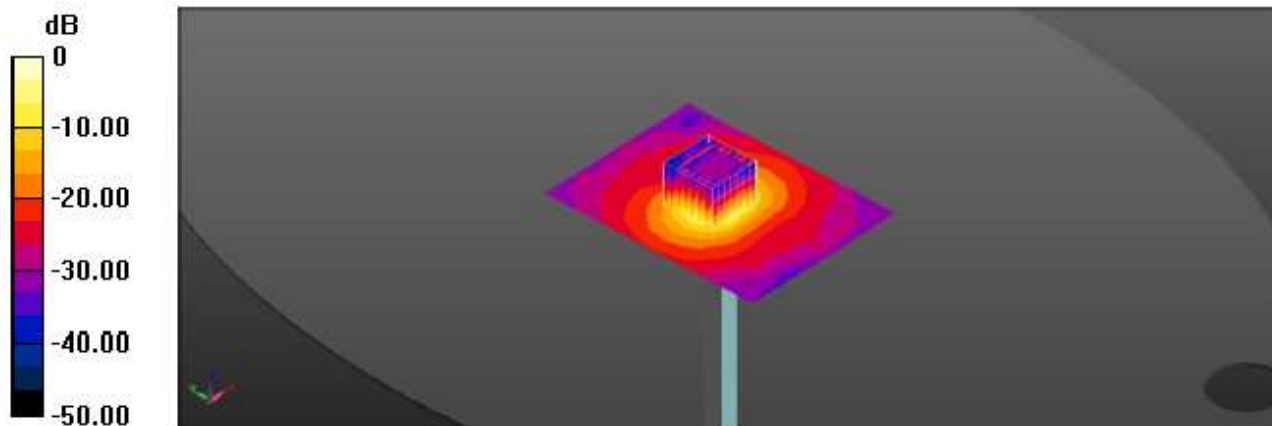

0 dB = 21.8 W/kg = 13.38 dBW/kg

Date: 2019-09-06

Test Laboratory: KCTL Inc.

**File Name:** [5600 MHz Verification Input Power 100 mW 2019-09-06.da5:0](#)**DUT: Dipole D5GHzV2, Type: D5GHzV2, Serial: D5GHzV2 - SN:1134**Communication System: UID 0, CW (0); Frequency: 5600 MHz; Duty Cycle: 1:1  
Medium parameters used:  $f = 5600$  MHz;  $\sigma = 5.055$  S/m;  $\epsilon_r = 34.941$ ;  $\rho = 1000$  kg/m<sup>3</sup>  
Phantom section: Flat Section

DASY5 Configuration:

- Probe: EX3DV4 - SN3928; ConvF(4.78, 4.78, 4.78) @ 5600 MHz; Calibrated: 2019-01-31
- Sensor-Surface: 1.4mm (Mechanical Surface Detection)
- Electronics: DAE4 Sn1342; Calibrated: 2019-05-23
- Phantom: ELI V5.0 (20deg probe tilt)\_2\_20180808; Type: QD OVA 002 BB; Serial: 1220
- Measurement SW: DASY52, Version 52.10 (2);

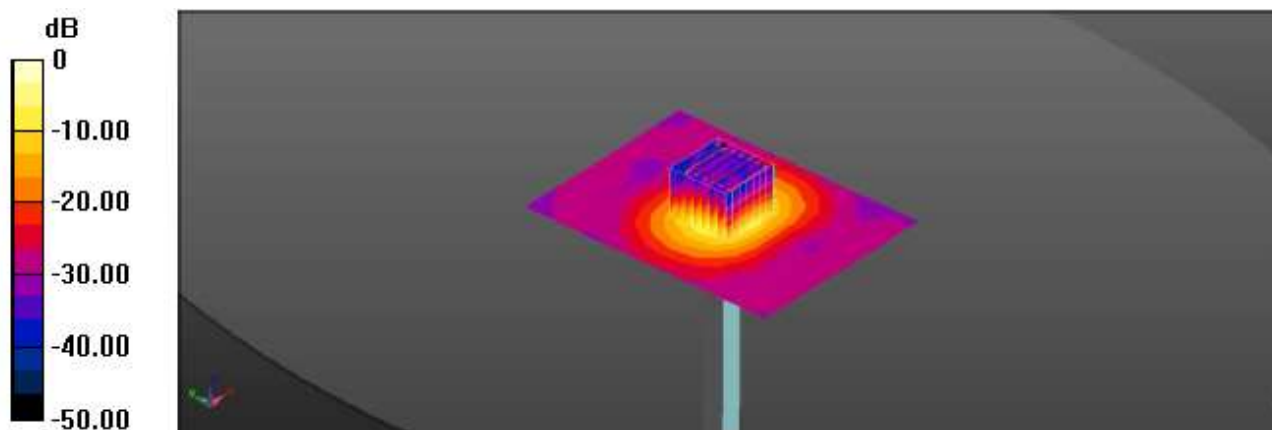
**Configuration/5600 MHz Verification Input Power 100 mW 2019-09-06/Area Scan (10x13x1):**Measurement grid: dx=10mm, dy=10mm  
Maximum value of SAR (measured) = 19.3 W/kg**Configuration/5600 MHz Verification Input Power 100 mW 2019-09-06/Zoom Scan (8x8x7)/Cube**0: Measurement grid: dx=4mm, dy=4mm, dz=1.4mm  
Reference Value = 73.68 V/m; Power Drift = -0.19 dB  
Peak SAR (extrapolated) = 42.3 W/kg**SAR(1 g) = 8.8 W/kg; SAR(10 g) = 2.52 W/kg**  
Maximum value of SAR (measured) = 23.6 W/kg

0 dB = 23.6 W/kg = 13.73 dBW/kg



Date: 2019-09-11

Test Laboratory: KCTL Inc.

**File Name:** [5600 MHz Verification Input Power 100 mW 2019-09-11.da5:0](#)**DUT: Dipole D5GHzV2, Type: D5GHzV2, Serial: D5GHzV2 - SN:1134**Communication System: UID 0, CW (0); Frequency: 5600 MHz; Duty Cycle: 1:1  
Medium parameters used:  $f = 5600$  MHz;  $\sigma = 5.161$  S/m;  $\epsilon_r = 34.873$ ;  $\rho = 1000$  kg/m<sup>3</sup>  
Phantom section: Flat Section

DASY5 Configuration:

- Probe: EX3DV4 - SN3928; ConvF(4.78, 4.78, 4.78) @ 5600 MHz; Calibrated: 2019-01-31
- Sensor-Surface: 1.4mm (Mechanical Surface Detection)
- Electronics: DAE4 Sn1342; Calibrated: 2019-05-23
- Phantom: ELI V5.0 (20deg probe tilt)\_2\_20180808; Type: QD OVA 002 BB; Serial: 1220
- Measurement SW: DASY52, Version 52.10 (2);

**Configuration/5600 MHz Verification Input Power 100 mW 2019-09-11/Area Scan (10x13x1):**Measurement grid: dx=10mm, dy=10mm  
Maximum value of SAR (measured) = 18.4 W/kg**Configuration/5600 MHz Verification Input Power 100 mW 2019-09-11/Zoom Scan (8x8x7)/Cube**

0: Measurement grid: dx=4mm, dy=4mm, dz=1.4mm

Reference Value = 76.51 V/m; Power Drift = 0.05 dB

Peak SAR (extrapolated) = 44.1 W/kg

**SAR(1 g) = 8.94 W/kg; SAR(10 g) = 2.56 W/kg**

Maximum value of SAR (measured) = 24.0 W/kg

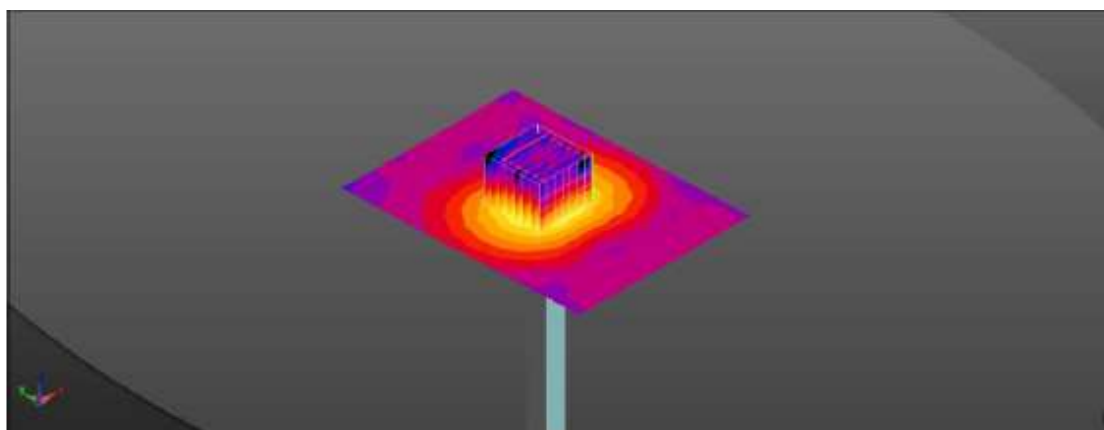
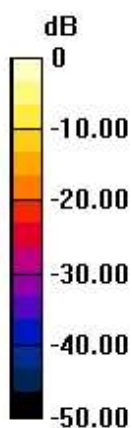

0 dB = 24.0 W/kg = 13.80 dBW/kg

Date: 2019-09-10

Test Laboratory: KCTL Inc.

**File Name:** [5800 MHz Verification Input Power 100 mW 2019-09-10.da5:0](#)**DUT: Dipole D5GHzV2, Type: D5GHzV2, Serial: D5GHzV2 - SN:1134**Communication System: UID 0, CW (0); Frequency: 5800 MHz; Duty Cycle: 1:1  
Medium parameters used:  $f = 5800$  MHz;  $\sigma = 5.262$  S/m;  $\epsilon_r = 36.293$ ;  $\rho = 1000$  kg/m<sup>3</sup>  
Phantom section: Flat Section

DASY5 Configuration:

- Probe: EX3DV4 - SN3928;ConvF(4.7, 4.7, 4.7) @ 5800 MHz; Calibrated: 2019-01-31
- Sensor-Surface: 1.4mm (Mechanical Surface Detection)
- Electronics: DAE4 Sn1342; Calibrated: 2019-05-23
- Phantom: ELI V5.0 (20deg probe tilt)\_2\_20180808; Type: QD OVA 002 BB; Serial: 1220
- Measurement SW: DASY52, Version 52.10 (2);

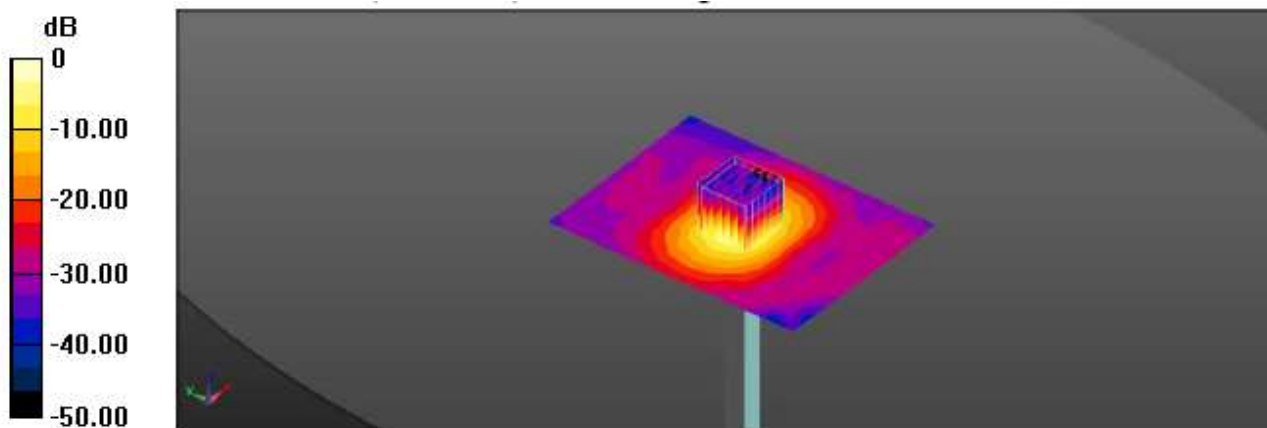
**Configuration/5800 MHz Verification Input Power 100 mW 2019-09-10/Area Scan (10x13x1):**Measurement grid: dx=10mm, dy=10mm  
Maximum value of SAR (measured) = 19.2 W/kg**Configuration/5800 MHz Verification Input Power 100 mW 2019-09-10/Zoom Scan (7x7x7)/Cube**0: Measurement grid: dx=4mm, dy=4mm, dz=1.4mm  
Reference Value = 69.12 V/m; Power Drift = 0.17 dB  
Peak SAR (extrapolated) = 40.6 W/kg**SAR(1 g) = 7.99 W/kg; SAR(10 g) = 2.3 W/kg**  
Maximum value of SAR (measured) = 21.8 W/kg

0 dB = 21.8 W/kg = 13.38 dBW/kg

## 15. Test Results

#1

Date: 2019-09-04

Test Laboratory: KCTL Inc.

File Name: [1.802.11 2.4G Body.da53:0](#)**DUT: NP930QCG, Type: Notebook, Serial: 1BP591ZM80073M**

Communication System: UID 0, 2.4GWLAN (0); Frequency: 2437 MHz; Duty Cycle: 1:1  
Medium parameters used (interpolated):  $f = 2437$  MHz;  $\sigma = 1.819$  S/m;  $\epsilon_r = 39.232$ ;  $\rho = 1000$  kg/m<sup>3</sup>  
Phantom section: Flat Section

DASY5 Configuration:

- Probe: EX3DV4 - SN3928;ConvF(7.21, 7.21, 7.21) @ 2437 MHz; Calibrated: 2019-01-31
- Sensor-Surface: 1.4mm (Mechanical Surface Detection)
- Electronics: DAE4 Sn1342; Calibrated: 2019-05-23
- Phantom: ELI V5.0 (20deg probe tilt)\_3\_20180808; Type: QD OVA 002 AA; Serial: 1173
- Measurement SW: DASY52, Version 52.10 (2);

**Configuration/802.11 b\_Ant.0\_CH6\_Rear 0mm/Area Scan (12x11x1):** Measurement grid:  
dx=12mm, dy=12mm

Info: Interpolated medium parameters used for SAR evaluation.

Maximum value of SAR (measured) = 0.931 W/kg

**Configuration/802.11 b\_Ant.0\_CH6\_Rear 0mm/Zoom Scan (9x8x7)/Cube 0:** Measurement grid:  
dx=5mm, dy=5mm, dz=5mm

Reference Value = 25.46 V/m; Power Drift = -0.06 dB

Peak SAR (extrapolated) = 2.13 W/kg

**SAR(1 g) = 0.613 W/kg; SAR(10 g) = 0.235 W/kg**

Info: Interpolated medium parameters used for SAR evaluation.

Maximum value of SAR (measured) = 1.33 W/kg

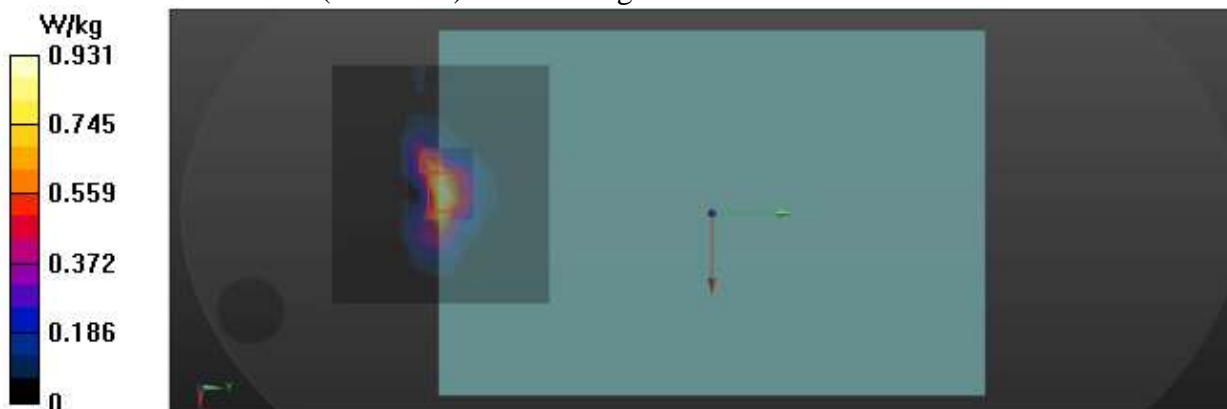

#2

Date: 2019-09-04

Test Laboratory: KCTL Inc.

File Name: [1.802.11 2.4G Body.da53:0](#)**DUT: NP930QCG, Type: Notebook, Serial: 1BP591ZM80073M**

Communication System: UID 0, 2.4GWLAN (0); Frequency: 2462 MHz; Duty Cycle: 1:1

Medium parameters used:  $f = 2462$  MHz;  $\sigma = 1.844$  S/m;  $\epsilon_r = 39.222$ ;  $\rho = 1000$  kg/m<sup>3</sup>

Phantom section: Flat Section

DASY5 Configuration:

- Probe: EX3DV4 - SN3928;ConvF(7.21, 7.21, 7.21) @ 2462 MHz; Calibrated: 2019-01-31
- Sensor-Surface: 1.4mm (Mechanical Surface Detection)
- Electronics: DAE4 Sn1342; Calibrated: 2019-05-23
- Phantom: ELI V5.0 (20deg probe tilt)\_3\_20180808; Type: QD OVA 002 AA; Serial: 1173
- Measurement SW: DASY52, Version 52.10 (2);

**Configuration/802.11 b\_Ant.1\_CH11\_Rear 0mm/Area Scan (12x11x1):** Measurement grid:

dx=12mm, dy=12mm

Maximum value of SAR (measured) = 1.11 W/kg

**Configuration/802.11 b\_Ant.1\_CH11\_Rear 0mm/Zoom Scan (7x8x7)/Cube 0:** Measurement

grid: dx=5mm, dy=5mm, dz=5mm

Reference Value = 24.64 V/m; Power Drift = -0.19 dB

Peak SAR (extrapolated) = 2.30 W/kg

**SAR(1 g) = 0.540 W/kg; SAR(10 g) = 0.184 W/kg**

Maximum value of SAR (measured) = 1.45 W/kg

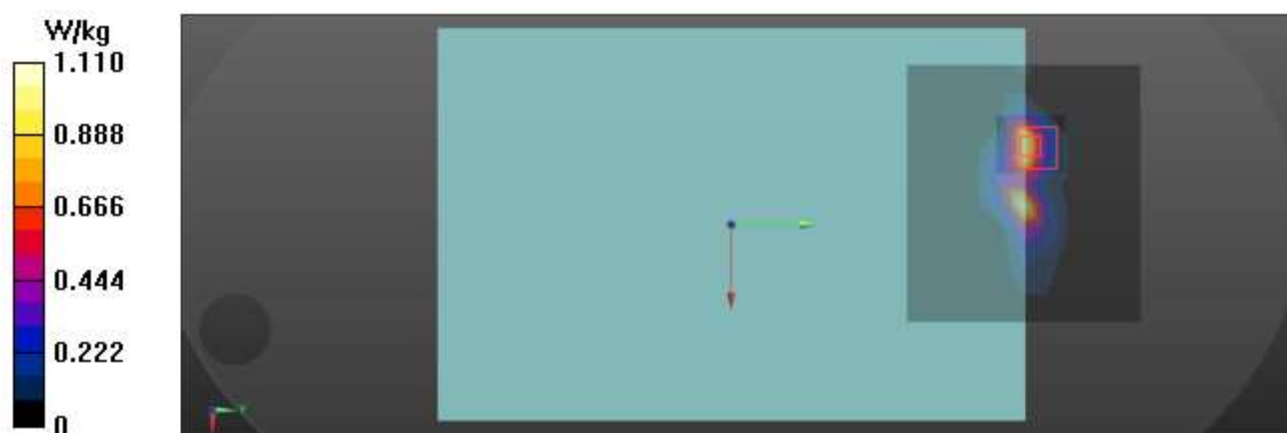

#3

Date: 2019-09-04

Test Laboratory: KCTL Inc.

File Name: [1.802.11 2.4G Body.da53:0](#)**DUT: NP930QCG, Type: Notebook, Serial: 1BP591ZM80073M**Communication System: UID 0, 2.4G WLAN (0); Frequency: 2437 MHz; Duty Cycle: 1:1  
Medium parameters used (interpolated):  $f = 2437$  MHz;  $\sigma = 1.819$  S/m;  $\epsilon_r = 39.232$ ;  $\rho = 1000$  kg/m<sup>3</sup>  
Phantom section: Flat Section

DASY5 Configuration:

- Probe: EX3DV4 - SN3928;ConvF(7.21, 7.21, 7.21) @ 2437 MHz; Calibrated: 2019-01-31
- Sensor-Surface: 1.4mm (Mechanical Surface Detection)
- Electronics: DAE4 Sn1342; Calibrated: 2019-05-23
- Phantom: ELI V5.0 (20deg probe tilt)\_3\_20180808; Type: QD OVA 002 AA; Serial: 1173
- Measurement SW: DASY52, Version 52.10 (2);

**Configuration/802.11 n\_BW20\_MIMO\_CH6\_Rear 0mm/Area Scan (12x33x1):** Measurement grid: dx=12mm, dy=12mm[Info: Interpolated medium parameters used for SAR evaluation.](#)

Maximum value of SAR (measured) = 0.648 W/kg

**Configuration/802.11 n\_BW20\_MIMO\_CH6\_Rear 0mm/Zoom Scan (10x9x7)/Cube 0:**

Measurement grid: dx=5mm, dy=5mm, dz=5mm

Reference Value = 20.59 V/m; Power Drift = 0.15 dB

Peak SAR (extrapolated) = 1.43 W/kg

**SAR(1 g) = 0.406 W/kg; SAR(10 g) = 0.175 W/kg**[Info: Interpolated medium parameters used for SAR evaluation.](#)

Maximum value of SAR (measured) = 1.00 W/kg

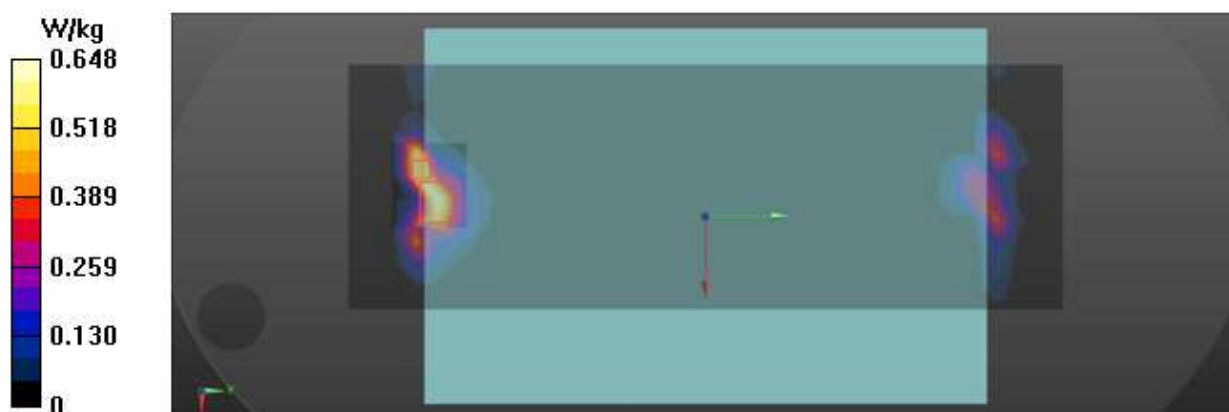

This test report shall not be reproduced, except in full, without the written approval

KCTL-TIA002-004/2

#4

Date: 2019-09-05

Test Laboratory: KCTL Inc.

File Name: [1.802.11 ac BW80 Body.da53:0](#)**DUT: NP930QCG, Type: Notebook, Serial: 1BP591ZM80073M**Communication System: UID 0, 5GWLAN (0); Frequency: 5290 MHz; Duty Cycle: 1:1  
Medium parameters used (interpolated):  $f = 5290$  MHz;  $\sigma = 4.807$  S/m;  $\epsilon_r = 35.299$ ;  $\rho = 1000$  kg/m<sup>3</sup>  
Phantom section: Flat Section

DASY5 Configuration:

- Probe: EX3DV4 - SN3928;ConvF(4.95, 4.95, 4.95) @ 5290 MHz; Calibrated: 2019-01-31
- Sensor-Surface: 1.4mm (Mechanical Surface Detection)
- Electronics: DAE4 Sn1342; Calibrated: 2019-05-23
- Phantom: ELI V5.0 (20deg probe tilt)\_2\_20180808; Type: QD OVA 002 BB; Serial: 1220
- Measurement SW: DASY52, Version 52.10 (2);

**Configuration/802.11 ac\_BW80\_Ant.0\_CH58\_Rear 0mm/Area Scan (14x13x1):** Measurement grid: dx=10mm, dy=10mm[Info: Interpolated medium parameters used for SAR evaluation.](#)

Maximum value of SAR (measured) = 1.64 W/kg

**Configuration/802.11 ac\_BW80\_Ant.0\_CH58\_Rear 0mm/Zoom Scan (9x9x7)/Cube 0:**

Measurement grid: dx=4mm, dy=4mm, dz=1.4mm

Reference Value = 21.90 V/m; Power Drift = -0.05 dB

Peak SAR (extrapolated) = 4.38 W/kg

**SAR(1 g) = 0.724 W/kg; SAR(10 g) = 0.248 W/kg**[Info: Interpolated medium parameters used for SAR evaluation.](#)

Maximum value of SAR (measured) = 1.91 W/kg

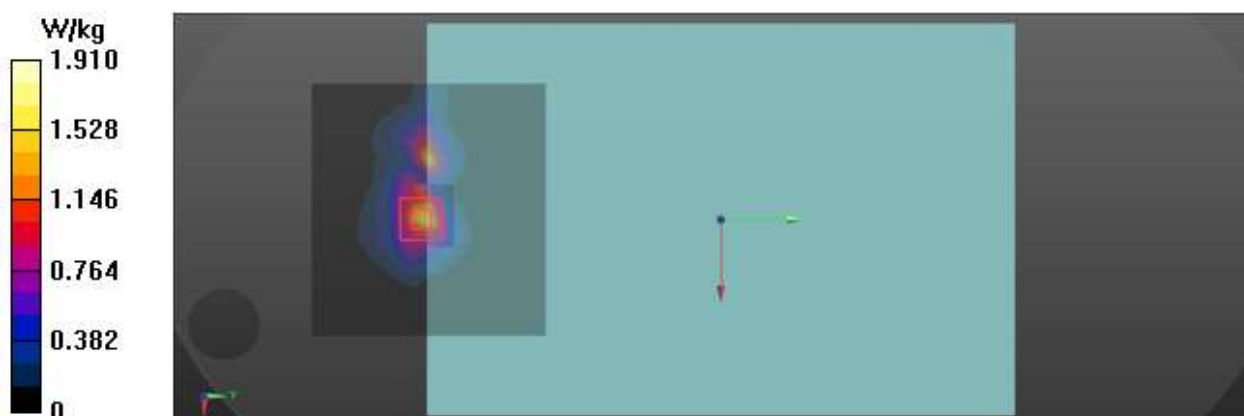

This test report shall not be reproduced, except in full, without the written approval

KCTL-TIA002-004/2

#5

Date: 2019-09-05

Test Laboratory: KCTL Inc.

File Name: [1.802.11 ac BW80 Body.da53:0](#)**DUT: NP930QCG, Type: Notebook, Serial: 1BP591ZM80073M**Communication System: UID 0, 5GWLAN (0); Frequency: 5290 MHz; Duty Cycle: 1:1  
Medium parameters used (interpolated):  $f = 5290$  MHz;  $\sigma = 4.807$  S/m;  $\epsilon_r = 35.299$ ;  $\rho = 1000$  kg/m<sup>3</sup>  
Phantom section: Flat Section

DASY5 Configuration:

- Probe: EX3DV4 - SN3928;ConvF(4.95, 4.95, 4.95) @ 5290 MHz; Calibrated: 2019-01-31
- Sensor-Surface: 1.4mm (Mechanical Surface Detection)
- Electronics: DAE4 Sn1342; Calibrated: 2019-05-23
- Phantom: ELI V5.0 (20deg probe tilt)\_2\_20180808; Type: QD OVA 002 BB; Serial: 1220
- Measurement SW: DASY52, Version 52.10 (2);

**Configuration/802.11 ac\_BW80\_Ant.1\_CH58\_Rear 0mm/Area Scan (14x13x1):** Measurement grid: dx=10mm, dy=10mm[Info: Interpolated medium parameters used for SAR evaluation.](#)

Maximum value of SAR (measured) = 2.67 W/kg

**Configuration/802.11 ac\_BW80\_Ant.1\_CH58\_Rear 0mm/Zoom Scan (9x9x7)/Cube 0:**

Measurement grid: dx=4mm, dy=4mm, dz=1.4mm

Reference Value = 25.13 V/m; Power Drift = 0.03 dB

Peak SAR (extrapolated) = 7.09 W/kg

**SAR(1 g) = 0.775 W/kg; SAR(10 g) = 0.201 W/kg**[Info: Interpolated medium parameters used for SAR evaluation.](#)

Maximum value of SAR (measured) = 2.68 W/kg

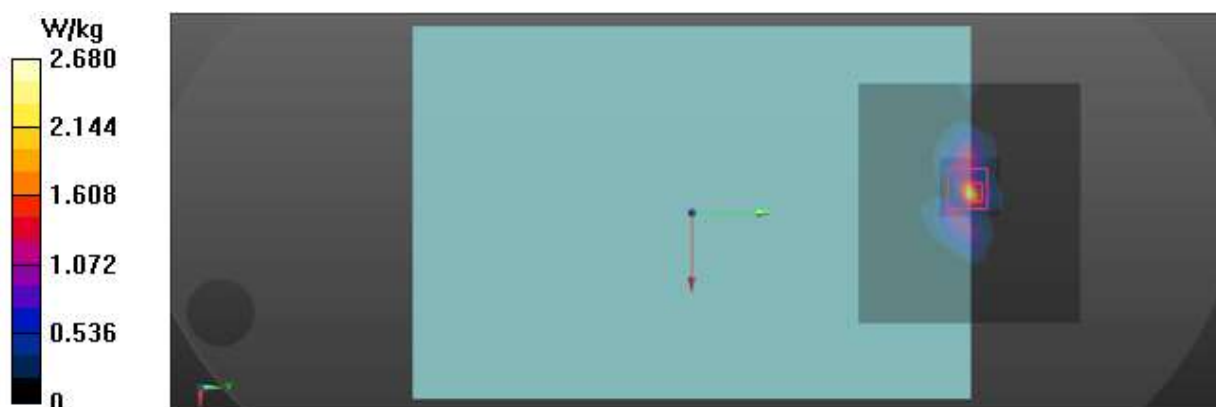

#6

Date: 2019-09-05

Test Laboratory: KCTL Inc.

File Name: [1.802.11 ac BW80 Body.da53:0](#)**DUT: NP930QCG, Type: Notebook, Serial: 1BP591ZM80073M**Communication System: UID 0, 5GWLAN (0); Frequency: 5290 MHz; Duty Cycle: 1:1  
Medium parameters used (interpolated):  $f = 5290$  MHz;  $\sigma = 4.807$  S/m;  $\epsilon_r = 35.299$ ;  $\rho = 1000$  kg/m<sup>3</sup>  
Phantom section: Flat Section

DASY5 Configuration:

- Probe: EX3DV4 - SN3928;ConvF(4.95, 4.95, 4.95) @ 5290 MHz; Calibrated: 2019-01-31
- Sensor-Surface: 1.4mm (Mechanical Surface Detection)
- Electronics: DAE4 Sn1342; Calibrated: 2019-05-23
- Phantom: ELI V5.0 (20deg probe tilt)\_2\_20180808; Type: QD OVA 002 BB; Serial: 1220
- Measurement SW: DASY52, Version 52.10 (2);

**Configuration/802.11 ac\_BW80\_MIMO\_CH58\_Rear 0mm/Area Scan (14x39x1):** Measurement grid: dx=10mm, dy=10mm**Info: Interpolated medium parameters used for SAR evaluation.**

Maximum value of SAR (measured) = 1.04 W/kg

**Configuration/802.11 ac\_BW80\_MIMO\_CH58\_Rear 0mm/Zoom Scan (8x8x7)/Cube 0:**

Measurement grid: dx=4mm, dy=4mm, dz=1.4mm

Reference Value = 16.24 V/m; Power Drift = -0.08 dB

Peak SAR (extrapolated) = 4.31 W/kg

**SAR(1 g) = 0.482 W/kg; SAR(10 g) = 0.164 W/kg****Info: Interpolated medium parameters used for SAR evaluation.**

Maximum value of SAR (measured) = 1.61 W/kg

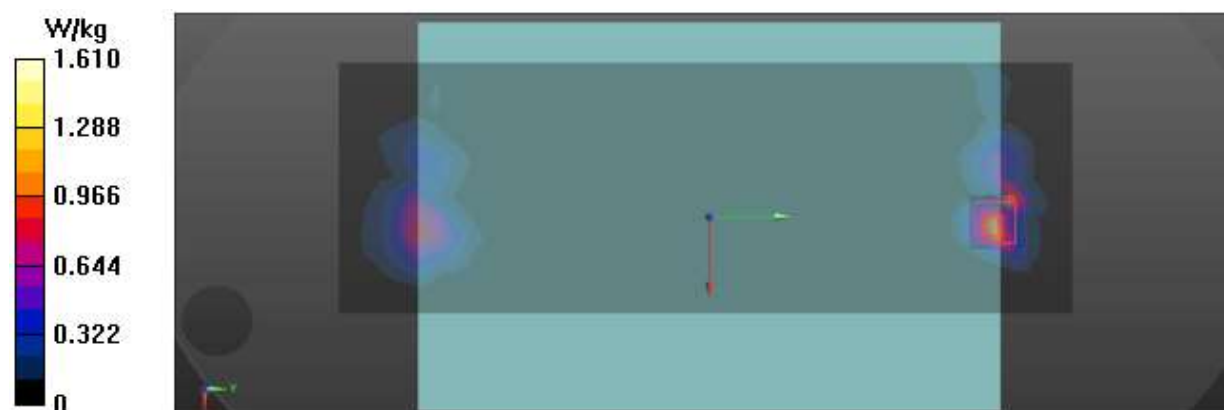

This test report shall not be reproduced, except in full, without the written approval

KCTL-TIA002-004/2



#7

Date: 2019-09-11

Test Laboratory: KCTL Inc.

File Name: [1.802.11 ac Body.da53:0](#)**DUT: NP930QCG, Type: Notebook, Serial: 1BP591ZM80073M**Communication System: UID 0, 5GWLAN (0); Frequency: 5690 MHz; Duty Cycle: 1:1  
Medium parameters used (interpolated):  $f = 5690$  MHz;  $\sigma = 5.268$  S/m;  $\epsilon_r = 34.781$ ;  $\rho = 1000$  kg/m<sup>3</sup>  
Phantom section: Flat Section

DASY5 Configuration:

- Probe: EX3DV4 - SN3928;ConvF(4.78, 4.78, 4.78) @ 5690 MHz; Calibrated: 2019-01-31
- Sensor-Surface: 1.4mm (Mechanical Surface Detection)
- Electronics: DAE4 Sn1342; Calibrated: 2019-05-23
- Phantom: ELI V5.0 (20deg probe tilt)\_2\_20180808; Type: QD OVA 002 BB; Serial: 1220
- Measurement SW: DASY52, Version 52.10 (2);

**Configuration/802.11 ac\_BW80\_Ant.0\_CH138\_Rear 0mm/Area Scan (13x10x1):** Measurement grid: dx=10mm, dy=10mm[Info: Interpolated medium parameters used for SAR evaluation.](#)

Maximum value of SAR (measured) = 3.16 W/kg

**Configuration/802.11 ac\_BW80\_Ant.0\_CH138\_Rear 0mm/Zoom Scan (9x9x7)/Cube 0:**

Measurement grid: dx=4mm, dy=4mm, dz=1.4mm

Reference Value = 28.32 V/m; Power Drift = 0.17 dB

Peak SAR (extrapolated) = 10.8 W/kg

**SAR(1 g) = 1.33 W/kg; SAR(10 g) = 0.442 W/kg**[Info: Interpolated medium parameters used for SAR evaluation.](#)

Maximum value of SAR (measured) = 3.70 W/kg

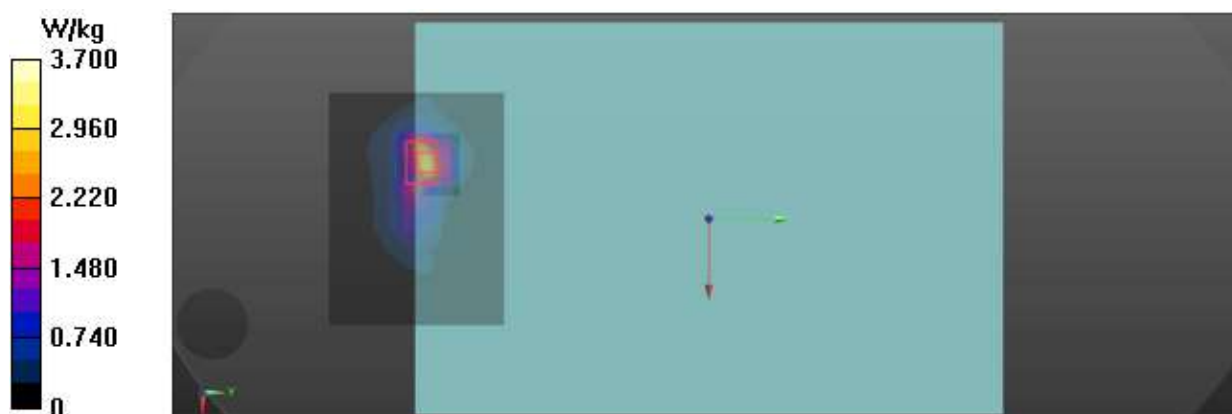

This test report shall not be reproduced, except in full, without the written approval

KCTL-TIA002-004/2

#8

Date: 2019-09-11

Test Laboratory: KCTL Inc.

File Name: [1.802.11 ac Body.da53:0](#)**DUT: NP930QCG, Type: Notebook, Serial: 1BP591ZM80073M**Communication System: UID 0, 5GWLAN (0); Frequency: 5530 MHz; Duty Cycle: 1:1  
Medium parameters used (interpolated):  $f = 5530$  MHz;  $\sigma = 5.064$  S/m;  $\epsilon_r = 34.941$ ;  $\rho = 1000$  kg/m<sup>3</sup>  
Phantom section: Flat Section

DASY5 Configuration:

- Probe: EX3DV4 - SN3928;ConvF(4.86, 4.86, 4.86) @ 5530 MHz; Calibrated: 2019-01-31
- Sensor-Surface: 1.4mm (Mechanical Surface Detection)
- Electronics: DAE4 Sn1342; Calibrated: 2019-05-23
- Phantom: ELI V5.0 (20deg probe tilt)\_2\_20180808; Type: QD OVA 002 BB; Serial: 1220
- Measurement SW: DASY52, Version 52.10 (2);

**Configuration/802.11 ac\_BW80\_Ant.1\_CH106\_Rear 0mm/Area Scan (13x10x1):** Measurement grid: dx=10mm, dy=10mm[Info: Interpolated medium parameters used for SAR evaluation.](#)

Maximum value of SAR (measured) = 1.04 W/kg

**Configuration/802.11 ac\_BW80\_Ant.1\_CH106\_Rear 0mm/Zoom Scan (10x9x7)/Cube 0:**

Measurement grid: dx=4mm, dy=4mm, dz=1.4mm

Reference Value = 13.95 V/m; Power Drift = -0.08 dB

Peak SAR (extrapolated) = 2.94 W/kg

**SAR(1 g) = 0.388 W/kg; SAR(10 g) = 0.134 W/kg**[Info: Interpolated medium parameters used for SAR evaluation.](#)

Maximum value of SAR (measured) = 1.07 W/kg

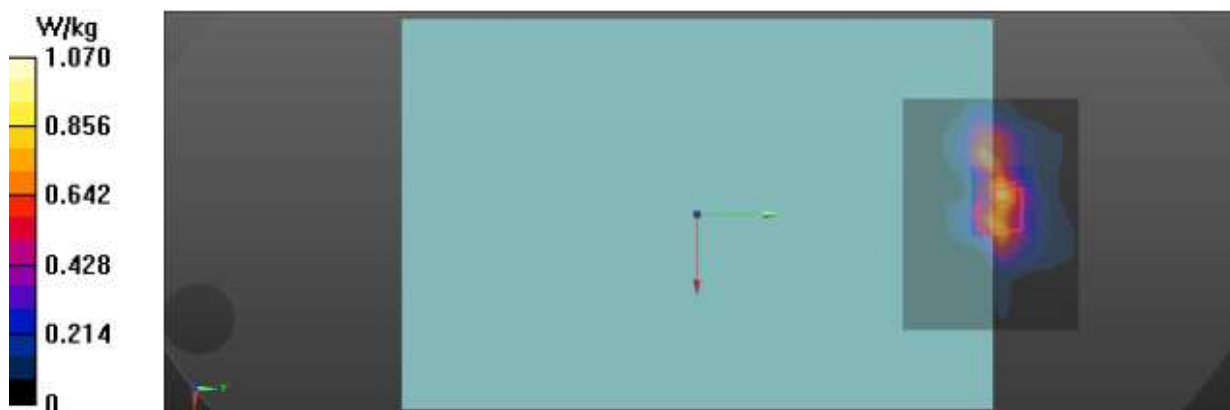

This test report shall not be reproduced, except in full, without the written approval

KCTL-TIA002-004/2

#9

Date: 2019-09-11

Test Laboratory: KCTL Inc.

File Name: [1.802.11 ac Body.da53:0](#)**DUT: NP930QCG, Type: Notebook, Serial: 1BP591ZM80073M**Communication System: UID 0, 5GWLAN (0); Frequency: 5570 MHz; Duty Cycle: 1:1  
Medium parameters used (interpolated):  $f = 5570$  MHz;  $\sigma = 5.122$  S/m;  $\epsilon_r = 34.899$ ;  $\rho = 1000$  kg/m<sup>3</sup>  
Phantom section: Flat Section

DASY5 Configuration:

- Probe: EX3DV4 - SN3928;ConvF(4.78, 4.78, 4.78) @ 5570 MHz; Calibrated: 2019-01-31
- Sensor-Surface: 1.4mm (Mechanical Surface Detection)
- Electronics: DAE4 Sn1342; Calibrated: 2019-05-23
- Phantom: ELI V5.0 (20deg probe tilt)\_2\_20180808; Type: QD OVA 002 BB; Serial: 1220
- Measurement SW: DASY52, Version 52.10 (2);

**Configuration/802.11 ac\_BW160\_MIMO\_CH114\_Rear 0mm/Area Scan (13x39x1):**

Measurement grid: dx=10mm, dy=10mm

Info: [Interpolated medium parameters used for SAR evaluation.](#)

Maximum value of SAR (measured) = 1.42 W/kg

**Configuration/802.11 ac\_BW160\_MIMO\_CH114\_Rear 0mm/Zoom Scan (9x9x7)/Cube 0:**

Measurement grid: dx=4mm, dy=4mm, dz=1.4mm

Reference Value = 9.874 V/m; Power Drift = -0.07 dB

Peak SAR (extrapolated) = 4.62 W/kg

**SAR(1 g) = 0.647 W/kg; SAR(10 g) = 0.213 W/kg**Info: [Interpolated medium parameters used for SAR evaluation.](#)

Maximum value of SAR (measured) = 1.84 W/kg

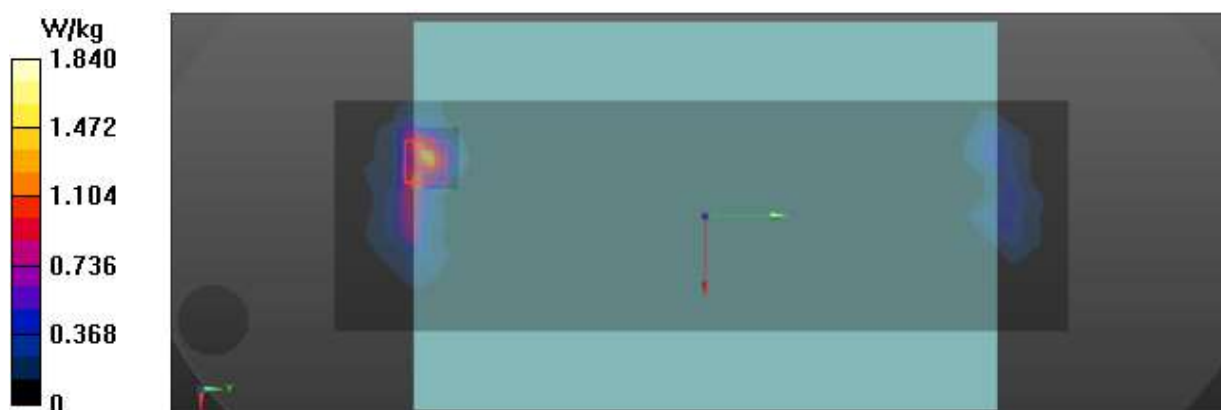

This test report shall not be reproduced, except in full, without the written approval

KCTL-TIA002-004/2

#10

Date: 2019-09-10

Test Laboratory: KCTL Inc.

File Name: [1.802.11 ac Body.da53:0](#)**DUT: NP930QCG, Type: Notebook, Serial: 1BP591ZM80073M**

Communication System: UID 0, 5GWLAN (0); Frequency: 5775 MHz; Duty Cycle: 1:1

Medium parameters used:  $f = 5775$  MHz;  $\sigma = 5.25$  S/m;  $\epsilon_r = 36.287$ ;  $\rho = 1000$  kg/m<sup>3</sup>

Phantom section: Flat Section

DASY5 Configuration:

- Probe: EX3DV4 - SN3928;ConvF(4.7, 4.7, 4.7) @ 5775 MHz; Calibrated: 2019-01-31
- Sensor-Surface: 1.4mm (Mechanical Surface Detection)
- Electronics: DAE4 Sn1342; Calibrated: 2019-05-23
- Phantom: ELI V5.0 (20deg probe tilt)\_2\_20180808; Type: QD OVA 002 BB; Serial: 1220
- Measurement SW: DASY52, Version 52.10 (2);

**Configuration/802.11 ac\_BW80\_Ant.0\_CH155\_Rear 0mm/Area Scan (13x10x1):** Measurement grid: dx=10mm, dy=10mm

Maximum value of SAR (measured) = 3.18 W/kg

**Configuration/802.11 ac\_BW80\_Ant.0\_CH155\_Rear 0mm/Zoom Scan (9x9x7)/Cube 0:**

Measurement grid: dx=4mm, dy=4mm, dz=1.4mm

Reference Value = 25.39 V/m; Power Drift = 0.13 dB

Peak SAR (extrapolated) = 7.04 W/kg

**SAR(1 g) = 1.16 W/kg; SAR(10 g) = 0.407 W/kg**

Maximum value of SAR (measured) = 3.27 W/kg

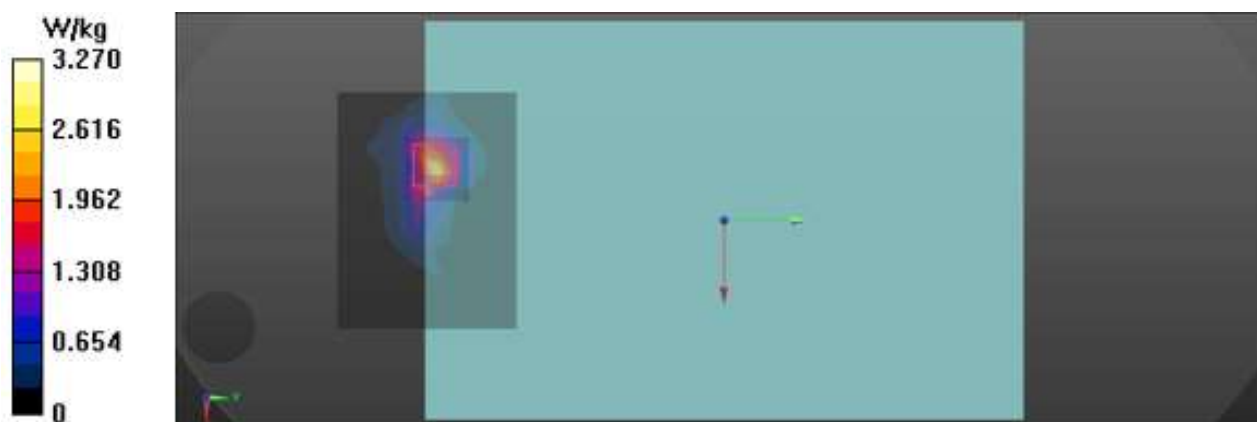

#11

Date: 2019-09-10

Test Laboratory: KCTL Inc.

File Name: [1.802.11 ac Body.da53:0](#)**DUT: NP930QCG, Type: Notebook, Serial: 1BP591ZM80073M**

Communication System: UID 0, 5GWLAN (0); Frequency: 5775 MHz; Duty Cycle: 1:1

Medium parameters used:  $f = 5775$  MHz;  $\sigma = 5.25$  S/m;  $\epsilon_r = 36.287$ ;  $\rho = 1000$  kg/m<sup>3</sup>

Phantom section: Flat Section

DASY5 Configuration:

- Probe: EX3DV4 - SN3928;ConvF(4.7, 4.7, 4.7) @ 5775 MHz; Calibrated: 2019-01-31
- Sensor-Surface: 1.4mm (Mechanical Surface Detection)
- Electronics: DAE4 Sn1342; Calibrated: 2019-05-23
- Phantom: ELI V5.0 (20deg probe tilt)\_2\_20180808; Type: QD OVA 002 BB; Serial: 1220
- Measurement SW: DASY52, Version 52.10 (2);

**Configuration/802.11 ac\_BW80\_Ant.1\_CH155\_Rear 0mm/Area Scan (13x10x1):** Measurement grid: dx=10mm, dy=10mm

Maximum value of SAR (measured) = 0.890 W/kg

**Configuration/802.11 ac\_BW80\_Ant.1\_CH155\_Rear 0mm/Zoom Scan (8x8x7)/Cube 0:**

Measurement grid: dx=4mm, dy=4mm, dz=1.4mm

Reference Value = 12.10 V/m; Power Drift = 0.05 dB

Peak SAR (extrapolated) = 2.27 W/kg

**SAR(1 g) = 0.398 W/kg; SAR(10 g) = 0.140 W/kg**

Maximum value of SAR (measured) = 1.02 W/kg

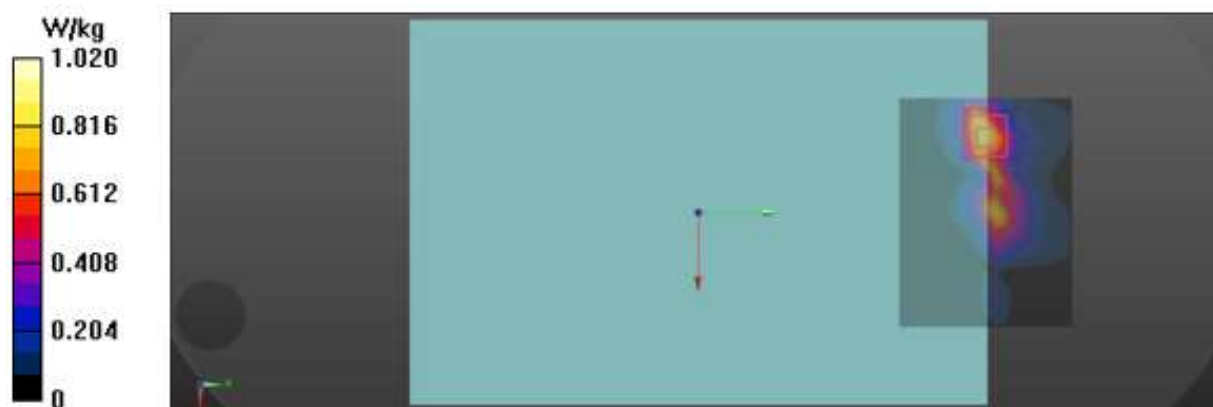

#12

Date: 2019-09-10

Test Laboratory: KCTL Inc.

File Name: [1.802.11 ac Body.da53:0](#)**DUT: NP930QCG, Type: Notebook, Serial: 1BP591ZM80073M**

Communication System: UID 0, 5GWLAN (0); Frequency: 5775 MHz; Duty Cycle: 1:1

Medium parameters used:  $f = 5775$  MHz;  $\sigma = 5.25$  S/m;  $\epsilon_r = 36.287$ ;  $\rho = 1000$  kg/m<sup>3</sup>

Phantom section: Flat Section

DASY5 Configuration:

- Probe: EX3DV4 - SN3928;ConvF(4.7, 4.7, 4.7) @ 5775 MHz; Calibrated: 2019-01-31
- Sensor-Surface: 1.4mm (Mechanical Surface Detection)
- Electronics: DAE4 Sn1342; Calibrated: 2019-05-23
- Phantom: ELI V5.0 (20deg probe tilt)\_2\_20180808; Type: QD OVA 002 BB; Serial: 1220
- Measurement SW: DASY52, Version 52.10 (2);

**Configuration/802.11 ac\_BW80\_MIMO\_CH155\_Rear 0mm re/Area Scan (13x39x1):**

Measurement grid: dx=10mm, dy=10mm

Maximum value of SAR (measured) = 1.36 W/kg

**Configuration/802.11 ac\_BW80\_MIMO\_CH155\_Rear 0mm re/Zoom Scan (8x8x7)/Cube 0:**

Measurement grid: dx=4mm, dy=4mm, dz=1.4mm

Reference Value = 19.29 V/m; Power Drift = 0.07 dB

Peak SAR (extrapolated) = 3.92 W/kg

**SAR(1 g) = 0.669 W/kg; SAR(10 g) = 0.228 W/kg**

Maximum value of SAR (measured) = 1.76 W/kg

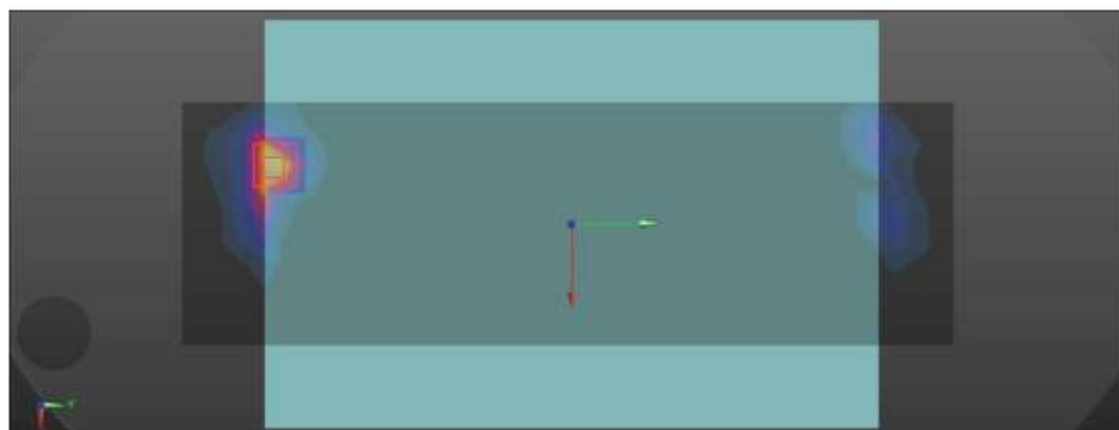
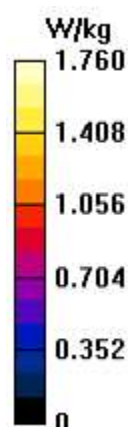

#13

Date: 2019-09-04

Test Laboratory: KCTL Inc.

File Name: **3.Bluetooth GFSK DH5 Body.da53:0****DUT: NP930QCG, Type: Notebook, Serial: 1BP591ZM80073M**

Communication System: UID 0, Bluetooth (0); Frequency: 2480 MHz; Duty Cycle: 1:1.30017

Medium parameters used:  $f = 2480$  MHz;  $\sigma = 1.863$  S/m;  $\epsilon_r = 39.189$ ;  $\rho = 1000$  kg/m<sup>3</sup>

Phantom section: Flat Section

DASY5 Configuration:

- Probe: EX3DV4 - SN3928;ConvF(7.21, 7.21, 7.21) @ 2480 MHz; Calibrated: 2019-01-31
- Sensor-Surface: 1.4mm (Mechanical Surface Detection)
- Electronics: DAE4 Sn1342; Calibrated: 2019-05-23
- Phantom: ELI V5.0 (20deg probe tilt)\_3\_20180808; Type: QD OVA 002 AA; Serial: 1173
- Measurement SW: DASY52, Version 52.10 (2);

**Configuration/Bluetooth\_GFSK\_DH5\_CH78\_Rear 0mm/Area Scan (12x9x1):** Measurement grid: dx=12mm, dy=12mm

Maximum value of SAR (measured) = 0.132 W/kg

**Configuration/Bluetooth\_GFSK\_DH5\_CH78\_Rear 0mm/Zoom Scan (7x7x7)/Cube 0:**

Measurement grid: dx=5mm, dy=5mm, dz=5mm

Reference Value = 9.308 V/m; Power Drift = 0.04 dB

Peak SAR (extrapolated) = 0.252 W/kg

**SAR(1 g) = 0.065 W/kg; SAR(10 g) = 0.021 W/kg**

Maximum value of SAR (measured) = 0.151 W/kg

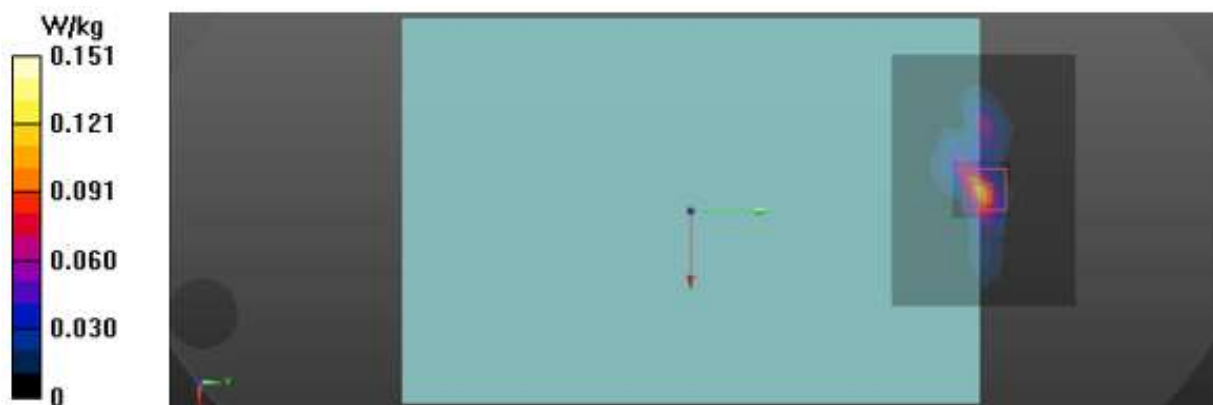

#14

Date: 2019-09-04

Test Laboratory: KCTL Inc.

File Name: [2.802.11 2.4G Body Tablet.da53:1](#)**DUT: NP930QCG, Type: Tablet, Serial: 1BP591ZM80073M**

Communication System: UID 0, 2.4GWLAN (0); Frequency: 2412 MHz; Duty Cycle: 1:1

Medium parameters used:  $f = 2412$  MHz;  $\sigma = 1.795$  S/m;  $\epsilon_r = 39.24$ ;  $\rho = 1000$  kg/m<sup>3</sup>

Phantom section: Flat Section

DASY5 Configuration:

- Probe: EX3DV4 - SN3928;ConvF(7.21, 7.21, 7.21) @ 2412 MHz; Calibrated: 2019-01-31
- Sensor-Surface: 1.4mm (Mechanical Surface Detection)
- Electronics: DAE4 Sn1342; Calibrated: 2019-05-23
- Phantom: ELI V5.0 (20deg probe tilt)\_3\_20180808; Type: QD OVA 002 AA; Serial: 1173
- Measurement SW: DASY52, Version 52.10 (2);

**Configuration 2/802.11 b\_Ant.0\_CH1\_Rear 0mm/Area Scan (12x11x1):** Measurement grid:

dx=12mm, dy=12mm

Maximum value of SAR (measured) = 0.717 W/kg

**Configuration 2/802.11 b\_Ant.0\_CH1\_Rear 0mm/Zoom Scan (7x7x7)/Cube 0:** Measurement

grid: dx=5mm, dy=5mm, dz=5mm

Reference Value = 23.95 V/m; Power Drift = 0.15 dB

Peak SAR (extrapolated) = 1.52 W/kg

**SAR(1 g) = 0.483 W/kg; SAR(10 g) = 0.185 W/kg**

Maximum value of SAR (measured) = 1.01 W/kg

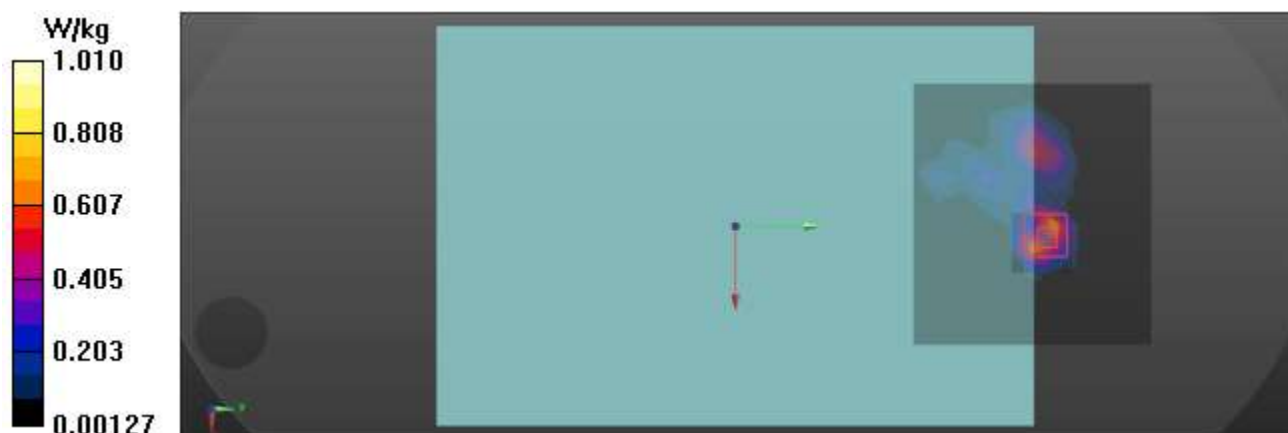



#15

Date: 2019-09-04

Test Laboratory: KCTL Inc.

File Name: [2.802.11 2.4G Body Tablet.da53:2](#)**DUT: NP930QCG, Type: Tablet, Serial: 1BP591ZM80073M**Communication System: UID 0, 2.4GWLAN (0); Frequency: 2462 MHz; Duty Cycle: 1:1  
Medium parameters used:  $f = 2462$  MHz;  $\sigma = 1.844$  S/m;  $\epsilon_r = 39.222$ ;  $\rho = 1000$  kg/m<sup>3</sup>  
Phantom section: Flat Section

DASY5 Configuration:

- Probe: EX3DV4 - SN3928;ConvF(7.21, 7.21, 7.21) @ 2462 MHz; Calibrated: 2019-01-31
- Sensor-Surface: 1.4mm (Mechanical Surface Detection)
- Electronics: DAE4 Sn1342; Calibrated: 2019-05-23
- Phantom: ELI V5.0 (20deg probe tilt)\_3\_20180808; Type: QD OVA 002 AA; Serial: 1173
- Measurement SW: DASY52, Version 52.10 (2);

**Configuration 3/802.11 b\_Ant.1\_CH1\_Right 0 mm/Area Scan (8x18x1):** Measurement grid:  
dx=12mm, dy=12mm

Maximum value of SAR (measured) = 1.41 W/kg

**Configuration 3/802.11 b\_Ant.1\_CH1\_Right 0 mm/Zoom Scan (7x7x7)/Cube 0:** Measurement grid: dx=5mm, dy=5mm, dz=5mm

Reference Value = 18.05 V/m; Power Drift = 0.04 dB

Peak SAR (extrapolated) = 2.81 W/kg

**SAR(1 g) = 0.732 W/kg; SAR(10 g) = 0.264 W/kg**

Maximum value of SAR (measured) = 1.55 W/kg

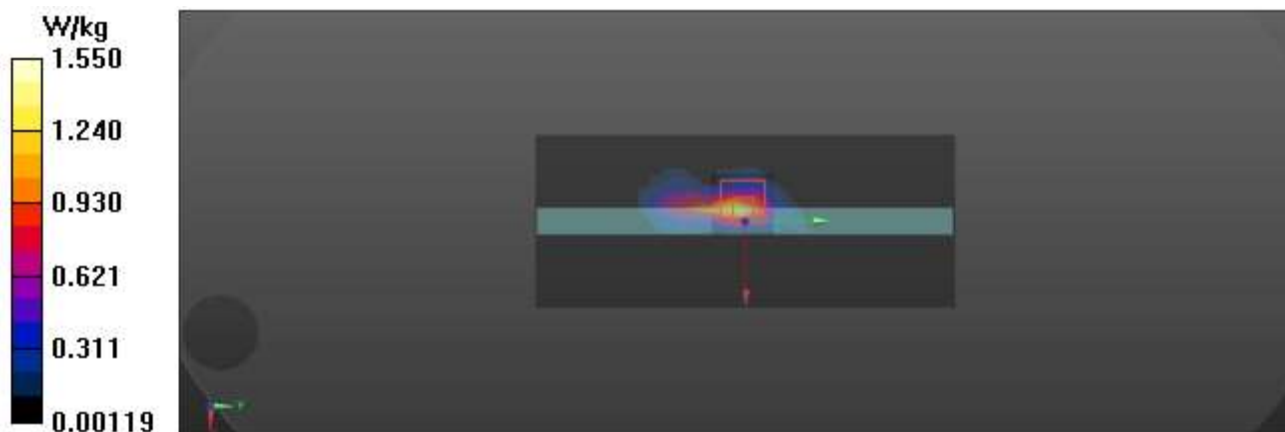

#16

Date: 2019-09-04

Test Laboratory: KCTL Inc.

File Name: [2.802.11 2.4G Body Tablet.da53:2](#)**DUT: NP930QCG, Type: Tablet, Serial: 1BP591ZM80073M**

Communication System: UID 0, 2.4G WLAN (0); Frequency: 2437 MHz; Duty Cycle: 1:1  
Medium parameters used (interpolated):  $f = 2437$  MHz;  $\sigma = 1.819$  S/m;  $\epsilon_r = 39.232$ ;  $\rho = 1000$  kg/m<sup>3</sup>  
Phantom section: Flat Section

DASY5 Configuration:

- Probe: EX3DV4 - SN3928; ConvF(7.21, 7.21, 7.21) @ 2437 MHz; Calibrated: 2019-01-31
- Sensor-Surface: 1.4mm (Mechanical Surface Detection)
- Electronics: DAE4 Sn1342; Calibrated: 2019-05-23
- Phantom: ELI V5.0 (20deg probe tilt)\_3\_20180808; Type: QD OVA 002 AA; Serial: 1173
- Measurement SW: DASY52, Version 52.10 (2);

**Configuration 3/802.11 n\_BW40\_MIMO\_CH6\_Right 0 mm/Area Scan (8x18x1):** Measurement grid: dx=12mm, dy=12mm

[Info: Interpolated medium parameters used for SAR evaluation.](#)

Maximum value of SAR (measured) = 0.644 W/kg

**Configuration 3/802.11 n\_BW40\_MIMO\_CH6\_Right 0 mm/Zoom Scan (9x7x7)/Cube 0:**

Measurement grid: dx=5mm, dy=5mm, dz=5mm

Reference Value = 18.49 V/m; Power Drift = -0.16 dB

Peak SAR (extrapolated) = 1.13 W/kg

**SAR(1 g) = 0.305 W/kg; SAR(10 g) = 0.109 W/kg**

[Info: Interpolated medium parameters used for SAR evaluation.](#)

Maximum value of SAR (measured) = 0.646 W/kg

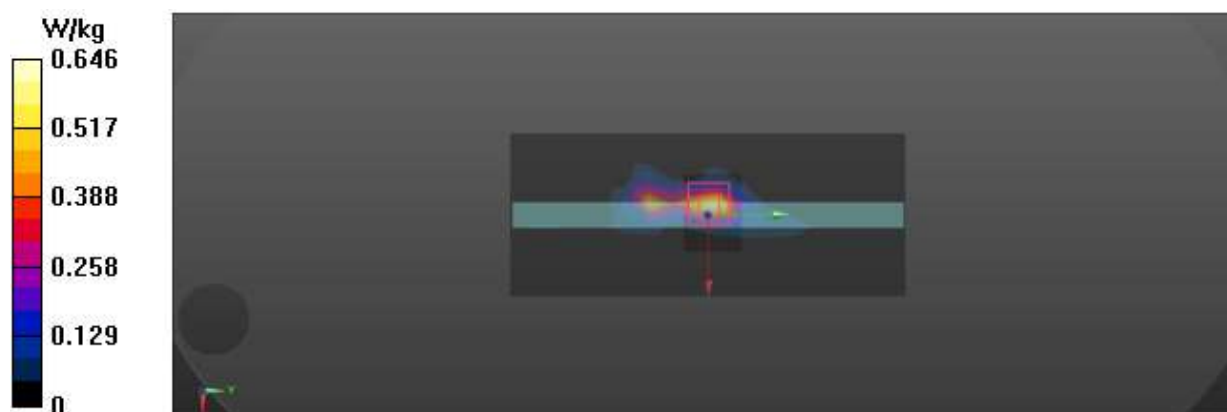

This test report shall not be reproduced, except in full, without the written approval

KCTL-TIA002-004/2

#17

Date: 2019-09-05

Test Laboratory: KCTL Inc.

File Name: [2.802.11 ac BW80 Body Tablet.da53:2](#)**DUT: NP930QCG, Type: Tablet, Serial: 1BP591ZM80073M**Communication System: UID 0, 5GWLAN (0); Frequency: 5290 MHz; Duty Cycle: 1:1  
Medium parameters used (interpolated):  $f = 5290$  MHz;  $\sigma = 4.807$  S/m;  $\epsilon_r = 35.299$ ;  $\rho = 1000$  kg/m<sup>3</sup>  
Phantom section: Flat Section

DASY5 Configuration:

- Probe: EX3DV4 - SN3928;ConvF(4.95, 4.95, 4.95) @ 5290 MHz; Calibrated: 2019-01-31
- Sensor-Surface: 1.4mm (Mechanical Surface Detection)
- Electronics: DAE4 Sn1342; Calibrated: 2019-05-23
- Phantom: ELI V5.0 (20deg probe tilt)\_2\_20180808; Type: QD OVA 002 BB; Serial: 1220
- Measurement SW: DASY52, Version 52.10 (2);

**Configuration 3/802.11 ac\_BW80\_Ant.0\_CH58\_Left 0 mm/Area Scan (9x9x1):** Measurement grid: dx=10mm, dy=10mm

Info: Interpolated medium parameters used for SAR evaluation.

Maximum value of SAR (measured) = 3.41 W/kg

**Configuration 3/802.11 ac\_BW80\_Ant.0\_CH58\_Left 0 mm/Zoom Scan (8x8x7)/Cube 0:**

Measurement grid: dx=4mm, dy=4mm, dz=1.4mm

Reference Value = 16.58 V/m; Power Drift = -0.02 dB

Peak SAR (extrapolated) = 8.10 W/kg

**SAR(1 g) = 1.03 W/kg; SAR(10 g) = 0.279 W/kg**

Info: Interpolated medium parameters used for SAR evaluation.

Maximum value of SAR (measured) = 2.74 W/kg

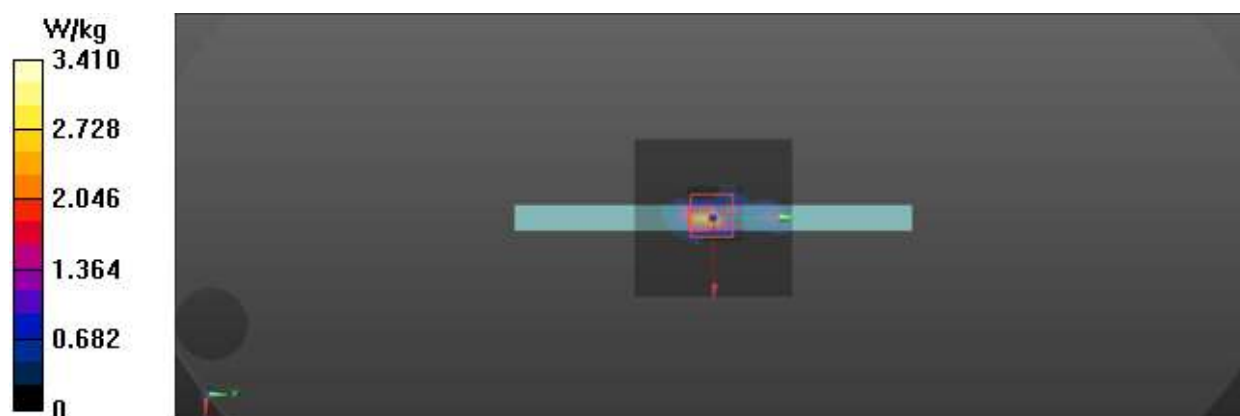

This test report shall not be reproduced, except in full, without the written approval

KCTL-TIA002-004/2

#18

Date: 2019-09-05

Test Laboratory: KCTL Inc.

File Name: [2.802.11 ac BW80 Body Tablet.da53:2](#)**DUT: NP930QCG, Type: Tablet, Serial: 1BP591ZM80073M**Communication System: UID 0, 5GWLAN (0); Frequency: 5290 MHz; Duty Cycle: 1:1  
Medium parameters used (interpolated):  $f = 5290$  MHz;  $\sigma = 4.807$  S/m;  $\epsilon_r = 35.299$ ;  $\rho = 1000$  kg/m<sup>3</sup>  
Phantom section: Flat Section

DASY5 Configuration:

- Probe: EX3DV4 - SN3928;ConvF(4.95, 4.95, 4.95) @ 5290 MHz; Calibrated: 2019-01-31
- Sensor-Surface: 1.4mm (Mechanical Surface Detection)
- Electronics: DAE4 Sn1342; Calibrated: 2019-05-23
- Phantom: ELI V5.0 (20deg probe tilt)\_2\_20180808; Type: QD OVA 002 BB; Serial: 1220
- Measurement SW: DASY52, Version 52.10 (2);

**Configuration 3/802.11 ac\_BW80\_MIMO\_CH58\_Left 0 mm/Area Scan (9x12x1):** Measurement grid: dx=10mm, dy=10mm**Info: Interpolated medium parameters used for SAR evaluation.**

Maximum value of SAR (measured) = 2.10 W/kg

**Configuration 3/802.11 ac\_BW80\_MIMO\_CH58\_Left 0 mm/Zoom Scan (9x9x7)/Cube 0:**

Measurement grid: dx=4mm, dy=4mm, dz=1.4mm

Reference Value = 26.81 V/m; Power Drift = -0.04 dB

Peak SAR (extrapolated) = 8.10 W/kg

**SAR(1 g) = 0.898 W/kg; SAR(10 g) = 0.217 W/kg****Info: Interpolated medium parameters used for SAR evaluation.**

Maximum value of SAR (measured) = 2.91 W/kg

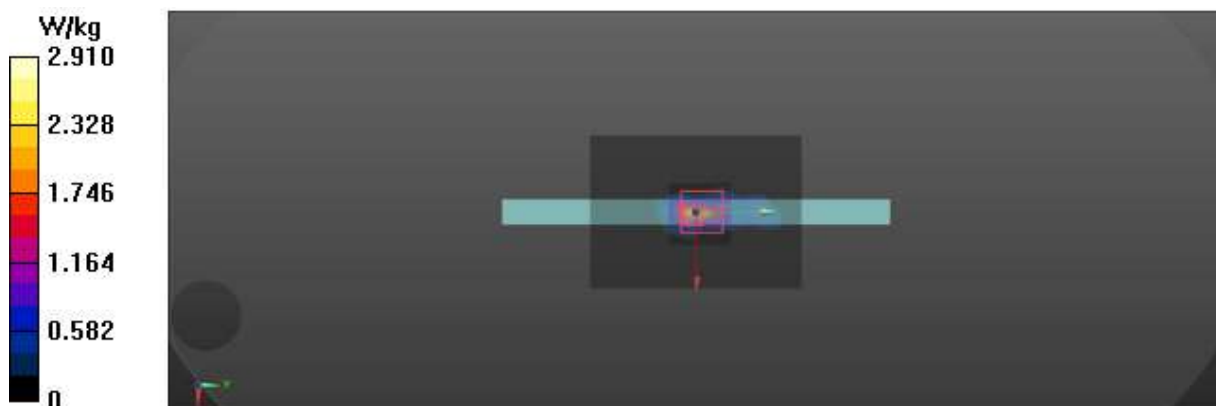

#19

Date: 2019-09-05

Test Laboratory: KCTL Inc.

File Name: [2.802.11 ac BW80 Body Tablet.da53:2](#)**DUT: NP930QCG, Type: Tablet, Serial: 1BP591ZM80073M**

Communication System: UID 0, 5GWLAN (0); Frequency: 5290 MHz; Duty Cycle: 1:1  
Medium parameters used (interpolated):  $f = 5290$  MHz;  $\sigma = 4.807$  S/m;  $\epsilon_r = 35.299$ ;  $\rho = 1000$  kg/m<sup>3</sup>  
Phantom section: Flat Section

DASY5 Configuration:

- Probe: EX3DV4 - SN3928;ConvF(4.95, 4.95, 4.95) @ 5290 MHz; Calibrated: 2019-01-31
- Sensor-Surface: 1.4mm (Mechanical Surface Detection)
- Electronics: DAE4 Sn1342; Calibrated: 2019-05-23
- Phantom: ELI V5.0 (20deg probe tilt)\_2\_20180808; Type: QD OVA 002 BB; Serial: 1220
- Measurement SW: DASY52, Version 52.10 (2);

**Configuration 3/802.11 ac\_BW80\_Ant.1\_CH58\_Right 0 mm re/Area Scan (9x12x1):**

Measurement grid: dx=10mm, dy=10mm

Info: Interpolated medium parameters used for SAR evaluation.

Maximum value of SAR (measured) = 2.42 W/kg

**Configuration 3/802.11 ac\_BW80\_Ant.1\_CH58\_Right 0 mm re/Zoom Scan (9x11x7)/Cube 0:**

Measurement grid: dx=4mm, dy=4mm, dz=1.4mm

Reference Value = 16.80 V/m; Power Drift = -0.04 dB

Peak SAR (extrapolated) = 8.89 W/kg

**SAR(1 g) = 0.937 W/kg; SAR(10 g) = 0.202 W/kg**

Info: Interpolated medium parameters used for SAR evaluation.

Maximum value of SAR (measured) = 3.26 W/kg

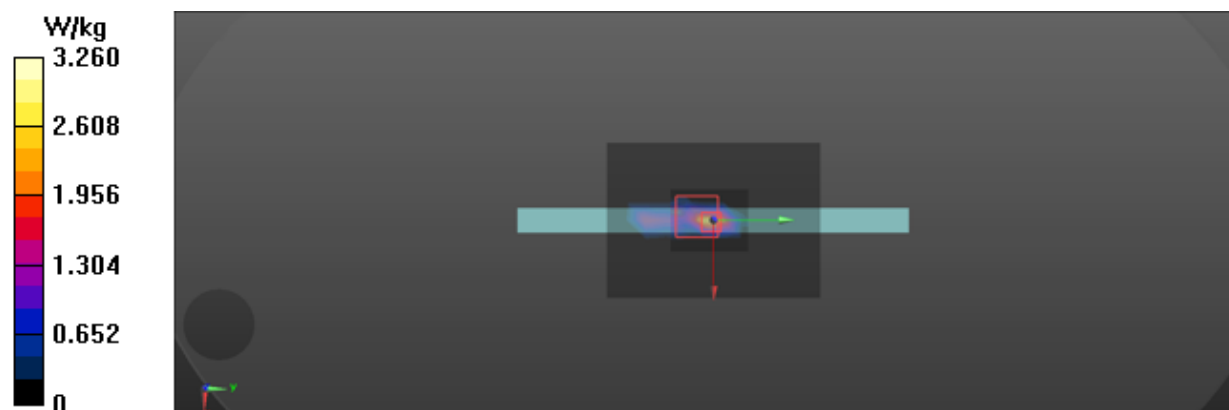

#20

Date: 2019-09-11

Test Laboratory: KCTL Inc.

File Name: [2.802.11 ac Body Tablet.da53:2](#)**DUT: NP930QCG, Type: Tablet, Serial: 1BP591ZM80073M**Communication System: UID 0, 5GWLAN (0); Frequency: 5530 MHz; Duty Cycle: 1:1  
Medium parameters used (interpolated):  $f = 5530$  MHz;  $\sigma = 5.064$  S/m;  $\epsilon_r = 34.941$ ;  $\rho = 1000$  kg/m<sup>3</sup>  
Phantom section: Flat Section

DASY5 Configuration:

- Probe: EX3DV4 - SN3928;ConvF(4.86, 4.86, 4.86) @ 5530 MHz; Calibrated: 2019-01-31
- Sensor-Surface: 1.4mm (Mechanical Surface Detection)
- Electronics: DAE4 Sn1342; Calibrated: 2019-05-23
- Phantom: ELI V5.0 (20deg probe tilt)\_2\_20180808; Type: QD OVA 002 BB; Serial: 1220
- Measurement SW: DASY52, Version 52.10 (2);

**Configuration 3/802.11 ac\_BW80\_Ant.0\_CH106\_Left 0 mm/Area Scan (9x14x1):** Measurement grid: dx=10mm, dy=10mm**Info: Interpolated medium parameters used for SAR evaluation.**

Maximum value of SAR (measured) = 2.95 W/kg

**Configuration 3/802.11 ac\_BW80\_Ant.0\_CH106\_Left 0 mm/Zoom Scan (9x9x7)/Cube 0:**

Measurement grid: dx=4mm, dy=4mm, dz=1.4mm

Reference Value = 29.60 V/m; Power Drift = -0.11 dB

Peak SAR (extrapolated) = 9.71 W/kg

**SAR(1 g) = 1.14 W/kg; SAR(10 g) = 0.265 W/kg****Info: Interpolated medium parameters used for SAR evaluation.**

Maximum value of SAR (measured) = 4.08 W/kg

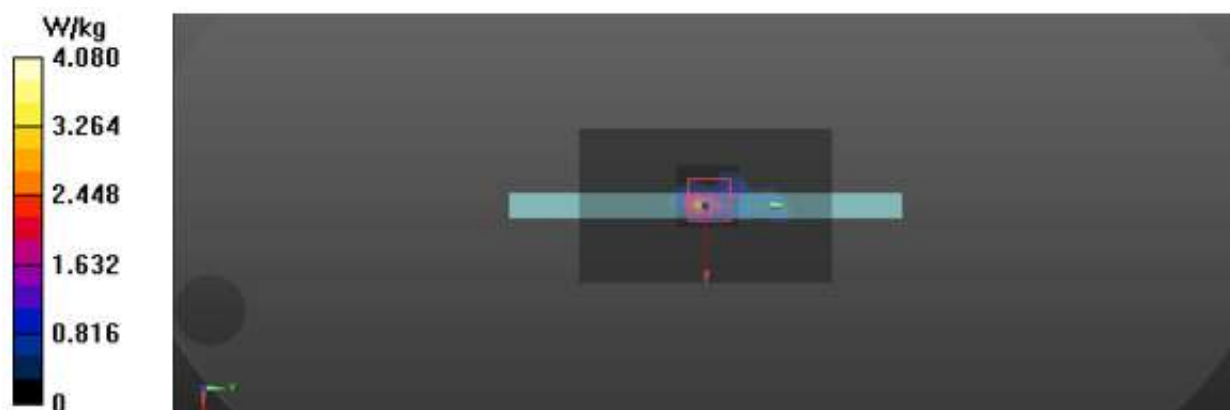

This test report shall not be reproduced, except in full, without the written approval

KCTL-TIA002-004/2

#21

Date: 2019-09-06

Test Laboratory: KCTL Inc.

File Name: [2.802.11 ac Body Tablet.da53:2](#)**DUT: NP930QCG, Type: Tablet, Serial: 1BP591ZM80073M**

Communication System: UID 0, 5GWLAN (0); Frequency: 5530 MHz; Duty Cycle: 1:1  
Medium parameters used (interpolated):  $f = 5530$  MHz;  $\sigma = 4.969$  S/m;  $\epsilon_r = 35.088$ ;  $\rho = 1000$  kg/m<sup>3</sup>  
Phantom section: Flat Section

DASY5 Configuration:

- Probe: EX3DV4 - SN3928;ConvF(4.86, 4.86, 4.86) @ 5530 MHz; Calibrated: 2019-01-31
- Sensor-Surface: 1.4mm (Mechanical Surface Detection)
- Electronics: DAE4 Sn1342; Calibrated: 2019-05-23
- Phantom: ELI V5.0 (20deg probe tilt)\_2\_20180808; Type: QD OVA 002 BB; Serial: 1220
- Measurement SW: DASY52, Version 52.10 (2);

**Configuration 3/802.11 ac\_BW80\_MIMO\_CH106\_Left 0 mm/Area Scan (9x14x1):**

Measurement grid: dx=10mm, dy=10mm

Info: [Interpolated medium parameters used for SAR evaluation.](#)

Maximum value of SAR (measured) = 2.49 W/kg

**Configuration 3/802.11 ac\_BW80\_MIMO\_CH106\_Left 0 mm/Zoom Scan (9x11x7)/Cube 0:**

Measurement grid: dx=4mm, dy=4mm, dz=1.4mm

Reference Value = 17.07 V/m; Power Drift = -0.19 dB

Peak SAR (extrapolated) = 8.63 W/kg

**SAR(1 g) = 0.996 W/kg; SAR(10 g) = 0.231 W/kg**Info: [Interpolated medium parameters used for SAR evaluation.](#)

Maximum value of SAR (measured) = 2.87 W/kg

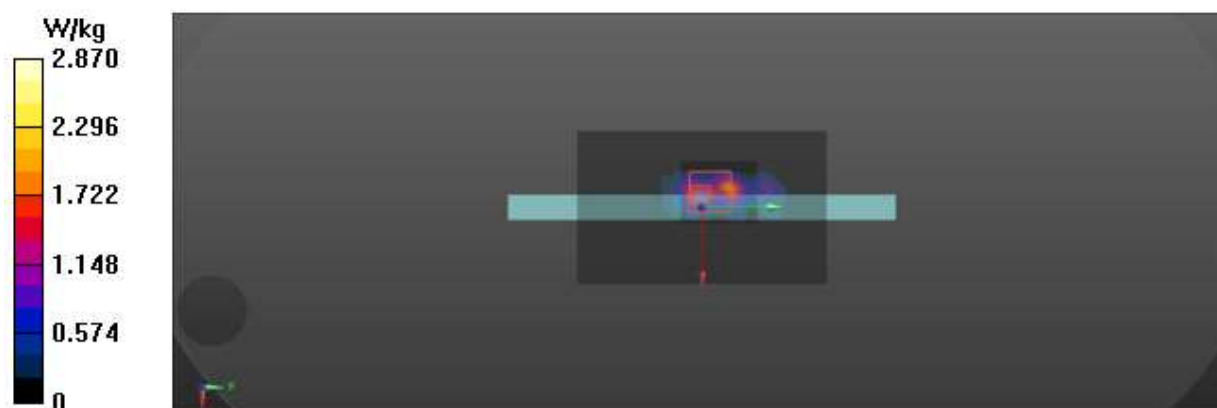

This test report shall not be reproduced, except in full, without the written approval

KCTL-TIA002-004/2

#22

Date: 2019-09-06

Test Laboratory: KCTL Inc.

File Name: [2.802.11 ac Body Tablet.da53:2](#)**DUT: NP930QCG, Type: Tablet, Serial: 1BP591ZM80073M**

Communication System: UID 0, 5GWLAN (0); Frequency: 5690 MHz; Duty Cycle: 1:1  
Medium parameters used (interpolated):  $f = 5690$  MHz;  $\sigma = 5.166$  S/m;  $\epsilon_r = 34.83$ ;  $\rho = 1000$  kg/m<sup>3</sup>  
Phantom section: Flat Section

DASY5 Configuration:

- Probe: EX3DV4 - SN3928;ConvF(4.78, 4.78, 4.78) @ 5690 MHz; Calibrated: 2019-01-31
- Sensor-Surface: 1.4mm (Mechanical Surface Detection)
- Electronics: DAE4 Sn1342; Calibrated: 2019-05-23
- Phantom: ELI V5.0 (20deg probe tilt)\_2\_20180808; Type: QD OVA 002 BB; Serial: 1220
- Measurement SW: DASY52, Version 52.10 (2);

**Configuration 3/802.11 ac\_BW80\_Ant.1\_CH138\_Right 0 mm re/Area Scan (9x14x1):**

Measurement grid: dx=10mm, dy=10mm

Info: Interpolated medium parameters used for SAR evaluation.

Maximum value of SAR (measured) = 2.54 W/kg

**Configuration 3/802.11 ac\_BW80\_Ant.1\_CH138\_Right 0 mm re/Zoom Scan (9x9x7)/Cube 0:**

Measurement grid: dx=4mm, dy=4mm, dz=1.4mm

Reference Value = 26.48 V/m; Power Drift = 0.17 dB

Peak SAR (extrapolated) = 7.40 W/kg

**SAR(1 g) = 1.03 W/kg; SAR(10 g) = 0.244 W/kg**

Info: Interpolated medium parameters used for SAR evaluation.

Maximum value of SAR (measured) = 3.18 W/kg

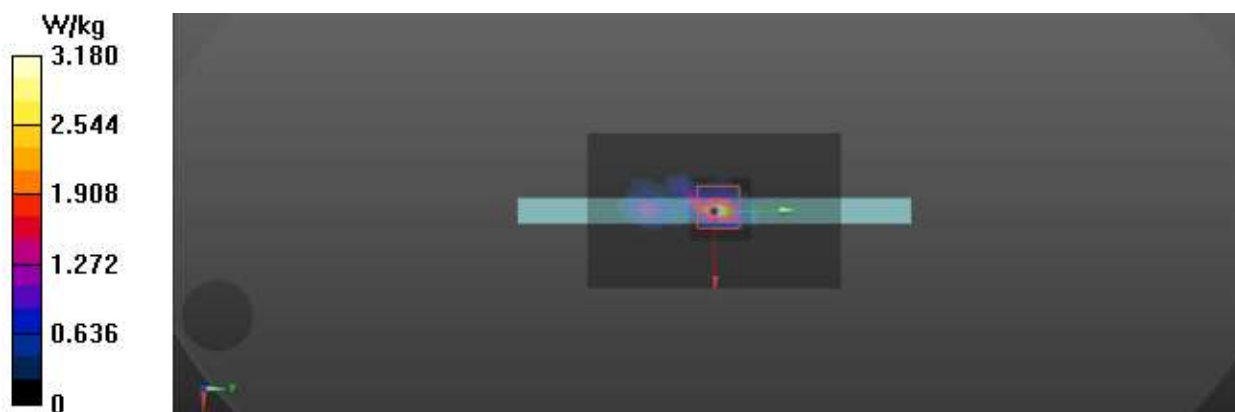



#23

Date: 2019-09-10

Test Laboratory: KCTL Inc.

File Name: [2.802.11 ac Body Tablet.da53:2](#)**DUT: NP930QCG, Type: Tablet, Serial: 1BP591ZM80073M**

Communication System: UID 0, 5GWLAN (0); Frequency: 5775 MHz; Duty Cycle: 1:1

Medium parameters used:  $f = 5775$  MHz;  $\sigma = 5.25$  S/m;  $\epsilon_r = 36.287$ ;  $\rho = 1000$  kg/m<sup>3</sup>

Phantom section: Flat Section

DASY5 Configuration:

- Probe: EX3DV4 - SN3928;ConvF(4.7, 4.7, 4.7) @ 5775 MHz; Calibrated: 2019-01-31
- Sensor-Surface: 1.4mm (Mechanical Surface Detection)
- Electronics: DAE4 Sn1342; Calibrated: 2019-05-23
- Phantom: ELI V5.0 (20deg probe tilt)\_2\_20180808; Type: QD OVA 002 BB; Serial: 1220
- Measurement SW: DASY52, Version 52.10 (2);

**Configuration 3/802.11 ac\_BW80\_Ant.1\_CH155\_Right 0 mm/Area Scan (9x14x1):**

Measurement grid: dx=10mm, dy=10mm

Maximum value of SAR (measured) = 2.51 W/kg

**Configuration 3/802.11 ac\_BW80\_Ant.1\_CH155\_Right 0 mm/Zoom Scan (9x9x7)/Cube 0:**

Measurement grid: dx=4mm, dy=4mm, dz=1.4mm

Reference Value = 26.62 V/m; Power Drift = -0.12 dB

Peak SAR (extrapolated) = 6.87 W/kg

**SAR(1 g) = 0.795 W/kg; SAR(10 g) = 0.163 W/kg**

Maximum value of SAR (measured) = 3.06 W/kg

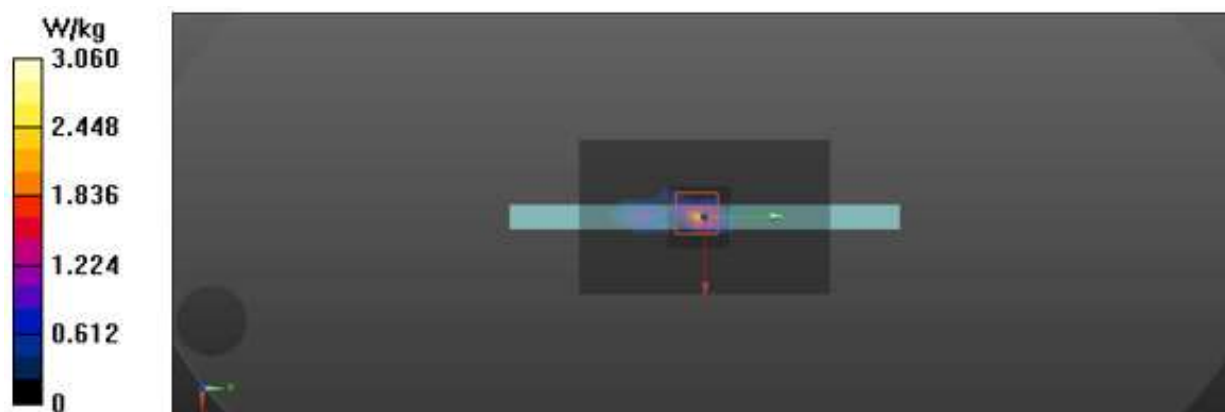

#24

Date: 2019-09-10

Test Laboratory: KCTL Inc.

File Name: [2.802.11 ac Body Tablet.da53:2](#)**DUT: NP930QCG, Type: Tablet, Serial: 1BP591ZM80073M**

Communication System: UID 0, 5GWLAN (0); Frequency: 5775 MHz; Duty Cycle: 1:1

Medium parameters used:  $f = 5775$  MHz;  $\sigma = 5.25$  S/m;  $\epsilon_r = 36.287$ ;  $\rho = 1000$  kg/m<sup>3</sup>

Phantom section: Flat Section

DASY5 Configuration:

- Probe: EX3DV4 - SN3928;ConvF(4.7, 4.7, 4.7) @ 5775 MHz; Calibrated: 2019-01-31
- Sensor-Surface: 1.4mm (Mechanical Surface Detection)
- Electronics: DAE4 Sn1342; Calibrated: 2019-05-23
- Phantom: ELI V5.0 (20deg probe tilt)\_2\_20180808; Type: QD OVA 002 BB; Serial: 1220
- Measurement SW: DASY52, Version 52.10 (2);

**Configuration 3/802.11 ac\_BW80\_MIMO\_CH155\_Left 0 mm/Area Scan (9x14x1):**

Measurement grid: dx=10mm, dy=10mm

Maximum value of SAR (measured) = 1.34 W/kg

**Configuration 3/802.11 ac\_BW80\_MIMO\_CH155\_Left 0 mm/Zoom Scan (9x10x7)/Cube 0:**

Measurement grid: dx=4mm, dy=4mm, dz=1.4mm

Reference Value = 17.06 V/m; Power Drift = -0.14 dB

Peak SAR (extrapolated) = 6.89 W/kg

**SAR(1 g) = 0.771 W/kg; SAR(10 g) = 0.178 W/kg**

Maximum value of SAR (measured) = 2.57 W/kg

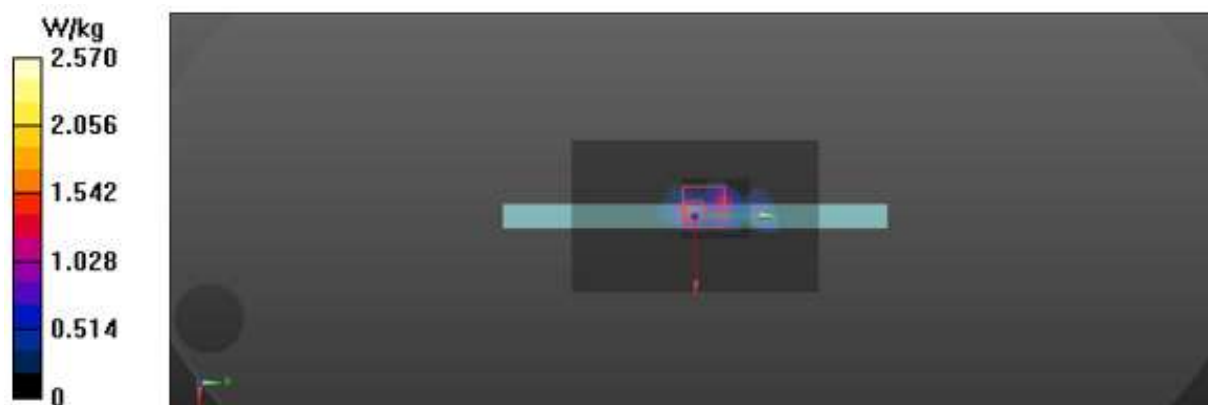

#25

Date: 2019-09-10

Test Laboratory: KCTL Inc.

File Name: [2.802.11 ac Body Tablet.da53:2](#)**DUT: NP930QCG, Type: Tablet, Serial: 1BP591ZM80073M**

Communication System: UID 0, 5GWLAN (0); Frequency: 5775 MHz; Duty Cycle: 1:1

Medium parameters used:  $f = 5775$  MHz;  $\sigma = 5.25$  S/m;  $\epsilon_r = 36.287$ ;  $\rho = 1000$  kg/m<sup>3</sup>

Phantom section: Flat Section

DASY5 Configuration:

- Probe: EX3DV4 - SN3928;ConvF(4.7, 4.7, 4.7) @ 5775 MHz; Calibrated: 2019-01-31
- Sensor-Surface: 1.4mm (Mechanical Surface Detection)
- Electronics: DAE4 Sn1342; Calibrated: 2019-05-23
- Phantom: ELI V5.0 (20deg probe tilt)\_2\_20180808; Type: QD OVA 002 BB; Serial: 1220
- Measurement SW: DASY52, Version 52.10 (2);

**Configuration 3/802.11 ac\_BW80\_Ant.0\_CH155\_Left 0 mm re/Area Scan (9x14x1):**

Measurement grid: dx=10mm, dy=10mm

Maximum value of SAR (measured) = 1.86 W/kg

**Configuration 3/802.11 ac\_BW80\_Ant.0\_CH155\_Left 0 mm re/Zoom Scan (9x10x7)/Cube 0:**

Measurement grid: dx=4mm, dy=4mm, dz=1.4mm

Reference Value = 19.63 V/m; Power Drift = -0.17 dB

Peak SAR (extrapolated) = 8.93 W/kg

**SAR(1 g) = 1.02 W/kg; SAR(10 g) = 0.243 W/kg**

Maximum value of SAR (measured) = 3.37 W/kg

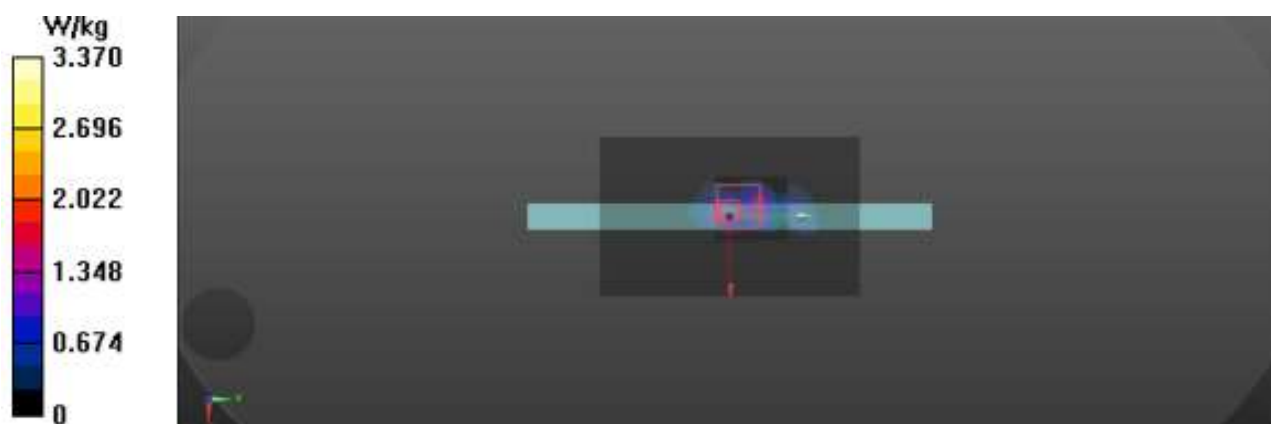

#26

Date: 2019-09-04

Test Laboratory: KCTL Inc.

File Name: [4.Bluetooth GFSK DH5 Body Tablet.da53:1](#)**DUT: NP930QCG, Type: Tablet, Serial: 1BP591ZM80073M**

Communication System: UID 0, Bluetooth (0); Frequency: 2480 MHz; Duty Cycle: 1:1.30017

Medium parameters used:  $f = 2480$  MHz;  $\sigma = 1.863$  S/m;  $\epsilon_r = 39.189$ ;  $\rho = 1000$  kg/m<sup>3</sup>

Phantom section: Flat Section

DASY5 Configuration:

- Probe: EX3DV4 - SN3928;ConvF(7.21, 7.21, 7.21) @ 2480 MHz; Calibrated: 2019-01-31
- Sensor-Surface: 1.4mm (Mechanical Surface Detection)
- Electronics: DAE4 Sn1342; Calibrated: 2019-05-23
- Phantom: ELI V5.0 (20deg probe tilt)\_3\_20180808; Type: QD OVA 002 AA; Serial: 1173
- Measurement SW: DASY52, Version 52.10 (2);

**Configuration 3/Bluetooth\_GFSK\_DH5\_CH78\_Right 0 mm/Area Scan (8x11x1):** Measurement grid: dx=12mm, dy=12mm

Maximum value of SAR (measured) = 0.231 W/kg

**Configuration 3/Bluetooth\_GFSK\_DH5\_CH78\_Right 0 mm/Zoom Scan (7x7x7)/Cube 0:**

Measurement grid: dx=5mm, dy=5mm, dz=5mm

Reference Value = 10.70 V/m; Power Drift = 0.03 dB

Peak SAR (extrapolated) = 0.634 W/kg

**SAR(1 g) = 0.093 W/kg; SAR(10 g) = 0.035 W/kg**

Maximum value of SAR (measured) = 0.204 W/kg

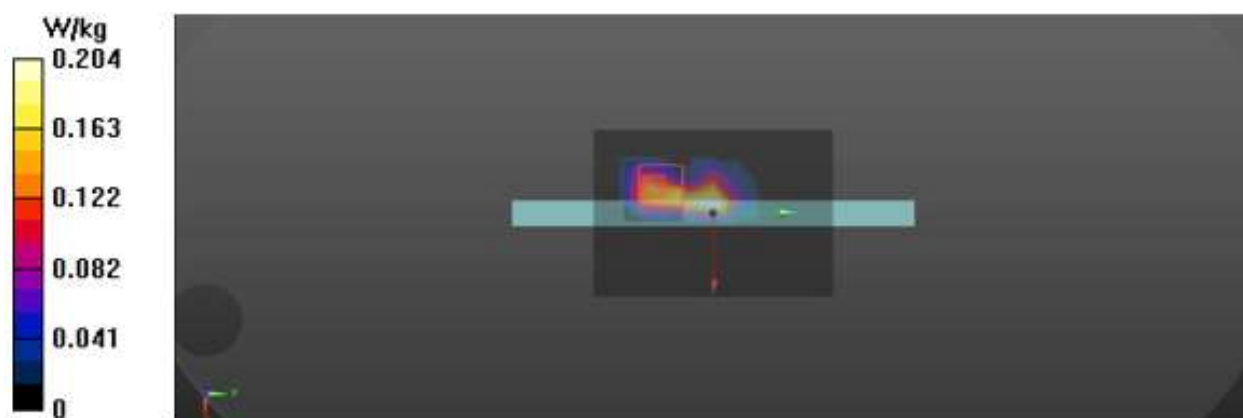

**KCTL Inc.**

65, Sinwon-ro, Yeongtong-gu,  
Suwon-si, Gyeonggi-do, 16677, Korea  
TEL: 82-31-285-0894 FAX: 82-505-299-8311  
[www.kctl.co.kr](http://www.kctl.co.kr)

Report No.:  
KR19-SPF0028  
Page (69) of (131)

**Appendixes List**

<b>Appendix A</b>	A.1 Probe Calibration certificate (EX3DV4_3928) A.2 Dipole Calibration certificate (D2450V2_895) A.3 Dipole Calibration certificate (D5GHzV2_1134) A.4 Justification for Extended SAR Dipole Calibrations
<b>Appendix B</b>	SAR Tissue Specification
<b>Appendix C</b>	IEEE 802.11ax SAR Power
<b>Appendix D</b>	Antenna Location & Distance
<b>Appendix E</b>	EUT Photo
<b>Appendix F</b>	Test Setup Photo



# KCTL Inc.

65, Sinwon-ro, Yeongtong-gu,  
Suwon-si, Gyeonggi-do, 16677, Korea  
TEL: 82-31-285-0894 FAX: 82-505-299-8311  
[www.kctl.co.kr](http://www.kctl.co.kr)

Report No.:  
KR19-SPF0028  
Page (70) of (131)

# KCTL

## Appendix A. Calibration certificate Appendix A.1 Probe Calibration certificate (EX3DV4\_3928)

Calibration Laboratory of  
Schmid & Partner  
Engineering AG  
Zeughausstrasse 43, 8004 Zurich, Switzerland



S Schweizerischer Kalibrierdienst  
C Service suisse d'étalonnage  
S Servizio svizzero di taratura  
S Swiss Calibration Service

Accredited by the Swiss Accreditation Service (SAS)  
The Swiss Accreditation Service is one of the signatories to the EA  
Multilateral Agreement for the recognition of calibration certificates

Accreditation No.: SCS 0108

Client KCTL (Dymstec)

Certificate No: EX3-3928\_Jan19

### CALIBRATION CERTIFICATE

Object EX3DV4 - SN:3928

Calibration procedure(s) QA CAL-01.v9, QA CAL-14.v5, QA CAL-23.v5, QA CAL-25.v7  
Calibration procedure for dosimetric E-field probes

Calibration date: January 31, 2019

This calibration certificate documents the traceability to national standards, which realize the physical units of measurements (SI).  
The measurements and the uncertainties with confidence probability are given on the following pages and are part of the certificate.

All calibrations have been conducted in the closed laboratory facility: environment temperature (22 ± 3)°C and humidity < 70%.

Calibration Equipment used (M&TE critical for calibration)

Primary Standards	ID	Cal Date (Certificate No.)	Scheduled Calibration
Power meter NRP	SN: 104778	04-Apr-18 (No. 217-02672/02673)	Apr-19
Power sensor NRP-Z91	SN: 103244	04-Apr-18 (No. 217-02672)	Apr-19
Power sensor NRP-Z91	SN: 103245	04-Apr-18 (No. 217-02673)	Apr-19
Reference 20 dB Attenuator	SN: S5277 (20x)	04-Apr-18 (No. 217-02682)	Apr-19
DAE4	SN: 660	19-Dec-18 (No. DAE4-660_Dec18)	Dec-19
Reference Probe ES3DV2	SN: 3013	31-Dec-18 (No. ES3-3013_Dec18)	Dec-19
Secondary Standards	ID	Check Date (in house)	Scheduled Check
Power meter E4419B	SN: GB41293874	06-Apr-16 (in house check Jun-16)	In house check: Jun-20
Power sensor E4412A	SN: MY41498067	06-Apr-16 (in house check Jun-16)	In house check: Jun-20
Power sensor E4412A	SN: 000110210	06-Apr-16 (in house check Jun-16)	In house check: Jun-20
RF generator HP B648C	SN: US3642U01700	04-Aug-99 (in house check Jun-18)	In house check: Jun-20
Network Analyzer E8358A	SN: US41080477	31-Mar-14 (in house check Oct-18)	In house check: Oct-19

	Name	Function	Signature
Calibrated by:	Jeton Kasrafi	Laboratory Technician	
Approved by:	Kalja Pokovic	Technical Manager	

Issued: February 2, 2019

This calibration certificate shall not be reproduced except in full without written approval of the laboratory.

# KCTL Inc.

65, Sinwon-ro, Yeongtong-gu,  
Suwon-si, Gyeonggi-do, 16677, Korea  
TEL: 82-31-285-0894 FAX: 82-505-299-8311  
[www.kctl.co.kr](http://www.kctl.co.kr)

Report No.:  
KR19-SPF0028  
Page (71) of (131)

# KCTL

Calibration Laboratory of  
Schmid & Partner  
Engineering AG  
Zeughausstrasse 43, 8004 Zurich, Switzerland



S Schweizerischer Kalibrierdienst  
S Service suisse d'étalonnage  
S Servizio svizzero di taratura  
S Swiss Calibration Service

Accredited by the Swiss Accreditation Service (SAS)  
The Swiss Accreditation Service is one of the signatories to the EA  
Multilateral Agreement for the recognition of calibration certificates

Accreditation No.: **SCS 0108**

## Glossary:

TSL	tissue simulating liquid
NORM <sub>x,y,z</sub>	sensitivity in free space
ConvF	sensitivity in TSL / NORM <sub>x,y,z</sub>
DCP	diode compression point
CF	crest factor (1/duty_cycle) of the RF signal
A, B, C, D	modulation dependent linearization parameters
Polarization $\varphi$	$\varphi$ rotation around probe axis
Polarization $\theta$	$\theta$ rotation around an axis that is in the plane normal to probe axis (at measurement center), i.e., $\theta = 0$ is normal to probe axis
Connector Angle	information used in DASY system to align probe sensor X to the robot coordinate system

## Calibration is Performed According to the Following Standards:

- IEEE Std 1528-2013, "IEEE Recommended Practice for Determining the Peak Spatial-Averaged Specific Absorption Rate (SAR) in the Human Head from Wireless Communications Devices: Measurement Techniques", June 2013
- IEC 62209-1, "Measurement procedure for the assessment of Specific Absorption Rate (SAR) from hand-held and body-mounted devices used next to the ear (frequency range of 300 MHz to 6 GHz)", July 2016
- IEC 62209-2, "Procedure to determine the Specific Absorption Rate (SAR) for wireless communication devices used in close proximity to the human body (frequency range of 30 MHz to 6 GHz)", March 2010
- KDB 865664, "SAR Measurement Requirements for 100 MHz to 6 GHz"

## Methods Applied and Interpretation of Parameters:

- NORM<sub>x,y,z</sub>**: Assessed for E-field polarization  $\theta = 0$  ( $f \leq 900$  MHz in TEM-cell;  $f > 1800$  MHz: R22 waveguide). NORM<sub>x,y,z</sub> are only intermediate values, i.e., the uncertainties of NORM<sub>x,y,z</sub> does not affect the E<sup>2</sup>-field uncertainty inside TSL (see below ConvF).
- NORM( $f$ )<sub>x,y,z</sub>** = NORM<sub>x,y,z</sub> \* frequency\_response (see Frequency Response Chart). This linearization is implemented in DASY4 software versions later than 4.2. The uncertainty of the frequency response is included in the stated uncertainty of ConvF.
- DCP<sub>x,y,z</sub>**: DCP are numerical linearization parameters assessed based on the data of power sweep with CW signal (no uncertainty required). DCP does not depend on frequency nor media.
- PAR**: PAR is the Peak to Average Ratio that is not calibrated but determined based on the signal characteristics
- A<sub>x,y,z</sub>; B<sub>x,y,z</sub>; C<sub>x,y,z</sub>; D<sub>x,y,z</sub>; VR<sub>x,y,z</sub>**: A, B, C, D are numerical linearization parameters assessed based on the data of power sweep for specific modulation signal. The parameters do not depend on frequency nor media. VR is the maximum calibration range expressed in RMS voltage across the diode.
- ConvF and Boundary Effect Parameters**: Assessed in flat phantom using E-field (or Temperature Transfer Standard for  $f \leq 800$  MHz) and inside waveguide using analytical field distributions based on power measurements for  $f > 800$  MHz. The same setups are used for assessment of the parameters applied for boundary compensation (alpha, depth) of which typical uncertainty values are given. These parameters are used in DASY4 software to improve probe accuracy close to the boundary. The sensitivity in TSL corresponds to NORM<sub>x,y,z</sub> \* ConvF whereby the uncertainty corresponds to that given for ConvF. A frequency dependent ConvF is used in DASY version 4.4 and higher which allows extending the validity from  $\pm 50$  MHz to  $\pm 100$  MHz.
- Spherical isotropy (3D deviation from isotropy)**: in a field of low gradients realized using a flat phantom exposed by a patch antenna.
- Sensor Offset**: The sensor offset corresponds to the offset of virtual measurement center from the probe tip (on probe axis). No tolerance required.
- Connector Angle**: The angle is assessed using the information gained by determining the NORM<sub>x</sub> (no uncertainty required).

# KCTL Inc.

65, Sinwon-ro, Yeongtong-gu,  
Suwon-si, Gyeonggi-do, 16677, Korea  
TEL: 82-31-285-0894 FAX: 82-505-299-8311  
[www.kctl.co.kr](http://www.kctl.co.kr)

Report No.:  
KR19-SPF0028  
Page (72) of (131)



EX3DV4 – SN:3928

January 31, 2019

## DASY/EASY - Parameters of Probe: EX3DV4 - SN:3928

### Basic Calibration Parameters

	Sensor X	Sensor Y	Sensor Z	Unc (k=2)
Norm ( $\mu\text{V}/(\text{V}/\text{m})^2$ ) <sup>A</sup>	0.48	0.22	0.55	± 10.1 %
DCP ( $\text{mV}$ ) <sup>B</sup>	94.9	94.8	96.3	

### Calibration Results for Modulation Response

UID	Communication System Name		A dB	B dB $\sqrt{\mu\text{V}}$	C	D dB	VR mV	Max dev.	Unc (k=2)
0	CW	X	0.0	0.0	1.0	0.00	135.8	±3.0 %	± 4.7 %
		Y	0.0	0.0	1.0		135.4		
		Y	0.0	0.0	1.0		143.6		

The reported uncertainty of measurement is stated as the standard uncertainty of measurement multiplied by the coverage factor  $k=2$ , which for a normal distribution corresponds to a coverage probability of approximately 95%.

<sup>A</sup> The uncertainties of Norm X, Y, Z do not affect the E<sup>2</sup>-field uncertainty inside TSL (see Pages 5 and 6).

<sup>B</sup> Numerical linearization parameter; uncertainty not required.

<sup>C</sup> Uncertainty is determined using the max. deviation from linear response applying rectangular distribution and is expressed for the square of the field value.





**KCTL Inc.**

65, Sinwon-ro, Yeongtong-gu,  
Suwon-si, Gyeonggi-do, 16677, Korea  
TEL: 82-31-285-0894 FAX: 82-505-299-8311  
[www.kctl.co.kr](http://www.kctl.co.kr)

Report No.:  
KR19-SPF0028  
Page (73) of (131)

**KCTL**

EX3DV4- SN:3928

January 31, 2019

**DASY/EASY - Parameters of Probe: EX3DV4 - SN:3928****Other Probe Parameters**

Sensor Arrangement	Triangular
Connector Angle (°)	70.7
Mechanical Surface Detection Mode	enabled
Optical Surface Detection Mode	disabled
Probe Overall Length	337 mm
Probe Body Diameter	10 mm
Tip Length	9 mm
Tip Diameter	2.5 mm
Probe Tip to Sensor X Calibration Point	1 mm
Probe Tip to Sensor Y Calibration Point	1 mm
Probe Tip to Sensor Z Calibration Point	1 mm
Recommended Measurement Distance from Surface	1.4 mm

**KCTL**

EX3DV4-SN:3928

January 31, 2019

**DASY/EASY - Parameters of Probe: EX3DV4 - SN:3928****Calibration Parameter Determined in Head Tissue Simulating Media**

f (MHz) <sup>c</sup>	Relative Permittivity <sup>e</sup>	Conductivity (S/m) <sup>f</sup>	ConvF X	ConvF Y	ConvF Z	Alpha <sup>g</sup>	Depth <sup>h</sup> (mm)	Unc (k=2)
750	41.9	0.89	9.34	9.34	9.34	0.55	0.90	± 12.0 %
850	41.5	0.92	9.27	9.27	9.27	0.60	0.85	± 12.0 %
900	41.5	0.97	9.02	9.02	9.02	0.47	0.89	± 12.0 %
1750	40.1	1.37	7.97	7.97	7.97	0.38	0.84	± 12.0 %
1900	40.0	1.40	7.79	7.79	7.79	0.25	0.85	± 12.0 %
2300	39.5	1.67	7.51	7.51	7.51	0.28	0.84	± 12.0 %
2450	39.2	1.80	7.21	7.21	7.21	0.31	0.85	± 12.0 %
2600	39.0	1.96	6.92	6.92	6.92	0.35	0.89	± 12.0 %
3500	37.9	2.91	6.86	6.86	6.86	0.25	1.20	± 13.1 %
3700	37.7	3.12	6.70	6.70	6.70	0.25	1.20	± 13.1 %
5200	36.0	4.66	5.16	5.16	5.16	0.40	1.80	± 13.1 %
5300	35.9	4.76	4.95	4.95	4.95	0.40	1.80	± 13.1 %
5500	35.6	4.96	4.86	4.86	4.86	0.40	1.80	± 13.1 %
5600	35.5	5.07	4.78	4.78	4.78	0.40	1.80	± 13.1 %
5800	35.3	5.27	4.70	4.70	4.70	0.40	1.80	± 13.1 %

<sup>c</sup> Frequency validity above 300 MHz of ± 100 MHz only applies for DASY v4.4 and higher (see Page 2), else it is restricted to ± 50 MHz. The uncertainty is the RSS of the ConvF uncertainty at calibration frequency and the uncertainty for the indicated frequency band. Frequency validity below 300 MHz is ± 10, 25, 40, 50 and 70 MHz for ConvF assessments at 30, 64, 128, 150 and 220 MHz respectively. Validity of ConvF assessed at 6 MHz is 4-9 MHz, and ConvF assessed at 13 MHz is 9-19 MHz. Above 5 GHz frequency validity can be extended to ± 110 MHz.

<sup>f</sup> At frequencies below 3 GHz, the validity of tissue parameters ( $\epsilon$  and  $\sigma$ ) can be relaxed to ± 10% if liquid compensation formula is applied to measured SAR values. At frequencies above 3 GHz, the validity of tissue parameters ( $\epsilon$  and  $\sigma$ ) is restricted to ± 5%. The uncertainty is the RSS of the ConvF uncertainty for indicated target tissue parameters.

<sup>g</sup> Alpha/Depth are determined during calibration. SPEAG warrants that the remaining deviation due to the boundary effect after compensation is always less than ± 1% for frequencies below 3 GHz and below ± 2% for frequencies between 3-6 GHz at any distance larger than half the probe tip diameter from the boundary.

EX3DV4-SN:3928

January 31, 2019

**DASY/EASY - Parameters of Probe: EX3DV4 - SN:3928****Calibration Parameter Determined in Body Tissue Simulating Media**

f (MHz) <sup>C</sup>	Relative Permittivity <sup>F</sup>	Conductivity (S/m) <sup>G</sup>	ConvF X	ConvF Y	ConvF Z	Alpha <sup>D</sup>	Depth <sup>D</sup> (mm)	Unc (k=2)
750	55.5	0.96	9.55	9.55	9.55	0.51	0.80	± 12.0 %
850	55.2	0.99	9.32	9.32	9.32	0.39	0.84	± 12.0 %
900	55.0	1.05	9.28	9.28	9.28	0.46	0.86	± 12.0 %
1750	53.4	1.49	7.70	7.70	7.70	0.37	0.84	± 12.0 %
1900	53.3	1.52	7.46	7.46	7.46	0.37	0.84	± 12.0 %
2300	52.9	1.81	7.25	7.25	7.25	0.38	0.86	± 12.0 %
2450	52.7	1.95	7.22	7.22	7.22	0.24	0.93	± 12.0 %
2600	52.5	2.16	6.95	6.95	6.95	0.25	0.94	± 12.0 %
3500	51.3	3.31	6.66	6.66	6.66	0.25	1.20	± 13.1 %
3700	51.0	3.55	6.64	6.64	6.64	0.25	1.25	± 13.1 %
5200	49.0	5.30	4.43	4.43	4.43	0.50	1.90	± 13.1 %
5300	48.9	5.42	4.30	4.30	4.30	0.50	1.90	± 13.1 %
5500	48.6	5.65	4.03	4.03	4.03	0.50	1.90	± 13.1 %
5600	48.5	5.77	3.91	3.91	3.91	0.50	1.90	± 13.1 %
5800	48.2	6.00	4.00	4.00	4.00	0.50	1.90	± 13.1 %

<sup>C</sup> Frequency validity above 300 MHz of ± 100 MHz only applies for DASY v4.4 and higher (see Page 2), else it is restricted to ± 50 MHz. The uncertainty is the RSS of the ConvF uncertainty at calibration frequency and the uncertainty for the indicated frequency band. Frequency validity below 300 MHz is ± 10, 25, 40, 50 and 70 MHz for ConvF assessments at 30, 64, 126, 150 and 220 MHz respectively. Validity of ConvF assessed at 6 MHz is 4-9 MHz, and ConvF assessed at 13 MHz is 9-19 MHz. Above 5 GHz frequency validity can be extended to ± 110 MHz.

<sup>F</sup> At frequencies below 3 GHz, the validity of tissue parameters ( $\epsilon$  and  $\sigma$ ) can be relaxed to ± 10% if liquid compensation formula is applied to measured SAR values. At frequencies above 3 GHz, the validity of tissue parameters ( $\epsilon$  and  $\sigma$ ) is restricted to ± 5%. The uncertainty is the RSS of the ConvF uncertainty for indicated target tissue parameters.

<sup>D</sup> Alpha/Depth are determined during calibration. SPEAG warrants that the remaining deviation due to the boundary effect after compensation is always less than ± 1% for frequencies below 3 GHz and below ± 2% for frequencies between 3-6 GHz at any distance larger than half the probe tip diameter from the boundary.

# KCTL Inc.

65, Sinwon-ro, Yeongtong-gu,  
Suwon-si, Gyeonggi-do, 16677, Korea  
TEL: 82-31-285-0894 FAX: 82-505-299-8311  
[www.kctl.co.kr](http://www.kctl.co.kr)

Report No.:  
KR19-SPF0028  
Page (76) of (131)



EX3DV4-SN:3928

January 31, 2019

## Frequency Response of E-Field (TEM-Cell: ifi110 EXX, Waveguide: R22)

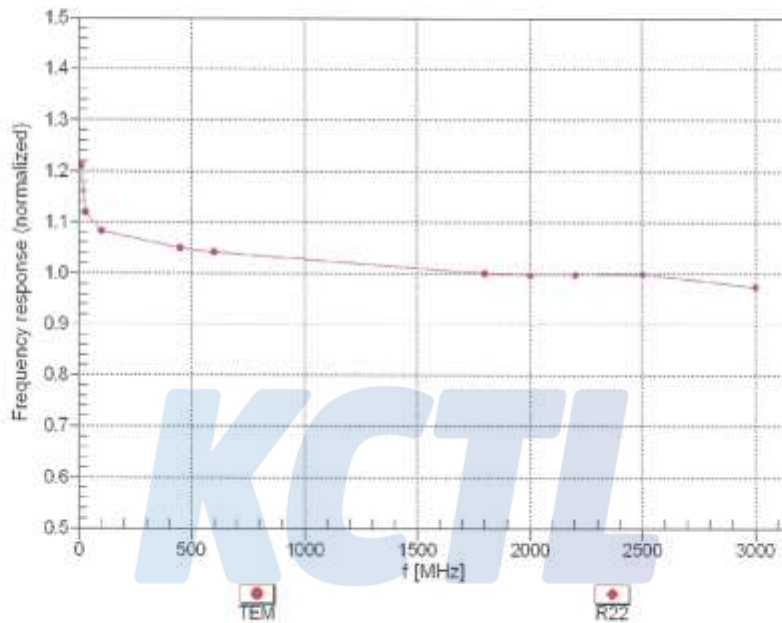

Uncertainty of Frequency Response of E-field:  $\pm 6.3\%$  ( $k=2$ )

EX3DV4- SN:3928

January 31, 2019

**Receiving Pattern ( $\phi$ ),  $\theta = 0^\circ$**

f=600 MHz,TEM



f=1800 MHz,R22

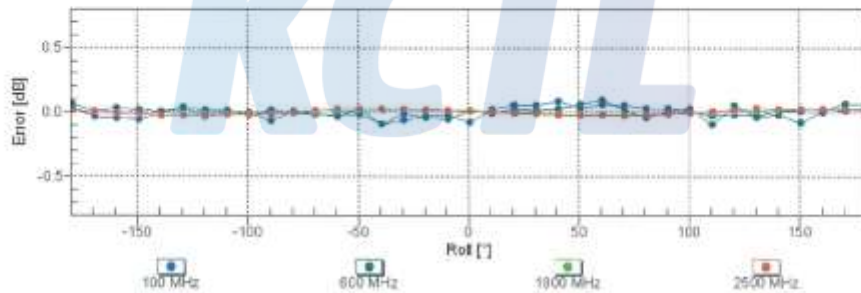
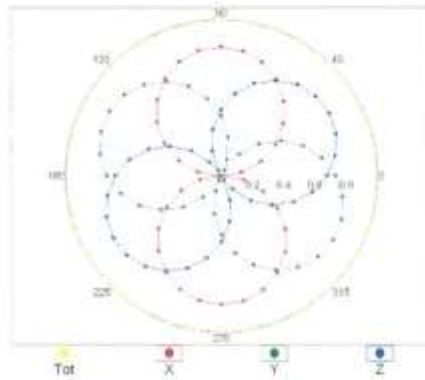

Uncertainty of Axial Isotropy Assessment:  $\pm 0.5\%$  (k=2)

EX3DV4- SN:3928

January 31, 2019

**Dynamic Range  $f(SAR_{head})$**   
(TEM cell,  $f_{eval} = 1900$  MHz)

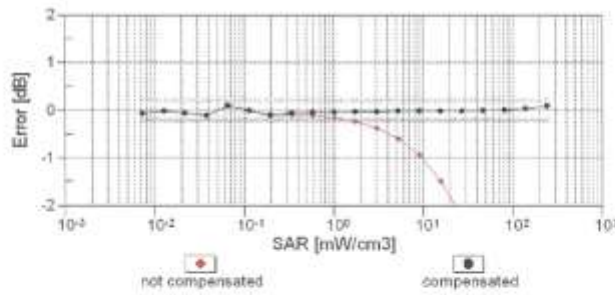
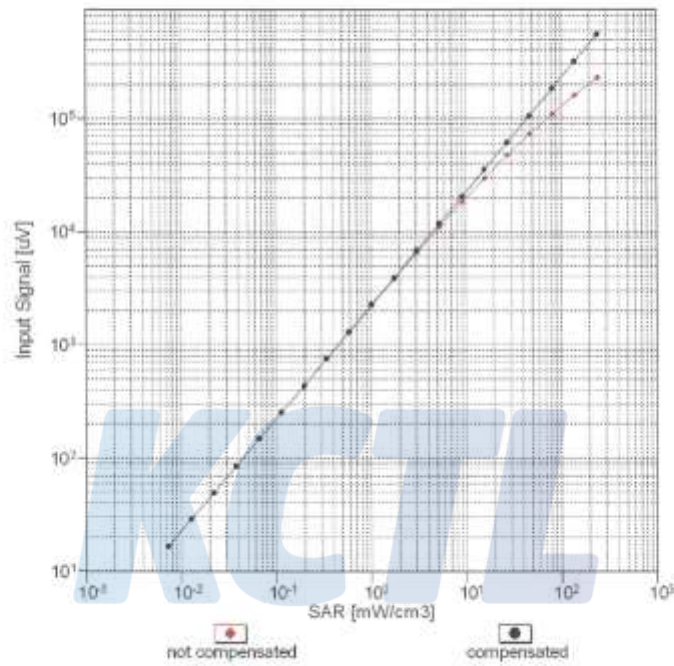

Uncertainty of Linearity Assessment:  $\pm 0.6\%$  (k=2)

EX3DV4-SN:3928

January 31, 2019

### Conversion Factor Assessment

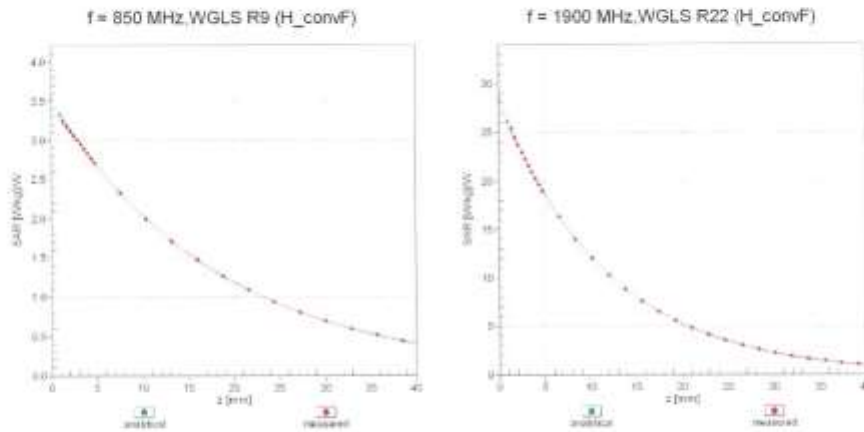

### Deviation from Isotropy in Liquid

Error ( $\phi, \theta$ ), f = 900 MHz

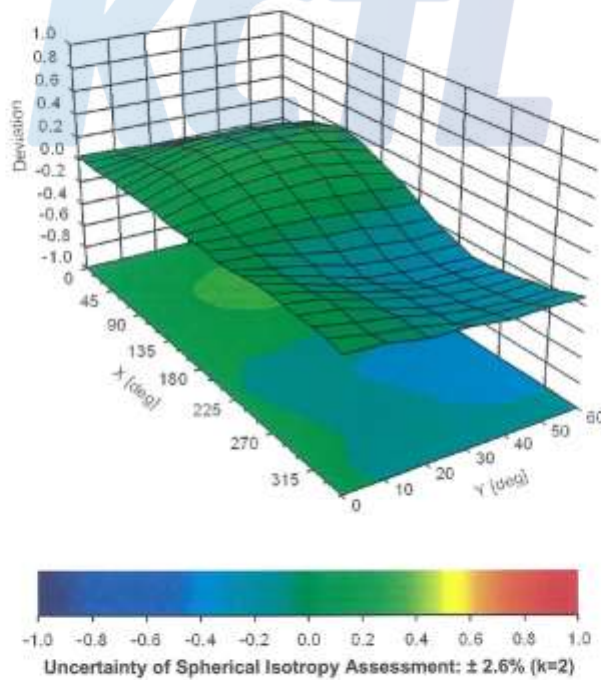

# KCTL Inc.

65, Sinwon-ro, Yeongtong-gu,  
Suwon-si, Gyeonggi-do, 16677, Korea  
TEL: 82-31-285-0894 FAX: 82-505-299-8311  
[www.kctl.co.kr](http://www.kctl.co.kr)

Report No.:  
KR19-SPF0028  
Page (80) of (131)

# KCTL

## Appendix A.2 Dipole Calibration certificate (D2450V2\_895)

Calibration Laboratory of  
Schmid & Partner  
Engineering AG  
Zeughausstrasse 43, 8004 Zurich, Switzerland



S Schweizerischer Kalibrierdienst  
C Service suisse d'étalonnage  
S Servizio svizzero di taratura  
S Swiss Calibration Service

Accredited by the Swiss Accreditation Service (SAS)  
The Swiss Accreditation Service is one of the signatories to the EA  
Multilateral Agreement for the recognition of calibration certificates

Accreditation No.: SCS 0108

Client **KCTL (Dymstec)**

Certificate No: **D2450V2-895\_Jul18**

CALIBRATION CERTIFICATE			
Object	D2450V2 - SN:895		
Calibration procedure(s)	QA CAL-05.v10 Calibration procedure for dipole validation kits above 700 MHz		
Calibration date:	July 24, 2018		
This calibration certificate documents the traceability to national standards, which realize the physical units of measurements (SI). The measurements and the uncertainties with confidence probability are given on the following pages and are part of the certificate.			
All calibrations have been conducted in the closed laboratory facility: environment temperature (22 ± 3)°C and humidity < 70%.			
Calibration Equipment used (M&TE critical for calibration)			
Primary Standards	ID #	Cal Date (Certificate No.)	Scheduled Calibration
Power meter NRP	SN: 10477B	04-Apr-18 (No. 217-02672/02673)	Apr-19
Power sensor NRP-Z91	SN: 103244	04-Apr-18 (No. 217-02672)	Apr-19
Power sensor NRP-Z91	SN: 103245	04-Apr-18 (No. 217-02673)	Apr-19
Reference 20 dB Attenuator	SN: 5058 (20k)	04-Apr-18 (No. 217-02682)	Apr-19
Type-N mismatch combination	SN: 5047.2 / 06327	04-Apr-18 (No. 217-02683)	Apr-19
Reference Probe EX3DV4	SN: 7349	30-Dec-17 (No. EX3-7349_Dec17)	Dec-18
DAE4	SN: 601	26-Oct-17 (No. DAE4-601_Oct17)	Oct-18
Secondary Standards	ID #	Check Date (in house)	Scheduled Check
Power meter EPM-442A	SN: GB37480704	07-Oct-15 (in house check Oct-16)	in house check: Oct-18
Power sensor HP 8481A	SN: US37292783	07-Oct-15 (in house check Oct-16)	in house check: Oct-18
Power sensor HP 8481A	SN: MY41092317	07-Oct-15 (in house check Oct-16)	in house check: Oct-18
RF generator R&S SMT-06	SN: 100972	15-Jun-15 (in house check Oct-16)	in house check: Oct-18
Network Analyzer Agilent E8358A	SN: US41080477	31-Mar-14 (in house check Oct-17)	in house check: Oct-18
Calibrated by:	Name Claudio Leubler	Function Laboratory Technician	Signature 
Approved by:	Name Katja Pokovic	Function Technical Manager	Signature 
This calibration certificate shall not be reproduced except in full without written approval of the laboratory.			
Issued: July 24, 2018			

Certificate No: D2450V2-895\_Jul18

Page 1 of 8



# KCTL Inc.

65, Sinwon-ro, Yeongtong-gu,  
Suwon-si, Gyeonggi-do, 16677, Korea  
TEL: 82-31-285-0894 FAX: 82-505-299-8311  
[www.kctl.co.kr](http://www.kctl.co.kr)

Report No.:  
KR19-SPF0028  
Page (81) of (131)

# KCTL

**Calibration Laboratory of  
Schmid & Partner  
Engineering AG**  
Zeughausstrasse 43, 8004 Zurich, Switzerland



**S** Schweizerischer Kalibrierdienst  
**C** Service suisse d'étalonnage  
**S** Servizio svizzero di taratura  
**S** Swiss Calibration Service

Accredited by the Swiss Accreditation Service (SAS)  
The Swiss Accreditation Service is one of the signatories to the EA  
Multilateral Agreement for the recognition of calibration certificates

Accreditation No.: **SCS 0108**

### Glossary:

TSL	tissue simulating liquid
ConvF	sensitivity in TSL / NORM x,y,z
N/A	not applicable or not measured

### Calibration is Performed According to the Following Standards:

- IEEE Std 1528-2013, "IEEE Recommended Practice for Determining the Peak Spatial-Averaged Specific Absorption Rate (SAR) in the Human Head from Wireless Communications Devices: Measurement Techniques", June 2013
- IEC 62209-1, "Measurement procedure for the assessment of Specific Absorption Rate (SAR) from hand-held and body-mounted devices used next to the ear (frequency range of 300 MHz to 6 GHz)", July 2016
- IEC 62209-2, "Procedure to determine the Specific Absorption Rate (SAR) for wireless communication devices used in close proximity to the human body (frequency range of 30 MHz to 6 GHz)", March 2010
- KDB 865664, "SAR Measurement Requirements for 100 MHz to 6 GHz"

### Additional Documentation:

- DASY4/5 System Handbook

### Methods Applied and Interpretation of Parameters:

- Measurement Conditions:** Further details are available from the Validation Report at the end of the certificate. All figures stated in the certificate are valid at the frequency indicated.
- Antenna Parameters with TSL:** The dipole is mounted with the spacer to position its feed point exactly below the center marking of the flat phantom section, with the arms oriented parallel to the body axis.
- Feed Point Impedance and Return Loss:** These parameters are measured with the dipole positioned under the liquid filled phantom. The impedance stated is transformed from the measurement at the SMA connector to the feed point. The Return Loss ensures low reflected power. No uncertainty required.
- Electrical Delay:** One-way delay between the SMA connector and the antenna feed point. No uncertainty required.
- SAR measured:** SAR measured at the stated antenna input power.
- SAR normalized:** SAR as measured, normalized to an input power of 1 W at the antenna connector.
- SAR for nominal TSL parameters:** The measured TSL parameters are used to calculate the nominal SAR result.

The reported uncertainty of measurement is stated as the standard uncertainty of measurement multiplied by the coverage factor  $k=2$ , which for a normal distribution corresponds to a coverage probability of approximately 95%.

**Measurement Conditions**

DASY system configuration, as far as not given on page 1.

DASY Version	DASY5	V52.10.1
Extrapolation	Advanced Extrapolation	
Phantom	Modular Flat Phantom	
Distance Dipole Center - TSL	10 mm	with Spacer
Zoom Scan Resolution	dx, dy, dz = 5 mm	
Frequency	2450 MHz $\pm$ 1 MHz	

**Head TSL parameters**

The following parameters and calculations were applied.

	Temperature	Permittivity	Conductivity
Nominal Head TSL parameters	22.0 °C	39.2	1.80 mho/m
Measured Head TSL parameters	(22.0 $\pm$ 0.2) °C	37.8 $\pm$ 6 %	1.85 mho/m $\pm$ 6 %
Head TSL temperature change during test	< 0.5 °C	----	----

**SAR result with Head TSL**

SAR averaged over 1 cm <sup>3</sup> (1 g) of Head TSL	Condition	
SAR measured	250 mW input power	13.1 W/kg
SAR for nominal Head TSL parameters	normalized to 1W	51.3 W/kg $\pm$ 17.0 % (k=2)

SAR averaged over 10 cm <sup>3</sup> (10 g) of Head TSL	condition	
SAR measured	250 mW input power	6.10 W/kg
SAR for nominal Head TSL parameters	normalized to 1W	24.1 W/kg $\pm$ 16.5 % (k=2)

**Body TSL parameters**

The following parameters and calculations were applied.

	Temperature	Permittivity	Conductivity
Nominal Body TSL parameters	22.0 °C	52.7	1.95 mho/m
Measured Body TSL parameters	(22.0 $\pm$ 0.2) °C	51.9 $\pm$ 6 %	2.02 mho/m $\pm$ 6 %
Body TSL temperature change during test	< 0.5 °C	----	----

**SAR result with Body TSL**

SAR averaged over 1 cm <sup>3</sup> (1 g) of Body TSL	Condition	
SAR measured	250 mW input power	12.9 W/kg
SAR for nominal Body TSL parameters	normalized to 1W	50.6 W/kg $\pm$ 17.0 % (k=2)

SAR averaged over 10 cm <sup>3</sup> (10 g) of Body TSL	condition	
SAR measured	250 mW input power	6.03 W/kg
SAR for nominal Body TSL parameters	normalized to 1W	23.8 W/kg $\pm$ 16.5 % (k=2)

**Appendix (Additional assessments outside the scope of SCS 0108)****Antenna Parameters with Head TSL**

Impedance, transformed to feed point	53.8 $\Omega$ + 1.8 $\mu\Omega$
Return Loss	- 27.9 dB

**Antenna Parameters with Body TSL**

Impedance, transformed to feed point	49.2 $\Omega$ + 5.0 $\mu\Omega$
Return Loss	- 25.9 dB

**General Antenna Parameters and Design**

Electrical Delay (one direction)	1.156 ns
----------------------------------	----------

After long term use with 100W radiated power, only a slight warming of the dipole near the feedpoint can be measured.

The dipole is made of standard semirigid coaxial cable. The center conductor of the feeding line is directly connected to the second arm of the dipole. The antenna is therefore short-circuited for DC-signals. On some of the dipoles, small end caps are added to the dipole arms in order to improve matching when loaded according to the position as explained in the "Measurement Conditions" paragraph. The SAR data are not affected by this change. The overall dipole length is still according to the Standard.

No excessive force must be applied to the dipole arms, because they might bend or the soldered connections near the feedpoint may be damaged.

**Additional EUT Data**

Manufactured by	SPEAG
Manufactured on	June 19, 2012

**DASY5 Validation Report for Head TSL**

Date: 24.07.2018

Test Laboratory: SPEAG, Zurich, Switzerland

**DUT: Dipole 2450 MHz; Type: D2450V2; Serial: D2450V2 - SN:895**

Communication System: UID 0 - CW; Frequency: 2450 MHz

Medium parameters used:  $f = 2450$  MHz;  $\sigma = 1.85$  S/m;  $\epsilon_r = 37.8$ ;  $\rho = 1000$  kg/m<sup>3</sup>

Phantom section: Flat Section

Measurement Standard: DASY5 (IEEE/IEC/ANSI C63.19-2011)

DASY52 Configuration:

- Probe: EX3DV4 - SN7349; ConvF(7.88, 7.88, 7.88) @ 2450 MHz; Calibrated: 30.12.2017
- Sensor-Surface: 1.4mm (Mechanical Surface Detection)
- Electronics: DAE4 Sn601; Calibrated: 26.10.2017
- Phantom: Flat Phantom 5.0 (front); Type: QD 000 P50 AA; Serial: 1001
- DASY52 52.10.1(1476); SEMCAD X 14.6.11(7439)

**Dipole Calibration for Head Tissue/Pin=250 mW, d=10mm/Zoom Scan (7x7x7)/Cube 0:**

Measurement grid: dx=5mm, dy=5mm, dz=5mm

Reference Value = 115.0 V/m; Power Drift = 0.04 dB

Peak SAR (extrapolated) = 26.1 W/kg

**SAR(1 g) = 13.1 W/kg; SAR(10 g) = 6.1 W/kg**

Maximum value of SAR (measured) = 21.4 W/kg

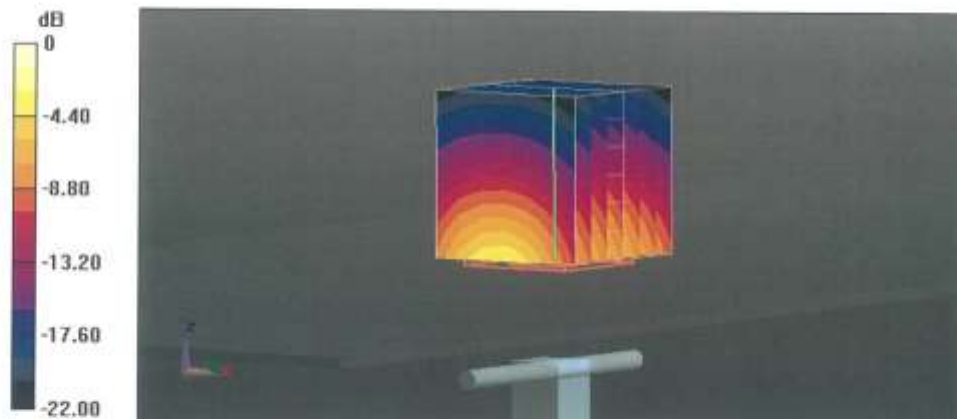

# KCTL Inc.

65, Sinwon-ro, Yeongtong-gu,  
Suwon-si, Gyeonggi-do, 16677, Korea  
TEL: 82-31-285-0894 FAX: 82-505-299-8311  
[www.kctl.co.kr](http://www.kctl.co.kr)

Report No.:  
KR19-SPF0028  
Page (85) of (131)



## Impedance Measurement Plot for Head TSL

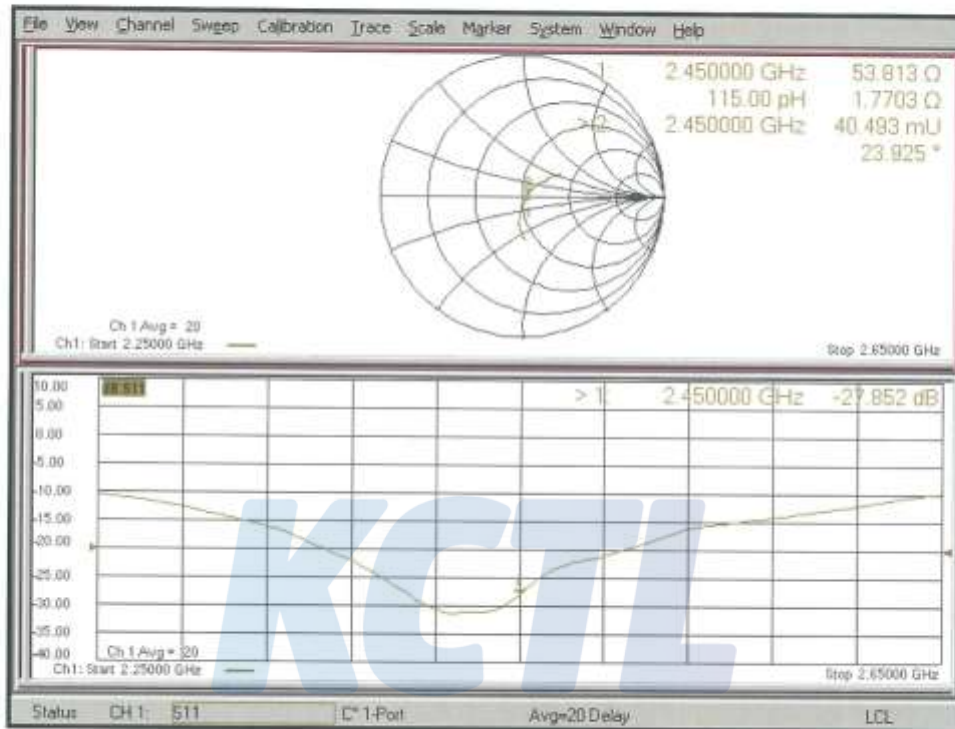

**DASY5 Validation Report for Body TSL**

Date: 24.07.2018

Test Laboratory: SPEAG, Zurich, Switzerland

**DUT: Dipole 2450 MHz; Type: D2450V2; Serial: D2450V2 - SN:895**

Communication System: UID 0 - CW; Frequency: 2450 MHz

Medium parameters used:  $f = 2450$  MHz;  $\sigma = 2.02$  S/m;  $\epsilon_r = 51.9$ ;  $\rho = 1000$  kg/m<sup>3</sup>

Phantom section: Flat Section

Measurement Standard: DASY5 (IEEE/IEC/ANSI C63.19-2011)

DASY52 Configuration:

- Probe: EX3DV4 - SN7349; ConvF(8.01, 8.01, 8.01) @ 2450 MHz; Calibrated: 30.12.2017
- Sensor-Surface: 1.4mm (Mechanical Surface Detection)
- Electronics: DAE4 Sn601; Calibrated: 26.10.2017
- Phantom: Flat Phantom 5.0 (back); Type: QD 000 P50 AA; Serial: 1002
- DASY52 52.10.1(1476); SEMCAD X 14.6.11(7439)

**Dipole Calibration for Body Tissue/Pin=250 mW, d=10mm/Zoom Scan (7x7x7)/Cube 0:**

Measurement grid: dx=5mm, dy=5mm, dz=5mm

Reference Value = 108.0 V/m; Power Drift = -0.04 dB

Peak SAR (extrapolated) = 25.1 W/kg

**SAR(1 g) = 12.9 W/kg; SAR(10 g) = 6.03 W/kg**

Maximum value of SAR (measured) = 20.9 W/kg

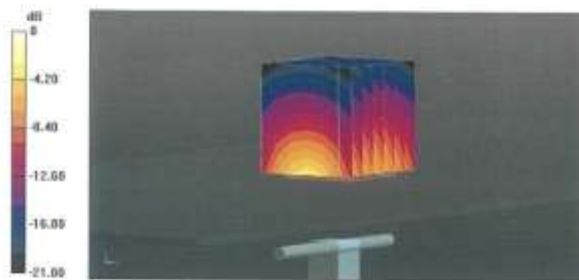

0 dB = 20.9 W/kg = 13.20 dBW/kg

# KCTL Inc.

65, Sinwon-ro, Yeongtong-gu,  
Suwon-si, Gyeonggi-do, 16677, Korea  
TEL: 82-31-285-0894 FAX: 82-505-299-8311  
[www.kctl.co.kr](http://www.kctl.co.kr)

Report No.:  
KR19-SPF0028  
Page (87) of (131)



## Impedance Measurement Plot for Body TSL

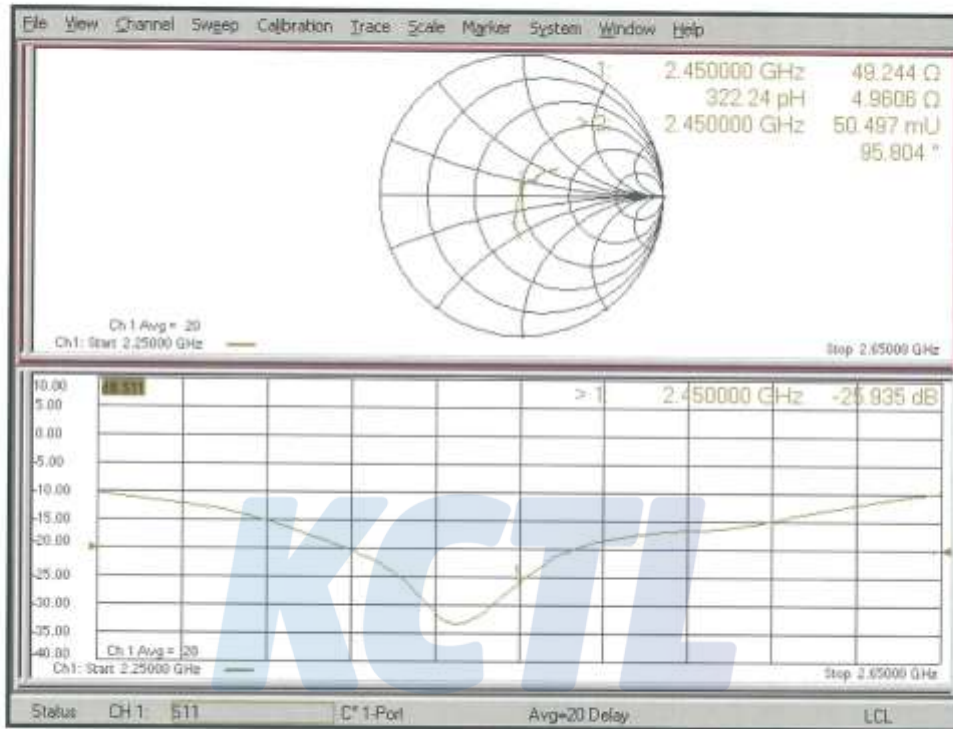

# KCTL Inc.

65, Sinwon-ro, Yeongtong-gu,  
Suwon-si, Gyeonggi-do, 16677, Korea  
TEL: 82-31-285-0894 FAX: 82-505-299-8311  
[www.kctl.co.kr](http://www.kctl.co.kr)

Report No.:  
KR19-SPF0028  
Page (88) of (131)

# KCTL

## Appendix A.3 Dipole Calibration certificate (D5GHzV2 1134)

Calibration Laboratory of  
Schmid & Partner  
Engineering AG  
Zeughausstrasse 43, 8004 Zurich, Switzerland



S Schweizerischer Kalibrierdienst  
C Service suisse d'étalonnage  
S Servizio svizzero di taratura  
S Swiss Calibration Service

Accredited by the Swiss Accreditation Service (SAS)  
The Swiss Accreditation Service is one of the signatories to the EA  
Multilateral Agreement for the recognition of calibration certificates

Accreditation No.: SCS 0108

Client **KCTL (Dymstec)**

Certificate No: **D5GHzV2-1134\_May19**

### CALIBRATION CERTIFICATE

Object **D5GHzV2 - SN:1134**

Calibration procedure(s) **QA CAL-22.v4  
Calibration Procedure for SAR Validation Sources between 3-6 GHz**

Calibration date: **May 23, 2019**

This calibration certificate documents the traceability to national standards, which realize the physical units of measurements (SI).  
The measurements and the uncertainties with confidence probability are given on the following pages and are part of the certificate.

All calibrations have been conducted in the closed laboratory facility: environment temperature  $(22 \pm 3)^\circ\text{C}$  and humidity  $< 70\%$ .

Calibration Equipment used (M&TE critical for calibration)

Primary Standards	ID #	Cal Date (Certificate No.)	Scheduled Calibration
Power meter NRP	SN: 104778	03-Apr-19 (No. 217-02892/02893)	Apr-20
Power sensor NRP-Z91	SN: 103244	03-Apr-19 (No. 217-02892)	Apr-20
Power sensor NRP-Z91	SN: 103245	03-Apr-19 (No. 217-02893)	Apr-20
Reference 20 dB Attenuator	SN: 5058 (20k)	04-Apr-19 (No. 217-02894)	Apr-20
Type-N mismatch combination	SN: 5047.2 / 06327	04-Apr-19 (No. 217-02895)	Apr-20
Reference Probe EX3DV4	SN: 3503	25-Mar-19 (No. EX3-3503_Mar19)	Mar-20
DAE4	SN: 601	30-Apr-19 (No. DAE4-601_Apr19)	Apr-20
Secondary Standards	ID #	Check Date (in house)	Scheduled Check
Power meter E4419B	SN: GB39512475	30-Oct-14 (in house check Feb-19)	In house check: Oct-20
Power sensor HP B481A	SN: US37292783	07-Oct-15 (in house check Oct-18)	In house check: Oct-20
Power sensor HP B481A	SN: MY41092317	07-Oct-15 (in house check Oct-18)	In house check: Oct-20
RF generator R&S SMT-06	SN: 100972	15-Jun-15 (in house check Oct-18)	In house check: Oct-20
Network Analyzer Agilent E8358A	SN: US41080477	31-Mar-14 (in house check Oct-18)	In house check: Oct-19

Calibrated by: **Claudio Leubler** Laboratory Technician

Signature

Approved by: **Katja Pokovic** Technical Manager

Issued: May 27, 2019

This calibration certificate shall not be reproduced except in full without written approval of the laboratory.

Certificate No: D5GHzV2-1134\_May19

Page 1 of 16



# KCTL Inc.

65, Sinwon-ro, Yeongtong-gu,  
Suwon-si, Gyeonggi-do, 16677, Korea  
TEL: 82-31-285-0894 FAX: 82-505-299-8311  
[www.kctl.co.kr](http://www.kctl.co.kr)

Report No.:  
KR19-SPF0028  
Page (89) of (131)

# KCTL

**Calibration Laboratory of  
Schmid & Partner  
Engineering AG**  
Zeughausstrasse 43, 8004 Zurich, Switzerland



**S** Schweizerischer Kalibrierdienst  
**C** Service suisse d'étalonnage  
**S** Servizio svizzero di taratura  
**S** Swiss Calibration Service

Accredited by the Swiss Accreditation Service (SAS)  
The Swiss Accreditation Service is one of the signatories to the EA  
Multilateral Agreement for the recognition of calibration certificates

Accreditation No.: **SCS 0108**

### Glossary:

TSL tissue simulating liquid  
ConvF sensitivity in TSL / NORM x,y,z  
N/A not applicable or not measured

### Calibration is Performed According to the Following Standards:

- IEEE Std 1528-2013, "IEEE Recommended Practice for Determining the Peak Spatial-Averaged Specific Absorption Rate (SAR) in the Human Head from Wireless Communications Devices: Measurement Techniques", June 2013
- IEC 62209-1, "Measurement procedure for the assessment of Specific Absorption Rate (SAR) from hand-held and body-mounted devices used next to the ear (frequency range of 300 MHz to 6 GHz)", July 2016
- IEC 62209-2, "Procedure to determine the Specific Absorption Rate (SAR) for wireless communication devices used in close proximity to the human body (frequency range of 30 MHz to 6 GHz)", March 2010
- KDB 865664, "SAR Measurement Requirements for 100 MHz to 6 GHz"

### Additional Documentation:

- DASY4/5 System Handbook

### Methods Applied and Interpretation of Parameters:

- Measurement Conditions:** Further details are available from the Validation Report at the end of the certificate. All figures stated in the certificate are valid at the frequency indicated.
- Antenna Parameters with TSL:** The dipole is mounted with the spacer to position its feed point exactly below the center marking of the flat phantom section, with the arms oriented parallel to the body axis.
- Feed Point Impedance and Return Loss:** These parameters are measured with the dipole positioned under the liquid filled phantom. The impedance stated is transformed from the measurement at the SMA connector to the feed point. The Return Loss ensures low reflected power. No uncertainty required.
- Electrical Delay:** One-way delay between the SMA connector and the antenna feed point. No uncertainty required.
- SAR measured:** SAR measured at the stated antenna input power.
- SAR normalized:** SAR as measured, normalized to an input power of 1 W at the antenna connector.
- SAR for nominal TSL parameters:** The measured TSL parameters are used to calculate the nominal SAR result.

The reported uncertainty of measurement is stated as the standard uncertainty of measurement multiplied by the coverage factor  $k=2$ , which for a normal distribution corresponds to a coverage probability of approximately 95%.

# KCTL Inc.

65, Sinwon-ro, Yeongtong-gu,  
Suwon-si, Gyeonggi-do, 16677, Korea  
TEL: 82-31-285-0894 FAX: 82-505-299-8311  
[www.kctl.co.kr](http://www.kctl.co.kr)

Report No.:  
KR19-SPF0028  
Page (90) of (131)



## Measurement Conditions

DASY system configuration, as far as not given on page 1.

DASY Version	DASY5	V52.10.2
Extrapolation	Advanced Extrapolation	
Phantom	Modular Flat Phantom V5.0	
Distance Dipole Center - TSL	10 mm	with Spacer
Zoom Scan Resolution	dx, dy = 4.0 mm, dz = 1.4 mm	Graded Ratio = 1.4 (Z direction)
Frequency	5200 MHz ± 1 MHz 5300 MHz ± 1 MHz 5500 MHz ± 1 MHz 5600 MHz ± 1 MHz 5800 MHz ± 1 MHz	

## Head TSL parameters at 5200 MHz

The following parameters and calculations were applied.

	Temperature	Permittivity	Conductivity
Nominal Head TSL parameters	22.0 °C	36.0	4.66 mho/m
Measured Head TSL parameters	(22.0 ± 0.2) °C	35.4 ± 6 %	4.47 mho/m ± 6 %
Head TSL temperature change during test	< 0.5 °C	---	---

## SAR result with Head TSL at 5200 MHz

SAR averaged over 1 cm <sup>3</sup> (1 g) of Head TSL	Condition	
SAR measured	100 mW input power	7.94 W/kg
SAR for nominal Head TSL parameters	normalized to 1W	79.0 W/kg ± 19.9 % (k=2)
SAR averaged over 10 cm <sup>3</sup> (10 g) of Head TSL	condition	
SAR measured	100 mW input power	2.27 W/kg
SAR for nominal Head TSL parameters	normalized to 1W	22.6 W/kg ± 19.5 % (k=2)

# KCTL Inc.

65, Sinwon-ro, Yeongtong-gu,  
Suwon-si, Gyeonggi-do, 16677, Korea  
TEL: 82-31-285-0894 FAX: 82-505-299-8311  
[www.kctl.co.kr](http://www.kctl.co.kr)

Report No.:  
KR19-SPF0028  
Page (91) of (131)



## Head TSL parameters at 5300 MHz

The following parameters and calculations were applied.

	Temperature	Permittivity	Conductivity
Nominal Head TSL parameters	22.0 °C	35.9	4.76 mho/m
Measured Head TSL parameters	(22.0 ± 0.2) °C	35.3 ± 6 %	4.57 mho/m ± 6 %
Head TSL temperature change during test	< 0.5 °C	---	---

## SAR result with Head TSL at 5300 MHz

SAR averaged over 1 cm <sup>3</sup> (1 g) of Head TSL	Condition	
SAR measured	100 mW input power	8.27 W/kg
SAR for nominal Head TSL parameters	normalized to 1W	<b>82.3 W/kg ± 19.9 % (k=2)</b>

SAR averaged over 10 cm <sup>3</sup> (10 g) of Head TSL	condition	
SAR measured	100 mW input power	2.36 W/kg
SAR for nominal Head TSL parameters	normalized to 1W	<b>23.4 W/kg ± 19.5 % (k=2)</b>

## Head TSL parameters at 5500 MHz

The following parameters and calculations were applied.

	Temperature	Permittivity	Conductivity
Nominal Head TSL parameters	22.0 °C	35.6	4.96 mho/m
Measured Head TSL parameters	(22.0 ± 0.2) °C	35.0 ± 6 %	4.77 mho/m ± 6 %
Head TSL temperature change during test	< 0.5 °C	---	---

## SAR result with Head TSL at 5500 MHz

SAR averaged over 1 cm <sup>3</sup> (1 g) of Head TSL	Condition	
SAR measured	100 mW input power	8.55 W/kg
SAR for nominal Head TSL parameters	normalized to 1W	<b>85.1 W/kg ± 19.9 % (k=2)</b>

SAR averaged over 10 cm <sup>3</sup> (10 g) of Head TSL	condition	
SAR measured	100 mW input power	2.42 W/kg
SAR for nominal Head TSL parameters	normalized to 1W	<b>24.0 W/kg ± 19.5 % (k=2)</b>

# KCTL Inc.

65, Sinwon-ro, Yeongtong-gu,  
Suwon-si, Gyeonggi-do, 16677, Korea  
TEL: 82-31-285-0894 FAX: 82-505-299-8311  
[www.kctl.co.kr](http://www.kctl.co.kr)

Report No.:  
KR19-SPF0028  
Page (92) of (131)



## Head TSL parameters at 5600 MHz

The following parameters and calculations were applied.

	Temperature	Permittivity	Conductivity
Nominal Head TSL parameters	22.0 °C	35.5	5.07 mho/m
Measured Head TSL parameters	(22.0 ± 0.2) °C	34.9 ± 6 %	4.87 mho/m ± 6 %
Head TSL temperature change during test	< 0.5 °C	---	---

## SAR result with Head TSL at 5600 MHz

SAR averaged over 1 cm <sup>3</sup> (1 g) of Head TSL	Condition	
SAR measured	100 mW input power	8.57 W/kg
SAR for nominal Head TSL parameters	normalized to 1W	<b>85.3 W/kg ± 19.9 % (k=2)</b>

SAR averaged over 10 cm <sup>3</sup> (10 g) of Head TSL	condition	
SAR measured	100 mW input power	2.44 W/kg
SAR for nominal Head TSL parameters	normalized to 1W	<b>24.2 W/kg ± 19.5 % (k=2)</b>

## Head TSL parameters at 5800 MHz

The following parameters and calculations were applied.

	Temperature	Permittivity	Conductivity
Nominal Head TSL parameters	22.0 °C	35.3	5.27 mho/m
Measured Head TSL parameters	(22.0 ± 0.2) °C	34.6 ± 6 %	5.07 mho/m ± 6 %
Head TSL temperature change during test	< 0.5 °C	---	---

## SAR result with Head TSL at 5800 MHz

SAR averaged over 1 cm <sup>3</sup> (1 g) of Head TSL	Condition	
SAR measured	100 mW input power	7.97 W/kg
SAR for nominal Head TSL parameters	normalized to 1W	<b>79.2 W/kg ± 19.9 % (k=2)</b>

SAR averaged over 10 cm <sup>3</sup> (10 g) of Head TSL	condition	
SAR measured	100 mW input power	2.26 W/kg
SAR for nominal Head TSL parameters	normalized to 1W	<b>22.5 W/kg ± 19.5 % (k=2)</b>

# KCTL Inc.

65, Sinwon-ro, Yeongtong-gu,  
Suwon-si, Gyeonggi-do, 16677, Korea  
TEL: 82-31-285-0894 FAX: 82-505-299-8311  
[www.kctl.co.kr](http://www.kctl.co.kr)

Report No.:  
KR19-SPF0028  
Page (93) of (131)



## Body TSL parameters at 5200 MHz

The following parameters and calculations were applied.

	Temperature	Permittivity	Conductivity
Nominal Body TSL parameters	22.0 °C	49.0	5.30 mho/m
Measured Body TSL parameters	(22.0 ± 0.2) °C	47.2 ± 6 %	5.45 mho/m ± 6 %
Body TSL temperature change during test	< 0.5 °C	---	---

## SAR result with Body TSL at 5200 MHz

SAR averaged over 1 cm <sup>3</sup> (1 g) of Body TSL	Condition	
SAR measured	100 mW input power	7.55 W/kg
SAR for nominal Body TSL parameters	normalized to 1W	75.0 W/kg ± 19.9 % (k=2)

SAR averaged over 10 cm <sup>3</sup> (10 g) of Body TSL	condition	
SAR measured	100 mW input power	2.11 W/kg
SAR for nominal Body TSL parameters	normalized to 1W	20.9 W/kg ± 19.5 % (k=2)

## Body TSL parameters at 5300 MHz

The following parameters and calculations were applied.

	Temperature	Permittivity	Conductivity
Nominal Body TSL parameters	22.0 °C	48.9	5.42 mho/m
Measured Body TSL parameters	(22.0 ± 0.2) °C	47.0 ± 6 %	5.58 mho/m ± 6 %
Body TSL temperature change during test	< 0.5 °C	---	---

## SAR result with Body TSL at 5300 MHz

SAR averaged over 1 cm <sup>3</sup> (1 g) of Body TSL	Condition	
SAR measured	100 mW input power	7.55 W/kg
SAR for nominal Body TSL parameters	normalized to 1W	75.0 W/kg ± 19.9 % (k=2)

SAR averaged over 10 cm <sup>3</sup> (10 g) of Body TSL	condition	
SAR measured	100 mW input power	2.10 W/kg
SAR for nominal Body TSL parameters	normalized to 1W	20.8 W/kg ± 19.5 % (k=2)

# KCTL Inc.

65, Sinwon-ro, Yeongtong-gu,  
Suwon-si, Gyeonggi-do, 16677, Korea  
TEL: 82-31-285-0894 FAX: 82-505-299-8311  
[www.kctl.co.kr](http://www.kctl.co.kr)

Report No.:  
KR19-SPF0028  
Page (94) of (131)



## Body TSL parameters at 5500 MHz

The following parameters and calculations were applied.

	Temperature	Permittivity	Conductivity
Nominal Body TSL parameters	22.0 °C	48.6	5.65 mho/m
Measured Body TSL parameters	(22.0 ± 0.2) °C	48.6 ± 6 %	5.85 mho/m ± 6 %
Body TSL temperature change during test	< 0.5 °C	----	----

## SAR result with Body TSL at 5500 MHz

SAR averaged over 1 cm <sup>3</sup> (1 g) of Body TSL	Condition	
SAR measured	100 mW input power	7.90 W/kg
SAR for nominal Body TSL parameters	normalized to 1W	<b>78.4 W/kg ± 19.9 % (k=2)</b>

SAR averaged over 10 cm <sup>3</sup> (10 g) of Body TSL	condition	
SAR measured	100 mW input power	2.18 W/kg
SAR for nominal Body TSL parameters	normalized to 1W	<b>21.6 W/kg ± 19.5 % (k=2)</b>

## Body TSL parameters at 5600 MHz

The following parameters and calculations were applied.

	Temperature	Permittivity	Conductivity
Nominal Body TSL parameters	22.0 °C	48.5	5.77 mho/m
Measured Body TSL parameters	(22.0 ± 0.2) °C	48.5 ± 6 %	5.99 mho/m ± 6 %
Body TSL temperature change during test	< 0.5 °C	----	----

## SAR result with Body TSL at 5600 MHz

SAR averaged over 1 cm <sup>3</sup> (1 g) of Body TSL	Condition	
SAR measured	100 mW input power	8.02 W/kg
SAR for nominal Body TSL parameters	normalized to 1W	<b>79.6 W/kg ± 19.9 % (k=2)</b>

SAR averaged over 10 cm <sup>3</sup> (10 g) of Body TSL	condition	
SAR measured	100 mW input power	2.23 W/kg
SAR for nominal Body TSL parameters	normalized to 1W	<b>22.1 W/kg ± 19.5 % (k=2)</b>

**KCTL Inc.**

65, Sinwon-ro, Yeongtong-gu,  
Suwon-si, Gyeonggi-do, 16677, Korea  
TEL: 82-31-285-0894 FAX: 82-505-299-8311  
[www.kctl.co.kr](http://www.kctl.co.kr)

Report No.:  
KR19-SPF0028  
Page (95) of (131)

**Body TSL parameters at 5800 MHz**

The following parameters and calculations were applied.

	Temperature	Permittivity	Conductivity
Nominal Body TSL parameters	22.0 °C	48.2	6.00 mho/m
Measured Body TSL parameters	(22.0 ± 0.2) °C	46.1 ± 6 %	6.27 mho/m ± 6 %
Body TSL temperature change during test	< 0.5 °C	---	---

**SAR result with Body TSL at 5800 MHz**

SAR averaged over 1 cm <sup>3</sup> (1 g) of Body TSL	Condition	
SAR measured	100 mW input power	7.44 W/kg
SAR for nominal Body TSL parameters	normalized to 1W	<b>73.9 W/kg ± 19.9 % (k=2)</b>

SAR averaged over 10 cm <sup>3</sup> (10 g) of Body TSL	condition	
SAR measured	100 mW input power	2.08 W/kg
SAR for nominal Body TSL parameters	normalized to 1W	<b>20.4 W/kg ± 19.5 % (k=2)</b>



**Appendix (Additional assessments outside the scope of SCS 0108)****Antenna Parameters with Head TSL at 5200 MHz**

Impedance, transformed to feed point	48.0 $\Omega$ - 9.5 j $\Omega$
Return Loss	- 20.2 dB

**Antenna Parameters with Head TSL at 5300 MHz**

Impedance, transformed to feed point	48.8 $\Omega$ - 6.5 j $\Omega$
Return Loss	- 23.5 dB

**Antenna Parameters with Head TSL at 5500 MHz**

Impedance, transformed to feed point	50.1 $\Omega$ - 4.1 j $\Omega$
Return Loss	- 27.8 dB

**Antenna Parameters with Head TSL at 5600 MHz**

Impedance, transformed to feed point	54.1 $\Omega$ - 2.8 j $\Omega$
Return Loss	- 26.5 dB

**Antenna Parameters with Head TSL at 5800 MHz**

Impedance, transformed to feed point	55.2 $\Omega$ - 4.0 j $\Omega$
Return Loss	- 24.1 dB

**Antenna Parameters with Body TSL at 5200 MHz**

Impedance, transformed to feed point	49.7 $\Omega$ - 7.9 j $\Omega$
Return Loss	- 22.0 dB

**Antenna Parameters with Body TSL at 5300 MHz**

Impedance, transformed to feed point	49.5 $\Omega$ - 5.3 j $\Omega$
Return Loss	- 25.5 dB

**Antenna Parameters with Body TSL at 5500 MHz**

Impedance, transformed to feed point	52.1 $\Omega$ - 2.6 j $\Omega$
Return Loss	- 29.8 dB

**Antenna Parameters with Body TSL at 5600 MHz**

Impedance, transformed to feed point	55.8 $\Omega$ - 1.7 j $\Omega$
Return Loss	- 25.1 dB



## KCTL Inc.

65, Sinwon-ro, Yeongtong-gu,  
Suwon-si, Gyeonggi-do, 16677, Korea  
TEL: 82-31-285-0894 FAX: 82-505-299-8311  
[www.kctl.co.kr](http://www.kctl.co.kr)

Report No.:  
KR19-SPF0028  
Page (97) of (131)

# KCTL

### Antenna Parameters with Body TSL at 5800 MHz

Impedance, transformed to feed point	55.5 $\Omega$ - 3.2 j $\Omega$
Return Loss	- 24.4 dB

### General Antenna Parameters and Design

Electrical Delay (one direction)	1,203 ns
----------------------------------	----------

After long term use with 100W radiated power, only a slight warming of the dipole near the feedpoint can be measured.

The dipole is made of standard semirigid coaxial cable. The center conductor of the feeding line is directly connected to the second arm of the dipole. The antenna is therefore short-circuited for DC-signals. On some of the dipoles, small end caps are added to the dipole arms in order to improve matching when loaded according to the position as explained in the "Measurement Conditions" paragraph. The SAR data are not affected by this change. The overall dipole length is still according to the Standard.

No excessive force must be applied to the dipole arms, because they might bend or the soldered connections near the feedpoint may be damaged.

### Additional EUT Data

Manufactured by	SPEAG
-----------------	-------

# KCTL

**DASY5 Validation Report for Head TSL**

Date: 22.05.2019

Test Laboratory: SPEAG, Zurich, Switzerland

**DUT: Dipole D5GHzV2; Type: D5GHzV2; Serial: D5GHzV2 - SN:1134**

Communication System: UID 0 - CW; Frequency: 5200 MHz, Frequency: 5300 MHz,  
Frequency: 5500 MHz, Frequency: 5600 MHz, Frequency: 5800 MHz  
Medium parameters used:  $f = 5200$  MHz;  $\sigma = 4.47$  S/m;  $\epsilon_r = 35.4$ ;  $\rho = 1000$  kg/m<sup>3</sup>,  
Medium parameters used:  $f = 5300$  MHz;  $\sigma = 4.57$  S/m;  $\epsilon_r = 35.3$ ;  $\rho = 1000$  kg/m<sup>3</sup>,  
Medium parameters used:  $f = 5500$  MHz;  $\sigma = 4.77$  S/m;  $\epsilon_r = 35$ ;  $\rho = 1000$  kg/m<sup>3</sup>,  
Medium parameters used:  $f = 5600$  MHz;  $\sigma = 4.87$  S/m;  $\epsilon_r = 34.9$ ;  $\rho = 1000$  kg/m<sup>3</sup>,  
Medium parameters used:  $f = 5800$  MHz;  $\sigma = 5.07$  S/m;  $\epsilon_r = 34.6$ ;  $\rho = 1000$  kg/m<sup>3</sup>  
Phantom section: Flat Section  
Measurement Standard: DASY5 (IEEE/IEC/ANSI C63.19-2011)

DASY52 Configuration:

- Probe: EX3DV4 - SN3503; ConvF(5.64, 5.64, 5.64) @ 5200 MHz,  
ConvF(5.39, 5.39, 5.39) @ 5300 MHz, ConvF(5.1, 5.1, 5.1) @ 5500 MHz,  
ConvF(4.95, 4.95, 4.95) @ 5600 MHz, ConvF(4.96, 4.96, 4.96) @ 5800 MHz; Calibrated: 25.03.2019
- Sensor-Surface: 1.4mm (Mechanical Surface Detection)
- Electronics: DAE4 Sn601; Calibrated: 30.04.2019
- Phantom: Flat Phantom 5.0 (front); Type: QD 000 P50 AA; Serial: 1001
- DASY52 52.10.2(1495); SEMCAD X 14.6.12(7450)

**Dipole Calibration for Head Tissue/Pin=100mW, dist=10mm, f=5200 MHz/Zoom Scan,****dist=1.4mm (8x8x7)/Cube 0:** Measurement grid: dx=4mm, dy=4mm, dz=1.4mm

Reference Value = 76.08 V/m; Power Drift = 0.06 dB

Peak SAR (extrapolated) = 28.5 W/kg

**SAR(1 g) = 7.94 W/kg; SAR(10 g) = 2.27 W/kg**

Maximum value of SAR (measured) = 18.2 W/kg

**Dipole Calibration for Head Tissue/Pin=100mW, dist=10mm, f=5300 MHz/Zoom Scan,****dist=1.4mm (8x8x7)/Cube 0:** Measurement grid: dx=4mm, dy=4mm, dz=1.4mm

Reference Value = 77.28 V/m; Power Drift = 0.03 dB

Peak SAR (extrapolated) = 29.7 W/kg

**SAR(1 g) = 8.27 W/kg; SAR(10 g) = 2.36 W/kg**

Maximum value of SAR (measured) = 19.2 W/kg

**Dipole Calibration for Head Tissue/Pin=100mW, dist=10mm, f=5500 MHz/Zoom Scan,****dist=1.4mm (8x8x7)/Cube 0:** Measurement grid: dx=4mm, dy=4mm, dz=1.4mm

Reference Value = 76.91 V/m; Power Drift = 0.04 dB

Peak SAR (extrapolated) = 33.2 W/kg

**SAR(1 g) = 8.55 W/kg; SAR(10 g) = 2.42 W/kg**

Maximum value of SAR (measured) = 20.1 W/kg

**Dipole Calibration for Head Tissue/Pin=100mW, dist=10mm, f=5600 MHz/Zoom Scan,**  
**dist=1.4mm (8x8x7)/Cube 0:** Measurement grid: dx=4mm, dy=4mm, dz=1.4mm  
Reference Value = 77.68 V/m; Power Drift = 0.02 dB  
Peak SAR (extrapolated) = 32.2 W/kg  
**SAR(1 g) = 8.57 W/kg; SAR(10 g) = 2.44 W/kg**  
Maximum value of SAR (measured) = 20.2 W/kg

**Dipole Calibration for Head Tissue/Pin=100mW, dist=10mm, f=5800 MHz/Zoom Scan,**  
**dist=1.4mm (8x8x7)/Cube 0:** Measurement grid: dx=4mm, dy=4mm, dz=1.4mm  
Reference Value = 74.08 V/m; Power Drift = 0.02 dB  
Peak SAR (extrapolated) = 32.0 W/kg  
**SAR(1 g) = 7.97 W/kg; SAR(10 g) = 2.26 W/kg**  
Maximum value of SAR (measured) = 19.1 W/kg

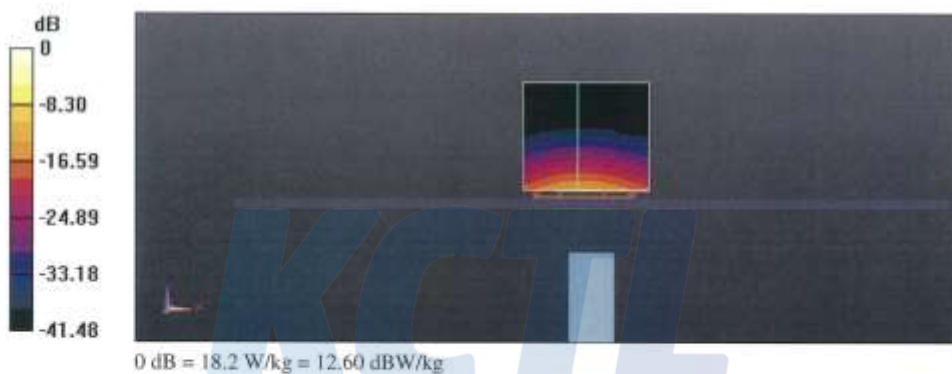

# KCTL Inc.

65, Sinwon-ro, Yeongtong-gu,  
Suwon-si, Gyeonggi-do, 16677, Korea  
TEL: 82-31-285-0894 FAX: 82-505-299-8311  
[www.kctl.co.kr](http://www.kctl.co.kr)

Report No.:  
KR19-SPF0028  
Page (100) of (131)



## Impedance Measurement Plot for Head TSL

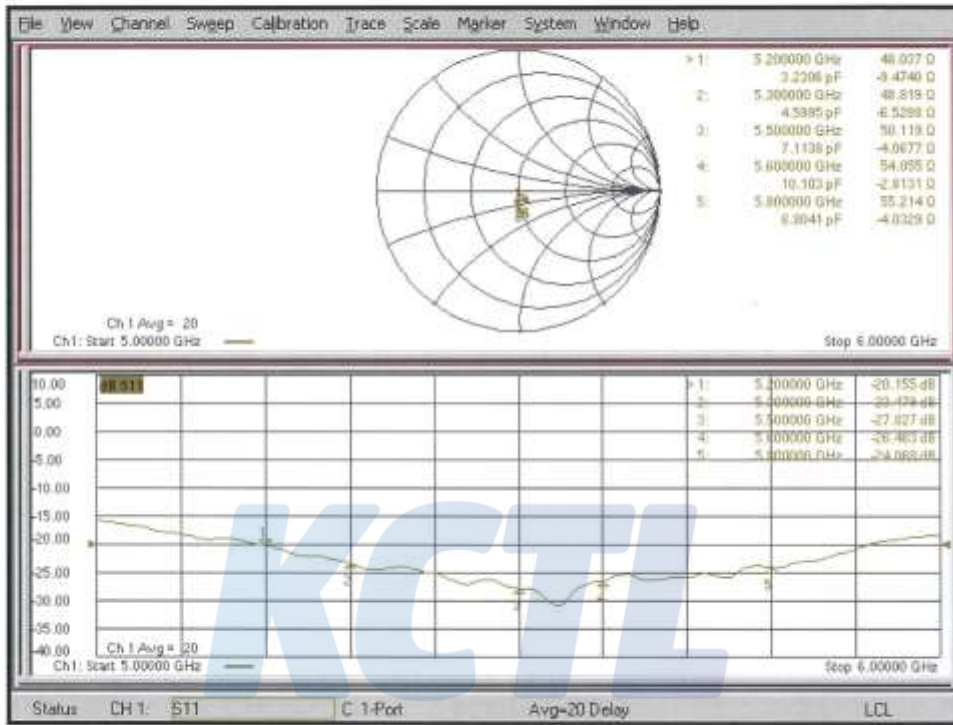

**DASY5 Validation Report for Body TSL**

Date: 23.05.2019

Test Laboratory: SPEAG, Zurich, Switzerland

**DUT: Dipole D5GHzV2; Type: D5GHzV2; Serial: D5GHzV2 - SN:1134**Communication System: UID 0 - CW; Frequency: 5200 MHz, Frequency: 5300 MHz,  
Frequency: 5500 MHz, Frequency: 5600 MHz, Frequency: 5800 MHzMedium parameters used:  $f = 5200$  MHz;  $\sigma = 5.45$  S/m;  $\epsilon_r = 47.2$ ;  $\rho = 1000$  kg/m<sup>3</sup>,Medium parameters used:  $f = 5300$  MHz;  $\sigma = 5.58$  S/m;  $\epsilon_r = 47$ ;  $\rho = 1000$  kg/m<sup>3</sup>,Medium parameters used:  $f = 5500$  MHz;  $\sigma = 5.85$  S/m;  $\epsilon_r = 46.6$ ;  $\rho = 1000$  kg/m<sup>3</sup>,Medium parameters used:  $f = 5600$  MHz;  $\sigma = 5.99$  S/m;  $\epsilon_r = 46.5$ ;  $\rho = 1000$  kg/m<sup>3</sup>,Medium parameters used:  $f = 5800$  MHz;  $\sigma = 6.27$  S/m;  $\epsilon_r = 46.1$ ;  $\rho = 1000$  kg/m<sup>3</sup>

Phantom section: Flat Section

Measurement Standard: DASY5 (IEEE/IEC/ANSI C63.19-2011)

DASY52 Configuration:

- Probe: EX3DV4 - SN3503; ConvF(5.14, 5.14, 5.14) @ 5200 MHz,  
ConvF(5.25, 5.25, 5.25) @ 5300 MHz, ConvF(4.79, 4.79, 4.79) @ 5500 MHz,  
ConvF(4.74, 4.74, 4.74) @ 5600 MHz, ConvF(4.62, 4.62, 4.62) @ 5800 MHz; Calibrated: 25.03.2019
- Sensor-Surface: 1.4mm (Mechanical Surface Detection)
- Electronics: DAE4 Sn601; Calibrated: 30.04.2019
- Phantom: Flat Phantom 5.0 (back); Type: QD 000 P50 AA; Serial: 1002
- DASY52 52.10.2(1495); SEMCAD X 14.6.12(7450)

**Dipole Calibration for Body Tissue/Pin=100mW, dist=10mm, f=5200 MHz/Zoom Scan,****dist=1.4mm (8x8x7)/Cube 0:** Measurement grid: dx=4mm, dy=4mm, dz=1.4mm

Reference Value = 69.01 V/m; Power Drift = 0.00 dB

Peak SAR (extrapolated) = 28.7 W/kg

**SAR(1 g) = 7.55 W/kg; SAR(10 g) = 2.11 W/kg**

Maximum value of SAR (measured) = 17.5 W/kg

**Dipole Calibration for Body Tissue/Pin=100mW, dist=10mm, f=5300 MHz/Zoom Scan,****dist=1.4mm (8x8x7)/Cube 0:** Measurement grid: dx=4mm, dy=4mm, dz=1.4mm

Reference Value = 67.76 V/m; Power Drift = 0.03 dB

Peak SAR (extrapolated) = 30.0 W/kg

**SAR(1 g) = 7.55 W/kg; SAR(10 g) = 2.1 W/kg**

Maximum value of SAR (measured) = 17.9 W/kg

**Dipole Calibration for Body Tissue/Pin=100mW, dist=10mm, f=5500 MHz/Zoom Scan,****dist=1.4mm (8x8x7)/Cube 0:** Measurement grid: dx=4mm, dy=4mm, dz=1.4mm

Reference Value = 68.53 V/m; Power Drift = -0.00 dB

Peak SAR (extrapolated) = 33.2 W/kg

**SAR(1 g) = 7.9 W/kg; SAR(10 g) = 2.18 W/kg**

Maximum value of SAR (measured) = 19.1 W/kg

# KCTL Inc.

65, Sinwon-ro, Yeongtong-gu,  
Suwon-si, Gyeonggi-do, 16677, Korea  
TEL: 82-31-285-0894 FAX: 82-505-299-8311  
[www.kctl.co.kr](http://www.kctl.co.kr)

Report No.:  
KR19-SPF0028  
Page (102) of (131)

# KCTL

**Dipole Calibration for Body Tissue/Pin=100mW, dist=10mm, f=5600 MHz/Zoom Scan, dist=1.4mm (8x8x7)/Cube 0:** Measurement grid: dx=4mm, dy=4mm, dz=1.4mm  
Reference Value = 68.29 V/m; Power Drift = 0.05 dB  
Peak SAR (extrapolated) = 34.8 W/kg  
SAR(1 g) = 8.02 W/kg; SAR(10 g) = 2.23 W/kg  
Maximum value of SAR (measured) = 19.7 W/kg

**Dipole Calibration for Body Tissue/Pin=100mW, dist=10mm, f=5800 MHz/Zoom Scan, dist=1.4mm (8x8x7)/Cube 0:** Measurement grid: dx=4mm, dy=4mm, dz=1.4mm  
Reference Value = 65.93 V/m; Power Drift = 0.01 dB  
Peak SAR (extrapolated) = 32.8 W/kg  
SAR(1 g) = 7.44 W/kg; SAR(10 g) = 2.06 W/kg  
Maximum value of SAR (measured) = 18.3 W/kg

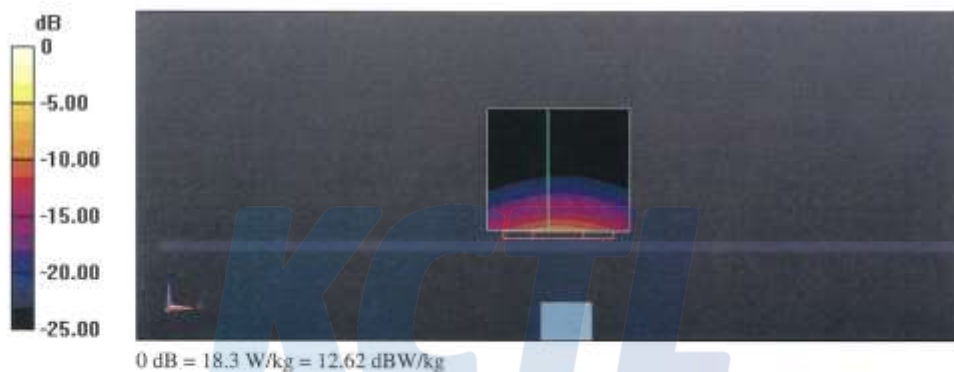

# KCTL Inc.

65, Sinwon-ro, Yeongtong-gu,  
Suwon-si, Gyeonggi-do, 16677, Korea  
TEL: 82-31-285-0894 FAX: 82-505-299-8311  
[www.kctl.co.kr](http://www.kctl.co.kr)

Report No.:  
KR19-SPF0028  
Page (103) of (131)



## Impedance Measurement Plot for Body TSL

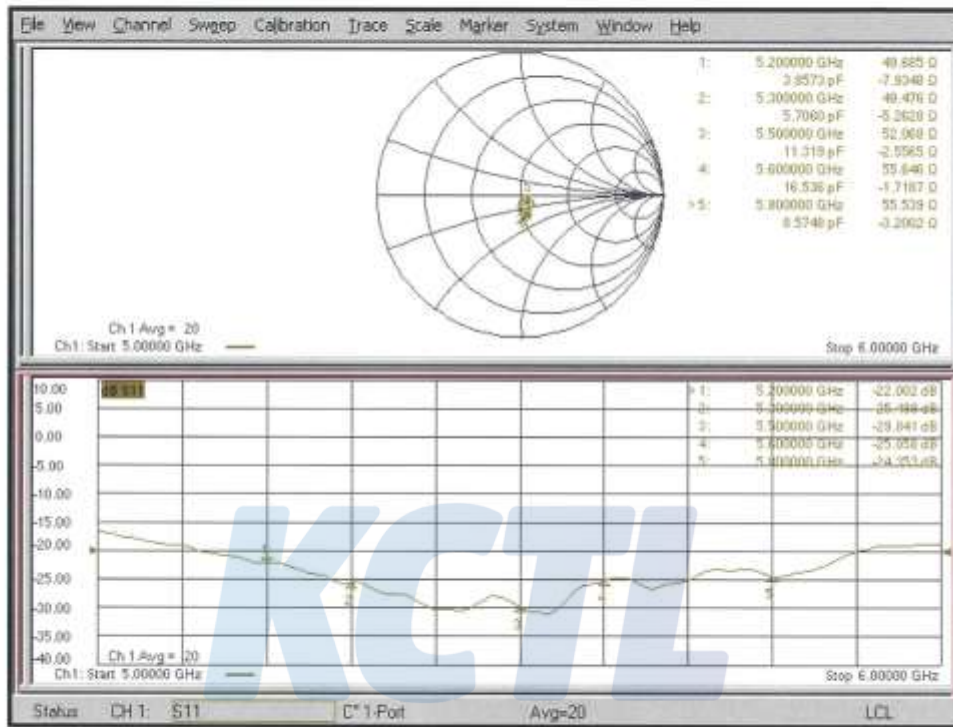

**Appendix A.4 Justification for Extended SAR Dipole Calibrations**

Instead of the typical annual calibration recommended by measurement standards, longer calibration intervals of up to three years may be considered when it is demonstrated that the SAR target, impedance and return loss of a dipole have remain stable according to the following requirements

KDB 865664 D01v01r04 requirements

- a) Return loss: < - 20 dB, within 20 % of previous measurement
- b) Impedance: within 5  $\Omega$  from previous measurement.

**2450 MHz**

Dipole Antenna	Head/Body	Date of Measurement	Return Loss (dB)	$\Delta$ %	Impedance ( $\Omega$ )	$\Delta$ $\Omega$
D2450V2 SN 895	Head	2018.07.24	-27.9	8.3	53.8	1.2
		2019.07.23	-25.6		55.0	

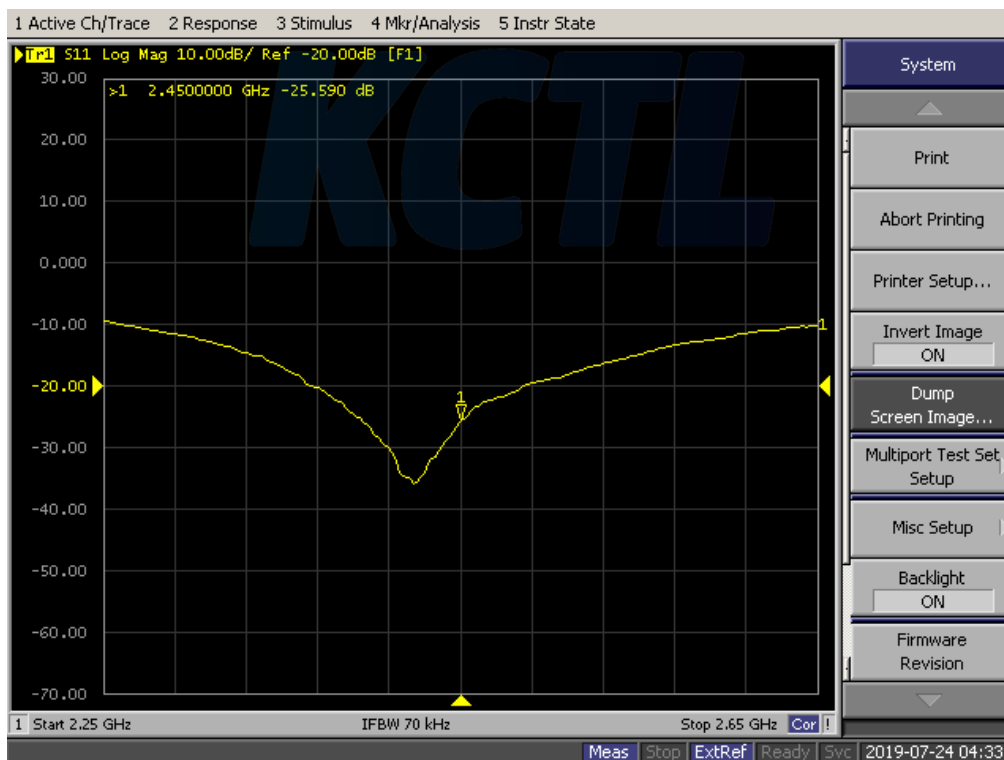



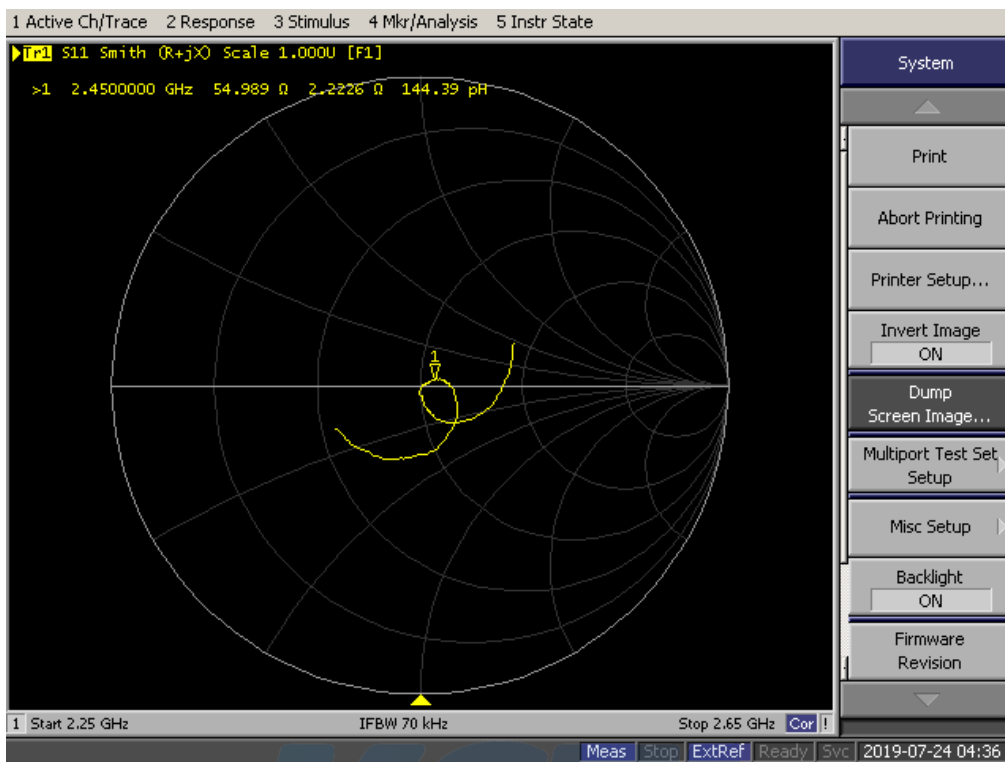

c) Extrapolated peak SAR: within 15% of that reported in the calibration data

**2450 MHz**

Dipole Antenna	Head/Body	Date of Measurement	Extrapolated peak SAR (W/kg)	Δ %
D2450V2 SN 895	Head	2018.07.24	104.4	5.36
		2019.09.04	110.0	

**KCTL Inc.**

65, Sinwon-ro, Yeongtong-gu,  
Suwon-si, Gyeonggi-do, 16677, Korea  
TEL: 82-31-285-0894 FAX: 82-505-299-8311  
[www.kctl.co.kr](http://www.kctl.co.kr)

Report No.:  
KR19-SPF0028  
Page (106) of (131)



## Appendix B. SAR Tissue Specification

The brain mixtures consist of a viscous gel using hydrox-ethyl cellulose(HEC) gelling agent and saline solution. Preservation with a bactericide is added and visual inspection is made to make sure air bubbles are not trapped during the mixing process. The mixture is calibrated to obtain proper dielectric constant (permittivity) and conductivity of the desired tissue.

Frequency (MHz)	750 ~ 835		1 750		1 900		2 450		5 200 ~ 5 800	
Tissue Type	Head	Body	Head	Body	Head	Body	Head	Body	Head	Body
Ingredient	% by weight									
Water	40.29	51.97	53.00	68.00	55.00	70.50	72.00	73.00	65.52	80.00
Salt (NaCl)	1.38	0.93	0.40	0.20	0.35	0.30	0.10	0.10	0	0
Sugar	57.90	47.00	0	0	0	0	0	0	0	0
HEC	0.24	0	0	0	0	0	0	0	0	0
Bactericide	0.19	0.10	0	0	0	0	0	0	0	0
Triton X-100	0	0	0	0	0	0	20.00	0	17.24	0
DGBE	0	0	46.60	31.80	44.65	29.20	0	26.90	0	0
Diethylene glycol hexyl ether	0	0	0	0	0	0	7.90	0	17.24	0
Polysorbate (Tween) 80	0	0	0	0	0	0	0	0	0	20.00
<b>Tissue parameter target by C. Gabriel and G. Harts grove.</b>										
Salt: 99 % Pure Sodium Chloride					Sucrose: 98 % Pure Sucrose					
Water: De-ionized, 16 M resistivity					HEC: Hydroxyethyl Cellulose					
DGBE: 99 % Di(ethylene glycol) butyl ether, [2-(2-butoxyethoxy) ethanol]										
Triton X-100(ultra-pure): Polyethylene glycol mono[4-(1,1,3,3-tetramethylbutyl)phenyl] ether										

**KCTL Inc.**

65, Sinwon-ro, Yeongtong-gu,  
Suwon-si, Gyeonggi-do, 16677, Korea  
TEL: 82-31-285-0894 FAX: 82-505-299-8311  
[www.kctl.co.kr](http://www.kctl.co.kr)

Report No.:  
KR19-SPF0028  
Page (107) of (131)



## Appendix C. IEEE 802.11ax SAR Power

### Appendix C.1 802.11ax Maximum Tune-up Power (Notebook)

Band	Mode	Channel	Output Power (dB m)					
			Ant.0		Ant.1		MIMO	
			Target	Max. Allowed	Target	Max. Allowed	Target	Max. Allowed
WLAN 2.4GHz	SU 20 MHz	1	16.50	<b>17.00</b>	16.25	<b>16.75</b>	13.50	<b>14.00</b>
		6	17.50	<b>18.00</b>	17.50	<b>18.00</b>	15.00	<b>15.50</b>
		11	14.50	<b>15.00</b>	15.00	<b>15.50</b>	13.00	<b>13.50</b>
	RU 26T_20 MHz	1	17.50	<b>18.00</b>	17.50	<b>18.00</b>	15.00	<b>15.50</b>
		6	15.00	<b>15.50</b>	15.00	<b>15.50</b>	12.00	<b>12.50</b>
		11	13.00	<b>13.50</b>	13.00	<b>13.50</b>	10.00	<b>10.50</b>
	RU 52T_20 MHz	1	17.50	<b>18.00</b>	17.50	<b>18.00</b>	15.00	<b>15.50</b>
		6	15.00	<b>15.50</b>	15.00	<b>15.50</b>	12.00	<b>12.50</b>
		11	13.50	<b>14.00</b>	13.50	<b>14.00</b>	10.50	<b>11.00</b>
	RU 106T_20 MHz	All Channel	17.50	<b>18.00</b>	17.50	<b>18.00</b>	15.00	<b>15.50</b>
	RU 242T_20 MHz	1	16.50	<b>17.00</b>	16.25	<b>16.75</b>	13.50	<b>14.00</b>
		6	17.50	<b>18.00</b>	17.50	<b>18.00</b>	15.00	<b>15.50</b>
		11	14.50	<b>15.00</b>	15.00	<b>15.50</b>	13.00	<b>13.50</b>
	SU 40 MHz	1	16.00	<b>16.50</b>	16.00	<b>16.50</b>	13.50	<b>14.00</b>
		6	15.50	<b>16.00</b>	15.50	<b>16.00</b>	13.00	<b>13.50</b>
		9	15.00	<b>15.50</b>	14.00	<b>14.50</b>	12.50	<b>13.00</b>
	RU 26T_40 MHz	1	17.50	<b>18.00</b>	17.50	<b>18.00</b>	15.00	<b>15.50</b>
		6	16.00	<b>16.50</b>	16.00	<b>16.50</b>	13.00	<b>13.50</b>
		9	14.00	<b>14.50</b>	14.00	<b>14.50</b>	11.00	<b>11.50</b>
	RU 52T_40 MHz	1	17.50	<b>18.00</b>	17.50	<b>18.00</b>	15.00	<b>15.50</b>
		6	16.00	<b>16.50</b>	16.00	<b>16.50</b>	13.00	<b>13.50</b>
9		14.00	<b>14.50</b>	14.00	<b>14.50</b>	11.00	<b>11.50</b>	
RU 106T_40 MHz	All Channel	17.50	<b>18.00</b>	17.50	<b>18.00</b>	15.00	<b>15.50</b>	
RU 242T_40 MHz	1	16.50	<b>17.00</b>	16.25	<b>16.75</b>	13.50	<b>14.00</b>	
	Except 1	17.50	<b>18.00</b>	17.50	<b>18.00</b>	15.00	<b>15.50</b>	
RU 484T_40 MHz	1	16.00	<b>16.50</b>	16.00	<b>16.50</b>	13.50	<b>14.00</b>	
	6	15.50	<b>16.00</b>	15.50	<b>16.00</b>	13.00	<b>13.50</b>	
	9	15.00	<b>15.50</b>	14.00	<b>14.50</b>	12.50	<b>13.00</b>	

This test report shall not be reproduced, except in full, without the written approval

KCTL-TIA002-004/2

**KCTL Inc.**

65, Sinwon-ro, Yeongtong-gu,  
Suwon-si, Gyeonggi-do, 16677, Korea  
TEL: 82-31-285-0894 FAX: 82-505-299-8311  
[www.kctl.co.kr](http://www.kctl.co.kr)

Report No.:  
KR19-SPF0028  
Page (108) of (131)



Band	Mode	Channel	Output Power (dB m)					
			Ant.0		Ant.1		MIMO	
			Target	Max. Allowed	Target	Max. Allowed	Target	Max. Allowed
U-NII-1 U-NII-2A, U-NII-2C, U-NII-3	SU 20 MHz	All Channel	15.00	15.50	15.00	15.50	12.50	13.00
	RU 26T_20 MHz	36, 40, 48, 56, 60, 100, 124	13.00	13.50	13.00	13.50	10.00	10.50
		44, 52, 120, 144	14.00	14.50	14.00	14.50	11.00	11.50
		64	13.50	14.00	13.50	14.00	10.50	11.00
		149	14.50	15.00	14.50	15.00	11.75	12.25
		157, 165	15.00	15.50	15.00	15.50	12.00	12.50
	RU 52T_20 MHz	36, 44, 52, 100, 144, 149, 157, 165	15.00	15.50	15.00	15.50	12.50	13.00
		40, 48, 60	14.00	14.50	14.00	14.50	11.00	11.50
		56, 64	15.00	15.50	15.00	15.50	12.00	12.50
		120, 124	14.50	15.00	14.50	15.00	11.50	12.00
	RU 106T_20 MHz	All Channel	15.00	15.50	15.00	15.50	12.50	13.00
	RU 242T_20 MHz	All Channel	15.00	15.50	15.00	15.50	12.50	13.00
	SU 40 MHz	All Channel	15.00	15.50	15.00	15.50	12.50	13.00
	RU 26T_40 MHz	38, 62, 102, 126	13.00	13.50	13.00	13.50	10.00	10.50
		46, 54, 118	14.00	14.50	14.00	14.50	11.00	11.50
		142	13.50	14.00	13.50	14.00	10.50	11.00
		151	14.50	15.00	14.50	15.00	11.75	12.25
		159	15.00	15.50	15.00	15.50	12.00	12.50
	RU 52T_40 MHz	38, 46, 54, 102, 118, 151, 159	15.00	15.50	15.00	15.50	12.50	13.00
		62	14.00	14.50	14.00	14.50	11.00	11.50
		126	14.50	15.00	14.50	15.00	11.50	12.00
		142	15.00	15.50	15.00	15.50	12.00	12.50
	RU 106T_40 MHz	All Channel	15.00	15.50	15.00	15.50	12.50	13.00
RU 242T_40 MHz	All Channel	15.00	15.50	15.00	15.50	12.50	13.00	
RU 484T_40 MHz	All Channel	15.00	15.50	15.00	15.50	12.50	13.00	

**KCTL Inc.**

65, Sinwon-ro, Yeongtong-gu,  
Suwon-si, Gyeonggi-do, 16677, Korea  
TEL: 82-31-285-0894 FAX: 82-505-299-8311  
[www.kctl.co.kr](http://www.kctl.co.kr)

Report No.:  
KR19-SPF0028  
Page (109) of (131)



Band	Mode	Channel	Output Power (dB m)					
			Ant.0		Ant.1		MIMO	
			Target	Max. Allowed	Target	Max. Allowed	Target	Max. Allowed
U-NII-1 U-NII-2A, U-NII-2C, U-NII-3	SU 80 MHz	All Channel	15.00	15.50	15.00	15.50	12.50	13.00
	RU 26T_80 MHz	42, 106, 138	13.00	13.50	13.00	13.50	10.00	10.50
		58, 122	14.00	14.50	14.00	14.50	11.00	11.50
		155	14.50	15.00	14.50	15.00	11.75	12.25
	RU 52T_80 MHz	All Channel	15.00	15.50	15.00	15.50	12.50	13.00
	RU 106T_80 MHz	All Channel	15.00	15.50	15.00	15.50	12.50	13.00
	RU 242T_80 MHz	All Channel	15.00	15.50	15.00	15.50	12.50	13.00
	RU 484T_80 MHz	All Channel	15.00	15.50	15.00	15.50	12.50	13.00
	RU 996T_80 MHz	All Channel	15.00	15.50	15.00	15.50	12.50	13.00
	SU 160 MHz	50	14.75	15.25	14.25	14.75	12.25	12.75
		114	14.00	14.50	13.75	14.25	12.50	13.00
	RU 26T_160 MHz	All Channel	13.00	13.50	13.00	13.50	10.00	10.50
	RU 52T_160 MHz	All Channel	15.00	15.50	15.00	15.50	12.50	13.00
	RU 106T_160 MHz	All Channel	15.00	15.50	15.00	15.50	12.50	13.00
	RU 242T_160 MHz	All Channel	15.00	15.50	15.00	15.50	12.50	13.00
	RU 484T_160 MHz	All Channel	15.00	15.50	15.00	15.50	12.50	13.00
	RU 996T_160 MHz	All Channel	15.00	15.50	15.00	15.50	12.50	13.00
	RU 2x996T_160 MHz	50	14.75	15.25	14.25	14.75	12.25	12.75
114		14.00	14.50	13.75	14.25	12.50	13.00	

**KCTL Inc.**

65, Sinwon-ro, Yeongtong-gu,  
Suwon-si, Gyeonggi-do, 16677, Korea  
TEL: 82-31-285-0894 FAX: 82-505-299-8311  
[www.kctl.co.kr](http://www.kctl.co.kr)

Report No.:  
KR19-SPF0028  
Page (110) of (131)



### Appendix C.2 802.11ax Maximum Tune-up Power (Tablet)

Band	Mode	Channel	Output Power (dB m)					
			Ant.0		Ant.1		MIMO	
			Target	Max. Allowed	Target	Max. Allowed	Target	Max. Allowed
WLAN 2.4GHz	SU 20 MHz	11	14.50	<b>15.00</b>	15.00	<b>15.50</b>	13.00	<b>13.50</b>
		Except 11	15.50	<b>16.00</b>	15.50	<b>16.00</b>	13.00	<b>13.50</b>
	RU 26T_20 MHz	1	15.50	<b>16.00</b>	15.50	<b>16.00</b>	13.00	<b>13.50</b>
		6	15.00	<b>15.50</b>	15.00	<b>15.50</b>	12.00	<b>12.50</b>
		11	13.00	<b>13.50</b>	13.00	<b>13.50</b>	10.00	<b>10.50</b>
	RU 52T_20 MHz	1	15.50	<b>16.00</b>	15.50	<b>16.00</b>	13.00	<b>13.50</b>
		6	15.00	<b>15.50</b>	15.00	<b>15.50</b>	12.00	<b>12.50</b>
		11	13.50	<b>14.00</b>	13.50	<b>14.00</b>	10.50	<b>10.50</b>
	RU 106T_20 MHz	All Channel	15.50	<b>16.00</b>	15.50	<b>16.00</b>	13.00	<b>13.50</b>
	RU 242T_20 MHz	11	14.50	<b>15.00</b>	15.00	<b>15.50</b>	13.00	<b>13.50</b>
		Except 11	15.50	<b>16.00</b>	15.50	<b>16.00</b>	13.00	<b>13.50</b>
	SU 40 MHz	9	15.00	<b>15.50</b>	14.00	<b>14.50</b>	12.50	<b>13.00</b>
		Except 9	15.50	<b>16.00</b>	15.50	<b>16.00</b>	13.00	<b>13.50</b>
	RU 26T_40 MHz	3	15.50	<b>16.00</b>	15.50	<b>16.00</b>	15.00	<b>15.50</b>
		6	15.50	<b>16.00</b>	15.50	<b>16.00</b>	13.00	<b>13.50</b>
		9	14.00	<b>14.50</b>	14.00	<b>14.50</b>	11.00	<b>11.50</b>
	RU 52T_40 MHz	9	14.00	<b>14.50</b>	14.00	<b>14.50</b>	11.00	<b>11.50</b>
		Except 9	15.50	<b>16.00</b>	15.50	<b>16.00</b>	13.00	<b>13.50</b>
	RU 106T_40 MHz	All Channel	15.50	<b>16.00</b>	15.50	<b>16.00</b>	13.00	<b>13.50</b>
	RU 242T_40 MHz	All Channel	15.50	<b>16.00</b>	15.50	<b>16.00</b>	13.00	<b>13.50</b>
RU 484T_40 MHz	9	15.00	<b>15.50</b>	14.00	<b>14.50</b>	12.50	<b>13.00</b>	
	Except 9	15.50	<b>16.00</b>	15.50	<b>16.00</b>	13.00	<b>13.50</b>	

**KCTL Inc.**

65, Sinwon-ro, Yeongtong-gu,  
Suwon-si, Gyeonggi-do, 16677, Korea  
TEL: 82-31-285-0894 FAX: 82-505-299-8311  
[www.kctl.co.kr](http://www.kctl.co.kr)

Report No.:  
KR19-SPF0028  
Page (111) of (131)



Band	Mode	Channel	Output Power (dB m)					
			Ant.0		Ant.1		MIMO	
			Target	Max. Allowed	Target	Max. Allowed	Target	Max. Allowed
U-NII-1 U-NII-2A, U-NII-2C, U-NII-3	SU 20 MHz	100, 120, 124, 144	9.00	<b>9.50</b>	12.00	<b>12.50</b>	8.00	<b>8.50</b>
		Other Ch.	10.00	<b>10.50</b>	12.00	<b>12.50</b>	8.50	<b>9.00</b>
	RU 26T_20 MHz	100, 120, 124, 144	9.00	<b>9.50</b>	12.00	<b>12.50</b>	8.00	<b>8.50</b>
		Other Ch.	10.00	<b>10.50</b>	12.00	<b>12.50</b>	8.50	<b>9.00</b>
	RU 52T_20 MHz	100, 120, 124, 144	9.00	<b>9.50</b>	12.00	<b>12.50</b>	8.00	<b>8.50</b>
		Other Ch.	10.00	<b>10.50</b>	12.00	<b>12.50</b>	8.50	<b>9.00</b>
	RU 106T_20 MHz	100, 120, 124, 144	9.00	<b>9.50</b>	12.00	<b>12.50</b>	8.00	<b>8.50</b>
		Other Ch.	10.00	<b>10.50</b>	12.00	<b>12.50</b>	8.50	<b>9.00</b>
	RU 242T_20 MHz	100, 120, 124, 144	9.00	<b>9.50</b>	12.00	<b>12.50</b>	8.00	<b>8.50</b>
		Other Ch.	10.00	<b>10.50</b>	12.00	<b>12.50</b>	8.50	<b>9.00</b>
	SU 40 MHz	102, 118, 126, 142	9.00	<b>9.50</b>	12.00	<b>12.50</b>	8.00	<b>8.50</b>
		Other Ch.	10.00	<b>10.50</b>	12.00	<b>12.50</b>	8.50	<b>9.00</b>
	RU 26T_40 MHz	102, 118, 126, 142	9.00	<b>9.50</b>	12.00	<b>12.50</b>	8.00	<b>8.50</b>
		Other Ch.	10.00	<b>10.50</b>	12.00	<b>12.50</b>	8.50	<b>9.00</b>
	RU 52T_40 MHz	102, 118, 126, 142	9.00	<b>9.50</b>	12.00	<b>12.50</b>	8.00	<b>8.50</b>
		Other Ch.	10.00	<b>10.50</b>	12.00	<b>12.50</b>	8.50	<b>9.00</b>
	RU 106T_40 MHz	102, 118, 126, 142	9.00	<b>9.50</b>	12.00	<b>12.50</b>	8.00	<b>8.50</b>
		Other Ch.	10.00	<b>10.50</b>	12.00	<b>12.50</b>	8.50	<b>9.00</b>
	RU 242T_40 MHz	102, 118, 126, 142	9.00	<b>9.50</b>	12.00	<b>12.50</b>	8.00	<b>8.50</b>
		Other Ch.	10.00	<b>10.50</b>	12.00	<b>12.50</b>	8.50	<b>9.00</b>
RU 484T_40 MHz	102, 118, 126, 142	9.00	<b>9.50</b>	12.00	<b>12.50</b>	8.00	<b>8.50</b>	
	Other Ch.	10.00	<b>10.50</b>	12.00	<b>12.50</b>	8.50	<b>9.00</b>	

This test report shall not be reproduced, except in full, without the written approval

KCTL-TIA002-004/2

**KCTL Inc.**

65, Sinwon-ro, Yeongtong-gu,  
Suwon-si, Gyeonggi-do, 16677, Korea  
TEL: 82-31-285-0894 FAX: 82-505-299-8311  
[www.kctl.co.kr](http://www.kctl.co.kr)

Report No.:  
KR19-SPF0028  
Page (112) of (131)



Band	Mode	Channel	Output Power (dB m)					
			Ant.0		Ant.1		MIMO	
			Target	Max. Allowed	Target	Max. Allowed	Target	Max. Allowed
U-NII-1 U-NII-2A, U-NII-2C, U-NII-3	SU 80 MHz	106, 122, 138	9.00	9.50	12.00	12.50	8.00	8.50
		Other Ch.	10.00	10.50	12.00	12.50	8.50	9.00
	RU 26T_80 MHz	106, 122, 138	9.00	9.50	12.00	12.50	8.00	8.50
		Other Ch.	10.00	10.50	12.00	12.50	8.50	9.00
	RU 52T_80 MHz	106, 122, 138	9.00	9.50	12.00	12.50	8.00	8.50
		Other Ch.	10.00	10.50	12.00	12.50	8.50	9.00
	RU 106T_80 MHz	106, 122, 138	9.00	9.50	12.00	12.50	8.00	8.50
		Other Ch.	10.00	10.50	12.00	12.50	8.50	9.00
	RU 242T_80 MHz	106, 122, 138	9.00	9.50	12.00	12.50	8.00	8.50
		Other Ch.	10.00	10.50	12.00	12.50	8.50	9.00
	RU 484T_80 MHz	106, 122, 138	9.00	9.50	12.00	12.50	8.00	8.50
		Other Ch.	10.00	10.50	12.00	12.50	8.50	9.00
	RU 996T_80 MHz	106, 122, 138	9.00	9.50	12.00	12.50	8.00	8.50
		Other Ch.	10.00	10.50	12.00	12.50	8.50	9.00
	SU 160 MHz	50	10.00	10.50	12.00	12.50	8.50	9.00
		114	9.00	9.50	12.00	12.50	8.00	8.50
	RU 26T_160 MHz	50	10.00	10.50	12.00	12.50	8.50	9.00
		114	9.00	9.50	12.00	12.50	8.00	8.50
	RU 52T_160 MHz	50	10.00	10.50	12.00	12.50	8.50	9.00
		114	9.00	9.50	12.00	12.50	8.00	8.50
	RU 106T_160 MHz	50	10.00	10.50	12.00	12.50	8.50	9.00
		114	9.00	9.50	12.00	12.50	8.00	8.50
	RU 242T_160 MHz	50	10.00	10.50	12.00	12.50	8.50	9.00
		114	9.00	9.50	12.00	12.50	8.00	8.50
	RU 484T_160 MHz	50	10.00	10.50	12.00	12.50	8.50	9.00
		114	9.00	9.50	12.00	12.50	8.00	8.50
	RU 996T_160 MHz	50	10.00	10.50	12.00	12.50	8.50	9.00
		114	9.00	9.50	12.00	12.50	8.00	8.50
RU 2x996T_160 MHz	50	10.00	10.50	12.00	12.50	8.50	9.00	
	114	9.00	9.50	12.00	12.50	8.00	8.50	



**KCTL Inc.**

65, Sinwon-ro, Yeongtong-gu,  
Suwon-si, Gyeonggi-do, 16677, Korea  
TEL: 82-31-285-0894 FAX: 82-505-299-8311  
[www.kctl.co.kr](http://www.kctl.co.kr)

Report No.:  
KR19-SPF0028  
Page (113) of (131)



### Appendix C.3 802.11ax RF Average Conducted Output Power (Notebook)

#### Appendix C.3.1 802.11ax 2.4G – 20 MHz Output Power

Mode		Ant.	Conducted Powers (dBm)				
Tones	RU Index		Channel				
			1	6	11	12	13
SU(HE0)		Ant.0	16.85	17.95	14.85	14.75	12.55
26T	0		17.95	15.45	13.45	12.85	4.25
52T	37		17.85	15.25	13.75	14.35	4.35
106T	53		17.95	17.95	17.85	13.35	4.35
242T	61		16.85	17.95	14.85	14.75	12.55

Mode		Ant.	Conducted Powers (dBm)				
Tones	RU Index		Channel				
			1	6	11	12	13
SU(HE0)		Ant.1	16.65	17.85	15.45	14.95	12.65
26T	0		17.85	15.35	13.45	12.75	4.35
52T	37		17.75	15.25	13.85	14.35	4.45
106T	53		17.85	17.95	17.95	13.35	4.45
242T	61		16.65	17.85	15.35	14.95	12.65

Mode		Ant.	Conducted Powers (dBm)				
Tones	RU Index		Channel				
			1	6	11	12	13
SU(HE0)		Ant.0 MIMO	13.95	15.45	13.35	12.85	10.35
26T	0		15.45	12.35	10.35	6.45	1.35
52T	37		15.45	12.45	10.95	11.25	1.45
106T	53		15.35	15.35	14.75	11.45	1.35
242T	61		13.95	15.35	13.35	12.85	10.35

Mode		Ant.	Conducted Powers (dBm)				
Tones	RU Index		Channel				
			1	6	11	12	13
SU(HE0)		Ant.1 MIMO	13.75	15.35	13.25	12.95	10.45
26T	0		15.35	12.35	10.35	6.45	1.45
52T	37		15.45	12.35	10.85	11.45	1.25
106T	53		15.35	15.35	14.95	11.35	1.45
242T	61		13.75	15.35	13.25	12.95	10.45

**KCTL Inc.**

65, Sinwon-ro, Yeongtong-gu,  
Suwon-si, Gyeonggi-do, 16677, Korea  
TEL: 82-31-285-0894 FAX: 82-505-299-8311  
[www.kctl.co.kr](http://www.kctl.co.kr)

Report No.:  
KR19-SPF0028  
Page (114) of (131)



### Appendix C.3.2 802.11ax 2.4G – 40 MHz Output Power

Mode		Ant.	Conducted Powers (dBm)				
Tones	RU Index		Channel				
			3	6	9	10	11
SU(HE0)		Ant.0	15.85	15.95	15.35	12.45	12.85
26T	0		17.95	16.35	14.45	14.45	15.35
52T	37		17.95	16.45	14.45	14.45	15.45
106T	53		17.85	17.85	17.75	17.85	17.85
242T	61		16.85	17.85	17.75	17.85	17.95
484T	65		15.85	15.95	15.35	12.35	12.85

Mode		Ant.	Conducted Powers (dBm)				
Tones	RU Index		Channel				
			3	6	9	10	11
SU(HE0)		Ant.1	16.35	15.95	14.45	12.35	12.95
26T	0		17.75	16.25	14.45	14.25	14.25
52T	37		17.75	16.35	14.35	14.25	15.35
106T	53		17.85	17.75	17.75	17.95	17.85
242T	61		16.45	17.75	17.75	17.95	17.85
484T	65		16.35	15.95	14.45	12.35	12.95

Mode		Ant.	Conducted Powers (dBm)				
Tones	RU Index		Channel				
			3	6	9	10	11
SU(HE0)		Ant.0 MIMO	13.95	13.45	12.95	9.45	10.05
26T	0		15.45	13.35	11.45	11.45	12.25
52T	37		15.45	13.45	11.45	11.45	12.45
106T	53		15.35	15.25	15.45	15.35	15.45
242T	61		13.95	15.25	15.45	15.45	15.45
484T	65		13.95	13.25	12.95	9.45	10.05

Mode		Ant.	Conducted Powers (dBm)				
Tones	RU Index		Channel				
			3	6	9	10	11
SU(HE0)		Ant.1 MIMO	13.95	13.45	12.95	9.45	10.35
26T	0		15.45	13.45	11.35	11.45	12.45
52T	37		15.35	13.35	11.45	11.35	12.35
106T	53		15.35	15.35	15.35	15.45	15.35
242T	61		13.95	15.45	15.35	15.45	15.35
484T	65		13.95	13.45	12.95	9.45	10.35

**KCTL Inc.**

65, Sinwon-ro, Yeongtong-gu,  
Suwon-si, Gyeonggi-do, 16677, Korea  
TEL: 82-31-285-0894 FAX: 82-505-299-8311  
[www.kctl.co.kr](http://www.kctl.co.kr)

Report No.:  
KR19-SPF0028  
Page (115) of (131)



### Appendix C.3.3 802.11ax 5G – 20 MHz Output Power

Mode		Ant.	Conducted Powers (dBm)														
Tones	RU Index		UNII 1 Ch.				UNII 2A Ch.				UNII 2C Ch.				UNII 3 Ch.		
			36	40	44	48	52	56	60	64	100	120	124	144	149	157	165
SU(HE0)		Ant.0	15.45	15.45	15.35	15.25	15.45	15.25	15.45	15.25	15.25	15.45	15.25	15.35	15.35	15.45	15.25
26T	0		13.35	13.45	14.35	13.25	14.35	13.35	13.35	13.95	13.25	14.35	13.35	14.25	14.85	15.45	15.35
52T	37		15.35	14.35	15.45	14.35	15.35	15.45	14.45	15.35	15.35	14.85	14.95	15.45	15.25	15.25	15.35
106T	53		15.45	15.45	15.35	15.25	15.25	15.45	15.45	15.45	15.25	15.45	15.25	15.35	15.35	15.35	15.45
242T	61		15.45	15.45	15.35	15.25	15.25	15.35	15.45	15.35	15.35	15.35	15.25	15.35	15.35	15.45	15.25

Mode		Ant.	Conducted Powers (dBm)														
Tones	RU Index		UNII 1 Ch.				UNII 2A Ch.				UNII 2C Ch.				UNII 3 Ch.		
			36	40	44	48	52	56	60	64	100	120	124	144	149	157	165
SU(HE0)		Ant.1	15.35	15.35	15.25	15.45	15.25	15.35	15.35	15.35	15.35	15.35	15.35	15.25	15.25	15.35	15.35
26T	0		13.45	13.35	14.35	13.35	14.35	13.45	13.45	13.95	13.25	14.35	13.35	14.45	14.75	15.45	15.45
52T	37		15.25	14.45	15.35	14.25	15.45	15.25	14.25	15.35	15.35	14.95	14.75	15.35	15.45	15.35	15.25
106T	53		15.25	15.35	15.35	15.25	15.45	15.45	15.25	15.45	15.45	15.35	15.35	15.25	15.25	15.45	15.35
242T	61		15.45	15.35	15.25	15.25	15.45	15.35	15.45	15.35	15.45	15.35	15.35	15.25	15.25	15.35	15.25

Mode		Ant.	Conducted Powers (dBm)														
Tones	RU Index		UNII 1 Ch.				UNII 2A Ch.				UNII 2C Ch.				UNII 3 Ch.		
			36	40	44	48	52	56	60	64	100	120	124	144	149	157	165
SU(HE0)		Ant.0 MIMO	12.85	12.85	12.85	12.85	12.95	12.95	12.85	12.95	12.75	12.75	12.75	12.75	12.85	12.75	12.75
26T	0		10.15	10.25	11.35	10.35	11.25	10.35	10.35	10.85	10.45	11.45	10.25	11.45	12.15	12.35	12.45
52T	37		12.95	11.35	12.95	11.25	12.85	12.35	11.45	12.45	12.75	11.95	11.95	12.75	12.95	12.85	12.75
106T	53		12.95	12.95	12.85	12.95	12.95	12.75	12.95	12.85	12.85	12.75	12.85	12.95	12.85	12.95	12.85
242T	61		12.85	12.85	12.85	12.95	12.95	12.75	12.95	12.75	12.85	12.75	12.85	12.95	12.75	12.95	12.95

Mode		Ant.	Conducted Powers (dBm)														
Tones	RU Index		UNII 1 Ch.				UNII 2A Ch.				UNII 2C Ch.				UNII 3 Ch.		
			36	40	44	48	52	56	60	64	100	120	124	144	149	157	165
SU(HE0)		Ant.1 MIMO	12.95	12.75	12.85	12.85	12.95	12.95	12.95	12.95	12.85	12.75	12.85	12.95	12.95	12.75	12.95
26T	0		10.35	10.45	11.35	10.25	11.45	10.25	10.25	10.85	10.35	11.35	10.35	11.45	12.15	12.25	12.35
52T	37		12.75	11.35	12.75	11.35	12.85	12.45	11.35	12.45	12.85	11.95	11.95	12.95	12.85	12.95	12.95
106T	53		12.75	12.85	12.95	12.85	12.85	12.85	12.85	12.85	12.95	12.85	12.85	12.85	12.95	12.85	12.85
242T	61		12.85	12.95	12.95	12.95	12.85	12.75	12.75	12.85	12.85	12.85	12.95	12.75	12.95	12.85	12.95

**KCTL Inc.**

65, Sinwon-ro, Yeongtong-gu,  
Suwon-si, Gyeonggi-do, 16677, Korea  
TEL: 82-31-285-0894 FAX: 82-505-299-8311  
[www.kctl.co.kr](http://www.kctl.co.kr)

Report No.:  
KR19-SPF0028  
Page (116) of (131)



### Appendix C.3.4 802.11ax 5G – 40 MHz Output Power

Mode		Ant.	Conducted Powers (dBm)									
Tones	RU Index		UNII 1 Ch.		UNII 2A Ch.		UNII 2C Ch.				UNII 3 Ch.	
			38	46	54	62	102	118	126	142	151	159
SU(HE0)		Ant.0	15.25	15.45	15.35	15.35	15.35	15.35	15.25	15.45	15.35	15.25
26T	0		13.45	14.45	14.25	13.35	13.35	14.45	13.35	13.85	14.85	15.25
52T	37		15.45	15.35	15.35	14.45	15.45	15.45	14.95	15.35	15.45	15.45
106T	53		15.35	15.35	15.25	15.15	15.25	15.35	15.25	15.35	15.25	15.25
242T	61		15.45	15.45	15.35	15.25	15.35	15.25	15.25	15.35	15.45	15.15
484T	65		15.25	15.45	15.35	15.35	15.35	15.35	15.25	15.45	15.25	15.25

Mode		Ant.	Conducted Powers (dBm)									
Tones	RU Index		UNII 1 Ch.		UNII 2A Ch.		UNII 2C Ch.				UNII 3 Ch.	
			38	46	54	62	102	118	126	142	151	159
SU(HE0)		Ant.1	15.25	15.45	15.35	15.35	15.35	15.45	15.35	15.45	15.25	15.25
26T	0		13.35	14.35	14.45	13.45	13.45	14.35	13.45	13.75	14.85	15.35
52T	37		15.45	15.35	15.25	14.25	15.45	15.35	14.75	15.45	15.45	15.35
106T	53		15.45	15.35	15.35	15.25	15.25	15.25	15.35	15.15	15.25	15.35
242T	61		15.35	15.25	15.35	15.15	15.15	15.25	15.35	15.15	15.25	15.15
484T	65		15.25	15.45	15.25	15.35	15.35	15.35	15.35	15.25	15.25	15.25

Mode		Ant.	Conducted Powers (dBm)									
Tones	RU Index		UNII 1 Ch.		UNII 2A Ch.		UNII 2C Ch.				UNII 3 Ch.	
			38	46	54	62	102	118	126	142	151	159
SU(HE0)		Ant.0 MIMO	12.75	12.85	12.95	12.95	12.75	12.85	12.75	12.85	12.75	12.95
26T	0		10.35	11.45	11.45	10.45	10.35	11.45	10.45	10.95	12.15	12.45
52T	37		12.95	12.95	12.95	11.45	12.75	12.95	11.75	12.35	12.95	12.85
106T	53		12.85	12.85	12.75	12.85	12.75	12.65	12.75	12.65	12.75	12.75
242T	61		12.95	12.85	12.65	12.85	12.85	12.85	12.75	12.65	12.85	12.65
484T	65		12.85	12.85	12.95	12.95	12.95	12.85	12.95	12.75	12.95	12.85

Mode		Ant.	Conducted Powers (dBm)									
Tones	RU Index		UNII 1 Ch.		UNII 2A Ch.		UNII 2C Ch.				UNII 3 Ch.	
			38	46	54	62	102	118	126	142	151	159
SU(HE0)		Ant.1 MIMO	12.85	12.85	12.75	12.95	12.75	12.95	12.75	12.95	12.75	12.75
26T	0		10.35	11.25	11.35	10.35	10.35	11.25	10.35	10.95	12.05	12.35
52T	37		12.75	12.95	12.85	11.35	12.85	12.95	11.95	12.35	12.95	12.85
106T	53		12.85	12.75	12.65	12.85	12.75	12.75	12.85	12.75	12.65	12.75
242T	61		12.85	12.75	12.65	12.75	12.65	12.85	12.85	12.65	12.75	12.75
484T	65		12.85	12.85	12.95	12.95	12.75	12.85	12.95	12.95	12.95	12.75

**KCTL Inc.**

65, Sinwon-ro, Yeongtong-gu,  
Suwon-si, Gyeonggi-do, 16677, Korea  
TEL: 82-31-285-0894 FAX: 82-505-299-8311  
[www.kctl.co.kr](http://www.kctl.co.kr)

Report No.:  
KR19-SPF0028  
Page (117) of (131)



### Appendix C.3.5 802.11ax 5G – 80 MHz Output Power

Mode		Ant.	Conducted Powers (dBm)					
Tones	RU Index		UNII 1 Ch.	UNII 2A Ch.	UNII 2C Ch.		UNII 3 Ch.	
			42	58	106	122	138	155
SU(HE0)		Ant.0	15.25	15.25	15.35	15.45	15.25	15.45
26T	0		13.25	14.35	13.45	14.35	13.25	14.75
52T	37		15.25	15.35	15.45	15.35	15.35	15.25
106T	53		15.35	15.05	15.35	15.35	15.35	15.35
242T	61		15.45	15.25	15.25	15.15	15.25	15.15
484T	65		15.45	15.35	15.15	15.25	15.15	15.35
996T	67		15.25	15.25	15.45	15.45	15.45	15.45

Mode		Ant.	Conducted Powers (dBm)					
Tones	RU Index		UNII 1 Ch.	UNII 2A Ch.	UNII 2C Ch.		UNII 3 Ch.	
			42	58	106	122	138	155
SU(HE0)		Ant.1	15.45	15.45	15.35	15.25	15.35	15.45
26T	0		13.35	14.35	13.45	14.45	13.35	14.75
52T	37		15.25	15.45	15.45	15.45	15.45	15.25
106T	53		15.45	15.15	15.15	15.45	15.35	15.15
242T	61		15.45	15.15	15.35	15.35	15.25	15.15
484T	65		15.35	15.25	15.25	15.25	15.15	15.25
996T	67		15.45	15.45	15.25	15.45	15.35	15.45

Mode		Ant.	Conducted Powers (dBm)					
Tones	RU Index		UNII 1 Ch.	UNII 2A Ch.	UNII 2C Ch.		UNII 3 Ch.	
			42	58	106	122	138	155
SU(HE0)		Ant.0 MIMO	12.95	12.95	12.95	12.75	12.95	12.85
26T	0		10.35	11.35	10.35	11.45	10.35	12.05
52T	37		12.95	12.85	12.75	12.75	12.75	12.95
106T	53		12.85	12.55	12.65	12.85	12.85	12.75
242T	61		12.95	12.85	12.75	12.85	12.95	12.75
484T	65		12.75	12.45	12.55	12.55	12.75	12.65
996T	67		12.85	12.85	12.85	12.85	12.75	12.75

Mode		Ant.	Conducted Powers (dBm)					
Tones	RU Index		UNII 1 Ch.	UNII 2A Ch.	UNII 2C Ch.		UNII 3 Ch.	
			42	58	106	122	138	155
SU(HE0)		Ant.1 MIMO	12.85	12.85	12.85	12.85	12.95	12.95
26T	0		10.35	11.25	10.45	11.45	10.35	12.15
52T	37		12.85	12.85	12.85	12.75	12.85	12.85
106T	53		12.95	12.65	12.65	12.65	12.85	12.75
242T	61		12.95	12.75	12.75	12.75	12.95	12.65
484T	65		12.95	12.85	12.75	12.95	12.75	12.85
996T	67		12.85	12.85	12.75	12.95	12.85	12.85

**KCTL Inc.**

65, Sinwon-ro, Yeongtong-gu,  
Suwon-si, Gyeonggi-do, 16677, Korea  
TEL: 82-31-285-0894 FAX: 82-505-299-8311  
[www.kctl.co.kr](http://www.kctl.co.kr)

Report No.:  
KR19-SPF0028  
Page (118) of (131)



### Appendix C.3.6 802.11ax 5G – 160 MHz Output Power

Mode		Ant.	Conducted Powers (dBm)	
Tones	RU Index		UNII Ch.	
			50	114
SU(HE0)		Ant.0	15.15	14.25
26T	0		13.25	13.45
52T	37		15.25	15.45
106T	53		15.35	15.35
242T	61		15.45	15.25
484T	65		15.25	15.45
996T	67		15.45	15.35
2x996T	68		15.15	14.25

Mode		Ant.	Conducted Powers (dBm)	
Tones	RU Index		UNII Ch.	
			50	114
SU(HE0)		Ant.1	14.55	14.05
26T	0		13.45	13.35
52T	37		15.35	15.35
106T	53		15.35	15.35
242T	61		15.35	15.45
484T	65		15.45	15.45
996T	67		15.45	15.25
2x996T	68		14.55	14.05

Mode		Ant.	Conducted Powers (dBm)	
Tones	RU Index		UNII Ch.	
			50	114
SU(HE0)		Ant.0 MIMO	12.68	12.88
26T	0		10.35	10.35
52T	37		12.95	12.85
106T	53		12.95	12.85
242T	61		12.85	12.85
484T	65		12.95	12.75
996T	67		12.85	12.75
2x996T	68		12.65	12.85

Mode		Ant.	Conducted Powers (dBm)	
Tones	RU Index		UNII Ch.	
			50	114
SU(HE0)		Ant.1 MIMO	12.68	12.78
26T	0		10.35	10.25
52T	37		12.85	12.95
106T	53		12.85	12.95
242T	61		12.85	12.75
484T	65		12.85	12.85
996T	67		12.95	12.75
2x996T	68		12.65	12.75

This test report shall not be reproduced, except in full, without the written approval

**KCTL Inc.**

65, Sinwon-ro, Yeongtong-gu,  
Suwon-si, Gyeonggi-do, 16677, Korea  
TEL: 82-31-285-0894 FAX: 82-505-299-8311  
[www.kctl.co.kr](http://www.kctl.co.kr)

Report No.:  
KR19-SPF0028  
Page (119) of (131)



### Appendix C.4 802.11ax RF Average Conducted Output Power (Tablet)

#### Appendix C.4.1 802.11ax 2.4G – 20 MHz Output Power

Mode		Ant.	Conducted Powers (dBm)				
Tones	RU Index		Channel				
			1	6	11	12	13
SU(HE0)		Ant.0	15.95	15.85	14.75	14.95	12.55
26T	0		15.85	15.35	13.35	12.75	4.35
52T	37		15.85	15.25	13.75	14.35	4.35
106T	53		15.95	15.85	15.85	13.25	4.45
242T	61		15.95	15.85	14.75	14.95	12.55

Mode		Ant.	Conducted Powers (dBm)				
Tones	RU Index		Channel				
			1	6	11	12	13
SU(HE0)		Ant.1	15.85	15.85	15.35	14.95	12.65
26T	0		15.85	15.35	13.45	12.85	4.45
52T	37		15.85	15.35	13.85	14.35	4.45
106T	53		15.95	15.85	15.95	13.35	4.45
242T	61		15.75	15.85	15.35	14.95	12.65

Mode		Ant.	Conducted Powers (dBm)				
Tones	RU Index		Channel				
			1	6	11	12	13
SU(HE0)		Ant.0 MIMO	13.45	13.35	13.35	12.75	10.35
26T	0		13.35	12.45	10.45	6.35	1.35
52T	37		13.45	12.45	10.85	11.45	1.45
106T	53		13.35	13.35	13.35	11.35	1.35
242T	61		13.35	13.45	13.45	12.75	10.35

Mode		Ant.	Conducted Powers (dBm)				
Tones	RU Index		Channel				
			1	6	11	12	13
SU(HE0)		Ant.1 MIMO	13.25	13.25	13.35	12.75	10.45
26T	0		13.45	12.45	10.35	6.45	1.35
52T	37		13.45	12.45	10.95	11.25	1.45
106T	53		13.45	13.35	13.45	11.35	1.45
242T	61		13.25	13.35	13.25	12.95	10.45

**KCTL Inc.**

65, Sinwon-ro, Yeongtong-gu,  
Suwon-si, Gyeonggi-do, 16677, Korea  
TEL: 82-31-285-0894 FAX: 82-505-299-8311  
[www.kctl.co.kr](http://www.kctl.co.kr)

Report No.:  
KR19-SPF0028  
Page (120) of (131)



### Appendix C.4.2 802.11ax 2.4G – 40 MHz Output Power

Mode		Ant.	Conducted Powers (dBm)				
Tones	RU Index		Channel				
			3	6	9	10	11
SU(HE0)		Ant.0	15.85	15.85	15.45	12.45	12.85
26T	0		15.85	15.85	14.35	14.35	15.45
52T	37		15.85	15.85	14.35	14.45	15.45
106T	53		15.75	15.75	15.95	15.95	15.85
242T	61		15.95	15.95	15.85	15.85	15.95
484T	65		15.85	15.85	15.45	12.45	12.85

Mode		Ant.	Conducted Powers (dBm)				
Tones	RU Index		Channel				
			3	6	9	10	11
SU(HE0)		Ant.1	15.95	15.95	14.45	12.35	12.95
26T	0		15.85	15.85	14.45	14.35	14.25
52T	37		15.95	15.95	14.35	14.35	15.45
106T	53		15.85	15.75	15.85	15.95	15.85
242T	61		15.85	15.75	15.75	15.95	15.95
484T	65		15.95	15.95	14.45	12.35	12.95

Mode		Ant.	Conducted Powers (dBm)				
Tones	RU Index		Channel				
			3	6	9	10	11
SU(HE0)		Ant.0 MIMO	13.45	13.45	12.85	9.45	10.45
26T	0		15.35	13.25	11.25	11.45	12.45
52T	37		13.35	13.35	11.25	11.25	12.35
106T	53		13.35	13.25	13.35	13.35	13.45
242T	61		13.35	13.25	13.35	13.45	13.35
484T	65		13.45	13.45	12.75	9.35	10.45

Mode		Ant.	Conducted Powers (dBm)				
Tones	RU Index		Channel				
			3	6	9	10	11
SU(HE0)		Ant.1 MIMO	13.25	13.25	12.95	9.45	10.25
26T	0		15.35	13.25	11.45	11.35	12.45
52T	37		13.35	13.35	11.45	11.45	12.35
106T	53		13.35	13.25	13.45	13.25	13.35
242T	61		13.35	13.35	13.25	13.25	13.35
484T	65		13.25	13.25	12.95	9.35	10.25



# KCTL Inc.

65, Sinwon-ro, Yeongtong-gu,  
Suwon-si, Gyeonggi-do, 16677, Korea  
TEL: 82-31-285-0894 FAX: 82-505-299-8311  
[www.kctl.co.kr](http://www.kctl.co.kr)

Report No.:  
KR19-SPF0028  
Page (121) of (131)



## Appendix C.4.3 802.11ax 5G – 20 MHz Output Power

Mode		Ant.	Conducted Powers (dBm)														
Tones	RU Index		UNII 1 Ch.				UNII 2A Ch.				UNII 2C Ch.				UNII 3 Ch.		
			36	40	44	48	52	56	60	64	100	120	124	144	149	157	165
SU(HE0)		Ant.0	10.45	10.45	10.45	10.35	10.35	10.25	10.25	10.25	9.45	9.45	9.35	9.45	10.35	10.45	10.45
26T	0		10.45	10.35	10.45	10.35	10.35	10.45	10.45	10.45	9.25	9.35	9.35	9.25	10.45	10.45	10.35
52T	37		10.35	10.45	10.25	10.45	10.45	10.45	10.25	10.45	9.35	9.35	9.35	9.45	10.45	10.25	10.25
106T	53		9.95	10.25	10.45	10.25	10.35	10.45	10.35	10.35	9.45	9.45	9.45	9.45	10.35	10.45	10.35
242T	61		10.05	10.45	10.25	10.35	10.35	10.35	10.25	10.45	9.35	9.45	9.45	9.45	10.35	10.25	10.45

Mode		Ant.	Conducted Powers (dBm)														
Tones	RU Index		UNII 1 Ch.				UNII 2A Ch.				UNII 2C Ch.				UNII 3 Ch.		
			36	40	44	48	52	56	60	64	100	120	124	144	149	157	165
SU(HE0)		Ant.1	12.35	12.45	12.25	12.45	12.35	12.35	12.35	12.35	12.45	12.25	12.25	12.35	12.35	12.35	12.25
26T	0		12.35	12.45	12.25	12.45	12.45	12.35	12.45	12.25	12.45	12.35	12.35	12.35	12.25	12.25	12.25
52T	37		12.25	12.25	12.45	12.35	12.45	12.25	12.35	12.35	12.35	12.35	12.35	12.35	12.45	12.35	12.35
106T	53		12.45	12.45	12.45	12.35	12.25	12.45	12.25	12.35	12.45	12.35	12.35	12.45	12.35	12.45	12.45
242T	61		12.25	12.35	12.45	12.45	12.25	12.45	12.45	12.45	12.45	12.35	12.35	12.25	12.35	12.45	12.45

Mode		Ant.	Conducted Powers (dBm)														
Tones	RU Index		UNII 1 Ch.				UNII 2A Ch.				UNII 2C Ch.				UNII 3 Ch.		
			36	40	44	48	52	56	60	64	100	120	124	144	149	157	165
SU(HE0)		Ant.0 MIMO	8.95	8.95	8.95	8.85	8.85	8.85	8.75	8.75	8.35	8.35	8.45	8.25	8.85	8.85	8.85
26T	0		8.85	8.95	8.75	8.85	8.95	8.95	8.95	8.95	8.35	8.25	8.35	8.35	8.85	8.75	8.85
52T	37		8.85	8.95	8.95	8.85	8.85	8.85	8.95	8.95	8.25	8.25	8.25	8.35	8.85	8.95	8.85
106T	53		8.75	8.85	8.85	8.75	8.95	8.85	8.85	8.85	8.35	8.35	8.35	8.45	8.65	8.85	8.95
242T	61		8.85	8.85	8.75	8.85	8.75	8.75	8.95	8.95	8.25	8.35	8.35	8.45	8.65	8.85	8.85

Mode		Ant.	Conducted Powers (dBm)														
Tones	RU Index		UNII 1 Ch.				UNII 2A Ch.				UNII 2C Ch.				UNII 3 Ch.		
			36	40	44	48	52	56	60	64	100	120	124	144	149	157	165
SU(HE0)		Ant.1 MIMO	8.95	8.85	8.95	8.95	8.95	8.75	8.95	8.95	8.25	8.35	8.35	8.25	8.85	8.85	8.95
26T	0		8.85	8.95	8.85	8.75	8.95	8.75	8.95	8.85	8.35	8.35	8.35	8.45	8.85	8.75	8.75
52T	37		8.85	8.95	8.85	8.85	8.95	8.95	8.95	8.95	8.35	8.45	8.25	8.45	8.85	8.75	8.95
106T	53		8.75	8.85	8.95	8.95	8.75	8.85	8.85	8.95	8.45	8.45	8.45	8.35	8.95	8.85	8.85
242T	61		8.85	8.95	8.95	8.95	8.85	8.85	8.85	8.85	8.35	8.45	8.45	8.35	8.75	8.85	8.75

**KCTL Inc.**

65, Sinwon-ro, Yeongtong-gu,  
Suwon-si, Gyeonggi-do, 16677, Korea  
TEL: 82-31-285-0894 FAX: 82-505-299-8311  
[www.kctl.co.kr](http://www.kctl.co.kr)

Report No.:  
KR19-SPF0028  
Page (122) of (131)



### Appendix C.4.4 802.11ax 5G – 40 MHz Output Power

Mode		Ant.	Conducted Powers (dBm)									
Tones	RU Index		UNII 1 Ch.		UNII 2A Ch.		UNII 2C Ch.				UNII 3 Ch.	
			38	46	54	62	102	118	126	142	151	159
SU(HE0)		Ant.0	10.45	10.45	10.45	10.35	9.25	9.25	9.45	9.15	10.25	10.25
26T	0		10.45	10.25	10.25	10.25	9.25	9.35	9.25	9.45	10.45	10.45
52T	37		10.15	10.35	10.45	10.45	9.45	9.45	9.45	9.35	10.35	10.35
106T	53		10.25	10.45	10.45	10.25	9.35	9.35	9.35	9.45	10.45	10.45
242T	61		10.25	10.45	10.45	10.45	9.45	9.35	9.35	9.45	10.45	10.35
484T	65		10.05	10.25	10.35	10.25	9.35	9.25	9.45	9.25	10.45	10.45

Mode		Ant.	Conducted Powers (dBm)									
Tones	RU Index		UNII 1 Ch.		UNII 2A Ch.		UNII 2C Ch.				UNII 3 Ch.	
			38	46	54	62	102	118	126	142	151	159
SU(HE0)		Ant.1	12.35	12.25	12.35	12.35	12.45	12.45	12.45	12.45	12.35	12.45
26T	0		12.45	12.45	12.25	12.25	12.35	12.45	12.45	12.35	12.45	12.45
52T	37		12.45	12.35	12.45	12.35	12.35	12.45	12.35	12.45	12.35	12.25
106T	53		12.45	12.45	12.35	12.45	12.45	12.35	12.45	12.35	12.45	12.35
242T	61		12.45	12.35	12.35	12.25	12.35	12.35	12.45	12.35	12.45	12.45
484T	65		12.25	12.45	12.35	12.35	12.45	12.35	12.35	12.25	12.45	12.45

Mode		Ant.	Conducted Powers (dBm)									
Tones	RU Index		UNII 1 Ch.		UNII 2A Ch.		UNII 2C Ch.				UNII 3 Ch.	
			38	46	54	62	102	118	126	142	151	159
SU(HE0)		Ant.0 MIMO	8.85	8.85	8.85	8.85	8.45	8.35	8.45	8.45	8.85	8.85
26T	0		8.95	8.95	8.75	8.95	8.25	8.35	8.35	8.45	8.95	8.75
52T	37		8.85	8.85	8.85	8.95	8.35	8.45	8.45	8.25	8.85	8.95
106T	53		8.95	8.95	8.95	8.95	8.35	8.35	8.35	8.45	8.95	8.85
242T	61		8.95	8.95	8.95	8.85	8.45	8.35	8.35	8.35	8.85	8.95
484T	65		8.75	8.75	8.75	8.95	8.35	8.35	8.35	8.35	8.75	8.95

Mode		Ant.	Conducted Powers (dBm)									
Tones	RU Index		UNII 1 Ch.		UNII 2A Ch.		UNII 2C Ch.				UNII 3 Ch.	
			38	46	54	62	102	118	126	142	151	159
SU(HE0)		Ant.1 MIMO	8.95	8.95	8.95	8.75	8.35	8.45	8.35	8.25	8.75	8.75
26T	0		8.95	8.85	8.95	8.95	8.35	8.45	8.35	8.25	8.85	8.95
52T	37		8.85	8.95	8.95	8.85	8.45	8.35	8.45	8.45	8.95	8.85
106T	53		8.95	8.85	8.95	8.95	8.25	8.45	8.35	8.25	8.85	8.95
242T	61		8.95	8.75	8.95	8.85	8.45	8.45	8.35	8.25	8.85	8.95
484T	65		8.95	8.85	8.75	8.95	8.25	8.45	8.25	8.45	8.95	8.75

**KCTL Inc.**

65, Sinwon-ro, Yeongtong-gu,  
Suwon-si, Gyeonggi-do, 16677, Korea  
TEL: 82-31-285-0894 FAX: 82-505-299-8311  
[www.kctl.co.kr](http://www.kctl.co.kr)

Report No.:  
KR19-SPF0028  
Page (123) of (131)



### Appendix C.4.5 802.11ax 5G – 80 MHz Output Power

Mode		Ant.	Conducted Powers (dBm)					
Tones	RU Index		UNII 1 Ch.	UNII 2A Ch.	UNII 2C Ch.		UNII 3 Ch.	
			42	58	106	122	138	155
SU(HE0)		Ant.0	10.25	10.45	9.45	9.35	9.35	10.45
26T	0		10.25	10.15	9.35	9.35	9.15	10.45
52T	37		10.45	10.05	9.35	9.45	9.35	10.35
106T	53		10.25	10.35	9.35	9.35	9.45	10.45
242T	61		10.35	10.35	9.35	9.45	9.35	10.35
484T	65		10.15	10.25	9.45	9.35	9.35	10.45
996T	67		10.25	10.35	9.35	9.25	9.45	10.45

Mode		Ant.	Conducted Powers (dBm)					
Tones	RU Index		UNII 1 Ch.	UNII 2A Ch.	UNII 2C Ch.		UNII 3 Ch.	
			42	58	106	122	138	155
SU(HE0)		Ant.1	12.34	12.24	12.24	12.34	12.44	12.44
26T	0		12.24	12.44	12.34	12.44	12.44	12.34
52T	37		12.34	12.44	12.34	12.34	12.44	12.44
106T	53		12.44	12.34	12.44	12.24	12.34	12.34
242T	61		12.44	12.44	12.44	12.44	12.24	12.44
484T	65		12.44	12.44	12.24	12.34	12.34	12.34
996T	67		12.44	12.44	12.44	12.34	12.44	12.34

Mode		Ant.	Conducted Powers (dBm)					
Tones	RU Index		UNII 1 Ch.	UNII 2A Ch.	UNII 2C Ch.		UNII 3 Ch.	
			42	58	106	122	138	155
SU(HE0)		Ant.0 MIMO	8.84	8.74	8.24	8.44	8.34	8.74
26T	0		8.84	8.94	8.24	8.34	8.44	8.94
52T	37		8.94	8.84	8.44	8.34	8.34	8.94
106T	53		8.94	8.74	8.34	8.34	8.24	8.94
242T	61		8.84	8.84	8.34	8.44	8.44	8.84
484T	65		8.94	8.84	8.44	8.44	8.44	8.94
996T	67		8.74	8.94	8.44	8.24	8.24	8.84

Mode		Ant.	Conducted Powers (dBm)					
Tones	RU Index		UNII 1 Ch.	UNII 2A Ch.	UNII 2C Ch.		UNII 3 Ch.	
			42	58	106	122	138	155
SU(HE0)		Ant.1 MIMO	8.94	8.94	8.34	8.44	8.24	8.94
26T	0		8.74	8.84	8.24	8.34	8.44	8.74
52T	37		8.94	8.74	8.34	8.44	8.34	8.94
106T	53		8.84	8.94	8.44	8.44	8.24	8.84
242T	61		8.94	8.74	8.44	8.44	8.34	8.94
484T	65		8.84	8.94	8.34	8.24	8.24	8.94
996T	67		8.84	8.84	8.24	8.44	8.44	8.84

This test report shall not be reproduced, except in full, without the written approval

**KCTL Inc.**

65, Sinwon-ro, Yeongtong-gu,  
Suwon-si, Gyeonggi-do, 16677, Korea  
TEL: 82-31-285-0894 FAX: 82-505-299-8311  
[www.kctl.co.kr](http://www.kctl.co.kr)

Report No.:  
KR19-SPF0028  
Page (124) of (131)



### Appendix C.4.6 802.11ax 5G – 160 MHz Output Power

Mode		Ant.	Conducted Powers (dBm)	
Tones	RU Index		UNII Ch.	
			50	114
SU(HE0)		Ant.0	10.45	9.35
26T	0		10.35	9.25
52T	37		10.35	9.35
106T	53		10.35	9.35
242T	61		10.35	9.25
484T	65		10.35	9.35
996T	67		10.45	9.25
2x996T	68		10.45	9.35

Mode		Ant.	Conducted Powers (dBm)	
Tones	RU Index		UNII Ch.	
			50	114
SU(HE0)		Ant.1	12.35	12.35
26T	0		12.45	12.35
52T	37		12.25	12.35
106T	53		12.45	12.35
242T	61		12.45	12.45
484T	65		12.35	12.25
996T	67		12.35	12.45
2x996T	68		12.45	12.35

Mode		Ant.	Conducted Powers (dBm)	
Tones	RU Index		UNII Ch.	
			50	114
SU(HE0)		Ant.0 MIMO	8.88	8.48
26T	0		8.95	8.35
52T	37		8.85	8.35
106T	53		8.75	8.35
242T	61		8.85	8.45
484T	65		8.85	8.35
996T	67		8.95	8.25
2x996T	68		8.85	8.45

Mode		Ant.	Conducted Powers (dBm)	
Tones	RU Index		UNII Ch.	
			50	114
SU(HE0)		Ant.1 MIMO	8.98	8.48
26T	0		8.75	8.45
52T	37		8.95	8.35
106T	53		8.95	8.45
242T	61		8.75	8.35
484T	65		8.75	8.25
996T	67		8.85	8.45
2x996T	68		8.85	8.35

This test report shall not be reproduced, except in full, without the written approval