



EMC Measurement/Technical Report

on

Digianswer Bluetooth Base Unit DGABTBU100

Report Reference: 4_DIGI_0100_BT_FCCe

7 Layers AG
Borsigstr. 11
40880 Ratingen
Germany

Note:

The following test results relate only to the devices specified in this document. This report shall not be reproduced in parts without the written approval of the testing laboratory.

Registergericht - registered in:
Ratingen, HRB 3264
Aufsichtsratsvorsitzende -
Chairman of the Supervisory Board:
Dr. Sabine Grobecker

Vorstand - Board of Directors:
Dr. Wolfgang Dahm
Dr. Hans-Jürgen Meckelburg

7 layers AG, Borsigstrasse 11
40880 Ratingen, Germany
Phone: +49 (0) 2102 749 0
Fax: +49 (0) 2102 749 350
<http://www.7Layers.com>

Table of Contents

0. Summary	3
0.1 Technical Report Summary	3
0.2 Measurement Summary	4
1. Administrative Data	6
1.1 Testing Laboratory	6
1.2 Project Data	6
1.3 Applicant Data	6
1.4 Manufacturer Data	6
2. Product Labeling	7
2.1 FCC ID Label	7
2.2 Location of Label on the EUT	7
3. Testobject Data	8
3.1 General EUT Description	8
3.2 EUT Main Components	9
3.3 Ancillary Equipment	9
3.4 EUT Setups	9
3.5 Operating Modes	9
4. Measurement Results	11
4.1 Conducted Emissions	11
4.2 Occupied Bandwidth	13
4.3 Output Power	15
4.4 Spurious Emissions Conducted	18
4.5 Spurious Emissions Radiated	20
4.6 Dwell Time	26
4.7 Power Density	28
4.8 Channel Separation	30
4.9 Processing Gain	31
5. Testequipment	32
6. Foto Report	34
7. Setup Drawings	36
8. Annex	39
Measurement plots	



0 Summary

0.1 Technical Report Summary

Type of Authorization

Certification for an Intentional Radiator (Frequency Hopping Spread Spectrum)

Applicable FCC Rules:

Prepared in accordance with the requirements of FCC Rules and Regulations as listed in 47 CFR Ch.1 Parts 0 to 19 (10-1-98 Edition). The following subparts are applicable to the results in this test report.

Part 2, Subpart J - Equipment Authorization Procedures, Certification Sections

Part 15, Subpart C - Intentional Radiators

§ 15.201 Equipment authorization requirement

§ 15.203 Antenna requirements

§ 15.207 Conducted limits

§ 15.209 Radiated emission limits; general requirements

§ 15.247 Operation within the bands 902-928 MHz, 2400-2483,5 MHz and 5725-5850 MHz

Note:

The tests were selected and performed with reference to the FCC Public Notice DA 00-705, released March 30, 2000

Summary Test Results:

The EUT complied with all the applicable FCC rules as listed above.



0.2 Measurement Summary

FCC Part 15, Subpart C § 15.207

Conducted Emissions (AC Power Line)

The measurement was performed according to ANSI C63.4 1992

OP-Mode	Setup	Port	Final Result
op-mode 4	setup 1	AC port	passed
op-mode 5	setup 2	AC port	passed

FCC Part 15, Subpart C § 15.247 (a) (1) (ii)

Occupied Bandwidth

The measurement was performed according to ANSI C63.4 1992

OP-Mode	Setup	Port	Final Result
op-mode 1	setup 1	Antenna port	passed
op-mode 2	setup 1	Antenna port	passed
op-mode 3	setup 1	Antenna port	passed
op-mode 6	setup 1	Antenna port	passed
op-mode 7	setup 1	Antenna port	passed

FCC Part 15, Subpart C § 15.247 (b) (1)

Peak Power Output

The measurement was performed according to FCC §15.31 10-1-1998

OP-Mode	Setup	Port	Final Result
op-mode 1	setup 1	Antenna port	passed
op-mode 2	setup 1	Antenna port	passed
op-mode 3	setup 1	Antenna port	passed

FCC Part 15, Subpart C § 15.247 (c)

Spurious RF Conducted Emissions

The measurement was performed according to FCC §15.31 10-1-1998

OP-Mode	Setup	Port	Final Result
op-mode 1	setup 1	Antenna port	passed
op-mode 2	setup 1	Antenna port	passed
op-mode 3	setup 1	Antenna port	passed

FCC Part 15, Subpart C § 15.247 (c), §15.35 (b), § 15.209

Spurious Radiated Emissions

The measurement was performed according to ANSI C63.4 1992

OP-Mode	Setup	Port	Final Result
op-mode 1	setup 1	enclosure	passed
op-mode 2	setup 1	enclosure	passed
op-mode 3	setup 1	enclosure	passed

FCC Part 15, Subpart C § 15.247(g)



Dwell Time

The measurement was performed according to FCC §15.31 10-1-1998

OP-Mode	Setup	Port	Final Result
op-mode 6	setup 1	Antenna port	passed
op-mode 7	setup 1	Antenna port	passed

FCC Part 15, Subpart C § 15.247 (g)

Power Density

The measurement was performed according to FCC §15.31 10-1-1998

OP-Mode	Setup	Port	Final Result
op-mode 6	setup 1	Antenna port	passed
op-mode 7	setup 1	Antenna port	passed

FCC Part 15, Subpart C § 15.247 (a) (1)

Channel Separation

The measurement was performed according to FCC §15.31 10-1-1998

OP-Mode	Setup	Port	Final Result
op-mode 4	setup 1	Antenna port	passed

FCC Part 15, Subpart C § 15.247 (g)

Processing Gain

The measurement was performed according to FCC §15.31 10-1-1998

OP-Mode	Setup	Port	Final Result
op-mode 4	setup 1	Antenna port	passed

Responsible for Accreditation Scope: _____

Responsible for Test Report: _____



1. Administrative Data

1.1 Testing Laboratory

Company Name: 7 Layers AG
Address: Borsigstr. 11
40880 Ratingen
Germany

This facility has been fully described in a report submitted to the FCC and accepted in a letter dated February 07, 2000 under the registration number 96716.

The test facility is also accredited by the following accreditation organisation:

- Deutscher Akkreditierungs Rat DAR-Registration no. TTI-P-G 178/99-10
- Regulierungsbehörde für Telekommunikation und Post (Reg TP)

Responsible for Accreditation Scope: Dipl.-Ing Bernhard Retka
Dipl.-Ing Arndt Stöcker

1.2 Project Data

Project Leader: Dipl.-Ing. Thomas Hoell
Receipt of EUT: 21.08.00
Date of Test(s): 18.08. - 26.09.00
Date of Report: 26.09.00
No. of Pages in Annex: none

1.3 Applicant Data

Company Name: Digianswer A/S
Address: Skalhuse 5

DK-9240 Nibe
Denmark
Contact Person: Mr. Trom Ringtved

1.4 Manufacturer Data

Company Name: see applicant
Address:

Contact Person:



2.0 Product Labeling

2.1 FCC ID Label:

At the time of this report there was no ID label available. This will be added to the report whenever the report will be sent to the FCC.

2.2 Location of Label on the EUT:

3. Testobject Data

3.1 General EUT Description

Equipment under Test:	Digianswer Bluetooth Base Unit
Type Designation:	DGABTBU100
Kind of Device: (optional)	
Voltage Type:	DC
Voltage level:	9 V

General product description:

Bluetooth is a short-range radio link intended to be a cable replacement between portable and/or fixed electronic devices.

Bluetooth operates in the unlicensed ISM Band at 2.4 GHz. In the US a band of 83.5 MHz width is available. In this band, 79 RF channels spaced 1MHz apart are defined. The channel is represented by a pseudo-random hopping sequence through the 79 channels. The channel is divided into time slots, with a nominal slot length of 625 μ s, where each slot corresponds to different RF hop frequencies. The nominal hop rate is 1600 hops/s. All frequencies are equally used. The average time of occupancy is 0.3797 s within a 30 second period. The symbol rate on the channel is 1 Ms/s.

The EUT provides the following ports:

Ports

AC port
Antenna port
DC port
enclosure

The main components of EUT are listed and described in Chapter 2.2

3.2 EUT Main components:

Type, S/N, Short Descriptions etc. used in this Test Report

Short Description	Equipment under Test	Type Designation	Serial No.	HW Status	SW Status	Date of Receipt
EUT A	Base Unit - DGABTB100	Base Unit	6666	DIG430-6	GNBS-935, BB9981	21.08.00

NOTE: The short description is used to simplify the identification of the EUT in this test report

3.3 Ancillary Equipment

For the purposes of this test report, ancillary equipment is defined as equipment which is used in conjunction with the EUT to provide additional operational and control features to the EUT. It is necessary to configure the system in a typical fashion, as a customer would normally use it.

Short Description	Equipment under Test	Type Designation	HW Status	SW Status	Serial No.	FCC Id
AE 1	GN Netcom 1699-059	Power Plug	-	-	-	

3.4 EUT Setups

This chapter describes the combination of EUT's and ancillary equipment used for testing.

Setup No.	Combination of EUTs	Description
setup 1	EUT A + AE 1	In this setup the Base Unit could have a connection with the Headset or could be in switched in a testmode and transmit continuously
setup 2	EUT A + AE 1	the Base Unit is in idle, the Headset is charged
setup 3		

3.5 Operating Modes

This chapter describes the operating modes of the EUT's used for testing.

Op. Mode	Description of Operating Modes	Remarks
op-mode 1	TX mode, the EUT transmit continuously on 2402 MHz	
op-mode 2	TX mode, the EUT transmit continuously on 2441 MHz	
op-mode 3	TX mode, the EUT transmit continuously on 2480 MHz	
op-mode 4	TX mode, the EUT has a continuous link to the Headset	
op-mode 5	stand by, the transmitter of the EUT is switched off and the Headset is charged from the EUT	
op-mode 6	Inquiry mode, the EUT continuously scan for inquiry	
op-mode 7	Paging, the EUT continuously page for another participant	

4. Test Results

4.1 Conducted Emissions (AC Power Line)

Standard FCC Part 15, 10-1-98
Subpart C

The test was performed according to: ANSI C63.4 1992

4.1.1 Test Description

The test set-up was made in accordance to the general provisions of ANSI C63.4-1992.

The Equipment Under Test (EUT) was setup in a shielded room to perform the conducted emissions measurements in a typical installation configuration.

The EUT was powered from 50 μ H || 50 Ohm Line Impedance Stabilization Network (LISN). The LISN's unused connections were terminated with 50 Ohm loads.

The measurement procedure consists of two steps. It is implemented into EMI test software ES-K1 from R&S.

Step 1: Preliminary scan

Preliminary test to identify the highest amplitudes relative to the limit.

EMI receiver settings:

- Detector: Peak - Maxhold
- Frequency range: 450 kHz – 30 MHz
- Frequency steps: 5 kHz
- IF-Bandwidth: 10 kHz
- Measuring time / Frequency step: 1 ms
- Measurement on phase + neutral lines of the power cords

Intention of this step is, to determine the conducted EMI-profile of the EUT. With this data, the test system performs (to reduce the number of final measurements) a data reduction with the following parameters:

- Offset for acceptance analysis: Limit line – 6 dB
- Maximum number of final measurements: 6

Step 2: Final measurement

With the frequencies determined in step 1, the final measurement will be performed.

EMI receiver settings:

- Detector: Quasi-Peak
- IF - Bandwidth: 9 kHz
- Measuring time: 1s / frequency

At the final test the cable were and moved within the range of positions likely to find their maximum emission.

After the measurement a plot will be generated which contains a diagram with the results of the preliminary scan and a chart with the frequencies and values of the results of the final measurement.



4.2 Occupied Bandwidth

Standard FCC Part 15, 10-1-98
Subpart C

The test was performed according to: ANSI C63.4 1992

4.2.1 Test Description

The test set-up was made in accordance to the general provisions of ANSI C63.4-1992.

The Equipment Under Test (EUT) was setup in a shielded room to perform the occupied bandwidth measurements.

The reference level is the level of the highest amplitude signal observed from the transmitter at either the fundamental frequency or first-order modulation products in all typical modes of operation, including the unmodulated carrier, even if atypical.

The results recorded were measured with the modulation which produce the worst-case (widest) occupied bandwidth.

The resolution bandwidth for measuring the reference level and the occupied bandwidth was 10 kHz.

The reference level of the spectrum analyser was set equal to the reference level of the EUT.

4.2.2 Test Limits

FCC Part 15, Subpart C, §15.247 (a) (1) (ii)

(1) Frequency hopping systems operating in the 2400 - 2483.5 MHz band should use at least 75 hopping frequencies.

(2) The average time of occupancy on any frequency should not be greater than 0.4 seconds within a 30 second period.

(3) The maximum 20 dB bandwidth of the hopping channel is 1MHz.

4.2.3 Test Protocol

Temperature: 21 °C

Air Pressure: 1024 hPa

Humidity: 54 %

Op. Mode	Setup	Port	Test Parameter
op-mode 1	setup 1	Antenna port	
20 dB Bandwidth MHz	Remarks		
0,715	none		

Remark: none



Temperature: 21 °C
Air Pressure: 1024 hPa
Humidity: 54 %

Op. Mode	Setup	Port	Test Parameter
op-mode 2	setup 1	Antenna port	
20 dB Bandwidth MHz	Remarks		
0,721	none		

Remark: none

Temperature: 21 °C
Air Pressure: 1024 hPa
Humidity: 54 %

Op. Mode	Setup	Port	Test Parameter
op-mode 3	setup 1	Antenna port	
20 dB Bandwidth MHz	Remarks		
0,721	none		

Remark: none

Temperature: 21 °C
Air Pressure: 1024 hPa
Humidity: 54 %

Op. Mode	Setup	Port	Test Parameter
op-mode 6	setup 1	Antenna port	
20 dB Bandwidth MHz	Remarks		
0,606	none		

Remark: none

Temperature: 21 °C
Air Pressure: 1024 hPa
Humidity: 54 %

Op. Mode	Setup	Port	Test Parameter
op-mode 7	setup 1	Antenna port	
20 dB Bandwidth MHz	Remarks		
0,438	none		

Remark: none



4.2 .4 Test result: Occupied Bandwidth

FCC Part 15, Subpart C	Op. Mode	Setup	Port	Result
	op-mode 1	setup 1	Antenna port	passed
	op-mode 2	setup 1	Antenna port	passed
	op-mode 3	setup 1	Antenna port	passed
	op-mode 6	setup 1	Antenna port	passed
	op-mode 7	setup 1	Antenna port	passed



Temperature: 21 °C
Air Pressure: 1024 hPa
Humidity: 54 %

Op. Mode	Setup	Port	Test Parameter
op-mode 2	setup 1	Antenna port	
Output Power dBm	Remarks		
-0,48	The EIRP including antenna gain (3.5 dBi) is 3,02 dBm		

Remark: none

Temperature: 21 °C
Air Pressure: 1024 hPa
Humidity: 54 %

Op. Mode	Setup	Port	Test Parameter
op-mode 3	setup 1	Antenna port	
Output Power dBm	Remarks		
-1,65	The EIRP including antenna gain (3.5 dBi) is 1,85 dBm		

Remark: none

4.3 .4 Test result: Peak Power Output

FCC Part 15, Subpart C	Op. Mode	Setup	Port	Result
	op-mode 1	setup 1	Antenna port	passed
	op-mode 2	setup 1	Antenna port	passed
	op-mode 3	setup 1	Antenna port	passed

4.4 Spurious RF Conducted Emissions

Standard FCC Part 15, 10-1-98
Subpart C

The test was performed according to: FCC §15.31 10-1-1998

4.4.1 Test Description

The Equipment Under Test (EUT) was set up in a shielded room to perform the output power measurements

The EUT was connected to spectrum analyzer via a short coax cable (Type: Rosenberger RTK 161, 1m, SMA connectors), with a known loss.

Analyser settings:

- Detector: Peak-Maxhold
- Frequency range: 30 – 25000 MHz
- Resolution Bandwidth (RBW): 100 kHz
- Video Bandwidth (VBW): 100 kHz
- Sweep Time: Coupled

The reference level of the spectrum analyser was set equal to the reference level of the EUT.

4.4.2 Test Limits

FCC Part 15, Subpart C, §15.247(c)

(1) All harmonics/spurs must be at least 20dB below the highest emission level within the authorized band as measured with a 100kHz RBW, based on either RF conducted or radiated measurement.

4.4.3 Test Protocol

Temperature: 21 °C
Air Pressure: 1024 hPa
Humidity: 54 %

Op. Mode	Setup	Port	Test Parameter			
op-mode 1	setup 1	Antenna port				
Frequency MHz	Measured Value dBm	Correction Factor dB	Corrected Value	Reference Value dB	Limit dBm	Delta to Limit dB
0,00	0,00	0,00	0,00	0,00	0,00	0,00

Remark: No spurious emission above noise level found



Temperature: 21 °C
 Air Pressure: 1024 hPa
 Humidity: 54 %

Op. Mode	Setup	Port	Test Parameter			
op-mode 2	setup 1	Antenna port				
Frequency MHz	Measured Value dBm	Correction Factor dB	Corrected Value	Reference Value dB	Limit dBm	Delta to Limit dB
0,00	0,00	0,00	0,00	0,00	0,00	0,00

Remark: No spurious emission above noise level found

Temperature: 21 °C
 Air Pressure: 1024 hPa
 Humidity: 54 %

Op. Mode	Setup	Port	Test Parameter			
op-mode 3	setup 1	Antenna port				
Frequency MHz	Measured Value dBm	Correction Factor dB	Corrected Value	Reference Value dB	Limit dBm	Delta to Limit dB
0,00	0,00	0,00	0,00	0,00	0,00	0,00

Remark: No spurious emission above noise level found

4.4 .4 Test result: Spurious RF Conducted Emissions

FCC Part 15, Subpart C	Op. Mode	Setup	Port	Result
	op-mode 1	setup 1	Antenna port	passed
	op-mode 2	setup 1	Antenna port	passed
	op-mode 3	setup 1	Antenna port	passed

4.5 Spurious Radiated Emissions

Standard FCC Part 15, 10-1-98
Subpart C

The test was performed according to: ANSI C63.4 1992

4.5.1 Test Description

The test set-up was made in accordance to the general provisions of ANSI C63.4-1992.

The Equipment Under Test (EUT) was set up on a non-conductive table 1.0 x 2.0 m in the semi-anechoic chamber. The test was performed at an EUT to receiving antenna distance of 3m.

The radiated emissions measurements was made in a typical installation configuration.

The measurement procedure consists of four steps. It is implemented into EMI test software ES-K1 from R&S.

Step 1: Preliminary scan

Preliminary test to identify the highest amplitudes relative to the limit.

Settings for step 1:

- Detector: Peak-Maxhold
- Frequency range: 30 – 1000 MHz
- Frequency steps: 60 kHz
- IF-Bandwidth: 120 kHz
- Measuring time / Frequency step: 100 μ s
- Turntable angle range: -180 to 180 °
- Turntable stepsize: 90 °
- Height variation range: 1 – 3m
- Height variation stepsize: 2m
- Polarisation: Horizontal + Vertical

Intention of this step is, to determine the radiated EMI-profile of the EUT. With this data, the test system performs (to reduce the number of final measurements) a data reduction with the following parameters:

- Offset for acceptance analysis: Limit line – 10 dB
- Maximum number of final measurements: 12

Step 2:

With the frequencies determined in step 1, an additional measurement with the following settings will be performed. Intention of this step is, to find out the approximate turntable angle and antenna height for each frequency.

Settings for step 2:

- Detector: Peak – Maxhold
- Measured frequencies: in step 1 determined frequencies
- IF – Bandwidth: 120 kHz
- Measuring time: 100ms
- Turntable angle range: -180 to 180 °
- Turntable stepsize: 45 °
- Height variation range: 1 – 5m
- Height variation stepsize: 0,5m
- Polarisation: horizontal + vertical

After this step the EMI test system has determined the following values for each frequency (of step 1):

- Frequency
- Azimuth value (of turntable)
- Antenna height

The last two values have now the following accuracy:

- Azimuth value (of turntable): 45°
- Antenna height: 0,5m

Step 3:

In this step the accuracy of the turntable azimuth and antenna height will be improved. This is necessary to find out the maximum value of every frequency.

For each frequency the turntable azimuth and antenna height, which was determined in step 3, will be adjusted.

The turntable azimuth will be slowly varied by +/- 22,5° around this value. During this action the value of emission is continuously measured. The turntable azimuth at the highest emission will be recorded and adjusted. In this position the antenna height is also slowly varied by +/- 25 cm around the antenna height determined in step 3. During this action the value of emission is also continuously measured. The antenna height of the highest emission will also be recorded and adjusted.

Settings for step 3:

- Detector: Peak – Maxhold
- Measured frequencies: in step 1 determined frequencies
- IF – Bandwidth: 120 kHz
- Measuring time: 100ms
- Turntable angle range: -22,5° to + 22,5 ° around the value determined in step 2
- Height variation range: -0,25m to + 0,25m around the value determined in step 2

Step 4:

With the settings determined in step 3, the final measurement will be performed:

EMI receiver settings for step 4:

- Detector: Quasi-Peak(< 1GHz)
- Measured frequencies: in step 1 determined frequencies
- IF – Bandwidth: 120 kHz
- Measuring time: 1s

The following modifications apply to the measurement procedure for the frequency range

above 1 GHz:

The measurement distance was reduced to 1m. The results were extrapolated by the extrapolation factor of 20 dB/decade (invers linear-distance for field strength measurements, invers linear-distance squared for the power reference level measurements). Due to the fact that in this frequency range a double ridged wave guided horn antenna (up to 18 Ghz) and a horn antenna (18-25 GHz) are used, the steps 2-4 are omitted. Step 1 was performed with one height of the receiving antenna only.

Detector: Peak, Average

RBW = VBW = 1 MHz, above 7 GHz 100 kHz



After the measurement a plot will be generated which contains a diagram with the results of the preliminary scan and a chart with the frequencies and values of the results of the final measurement.

4. 5 .2 Test Limits

FCC Part 15, Subpart C, §15.247(c)

(2) A radiated emission test applies to harmonic/spurs that fall in the restricted bands as listed in § 15.205(a). The maximum permitted QP (< 1GHz) and average (> 1GHz) field strength is listed in § 15.209(a).

(3)

FCC Part 15, Subpart C, §15.209, Radiated Emission Limits

Frequency Range (MHz):	Class B Limit (dBµV/m)
30 – 88	40,0
88 – 216	43,5
216 – 960	46,0
above 960	54,0

§15.35(b)

..., there is also a limit on the radio frequency emissions, as measured using instrumentation with a peak detector function, corresponding to 20 dB above the maximum permitted average limit....

Used conversion factor: Limit (dBµV/m) = 20 log (Limit (µV/m)/1µV/m)

4. 5 .3 Test Protocol

Temperature: 21 °C
 Air Pressure: 1024 hPa
 Humidity: 54 %

Op. Mode **Setup** **Port** **Test Parameter**

op-mode 1 setup 1 enclosure

Polarisation	Frequency MHz	Corrected Value dBµV/m			Limit QP/AV dBµV/m	Limit Peak dBµV/m	Delta to AV/QP Limit/dB	Delta to Peak Limit dB
		QP	Peak	AV				
Vertical	1201,00	0,00	47,76	34,46	54,00	74,00	-40,12	-44,02
Vertical	3603,00	0,00	49,04	40,64	54,00	74,00	13,36	24,96
Vertical	4583,00	0,00	61,62	47,31	54,00	74,00	6,69	12,38
Vertical	4803,50	0,00	59,68	48,37	54,00	74,00	5,63	14,32
Vertical	4987,50	0,00	58,14	36,07	54,00	74,00	17,93	15,86
Vertical	8406,50	0,00	59,49	46,19	54,00	74,00	7,81	14,51
Vertical	10808,50	0,00	66,81	52,18	54,00	74,00	1,82	7,19
Vertical	12010,50	0,00	55,65	43,96	54,00	74,00	10,04	18,35
Vertical	14475,50	0,00	54,40	42,79	54,00	74,00	11,21	19,60
Vertical	17700,00	0,00	58,01	46,90	54,00	74,00	7,10	15,99
Vertical	18214,50	0,00	48,50	35,50	54,00	74,00	18,50	25,50
Vertical	19665,00	0,00	49,19	36,10	54,00	74,00	17,90	24,81
Vertical	20758,50	0,00	48,97	35,70	54,00	74,00	18,30	25,03
Vertical	21391,00	0,00	50,85	37,40	54,00	74,00	16,60	23,15
Vertical	22214,00	0,00	50,82	37,20	54,00	74,00	16,80	23,18
Vertical	23859,00	0,00	52,87	39,20	54,00	74,00	14,80	21,13

Remark: none

Temperature: 21 °C
 Air Pressure: 1024 hPa
 Humidity: 54 %

Op. Mode **Setup** **Port** **Test Parameter**
 op-mode 2 setup 1 enclosure

Polarisation	Frequency MHz	Corrected Value dBµV/m			Limit QP/AV dBµV/m	Limit Peak dBµV/m	Delta to AV/QP Limit/dB	Delta to Peak Limit dB
		QP	Peak	AV				
Vertical	1220,50	0,00	45,39	37,40	54,00	74,00	16,60	28,61
Vertical	2291,50	0,00	48,04	34,05	54,00	74,00	19,95	25,96
Vertical	3661,00	0,00	45,90	34,10	54,00	74,00	19,90	28,10
Vertical	4583,00	0,00	58,48	47,49	54,00	74,00	6,51	15,52
Vertical	4882,00	0,00	59,90	48,31	54,00	74,00	5,69	14,10
Vertical	5017,00	0,00	58,70	35,70	54,00	74,00	18,30	15,30
Vertical	7323,00	0,00	52,30	42,12	54,00	74,00	11,88	21,70
Vertical	10984,00	0,00	64,31	50,75	54,00	74,00	3,25	9,69
Vertical	12205,00	0,00	54,43	43,15	54,00	74,00	10,85	19,57
Vertical	14472,00	0,00	54,40	42,62	54,00	74,00	11,38	19,60
Vertical	17701,00	0,00	59,25	46,88	54,00	74,00	7,12	14,75
Vertical	18213,00	0,00	48,33	35,60	54,00	74,00	18,40	25,67
Vertical	19703,00	0,00	49,33	36,20	54,00	74,00	17,80	24,67
Vertical	20499,50	0,00	49,20	35,40	54,00	74,00	18,60	24,80
Vertical	21374,50	0,00	50,80	37,40	54,00	74,00	16,60	23,20
Vertical	22032,50	0,00	50,99	36,80	54,00	74,00	17,20	23,01
Vertical	23630,50	0,00	52,59	39,00	54,00	74,00	15,00	21,41

Remark: none



Temperature: 21 °C
 Air Pressure: 1024 hPa
 Humidity: 54 %

Op. Mode **Setup** **Port** **Test Parameter**
 op-mode 3 setup 1 enclosure

Polarisation	Frequency MHz	Corrected Value dBµV/m			Limit QP/AV dBµV/m	Limit Peak dBµV/m	Delta to AV/QP Limit/dB	Delta to Peak Limit dB
		QP	Peak	AV				
Vertical	1146,00	0,00	46,47	35,35	54,00	74,00	18,65	27,53
Vertical	1240,00	0,00	47,42	34,78	54,00	74,00	19,22	26,58
Vertical	2291,00	0,00	50,42	34,01	54,00	74,00	19,99	23,58
Vertical	3720,00	0,00	48,37	36,93	54,00	74,00	17,07	25,63
Vertical	4583,00	0,00	57,43	46,61	54,00	74,00	7,39	16,57
Vertical	4904,00	0,00	55,82	34,27	54,00	74,00	19,73	18,18
Vertical	4960,00	0,00	61,58	53,71	54,00	74,00	0,29	12,42
Vertical	5043,00	0,00	57,40	35,57	54,00	74,00	18,43	16,60
Vertical	7439,50	0,00	54,10	40,85	54,00	74,00	13,15	19,90
Vertical	11159,50	0,00	60,92	46,48	54,00	74,00	7,52	13,08
Vertical	12400,50	0,00	56,22	43,94	54,00	74,00	10,06	17,78
Vertical	14500,00	0,00	54,29	42,65	54,00	74,00	11,35	19,71
Vertical	16119,00	0,00	57,18	43,81	54,00	74,00	10,19	16,82
Vertical	17700,00	0,00	58,52	46,90	54,00	74,00	7,10	15,48
Vertical	19705,00	0,00	49,54	36,10	54,00	74,00	17,90	24,46
Vertical	20669,50	0,00	49,18	35,60	54,00	74,00	18,40	24,82
Vertical	21374,00	0,00	51,07	37,40	54,00	74,00	16,60	22,93
Vertical	22257,00	0,00	50,90	37,30	54,00	74,00	16,70	23,10
Vertical	22953,00	0,00	51,29	37,60	54,00	74,00	16,40	22,71
Vertical	23906,50	0,00	52,84	39,30	54,00	74,00	14,70	21,16

Remark: none

4.5 .4 Test result: Spurious Radiated Emissions

FCC Part 15, Subpart C	Op. Mode	Setup	Port	Result
	op-mode 1	setup 1	enclosure	passed
	op-mode 2	setup 1	enclosure	passed
	op-mode 3	setup 1	enclosure	passed

4.6 Dwell Time

Standard FCC Part 15, 10-1-98
Subpart C

The test was performed according to: FCC §15.31 10-1-1998

4.6.1 Test Description

The Equipment Under Test (EUT) was set up in a shielded room to perform the output power measurements.

The reference level of the spectrum analyser was set equal to the output power of the EUT.

The EUT was connected to the spectrum analyzer via a short coax cable (Type: Rosenberger RTK 161, 1m, SMA connectors), with a known loss.

To determine the dwell time, 3 single measurements are necessary. The first plot shows the activity for a complete inquiry/paging on one channel. The second plot shows the repetition rate on one channel, and the third plot shows the duration of the burst used in inquiry/paging.

With these 3 single values the dwell time of the channel can be calculated.

4.6.2 Test Limits

FCC Part 15, Subpart C, §15.247 (g)

The dwell time of the channel shall be less than 400 ms in a XX s period

4.6.3 Test Protocol

Temperature: 21 °C
Air Pressure: 1024 hPa
Humidity: 54 %

Op. Mode	Setup	Port	Test Parameter
op-mode 6	setup 1	Antenna port	
Dwell time ms	Remarks		
55,73	none		

Remark: none



Temperature: 21 °C
Air Pressure: 1024 hPa
Humidity: 54 %

Op. Mode	Setup	Port	Test Parameter
op-mode 7	setup 1	Antenna port	
Dwell time ms	Remarks		
29,22	none		

Remark: none

4.6 .4 Test result: Dwell Time

FCC Part 15, Subpart C	Op. Mode	Setup	Port	Result
	op-mode 6	setup 1	Antenna port	passed
	op-mode 7	setup 1	Antenna port	passed

4.7 Power Density

Standard FCC Part 15, 10-1-98
Subpart C

The test was performed according to: FCC §15.31 10-1-1998

4.7.1 Test Description

The Equipment Under Test (EUT) was set up in a shielded room to perform the output power measurements

The EUT was connected to spectrum analyzer via a short coax cable (Type: Rosenberger RTK 161, 1m, SMA connectors), with a known loss.

The Analyser settings are according 15.247 (d):

- Detector: Peak-Maxhold
- Span: 2 MHz
- Resolution Bandwidth (RBW): 3 kHz
- Video Bandwidth (VBW): 3 kHz
- Sweep Time: Coupled

The reference level of the spectrum analyser was set equal to the reference level of the EUT.

4.7.2 Test Limits

FCC Part 15, Subpart C, §15.247 (g)

The power density shall be below 8 dBm measured with a resolution bandwidth of 3 kHz.

4.7.3 Test Protocol

Temperature: 21 °C
Air Pressure: 1024 hPa
Humidity: 54 %

Op. Mode	Setup	Port	Test Parameter
op-mode 6	setup 1	Antenna port	
Power Density dBm	Remarks		
-13,55	none		

Remark: none



Temperature: 21 °C
Air Pressure: 1024 hPa
Humidity: 54 %

Op. Mode	Setup	Port	Test Parameter
op-mode 7	setup 1	Antenna port	
Power Density dBm	Remarks		
-17,56	none		

Remark: none

4.7 .4 Test result: Power Density

FCC Part 15, Subpart C	Op. Mode	Setup	Port	Result
	op-mode 6	setup 1	Antenna port	passed
	op-mode 7	setup 1	Antenna port	passed

4.8 Channel Separation

Standard FCC Part 15, 10-1-98
Subpart C

The test was performed according to: FCC §15.31 10-1-1998

4.8.1 Test Description

The Equipment Under Test (EUT) was set up in a shielded room to perform the output power measurements

The EUT was connected to spectrum analyzer via a short coax cable (Type: Rosenberger RTK 161, 1m, SMA connectors), with a known loss.

Analyser settings:

- Detector: Peak-Maxhold
- Span: 10 MHz
- Resolution Bandwidth (RBW): 300 kHz
- Video Bandwidth (VBW): 300 kHz
- Sweep Time: Coupled

The reference level of the spectrum analyser was set equal to the reference level of the EUT.

4.8.2 Test Limits

4.8.3 Test Protocol

Temperature: 21 °C
Air Pressure: 1024 hPa
Humidity: 54 %

Op. Mode	Setup	Port	Test Parameter
op-mode 4	setup 1	Antenna port	

Channel Separation MHz	Remarks
1,022	none

Remark: none

4.8.4 Test result: Channel Separation

FCC Part 15, Subpart C	Op. Mode	Setup	Port	Result
	op-mode 4	setup 1	Antenna port	passed

5. Testequipment

EUT Digital Signaling System

Equipment	Type	Serial No.	Manufacturer	Cal due
Digital Radio Communication Tester	CMD 55	831050/020	Rohde & Schwarz	17.06.01

EMI Test System

Equipment	Type	Serial No.	Manufacturer	Cal due
EMI Analyzer	ESI 26	830482/004	Rohde & Schwarz	29.06.01
Signal Generator	SMR 20	846834/008	Rohde & Schwarz	26.07.02
Comparison Noise Emitter	CNE III	99/016	York	04.05.01

EMI Radiated Auxiliary Equipment

Equipment	Type	Serial No.	Manufacturer	Cal due
High Pass Filter	4HC1600/12750-1.	9942011	Trilithic	02.11.00
Loop Antenna	HFH2-Z2	829324/006	Rohde & Schwarz	16.06.01
Cable "ESI to Horn Antenna"	RTK 081	W18.04+3599/001	Rosenberger	09.12.00
Double-ridged horn	HF 906	357357/002	Rohde & Schwarz	18.05.01
Double-ridged horn	HF 906	357357/001	Rohde & Schwarz	18.05.01
Broadband Amplifier 45MHz-27GHz	JS4-00102600-42-5	619368	Miteq	
Log.-per. Antenna	HL 562 Ultralog	830547/003	Rohde & Schwarz	04.10.01
High Pass Filter	5HC2700/12750-1.	9942012	Trilithic	02.11.00
Pyramidal Horn Antenna 26,5 GHz	Model 3160-09	9910-1184	EMCO	22.08.01
Cable "ESI to EMI Antenna"	RTK081+Aircell7	W18.01+W38.01a	Huber+Suhner	09.12.00
Biconical dipole	VUBA 9117	9117108	Schwarzbeck	03.06.01

EMI Conducted Auxiliary Equipment

Equipment	Type	Serial No.	Manufacturer	Cal due
Two-Line V-Network	ESH 3-Z5	829996/002	Rohde & Schwarz	22.06.01
Cable "LISN to ESI"	RG214	W18.03+W48.03	Huber+Suhner	14.09.00
Two-Line V-Network	ESH 3-Z5	828304/029	Rohde & Schwarz	22.06.01

Auxiliary Test Equipment

Equipment	Type	Serial No.	Manufacturer	Cal due
Digital Multimeter 02	Voltcraft M-3860M	IJ095955	Conrad	03.06.01
Digital Multimeter 01	Voltcraft M-3860M	IJ096055	Conrad	03.06.01
Digital Oscilloscope	TDS 784C	B021311	Tektronix	26.05.01
Fibre optic link Transceiver	FO RS232 Link	182-018	Pontis	
Notch Filter ultra stable	WRCA800/960-6EE	24	Wainwright	03.02.03
Broadband Resist. Power Divider SMA	1515 / 93459	LN673	Weinschel	
Broadband Resist. Power Divider N	1506A / 93459	LM390	Weinschel	
Signal Generator	SMIQ 03B	832492/061	Rohde & Schwarz	09.11.00
I/Q Modulation Generator	AMIQ-B1	832085/018	Rohde & Schwarz	27.10.00
Temperature Chamber	VT 4002	58566002150010	Vötsch	
Temperature Chamber	S-1.2C-B	393/25-1389-27RF	Thermotron	23.05.03
Fibre optic link Satellite	FO RS232 Link	181-018	Pontis	

6. Foto Report

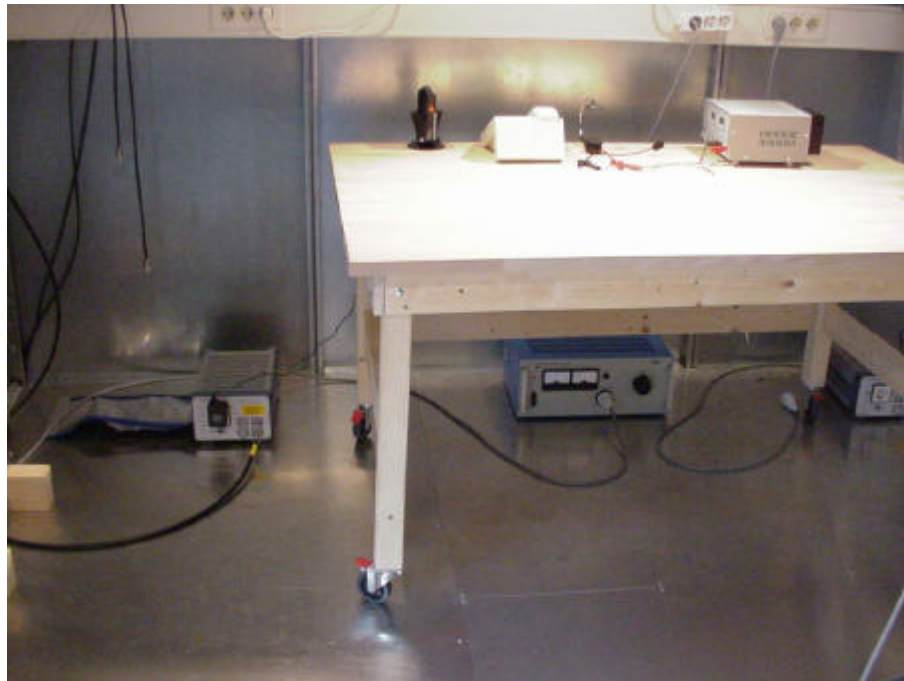

Picture 1 : Setup for AC mains measurements (front view)

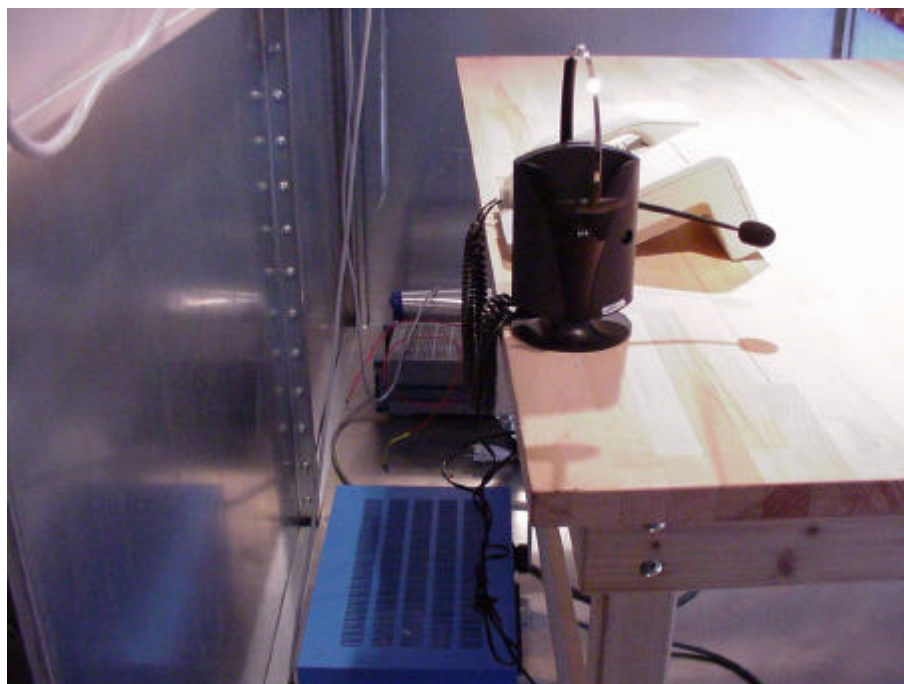

Picture 2 : Setup for AC mains measurements rear view)

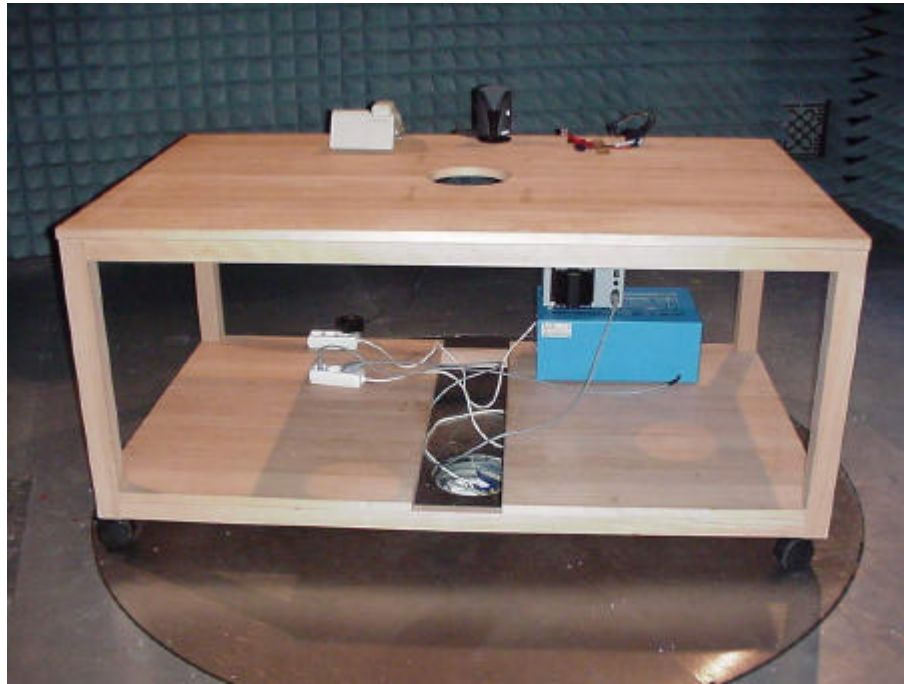

Picture 3 : Setup for radiated measurements, front view



Picture 4 : Setup for radiated measurements, rear view

7. Setup Drawings

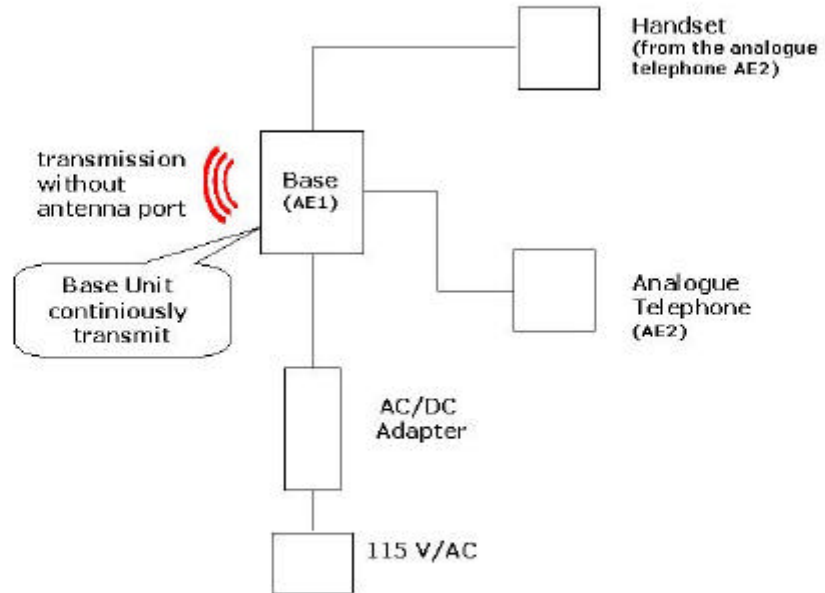

Drawin 1 : Setup for radiated measurements

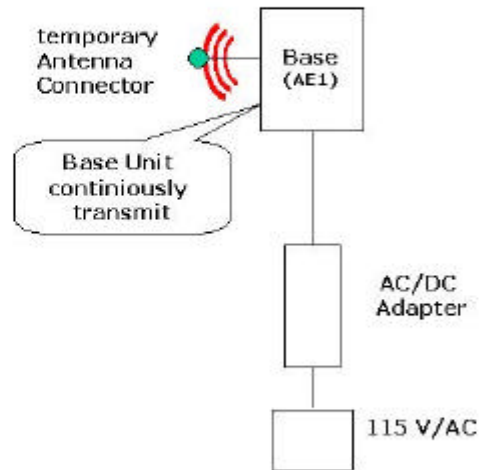

Drawin 2 : Setup for measurements on the antenna connector

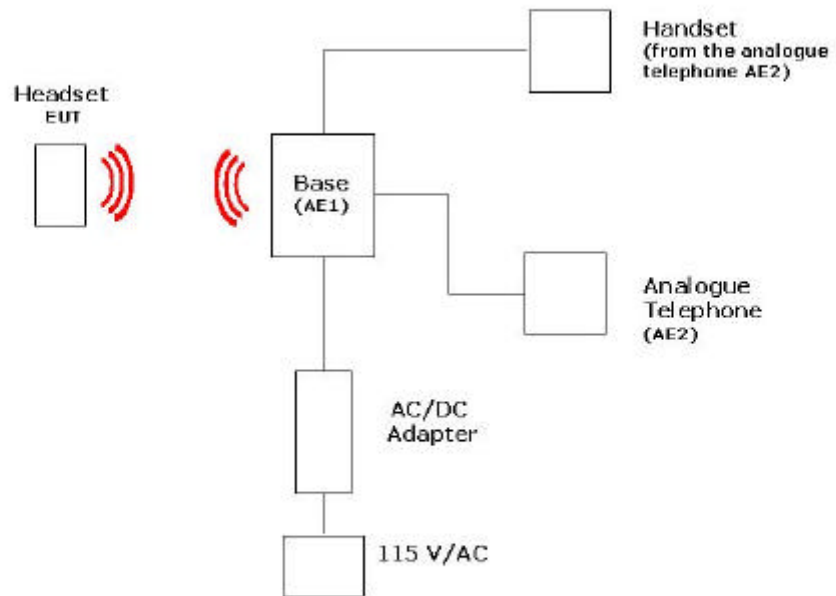

Drawin 3 : Setup for emission measurement on the ac mains

8. Annex

Occupied Bandwidth

Op. Mode Setup Port
 op-mode 1 setup 1 Antenna port

	Delta 2 [T1]	RBW	10 kHz	RF Att	30 dB
Ref Lvl	-20.64 dB	VBW	30 kHz		
21.2 dBm	342.68537074 kHz	SWT	76 ms	Unit	dBm

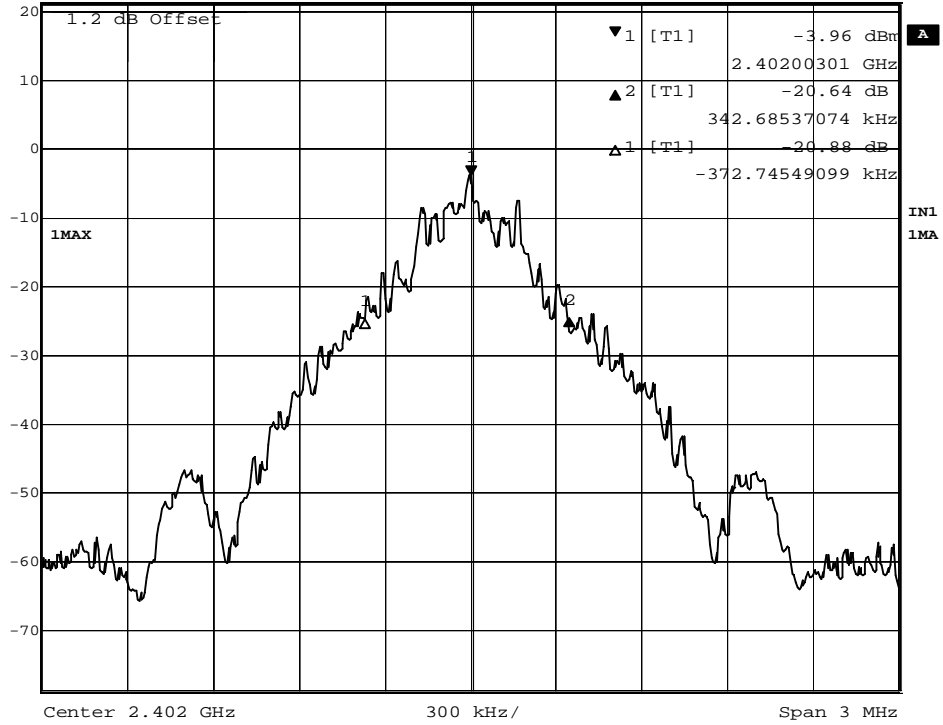

Date: 26.SEP.2000 11:00:48

20 dB Bandwidth: TX = 2402 MHz



Op. Mode Setup Port
op-mode 2 setup 1 Antenna port

Delta 2 [T1]	RBW	10 kHz	RF Att	30 dB
Ref Lvl	-23.53 dB	VBW	30 kHz	
21.2 dBm	348.69739479 kHz	SWT	76 ms	Unit dBm

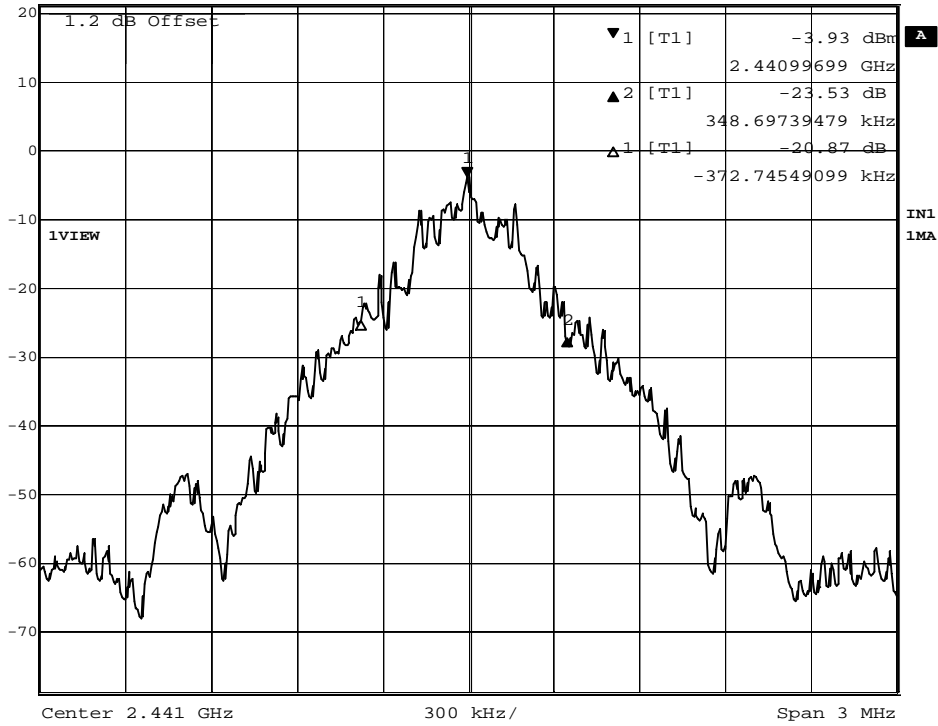

Date: 26.SEP.2000 10:57:50

20 dB Bandwidth: TX = 2441 MHz

Op. Mode Setup Port
 op-mode 3 setup 1 Antenna port

	Delta 2 [T1]	RBW	10 kHz	RF Att	30 dB
Ref Lvl	-20.94 dB	VBW	30 kHz		
21.2 dBm	330.66132265 kHz	SWT	76 ms	Unit	dBm

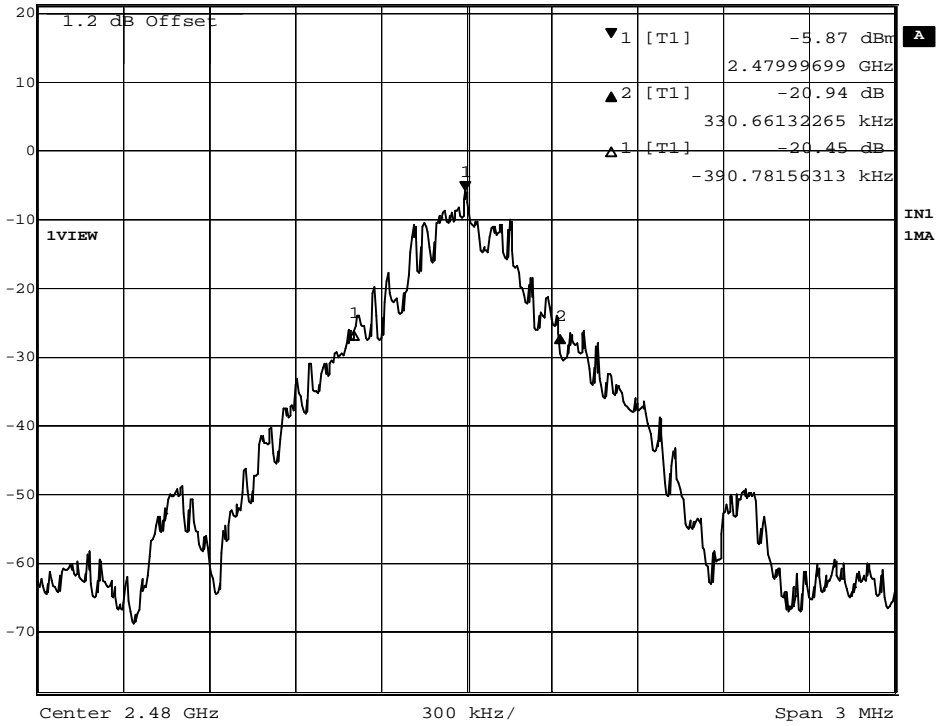

Date: 26.SEP.2000 11:03:48

20 dB Bandwidth: TX = 2480 MHz



Op. Mode Setup Port
op-mode 6 setup 1 Antenna port

Delta 2 [T1 NOI] RBW 10 kHz RF Att 30 dB
Ref Lvl -20.85 dB VBW 30 kHz
0.9 dBm 282.56513026 kHz SWT 76 ms Unit dBm

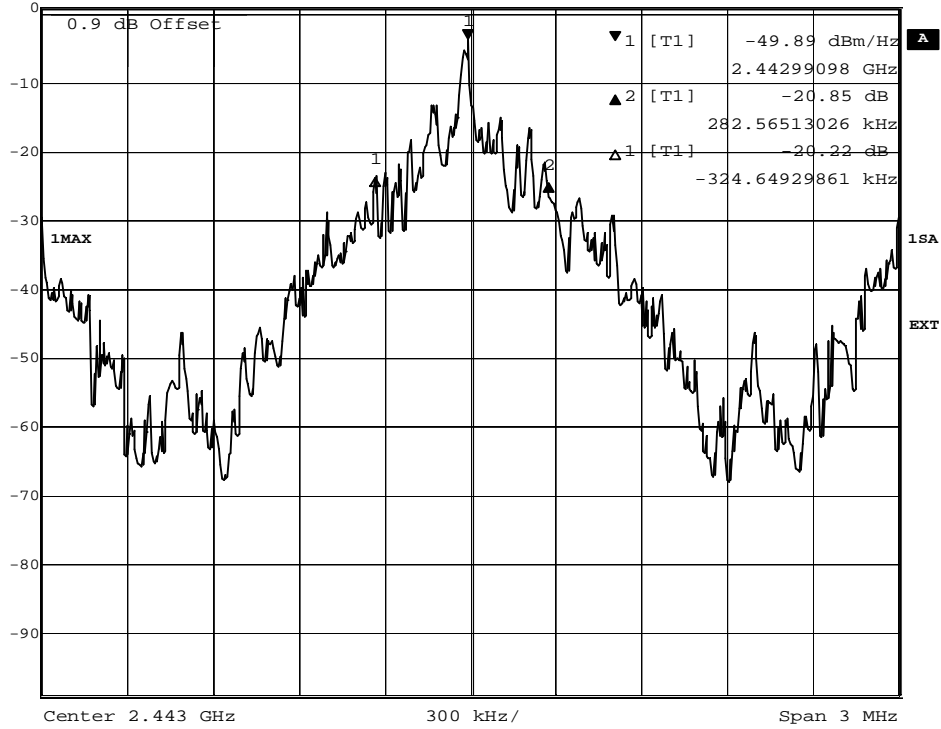

Date: 4.SEP.2000 11:46:14

20 dB Bandwidth: EUT is in inquiry mode

Op. Mode Setup Port
 op-mode 7 setup 1 Antenna port



Marker 1 [T1]	RBW	10 kHz	RF Att	40 dB
Ref Lvl	-4.81 dBm	VBW	30 kHz	
22.6 dBm	2.44198497 GHz	SWT	76 ms	Unit dBm

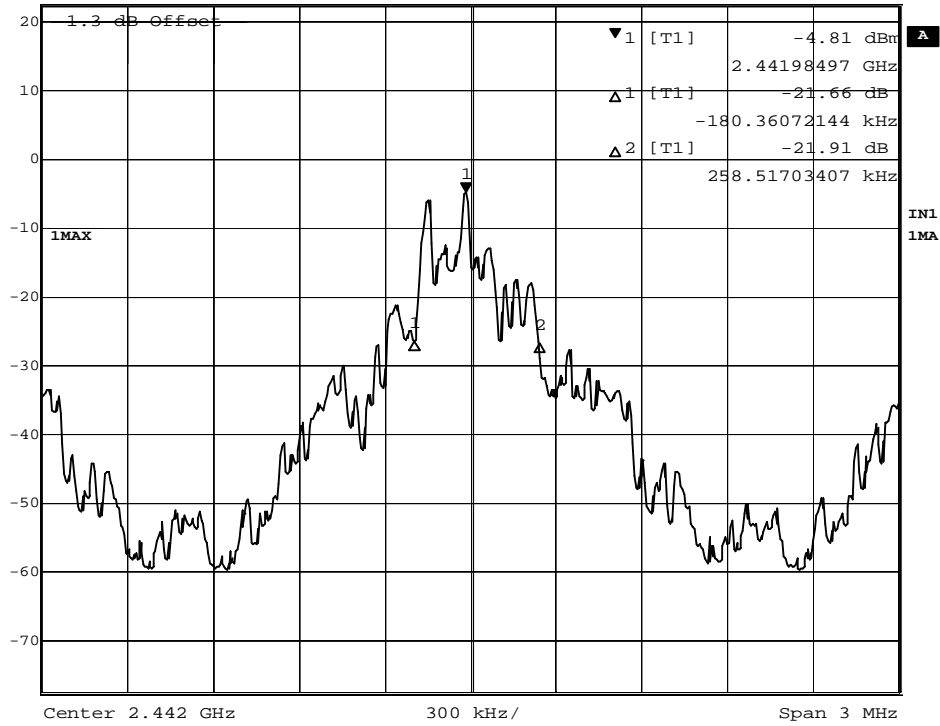

Date: 9.SEP.2000 16:53:45

20 dB Bandwidth: EUT is in page mode



Peak Power Output

Op. Mode Setup Port
op-mode 1 setup 1 Antenna port

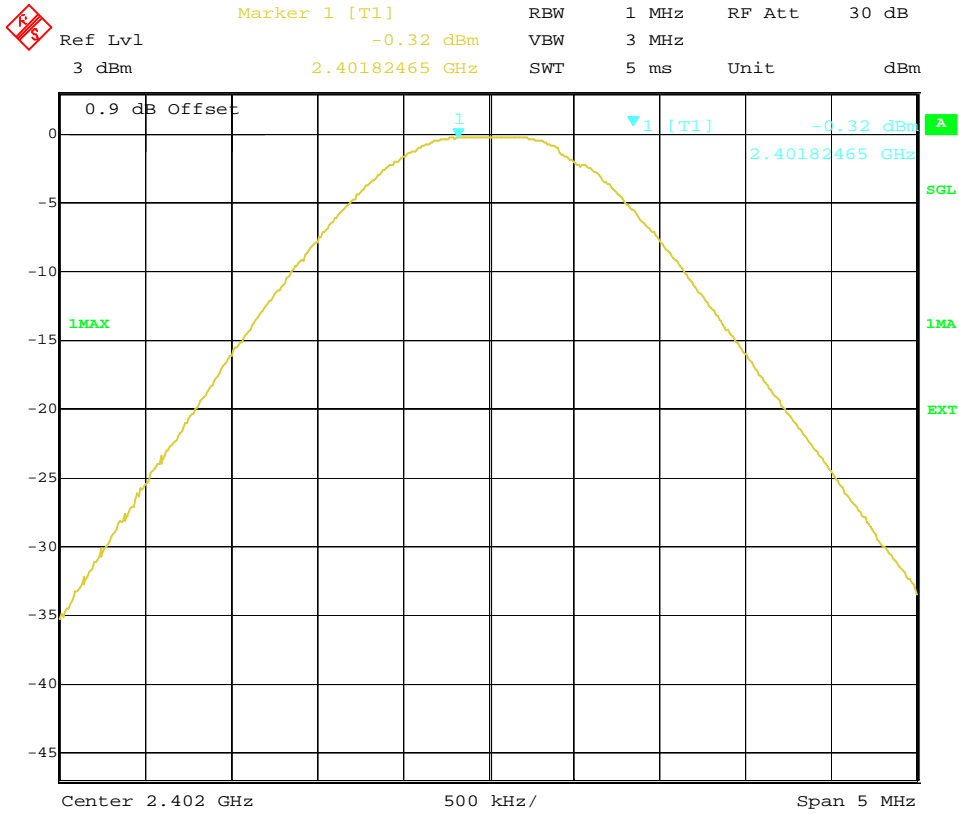

Date: 18.AUG.2000 14:17:36

Output Power: TX = 2402 MHz



Op. Mode Setup Port
op-mode 2 setup 1 Antenna port

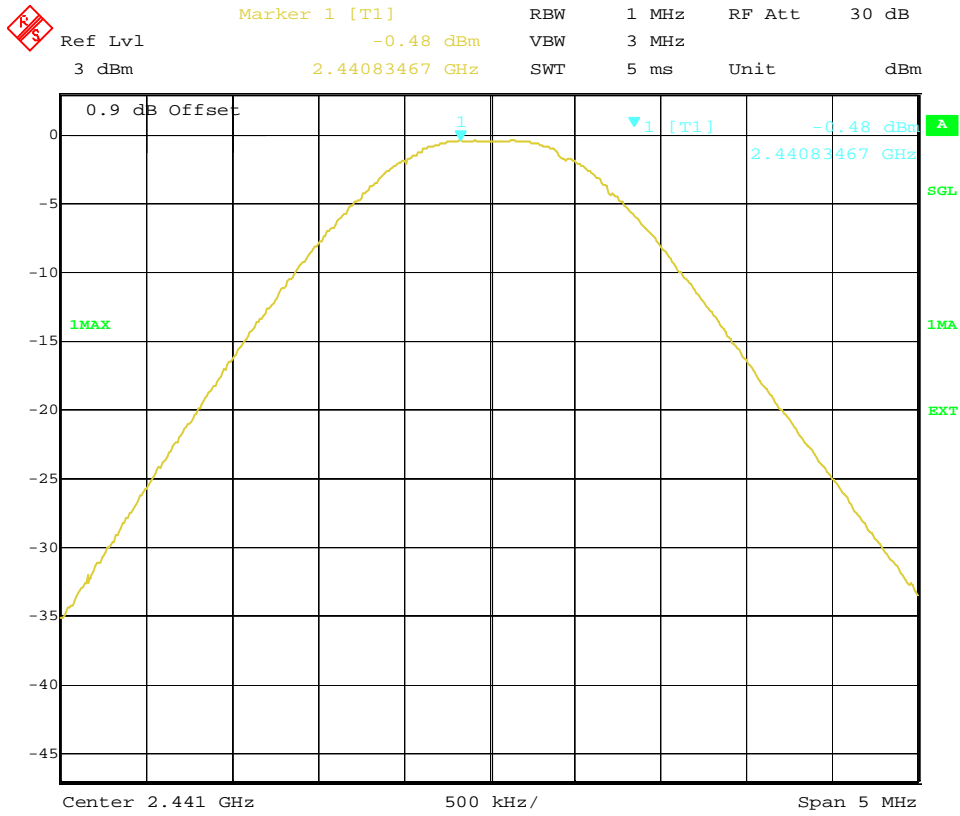

Date: 18.AUG.2000 14:19:06

Output Power: TX = 2441 MHz



Op. Mode Setup Port
op-mode 3 setup 1 Antenna port

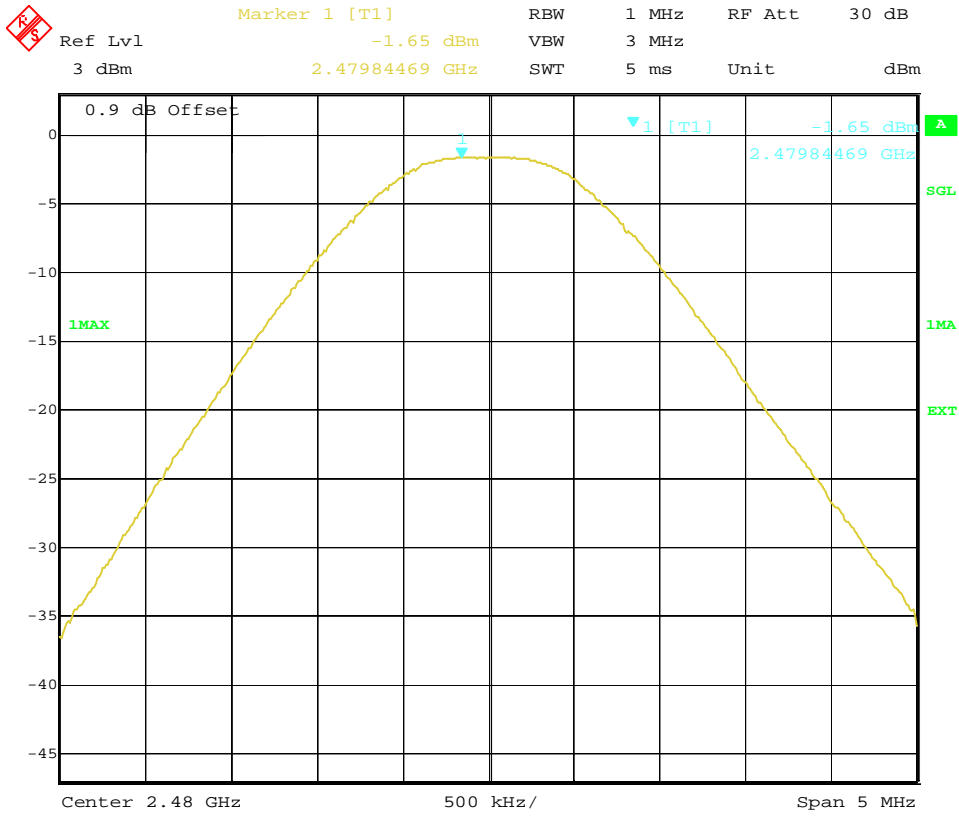

Date: 18.AUG.2000 14:19:54

Output Power: TX = 2480 MHz



Delta 2 [T1] RBW 100 kHz RF Att 30 dB
 Ref Lvl -53.14 dB VBW 300 kHz
 3.9 dBm 3.34669339 MHz SWT 21 ms Unit dBm

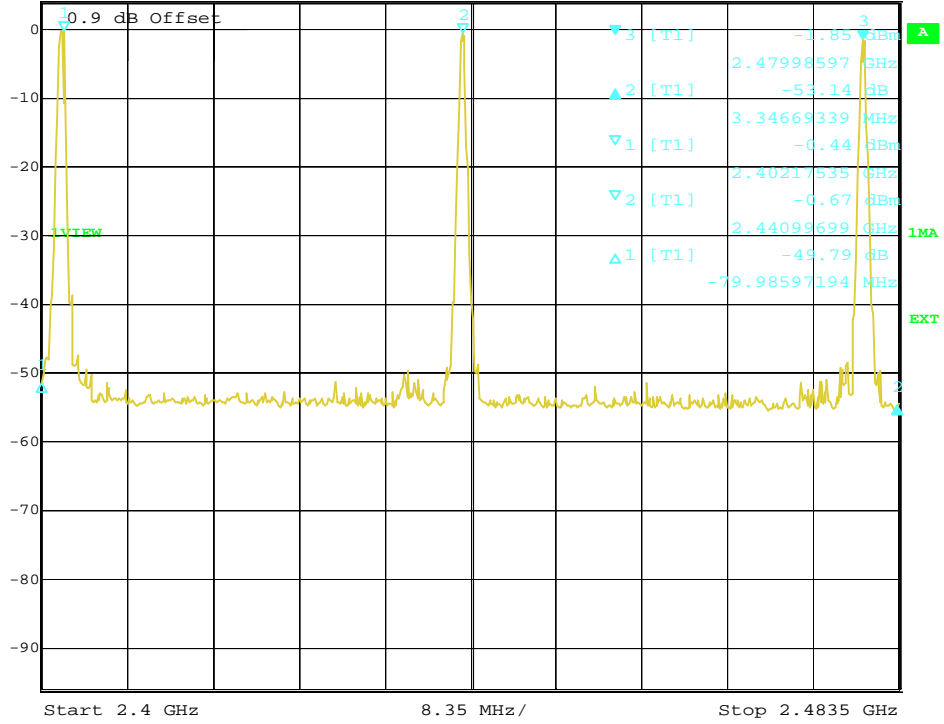

Date: 18.AUG.2000 14:44:53

Band-Edge Compliance

Op. Mode Setup Port
 op-mode 2 setup 1 Antenna port



Marker 1 [T1] RBW 100 kHz RF Att 30 dB
 Ref Lvl -0.33 dBm VBW 300 kHz
 3 dBm 2.43192385 GHz SWT 330 s Unit dBm

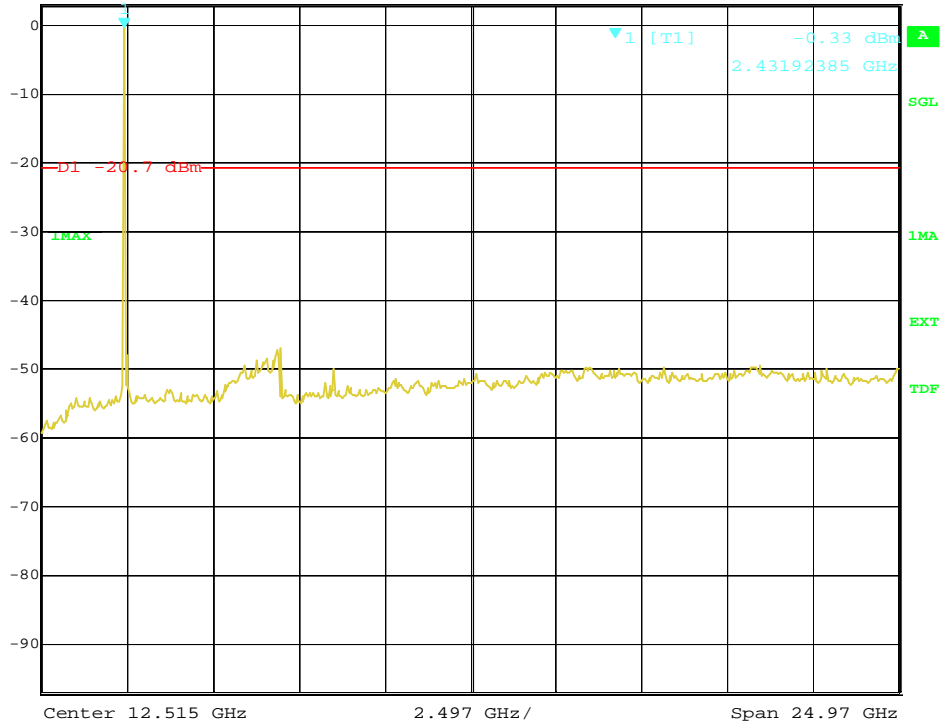

Date: 18.AUG.2000 15:56:28

Spurious Emissions: TX = 2441 MHz



Delta 2 [T1] RBW 100 kHz RF Att 30 dB
 Ref Lvl -53.14 dB VBW 300 kHz
 3.9 dBm 3.34669339 MHz SWT 21 ms Unit dBm

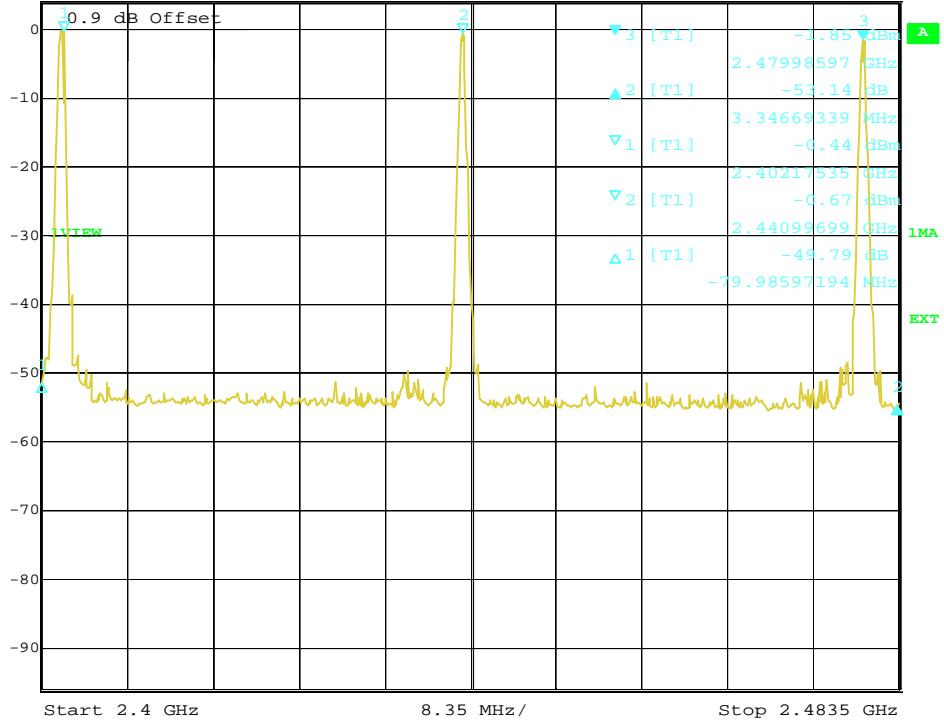

Date: 18.AUG.2000 14:44:53

Band-Edge Compliance

Op. Mode Setup Port
 op-mode 3 setup 1 Antenna port



Marker 1 [T1] RBW 100 kHz RF Att 30 dB
 Ref Lvl -1.79 dBm VBW 300 kHz
 3 dBm 2.48196393 GHz SWT 330 s Unit dBm

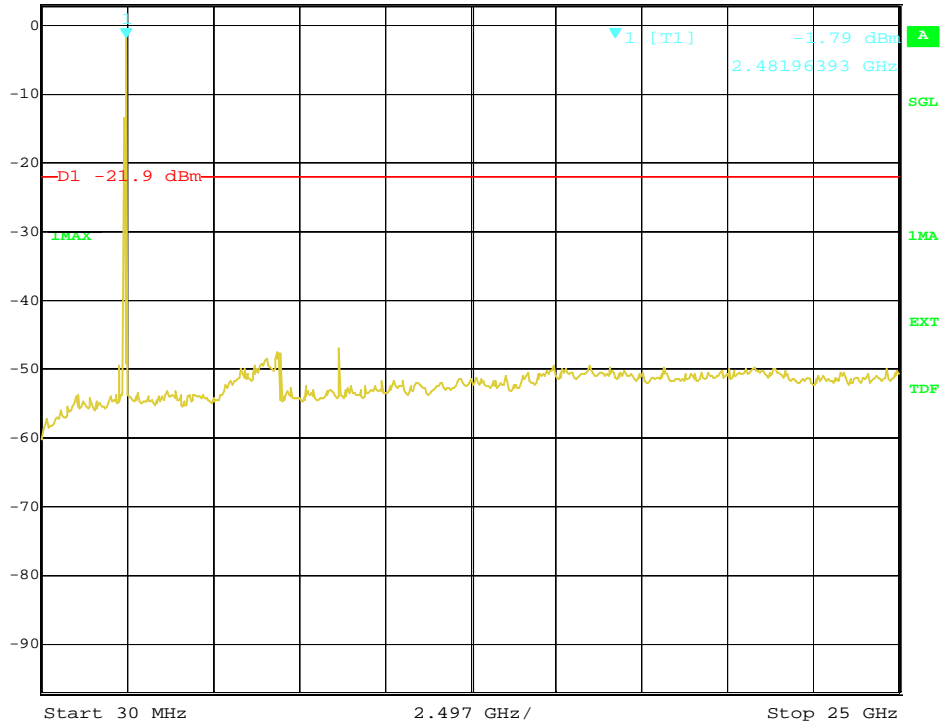

Date: 18.AUG.2000 15:13:21

Spurious Emissions: TX = 2402 MHz



Delta 2 [T1] RBW 100 kHz RF Att 30 dB
 Ref Lvl -53.14 dB VBW 300 kHz
 3.9 dBm 3.34669339 MHz SWT 21 ms Unit dBm

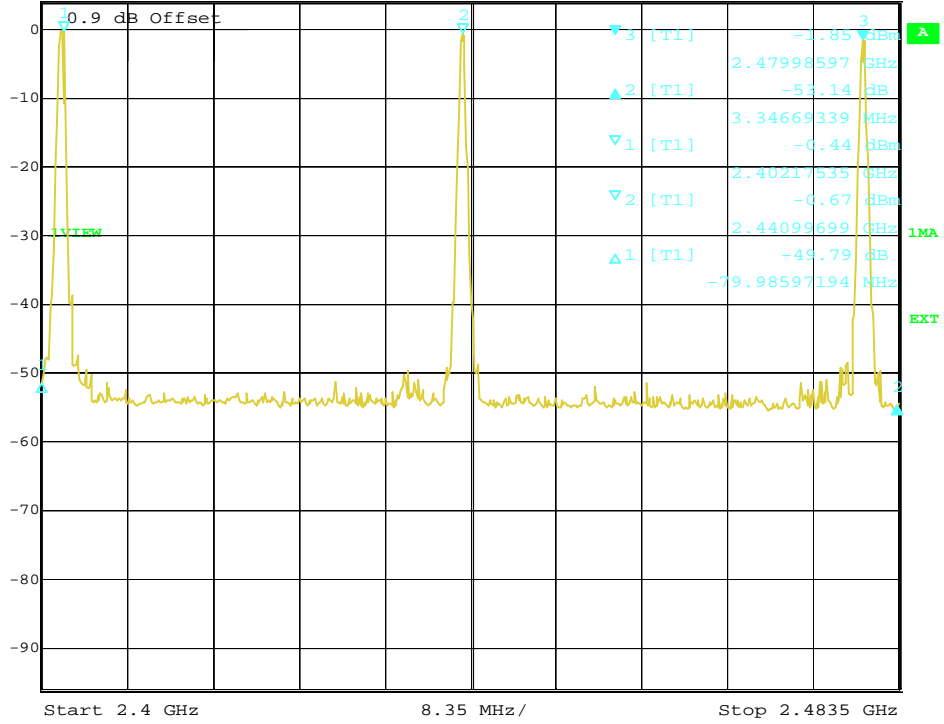

Date: 18.AUG.2000 14:44:53

Band-Edge Compliance

Dwell Time

Op. Mode Setup Port
 op-mode 6 setup 1 Antenna port

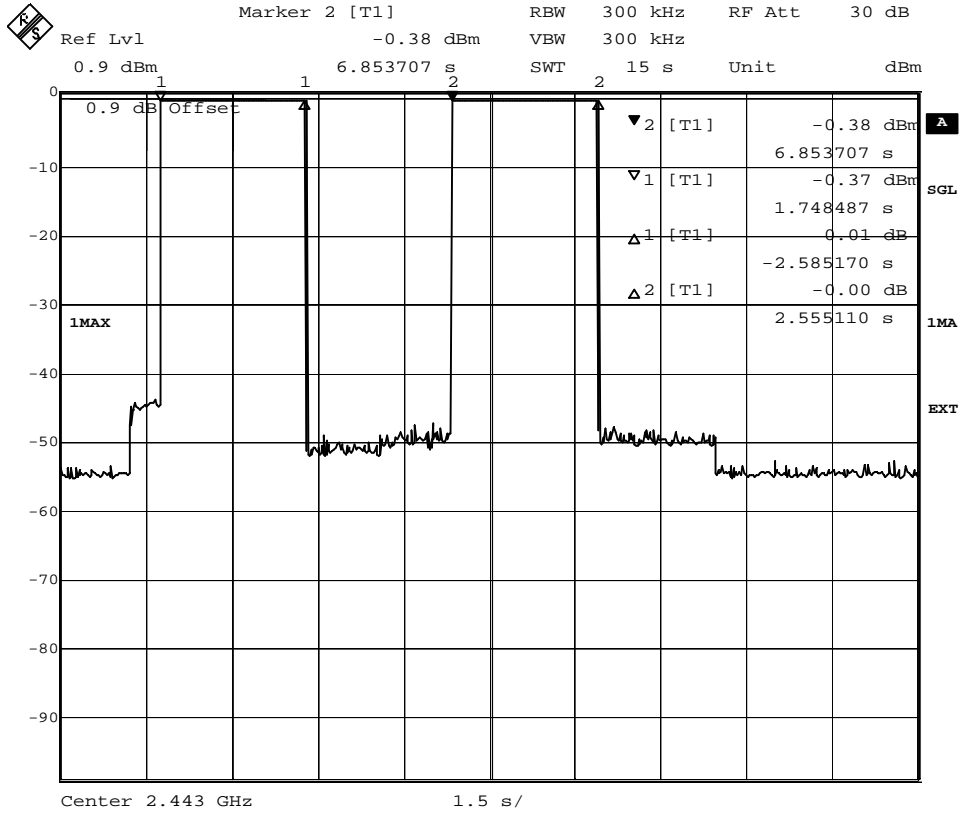

Date: 4.SEP.2000 11:29:58

Dwell time: EUT is in inquiry mode

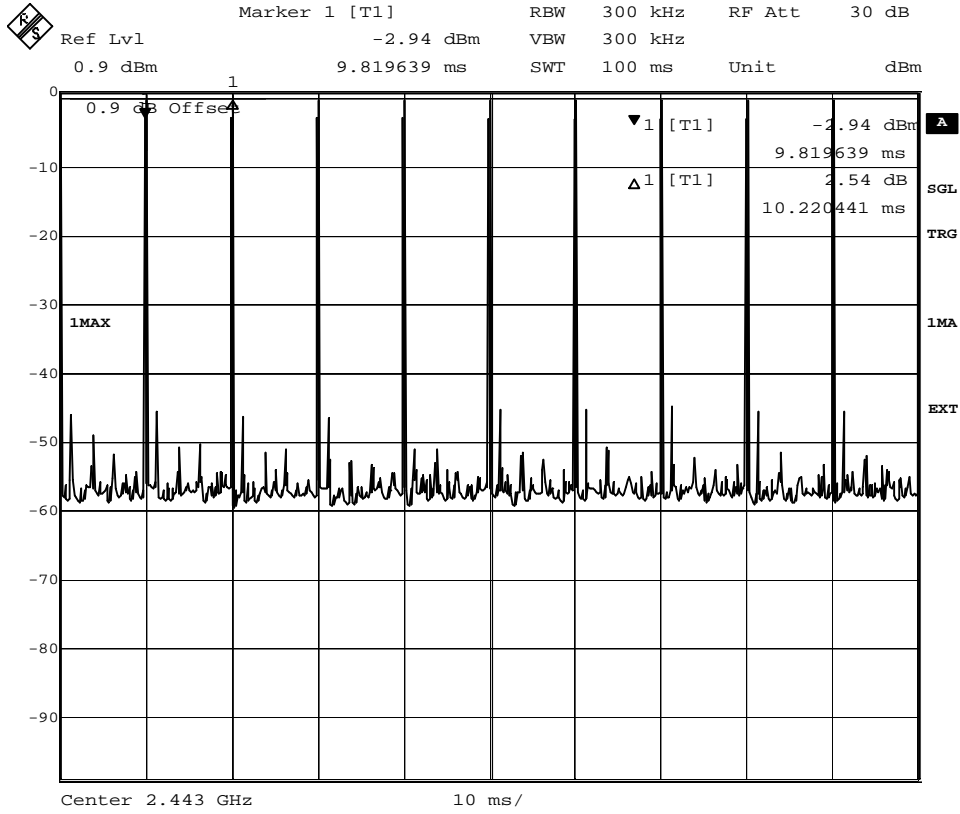

Date: 4.SEP.2000 11:33:14

Dwell time: EUT is in inquiry mode

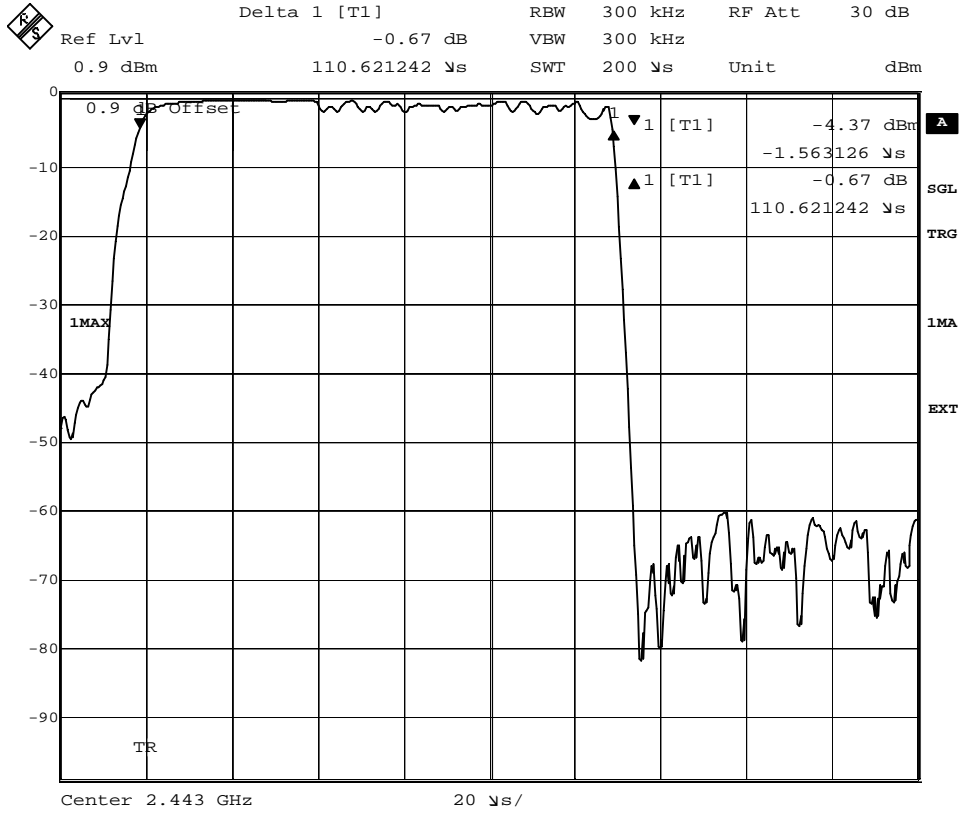

Date: 4.SEP.2000 11:35:38

Dwell time: EUT is in inquiry mode

Op. Mode Setup Port
 op-mode 7 setup 1 Antenna port

 Delta 2 [T1] RBW 300 kHz RF Att 40 dB
 Ref Lvl -43.05 dB VBW 300 kHz
 20 dBm 1.352705 s SWT 15 s Unit dBm

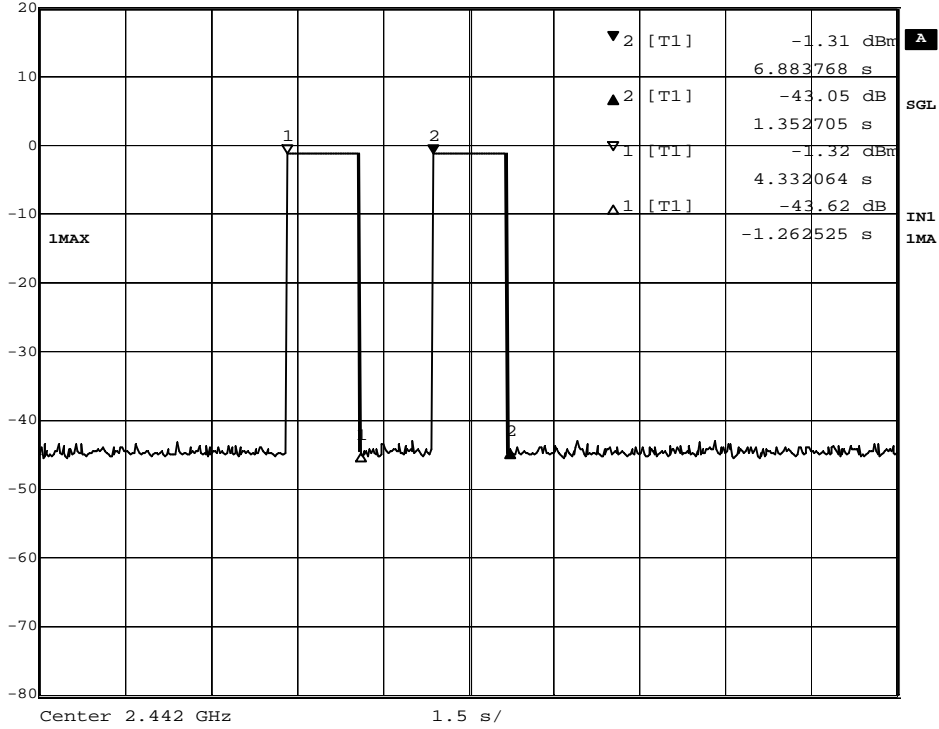

Date: 9.SEP.2000 16:22:09

Dwell time: EUT is in page mode

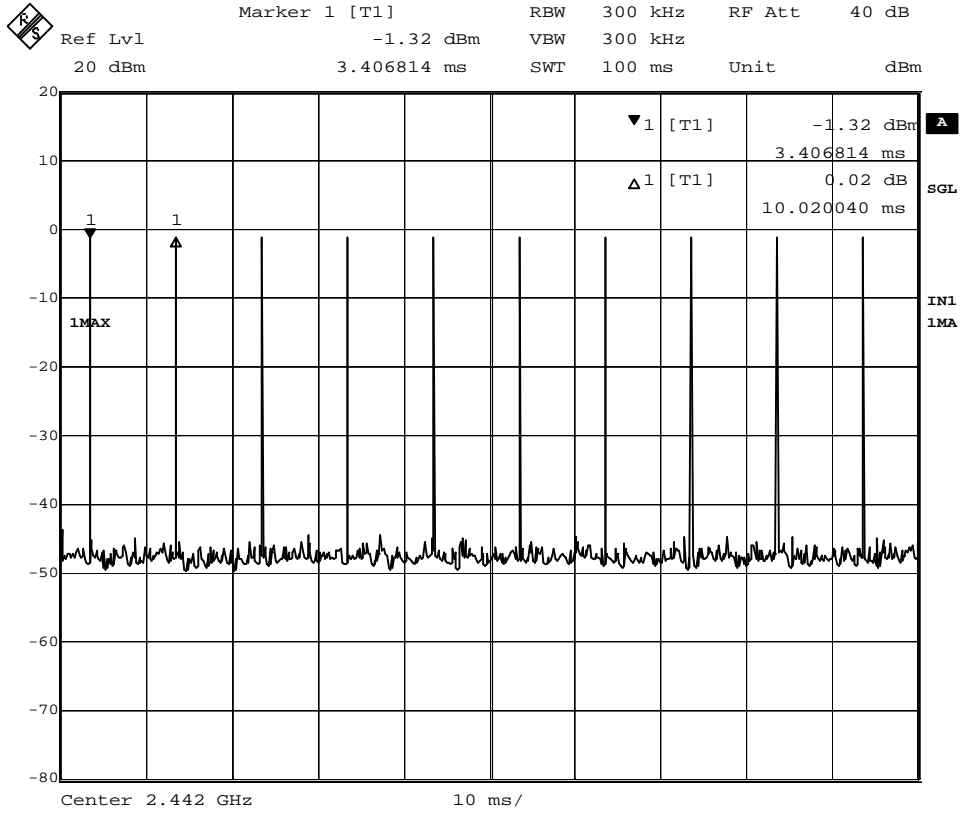

Date: 9.SEP.2000 16:20:17

Dwell time: EUT is in page mode

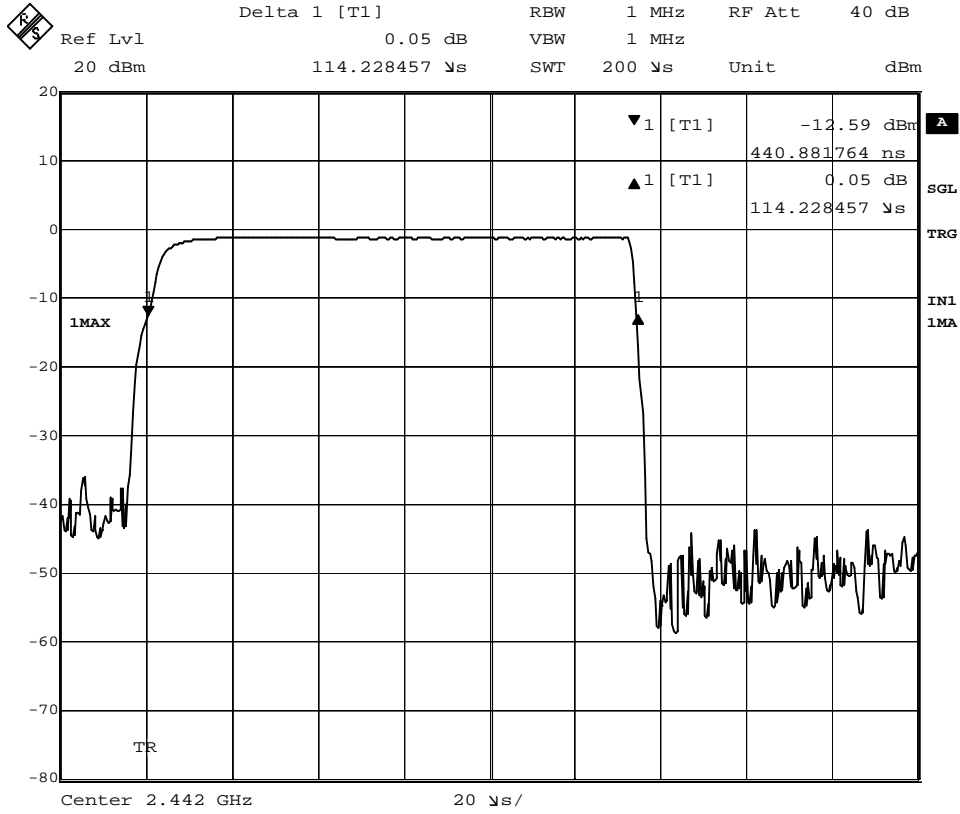

Date: 9.SEP.2000 16:31:00

Dwell time: EUT is in page mode

Power Density

Op. Mode Setup Port
 op-mode 6 setup 1 Antenna port

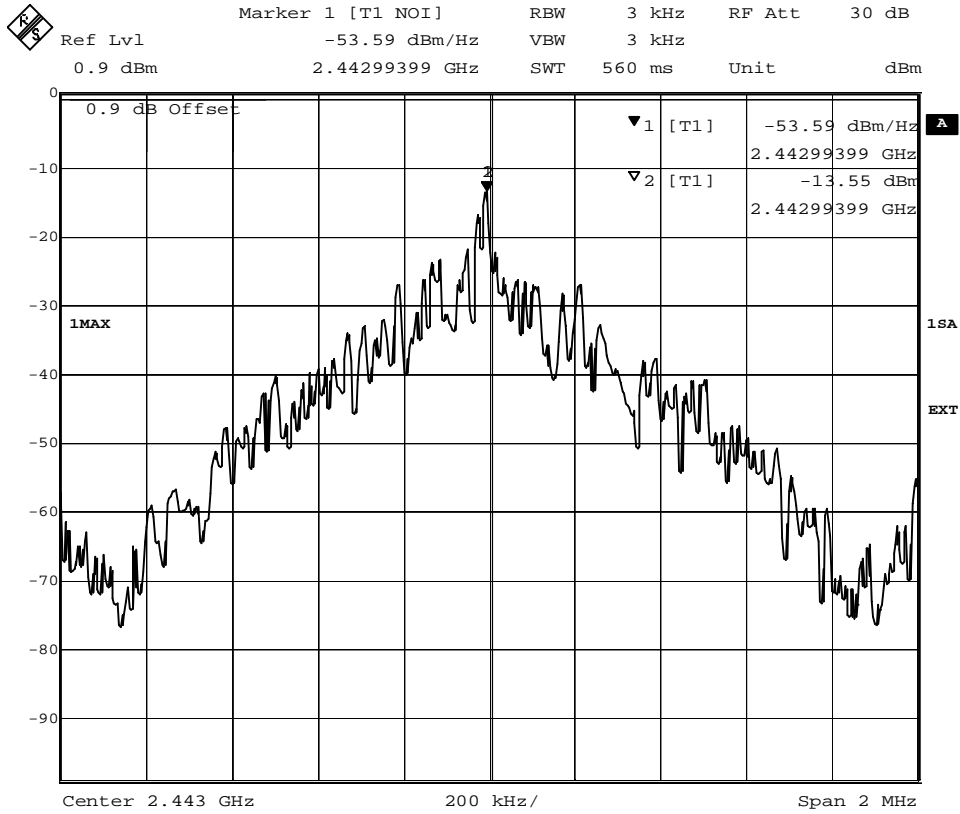

Date: 4.SEP.2000 11:41:36

Power Density: EUT is in inquiry mode

Op. Mode Setup Port
 op-mode 7 setup 1 Antenna port

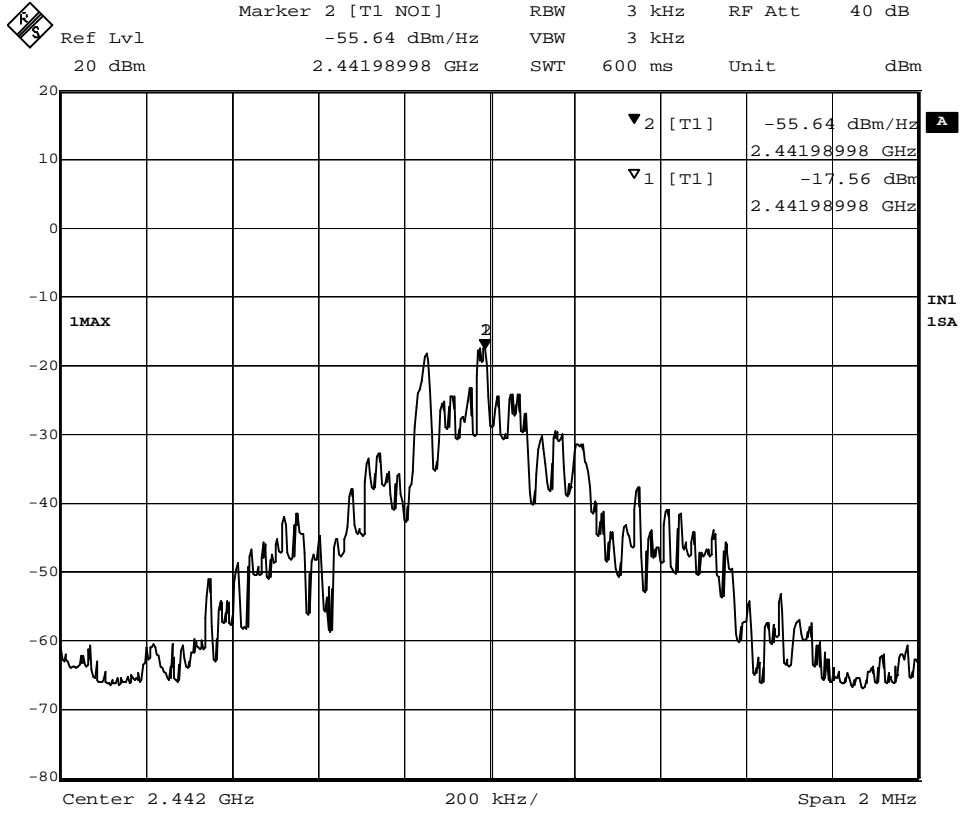

Date: 9.SEP.2000 16:41:32

Power density: EUT is in page mode

Channel Separation

Op. Mode Setup Port
 op-mode 4 setup 1 Antenna port

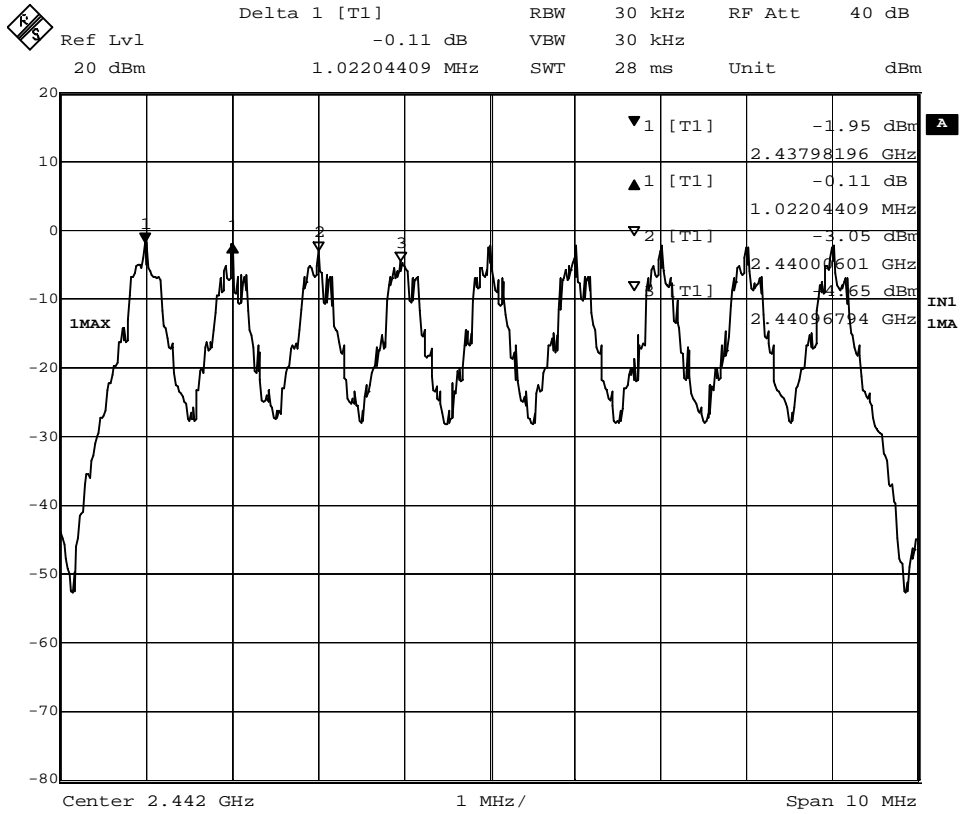

Date: 9.SEP.2000 17:04:08

Channel separation