

SAR Test Report

Report No.: AGC00767180503FH01

FCC ID : P46-VOLT5XL
APPLICATION PURPOSE : Original Equipment
PRODUCT DESIGNATION : Smartphone
BRAND NAME : SURGE
MODEL NAME : VOLT_5XL
CLIENT : Unimax Communications
DATE OF ISSUE : July 12,2018
STANDARD(S) : IEEE Std. 1528:2013
FCC 47CFR § 2.1093
IEEE/ANSI C95.1:2005
REPORT VERSION : V1.0

Attestation of Global Compliance(Shenzhen) Co., Ltd.

CAUTION:

This report shall not be reproduced except in full without the written permission of the test laboratory and shall not be quoted out of context.



The results shown in this test report refer only to the sample(s) tested unless otherwise stated and the sample(s) are retained for 30 days only. The document is issued by AGC, this document cannot be reproduced except in full with our prior written permission. The more details and the authenticity of the report will be confirmed at <http://www.agc-cert.com>.

Report Revise Record

Report Version	Revise Time	Issued Date	Valid Version	Notes
V1.0	/	July 12,2018	Valid	Initial Release

The results shown in this test report refer only to the sample(s) tested unless otherwise stated and the sample(s) are retained for 30 days only. The document is issued by AGC, this document cannot be reproduced except in full with our prior written permission. The more details and the authenticity of the report will be confirmed at <http://www.agc-cert.com>.

Test Report Certification

Applicant Name	Unimax Communications
Applicant Address	18201 McDermott St. West Suite E, Irvine, CA 92614
Manufacturer Name	Shenzhen TENSEN Industrial Co., Ltd.
Manufacturer Address	4th Floor, Yufeng Building, Jinhai Road No.6-9, Xixiang Street, Bao'an District, Shenzhen
Product Designation	Smartphone
Brand Name	SURGE
Model Name	VOLT_5XL
EUT Voltage	DC3.8V by battery
Applicable Standard	IEEE Std. 1528:2013 FCC 47CFR § 2.1093 IEEE/ANSI C95.1:2005
Test Date	June 25,2018 to July 09,2018
Report Template	AGCRT-US-4G/SAR (2018-01-01)

Note: The results of testing in this report apply to the product/system which was tested only.

Eric Zhou

Tested By _____

Eric Zhou(Zhou Yongkang) July 09,2018

Angela Li

Checked By _____

Angela Li(Li Jiao) July 12,2018

Forrest Lei

Authorized By _____

Forrest Lei(Lei Yonggang) July 12,2018
 Authorized Officer

The results shown in this test report refer only to the sample(s) tested unless otherwise stated and the sample(s) are retained for 30 days only. The document is issued by AGC, this document cannot be reproduced except in full with our prior written permission. The more details and the authenticity of the report will be confirmed at <http://www.agc-cert.com>.

TABLE OF CONTENTS

1. SUMMARY OF MAXIMUM SAR VALUE 5

2. GENERAL INFORMATION..... 6

 2.1. EUT DESCRIPTION..... 6

3. SAR MEASUREMENT SYSTEM..... 8

 3.1. THE SATIMO SYSTEM USED FOR PERFORMING COMPLIANCE TESTS CONSISTS OF FOLLOWING ITEMS 8

 3.2. COMOSAR E-FIELD PROBE 9

 3.3. ROBOT..... 9

 3.4. VIDEO POSITIONING SYSTEM 10

 3.5. DEVICE HOLDER 10

 3.6. SAM TWIN PHANTOM..... 11

4. SAR MEASUREMENT PROCEDURE..... 12

 4.1. SPECIFIC ABSORPTION RATE (SAR)..... 12

 4.2. SAR MEASUREMENT PROCEDURE 13

 4.3. RF EXPOSURE CONDITIONS 15

5. TISSUE SIMULATING LIQUID..... 17

 5.1. THE COMPOSITION OF THE TISSUE SIMULATING LIQUID..... 17

 5.2. TISSUE DIELECTRIC PARAMETERS FOR HEAD AND BODY PHANTOMS 17

 5.3. TISSUE CALIBRATION RESULT 18

6. SAR SYSTEM CHECK PROCEDURE 21

 6.1. SAR SYSTEM CHECK PROCEDURES 21

 6.2. SAR SYSTEM CHECK..... 22

7. EUT TEST POSITION..... 24

 7.1. DEFINE TWO IMAGINARY LINES ON THE HANDSET..... 24

 7.2. CHEEK POSITION 25

 7.3. TILT POSITION..... 25

 7.4. BODY WORN POSITION 26

8. SAR EXPOSURE LIMITS 27

9. TEST FACILITY 28

10. TEST EQUIPMENT LIST 29

11. MEASUREMENT UNCERTAINTY 30

12. CONDUCTED POWER MEASUREMENT..... 33

13. TEST RESULTS 56

 13.1. SAR TEST RESULTS SUMMARY..... 56

APPENDIX A. SAR SYSTEM CHECK DATA 75

APPENDIX B. SAR MEASUREMENT DATA..... 107

APPENDIX C. TEST SETUP PHOTOGRAPHS..... 163

APPENDIX D. CALIBRATION DATA 171

The results shown in this test report refer only to the sample(s) tested unless otherwise stated and the sample(s) are retained for 30 days only. The document is issued by AGC, this document cannot be reproduced except in full with our prior written permission. The more details and the authenticity of the report will be confirmed at <http://www.agc-cert.com>.

1. SUMMARY OF MAXIMUM SAR VALUE

The maximum results of Specific Absorption Rate (SAR) found during testing for EUT are as follows:

Frequency Band	Highest Reported 1g-SAR(W/Kg)		SAR Test Limit (W/Kg)
	Head	Body-worn	
GSM 850	0.387	0.994	1.6
PCS 1900	0.250	1.335	
UMTS Band II	0.618	1.381	
UMTS Band IV	0.634	1.360	
UMTS Band V	0.280	0.485	
LTE Band 2	0.413	1.336	
LTE Band 4	0.735	1.315	
LTE Band 5	0.276	0.519	
LTE Band 12	0.035	0.118	
WIFI 2.4G	0.199	0.138	
Simultaneous Reported SAR	1.519		
SAR Test Result	PASS		

This device is compliance with Specific Absorption Rate (SAR) for general population/uncontrolled exposure limits (1.6W/Kg) specified in IEEE Std. 1528:2013; FCC 47CFR § 2.1093; IEEE/ANSI C95.1:2005 and the following specific FCC Test Procedures:

- KDB 447498 D01 General RF Exposure Guidance v06
- KDB 648474 D04 Handset SAR v01r03
- KDB 865664 D01 SAR Measurement 100MHz to 6GHz v01r04
- KDB 941225 D01 3G SAR Procedures v03r01
- KDB 941225 D06 Hotspot Mode v02r01
- KDB 248227 D01 802 11 Wi-Fi SAR v02r02
- KDB 941225 D05 SAR for LTE Devices v02r05

The results shown in this test report refer only to the sample(s) tested unless otherwise stated and the sample(s) are retained for 30 days only. The document is issued by AGC, this document cannot be reproduced except in full with our prior written permission. The more details and the authenticity of the report will be confirmed at <http://www.agc-cert.com>.

2. GENERAL INFORMATION

2.1. EUT Description

General Information	
Product Designation	Smartphone
Test Model	VOLT_5XL
Hardware Version	A969-37-MB-V2.0
Software Version	VOLT_5XL_V1.0
Device Category	Portable
RF Exposure Environment	Uncontrolled
Antenna Type	Internal
GSM and GPRS & EGPRS	
Support Band	<input checked="" type="checkbox"/> GSM 850 <input checked="" type="checkbox"/> PCS 1900 (U.S. Bands) <input checked="" type="checkbox"/> GSM 900 <input checked="" type="checkbox"/> DCS 1800 (Non-U.S. Bands)
GPRS & EGPRS Type	Class B
GPRS & EGPRS Class	Class 12(1Tx+4Rx, 2Tx+3Rx, 3Tx+2Rx, 4Tx+1Rx)
TX Frequency Range	GSM 850 : 820-850MHz; PCS 1900: 1850-1910MHz;
RX Frequency Range	GSM 850 : 869~894MHz; PCS 1900: 1930~1990MHz
Release Version	R99
Type of modulation	GMSK for GSM/GPRS; GMSK & 8-PSK for EGPRS
Antenna Gain	GSM850: -0.9dBi; PCS1900: -0.3dBi
Max. Average Power	GSM850: 31.60dBm; PCS1900: 28.74dBm
WCDMA	
Support Band	<input checked="" type="checkbox"/> UMTS FDD Band II <input checked="" type="checkbox"/> UMTS FDD Band IV <input checked="" type="checkbox"/> UMTS FDD Band V (U.S. Bands) <input type="checkbox"/> UMTS FDD Band I <input type="checkbox"/> UMTS FDD Band III <input type="checkbox"/> UMTS FDD Band VIII (Non-U.S. Bands)
HS Type	HSPA(HSUPA/HSDPA)
TX Frequency Range	FDD Band II: 1850-1910MHz; Band IV: 1712.4-1752.6MHz FDD Band V: 820-850MHz
RX Frequency Range	FDD Band II: 1930-1990MHz; Band IV: 2112.4-5152.6MHz FDD Band V: 869-894MHz
Release Version	Rel-6
Type of modulation	HSDPA:QPSK/16QAM; HSUPA:BPSK; WCDMA:QPSK
Antenna Gain	Band II: -0.3dBi; Band IV: -0.7dBi; Band V: -0.9dBi
Max. Average Power	Band II: 21.69dBm; Band IV: 21.92dBm; Band V: 21.70dBm

The results shown in this test report refer only to the sample(s) tested unless otherwise stated and the sample(s) are retained for 30 days only. The document is issued by AGC, this document cannot be reproduced except in full with our prior written permission. The more details and the authenticity of the report will be confirmed at <http://www.agc-cert.com>.

EUT Description(Continue)

LTE	
Support Band	<input checked="" type="checkbox"/> FDD Band 2 <input checked="" type="checkbox"/> FDD Band 4 <input checked="" type="checkbox"/> FDD Band 5 <input checked="" type="checkbox"/> FDD Band 12 <input type="checkbox"/> FDD Band 17 <input type="checkbox"/> FDD Band 25 <input type="checkbox"/> FDD Band 26 <input type="checkbox"/> TDD Band 41 (U.S. Bands) <input type="checkbox"/> FDD Band 1 <input type="checkbox"/> FDD Band 3 <input type="checkbox"/> FDD Band 7 <input type="checkbox"/> FDD Band 8 <input type="checkbox"/> FDD Band 20 <input type="checkbox"/> TDD Band 33 <input type="checkbox"/> TDD Band 34 <input type="checkbox"/> TDD Band 38 <input type="checkbox"/> FDD Band 40 <input type="checkbox"/> FDD Band 42 <input type="checkbox"/> FDD Band 43 (Non-U.S. Bands)
TX Frequency Range	Band 2:1850-1910MHz; Band 4: 1710-1755 MHz; Band 5:824-849MHz;Band 12: 699-716 MHz;
RX Frequency Range	Band 2:1930-1990MHz; Band 4: 2110-2155 MHz; Band 5:869-894MHz;Band 12: 729-746 MHz;
Release Version	Rel-8
Type of modulation	QPSK, 16QAM
Antenna Gain	Band 2: -0.3dBi; Band 4: -0.7dBi; Band 5: -0.9dBi; Band 12: -1.2dBi
Diversity Antenna Gain	Band 2: -0.5dBi; Band 4: -0.9dBi; Band 5: -1.0dBi; Band 12: -1.5dBi
Max. Average Power	Band 2:23.19dBm;Band 4:22.87dBm; Band 5: 22.00dBm; Band 12: 25.73dBm
Bluetooth	
Bluetooth Version	<input type="checkbox"/> V2.0 <input type="checkbox"/> V2.1 <input type="checkbox"/> V2.1+EDR <input type="checkbox"/> V3.0 <input type="checkbox"/> V3.0+HS <input checked="" type="checkbox"/> V4.0 <input type="checkbox"/> V4.1
Operation Frequency	2402~2480MHz
Type of modulation	<input checked="" type="checkbox"/> GFSK <input checked="" type="checkbox"/> II/4-DQPSK <input checked="" type="checkbox"/> 8-DPSK
Peak Power	5.659dBm
Antenna Gain	0.25dBi
WIFI	
WIFI Specification	<input type="checkbox"/> 802.11a <input checked="" type="checkbox"/> 802.11b <input checked="" type="checkbox"/> 802.11g <input checked="" type="checkbox"/> 802.11n(20) <input checked="" type="checkbox"/> 802.11n(40)
Operation Frequency	2412~2462MHz
Avg. Burst Power	11b: 12.91dBm,11g:11.19dBm,11n(20):10.96dBm,11n(40):10.76dBm
Antenna Gain	0.25dBi
Accessories	
Battery	Brand name: SURGE Model No. : VOLT_5XL Voltage and Capacitance: 3.8 V & 2000mAh
Adapter	Brand name: SURGE Model No. : VOLT_5XL Input: AC 100-240V, 50/60Hz, 0.15A Output: DC 5V, 0.7A
Earphone	Brand name: N/A Model No. : N/A
Note:1.CMU200 can measure the average power and Peak power at the same time 2.The sample used for testing is end product.	
Product	Type <input checked="" type="checkbox"/> Production unit <input type="checkbox"/> Identical Prototype

The results shown in this test report refer only to the sample(s) tested unless otherwise stated and the sample(s) are retained for 30 days only. The document is issued by AGC, this document cannot be reproduced except in full with our prior written permission. The more details and the authenticity of the report will be confirmed at <http://www.agc-cert.com>.

3. SAR MEASUREMENT SYSTEM

3.1. The SATIMO system used for performing compliance tests consists of following items

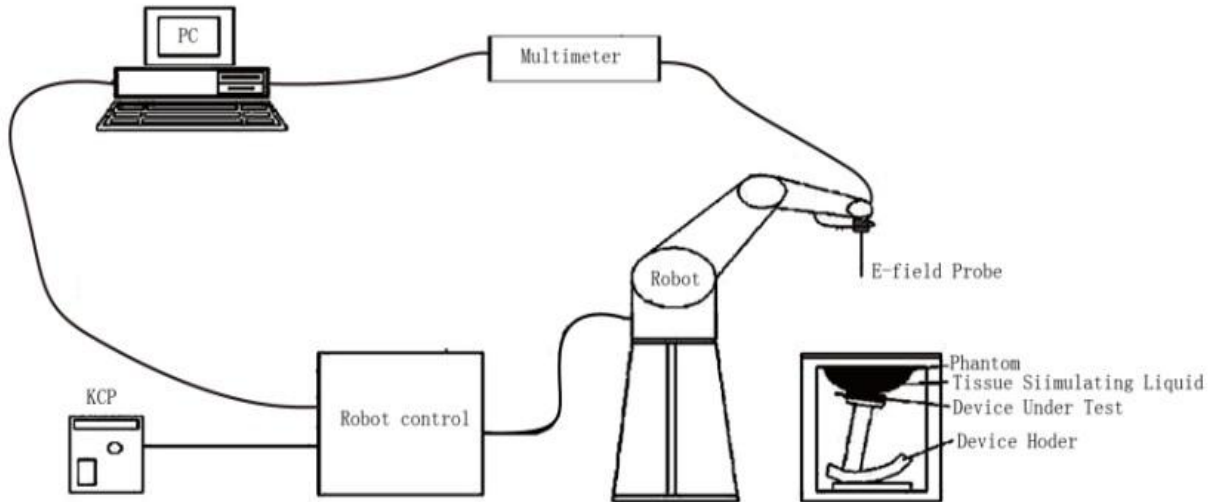

The COMOSAR system for performing compliance tests consists of the following items:

- The PC. It controls most of the bench devices and stores measurement data. A computer running WinXP and the Opensar software.
- The E-Field probe. The probe is a 3-axis system made of 3 distinct dipoles. Each dipole returns a voltage in function of the ambient electric field.
- The Keithley multimeter measures each probe dipole voltages.
- The SAM phantom simulates a human head. The measurement of the electric field is made inside the phantom.
- The liquids simulate the dielectric properties of the human head tissues.
- The network emulator controls the mobile phone under test.
- The validation dipoles are used to measure a reference SAR. They are used to periodically check the bench to make sure that there is no drift of the system characteristics over time.
- The phantom, the device holder and other accessories according to the targeted measurement.

The results shown in this test report refer only to the sample(s) tested unless otherwise stated and the sample(s) are retained for 30 days only. The document is issued by AGC, this document cannot be reproduced except in full with our prior written permission. The more details and the authenticity of the report will be confirmed at <http://www.agc-cert.com>.

3.2. COMOSAR E-Field Probe

The SAR measurement is conducted with the dosimetric probe manufactured by SATIMO. The probe is specially designed and calibrated for use in liquid with high permittivity. The dosimetric probe has special calibration in liquid at different frequency. SATIMO conducts the probe calibration in compliance with international and national standards (e.g. IEEE 1528 and relevant KDB files.) The calibration data are in Appendix D.

Isotropic E-Field Probe Specification

Model	SSE2	
Manufacture	MVG	
Identification No.	SN 08/16 EPGO282	
Frequency	0.7GHz-6GHz Linearity:±0.06dB(700MHz-6GHz)	
Dynamic Range	0.01W/Kg-100W/Kg Linearity:±0.06dB	
Dimensions	Overall length:330mm Length of individual dipoles:2mm Maximum external diameter:8mm Probe Tip external diameter:2.5mm Distance between dipoles/ probe extremity:1mm	
Application	High precision dosimetric measurements in any exposure scenario (e.g., very strong gradient fields). Only probe which enables compliance testing for frequencies up to 6 GHz with precision of better 30%.	

3.3. Robot

The COMOSAR system uses the KUKA robot from SATIMO SA (France).For the 6-axis controller COMOSAR system, the KUKA robot controller version from SATIMO is used.

The XL robot series have many features that are important for our application:

- High precision (repeatability 0.02 mm)
- High reliability (industrial design)
- Jerk-free straight movements
- Low ELF interference (the closed metallic construction shields against motor control fields)
- 6-axis controller



The results shown in this test report refer only to the sample(s) tested unless otherwise stated and the sample(s) are retained for 30 days only. The document is issued by AGC, this document cannot be reproduced except in full with our prior written permission. The more details and the authenticity of the report will be confirmed at <http://www.agc-cert.com>.

3.4. Video Positioning System

The video positioning system is used in OpenSAR to check the probe. Which is composed of a camera, LED, mirror and mechanical parts. The camera is piloted by the main computer with firewire link. During the process, the actual position of the probe tip with respect to the robot arm is measured, as well as the probe length and the horizontal probe offset. The software then corrects all movements, such that the robot coordinates are valid for the probe tip. The repeatability of this process is better than 0.1 mm. If a position has been taught with an aligned probe, the same position will be reached with another aligned probe within 0.1 mm, even if the other probe has different dimensions. During probe rotations, the probe tip will keep its actual position.

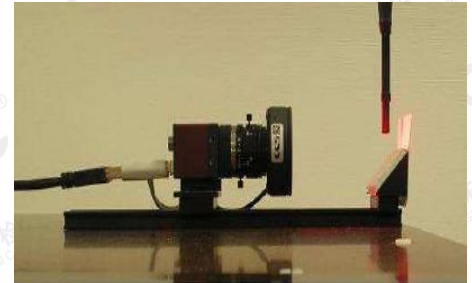

3.5. Device Holder

The COMOSAR device holder is designed to cope with different positions given in the standard. It has two scales for the device rotation (with respect to the body axis) and the device inclination (with respect to the line between the ear reference points). The rotation center for both scales is the ear reference point (EPR). Thus the device needs no repositioning when changing the angles. The COMOSAR device holder has been made out of low-loss POM material having the following dielectric parameters: relative permittivity $\epsilon_r = 3$ and loss tangent $\delta = 0.02$. The amount of dielectric material has been reduced in the closest vicinity of the device, since measurements have suggested that the influence of the clamp on the test results could thus be lowered.

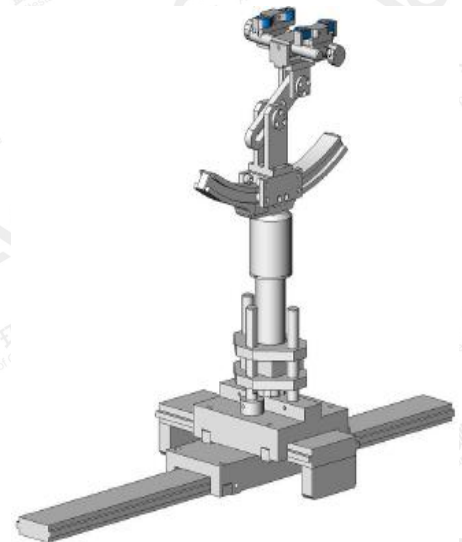

The results shown in this test report refer only to the sample(s) tested unless otherwise stated and the sample(s) are retained for 30 days only. The document is issued by AGC, this document cannot be reproduced except in full with our prior written permission. The more details and the authenticity of the report will be confirmed at <http://www.agc-cert.com>.

3.6. SAM Twin Phantom

The SAM twin phantom is a fiberglass shell phantom with 2mm shell thickness (except the ear region where shell thickness increases to 6mm). It has three measurement areas:

- Left head
- Right head
- Flat phantom



The bottom plate contains three pair of bolts for locking the device holder. The device holder positions are adjusted to the standard measurement positions in the three sections. A white cover is provided to tap the phantom during off-periods to prevent water evaporation and changes in the liquid parameters. On the phantom top, three reference markers are provided to identify the phantom position with respect to the robot.

The results shown in this test report refer only to the sample(s) tested unless otherwise stated and the sample(s) are retained for 30 days only. The document is issued by AGC, this document cannot be reproduced except in full with our prior written permission. The more details and the authenticity of the report will be confirmed at <http://www.agc-cert.com>.

4. SAR MEASUREMENT PROCEDURE

4.1. Specific Absorption Rate (SAR)

SAR is related to the rate at which energy is absorbed per unit mass in object exposed to a radio field. The SAR distribution in a biological body is complicated and is usually carried out by experimental techniques or numerical modeling. The standard recommends limits for two tiers of groups, occupational/controlled and occupational/uncontrolled, based on a person's awareness and ability to exercise control over his or her exposure. In general, occupational/controlled exposure limits are higher than the limits for general population/uncontrolled.

The SAR definition is the time derivative (rate) of the incremental energy (dW) absorbed by (dissipated in) an incremental mass (dm) contained in a volume element(dv) of given mass density (ρ). The equation description is as below:

$$SAR = \frac{d}{dt} \left(\frac{dW}{dm} \right) = \frac{d}{dt} \left(\frac{dW}{\rho dV} \right)$$

SAR is expressed in units of Watts per kilogram (W/Kg)

SAR can be obtained using either of the following equations:

$$SAR = \frac{\sigma E^2}{\rho}$$

$$SAR = c_h \left. \frac{dT}{dt} \right|_{t=0}$$

Where

SAR	is the specific absorption rate in watts per kilogram;
E	is the r.m.s. value of the electric field strength in the tissue in volts per meter;
σ	is the conductivity of the tissue in siemens per metre;
ρ	is the density of the tissue in kilograms per cubic metre;
c _h	is the heat capacity of the tissue in joules per kilogram and Kelvin;
$\left. \frac{dT}{dt} \right _{t=0}$	is the initial time derivative of temperature in the tissue in kelvins per second

The results shown in this test report refer only to the sample(s) tested unless otherwise stated and the sample(s) are retained for 30 days only. The document is issued by AGC, this document cannot be reproduced except in full with our prior written permission. The more details and the authenticity of the report will be confirmed at <http://www.agc-cert.com>.

4.2. SAR Measurement Procedure

Step 1: Power Reference Measurement

The Power Reference Measurement and Power Drift Measurement are for monitoring the power drift of the device under test in the batch process. The minimum distance of probe sensors to surface is 2.7mm This distance cannot be smaller than the distance os sensor calibration points to probe tip as `defined in the probe properties,

Step 2: Area Scan

The Area Scan is used as a fast scan in two dimensions to find the area of high field values, before doing a fine measurement around the hot spot. The sophisticated interpolation routines implemented in SATIMO software can find the maximum locations even in relatively coarse grids. When an Area Scan has measured all reachable points, it computes the field maximal found in the scanned area, within a range of the global maximum. The range (in db) is specified in the standards for compliance testing. For example, a 2db range is required in IEEE Standard 1528 and IEC62209 standards, whereby 3db is a requirement when compliance is assessed in accordance with the ARIB standard (Japan) If one Zoom Scan follows the Area Scan, then only the absolute maximum will be taken as reference. For cases where multiple maximum are detected, the number of Zoom Scan has to be increased accordingly.

Area Scan Parameters extracted from KDB 865664 D01 SAR Measurement 100MHz to 6GHz

	≤ 3 GHz	> 3 GHz
Maximum distance from closest measurement point (geometric center of probe sensors) to phantom surface	5 ± 1 mm	$\frac{1}{2} \cdot \delta \cdot \ln(2) \pm 0.5$ mm
Maximum probe angle from probe axis to phantom surface normal at the measurement location	30° ± 1°	20° ± 1°
Maximum area scan spatial resolution: Δx_{Area} , Δy_{Area}	≤ 2 GHz: ≤ 15 mm 2 – 3 GHz: ≤ 12 mm	3 – 4 GHz: ≤ 12 mm 4 – 6 GHz: ≤ 10 mm
	When the x or y dimension of the test device, in the measurement plane orientation, is smaller than the above, the measurement resolution must be ≤ the corresponding x or y dimension of the test device with at least one measurement point on the test device.	

Step 3: Zoom Scan

Zoom Scan are used to assess the peak spatial SAR value within a cubic average volume containing 1g abd 10g of simulated tissue. The Zoom Scan measures points(refer to table below) within a cube whose base faces are centered on the maxima found in a preceding area scan job within the same procedure. When the measurement is done, the Zoom Scan evaluates the averaged SAR for 1g and 10g and displays these values next to the job's label.

The results shown in this test report refer only to the sample(s) tested unless otherwise stated and the sample(s) are retained for 30 days only. The document is issued by AGC, this document cannot be reproduced except in full with our prior written permission. The more details and the authenticity of the report will be confirmed at <http://www.agc-cert.com>.

Zoom Scan Parameters extracted from KDB865664 d01 SAR Measurement 100MHz to 6GHz

Maximum zoom scan spatial resolution: Δx_{Zoom} , Δy_{Zoom}		≤ 2 GHz: ≤ 8 mm 2 – 3 GHz: ≤ 5 mm*	3 – 4 GHz: ≤ 5 mm* 4 – 6 GHz: ≤ 4 mm*
Maximum zoom scan spatial resolution, normal to phantom surface	uniform grid: $\Delta z_{Zoom}(n)$	≤ 5 mm	3 – 4 GHz: ≤ 4 mm 4 – 5 GHz: ≤ 3 mm 5 – 6 GHz: ≤ 2 mm
	graded grid	$\Delta z_{Zoom}(1)$: between 1 st two points closest to phantom surface	≤ 4 mm
		$\Delta z_{Zoom}(n>1)$: between subsequent points	$\leq 1.5 \cdot \Delta z_{Zoom}(n-1)$
Minimum zoom scan volume	x, y, z	≥ 30 mm	3 – 4 GHz: ≥ 28 mm 4 – 5 GHz: ≥ 25 mm 5 – 6 GHz: ≥ 22 mm
<p>Note: δ is the penetration depth of a plane-wave at normal incidence to the tissue medium; see draft standard IEEE P1528-2011 for details.</p> <p>* When zoom scan is required and the <i>reported</i> SAR from the <i>area scan based 1-g SAR estimation</i> procedures of KDB 447498 is ≤ 1.4 W/kg, ≤ 8 mm, ≤ 7 mm and ≤ 5 mm zoom scan resolution may be applied, respectively, for 2 GHz to 3 GHz, 3 GHz to 4 GHz and 4 GHz to 6 GHz.</p>			

Step 4: Power Drift Measurement

The Power Drift Measurement measures the field at the same location as the most recent power reference measurement within the same procedure, and with the same settings. The Power Drift Measurement gives the field difference in dB from the reading conducted within the same settings. This allows a user to monitor the power drift of the device under test within a batch process. The measurement procedure is the same as Step 1.

The results shown in this test report refer only to the sample(s) tested unless otherwise stated and the sample(s) are retained for 30 days only. The document is issued by AGC, this document cannot be reproduced except in full with our prior written permission. The more details and the authenticity of the report will be confirmed at <http://www.agc-cert.com>.

4.3. RF Exposure Conditions

Test Configuration and setting:

The EUT is a model of GSM Portable Mobile Station (MS). It supports GSM/GPRS/EGPRS, WCDMA/HSPA, LTE, BT, WIFI, and support hot spot mode.

For WWAN SAR testing, the device was controlled by using a base station emulator. Communication between the device and the emulator were established by air link. The distance between the EUT and the antenna is larger than 50cm, and the output power radiated from the emulator antenna is at least 30db smaller than the output power of EUT.

For WLAN testing, the EUT is configured with the WLAN continuous TX tool through engineering command.

Antenna Location: (the back view)

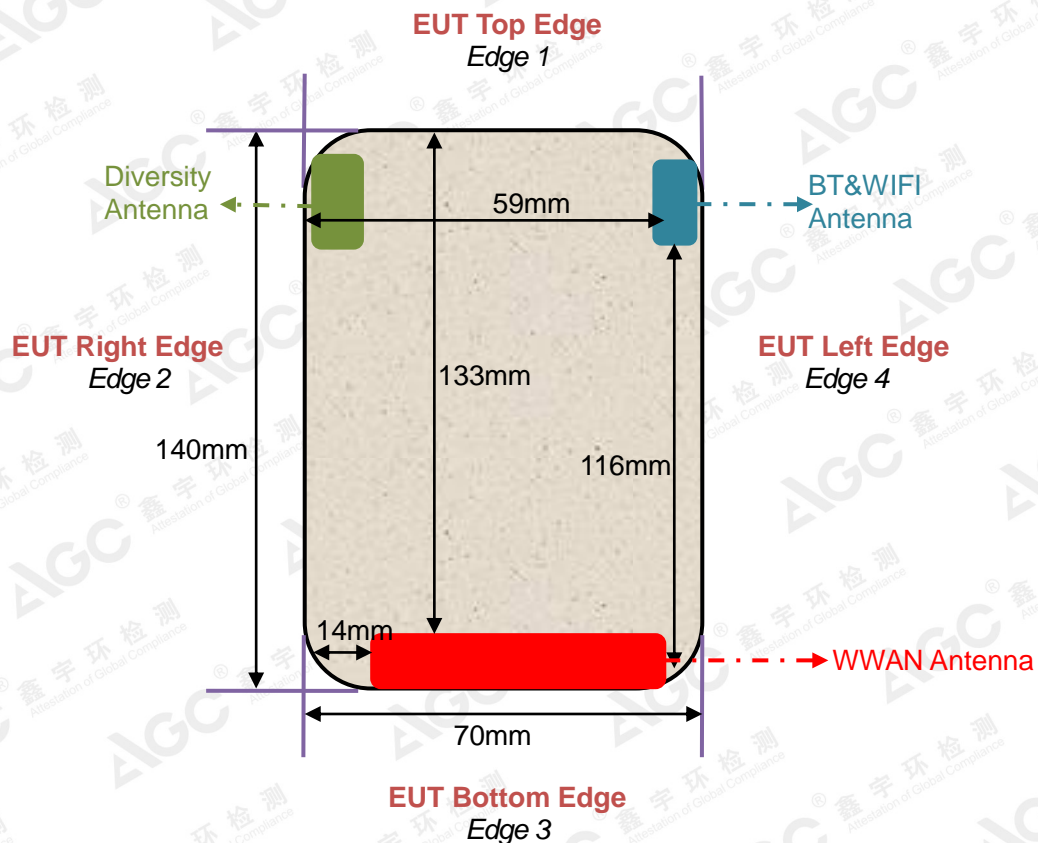

The results shown in this test report refer only to the sample(s) tested unless otherwise stated and the sample(s) are retained for 30 days only. The document is issued by AGC, this document cannot be reproduced except in full with our prior written permission. The more details and the authenticity of the report will be confirmed at <http://www.agc-cert.com>.

For WWAN mode:

Test Configurations	Antenna to edges/surface	SAR required	Note
Head			
Left Touch		Yes	--
Left Tilt		Yes	--
Right Touch		Yes	--
Right Tilt		Yes	--
Body			
Back	<25mm	Yes	--
Front	<25mm	Yes	--
Hotspot			
Back	<25mm	Yes	--
Front	<25mm	Yes	--
Edge 1 (Top)	133mm	No	SAR is not required for the distance between the antenna and the edge is >25mm as per KDB 941225 D06 Hotspot SAR
Edge 2 (Right)	14mm	Yes	--
Edge 3 (Bottom)	2mm	Yes	--
Edge 4 (Left)	3mm	Yes	--

For WLAN mode:

Test Configurations	Antenna to edges/surface	SAR required	Note
Head			
Left Touch		Yes	--
Left Tilt		Yes	--
Right Touch		Yes	--
Right Tilt		Yes	--
Body			
Back	<25mm	Yes	--
Front	<25mm	Yes	--
Hotspot			
Back	<25mm	Yes	--
Front	<25mm	Yes	--
Edge 1 (Top)	2mm	Yes	--
Edge 2 (Right)	59mm	No	SAR is not required for the distance between the antenna and the edge is >25mm as per KDB 941225 D06 Hotspot SAR
Edge 3 (Bottom)	116mm	No	SAR is not required for the distance between the antenna and the edge is >25mm as per KDB 941225 D06 Hotspot SAR
Edge 4 (Left)	1mm	Yes	--

The results shown in this test report refer only to the sample(s) tested unless otherwise stated and the sample(s) are retained for 30 days only. The document is issued by AGC, this document cannot be reproduced except in full with our prior written permission. The more details and the authenticity of the report will be confirmed at <http://www.agc-cert.com>.

5. TISSUE SIMULATING LIQUID

For SAR measurement of the field distribution inside the phantom, the phantom must be filled with homogeneous tissue simulating liquid to a depth of at least 15cm. For head SAR testing the liquid height from the ear reference point (ERP) of the phantom to the liquid top surface is larger than 15cm For body SAR testing, the liquid height from the center of the flat phantom to the liquid top surface is larger than 15cm. The nominal dielectric values of the tissue simulating liquids in the phantom and the tolerance of 5% are listed in 5.2

5.1. The composition of the tissue simulating liquid

Ingredient (% Weight) Frequency (MHz)	Water	Nacl	Polysorbate 20	DGBE	1,2 Propanediol	Triton X-100
750 Head	35	2	0.0	0.0	63	0.0
750 Body	55	1	0.0	0.0	44	0.0
835 Head	50.36	1.25	48.39	0.0	0.0	0.0
835 Body	54.00	1	0.0	15	0.0	30
1750 Head	52.64	0.36	0.0	47	0.0	0.0
1750 Body	70	1	0.0	9	0.0	20
1900 Head	54.9	0.18	0.0	44.92	0.0	0.0
1900 Body	70	1	0.0	9	0.0	20
2450 Head	71.88	0.16	0.0	7.99	0.0	19.97
2450 Body	70	1	0.0	9	0.0	20

5.2. Tissue Dielectric Parameters for Head and Body Phantoms

The head tissue dielectric parameters recommended by the IEEE 1528 have been incorporated in the following table. These head parameters are derived from planar layer models simulating the highest expected SAR for the dielectric properties and tissue thickness variations in a human head. Other head and body tissue parameters that have not been specified in IEEE 1528 are derived from the tissue dielectric parameters computed from the 4-Cole-Cole equations described in Reference [12] and extrapolated according to the head parameters specified in IEEE 1528.

Target Frequency (MHz)	head		body	
	ϵ_r	σ (S/m)	ϵ_r	σ (S/m)
300	45.3	0.87	58.2	0.92
450	43.5	0.87	56.7	0.94
750	41.9	0.89	55.5	0.96
835	41.5	0.90	55.2	0.97
900	41.5	0.97	55.0	1.05
915	41.5	1.01	55.0	1.06
1450	40.5	1.20	54.0	1.30
1610	40.3	1.29	53.8	1.40
1750	40.1	1.37	53.4	1.49
1800 – 2000	40.0	1.40	53.3	1.52
2450	39.2	1.80	52.7	1.95
3000	38.5	2.40	52.0	2.73

(ϵ_r = relative permittivity, σ = conductivity and $\rho = 1000$ kg/m³)

The results shown in this test report refer only to the sample(s) tested unless otherwise stated and the sample(s) are retained for 30 days only. The document is issued by AGC, this document cannot be reproduced except in full with our prior written permission. The more details and the authenticity of the report will be confirmed at <http://www.agc-cert.com>.

5.3. Tissue Calibration Result

The dielectric parameters of the liquids were verified prior to the SAR evaluation using SATIMO Dielectric Probe Kit and R&S Network Analyzer ZVL6.

Tissue Stimulant Measurement for 750MHz					
	Fr. (MHz)	Dielectric Parameters ($\pm 5\%$)		Tissue Temp [°C]	Test time
		ϵ_r 41.9 (39.805-43.995)	δ [s/m] 0.89(0.8455-0.9345)		
Head	704	43.85	0.85	21.3	July 02,2018
	707.5	43.35	0.86		
	711	41.68	0.87		
	750	41.06	0.87		
	Fr. (MHz)	Dielectric Parameters ($\pm 5\%$)		Tissue Temp [°C]	Test time
		ϵ_r 55.5(52.725-58.275)	δ [s/m]0.96(0.912-1.008)		
Body	704	57.32	0.92	21.5	July 02,2018
	707.5	56.69	0.93		
	711	55.04	0.97		
	750	54.56	0.98		

Tissue Stimulant Measurement for 835MHz					
	Fr. (MHz)	Dielectric Parameters ($\pm 5\%$)		Tissue Temp [°C]	Test time
		ϵ_r 41.5 (39.425-43.575)	δ [s/m] 0.90(0.855-0.945)		
Head	824.2	43.05	0.88	21.2	July 05,2018
	826.4	42.63	0.89		
	835	42.17	0.90		
	836.6	41.77	0.91		
	846.6	41.26	0.92		
	848.8	40.89	0.93		
	Fr. (MHz)	Dielectric Parameters ($\pm 5\%$)		Tissue Temp [°C]	Test time
		ϵ_r 55.20(52.44-57.96)	δ [s/m]0.97(0.9215-1.0185)		
Body	824.2	56.38	0.93	21.5	July 05,2018
	826.4	55.71	0.94		
	835	55.13	0.95		
	836.6	54.69	0.96		
	846.6	54.03	0.97		
	848.8	53.57	0.98		

The results shown in this test report refer only to the sample(s) tested unless otherwise stated and the sample(s) are retained for 30 days only. The document is issued by AGC, this document cannot be reproduced except in full with our prior written permission. The more details and the authenticity of the report will be confirmed at <http://www.agc-cert.com>.

Tissue Stimulant Measurement for 835MHz					
	Fr. (MHz)	Dielectric Parameters ($\pm 5\%$)		Tissue Temp [°C]	Test time
		ϵ_r 41.5 (39.425-43.575)	δ [s/m] 0.90(0.855-0.945)		
Head	829	41.35	0.88	21.5	June 30,2018
	835	41.06	0.88		
	836.5	40.96	0.89		
	844	40.40	0.91		
	Fr. (MHz)	Dielectric Parameters ($\pm 5\%$)		Tissue Temp [°C]	Test time
		ϵ_r 55.20(52.44-57.96)	δ [s/m]0.97(0.9215-1.0185)		
Body	829	55.43	0.95	21.5	June 30,2018
	835	54.89	0.95		
	836.5	54.51	0.95		
	844	53.66	0.97		

Tissue Stimulant Measurement for 1750MHz					
	Fr. (MHz)	Dielectric Parameters ($\pm 5\%$)		Tissue Temp [°C]	Test time
		ϵ_r 40.1 (38.095-42.105)	δ [s/m]1.37(1.3015-1.439)		
Head	1712.5	41.38	1.32	21.3	July 06,2018
	1732.5	40.27	1.36		
	1750	39.46	1.39		
	1752.5	39.02	1.40		
	Fr. (MHz)	Dielectric Parameters ($\pm 5\%$)		Tissue Temp [°C]	Test time
		ϵ_r 53.4(50.73-56.07)	δ [s/m] 1.49(1.4155-1.5645)		
Body	1712.5	55.05	1.44	21.5	July 06,2018
	1732.5	54.11	1.48		
	1750	53.24	1.51		
	1752.5	52.81	1.53		

Tissue Stimulant Measurement for 1750MHz					
	Fr. (MHz)	Dielectric Parameters ($\pm 5\%$)		Tissue Temp [°C]	Test time
		ϵ_r 40.1 (38.095-42.105)	δ [s/m]1.37(1.3015-1.439)		
Head	1720	40.84	1.34	22.5	July 09,2018
	1732.5	40.35	1.36		
	1745	39.73	1.38		
	1750	39.22	1.41		
	Fr. (MHz)	Dielectric Parameters ($\pm 5\%$)		Tissue Temp [°C]	Test time
		ϵ_r 53.4(50.73-56.07)	δ [s/m] 1.49(1.4155-1.5645)		
Body	1720	54.73	1.45	22.6	July 09,2018
	1732.5	54.26	1.47		
	1745	53.89	1.49		
	1750	53.34	1.51		

The results shown in this test report refer only to the sample(s) tested unless otherwise stated and the sample(s) are retained for 30 days only. The document is issued by AGC, this document cannot be reproduced except in full with our prior written permission. The more details and the authenticity of the report will be confirmed at <http://www.agc-cert.com>.

Tissue Stimulant Measurement for 1900MHz					
	Fr. (MHz)	Dielectric Parameters ($\pm 5\%$)		Tissue Temp [°C]	Test time
		ϵ_r 40.00(38.00-42.00)	δ [s/m]1.40(1.33-1.47)		
Head	1850.2	41.38	1.35	21.7	July 07,2018
	1852.4	40.95	1.37		
	1880	40.57	1.39		
	1900	40.06	1.40		
	1907.6	39.64	1.41		
	1909.8	39.11	1.43		
	Fr. (MHz)	Dielectric Parameters ($\pm 5\%$)		Tissue Temp [°C]	Test time
		ϵ_r 53.30(50.635-55.965)	δ [s/m]1.52(1.444-1.596)		
Body	1850.2	55.11	1.46	21.9	July 04,2018
	1852.4	54.63	1.48		
	1880	54.07	1.50		
	1900	53.73	1.51		
	1907.6	53.35	1.53		
	1909.8	52.89	1.55		

Tissue Stimulant Measurement for 1900MHz					
	Fr. (MHz)	Dielectric Parameters ($\pm 5\%$)		Tissue Temp [°C]	Test time
		ϵ_r 40.00(38.00-42.00)	δ [s/m]1.40(1.33-1.47)		
Head	1860	41.06	1.36	21.2	June 25,2018
	1880	40.67	1.38		
	1900	40.00	1.40		
	Fr. (MHz)	Dielectric Parameters ($\pm 5\%$)		Tissue Temp [°C]	Test time
		ϵ_r 53.30(50.635-55.965)	δ [s/m]1.52(1.444-1.596)		
Body	1860	54.16	1.48	21.5	June 25,2018
	1880	53.74	1.50		
	1900	53.22	1.52		

Tissue Stimulant Measurement for 2450MHz					
	Fr. (MHz)	Dielectric Parameters ($\pm 5\%$)		Tissue Temp [°C]	Test time
		ϵ_r 39.2(37.24-41.16)	δ [s/m]1.80(1.71-1.89)		
Head	2412	40.66	1.73	21.3	June 29,2018
	2437	39.87	1.75		
	2450	39.26	1.77		
	2462	38.75	1.80		
	Fr. (MHz)	Dielectric Parameters ($\pm 5\%$)		Tissue Temp [°C]	Test time
		ϵ_r 52.7(50.065-55.335)	δ [s/m]1.95(1.8525-2.0475)		
Body	2412	54.63	1.88	21.5	June 29,2018
	2437	54.17	1.90		
	2450	53.59	1.92		
	2462	52.86	1.95		

The results shown in this test report refer only to the sample(s) tested unless otherwise stated and the sample(s) are retained for 30 days only. The document is issued by AGC, this document cannot be reproduced except in full with our prior written permission. The more details and the authenticity of the report will be confirmed at <http://www.agc-cert.com>.

6. SAR SYSTEM CHECK PROCEDURE

6.1. SAR System Check Procedures

SAR system check is required to confirm measurement accuracy, according to the tissue dielectric media, probe calibration points and other system operating parameters required for measuring the SAR of a test device. The system verification must be performed for each frequency band and within the valid range of each probe calibration point required for testing the device. The same SAR probe(s) and tissue-equivalent media combinations used with each specific SAR system for system verification must be used for device testing. When multiple probe calibration points are required to cover substantially large transmission bands, independent system verifications are required for each probe calibration point. A system verification must be performed before each series of SAR measurements using the same probe calibration point and tissue-equivalent medium. Additional system verification should be considered according to the conditions of the tissue-equivalent medium and measured tissue dielectric parameters, typically every three to four days when the liquid parameters are remeasured or sooner when marginal liquid parameters are used at the beginning of a series of measurements.

Each SATIMO system is equipped with one or more system check kits. These units, together with the predefined measurement procedures within the SATIMO software, enable the user to conduct the system check and system validation. System kit includes a dipole, and dipole device holder.

The system check verifies that the system operates within its specifications. It's performed daily or before every SAR measurement. The system check uses normal SAR measurement in the flat section of the phantom with a matched dipole at a specified distance. The system check setup is shown as below.

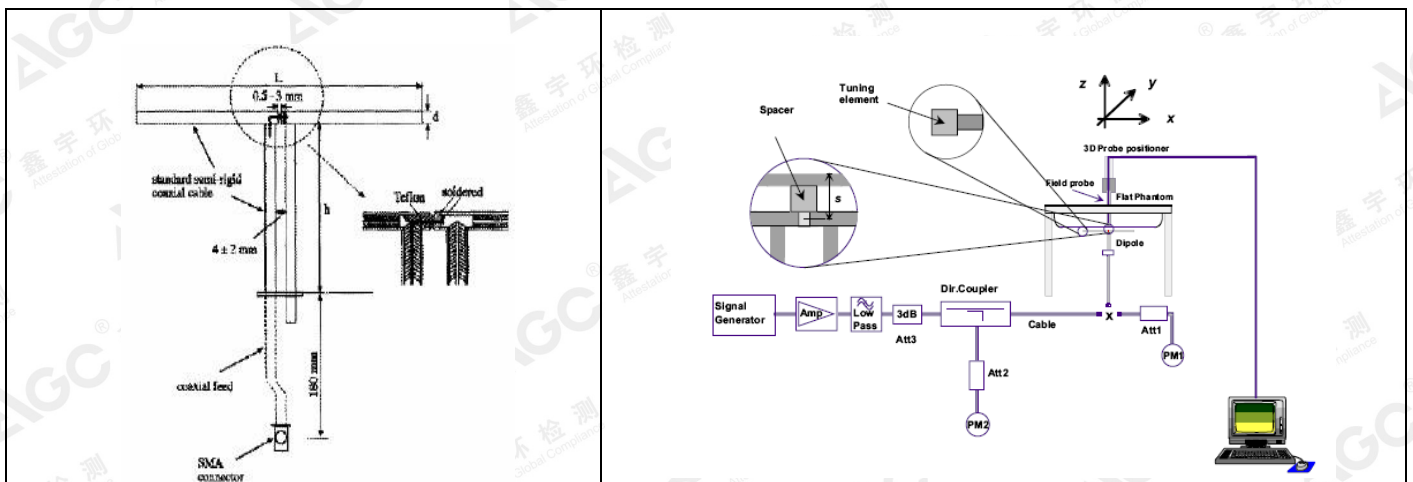

The results shown in this test report refer only to the sample(s) tested unless otherwise stated and the sample(s) are retained for 30 days only. The document is issued by AGC, this document cannot be reproduced except in full with our prior written permission. The more details and the authenticity of the report will be confirmed at <http://www.agc-cert.com>.

6.2. SAR System Check

6.2.1. Dipoles

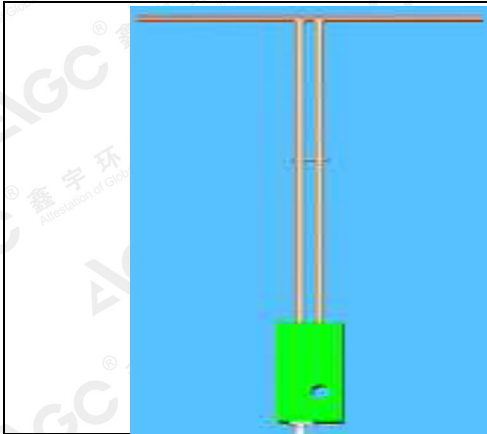

The dipoles used is based on the IEEE-1528 standard, and is complied with mechanical and electrical specifications in line with the requirements of IEEE. the table below provides details for the mechanical and electrical Specifications for the dipoles.

Frequency	L (mm)	h (mm)	d (mm)
750MHz	176	100	6.35
835MHz	161.0	89.8	3.6
1800MHz	71.6	41.7	3.6
1900MHz	68	39.5	3.6
2450MHz	51.5	30.4	3.6

The results shown in this test report refer only to the sample(s) tested unless otherwise stated and the sample(s) are retained for 30 days only. The document is issued by AGC, this document cannot be reproduced except in full with our prior written permission. The more details and the authenticity of the report will be confirmed at <http://www.agc-cert.com>.

6.2.2. System Check Result

System Performance Check at 750MHz&835MHz &1800MHz &1900MHz &2450MHz for Head								
Validation Kit: SN22/16 DIP 0G750-417& SN29/15 DIP 0G835-383& SN29/15 DIP 1G800-387 &SN 29/15 DIP 1G900-389& SN 29/15DIP 2G450-393								
Frequency [MHz]	Target Value(W/Kg)		Reference Result ($\pm 10\%$)		Tested Value(W/Kg)		Tissue Temp. [°C]	Test time
	1g	10g	1g	10g	1g	10g		
750	8.65	5.68	7.785-9.515	5.112-6.248	8.99	5.87	21.3	July 02,2018
835	10.04	6.43	9.036-11.044	5.787 -7.073	9.70	6.19	21.2	July 05,2018
835	10.04	6.43	9.036-11.044	5.787 -7.073	10.27	6.18	21.5	June 30,2018
1800	37.43	19.88	33.687-41.173	17.892-21.868	38.31	19.75	21.3	July 06,2018
1800	37.43	19.88	33.687-41.173	17.892-21.868	37.11	19.81	22.5	July 09,2018
1900	41.44	21.33	37.296-45.584	19.197-23.463	42.40	21.36	21.7	July 07,2018
1900	41.44	21.33	37.296-45.584	19.197-23.463	39.03	19.63	21.2	June 25,2018
2450	54.53	24.30	49.077-59.983	21.87-26.730	51.22	23.76	21.3	June 29,2018
System Performance Check at 750MHz & 835MHz &1800MHz &1900MHz &2450MHz for Body								
Frequency [MHz]	Target Value(W/Kg)		Reference Result ($\pm 10\%$)		Tested Value(W/Kg)		Tissue Temp. [°C]	Test time
	1g	10g	1g	10g	1g	10g		
750	8.95	5.97	8.055-9.845	5.373-6.567	9.65	6.00	21.5	July 02,2018
835	9.85	6.45	8.865-10.835	5.805-7.095	9.28	5.95	21.5	July 05,2018
835	9.85	6.45	8.865-10.835	5.805-7.095	9.20	5.90	21.5	June 30,2018
1800	36.53	19.80	32.877-40.183	17.82-21.780	37.26	19.20	21.5	July 06,2018
1800	36.53	19.80	32.877-40.183	17.82-21.780	36.10	19.31	22.6	July 09,2018
1900	39.38	20.86	35.442-43.318	18.774-22.946	37.81	19.65	21.9	July 04,2018
1900	39.38	20.86	35.442-43.318	18.774-22.946	37.26	18.89	21.5	June 25,2018
2450	49.92	23.16	44.928-54.912	20.844-25.476	49.41	22.75	21.5	June 29,2018

Note:

(1) We use a CW signal of 18dBm for system check, and then all SAR value are normalized to 1W forward power. The result must be within $\pm 10\%$ of target value.

The results shown in this test report refer only to the sample(s) tested unless otherwise stated and the sample(s) are retained for 30 days only. The document is issued by AGC, this document cannot be reproduced except in full with our prior written permission. The more details and the authenticity of the report will be confirmed at <http://www.agc-cert.com>.

7. EUT TEST POSITION

This EUT was tested in **Right Cheek, Right Tilted, Left Cheek, Left Tilted, Body back, Body front and 4 edges.**

7.1. Define Two Imaginary Lines on the Handset

- (1) The vertical centerline passes through two points on the front side of the handset: the midpoint of the width w_t of the handset at the level of the acoustic output, and the midpoint of the width w_b of the handset.
- (2) The horizontal line is perpendicular to the vertical centerline and passes through the center of the acoustic output. The horizontal line is also tangential to the face of the handset at point A.
- (3) The two lines intersect at point A. Note that for many handsets, point A coincides with the center of the acoustic output; however, the acoustic output may be located elsewhere on the horizontal line. Also note that the vertical centerline is not necessarily to the front face of the handset, especially for clamshell handsets, handsets with flip covers, and other irregularly shaped handsets.

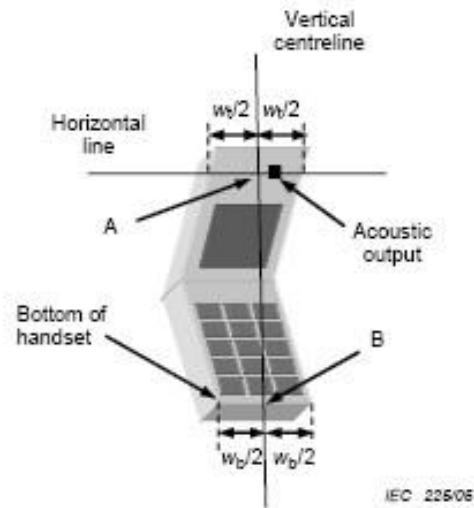
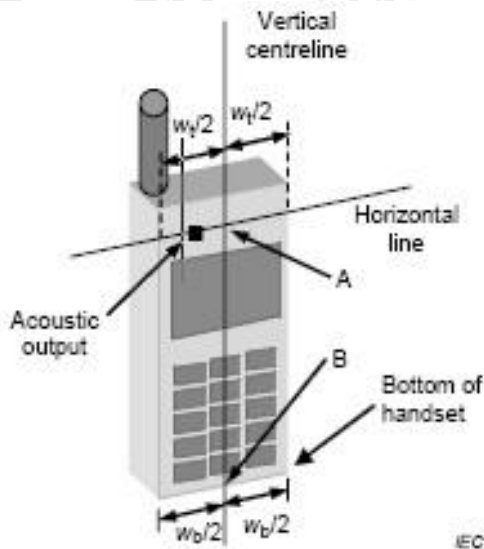

The results shown in this test report refer only to the sample(s) tested unless otherwise stated and the sample(s) are retained for 30 days only. The document is issued by AGC, this document cannot be reproduced except in full with our prior written permission. The more details and the authenticity of the report will be confirmed at <http://www.agc-cert.com>.

7.2. Cheek Position

- (1) To position the device with the vertical center line of the body of the device and the horizontal line crossing the center piece in a plane parallel to the sagittal plane of the phantom. While maintaining the device in this plane, align the vertical center line with the reference plane containing the ear and mouth reference point (M: Mouth, RE: Right Ear, and LE: Left Ear) and align the center of the ear piece with the line RE-LE.
- (2) To move the device towards the phantom with the ear piece aligned with the the line LE-RE until the phone touched the ear. While maintaining the device in the reference plane and maintaining the phone contact with ear, move the bottom of the phone until any point on the front side is in contact with the cheek of the phantom or until contact with the ear is lost



7.3. Tilt Position

- (1) To position the device in the “cheek” position described above.
- (2) While maintaining the device in the reference plane described above and pivoting against the ear, moves it outward away from the mouth by an angle of 15 degrees or until with the ear is lost.



The results shown in this test report refer only to the sample(s) tested unless otherwise stated and the sample(s) are retained for 30 days only. The document is issued by AGC, this document cannot be reproduced except in full with our prior written permission. The more details and the authenticity of the report will be confirmed at <http://www.agc-cert.com>.

7.4. Body Worn Position

- (1) To position the EUT parallel to the phantom surface.
- (2) To adjust the EUT parallel to the flat phantom.
- (3) To adjust the distance between the EUT surface and the flat phantom to **10mm**.

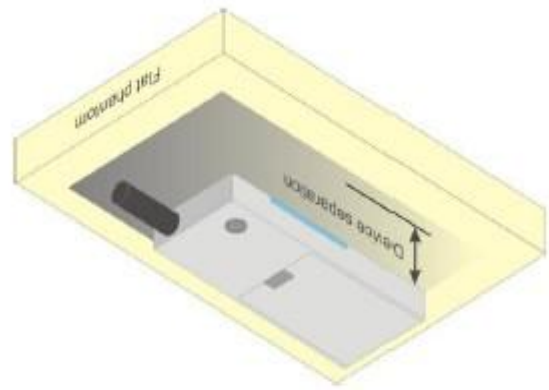
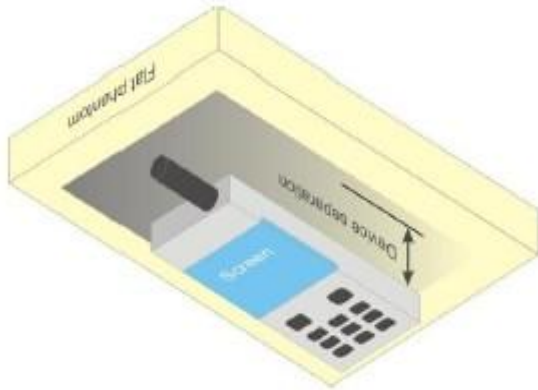

The results shown in this test report refer only to the sample(s) tested unless otherwise stated and the sample(s) are retained for 30 days only. The document is issued by AGC, this document cannot be reproduced except in full with our prior written permission. The more details and the authenticity of the report will be confirmed at <http://www.agc-cert.com>.

8. SAR EXPOSURE LIMITS

Limits for General Population/Uncontrolled Exposure (W/kg)

Type Exposure	Uncontrolled Environment Limit (W/kg)
Spatial Peak SAR (1g cube tissue for brain or body)	1.60
Spatial Average SAR (Whole body)	0.08
Spatial Peak SAR (Limbs)	4.0

The results shown in this test report refer only to the sample(s) tested unless otherwise stated and the sample(s) are retained for 30 days only. The document is issued by AGC, this document cannot be reproduced except in full with our prior written permission. The more details and the authenticity of the report will be confirmed at <http://www.agc-cert.com>.

9. TEST FACILITY

Test Site	Attestation of Global Compliance (Shenzhen) Co., Ltd
Location	1-2F., Bldg.2, No.1-4, Chaxi Sanwei Technical Industrial Park, Gushu, Xixiang, Bao'an District B112-B113, Shenzhen 518012
NVLAP Lab Code	600153-0
Designation Number	CN5028
Test Firm Registration Number	682566
Description	Attestation of Global Compliance(Shenzhen) Co., Ltd is accredited by National Voluntary Laboratory Accreditation program, NVLAP Code 600153-0

The results shown in this test report refer only to the sample(s) tested unless otherwise stated and the sample(s) are retained for 30 days only. The document is issued by AGC, this document cannot be reproduced except in full with our prior written permission. The more details and the authenticity of the report will be confirmed at <http://www.agc-cert.com>.

10. TEST EQUIPMENT LIST

Equipment description	Manufacturer/ Model	Identification No.	Current calibration date	Next calibration date
SAR Probe	MVG	SN 08/16 EPGO282	Aug. 08,2017	Aug. 07,2018
Phantom	SATIMO	SN_4511_SAM90	Validated. No cal required.	Validated. No cal required.
Liquid	SATIMO	-	Validated. No cal required.	Validated. No cal required.
Comm Tester	Agilent-8960	GB46310822	Mar. 01,2018	Feb. 28,2019
Comm Tester	R&S- CMW500	S/N121209	Jul. 13,2017	Jul. 12,2018
Multimeter	Keithley 2000	1188656	Mar. 01,2018	Feb. 28,2019
Dipole	SATIMO SID750	SN22/16 DIP 0G750-417	Jul. 05,2016	Jul. 04,2019
Dipole	SATIMO SID835	SN29/15 DIP 0G835-383	Jul. 05,2016	Jul. 04,2019
Dipole	SATIMO SID1800	SN29/15 DIP 1G800-387	Jul. 05,2016	Jul. 04,2019
Dipole	SATIMO SID1900	SN 29/15 DIP 1G900-389	Jul. 05,2016	Jul. 04,2019
Dipole	SATIMO SID2450	SN29/15 DIP 2G450-393	Jul. 05,2016	Jul. 04,2019
Signal Generator	Agilent-E4438C	US41461365	Mar. 01,2018	Feb. 28,2019
Vector Analyzer	Agilent / E4440A	US41421290	Mar. 01,2018	Feb. 28,2019
Network Analyzer	Rhode & Schwarz ZVL6	SN100132	Mar. 01,2018	Feb. 28,2019
Attenuator	Warison /WATT-6SR1211	N/A	N/A	N/A
Attenuator	Mini-circuits / VAT-10+	N/A	N/A	N/A
Amplifier	EM30180	SN060552	Mar. 01,2018	Feb. 28,2019
Directional Couple	Werlatone/ C5571-10	SN99463	Jun. 12,2018	Jun. 11,2019
Directional Couple	Werlatone/ C6026-10	SN99482	Jun. 12,2018	Jun. 11,2019
Power Sensor	NRP-Z21	1137.6000.02	Oct. 12,2017	Oct. 11,2018
Power Sensor	NRP-Z23	US38261498	Mar. 01,2018	Feb. 28,2019
Power Viewer	R&S	V2.3.1.0	N/A	N/A

Note: Per KDB 865664 Dipole SAR Validation, AGC Lab has adopted 3 years calibration intervals. On annual basis, every measurement dipole has been evaluated and is in compliance with the following criteria:

1. There is no physical damage on the dipole;
2. System validation with specific dipole is within 10% of calibrated value;
3. Return-loss is within 20% of calibrated measurement;
4. Impedance is within 5Ω of calibrated measurement.

The results shown in this test report refer only to the sample(s) tested unless otherwise stated and the sample(s) are retained for 30 days only. The document is issued by AGC, this document cannot be reproduced except in full with our prior written permission. The more details and the authenticity of the report will be confirmed at <http://www.agc-cert.com>.

11. MEASUREMENT UNCERTAINTY

Measurement uncertainty for Dipole averaged over 1 gram / 10 gram.									
a	b	c	d	e f(d,k)	f	g	h cx/f/e	i cxg/e	k
Uncertainty Component	Sec.	Tol (± %)	Prob. Dist.	Div.	Ci (1g)	Ci (10g)	1g Ui (±%)	10g Ui (±%)	vi
Measurement System									
Probe calibration	E.2.1	5.831	N	1	1	1	5.83	5.83	∞
Axial Isotropy	E.2.2	0.695	R	$\sqrt{3}$	$\sqrt{0.5}$	$\sqrt{0.5}$	0.28	0.28	∞
Hemispherical Isotropy	E.2.2	1.045	R	$\sqrt{3}$	$\sqrt{0.5}$	$\sqrt{0.5}$	0.43	0.43	∞
Boundary effect	E.2.3	1.0	R	$\sqrt{3}$	1	1	0.58	0.58	∞
Linearity	E.2.4	0.685	R	$\sqrt{3}$	1	1	0.40	0.40	∞
System detection limits	E.2.4	1.0	R	$\sqrt{3}$	1	1	0.58	0.58	∞
Modulation response	E.2.5	3.0	R	$\sqrt{3}$	1	1	1.73	1.73	∞
Readout Electronics	E.2.6	0.021	N	1	1	1	0.021	0.021	∞
Response Time	E.2.7	0	R	$\sqrt{3}$	1	1	0	0	∞
Integration Time	E.2.8	1.4	R	$\sqrt{3}$	1	1	0.81	0.81	∞
RF ambient conditions-Noise	E.6.1	3.0	R	$\sqrt{3}$	1	1	1.73	1.73	∞
RF ambient conditions-reflections	E.6.1	3.0	R	$\sqrt{3}$	1	1	1.73	1.73	∞
Probe positioner mechanical tolerance	E.6.2	1.4	R	$\sqrt{3}$	1	1	0.81	0.81	∞
Probe positioning with respect to phantom shell	E.6.3	1.4	R	$\sqrt{3}$	1	1	0.81	0.81	∞
Extrapolation, interpolation, and integrations algorithms for max. SAR evaluation	E.5	2.3	R	$\sqrt{3}$	1	1	1.33	1.33	∞
Test sample Related									
Test sample positioning	E.4.2	2.6	N	1	1	1	2.6	2.6	∞
Device holder uncertainty	E.4.1	3	N	1	1	1	3	3	∞
Output power variation—SAR drift measurement	E.2.9	5	R	$\sqrt{3}$	1	1	2.89	2.89	∞
SAR scaling	E.6.5	5	R	$\sqrt{3}$	1	1	2.89	2.89	∞
Phantom and tissue parameters									
Phantom shell uncertainty—shape, thickness, and permittivity	E.3.1	4	R	$\sqrt{3}$	1	1	2.31	2.31	∞
Uncertainty in SAR correction for deviations in permittivity and conductivity	E.3.2	1.9	N	1	1	0.84	1.90	1.60	∞
Liquid conductivity measurement	E.3.3	4	N	1	0.78	0.71	3.12	2.84	M
Liquid permittivity measurement	E.3.3	5	N	1	0.23	0.26	1.15	1.30	M
Liquid conductivity—temperature uncertainty	E.3.4	2.5	R	$\sqrt{3}$	0.78	0.71	1.13	1.02	∞
Liquid permittivity—temperature uncertainty	E.3.4	2.5	R	$\sqrt{3}$	0.23	0.26	0.33	0.38	∞
Combined Standard Uncertainty			RSS				9.79	9.59	
Expanded Uncertainty (95% Confidence interval)			K=2				19.58	19.18	

The results shown in this test report refer only to the sample(s) tested unless otherwise stated and the sample(s) are retained for 30 days only. The document is issued by AGC, this document cannot be reproduced except in full with our prior written permission. The more details and the authenticity of the report will be confirmed at <http://www.agc-cert.com>.

System check uncertainty for Dipole averaged over 1 gram / 10 gram.									
a	b	c	d	e f(d,k)	f	g	h cx _f /e	i cx _g /e	k
Uncertainty Component	Sec.	Tol (±%)	Prob. Dist.	Div.	Ci (1g)	Ci (10g)	1g U _i (±%)	10g U _i (±%)	v _i
Measurement System									
Probe calibration drift	E.2.1.3	0.5	N	1	1	1	0.50	0.50	∞
Axial Isotropy	E.2.2	0.695	R	√3	0	0	0.00	0.00	∞
Hemispherical Isotropy	E.2.2	1.045	R	√3	0	0	0.00	0.00	∞
Boundary effect	E.2.3	1.0	R	√3	0	0	0.00	0.00	∞
Linearity	E.2.4	0.685	R	√3	0	0	0.00	0.00	∞
System detection limits	E.2.4	1.0	R	√3	0	0	0.00	0.00	∞
Modulation response	E.2.5	3.0	R	√3	0	0	0.00	0.00	∞
Readout Electronics	E.2.6	0.021	N	1	0	0	0.00	0.00	∞
Response Time	E.2.7	0	R	√3	0	0	0.00	0.00	∞
Integration Time	E.2.8	1.4	R	√3	0	0	0.00	0.00	∞
RF ambient conditions-Noise	E.6.1	3.0	R	√3	0	0	0.00	0.00	∞
RF ambient conditions-reflections	E.6.1	3.0	R	√3	0	0	0.00	0.00	∞
Probe positioner mechanical tolerance	E.6.2	1.4	R	√3	1	1	0.81	0.81	∞
Probe positioning with respect to phantom shell	E.6.3	1.4	R	√3	1	1	0.81	0.81	∞
Extrapolation, interpolation, and integrations algorithms for max. SAR evaluation	E.5	2.3	R	√3	0	0	0.00	0.00	∞
System check source (dipole)									
Deviation of experimental dipoles	E.6.4	2	N	1	1	1	2	2	∞
Input power and SAR drift measurement	8,6.6.4	5	R	√3	1	1	2.89	2.89	∞
Dipole axis to liquid distance	8,E.6.6	2	R	√3	1	1	1.15	1.15	∞
Phantom and tissue parameters									
Phantom shell uncertainty—shape, thickness, and permittivity	E.3.1	4	R	√3	1	1	2.31	2.31	∞
Uncertainty in SAR correction for deviations in permittivity and conductivity	E.3.2	1.9	N	1	1	0.84	1.90	1.60	∞
Liquid conductivity measurement	E.3.3	4	N	1	0.78	0.71	3.12	2.84	M
Liquid permittivity measurement	E.3.3	5	N	1	0.23	0.26	1.15	1.30	M
Liquid conductivity—temperature uncertainty	E.3.4	2.5	R	√3	0.78	0.71	1.13	1.02	∞
Liquid permittivity—temperature uncertainty	E.3.4	2.5	R	√3	0.23	0.26	0.33	0.38	∞
Combined Standard Uncertainty			RSS				5.564	5.205	
Expanded Uncertainty (95% Confidence interval)			K=2				11.128	10.410	

The results shown in this test report refer only to the sample(s) tested unless otherwise stated and the sample(s) are retained for 30 days only. The document is issued by AGC, this document cannot be reproduced except in full with our prior written permission. The more details and the authenticity of the report will be confirmed at <http://www.agc-cert.com>.

System Validation uncertainty for Dipole averaged over 1 gram / 10 gram.									
a	b	c	d	e f(d,k)	f	g	h cx _f /e	i cx _g /e	k
Uncertainty Component	Sec.	Tol (±%)	Prob. Dist.	Div.	C _i (1g)	C _i (10g)	1g U _i (±%)	10g U _i (±%)	v _i
Measurement System									
Probe calibration	E.2.1	5.831	N	1	1	1	5.83	5.83	∞
Axial Isotropy	E.2.2	0.695	R	√3	1	1	0.40	0.40	∞
Hemispherical Isotropy	E.2.2	1.045	R	√3	0	0	0.00	0.00	∞
Boundary effect	E.2.3	1.0	R	√3	1	1	0.58	0.58	∞
Linearity	E.2.4	0.685	R	√3	1	1	0.40	0.40	∞
System detection limits	E.2.4	1.0	R	√3	1	1	0.58	0.58	∞
Modulation response	E.2.5	3.0	R	√3	0	0	0.00	0.00	∞
Readout Electronics	E.2.6	0.021	N	1	1	1	0.021	0.021	∞
Response Time	E.2.7	0.0	R	√3	0	0	0.00	0.00	∞
Integration Time	E.2.8	1.4	R	√3	0	0	0.00	0.00	∞
RF ambient conditions-Noise	E.6.1	3.0	R	√3	1	1	1.73	1.73	∞
RF ambient conditions-reflections	E.6.1	3.0	R	√3	1	1	1.73	1.73	∞
Probe positioner mechanical tolerance	E.6.2	1.4	R	√3	1	1	0.81	0.81	∞
Probe positioning with respect to phantom shell	E.6.3	1.4	R	√3	1	1	0.81	0.81	∞
Extrapolation, interpolation, and integrations algorithms for max. SAR evaluation	E.5	2.3	R	√3	1	1	1.33	1.33	∞
System check source (dipole)									
Deviation of experimental dipole from numerical dipole	E.6.4	5.0	N	1	1	1	5.00	5.00	∞
Input power and SAR drift measurement	8,6.6.4	5.0	R	√3	1	1	2.89	2.89	∞
Dipole axis to liquid distance	8,E.6.6	2.0	R	√3	1	1	1.15	1.15	∞
Phantom and tissue parameters									
Phantom shell uncertainty—shape, thickness, and permittivity	E.3.1	4.0	R	√3	1	1	2.31	2.31	∞
Uncertainty in SAR correction for deviations in permittivity and conductivity	E.3.2	1.9	N	1	1	0.84	1.90	1.60	∞
Liquid conductivity measurement	E.3.3	4.0	N	1	0.78	0.71	3.12	2.84	M
Liquid permittivity measurement	E.3.3	5.0	N	1	0.23	0.26	1.15	1.30	M
Liquid conductivity—temperature uncertainty	E.3.4	2.5	R	√3	0.78	0.71	1.13	1.02	∞
Liquid permittivity—temperature uncertainty	E.3.4	2.5	R	√3	0.23	0.26	0.33	0.38	∞
Combined Standard Uncertainty				RSS			9.718	9.517	
Expanded Uncertainty (95% Confidence interval)				K=2			19.437	19.035	

The results shown in this test report refer only to the sample(s) tested unless otherwise stated and the sample(s) are retained for 30 days only. The document is issued by AGC, this document cannot be reproduced except in full with our prior written permission. The more details and the authenticity of the report will be confirmed at <http://www.agc-cert.com>.

12. CONDUCTED POWER MEASUREMENT

GSM BAND

Mode	Frequency(MHz)	Avg. Burst Power(dBm)	Duty cycle Factor(dBm)	Frame Power(dBm)
Maximum Power <1>				
GSM 850	824.2	31.59	-9	22.59
	836.6	31.53	-9	22.53
	848.8	31.60	-9	22.60
GPRS 850 (1 Slot)	824.2	31.44	-9	22.44
	836.6	31.37	-9	22.37
	848.8	31.23	-9	22.23
GPRS 850 (2 Slot)	824.2	28.58	-6	22.58
	836.6	28.74	-6	22.74
	848.8	28.63	-6	22.63
GPRS 850 (3 Slot)	824.2	27.27	-4.26	23.01
	836.6	27.19	-4.26	22.93
	848.8	27.22	-4.26	22.96
GPRS 850 (4 Slot)	824.2	25.41	-3	22.41
	836.6	25.47	-3	22.47
	848.8	25.69	-3	22.69
EGPRS 850 (1 Slot)	824.2	25.07	-9	16.07
	836.6	25.14	-9	16.14
	848.8	25.35	-9	16.35
EGPRS 850 (2 Slot)	824.2	22.09	-6	16.09
	836.6	22.11	-6	16.11
	848.8	22.25	-6	16.25
EGPRS 850 (3 Slot)	824.2	21.29	-4.26	17.03
	836.6	21.22	-4.26	16.96
	848.8	21.39	-4.26	17.13
EGPRS 850 (4 Slot)	824.2	19.34	-3	16.34
	836.6	19.19	-3	16.19
	848.8	19.41	-3	16.41

The results shown in this test report refer only to the sample(s) tested unless otherwise stated and the sample(s) are retained for 30 days only. The document is issued by AGC, this document cannot be reproduced except in full with our prior written permission. The more details and the authenticity of the report will be confirmed at <http://www.agc-cert.com>.

Mode	Frequency(MHz)	Avg. Burst Power(dBm)	Duty cycle Factor(dBm)	Frame Power(dBm)
Maximum Power <2>				
GSM 850	824.2	31.52	-9	22.52
	836.6	31.50	-9	22.50
	848.8	31.55	-9	22.55
GPRS 850 (1 Slot)	824.2	31.41	-9	22.41
	836.6	31.35	-9	22.35
	848.8	31.21	-9	22.21
GPRS 850 (2 Slot)	824.2	28.55	-6	22.55
	836.6	28.71	-6	22.71
	848.8	28.60	-6	22.60
GPRS 850 (3 Slot)	824.2	27.23	-4.26	22.97
	836.6	27.15	-4.26	22.89
	848.8	27.18	-4.26	22.92
GPRS 850 (4 Slot)	824.2	25.36	-3	22.36
	836.6	25.42	-3	22.42
	848.8	25.61	-3	22.61

The results shown in this test report refer only to the sample(s) tested unless otherwise stated and the sample(s) are retained for 30 days only. The document is issued by AGC, this document cannot be reproduced except in full with our prior written permission. The more details and the authenticity of the report will be confirmed at <http://www.agc-cert.com>.

GSM BAND CONTINUE

Mode	Frequency(MHz)	Avg. Burst Power(dBm)	Duty cycle Factor(dBm)	Frame Power(dBm)
Maximum Power <1>				
PCS1900	1850.2	28.53	-9	19.53
	1880	28.65	-9	19.65
	1909.8	28.37	-9	19.37
GPRS1900 (1 Slot)	1850.2	28.59	-9	19.59
	1880	28.74	-9	19.74
	1909.8	28.50	-9	19.50
GPRS1900 (2 Slot)	1850.2	24.53	-6	18.53
	1880	24.42	-6	18.42
	1909.8	24.58	-6	18.58
GPRS1900 (3 Slot)	1850.2	23.39	-4.26	19.13
	1880	23.55	-4.26	19.29
	1909.8	23.52	-4.26	19.26
GPRS1900 (4 Slot)	1850.2	22.58	-3	19.58
	1880	22.83	-3	19.83
	1909.8	22.65	-3	19.65
EGPRS1900 (1 Slot)	1850.2	24.17	-9	15.17
	1880	24.32	-9	15.32
	1909.8	24.54	-9	15.54
EGPRS1900 (2 Slot)	1850.2	21.58	-6	15.58
	1880	21.69	-6	15.69
	1909.8	21.72	-6	15.72
EGPRS1900 (3 Slot)	1850.2	21.55	-4.26	17.29
	1880	21.36	-4.26	17.10
	1909.8	21.28	-4.26	17.02
EGPRS1900 (4 Slot)	1850.2	20.27	-3	17.27
	1880	20.49	-3	17.49
	1909.8	20.23	-3	17.23

The results shown in this test report refer only to the sample(s) tested unless otherwise stated and the sample(s) are retained for 30 days only. The document is issued by AGC, this document cannot be reproduced except in full with our prior written permission. The more details and the authenticity of the report will be confirmed at <http://www.agc-cert.com>.

Mode	Frequency(MHz)	Avg. Burst Power(dBm)	Duty cycle Factor(dBm)	Frame Power(dBm)
Maximum Power <2>				
PCS1900	1850.2	28.50	-9	19.50
	1880	28.63	-9	19.63
	1909.8	28.32	-9	19.32
GPRS1900 (1 Slot)	1850.2	28.53	-9	19.53
	1880	28.70	-9	19.70
	1909.8	28.47	-9	19.47
GPRS1900 (2 Slot)	1850.2	24.51	-6	18.51
	1880	24.38	-6	18.38
	1909.8	24.52	-6	18.52
GPRS1900 (3 Slot)	1850.2	23.35	-4.26	19.09
	1880	23.51	-4.26	19.25
	1909.8	23.50	-4.26	19.24
GPRS1900 (4 Slot)	1850.2	22.52	-3	19.52
	1880	22.81	-3	19.81
	1909.8	22.62	-3	19.62

Note 1:

The Frame Power (Source-based time-averaged Power) is scaled the maximum burst average power based on time slots. The calculated methods are show as following:

Frame Power = Max burst power (1 Up Slot) – 9 dB

Frame Power = Max burst power (2 Up Slot) – 6 dB

Frame Power = Max burst power (3 Up Slot) – 4.26 dB

Frame Power = Max burst power (4 Up Slot) – 3 dB

The results shown in this test report refer only to the sample(s) tested unless otherwise stated and the sample(s) are retained for 30 days only. The document is issued by AGC, this document cannot be reproduced except in full with our prior written permission. The more details and the authenticity of the report will be confirmed at <http://www.agc-cert.com>.

**UMTS BAND
 HSDPA Setup Configuration:**

- The EUT was connected to Base Station Agilent E5515C referred to the Setup Configuration.
- The RF path losses were compensated into the measurements.
- A call was established between EUT and Based Station with following setting:
 - (1) Set Gain Factors(β_c and β_d) parameters set according to each
 - (2) Set RMC 12.2Kbps+HSDPA mode.
 - (3) Set Cell Power=-86dBm
 - (4) Set HS-DSCH Configuration Type to FRC (H-set 1, QPSK)
 - (5) Select HSDPA Uplink Parameters
 - (6) Set Delta ACK, Delta NACK and Delta CQI=8
 - (7) Set Ack - Nack Repetition Factor to 3
 - (8) Set CQI Feedback Cycle (k) to 4ms
 - (9) Set CQI Repetition Factor to 2
 - (10) Power Ctrl Mode=All Up bits
- The transmitted maximum output power was recorded.

 Table C.10.2.4: β values for transmitter characteristics tests with HS-DPCCH

Sub-test	β_c (Note5)	β_d	β_d (SF)	β_c/β_d	β_{HS} (Note1, Note 2)	CM (dB) (Note 3)	MPR (dB) (Note 3)
1	2/15	15/15	64	2/15	4/15	0.0	0.0
2	12/15(Note 4)	15/15(Note 4)	64	12/15(Note 4)	24/15	1.0	0.0
3	15/15	8/15	64	15/8	30/15	1.5	0.5
4	15/15	4/15	64	15/4	30/15	1.5	0.5

Note 1: $\Delta ACK, \Delta NACK$ and $\Delta CQI = 30/15$ with $\beta_{hs} = 30/15 * \beta_c$.

Note 2: For the HS-DPCCH power mask requirement test in clause 5.2C, 5.7A, and the Error Vector Magnitude (EVM) with HS-DPCCH test in clause 5.13.1A, and HSDPA EVM with phase discontinuity in clause 5.13.1AA, ΔACK and $\Delta NACK = 30/15$ with $\beta_{hs} = 30/15 * \beta_c$, and $\Delta CQI = 24/15$ with $\beta_{hs} = 24/15 * \beta_c$.

Note 3: CM = 1 for $\beta_c/\beta_d = 12/15$, $h_s/c = 24/15$. For all other combinations of DPDCH, DPCCH and HS-DPCCH the MPR is based on the relative CM difference. This is applicable for only UEs that support HSDPA in release 6 and later releases.

Note 4: For subtest 2 the c/d ratio of 12/15 for the TFC during the measurement period (TF1, TF0) is achieved by setting the signalled gain factors for the reference TFC (TF1, TF1) to $c = 11/15$ and $d = 15/15$.

The results shown in this test report refer only to the sample(s) tested unless otherwise stated and the sample(s) are retained for 30 days only. The document is issued by AGC, this document cannot be reproduced except in full with our prior written permission. The more details and the authenticity of the report will be confirmed at <http://www.agc-cert.com>.

HSUPA Setup Configuration:

- The EUT was connected to Base Station Agilent E5515C referred to the Setup Configuration.
- The RF path losses were compensated into the measurements.
- A call was established between EUT and Base Station with following setting * :
 - (1) Call Configs = 5.2B, 5.9B, 5.10B, and 5.13.2B with QPSK
 - (2) Set the Gain Factors (β_c and β_d) and parameters (AG Index) were set according to each specific sub-test in the following table, C11.1.3, quoted from the TS 34.121
 - (3) Set Cell Power = -86 dBm
 - (4) Set Channel Type = 12.2k + HSPA
 - (5) Set UE Target Power
 - (6) Power Ctrl Mode= Alternating bits
 - (7) Set and observe the E-TFCI
 - (8) Confirm that E-TFCI is equal to the target E-TFCI of 75 for sub-test 1, and other subtest's E-TFCI
- The transmitted maximum output power was recorded.

 Table C.11.1.3: β values for transmitter characteristics tests with HS-DPCCH and E-DCH

Sub-test	β_c	β_d	β_d (SF)	β_c/β_d	β_{HS} (Note 1)	β_{ec}	β_{ed} (Note 4) (Note 5)	β_{ed} (SF)	β_{ed} (Code s)	CM (dB) (Note 2)	MPR (dB) (Note 2) (Note 6)	AG Index (Note 5)	E-TF CI
1	11/15 (Note 3)	15/15 (Note 3)	64	11/15 (Note 3)	22/15	209/225	1309/225	4	1	1.0	0.0	20	75
2	6/15	15/15	64	6/15	12/15	12/15	94/75	4	1	3.0	2.0	12	67
3	15/15	9/15	64	15/9	30/15	30/15	β_{ed1} : 47/15 β_{ed2} : 47/15	4	2	2.0	1.0	15	92
4	2/15	15/15	64	2/15	4/15	2/15	56/75	4	1	3.0	2.0	17	71
5	15/15	0	-	-	5/15	5/15	47/15	4	1	1.0	0.0	12	67

Note 1: For sub-test 1 to 4, ΔACK , $\Delta NACK$ and $\Delta CQI = 30/15$ with $\beta_{hs} = 30/15 * \beta_c$. For sub-test 5, ΔACK , $\Delta NACK$ and $\Delta CQI = 5/15$ with $\beta_{hs} = 5/15 * \beta_c$.

Note 2: CM = 1 for $\beta_c/\beta_d = 12/15$, $hs/c = 24/15$. For all other combinations of DPDCH, DPCCH, HS-DPCCH, E-DPDCH and E-DPCCH the MPR is based on the relative CM difference.

Note 3: For subtest 1 the c/d ratio of 11/15 for the TFC during the measurement period (TF1, TF0) is achieved by setting the signalled gain factors for the reference TFC (TF1, TF1) to $c = 10/15$ and $d = 15/15$.

Note 4: In case of testing by UE using E-DPDCH Physical Layer category 1, Sub-test 3 is omitted according to TS25.306 Table 5.1g.

Note 5: β_{ed} cannot be set directly; it is set by Absolute Grant Value.

Note 6: For subtests 2, 3 and 4, UE may perform E-DPDCH power scaling at max power which could results in slightly smaller MPR values.

UMTS BAND II

Mode	Frequency (MHz)	Avg. Burst Power (dBm)
WCDMA 1900 RMC	1852.4	20.89
	1880	21.66
	1907.6	21.69
WCDMA 1900 AMR	1852.4	20.51
	1880	20.92
	1907.6	20.72
HSDPA Subtest 1	1852.4	19.80
	1880	20.58
	1907.6	20.10
HSDPA Subtest 2	1852.4	19.86
	1880	20.08
	1907.6	19.81
HSDPA Subtest 3	1852.4	20.72
	1880	19.90
	1907.6	20.95
HSDPA Subtest 4	1852.4	21.26
	1880	21.32
	1907.6	21.40
HSUPA Subtest 1	1852.4	21.65
	1880	20.06
	1907.6	20.83
HSUPA Subtest 2	1852.4	20.74
	1880	20.10
	1907.6	20.25
HSUPA Subtest 3	1852.4	21.08
	1880	20.21
	1907.6	20.09
HSUPA Subtest 4	1852.4	19.93
	1880	19.81
	1907.6	19.96
HSUPA Subtest 5	1852.4	19.85
	1880	19.96
	1907.6	19.98

The results shown in this test report refer only to the sample(s) tested unless otherwise stated and the sample(s) are retained for 30 days only. The document is issued by AGC, this document cannot be reproduced except in full with our prior written permission. The more details and the authenticity of the report will be confirmed at <http://www.agc-cert.com>.

UMTS BAND IV

Mode	Frequency (MHz)	Avg. Burst Power (dBm)
WCDMA 1700 RMC	1712.5	21.82
	1732.5	21.89
	1752.5	21.92
WCDMA 1700 AMR	1712.5	20.74
	1732.5	21.15
	1752.5	20.95
HSDPA Subtest 1	1712.5	20.03
	1732.5	20.81
	1752.5	20.33
HSDPA Subtest 2	1712.5	20.09
	1732.5	20.31
	1752.5	20.04
HSDPA Subtest 3	1712.5	20.95
	1732.5	20.13
	1752.5	21.18
HSDPA Subtest 4	1712.5	21.49
	1732.5	21.55
	1752.5	21.63
HSUPA Subtest 1	1712.5	21.88
	1732.5	20.29
	1752.5	21.06
HSUPA Subtest 2	1712.5	20.97
	1732.5	20.33
	1752.5	20.48
HSUPA Subtest 3	1712.5	21.31
	1732.5	20.44
	1752.5	20.32
HSUPA Subtest 4	1712.5	20.16
	1732.5	20.04
	1752.5	20.19
HSUPA Subtest 5	1712.5	20.08
	1732.5	20.19
	1752.5	20.21

The results shown in this test report refer only to the sample(s) tested unless otherwise stated and the sample(s) are retained for 30 days only. The document is issued by AGC, this document cannot be reproduced except in full with our prior written permission. The more details and the authenticity of the report will be confirmed at <http://www.agc-cert.com>.

UMTS BAND V

Mode	Frequency (MHz)	Avg. Burst Power (dBm)
WCDMA 850 RMC	826.4	21.70
	836.6	21.47
	846.6	21.50
WCDMA 850 AMR	826.4	20.32
	836.6	20.73
	846.6	20.53
HSDPA Subtest 1	826.4	20.61
	836.6	20.39
	846.6	20.91
HSDPA Subtest 2	826.4	20.67
	836.6	20.89
	846.6	20.62
HSDPA Subtest 3	826.4	20.53
	836.6	20.71
	846.6	20.76
HSDPA Subtest 4	826.4	21.07
	836.6	21.13
	846.6	21.21
HSUPA Subtest 1	826.4	20.46
	836.6	20.87
	846.6	21.64
HSUPA Subtest 2	826.4	20.55
	836.6	20.91
	846.6	21.06
HSUPA Subtest 3	826.4	20.89
	836.6	21.02
	846.6	20.90
HSUPA Subtest 4	826.4	20.74
	836.6	20.62
	846.6	20.77
HSUPA Subtest 5	826.4	20.66
	836.6	20.77
	846.6	20.79

The results shown in this test report refer only to the sample(s) tested unless otherwise stated and the sample(s) are retained for 30 days only. The document is issued by AGC, this document cannot be reproduced except in full with our prior written permission. The more details and the authenticity of the report will be confirmed at <http://www.agc-cert.com>.

According to 3GPP 25.101 sub-clause 6.2.2 , the maximum output power is allowed to be reduced by following the table.

Table 6.1aA: UE maximum output power with HS-DPCCH and E-DCH

UE Transmit Channel Configuration	CM(db)	MPR(db)
For all combinations of ,DPDCH,DPCCH HS-DPDCH,E-DPDCH and E-DPCCH	$0 \leq CM \leq 3.5$	$MAX(CM-1,0)$

Note: CM=1 for $\beta_d/\beta_{d=12/15}$, $\beta_{hs}/\beta_c=24/15$. For all other combinations of DPDCH, DPCCH, HS-DPCCH, E-DPDCH and E-DPCCH the MPR is based on the relative CM difference.

The device supports MPR to solve linearity issues (ACLR or SEM) due to the higher peak-to average ratios (PAR) of the HSUPA signal. This prevents saturating the full range of the TX DAC inside of device and provides a reduced power output to the RF transceiver chip according to the Cubic Metric (a function of the combinations of DPDCH, DPCCH, HS-DPCCH, E-DPDCH and E-DPCCH).

When E-DPDCH channels are present the beta gains on those channels are reduced firsts to try to get the power under the allowed limit. If the beta gains are lowered as far as possible, then a hard limiting is applied at the maximum allowed level.

The SW currently recalculates the cubic metric every time the beta gains on the E-DPDCH are reduced. The cubic metric will likely get lower each time this is done .However, there is no reported reduction of maximum output power in the HSUPA mode since the device also provides a compensation for the power back-off by increasing the gain of TX_AG_C in the transceiver (PA) device.

The end effect is that the DUT output power is identical to the case where there is no MPR in the device.

The results shown in this test report refer only to the sample(s) tested unless otherwise stated and the sample(s) are retained for 30 days only. The document is issued by AGC, this document cannot be reproduced except in full with our prior written permission. The more details and the authenticity of the report will be confirmed at <http://www.agc-cert.com>.

LTE Band

Conducted Power of LTE Band 2(dBm)							
Bandwidth	Modulation	RB size	RB offset	Target MPR	Channel	Channel	Channel
					18607	18900	19193
1.4MHz	QPSK	1	0	0	22.33	21.80	21.69
			3	0	22.31	21.65	21.66
			5	0	22.28	21.51	21.64
		3	0	0	22.11	21.43	21.25
			2	0	22.18	21.48	21.29
			3	0	22.24	21.52	21.36
	6	0	1	21.43	20.79	20.40	
	16QAM	1	0	1	22.41	21.34	21.04
			3	1	22.39	21.35	20.97
			5	1	22.36	21.33	20.86
		3	0	1	22.31	21.05	20.44
			2	1	22.36	21.18	20.57
			3	1	22.40	21.26	20.65
		6	0	2	21.47	20.26	19.96
Bandwidth		Modulation	RB size	RB offset	Target MPR	Channel	Channel
					18615	18900	19185
3MHz	QPSK	1	0	0	22.25	21.74	21.48
			7	0	22.21	21.55	21.46
			14	0	22.17	21.12	21.47
		8	0	1	21.22	20.23	20.35
			4	1	21.29	20.36	20.41
			7	1	21.37	20.57	20.47
	15	0	1	21.34	20.67	20.37	
	16QAM	1	0	1	22.20	21.41	21.08
			7	1	22.19	21.39	20.88
			14	1	22.18	21.31	20.61
		8	0	2	21.32	20.12	19.52
			4	2	21.37	20.24	19.57
			7	2	21.39	20.33	19.64
		15	0	2	21.36	20.24	19.75

The results shown in this test report refer only to the sample(s) tested unless otherwise stated and the sample(s) are retained for 30 days only. The document is issued by AGC, this document cannot be reproduced except in full with our prior written permission. The more details and the authenticity of the report will be confirmed at <http://www.agc-cert.com>.

Conducted Power of LTE Band 2(dBm)								
Bandwidth	Modulation	RB size	RB offset	Target MPR	Channel	Channel	Channel	
					18625	18900	19175	
5MHz	QPSK	1	0	0	21.77	21.56	22.50	
			12	0	21.82	20.97	22.46	
			24	0	21.88	20.71	22.41	
		12	0	1	20.74	19.67	20.86	
			6	1	20.83	19.75	20.96	
			11	1	20.88	19.82	21.02	
	25	0	1	20.78	20.06	20.85		
	16QAM	1	0	1	23.19	20.94	20.54	
			12	1	23.11	21.03	19.96	
			24	1	23.00	21.09	19.79	
		12	0	2	21.74	19.88	18.84	
			6	2	21.79	19.92	18.92	
			11	2	21.85	19.96	18.95	
		25	0	2	21.81	19.76	19.16	
		Bandwidth	Modulation	RB size	RB offset	Target MPR	Channel	Channel
18650							18900	19150
10MHz	QPSK	1	0	0	21.57	21.51	21.73	
			24	0	21.36	20.69	21.71	
			49	0	21.13	20.02	21.67	
		25	0	1	20.55	19.76	20.52	
			12	1	20.59	19.79	20.58	
			25	1	20.63	19.82	20.63	
	50	0	1	20.82	20.15	20.62		
	16QAM	1	0	1	22.45	20.87	20.89	
			24	1	22.38	20.65	20.15	
			49	1	22.30	20.44	19.54	
		25	0	2	21.21	19.58	18.86	
			12	2	21.34	19.62	18.89	
			25	2	21.55	19.69	18.93	
		50	0	2	21.57	19.85	19.26	

The results shown in this test report refer only to the sample(s) tested unless otherwise stated and the sample(s) are retained for 30 days only. The document is issued by AGC, this document cannot be reproduced except in full with our prior written permission. The more details and the authenticity of the report will be confirmed at <http://www.agc-cert.com>.

Conducted Power of LTE Band 2(dBm)								
Bandwidth	Modulation	RB size	RB offset	Target MPR	Channel	Channel	Channel	
					18675	18900	19125	
15MHz	QPSK	1	0	0	21.66	22.23	21.54	
			37	0	21.28	21.58	21.63	
			74	0	20.87	20.13	21.71	
		36	0	1	20.06	19.64	20.21	
			16	1	21.14	19.75	20.33	
			35	1	20.27	19.87	20.54	
	75	0	1	20.56	20.41	20.51		
	16QAM	1	0	1	22.30	20.91	21.54	
			37	1	22.32	20.47	20.56	
			74	1	22.35	20.24	19.51	
		36	0	2	21.34	19.02	18.66	
			16	2	21.39	19.15	18.78	
			35	2	21.48	19.29	18.94	
		75	0	2	21.45	19.60	19.47	
		Bandwidth	Modulation	RB size	RB offset	Target MPR	Channel	Channel
18700							18900	19100
20MHz	QPSK	1	0	0	22.53	22.68	22.58	
			49	0	21.45	21.77	21.25	
			99	0	21.18	20.43	21.53	
		50	0	1	20.12	19.87	20.21	
			25	1	20.08	19.92	20.33	
			49	1	20.04	19.96	20.47	
	100	0	1	20.40	20.67	20.44		
	16QAM	1	0	1	22.07	20.97	22.03	
			49	1	22.13	20.63	21.11	
			99	1	22.30	20.40	19.52	
		50	0	2	21.17	18.93	18.96	
			25	2	21.34	18.99	19.02	
			49	2	21.42	19.06	19.09	
		100	0	2	21.39	19.42	19.80	

The results shown in this test report refer only to the sample(s) tested unless otherwise stated and the sample(s) are retained for 30 days only. The document is issued by AGC, this document cannot be reproduced except in full with our prior written permission. The more details and the authenticity of the report will be confirmed at <http://www.agc-cert.com>.

Conducted Power of LTE Band 4(dBm)							
Bandwidth	Modulation	RB size	RB offset	Target MPR	Channel	Channel	Channel
					19957	20175	20393
1.4MHz	QPSK	1	0	0	22.87	22.46	21.63
			2	0	22.85	22.49	21.62
			5	0	22.83	22.53	21.58
		3	0	0	22.43	22.33	21.12
			1	0	22.57	22.39	21.24
			2	0	22.76	22.45	21.29
	6	0	1	21.90	21.64	20.47	
	16QAM	1	0	1	22.06	21.88	21.51
			2	1	22.01	21.87	21.53
			5	1	21.97	21.86	21.55
		3	0	1	22.03	21.63	21.23
			1	1	22.11	21.75	21.33
			2	1	22.19	21.77	21.39
		6	0	2	21.68	20.75	20.58
Bandwidth		Modulation	RB size	RB offset	Target MPR	Channel	Channel
					19965	20175	20385
3MHz	QPSK	1	0	0	22.66	22.44	21.50
			7	0	22.61	22.49	21.38
			14	0	22.59	22.55	21.24
		8	0	1	21.67	21.52	20.47
			4	1	21.74	21.58	20.53
			7	1	21.81	21.63	20.56
	15	0	1	21.80	21.50	20.40	
	16QAM	1	0	1	21.96	21.84	21.61
			7	1	21.77	21.82	21.62
			14	1	21.69	21.78	21.63
		8	0	2	21.43	20.56	20.42
			4	2	21.52	20.65	20.48
			7	2	21.56	20.77	20.52
		15	0	2	21.58	20.69	20.42

The results shown in this test report refer only to the sample(s) tested unless otherwise stated and the sample(s) are retained for 30 days only. The document is issued by AGC, this document cannot be reproduced except in full with our prior written permission. The more details and the authenticity of the report will be confirmed at <http://www.agc-cert.com>.

Conducted Power of LTE Band 4(dBm)								
Bandwidth	Modulation	RB size	RB offset	Target MPR	Channel	Channel	Channel	
					19975	20175	20375	
5MHz	QPSK	1	0	0	22.83	22.56	21.51	
			12	0	22.74	22.63	21.36	
			24	0	22.61	22.67	21.25	
		12	0	1	21.64	21.43	20.31	
			6	1	21.69	21.52	20.37	
			11	1	21.75	21.55	20.43	
	25	0	1	21.74	21.48	20.44		
	16QAM	1	0	1	22.02	22.02	21.39	
			13	1	21.93	21.96	21.37	
			24	1	21.80	21.82	21.38	
		12	0	2	21.12	20.77	20.46	
			6	2	21.17	20.79	20.55	
			13	2	21.21	20.82	20.60	
		25	0	2	21.37	20.71	20.45	
		Bandwidth	Modulation	RB size	RB offset	Target MPR	Channel	Channel
20000							20175	20350
10MHz	QPSK	1	0	0	22.53	22.48	21.47	
			24	0	22.46	22.52	21.03	
			49	0	22.37	22.55	20.79	
		25	0	1	21.23	21.37	20.02	
			12	1	21.35	21.42	20.09	
			25	1	21.48	21.46	20.18	
	50	0	1	21.60	21.47	20.42		
	16QAM	1	0	1	21.89	21.91	21.76	
			24	1	21.67	21.65	21.71	
			49	1	21.32	21.49	21.69	
		25	0	2	20.84	20.13	20.34	
			12	2	20.93	20.35	20.39	
			25	2	20.98	20.42	20.43	
		50	0	2	21.38	20.55	20.46	

The results shown in this test report refer only to the sample(s) tested unless otherwise stated and the sample(s) are retained for 30 days only. The document is issued by AGC, this document cannot be reproduced except in full with our prior written permission. The more details and the authenticity of the report will be confirmed at <http://www.agc-cert.com>.

Conducted Power of LTE Band 4(dBm)								
Bandwidth	Modulation	RB size	RB offset	Target MPR	Channel	Channel	Channel	
					20025	20175	20325	
15MHz	QPSK	1	0	0	22.64	22.08	21.48	
			37	0	22.35	22.33	21.28	
			74	0	22.16	22.63	21.05	
		36	0	1	21.24	21.47	20.05	
			16	1	21.38	21.53	20.11	
			35	1	21.57	21.60	20.14	
		75	0	1	21.67	21.69	20.63	
		16QAM	1	0	1	22.26	21.92	21.29
				37	1	21.94	21.64	21.36
	74			1	21.63	21.42	21.62	
	36		0	2	20.56	20.31	20.45	
			16	2	20.87	20.39	20.51	
			35	2	20.92	20.44	20.55	
	75	0	2	21.32	20.55	20.59		
	Bandwidth	Modulation	RB size	RB offset	Target MPR	Channel	Channel	Channel
20050						20175	20300	
20MHz	QPSK	1	0	0	22.83	22.76	22.50	
			49	0	22.25	22.45	21.34	
			99	0	21.83	22.71	21.11	
		50	0	1	21.22	21.34	19.87	
			25	1	21.29	21.46	19.95	
			49	1	21.34	21.52	20.07	
		100	0	1	21.45	21.57	20.46	
		16QAM	1	0	1	22.56	21.95	21.25
				49	1	22.03	21.63	21.44
	99			1	21.86	21.07	21.79	
	50		0	2	20.88	20.01	20.23	
			25	2	20.93	20.17	20.38	
			49	2	20.97	20.23	20.51	
	100		0	2	21.43	20.36	20.54	

The results shown in this test report refer only to the sample(s) tested unless otherwise stated and the sample(s) are retained for 30 days only. The document is issued by AGC, this document cannot be reproduced except in full with our prior written permission. The more details and the authenticity of the report will be confirmed at <http://www.agc-cert.com>.

Conducted Power of LTE Band 5(dBm)								
Bandwidth	Modulation	RB size	RB offset	Target MPR	Channel	Channel	Channel	
					20407	20525	20643	
1.4MHz	QPSK	1	0	0	20.51	21.34	21.14	
			2	0	20.49	21.33	21.15	
			5	0	20.47	21.34	21.17	
		3	0	0	20.33	21.12	20.77	
			1	0	20.39	21.23	20.85	
			2	0	20.41	21.26	20.87	
		6	0	1	19.48	20.49	19.86	
		16QAM	1	0	1	21.96	19.46	20.49
				2	1	21.99	19.45	20.43
	5			1	22.00	19.43	20.38	
	3		0	1	21.87	19.27	20.05	
			1	1	21.93	19.31	20.16	
			2	1	21.96	19.36	20.21	
	6	0	2	21.07	18.35	19.36		
	Bandwidth	Modulation	RB size	RB offset	Target MPR	Channel	Channel	Channel
					20415	20525	20635	
3MHz	QPSK	1	0	0	20.45	21.42	20.94	
			7	0	20.47	21.37	20.99	
			14	0	20.50	21.32	21.03	
		8	0	1	19.45	20.34	19.89	
			4	1	19.49	20.40	19.92	
			7	1	19.52	20.44	19.96	
		15	0	1	19.46	20.35	19.85	
		16QAM	1	0	1	21.82	19.53	20.55
				7	1	21.87	19.57	20.49
	14			1	21.91	19.60	20.41	
	8		0	2	20.89	18.35	19.03	
			4	2	20.96	18.42	19.18	
			7	2	21.07	18.49	19.25	
	15		0	2	20.98	18.40	19.22	

The results shown in this test report refer only to the sample(s) tested unless otherwise stated and the sample(s) are retained for 30 days only. The document is issued by AGC, this document cannot be reproduced except in full with our prior written permission. The more details and the authenticity of the report will be confirmed at <http://www.agc-cert.com>.

Conducted Power of LTE Band 5(dBm)								
Bandwidth	Modulation	RB size	RB offset	Target MPR	Channel	Channel	Channel	
					20425	20525	20625	
5MHz	QPSK	1	0	0	20.60	21.70	21.09	
			12	0	20.75	21.55	21.14	
			24	0	20.98	21.24	21.18	
		12	0	1	19.62	20.24	19.88	
			6	1	19.73	20.32	19.95	
			11	1	19.77	20.37	20.05	
		25	0	1	19.56	20.43	19.90	
		16QAM	1	0	1	20.41	19.74	20.49
				12	1	20.58	20.07	20.29
	24			1	20.78	20.13	20.19	
	12		0	2	19.97	18.75	19.05	
			6	2	20.02	18.83	19.21	
			11	2	21.06	18.88	19.27	
	25	0	2	20.96	18.57	19.31		
	Bandwidth	Modulation	RB size	RB offset	Target MPR	Channel	Channel	Channel
					20450	20525	20600	
10MHz	QPSK	1	0	0	20.62	21.73	21.12	
			24	0	20.76	21.58	21.17	
			49	0	20.99	21.25	21.22	
		25	0	1	19.64	20.25	19.92	
			12	1	19.77	20.36	19.98	
			25	1	19.79	20.41	20.07	
		50	0	1	19.59	20.39	19.93	
		16QAM	1	0	1	20.42	19.71	20.51
				24	1	20.61	20.04	20.27
	49			1	20.81	20.16	20.22	
	25		0	2	19.99	18.78	19.06	
			12	2	20.05	18.86	19.23	
			25	2	21.08	18.91	19.31	
	50	0	2	20.97	18.55	19.33		

The results shown in this test report refer only to the sample(s) tested unless otherwise stated and the sample(s) are retained for 30 days only. The document is issued by AGC, this document cannot be reproduced except in full with our prior written permission. The more details and the authenticity of the report will be confirmed at <http://www.agc-cert.com>.

Conducted Power of LTE Band 12(dBm)								
Bandwidth	Modulation	RB size	RB offset	Target MPR	Channel	Channel	Channel	
					23017	23095	23173	
1.4MHz	QPSK	1	0	0	25.37	21.90	22.83	
			2	0	25.44	21.87	22.64	
			5	0	25.49	21.85	22.46	
		3	0	0	25.21	21.92	22.12	
			1	0	25.29	21.98	22.18	
			2	0	25.36	22.01	22.24	
		6	0	1	24.46	21.50	21.43	
		16QAM	1	0	1	23.83	24.39	21.31
				2	1	23.56	24.42	21.30
	5			1	23.41	24.45	21.28	
	3		0	1	23.23	24.28	21.06	
			1	1	23.31	24.33	21.13	
			2	1	23.39	24.39	21.18	
	6	0	2	22.67	23.31	20.67		
	Bandwidth	Modulation	RB size	RB offset	Target MPR	Channel	Channel	Channel
					23025	23095	23165	
3MHz	QPSK	1	0	0	25.48	22.58	23.11	
			7	0	25.56	22.03	22.87	
			14	0	25.73	21.94	22.05	
		8	0	1	24.75	21.45	21.12	
			4	1	24.82	21.53	21.26	
			7	1	24.87	21.57	21.34	
		15	0	1	24.71	21.51	21.46	
		16QAM	1	0	1	24.03	24.68	21.60
				7	1	23.77	24.69	21.55
	14			1	22.98	24.71	21.41	
	8		0	2	22.12	23.66	20.45	
			4	2	22.36	23.72	20.53	
			7	2	22.40	23.75	20.55	
	15		0	2	22.59	23.65	20.39	

The results shown in this test report refer only to the sample(s) tested unless otherwise stated and the sample(s) are retained for 30 days only. The document is issued by AGC, this document cannot be reproduced except in full with our prior written permission. The more details and the authenticity of the report will be confirmed at <http://www.agc-cert.com>.

Conducted Power of LTE Band 12(dBm)								
Bandwidth	Modulation	RB size	RB offset	Target MPR	Channel	Channel	Channel	
					23035	23095	23155	
5MHz	QPSK	1	0	0	25.64	22.66	23.78	
			12	0	25.57	22.13	23.02	
			24	0	25.31	21.92	22.07	
		12	0	1	24.56	21.15	21.11	
			6	1	24.62	21.29	21.18	
			11	1	24.68	21.38	21.26	
	25	0	1	24.65	21.56	21.64		
	16QAM	1	0	1	24.43	24.90	21.51	
			12	1	23.57	24.67	21.34	
			24	1	22.86	24.51	21.02	
		12	0	2	22.06	23.51	20.35	
			6	2	22.12	23.57	20.39	
			11	2	22.18	23.61	20.45	
		25	0	2	22.65	23.58	20.47	
		Bandwidth	Modulation	RB size	RB offset	Target MPR	Channel	Channel
						23060	23095	23130
10MHz	QPSK	1	0	0	25.66	23.63	23.88	
			24	0	25.55	22.15	23.07	
			49	0	25.33	21.95	22.56	
		25	0	1	24.59	21.17	21.23	
			12	1	24.64	21.31	21.21	
			25	1	24.71	21.42	21.33	
	50	0	1	24.63	21.54	21.59		
	16QAM	1	0	1	24.45	24.92	21.53	
			24	1	23.61	24.69	21.37	
			49	1	22.84	24.53	21.14	
		25	0	2	22.02	23.56	20.38	
			12	2	22.09	23.63	20.41	
			25	2	22.15	23.65	20.47	
		50	0	2	22.62	23.61	20.49	

The results shown in this test report refer only to the sample(s) tested unless otherwise stated and the sample(s) are retained for 30 days only. The document is issued by AGC, this document cannot be reproduced except in full with our prior written permission. The more details and the authenticity of the report will be confirmed at <http://www.agc-cert.com>.

The following tests were conducted according to the test requirements outlined in section 6.2 of the 3GPP TS36.101 specification.

UE Power Class: 3 (23 +/- 2dBm). The allowed Maximum Power Reduction (MPR) for the maximum output power due to higher order modulation and transmit bandwidth configuration (resource blocks) is specified in Table 6.2.3.3-1 of the 3GPP TS36.101.

Table 6.2.3.3-1 Maximum Power Reduction (MPR) for Power class3

Modulation	Maximum Power Reduction (MPR) for Power[RB]						MPR(dB)
	1.4MHz	3MHz	5MHz	10MHz	15MHz	20MHz	
QPSK	>5	>4	>8	>12	>16	>18	≤1
16QAM	≤5	≤4	≤8	≤12	≤16	≤18	≤1
16QAM	>5	>4	>8	>12	>16	>18	≤2

The allowed A-MPR values specified below in Table 6.2.4.3-1 of 3GPP TS36.101 are in addition to the allowed MPR requirements. All the measurements below were performed with A-MPR disabled, by using Network Signaling Value of "NS_01".3

The results shown in this test report refer only to the sample(s) tested unless otherwise stated and the sample(s) are retained for 30 days only. The document is issued by AGC, this document cannot be reproduced except in full with our prior written permission. The more details and the authenticity of the report will be confirmed at <http://www.agc-cert.com>.

Table 6.2.4.3-1: Additional Maximum Power Reduction (A-MPR) / Spectrum Emission requirements

Network Signaling value	Requirements (sub-clause)	E-UTRA Band	Channel bandwidth (MHz)	Resources Blocks (N_{RB})	A-MPR (dB)
NS_01	6.6.2.1.1	Table 5.2-1	1,4,3,5,10,15,20	Table 5.4.2-1	N/A
NS_03	6.6.2.2.3.1	2,4,10, 23, 25,35,36	3	>5	≤ 1
			5	>6	≤ 1
			10	>6	≤ 1
			15	>8	≤ 1
			20	>10	≤ 1
NS_04	6.6.2.2.3.2	41	5	>6	≤ 1
			10, 15, 20	Table 6.2.4.3-4	
NS_05	6.6.3.3.3.1	1	10,15,20	≥ 50	≤ 1
NS_06	6.6.2.2.3.3	12, 13, 14, 17	1.4, 3, 5, 10	Table 5.4.2-1	N/A
NS_07	6.6.2.2.3.3 6.6.3.3.3.2	13	10	Table 6.2.4.3-2	Table 6.2.4.3-2
NS_08	6.6.3.3.3.3	19	10, 15	> 44	≤ 3
NS_09	6.6.3.3.3.4	21	10, 15	> 40	≤ 1
				> 55	≤ 2
				Table 6.2.4.3-3	
NS_10		20	15, 20	Table 6.2.4.3-3	Table 6.2.4.3-3
NS_11	6.6.2.2.1 6.6.3.3.13	231	1.4, 3, 5, 10,15,20	Table 6.2.4.3-5	Table 6.2.4.3-5
NS_12	6.6.3.3.5	26	1.4, 3, 5	Table 6.2.4.3-6	Table 6.2.4.3-6
NS_13	6.6.3.3.6	26	5	Table 6.2.4.3-7	Table 6.2.4.3-7
NS_14	6.6.3.3.7	26	10, 15	Table 6.2.4.3-8	Table 6.2.4.3-8
NS_15	6.6.3.3.8	26	1.4, 3, 5, 10, 15	Table 6.2.4.3-9 Table 6.2.4.3-10	Table 6.2.4.3-9, Table 6.2.4.3-10
NS_16	6.6.3.3.9	27	3, 5, 10	Table 6.2.4.3-11, Table 6.2.4.3-12, Table 6.2.4.3-13	
NS_17	6.6.3.3.10	28	5, 10	Table 5.4.2-1	N/A
	6.6.3.3.11	28	5	≥ 2	≤ 1
NS_18			10, 15, 20	≥ 1	≤ 4
NS_19			10, 15, 20	Table 6.2.4.3-15	Table 6.2.4.3-15
NS_20			5, 10, 15, 20	Table 6.2.4.3-14	Table 6.2.4.3-14
...					
NS_20	-	-	-	-	-

The results shown in this test report refer only to the sample(s) tested unless otherwise stated and the sample(s) are retained for 30 days only. The document is issued by AGC, this document cannot be reproduced except in full with our prior written permission. The more details and the authenticity of the report will be confirmed at <http://www.agc-cert.com>.

WIFI

Mode	Data Rate (Mbps)	Channel	Frequency(MHz)	Avg. Burst Power(dBm)
802.11b	1	01	2412	12.79
		06	2437	12.79
		11	2462	12.91
802.11g	6	01	2412	9.11
		06	2437	11.19
		11	2462	10.92
802.11n(20)	6.5	01	2412	9.05
		06	2437	10.96
		11	2462	10.82
802.11n(40)	13.5	03	2422	10.42
		06	2437	10.54
		09	2452	10.76

Bluetooth_V4.0(BR/EDR)

Modulation	Channel	Frequency(MHz)	Peak Power (dBm)
GFSK	0	2402	2.899
	39	2441	3.233
	78	2480	3.323
π /4-DQPSK	0	2402	1.792
	39	2441	1.992
	78	2480	1.531
8-DPSK	0	2402	1.232
	39	2441	1.306
	78	2480	1.126

Bluetooth_V4.0(BLE)

Modulation	Channel	Frequency(MHz)	Peak Power (dBm)
GFSK	0	2402	5.311
	19	2440	5.638
	39	2480	5.659

The results shown in this test report refer only to the sample(s) tested unless otherwise stated and the sample(s) are retained for 30 days only. The document is issued by AGC, this document cannot be reproduced except in full with our prior written permission. The more details and the authenticity of the report will be confirmed at <http://www.agc-cert.com>.

13. TEST RESULTS

13.1. SAR Test Results Summary

13.1.1. Test position and configuration

Head SAR was performed with the device configured in the positions according to IEEE 1528-2013, Body-worn SAR was performed with the device 10mm from the phantom, and 4 Edges SAR was performed with the device 10mm from the phantom.

13.1.2. Operation Mode

1. Per KDB 447498 D01 v06 ,for each exposure position, if the highest 1-g SAR is ≤ 0.8 W/kg, testing for low and high channel is optional.
2. Per KDB 865664 D01 v01r04,for each frequency band, if the measured SAR is ≥ 0.8 W/Kg, testing for repeated SAR measurement is required , that the highest measured SAR is only to be tested. When the SAR results are near the limit, the following procedures are required for each device to verify these types of SAR measurement related variation concerns by repeating the highest measured SAR configuration in each frequency band.
 - (1) When the original highest measured SAR is ≥ 0.8 W/Kg, repeat that measurement once.
 - (2) Perform a second repeated measurement only if the ratio of largest to smallest SAR for the original and first repeated measurements is >1.20 or when the original or repeated measurement is ≥ 1.45 W/Kg.
 - (3) Perform a third repeated measurement only if the original, first and second repeated measurement is ≥ 1.5 W/Kg and ratio of largest to smallest SAR for the original, first and second measurement is ≥ 1.20 .
3. Body-worn exposure conditions are intended to voice call operations, therefore GSM voice call mode is selected to be test.
4. Per KDB 648474 D04 v01r03,when the reported SAR for a body-worn accessory measured without a headset connected to the handset is ≤ 1.2 W/Kg, SAR testing with a headset connected is not required.
5. Per KDB 248227 D01v02r02,for 2.4GHz 802.11g/n SAR testing is not required when the highest reported SAR for DSSS is adjusted by the ratio of OFDM to DSSS specified maximum output power and the adjusted SAR is ≤ 1.2 W/kg.
6. Per KDB 941225 D06 V02r01, When the same wireless mode transmission configurations for voice and data are required for SAR measurements, the more conservative configuration with a smaller separation distance should be tested for the overlapping SAR configurations.
7. Maximum Scaling SAR in order to calculate the Maximum SAR values to test under the standard Peak Power, Calculation method is as follows:
Maximum Scaling SAR =tested SAR (Max.) \times [maximum turn-up power (mw)/ maximum measurement output power(mw)]
8. Proximity sensor, just for avoiding the wrong operation in the phone screen when call, and has no influence on output power or SAR result
9. Per KDB 941225 D05v02r03, start with the largest channel bandwidth and measure SAR for QPSK with 1RB allocation using the RB offset and required test channel combination with highest maximum output power for RB offsets at the upper edge, middle and lower edge of each required test channel.
10. Per KDB 941125 D05v02r03, 50% RB allocation for QPSK SAR testing follows 1RB QPSK allocation procedure.

The results shown in this test report refer only to the sample(s) tested unless otherwise stated and the sample(s) are retained for 30 days only. The document is issued by AGC, this document cannot be reproduced except in full with our prior written permission. The more details and the authenticity of the report will be confirmed at <http://www.agc-cert.com>.

11. Per KDB 941125 D05v02r03. For QPSK with 100% RB allocation. SAR is not required when the highest maximum output power for 100% RB allocation is less than the highest maximum output power in 50% and 1RB allocation and the highest reported SAR is >1.45 W/Kg, the remaining required test channels must also be tested.
12. Per KDB 941125 D05v02r03. 16QAM output power for each RB allocation configuration is not 1/2 dB higher than the same configuration in QPSK and the reported SAR for the QPSK configuration is ≤ 1.45 W/Kg, Per KDB 941225 D05v02r02, 16QAM SAR testing is not required.
13. Per KDB 941125 D05v02r03. Smaller bandwidth output power for each RB allocation configuration is $>$ not 1/2 dB higher than the same configuration in the largest supported bandwidth, and the reported SAR for the largest supported bandwidth is ≤ 1.45 W/Kg. Per KDB 941125 D05v02r03, smaller bandwidth SAR testing is not required.

The results shown in this test report refer only to the sample(s) tested unless otherwise stated and the sample(s) are retained for 30 days only. The document is issued by AGC, this document cannot be reproduced except in full with our prior written permission. The more details and the authenticity of the report will be confirmed at <http://www.agc-cert.com>.

13.1.3. Test Result

SAR MEASUREMENT									
Depth of Liquid (cm):>15					Relative Humidity (%): 51.2				
Product: Smartphone									
Test Mode: GSM850 with GMSK modulation									
Position	Mode	Ch.	Fr. (MHz)	Power Drift ($\pm 5\%$)	SAR (1g) (W/kg)	Max. Tune-up Power (dBm)	Meas. output Power (dBm)	Scaled SAR (W/Kg)	Limit (W/kg)
SIM 1 Card									
Left Cheek	voice	190	836.6	-0.12	0.335	31.70	31.53	0.348	1.6
Left Tilt	voice	190	836.6	0.53	0.216	31.70	31.53	0.225	1.6
Right Cheek	voice	190	836.6	-0.26	0.372	31.70	31.53	0.387	1.6
Right Tilt	voice	190	836.6	0.05	0.220	31.70	31.53	0.229	1.6
Body back	voice	128	824.2	-0.17	0.771	31.70	31.59	0.791	1.6
Body back	voice	190	836.6	-0.04	0.776	31.70	31.53	0.807	1.6
Body back	voice	251	848.8	0.28	0.798	31.70	31.60	0.817	1.6
Body front	voice	190	836.6	-0.30	0.468	31.70	31.53	0.487	1.6
Body back	GPRS-3 slot	128	824.2	-0.33	0.987	27.30	27.27	0.994	1.6
Body back	GPRS-3 slot	190	836.6	-0.17	0.962	27.30	27.19	0.987	1.6
Body back	GPRS-3 slot	251	848.8	0.09	0.976	27.30	27.22	0.994	1.6
Body front	GPRS-3 slot	190	836.6	-0.25	0.644	27.30	27.19	0.661	1.6
Edge 2(Right)	GPRS-3 slot	190	836.6	0.63	0.527	27.30	27.19	0.541	1.6
Edge 3(Bottom)	GPRS-3 slot	190	836.6	-0.05	0.239	27.30	27.19	0.245	1.6
Edge 4(Left)	GPRS-3 slot	190	836.6	0.18	0.251	27.30	27.19	0.257	1.6

Note:

- When the 1-g Reported SAR is ≤ 0.8 W/kg, testing for low and high channel is optional. Refer to KDB 447498.
- The test separation for body back, body front and Edges is 10mm of all above table.

The results shown in this test report refer only to the sample(s) tested unless otherwise stated and the sample(s) are retained for 30 days only. The document is issued by AGC, this document cannot be reproduced except in full with our prior written permission. The more details and the authenticity of the report will be confirmed at <http://www.agc-cert.com>.

SAR MEASUREMENT									
Depth of Liquid (cm):>15									
Product: Smartphone									
Test Mode: PCS1900 with GMSK modulation									
Position	Mode	Ch.	Fr. (MHz)	Power Drift (<±5%)	SAR (1g) (W/kg)	Max. Tune-up Power (dBm)	Meas. output Power (dBm)	Scaled SAR (W/Kg)	Limit (W/kg)
SIM 1 Card									
Left Cheek	voice	661	1880.0	-0.23	0.247	28.70	28.65	0.250	1.6
Left Tilt	voice	661	1880.0	0.15	0.131	28.70	28.65	0.133	1.6
Right Cheek	voice	661	1880.0	0.07	0.240	28.70	28.65	0.243	1.6
Right Tilt	voice	661	1880.0	-0.22	0.102	28.70	28.65	0.103	1.6
Body back	voice	661	1880.0	0.35	0.697	28.70	28.65	0.705	1.6
Body front	voice	661	1880.0	-0.19	0.302	28.70	28.65	0.305	1.6
Body back	GPRS-4 slot	512	1850.2	-0.08	1.214	22.90	22.58	1.307	1.6
Body back	GPRS-4 slot	661	1880	0.38	1.094	22.90	22.83	1.112	1.6
Body back	GPRS-4 slot	810	1909.8	-0.17	1.006	22.90	22.65	1.066	1.6
Body front	GPRS-4 slot	661	1880.0	-0.29	0.492	22.90	22.83	0.500	1.6
Body back+Ear.	GPRS-4 slot	512	1850.2	-0.17	1.240	22.90	22.58	1.335	1.6
Body back+Ear.	GPRS-4 slot	661	1880	-0.14	1.159	22.90	22.83	1.178	1.6
Body back+Ear.	GPRS-4 slot	810	1909.8	0.05	1.004	22.90	22.65	1.063	1.6
Edge 2(Right)	GPRS-4 slot	661	1880.0	-0.28	0.231	22.90	22.83	0.235	1.6
Edge 3(Bottom)	GPRS-4 slot	661	1880.0	0.03	0.617	22.90	22.83	0.627	1.6
Edge 4(Left)	GPRS-4 slot	661	1880.0	0.30	0.227	22.90	22.83	0.231	1.6

Note:

- When the 1-g Reported SAR is ≤ 0.8 W/kg, testing for low and high channel is optional. Refer to KDB 447498.
- The test separation for body back, body front and Edges is 10mm of all above table.

The results shown in this test report refer only to the sample(s) tested unless otherwise stated and the sample(s) are retained for 30 days only. The document is issued by AGC, this document cannot be reproduced except in full with our prior written permission. The more details and the authenticity of the report will be confirmed at <http://www.agc-cert.com>.

SAR MEASUREMENT									
Depth of Liquid (cm):>15									
Product: Smartphone									
Test Mode: WCDMA Band II with QPSK modulation									
Position	Mode	Ch.	Fr. (MHz)	Power Drift ($\pm 5\%$)	SAR (1g) (W/kg)	Max. Tune-up Power (dBm)	Meas. output Power (dBm)	Scaled SAR (W/Kg)	Limit (W/kg)
Left Cheek	RMC 12.2kbps	9400	1880	-0.18	0.387	21.70	21.66	0.391	1.6
Left Tilt	RMC 12.2kbps	9400	1880	0.25	0.276	21.70	21.66	0.279	1.6
Right Cheek	RMC 12.2kbps	9400	1880	-0.13	0.612	21.70	21.66	0.618	1.6
Right Tilt	RMC 12.2kbps	9400	1880	-0.18	0.168	21.70	21.66	0.170	1.6
Body back	RMC 12.2kbps	9262	1852.4	-0.22	1.146	21.70	20.89	1.381	1.6
Body back	RMC 12.2kbps	9400	1880	0.35	1.066	21.70	21.66	1.076	1.6
Body back	RMC 12.2kbps	9538	1907.6	0.28	0.958	21.70	21.69	0.960	1.6
Body front	RMC 12.2kbps	9400	1880	-0.17	0.593	21.70	21.66	0.598	1.6
Edge 2(Right)	RMC 12.2kbps	9400	1880	0.06	0.235	21.70	21.66	0.237	1.6
Edge 3(Bottom)	RMC 12.2kbps	9400	1880	-0.23	0.617	21.70	21.66	0.623	1.6
Edge 4(Left)	RMC 12.2kbps	9400	1880	0.04	0.306	21.70	21.66	0.309	1.6

Note:

- When the 1-g Reported SAR is ≤ 0.8 W/kg, testing for low and high channel is optional. Refer to KDB 447498.
- The test separation for body back, body front and Edges is 10mm of all above table.

The results shown in this test report refer only to the sample(s) tested unless otherwise stated and the sample(s) are retained for 30 days only. The document is issued by AGC, this document cannot be reproduced except in full with our prior written permission. The more details and the authenticity of the report will be confirmed at <http://www.agc-cert.com>.

SAR MEASUREMENT									
Depth of Liquid (cm):>15					Relative Humidity (%): 54.4				
Product: Smartphone									
Test Mode: WCDMA Band IV with QPSK modulation									
Position	Mode	Ch.	Fr. (MHz)	Power Drift ($\leq \pm 5\%$)	SAR (1g) (W/kg)	Max. Tune-up Power (dBm)	Meas. output Power (dBm)	Scaled SAR (W/Kg)	Limit (W/kg)
Left Cheek	RMC 12.2kbps	8662	1732.5	-0.35	0.618	22.00	21.89	0.634	1.6
Left Tilt	RMC 12.2kbps	8662	1732.5	0.17	0.337	22.00	21.89	0.346	1.6
Right Cheek	RMC 12.2kbps	8662	1732.5	-0.08	0.602	22.00	21.89	0.617	1.6
Right Tilt	RMC 12.2kbps	8662	1732.5	0.29	0.252	22.00	21.89	0.258	1.6
Body back	RMC 12.2kbps	8562	1712.5	-0.56	1.305	22.00	21.82	1.360	1.6
Body back	RMC 12.2kbps	8662	1732.5	0.28	1.142	22.00	21.89	1.171	1.6
Body back	RMC 12.2kbps	8763	1752.5	-0.73	1.267	22.00	21.92	1.291	1.6
Body front	RMC 12.2kbps	8662	1732.5	0.15	0.951	22.00	21.89	0.975	1.6
Body back+Ear.	RMC 12.2kbps	8562	1712.5	0.08	1.179	22.00	21.82	1.229	1.6
Body back+Ear.	RMC 12.2kbps	8662	1732.5	-0.19	1.244	22.00	21.89	1.276	1.6
Body back+Ear.	RMC 12.2kbps	8763	1752.5	-0.22	1.188	22.00	21.92	1.210	1.6
Edge 2(Right)	RMC 12.2kbps	8662	1732.5	-0.36	0.333	22.00	21.89	0.342	1.6
Edge 3(Bottom)	RMC 12.2kbps	8662	1732.5	0.41	0.690	22.00	21.89	0.708	1.6
Edge 4(Left)	RMC 12.2kbps	8662	1732.5	0.28	0.551	22.00	21.89	0.565	1.6

Note:

- When the 1-g Reported SAR is ≤ 0.8 W/kg, testing for low and high channel is optional. Refer to KDB 447498.
- The test separation for body back, body front and Edges is 10mm of all above table.

The results shown in this test report refer only to the sample(s) tested unless otherwise stated and the sample(s) are retained for 30 days only. The document is issued by AGC, this document cannot be reproduced except in full with our prior written permission. The more details and the authenticity of the report will be confirmed at <http://www.agc-cert.com>.

SAR MEASUREMENT									
Depth of Liquid (cm):>15					Relative Humidity (%): 51.2				
Product: Smartphone									
Test Mode: WCDMA Band V with QPSK modulation									
Position	Mode	Ch.	Fr. (MHz)	Power Drift (<±5%)	SAR (1g) (W/kg)	Max. Tune-up Power (dBm)	Meas. output Power (dBm)	Scaled SAR (W/Kg)	Limit (W/kg)
Left Cheek	RMC 12.2kbps	4183	836.6	-0.35	0.266	21.70	21.47	0.280	1.6
Left Tilt	RMC 12.2kbps	4183	836.6	0.19	0.186	21.70	21.47	0.196	1.6
Right Cheek	RMC 12.2kbps	4183	836.6	-0.28	0.237	21.70	21.47	0.250	1.6
Right Tilt	RMC 12.2kbps	4183	836.6	-0.17	0.128	21.70	21.47	0.135	1.6
Body back	RMC 12.2kbps	4183	836.6	-0.05	0.460	21.70	21.47	0.485	1.6
Body front	RMC 12.2kbps	4183	836.6	0.56	0.302	21.70	21.47	0.318	1.6
Edge 2(Right)	RMC 12.2kbps	4183	836.6	-0.23	0.297	21.70	21.47	0.313	1.6
Edge 3(Bottom)	RMC 12.2kbps	4183	836.6	0.27	0.125	21.70	21.47	0.132	1.6
Edge 4(Left)	RMC 12.2kbps	4183	836.6	-0.03	0.165	21.70	21.47	0.174	1.6

Note:

- When the 1-g Reported SAR is ≤ 0.8 W/kg, testing for low and high channel is optional. Refer to KDB 447498.
- The test separation for body back, body front and Edges is 10mm of all above table.

The results shown in this test report refer only to the sample(s) tested unless otherwise stated and the sample(s) are retained for 30 days only. The document is issued by AGC, this document cannot be reproduced except in full with our prior written permission. The more details and the authenticity of the report will be confirmed at <http://www.agc-cert.com>.

SAR MEASUREMENT												
Depth of Liquid (cm):>15						Relative Humidity (%): 53.3						
Product: Smartphone												
Test Mode: LTE Band 2												
BM MHz	MOD	Position	Test Mode		Ch.	Freq. (MHz)	Power Drift (<±5%)	SAR (1g) (W/kg)	Max. Tune up Power (dBm)	Meas. output Power (dBm)	Scaled SAR (W/Kg)	Limit (W/kg)
			UL RB Allocation	UL RB START								
20	QPSK	Left Cheek	1	0	18900	1880	-0.35	0.332	22.70	22.68	0.334	1.6
		Left Tilt	1	0	18900	1880	0.19	0.193	22.70	22.68	0.194	1.6
		Right Cheek	1	0	18900	1880	-0.05	0.411	22.70	22.68	0.413	1.6
		Right Tilt	1	0	18900	1880	-0.27	0.139	22.70	22.68	0.140	1.6
		Body back	1	0	18700	1860	-0.64	1.285	22.70	22.53	1.336	1.6
		Body back	1	0	18900	1880	-0.58	0.977	22.70	22.68	0.982	1.6
		Body back	1	0	19100	1900	-0.23	1.145	22.70	22.58	1.177	1.6
		Body front	1	0	18900	1880	0.06	0.495	22.70	22.68	0.497	1.6
		Body back+ Ear.	1	0	18700	1860	-0.56	1.266	22.70	22.53	1.317	1.6
		Body back+ Ear.	1	0	18900	1880	0.15	0.970	22.70	22.68	0.974	1.6
		Body back+ Ear.	1	0	19100	1900	-0.08	1.189	22.70	22.58	1.222	1.6
		Edge 2(Right)	1	0	18900	1880	-0.18	0.230	22.70	22.68	0.231	1.6
		Edge 3(Bottom)	1	0	18900	1880	0.23	0.420	22.70	22.68	0.422	1.6
		Edge 4(Left)	1	0	18900	1880	0.09	0.299	22.70	22.68	0.300	1.6

Note:

- When the 1-g Reported SAR is ≤ 0.8 W/kg, testing for low and high channel is optional. Refer to KDB 447498.
- The test separation for body back, body front and Edges is 10mm of all above table.

The results shown in this test report refer only to the sample(s) tested unless otherwise stated and the sample(s) are retained for 30 days only. The document is issued by AGC, this document cannot be reproduced except in full with our prior written permission. The more details and the authenticity of the report will be confirmed at <http://www.agc-cert.com>.

SAR MEASUREMENT												
Depth of Liquid (cm):>15						Relative Humidity (%): 52.8						
Product: Smartphone												
Test Mode: LTE Band 4												
BM MHz	MOD	Position	Test Mode		Ch.	Freq. (MHz)	Power Drift (<±5%)	SAR (1g) (W/kg)	Max. Tuneup Power (dBm)	Meas. output Power (dBm)	Scaled SAR (W/Kg)	Limit (W/kg)
			UL RB Allocation	UL RB START								
20	QPSK	Left Cheek	1	0	20175	1732.5	-0.56	0.424	22.90	22.76	0.438	1.6
		Left Tilt	1	0	20175	1732.5	-0.38	0.331	22.90	22.76	0.342	1.6
		Right Cheek	1	0	20175	1732.5	0.29	0.712	22.90	22.76	0.735	1.6
		Right Tilt	1	0	20175	1732.5	-0.13	0.256	22.90	22.76	0.264	1.6
		Body back	1	0	20050	1720	0.87	1.165	22.90	22.83	1.184	1.6
		Body back	1	0	20175	1732.5	-1.41	1.273	22.90	22.76	1.315	1.6
		Body back	1	0	20300	1745	-0.85	1.051	22.90	22.50	1.152	1.6
		Body front	1	0	20050	1720	0.26	0.827	22.90	22.83	0.840	1.6
		Body front	1	0	20175	1732.5	-0.08	0.809	22.90	22.76	0.836	1.6
		Body front	1	0	20300	1745	-0.32	0.846	22.90	22.50	0.928	1.6
		Body back+ Ear.	1	0	20050	1720	0.01	1.155	22.90	22.83	1.174	1.6
		Body back+ Ear.	1	0	20175	1732.5	-0.29	1.247	22.90	22.76	1.288	1.6
		Body back+ Ear.	1	0	20300	1745	0.17	1.057	22.90	22.50	1.159	1.6
		Edge 2(Right)	1	0	20175	1732.5	-0.06	0.310	22.90	22.76	0.320	1.6
		Edge 3(Bottom)	1	0	20175	1732.5	0.53	0.662	22.90	22.76	0.684	1.6
Edge 4(Left)	1	0	20175	1732.5	0.27	0.372	22.90	22.76	0.384	1.6		

Note:

- When the 1-g Reported SAR is ≤ 0.8 W/kg, testing for low and high channel is optional. Refer to KDB 447498.
- The test separation for body back, body front and Edges is 10mm of all above table.

The results shown in this test report refer only to the sample(s) tested unless otherwise stated and the sample(s) are retained for 30 days only. The document is issued by AGC, this document cannot be reproduced except in full with our prior written permission. The more details and the authenticity of the report will be confirmed at <http://www.agc-cert.com>.

SAR MEASUREMENT												
Depth of Liquid (cm):>15						Relative Humidity (%): 52.2						
Product: Smartphone												
Test Mode: LTE Band 5												
BM MHz	MOD	Position	Test Mode		Ch.	Freq. (MHz)	Power Drift (<±5%)	SAR (1g) (W/kg)	Max. Tuneup Power (dBm)	Meas. output Power (dBm)	Scaled SAR (W/Kg)	Limit (W/kg)
			UL RB Allocation	UL RB START								
10	QPSK	Left Cheek	1	0	20525	836.5	-0.04	0.211	21.80	21.73	0.214	1.6
		Left Tilt	1	0	20525	836.5	0.15	0.148	21.80	21.73	0.150	1.6
		Right Cheek	1	0	20525	836.5	-0.08	0.272	21.80	21.73	0.276	1.6
		Right Tilt	1	0	20525	836.5	-0.19	0.140	21.80	21.73	0.142	1.6
		Body back	1	0	20525	836.5	0.27	0.511	21.80	21.73	0.519	1.6
		Body front	1	0	20525	836.5	-0.36	0.328	21.80	21.73	0.333	1.6
		Edge 2(Right)	1	0	20525	836.5	-0.05	0.313	21.80	21.73	0.318	1.6
		Edge 3(Bottom)	1	0	20525	836.5	-0.21	0.122	21.80	21.73	0.124	1.6
		Edge 4(Left)	1	0	20525	836.5	0.11	0.170	21.80	21.73	0.173	1.6

Note:

- When the 1-g Reported SAR is ≤ 0.8 W/kg, testing for low and high channel is optional. Refer to KDB 447498.
- The test separation for body back, body front and Edges is 10mm of all above table.

The results shown in this test report refer only to the sample(s) tested unless otherwise stated and the sample(s) are retained for 30 days only. The document is issued by AGC, this document cannot be reproduced except in full with our prior written permission. The more details and the authenticity of the report will be confirmed at <http://www.agc-cert.com>.

SAR MEASUREMENT												
Depth of Liquid (cm):>15						Relative Humidity (%): 48.8						
Product: Smartphone												
Test Mode: LTE Band 12												
BM MHz	MOD	Position	Test Mode		Ch.	Freq. (MHz)	Power Drift ($\pm 5\%$)	SAR (1g) (W/kg)	Max. Tuneup Power (dBm)	Meas. output Power (dBm)	Scaled SAR (W/Kg)	Limit (W/kg)
			UL RB Allocation	UL RB START								
10	QPSK	Left Cheek	1	0	23095	707.5	-0.38	0.022	25.66	23.63	0.035	1.6
		Left Tilt	1	0	23095	707.5	-0.37	0.017	25.66	23.63	0.027	1.6
		Right Cheek	1	0	23095	707.5	0.19	0.022	25.66	23.63	0.035	1.6
		Right Tilt	1	0	23095	707.5	-0.22	0.014	25.66	23.63	0.022	1.6
		Body back	1	0	23095	707.5	0.05	0.074	25.66	23.63	0.118	1.6
		Body front	1	0	23095	707.5	-0.16	0.039	25.66	23.63	0.062	1.6
		Edge 2(Right)	1	0	23095	707.5	0.07	0.023	25.66	23.63	0.037	1.6
		Edge 3(Bottom)	1	0	23095	707.5	-0.33	0.009	25.66	23.63	0.014	1.6
		Edge 4(Left)	1	0	23095	707.5	-0.52	0.023	25.66	23.63	0.037	1.6

Note:

- When the 1-g Reported SAR is ≤ 0.8 W/kg, testing for low and high channel is optional. Refer to KDB 447498.
- The test separation for body back, body front and Edges is 10mm of all above table.

The results shown in this test report refer only to the sample(s) tested unless otherwise stated and the sample(s) are retained for 30 days only. The document is issued by AGC, this document cannot be reproduced except in full with our prior written permission. The more details and the authenticity of the report will be confirmed at <http://www.agc-cert.com>.

SAR MEASUREMENT									
Depth of Liquid (cm):>15					Relative Humidity (%): 50.7				
Product: Smartphone									
Test Mode:802.11b									
Position	Mode	Ch.	Fr. (MHz)	Power Drift (<±5%)	SAR (1g) (W/kg)	Max. Tune-up Power (dBm)	Meas. output Power (dBm)	Scaled SAR (W/Kg)	Limit (W/kg)
Left Cheek	DTS	11	2462	-0.36	0.070	13.00	12.91	0.071	1.6
Left Tilt	DTS	11	2462	-0.18	0.054	13.00	12.91	0.055	1.6
Right Cheek	DTS	11	2462	0.29	0.195	13.00	12.91	0.199	1.6
Right Tilt	DTS	11	2462	-0.05	0.095	13.00	12.91	0.097	1.6
Body back	DTS	11	2462	-0.24	0.135	13.00	12.91	0.138	1.6
Body front	DTS	11	2462	0.52	0.041	13.00	12.91	0.042	1.6
Edge 1 (Top)	DTS	11	2462	-0.36	0.020	13.00	12.91	0.020	1.6
Edge 4(Left)	DTS	11	2462	-0.09	0.022	13.00	12.91	0.022	1.6

Note:

- According to KDB 248227 D01v02r02,for 2.4GHz 802.11g/n SAR testing is not required when the highest reported SAR for DSSS is adjusted by the ratio of OFDM to DSSS specified maximum output power and the adjusted SAR is $\leq 1.2W/kg$.
- All of above "DTS" means data transmitters.
- The test separation for body back, body front and Edges is 10mm of all above table.

Repeated SAR										
Product: Smartphone										
Test Mode: GSM850& PCS1900 with GMSK modulation & WCDMA Band IV &WCDMA Band IV with QPSK modulation										
Position	Mode	Ch.	Fr. (MHz)	Power Drift (<±5%)	Once SAR (1g) (W/kg)	Power Drift (<±5%)	Twice SAR (1g) (W/kg)	Power Drift (<±5%)	Third SAR (1g) (W/kg)	Limit W/kg
Body back	GPRS-3 slot	128	824.2	-0.36	0.973	--	--	--	--	1.6
Body back+Ear.	GPRS-4 slot	512	1850.2	-0.11	1.195	--	--	--	--	1.6
Body back	RMC 12.2kbps	9262	1852.4	-0.26	1.143	--	--	--	--	1.6
Body back	RMC 12.2kbps	8562	1712.5	-0.52	1.277	--	--	--	--	1.6

SAR MEASUREMENT													
Product: Smartphone													
Test Mode: LTE Band 2& LTE Band 4													
BM MHz	MOD	Position	Test Mode		Ch.	Freq. (MHz)	Power Drift (<±5%)	Once SAR (1g) (W/kg)	Power Drift (<±5%)	Twice SAR (1g) (W/kg)	Power Drift (<±5%)	Third SAR (1g) (W/kg)	Limit (W/kg)
			UL RB Allocation	UL RB START									
20	QPSK	Body back	1	0	18700	1860	-0.62	1.132	--	--	--	--	1.6
		Body back	1	0	20175	1732.5	-1.46	1.238	--	--	--	--	1.6

The results shown in this test report refer only to the sample(s) tested unless otherwise stated and the sample(s) are retained for 30 days only. The document is issued by AGC, this document cannot be reproduced except in full with our prior written permission. The more details and the authenticity of the report will be confirmed at <http://www.agc-cert.com>.

Simultaneous Multi-band Transmission Evaluation:
Application Simultaneous Transmission information:

NO	Simultaneous state	Portable Handset		
		Head	Body-worn	Hotspot
1	GSM(voice)+WLAN 2.4GHz (data)	Yes	Yes	-
2	GSM(voice)+Bluetooth(data)	-	Yes	
3	GSM (Data) + WLAN 2.4GHz (data)	-	Yes	Yes
4	GSM (Data) + Bluetooth(data)	-	Yes	Yes
5	WCDMA+WLAN 2.4GHz (data)	Yes	Yes	Yes
6	WCDMA+Bluetooth(data)	-	Yes	Yes
7	LTE + WLAN 2.4GHz (data)	Yes	Yes	Yes
8	LTE + Bluetooth(data)	--	Yes	Yes

NOTE:

1. WIFI and BT share the same antenna, and cannot transmit simultaneously.
2. Simultaneous with every transmitter must be the same test position.
3. KDB 447498 D01, BT SAR is excluded as below table.
4. KDB 447498 D01, for handsets the test separation distance is determined by the smallest distance between the outer surface of the device and the user; which is 0mm for head SAR and 10mm for body-worn SAR.
5. According to KDB 447498 D01 4.3.1, Standalone SAR test exclusion is as follow:
 For 100 MHz to 6 GHz and test separation distances ≤ 50 mm, the 1-g and 10-g SAR test exclusion thresholds are determined by the following:

$$[(\text{max. power of channel, including tune-up tolerance, mW}) / (\text{min. test separation distance, mm})] \cdot [\sqrt{f(\text{GHz})}] \leq 3.0$$
 for 1-g SAR, and ≤ 7.5 for 10-g extremity SAR³⁰, where
 - f(GHz) is the RF channel transmit frequency in GHz
 - Power and distance are rounded to the nearest mW and mm before calculation³¹
 - The result is rounded to one decimal place for comparison
 - The values 3.0 and 7.5 are referred to as numeric thresholds in step b) below
 The test exclusions are applicable only when the minimum test separation distance is ≤ 50 mm, and for transmission frequencies between 100 MHz and 6 GHz. When the minimum test separation distance is < 5 mm, a distance of 5 mm according to 4.1 f) is applied to determine SAR test exclusion.
6. If the test separation distance is < 5 mm, 5mm is used for excluded SAR calculation.
7. According to KDB 447498 D01 4.3.2, simultaneous transmission SAR test exclusion is as follow:
 - (1) Simultaneous transmission SAR test exclusion is determined for each operating configuration and exposure condition according to the reported standalone SAR of each applicable simultaneous transmitting antenna.
 - (2) Any transmitters and antennas should be considered when calculating simultaneous mode.
 - (3) For mobile phone and PC, it's the sum of all transmitters and antennas at the same mode with same position in each applicable exposure condition
 - (4) When the standalone SAR test exclusion of section 4.3.2 is applied to an antenna that transmits simultaneously with other antennas, the standalone SAR must be estimated according to the following to det

$$[(\text{max. power of channel, including tune-up tolerance, mW}) / (\text{min. test separation distance, mm})] \cdot [\sqrt{f(\text{GHz})/x}] \leq W/\text{kg}$$
 for test separation distances ≤ 50 mm;
 where $x = 7.5$ for 1-g SAR, and $x = 18.75$ for 10-g SAR.

The results shown in this test report refer only to the sample(s) tested unless otherwise stated and the sample(s) are retained for 30 days only. The document is issued by AGC, this document cannot be reproduced except in full with our prior written permission. The more details and the authenticity of the report will be confirmed at <http://www.agc-cert.com>.

8. When the sum of SAR is larger than the limit, SAR test exclusion is determined by the SAR to peak location separation ratio. The simultaneous transmitting antennas in each operating mode and exposure condition combination must be considered one pair at a time to determine the SAR to peak location separation ratio to qualify for test exclusion. The ratio is determined by $(SAR_1 + SAR_2)1.5/R_i$, rounded to two decimal digits, and must be ≤ 0.04 for all antenna pairs in the configuration to qualify for 1-g SAR test exclusion.

Estimated SAR		Max Power including Tune-up Tolerance		Separation Distance (mm)	Estimated SAR (W/kg)
		dBm	mW		
BT	Head	6	3.981	0	0.167
	Body	6	3.981	10	0.084

The results shown in this test report refer only to the sample(s) tested unless otherwise stated and the sample(s) are retained for 30 days only. The document is issued by AGC, this document cannot be reproduced except in full with our prior written permission. The more details and the authenticity of the report will be confirmed at <http://www.agc-cert.com>.

Sum of the SAR for GSM 850 &Wi-Fi & BT:

RF Exposure Conditions	Test Position	Simultaneous Transmission Scenario			Σ1-g SAR (W/Kg)	SPLSR (Yes/No)
		GSM 850	Wi-Fi DTS Band	Bluetooth		
Head (voice)	Left Touch	0.348	0.071		0.419	No
	Left Tilt	0.225	0.055		0.280	No
	Right Touch	0.387	0.199		0.586	No
	Right Tilt	0.229	0.097		0.326	No
Body-worn (voice)	Rear	0.817	0.138		0.955	No
		0.817		0.084	0.901	No
	Front	0.487	0.042		0.529	No
		0.487		0.084	0.571	No
Body-worn (Data)	Rear	0.994		0.084	1.078	No
		0.994	0.138		1.132	No
	Front	0.661		0.084	0.745	No
		0.661	0.042		0.703	No
Body-worn (Hotspot)	Edge 4	0.257	0.022		0.279	No
	Edge 4	0.257		0.084	0.341	No

Note:

-According to KDB 447498 D01 General RF Exposure Guidance, when the simultaneous transmission SAR is less than 1.6 W/Kg, SPLSR assessment is not required.

-SPLSR mean is "The SAR to Peak Location Separation Ratio"

Sum of the SAR for GSM 1900 &Wi-Fi & BT:

RF Exposure Conditions	Test Position	Simultaneous Transmission Scenario			Σ1-g SAR (W/Kg)	SPLSR (Yes/No)
		PCS 1900	Wi-Fi DTS Band	Bluetooth		
Head (voice)	Left Touch	0.250	0.071		0.321	No
	Left Tilt	0.133	0.055		0.188	No
	Right Touch	0.243	0.199		0.442	No
	Right Tilt	0.103	0.097		0.200	No
Body-worn (voice)	Rear	0.705	0.138		0.843	No
		0.705		0.084	0.789	No
	Front	0.305	0.042		0.347	No
		0.305		0.084	0.389	No
Body-worn (Data)	Rear	1.307		0.084	1.391	No
		1.307	0.138		1.445	No
	Front	0.500		0.084	0.584	No
		0.500	0.042		0.542	No
Body-worn (Hotspot)	Edge 4	0.231	0.022		0.253	No
	Edge 4	0.231		0.084	0.315	No

Note:

-According to KDB 447498 D01 General RF Exposure Guidance, when the simultaneous transmission SAR is less than 1.6 W/Kg, SPLSR assessment is not required.

-SPLSR mean is "The SAR to Peak Location Separation Ratio"

The results shown in this test report refer only to the sample(s) tested unless otherwise stated and the sample(s) are retained for 30 days only. The document is issued by AGC, this document cannot be reproduced except in full with our prior written permission. The more details and the authenticity of the report will be confirmed at <http://www.agc-cert.com>.

Sum of the SAR for WCDMA Band II & Wi-Fi & BT:

RF Exposure Conditions	Test Position	Simultaneous Transmission Scenario			Σ1-g SAR (W/Kg)	SPLSR (Yes/No)
		WCDMA Band II	Wi-Fi DTS Band	Bluetooth		
Head	Left Touch	0.391	0.071		0.462	No
	Left Tilt	0.279	0.055		0.334	No
	Right Touch	0.618	0.199		0.817	No
	Right Tilt	0.170	0.097		0.267	No
Body-worn	Rear	1.381	0.138		1.519	No
	Front	0.598	0.042		0.640	No
	Edge 4	0.309	0.022		0.331	No
	Rear	1.381		0.084	1.465	No
	Front	0.598		0.084	0.682	No
	Edge 4	0.309		0.084	0.393	No

Note:

- According to KDB 447498 D01 General RF Exposure Guidance, when the simultaneous transmission SAR is less than 1.6 W/Kg, SPLSR assessment is not required.
- SPLSR mean is "The SAR to Peak Location Separation Ratio"

Sum of the SAR for WCDMA Band IV & Wi-Fi & BT:

RF Exposure Conditions	Test Position	Simultaneous Transmission Scenario			Σ1-g SAR (W/Kg)	SPLSR (Yes/No)
		WCDMA Band IV	Wi-Fi DTS Band	Bluetooth		
Head	Left Touch	0.634	0.071		0.705	No
	Left Tilt	0.346	0.055		0.401	No
	Right Touch	0.617	0.199		0.816	No
	Right Tilt	0.258	0.097		0.355	No
Body-worn	Rear	1.360	0.138		1.498	No
	Front	0.975	0.042		1.017	No
	Edge 4	0.565	0.022		0.587	No
	Rear	1.360		0.084	1.444	No
	Front	0.975		0.084	1.059	No
	Edge 4	0.565		0.084	0.649	No

Note:

- According to KDB 447498 D01 General RF Exposure Guidance, when the simultaneous transmission SAR is less than 1.6 W/Kg, SPLSR assessment is not required.
- SPLSR mean is "The SAR to Peak Location Separation Ratio"

The results shown in this test report refer only to the sample(s) tested unless otherwise stated and the sample(s) are retained for 30 days only. The document is issued by AGC, this document cannot be reproduced except in full with our prior written permission. The more details and the authenticity of the report will be confirmed at <http://www.agc-cert.com>.

Sum of the SAR for WCDMA Band V & Wi-Fi & BT:

RF Exposure Conditions	Test Position	Simultaneous Transmission Scenario			Σ1-g SAR (W/Kg)	SPLSR (Yes/No)
		WCDMA Band V	Wi-Fi DTS Band	Bluetooth		
Head	Left Touch	0.280	0.071		0.351	No
	Left Tilt	0.196	0.055		0.251	No
	Right Touch	0.250	0.199		0.449	No
	Right Tilt	0.135	0.097		0.232	No
Body-worn	Rear	0.485	0.138		0.623	No
	Front	0.318	0.042		0.360	No
	Edge 4	0.174	0.022		0.196	No
	Rear	0.485		0.084	0.569	No
	Front	0.318		0.084	0.402	No
	Edge 4	0.174		0.084	0.258	No

Note:

- According to KDB 447498 D01 General RF Exposure Guidance, when the simultaneous transmission SAR is less than 1.6 W/Kg, SPLSR assessment is not required.
- SPLSR mean is "The SAR to Peak Location Separation Ratio"

Sum of the SAR for LTE Band 2 & Wi-Fi & BT:

RF Exposure Conditions	Test Position	Simultaneous Transmission Scenario			Σ1-g SAR (W/Kg)	SPLSR (Yes/No)
		LTE Band 2	Wi-Fi DTS Band	Bluetooth		
Head	Left Touch	0.334	0.071		0.405	No
	Left Tilt	0.194	0.055		0.249	No
	Right Touch	0.413	0.199		0.612	No
	Right Tilt	0.140	0.097		0.237	No
Body-worn	Rear	1.336	0.138		1.474	No
	Front	0.497	0.042		0.539	No
	Edge 4	0.300	0.022		0.322	No
	Rear	1.336		0.084	1.420	No
	Front	0.497		0.084	0.581	No
	Edge 4	0.300		0.084	0.384	No

Note:

- According to KDB 447498 D01 General RF Exposure Guidance, when the simultaneous transmission SAR is less than 1.6 W/Kg, SPLSR assessment is not required.
- SPLSR mean is "The SAR to Peak Location Separation Ratio"

The results shown in this test report refer only to the sample(s) tested unless otherwise stated and the sample(s) are retained for 30 days only. The document is issued by AGC, this document cannot be reproduced except in full with our prior written permission. The more details and the authenticity of the report will be confirmed at <http://www.agc-cert.com>.

Sum of the SAR for LTE Band 4 & Wi-Fi & BT:

RF Exposure Conditions	Test Position	Simultaneous Transmission Scenario			Σ1-g SAR (W/Kg)	SPLSR (Yes/No)
		LTE Band 4	Wi-Fi DTS Band	Bluetooth		
Head	Left Touch	0.438	0.071		0.509	No
	Left Tilt	0.342	0.055		0.397	No
	Right Touch	0.735	0.199		0.934	No
	Right Tilt	0.264	0.097		0.361	No
Body-worn	Rear	1.315	0.138		1.453	No
	Front	0.928	0.042		0.970	No
	Edge 4	0.384	0.022		0.406	No
	Rear	1.315		0.084	1.399	No
	Front	0.928		0.084	1.012	No
	Edge 4	0.384		0.084	0.468	No

Note:

- According to KDB 447498 D01 General RF Exposure Guidance, when the simultaneous transmission SAR is less than 1.6 W/Kg, SPLSR assessment is not required.
- SPLSR mean is "The SAR to Peak Location Separation Ratio"

Sum of the SAR for LTE Band 5 & Wi-Fi & BT:

RF Exposure Conditions	Test Position	Simultaneous Transmission Scenario			Σ1-g SAR (W/Kg)	SPLSR (Yes/No)
		LTE Band 5	Wi-Fi DTS Band	Bluetooth		
Head	Left Touch	0.214	0.071		0.285	No
	Left Tilt	0.150	0.055		0.205	No
	Right Touch	0.276	0.199		0.475	No
	Right Tilt	0.142	0.097		0.239	No
Body-worn	Rear	0.519	0.138		0.657	No
	Front	0.333	0.042		0.375	No
	Edge 4	0.173	0.022		0.195	No
	Rear	0.519		0.084	0.603	No
	Front	0.333		0.084	0.417	No
	Edge 4	0.173		0.084	0.257	No

Note:

- According to KDB 447498 D01 General RF Exposure Guidance, when the simultaneous transmission SAR is less than 1.6 W/Kg, SPLSR assessment is not required.
- SPLSR mean is "The SAR to Peak Location Separation Ratio"

The results shown in this test report refer only to the sample(s) tested unless otherwise stated and the sample(s) are retained for 30 days only. The document is issued by AGC, this document cannot be reproduced except in full with our prior written permission. The more details and the authenticity of the report will be confirmed at <http://www.agc-cert.com>.

Sum of the SAR for LTE Band 12 & Wi-Fi & BT:

RF Exposure Conditions	Test Position	Simultaneous Transmission Scenario			Σ1-g SAR (W/Kg)	SPLSR (Yes/No)
		LTE Band 12	Wi-Fi DTS Band	Bluetooth		
Head	Left Touch	0.035	0.071		0.106	No
	Left Tilt	0.027	0.055		0.082	No
	Right Touch	0.035	0.199		0.234	No
	Right Tilt	0.022	0.097		0.119	No
Body-worn	Rear	0.118	0.138		0.256	No
	Front	0.062	0.042		0.104	No
	Edge 4	0.037	0.022		0.059	No
	Rear	0.118		0.084	0.202	No
	Front	0.062		0.084	0.146	No
	Edge 4	0.037		0.084	0.121	No

Note:

- According to KDB 447498 D01 General RF Exposure Guidance, when the simultaneous transmission SAR is less than 1.6 W/Kg, SPLSR assessment is not required.
- SPLSR mean is "The SAR to Peak Location Separation Ratio "

The results shown in this test report refer only to the sample(s) tested unless otherwise stated and the sample(s) are retained for 30 days only. The document is issued by AGC, this document cannot be reproduced except in full with our prior written permission. The more details and the authenticity of the report will be confirmed at <http://www.agc-cert.com>.

APPENDIX A. SAR SYSTEM CHECK DATA

Test Laboratory: AGC Lab

Date: July 02,2018

System Check Head 750 MHz

DUT: Dipole 750 MHz Type: SID 750

Communication System CW; Communication System Band: D750 (750.0 MHz); Duty Cycle: 1:1; Conv.F=1.61
Frequency: 750 MHz; Medium parameters used: $f = 750$ MHz; $\sigma=0.87$ mho/m; $\epsilon_r = 41.06$; $\rho = 1000$ kg/m³ ;
Phantom section: Flat Section; Input Power=18dBm
Ambient temperature (°C):22.0, Liquid temperature (°C): 21.3

SATIMO Configuration:

- Probe: SSE2; Calibrated: Aug. 08,2017; Serial No.: SN 08/16 EPGO282
- Sensor-Surface: 4mm (Mechanical Surface Detection)
- Phantom: SAM twin phantom
- Measurement SW: OpenSAR V4_02_32

Configuration/System Check 750MHz Head/Area Scan: Measurement grid: dx=8mm, dy=8mm

Configuration/System Check 750MHz Head/Zoom Scan: Measurement grid: dx=8mm,dy=8mm, dz=5mm

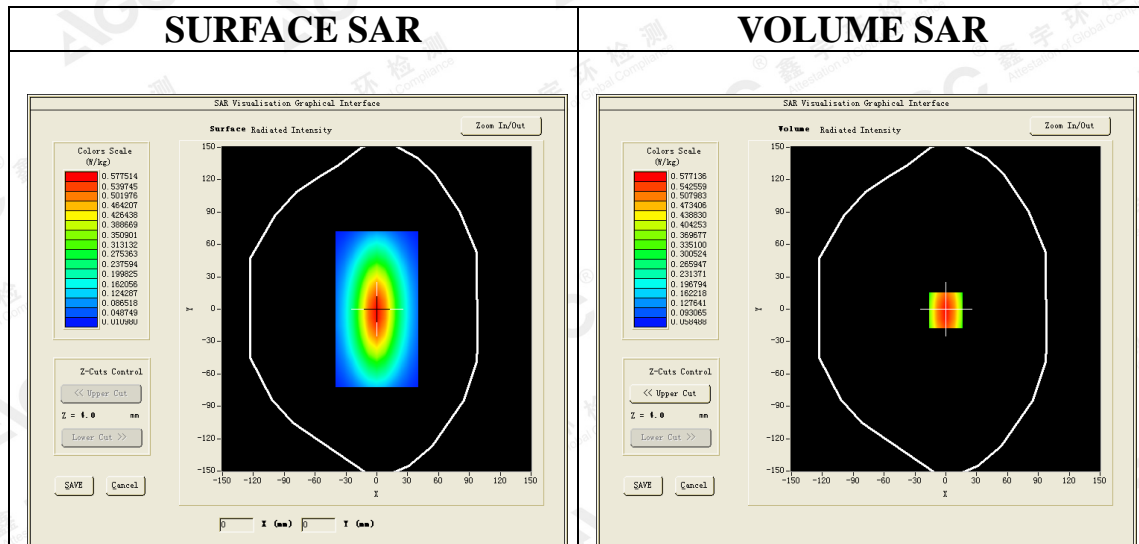

Maximum location: X=1.00, Y=-1.00

SAR Peak: 0.78 W/kg

SAR 10g (W/Kg)	0.370125
SAR 1g (W/Kg)	0.566954

The results shown in this test report refer only to the sample(s) tested unless otherwise stated and the sample(s) are retained for 30 days only. The document is issued by AGC, this document cannot be reproduced except in full with our prior written permission. The more details and the authenticity of the report will be confirmed at <http://www.agc-cert.com>.

Z (mm)	0.00	4.00	9.00	14.00	19.00	24.00	29.00
SAR (W/Kg)	0.7959	0.5810	0.3977	0.2795	0.1983	0.1429	0.1075

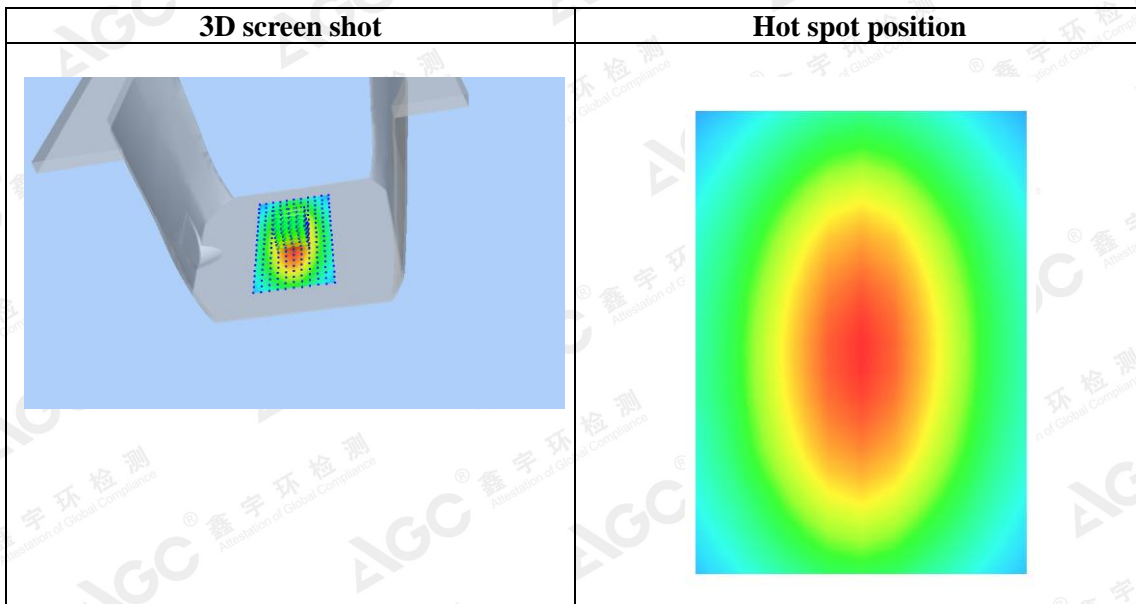
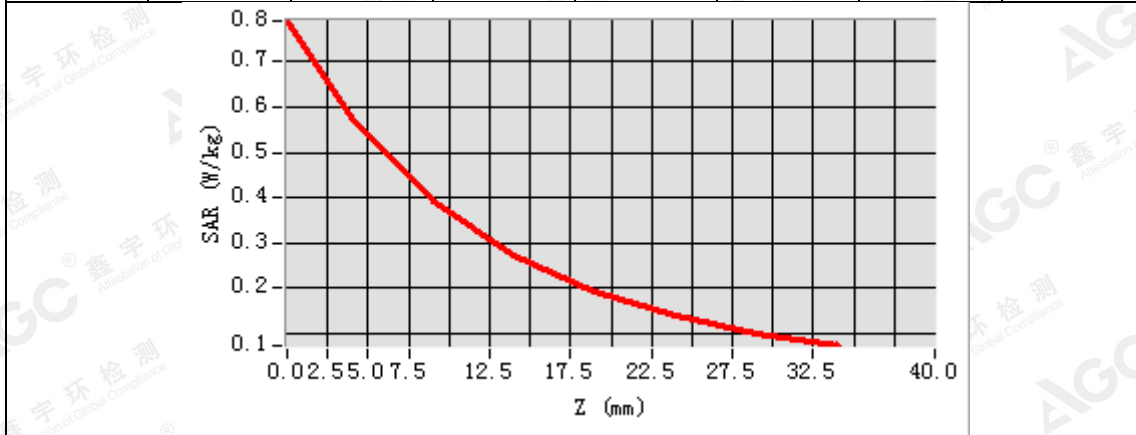

The results shown in this test report refer only to the sample(s) tested unless otherwise stated and the sample(s) are retained for 30 days only. The document is issued by AGC, this document cannot be reproduced except in full with our prior written permission. The more details and the authenticity of the report will be confirmed at <http://www.agc-cert.com>.

Test Laboratory: AGC Lab

Date: July 02,2018

System Check Body 750 MHz

DUT: Dipole 750 MHz Type: SID 750

Communication System CW; Communication System Band: D750 (750.0 MHz); Duty Cycle: 1:1; Conv.F=1.66

Frequency: 750 MHz; Medium parameters used: $f = 750$ MHz; $\sigma=0.98$ mho/m; $\epsilon_r=54.56$; $\rho= 1000$ kg/m³ ;

Phantom section: Flat Section; Input Power=18dBm

Ambient temperature (°C):22.0, Liquid temperature (°C): 21.5

SATIMO Configuration:

- Probe: SSE2; Calibrated: Aug. 08,2017; Serial No.: SN 08/16 EPGO282
- Sensor-Surface: 4mm (Mechanical Surface Detection)
- Phantom: SAM twin phantom
- Measurement SW: OpenSAR V4_02_32

Configuration/System Check 750MHz Body/Area Scan: Measurement grid: dx=8mm, dy=8mm

Configuration/System Check 750MHz Body/Zoom Scan: Measurement grid: dx=8mm,dy=8mm, dz=5mm

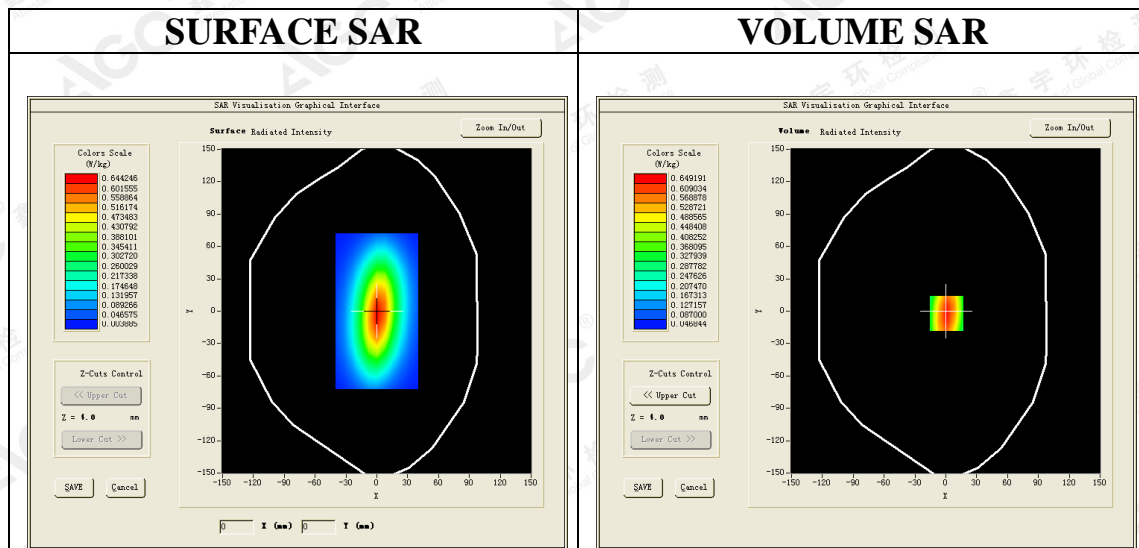

Maximum location: X=2.00, Y=-2.00

SAR Peak: 0.90 W/kg

SAR 10g (W/Kg)	0.378543
SAR 1g (W/Kg)	0.608906

The results shown in this test report refer only to the sample(s) tested unless otherwise stated and the sample(s) are retained for 30 days only. The document is issued by AGC, this document cannot be reproduced except in full with our prior written permission. The more details and the authenticity of the report will be confirmed at <http://www.agc-cert.com>.

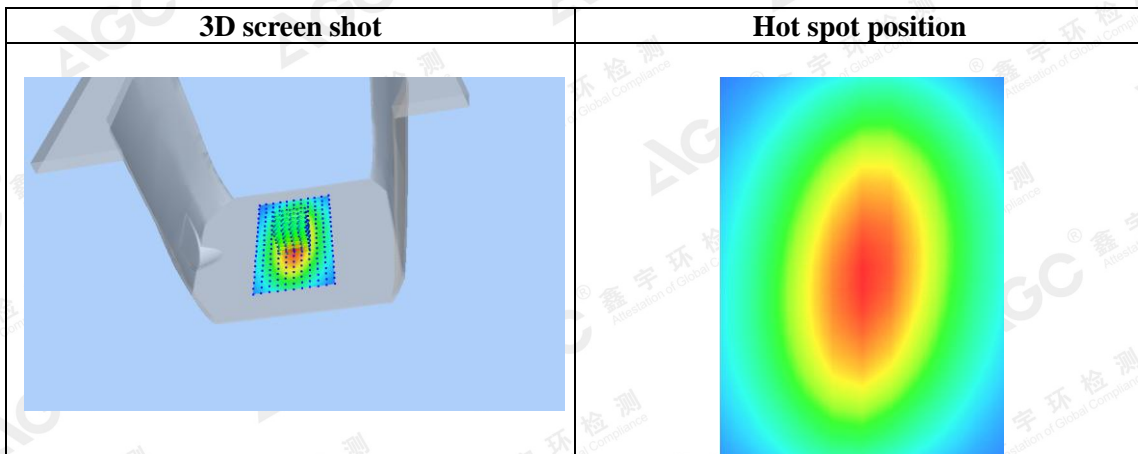
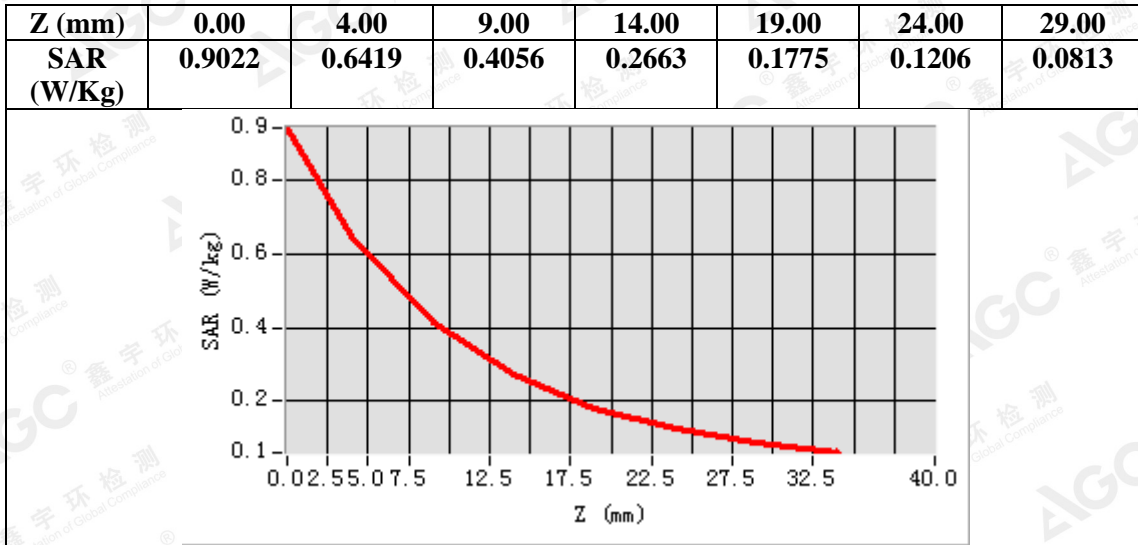

The results shown in this test report refer only to the sample(s) tested otherwise stated and the sample(s) are retained for 30 days only. The document is issued by AGC, this document cannot be reproduced except in full with our prior written permission. The more details and the authenticity of the report will be confirmed at <http://www.agc-cert.com>.

Test Laboratory: AGC Lab

Date: July 05,2018

System Check Head 835 MHz

DUT: Dipole 835 MHz Type: SID 835

Communication System CW; Communication System Band: D835 (835.0 MHz); Duty Cycle: 1:1; Conv.F=1.74

Frequency: 835 MHz; Medium parameters used: $f = 835$ MHz; $\sigma=0.90$ mho/m; $\epsilon_r = 42.17$; $\rho= 1000$ kg/m³ ;

Phantom section: Flat Section; Input Power=18dBm

Ambient temperature (°C):22.1, Liquid temperature (°C): 21.2

SATIMO Configuration:

- Probe: SSE2; Calibrated: Aug. 08,2017; Serial No.: SN 08/16 EPGO282
- Sensor-Surface: 4mm (Mechanical Surface Detection)
- Phantom: SAM twin phantom
- Measurement SW: OpenSAR V4_02_32

Configuration/System Check 835MHz Head/Area Scan: Measurement grid: dx=8mm, dy=8mm

Configuration/System Check 835MHz Head/Zoom Scan: Measurement grid: dx=8mm,dy=8mm, dz=5mm

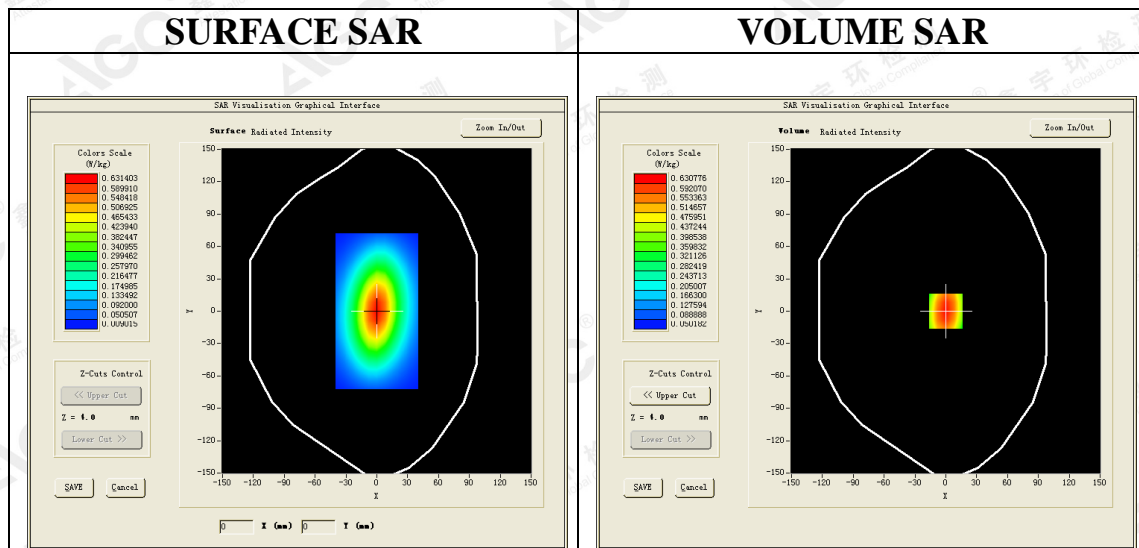

Maximum location: X=0.00, Y=1.00
SAR Peak: 0.90 W/kg

SAR 10g (W/Kg)	0.390534
SAR 1g (W/Kg)	0.611795

The results shown in this test report refer only to the sample(s) tested unless otherwise stated and the sample(s) are retained for 30 days only. The document is issued by AGC, this document cannot be reproduced except in full with our prior written permission. The more details and the authenticity of the report will be confirmed at <http://www.agc-cert.com>.

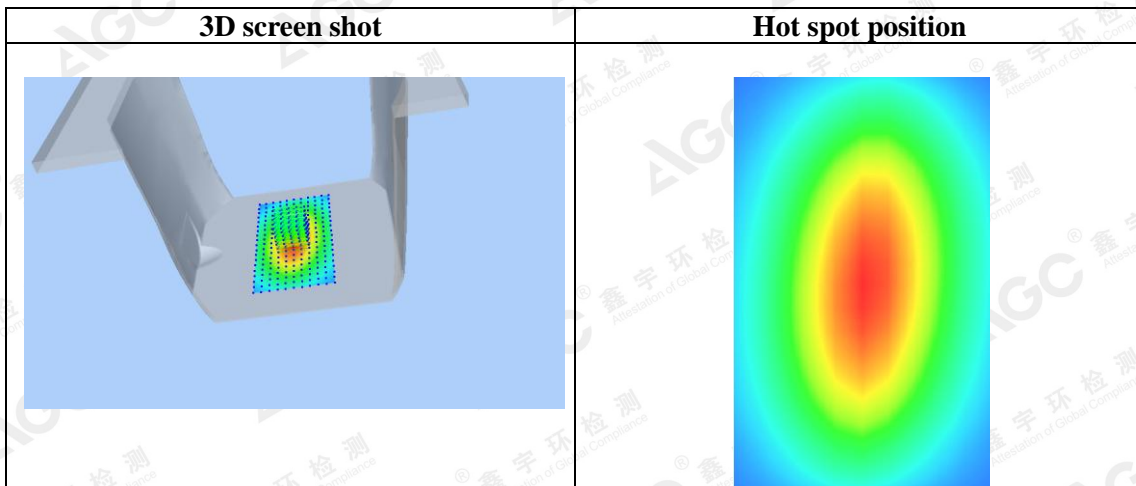
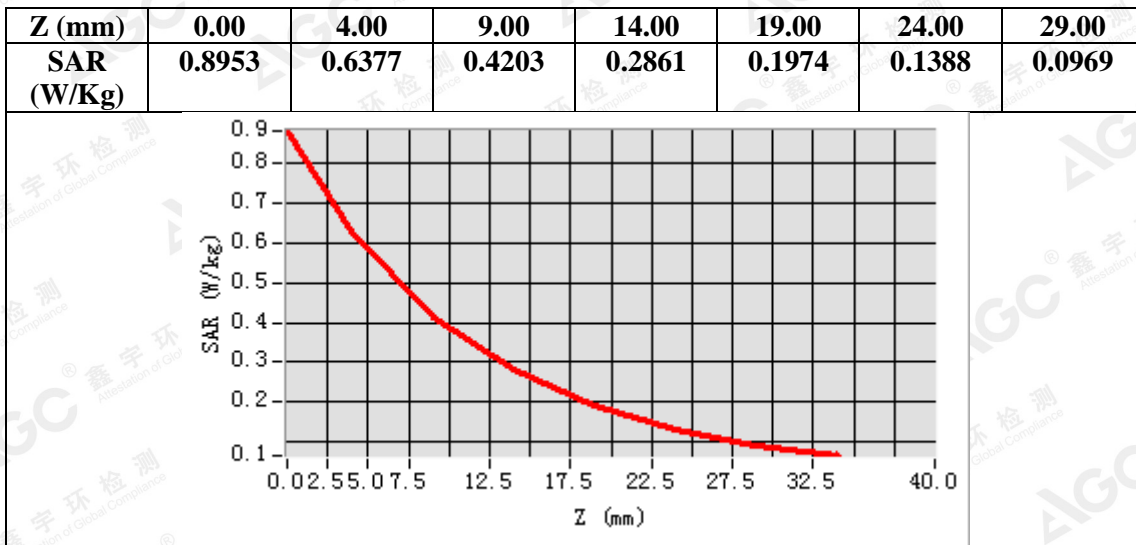

The results shown in this test report refer only to the sample(s) tested otherwise stated and the sample(s) are retained for 30 days only. The document is issued by AGC, this document cannot be reproduced except in full with our prior written permission. The more details and the authenticity of the report will be confirmed at <http://www.agc-cert.com>.

Test Laboratory: AGC Lab

Date: July 05,2018

System Check Body 835 MHz

DUT: Dipole 835 MHz Type: SID 835

Communication System CW; Communication System Band: D835 (835.0 MHz); Duty Cycle: 1:1; Conv.F=1.81

Frequency: 835 MHz; Medium parameters used: $f = 835$ MHz; $\sigma=0.95$ mho/m; $\epsilon_r = 55.13$; $\rho= 1000$ kg/m³ ;

Phantom section: Flat Section; Input Power=18dBm

Ambient temperature (°C):22.1, Liquid temperature (°C): 21.5

SATIMO Configuration:

- Probe: SSE2; Calibrated: Aug. 08,2017; Serial No.: SN 08/16 EPGO282
- Sensor-Surface: 4mm (Mechanical Surface Detection)
- Phantom: SAM twin phantom
- Measurement SW: OpenSAR V4_02_32

Configuration/System Check 835MHz Body/Area Scan: Measurement grid: dx=8mm, dy=8mm

Configuration/System Check 835MHz Body/Zoom Scan: Measurement grid: dx=8mm,dy=8mm, dz=5mm

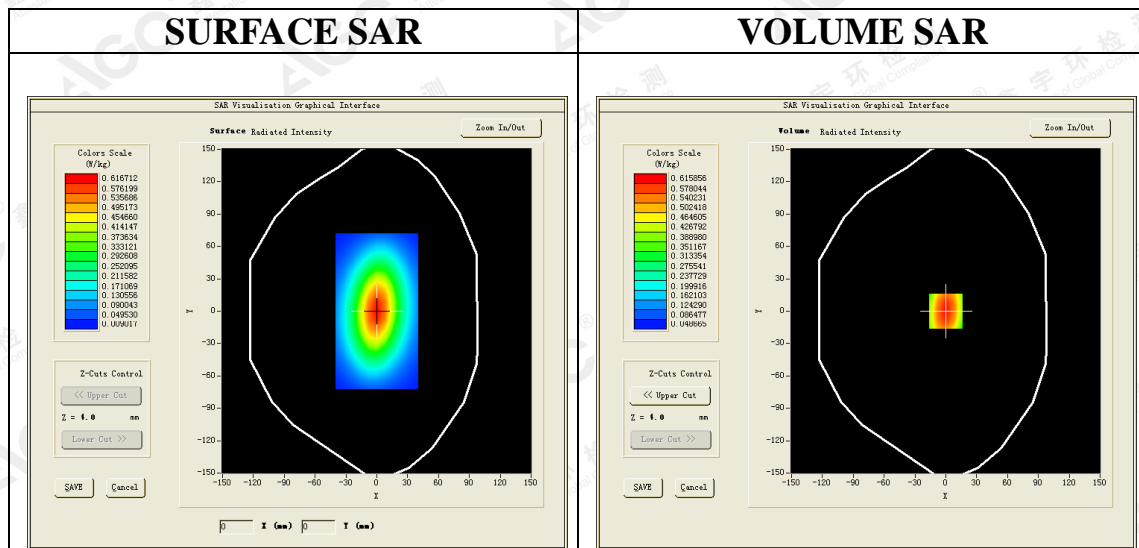

Maximum location: X=0.00, Y=0.00
SAR Peak: 0.88 W/kg

SAR 10g (W/Kg)	0.375186
SAR 1g (W/Kg)	0.585742

The results shown in this test report refer only to the sample(s) tested unless otherwise stated and the sample(s) are retained for 30 days only. The document is issued by AGC, this document cannot be reproduced except in full with our prior written permission. The more details and the authenticity of the report will be confirmed at <http://www.agc-cert.com>.

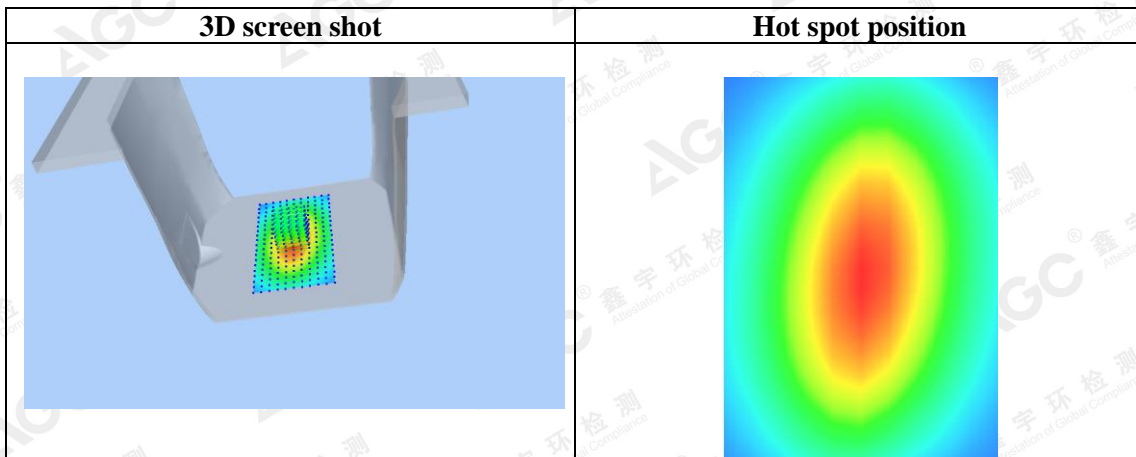
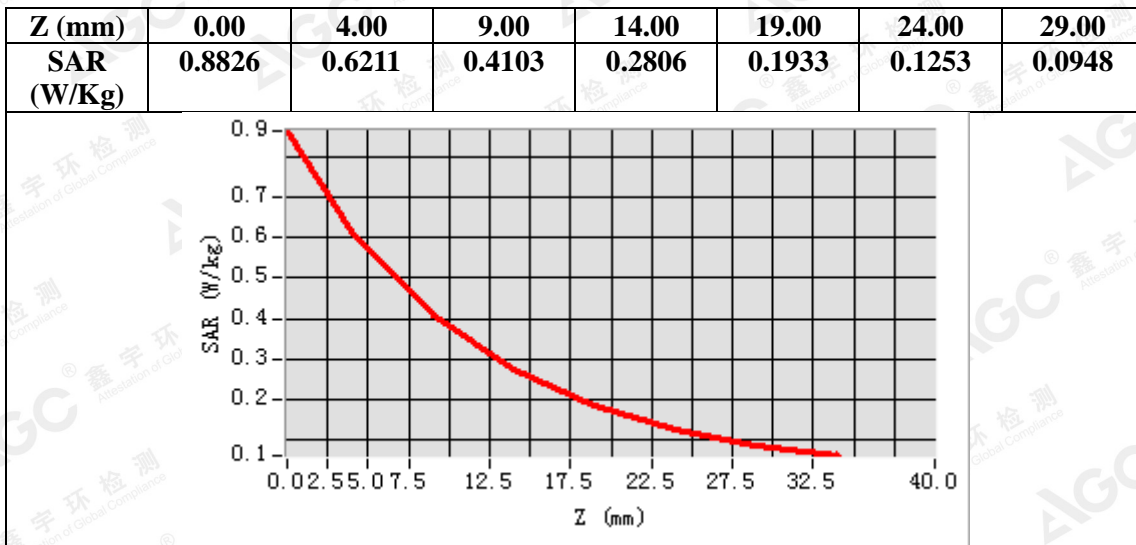

The results shown in this test report refer only to the sample(s) tested otherwise stated and the sample(s) are retained for 30 days only. The document is issued by AGC, this document cannot be reproduced except in full with our prior written permission. The more details and the authenticity of the report will be confirmed at <http://www.agc-cert.com>.

Test Laboratory: AGC Lab

Date: June 30,2018

System Check Head 835 MHz

DUT: Dipole 835 MHz Type: SID 835

Communication System CW; Communication System Band: D835 (835.0 MHz); Duty Cycle: 1:1; Conv.F=1.74

Frequency: 835 MHz; Medium parameters used: $f = 835$ MHz; $\sigma=0.88$ mho/m; $\epsilon_r=41.06$; $\rho= 1000$ kg/m³ ;

Phantom section: Flat Section; Input Power=18dBm

Ambient temperature (°C):21.8, Liquid temperature (°C): 21.5

SATIMO Configuration:

- Probe: SSE2; Calibrated: Aug. 08,2017; Serial No.: SN 08/16 EPGO282
- Sensor-Surface: 4mm (Mechanical Surface Detection)
- Phantom: SAM twin phantom
- Measurement SW: OpenSAR V4_02_32

Configuration/System Check 835MHz Head/Area Scan: Measurement grid: dx=8mm, dy=8mm

Configuration/System Check 835MHz Head/Zoom Scan: Measurement grid: dx=8mm,dy=8mm, dz=5mm

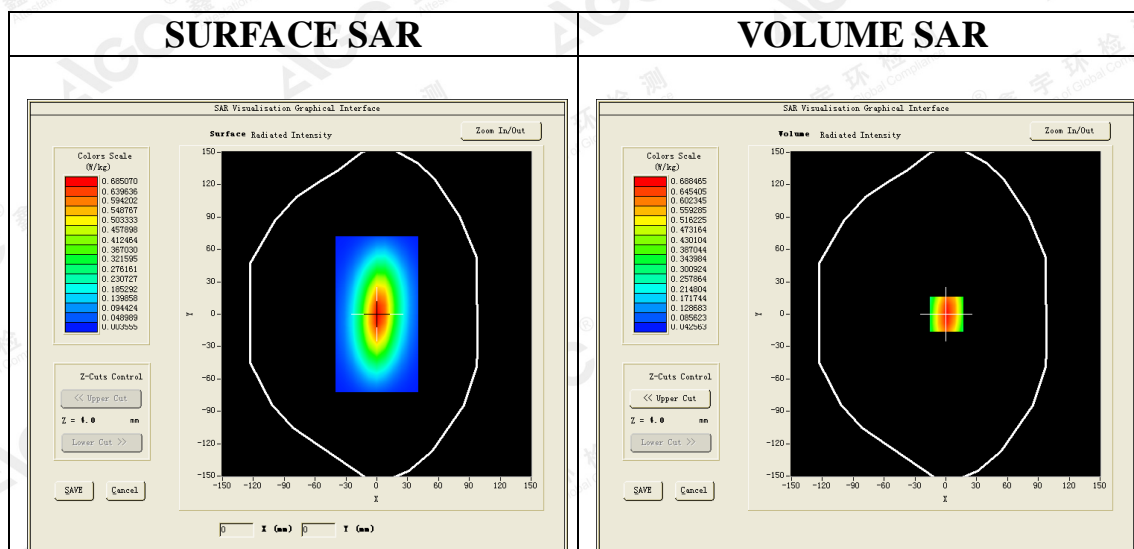

Maximum location: X=1.00, Y=1.00

SAR Peak: 0.99 W/kg

SAR 10g (W/Kg)	0.390123
SAR 1g (W/Kg)	0.647934

The results shown in this test report refer only to the sample(s) tested unless otherwise stated and the sample(s) are retained for 30 days only. The document is issued by AGC, this document cannot be reproduced except in full with our prior written permission. The more details and the authenticity of the report will be confirmed at <http://www.agc-cert.com>.

Z (mm)	0.00	4.00	9.00	14.00	19.00	24.00	29.00
SAR (W/Kg)	1.0002	0.6810	0.4226	0.2733	0.1785	0.1199	0.0803

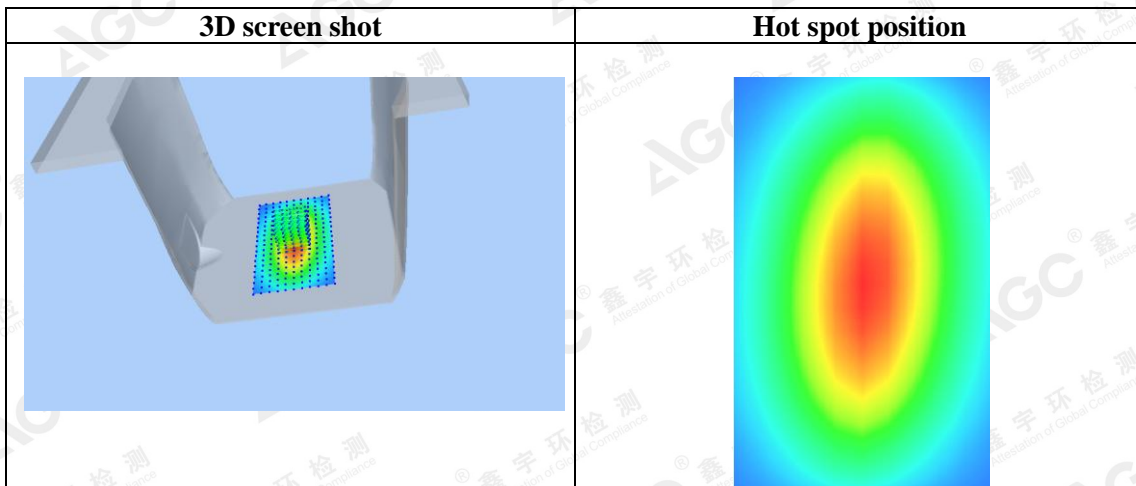
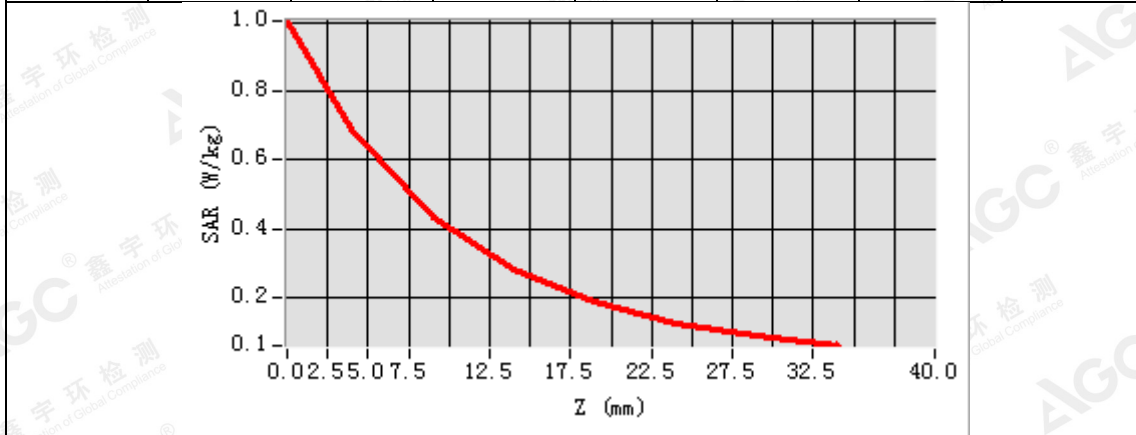

The results shown in this test report refer only to the sample(s) tested otherwise stated and the sample(s) are retained for 30 days only. The document is issued by AGC, this document cannot be reproduced except in full with our prior written permission. The more details and the authenticity of the report will be confirmed at <http://www.agc-cert.com>.

Test Laboratory: AGC Lab

Date: June 30,2018

System Check Body 835 MHz

DUT: Dipole 835 MHz Type: SID 835

Communication System CW; Communication System Band: D835 (835.0 MHz); Duty Cycle: 1:1; Conv.F=1.81

Frequency: 835 MHz; Medium parameters used: $f = 835$ MHz; $\sigma=0.95$ mho/m; $\epsilon_r = 54.89$; $\rho= 1000$ kg/m³ ;

Phantom section: Flat Section; Input Power=18dBm

Ambient temperature (°C):21.8, Liquid temperature (°C): 21.5

SATIMO Configuration:

- Probe: SSE2; Calibrated: Aug. 08,2017; Serial No.: SN 08/16 EPGO282
- Sensor-Surface: 4mm (Mechanical Surface Detection)
- Phantom: SAM twin phantom
- Measurement SW: OpenSAR V4_02_32

Configuration/System Check 835MHz Body/Area Scan: Measurement grid: dx=8mm, dy=8mm

Configuration/System Check 835MHz Body/Zoom Scan: Measurement grid: dx=8mm,dy=8mm, dz=5mm

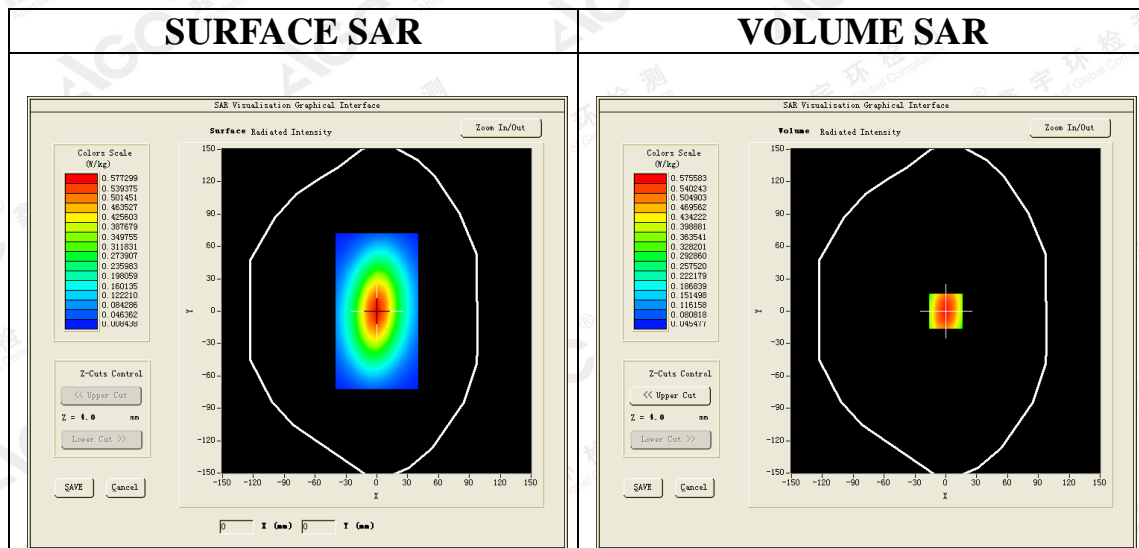

Maximum location: X=0.00, Y=0.00
SAR Peak: 0.80 W/kg

SAR 10g (W/Kg)	0.372156
SAR 1g (W/Kg)	0.580441

The results shown in this test report refer only to the sample(s) tested unless otherwise stated and the sample(s) are retained for 30 days only. The document is issued by AGC, this document cannot be reproduced except in full with our prior written permission. The more details and the authenticity of the report will be confirmed at <http://www.agc-cert.com>.

Z (mm)	0.00	4.00	9.00	14.00	19.00	24.00	29.00
SAR (W/Kg)	0.8051	0.5811	0.3856	0.2637	0.1815	0.1300	0.0902

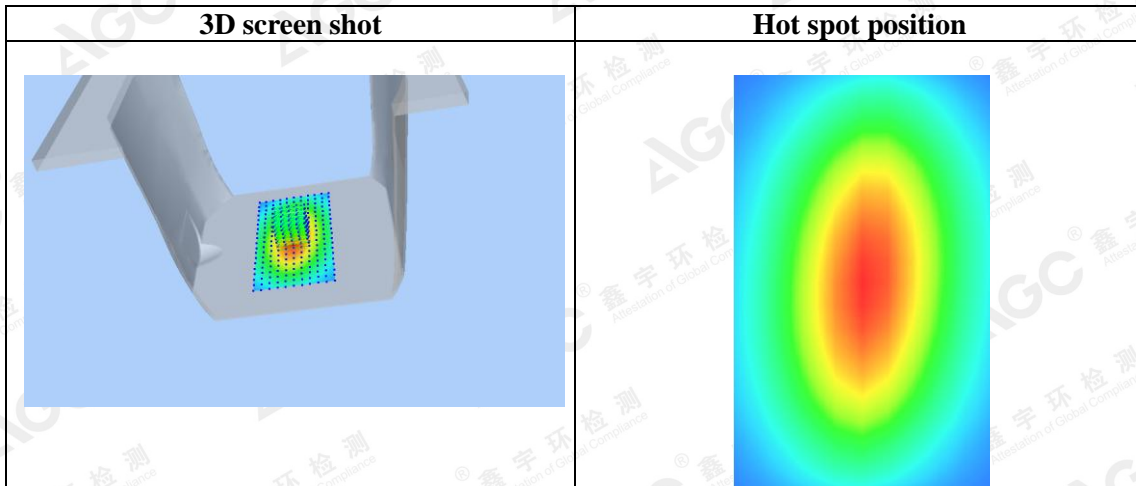
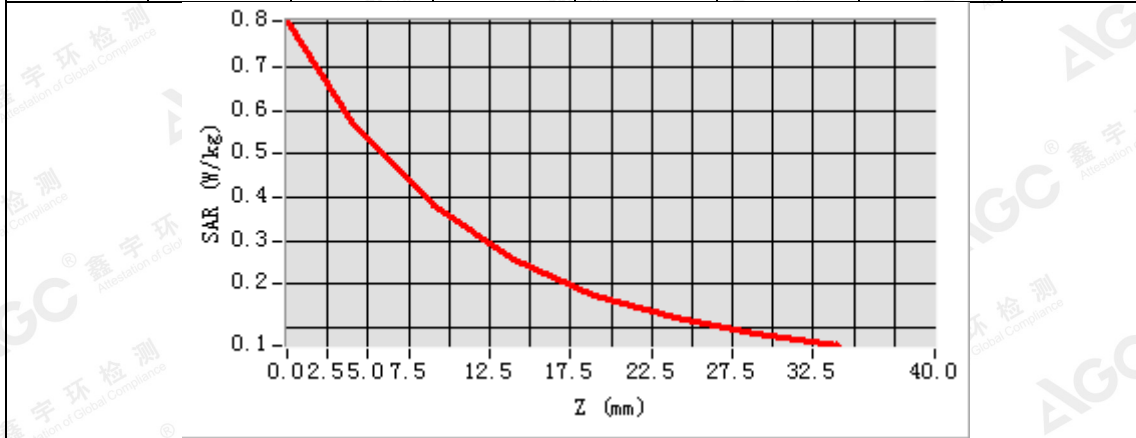

The results shown in this test report refer only to the sample(s) tested otherwise stated and the sample(s) are retained for 30 days only. The document is issued by AGC, this document cannot be reproduced except in full with our prior written permission. The more details and the authenticity of the report will be confirmed at <http://www.agc-cert.com>.

Test Laboratory: AGC Lab
System Check Head 1750MHz

Date: July 06,2018

DUT: Dipole 1800 MHz; Type: SID 1800

Communication System: CW; Communication System Band: D1700 (1750.0 MHz); Duty Cycle:1:1; Conv.F=1.99
Frequency: 1750 MHz; Medium parameters used: $f = 1750\text{MHz}$; $\sigma = 1.39 \text{ mho/m}$; $\epsilon_r = 39.46$; $\rho = 1000 \text{ kg/m}^3$;
Phantom section: Flat Section; Input Power=18dBm
Ambient temperature ($^{\circ}\text{C}$): 21.9, Liquid temperature ($^{\circ}\text{C}$): 21.3

SATIMO Configuration:

Probe: SSE2; Calibrated: Aug. 08,2017; Serial No.: SN 08/16 EPGO282

- Sensor-Surface: 4mm (Mechanical Surface Detection)
- Phantom: SAM twin phantom
- Measurement SW: OpenSAR V4_02_35

Configuration/System Check 1750MHz Head/Area Scan: Measurement grid: $dx=8\text{mm}, dy=8\text{mm}$

Configuration/System Check 1750MHz Head/Zoom Scan: Measurement grid: $dx=8\text{mm}, dy=8\text{mm}, dz=5\text{mm}$

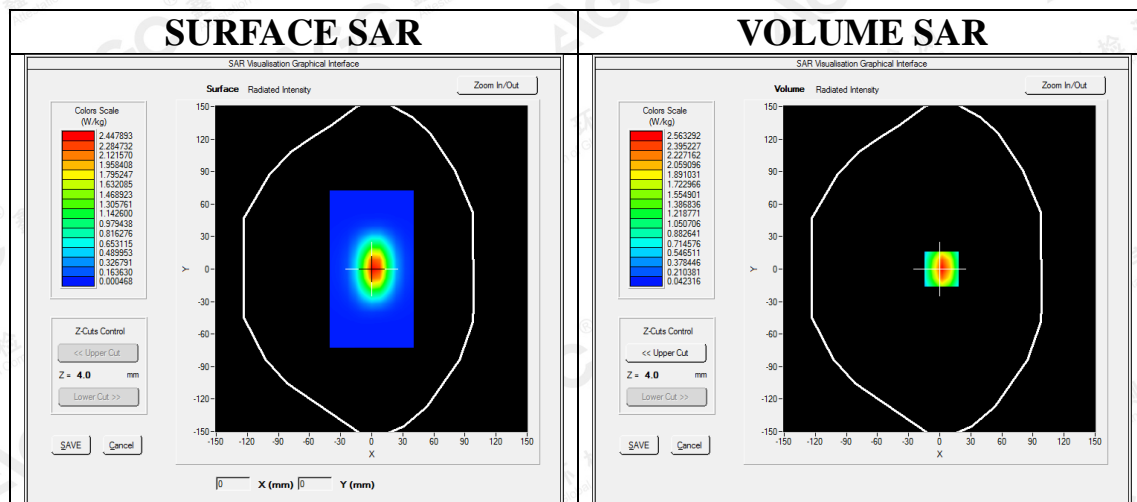

Maximum location: X=2.00, Y=0.00

SAR Peak: 4.06 W/kg

SAR 10g (W/Kg)	1.246280
SAR 1g (W/Kg)	2.417394

The results shown in this test report refer only to the sample(s) tested unless otherwise stated and the sample(s) are retained for 30 days only. The document is issued by AGC, this document cannot be reproduced except in full with our prior written permission. The more details and the authenticity of the report will be confirmed at <http://www.agc-cert.com>.

Z (mm)	0.00	4.00	9.00	14.00	19.00	24.00	29.00
SAR (W/Kg)	4.0594	2.5633	1.4103	0.8125	0.4693	0.2745	0.1618

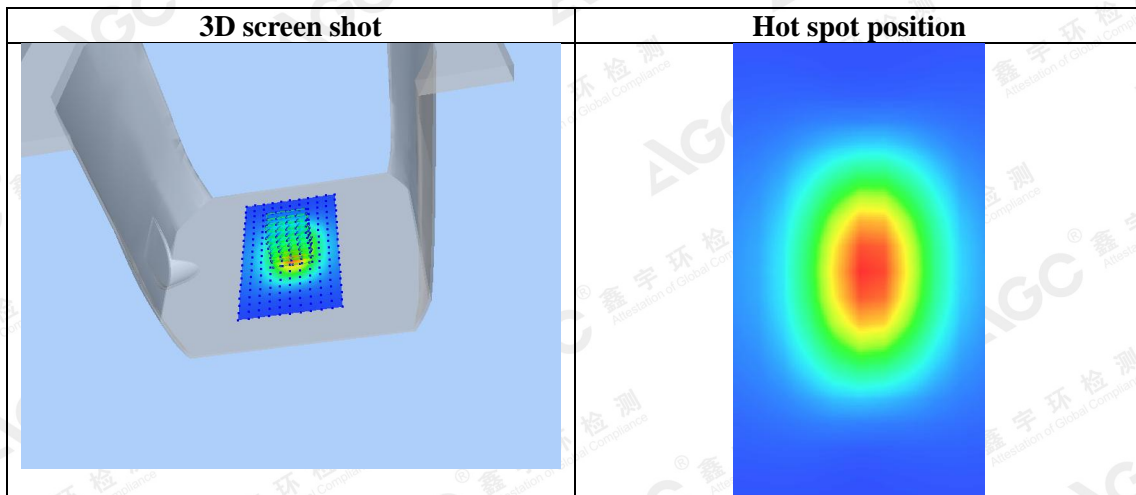
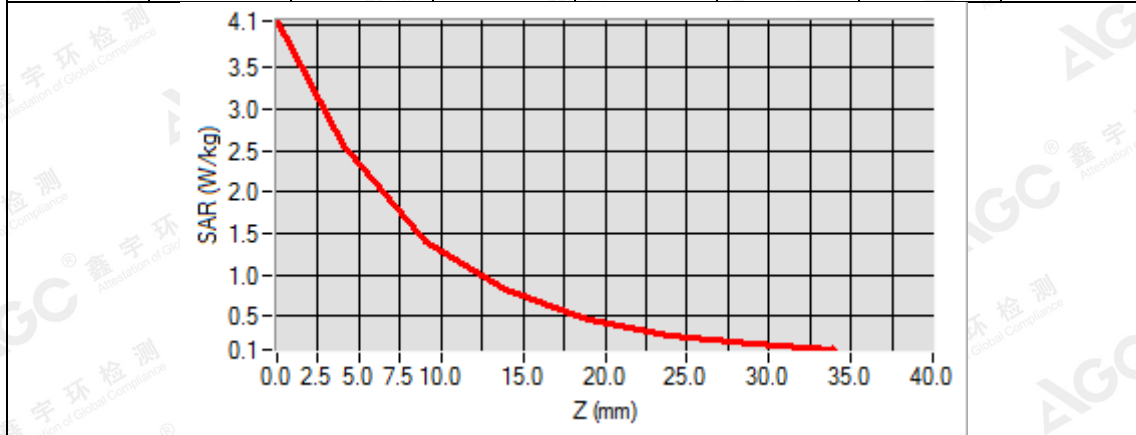

The results shown in this test report refer only to the sample(s) tested unless otherwise stated and the sample(s) are retained for 30 days only. The document is issued by AGC, this document cannot be reproduced except in full with our prior written permission. The more details and the authenticity of the report will be confirmed at <http://www.agc-cert.com>.

Test Laboratory: AGC Lab

Date: July 06,2018

System Check Body 1750MHz

DUT: Dipole 1800 MHz; Type: SID 1800

Communication System: CW; Communication System Band: D1700 (1750.0 MHz); Duty Cycle:1:1; Conv.F=2.05

Frequency: 1750MHz; Medium parameters used: $f = 1750\text{MHz}$; $\sigma = 1.51 \text{ mho/m}$; $\epsilon_r = 53.24$; $\rho = 1000 \text{ kg/m}^3$;

Phantom section: Flat Section; Input Power=18dBm

Ambient temperature (°C): 21.9, Liquid temperature (°C): 21.5

SATIMO Configuration:

Probe: SSE2; Calibrated: Aug. 08,2017; Serial No.: SN 08/16 EPGO282

- Sensor-Surface: 4mm (Mechanical Surface Detection)
- Phantom: SAM twin phantom
- Measurement SW: OpenSAR V4_02_35

Configuration/System Check 1750MHz Body/Area Scan: Measurement grid: dx=8mm,dy=8mm

Configuration/System Check 1750MHz Body/Zoom Scan: Measurement grid: dx=8mm,dy=8mm, dz=5mm

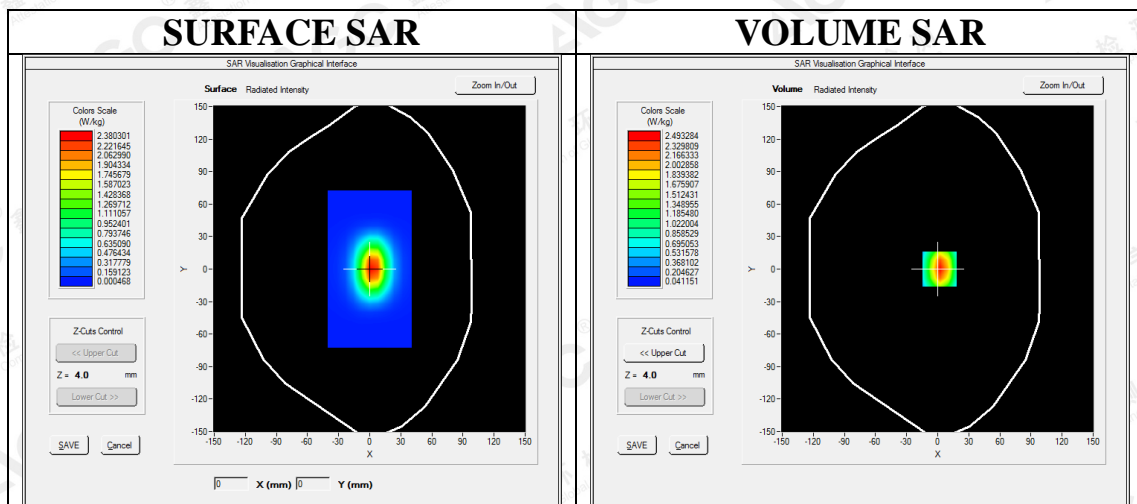

Maximum location: X=2.00, Y=0.00

SAR Peak: 3.95 W/kg

SAR 10g (W/Kg)	1.211706
SAR 1g (W/Kg)	2.351167

The results shown in this test report refer only to the sample(s) tested unless otherwise stated and the sample(s) are retained for 30 days only. The document is issued by AGC, this document cannot be reproduced except in full with our prior written permission. The more details and the authenticity of the report will be confirmed at <http://www.agc-cert.com>.

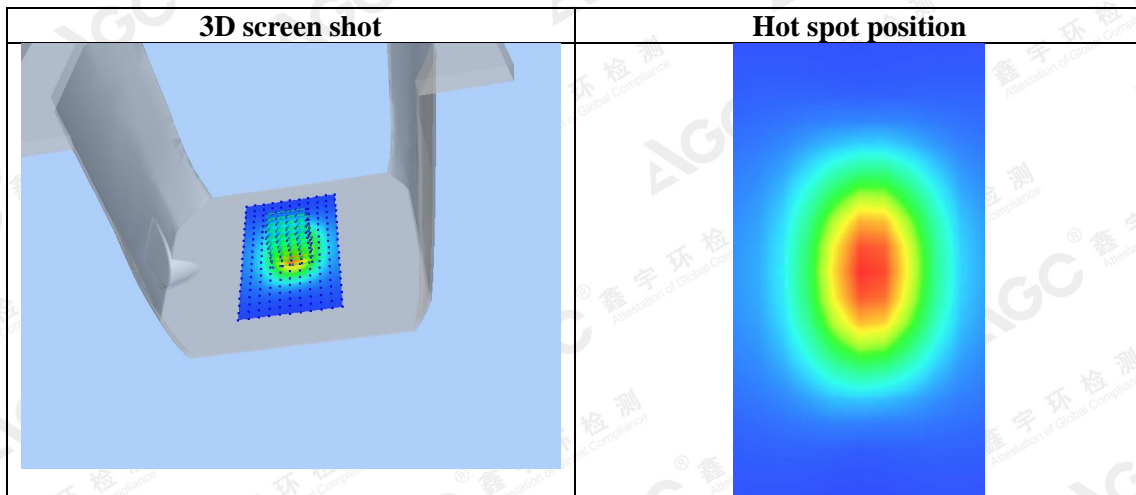
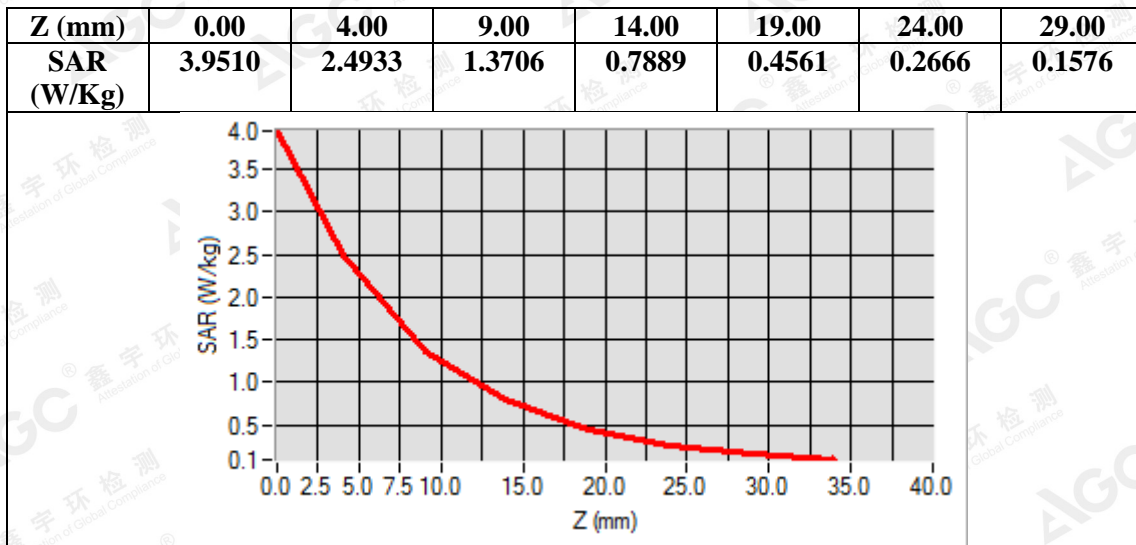

The results shown in this test report refer only to the sample(s) tested unless otherwise stated and the sample(s) are retained for 30 days only. The document is issued by AGC, this document cannot be reproduced except in full with our prior written permission. The more details and the authenticity of the report will be confirmed at <http://www.agc-cert.com>.

Test Laboratory: AGC Lab
System Check Head 1750MHz
DUT: Dipole 1800 MHz; Type: SID 1800

Date: July 09,2018

Communication System: CW; Communication System Band: D1700 (1750.0 MHz); Duty Cycle:1:1; Conv.F=1.99
Frequency: 1750 MHz; Medium parameters used: $f = 1750\text{MHz}$; $\sigma = 1.41\text{mho/m}$; $\epsilon_r = 39.22$; $\rho = 1000\text{ kg/m}^3$;
Phantom section: Flat Section; Input Power=18dBm
Ambient temperature (°C): 23.1, Liquid temperature (°C): 22.5

SATIMO Configuration:

- Probe: SSE2; Calibrated: Aug. 08,2017; Serial No.: SN 08/16 EPGO282
- Sensor-Surface: 4mm (Mechanical Surface Detection)
- Phantom: SAM twin phantom
- Measurement SW: OpenSAR V4_02_32

Configuration/System Check 1750MHz Head/Area Scan: Measurement grid: dx=8mm,dy=8mm

Configuration/System Check 1750MHz Head/Zoom Scan: Measurement grid: dx=8mm,dy=8mm, dz=5mm

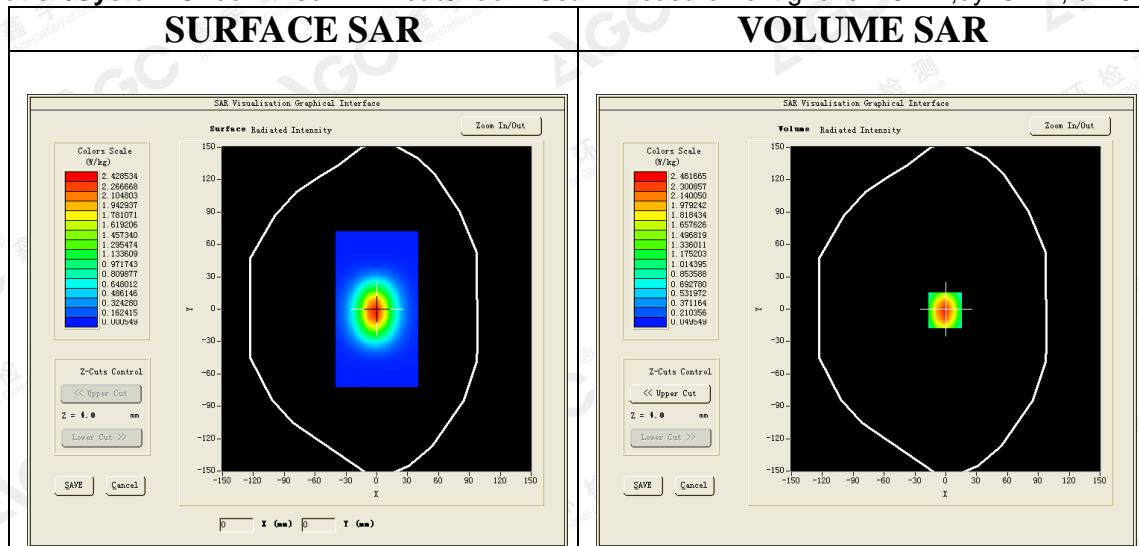

Maximum location: X=0.00, Y=0.00
SAR Peak: 3.87 W/kg

SAR 10g (W/Kg)	1.250125
SAR 1g (W/Kg)	2.341744

The results shown in this test report refer only to the sample(s) tested unless otherwise stated and the sample(s) are retained for 30 days only. The document is issued by AGC, this document cannot be reproduced except in full with our prior written permission. The more details and the authenticity of the report will be confirmed at <http://www.agc-cert.com>.

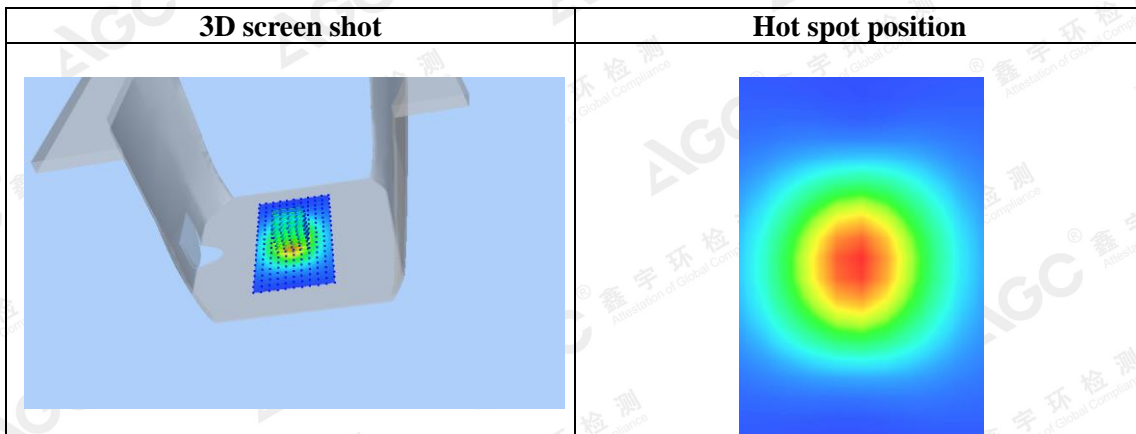
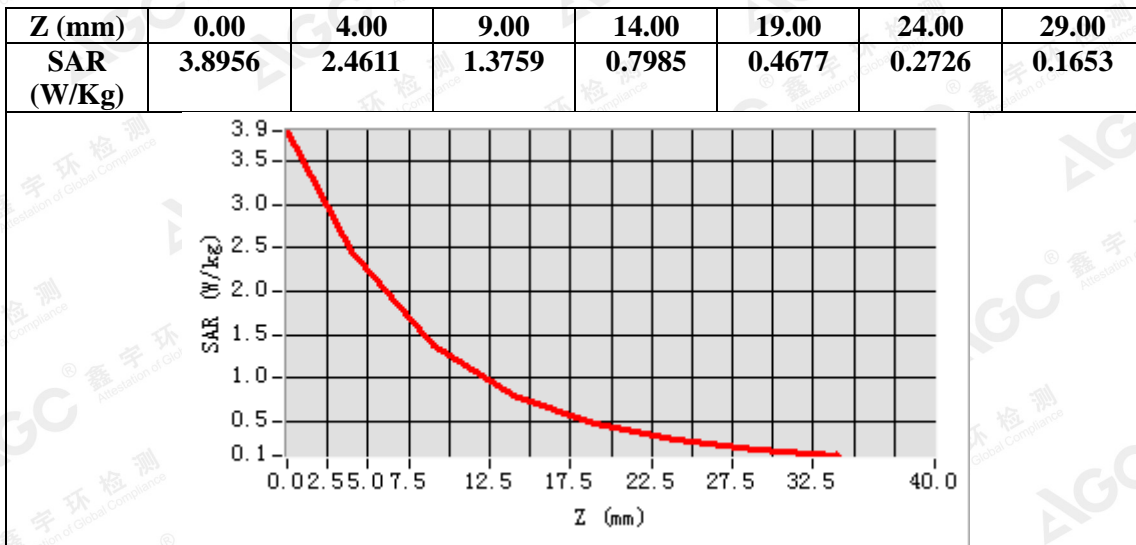

The results shown in this test report refer only to the sample(s) tested otherwise stated and the sample(s) are retained for 30 days only. The document is issued by AGC, this document cannot be reproduced except in full with our prior written permission. The more details and the authenticity of the report will be confirmed at <http://www.agc-cert.com>.

Test Laboratory: AGC Lab

Date: July 09, 2018

System Check Body 1750MHz

DUT: Dipole 1800 MHz; Type: SID 1800

Communication System: CW; Communication System Band: D1700 (1750.0 MHz); Duty Cycle:1:1; Conv.F=2.05

Frequency: 1750MHz; Medium parameters used: $f = 1750\text{MHz}$; $\sigma = 1.51 \text{ mho/m}$; $\epsilon_r = 53.34$; $\rho = 1000 \text{ kg/m}^3$;

Phantom section: Flat Section; Input Power=18dBm

Ambient temperature (°C): 23.1, Liquid temperature (°C): 22.6

SATIMO Configuration:

Probe: SSE2; Calibrated: Aug. 08, 2017; Serial No.: SN 08/16 EPGO282

- Sensor-Surface: 4mm (Mechanical Surface Detection)
- Phantom: SAM twin phantom
- Measurement SW: OpenSAR V4_02_32

Configuration/System Check 1750MHz Body/Area Scan: Measurement grid: dx=8mm,dy=8mm

Configuration/System Check 1750MHz Body/Zoom Scan: Measurement grid: dx=8mm,dy=8mm, dz=5mm

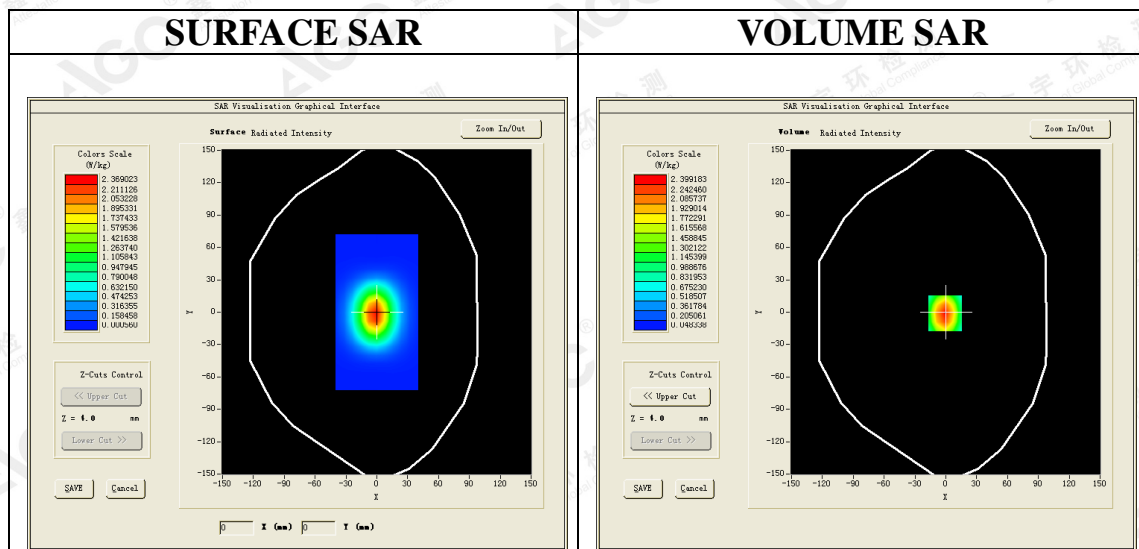

Maximum location: X=-1.00, Y=-1.00
SAR Peak: 3.74 W/kg

SAR 10g (W/Kg)	1.218178
SAR 1g (W/Kg)	2.277954

The results shown in this test report refer only to the sample(s) tested unless otherwise stated and the sample(s) are retained for 30 days only. The document is issued by AGC, this document cannot be reproduced except in full with our prior written permission. The more details and the authenticity of the report will be confirmed at <http://www.agc-cert.com>.

Z (mm)	0.00	4.00	9.00	14.00	19.00	24.00	29.00
SAR (W/Kg)	3.7550	2.3992	1.3423	0.7779	0.4550	0.2706	0.1615

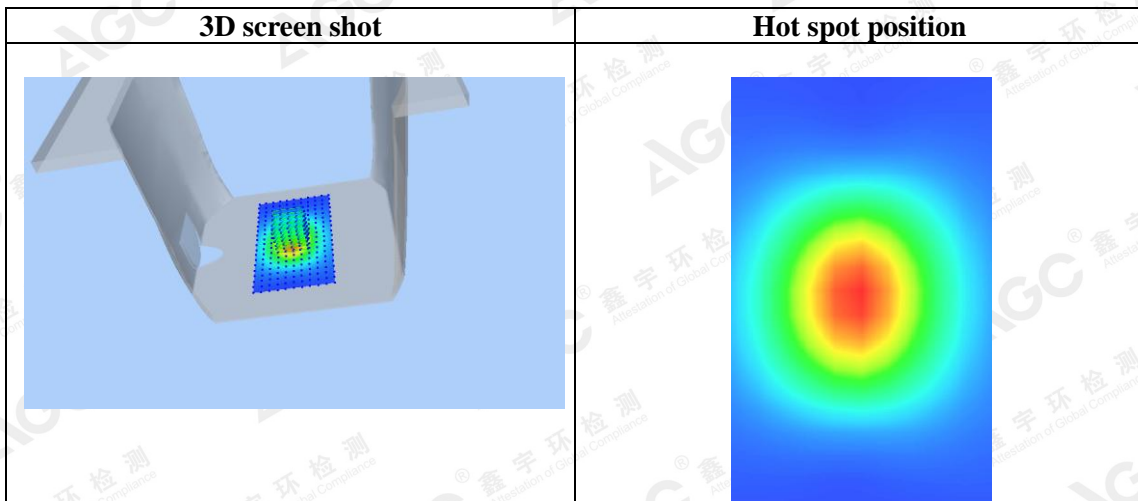
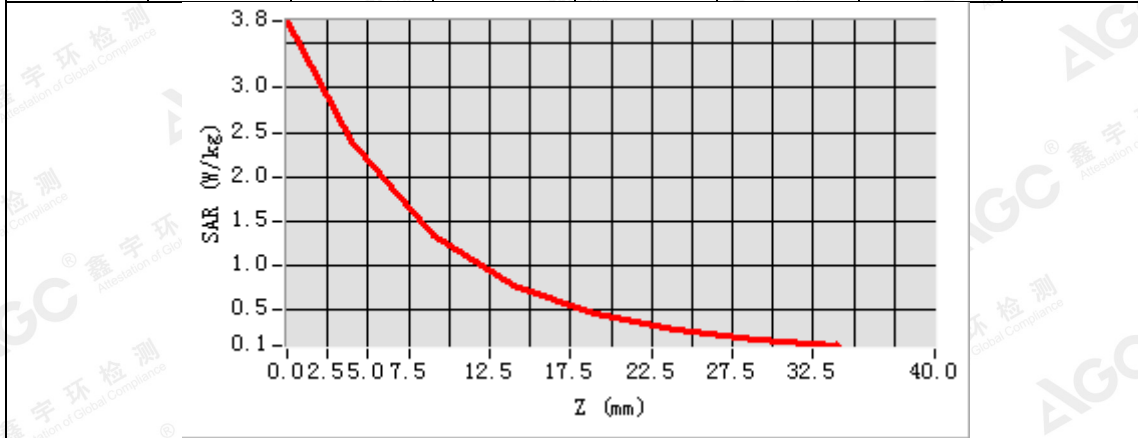

The results shown in this test report refer only to the sample(s) tested otherwise stated and the sample(s) are retained for 30 days only. The document is issued by AGC, this document cannot be reproduced except in full with our prior written permission. The more details and the authenticity of the report will be confirmed at <http://www.agc-cert.com>.

Test Laboratory: AGC Lab
System Check Head 1900MHz

Date: July 07, 2018

DUT: Dipole 1900 MHz; Type: SID 1900

Communication System: CW; Communication System Band: D1900 (1900.0 MHz); Duty Cycle:1:1; Conv.F=2.32
Frequency: 1900 MHz; Medium parameters used: $f = 1900$ MHz; $\sigma=1.40$ mho/m; $\epsilon_r=40.06$; $\rho= 1000$ kg/m³ ;
Phantom section: Flat Section; Input Power=18dBm
Ambient temperature (°C):22.1, Liquid temperature (°C): 21.7, Relative Humidity (%):56.4

SATIMO Configuration:

Probe: SSE2; Calibrated: Aug. 08,2017; Serial No.: SN 08/16 EPGO282

- Sensor-Surface: 4mm (Mechanical Surface Detection)
- Phantom: SAM twin phantom
- Measurement SW: OpenSAR V4_02_35

Configuration/System Check 1900MHz Head/Area Scan: Measurement grid: dx=8mm, dy=8mm

Configuration/System Check 1900MHz Head/Zoom Scan: Measurement grid: dx=8mm,dy=8mm, dz=5mm

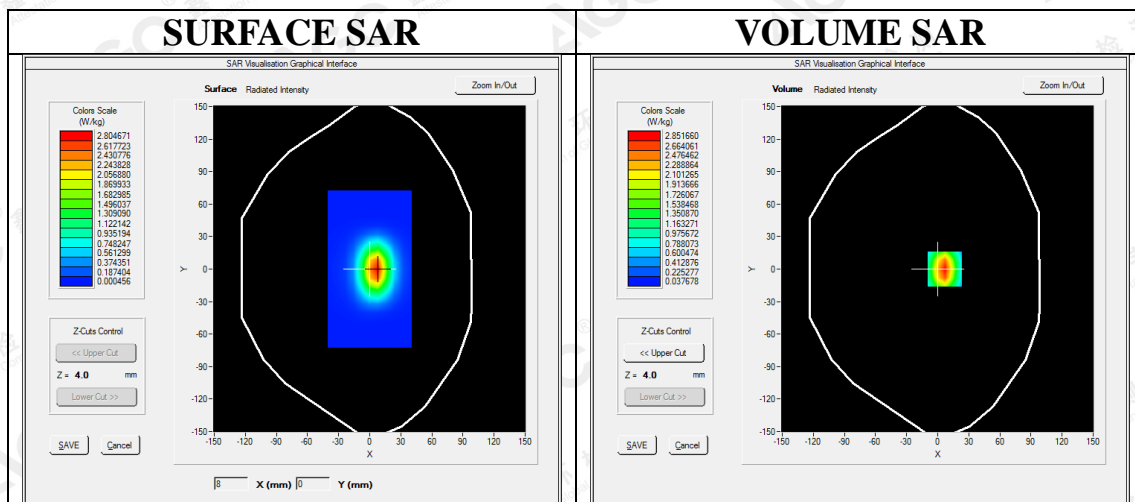

Maximum location: X=7.00, Y=0.00

SAR Peak: 4.55 W/kg

SAR 10g (W/Kg)	1.347859
SAR 1g (W/Kg)	2.675242

The results shown in this test report refer only to the sample(s) tested unless otherwise stated and the sample(s) are retained for 30 days only. The document is issued by AGC, this document cannot be reproduced except in full with our prior written permission. The more details and the authenticity of the report will be confirmed at <http://www.agc-cert.com>.

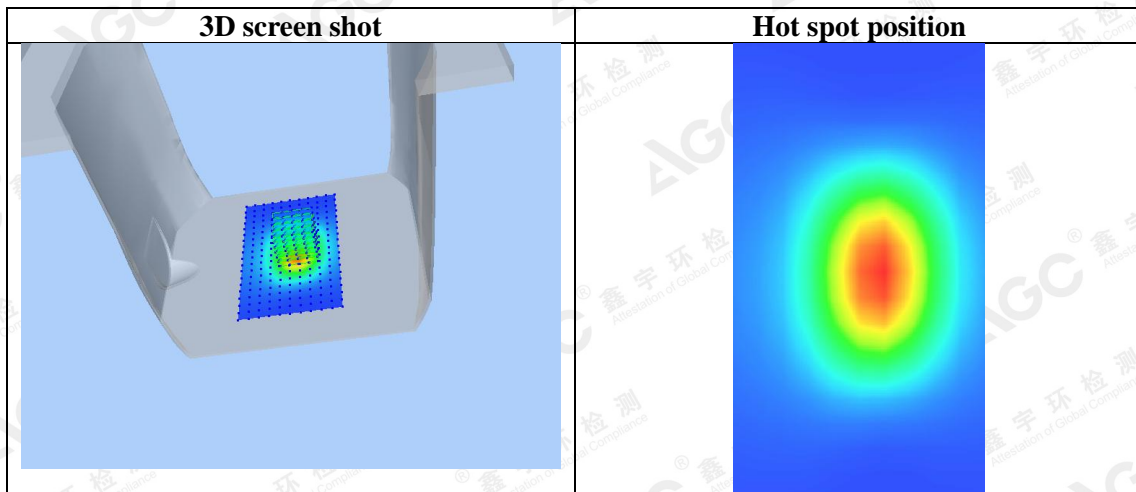
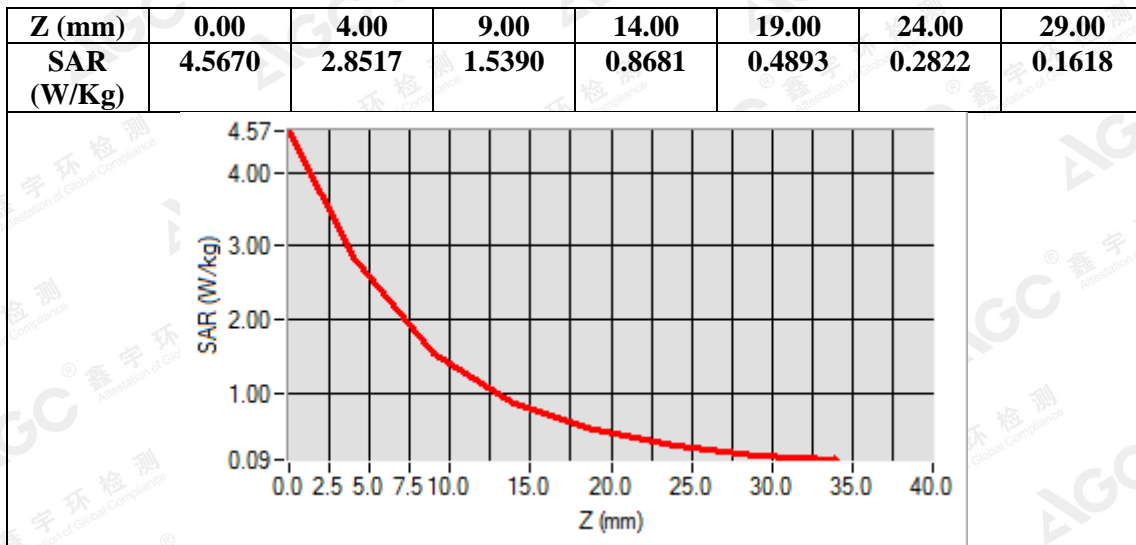

The results shown in this test report refer only to the sample(s) tested otherwise stated and the sample(s) are retained for 30 days only. The document is issued by AGC, this document cannot be reproduced except in full with our prior written permission. The more details and the authenticity of the report will be confirmed at <http://www.agc-cert.com>.

Test Laboratory: AGC Lab
System Check Body 1900MHz
DUT: Dipole 1900 MHz; Type: SID 1900

Date: July 04,2018

Communication System: CW; Communication System Band: D1900 (1900.0 MHz); Duty Cycle:1:1; Conv.F=2.39
Frequency: 1900 MHz; Medium parameters used: $f = 1900$ MHz; $\sigma = 1.51$ mho/m; $\epsilon_r = 53.73$; $\rho = 1000$ kg/m³ ;
Phantom section: Flat Section; Input Power=18dBm
Ambient temperature (°C):22.3, Liquid temperature (°C): 21.9, Relative Humidity (%): 50.6

SATIMO Configuration:

- Probe: SSE2; Calibrated: Aug. 08,2017; Serial No.: SN 08/16 EPGO282
- Sensor-Surface: 4mm (Mechanical Surface Detection)
- Phantom: SAM twin phantom
- Measurement SW: OpenSAR V4_02_32

Configuration/System Check 1900MHz Body/Area Scan: Measurement grid: dx=8mm, dy=8mm

Configuration/System Check 1900MHz Body/Zoom Scan: Measurement grid: dx=8mm,dy=8mm, dz=5mm

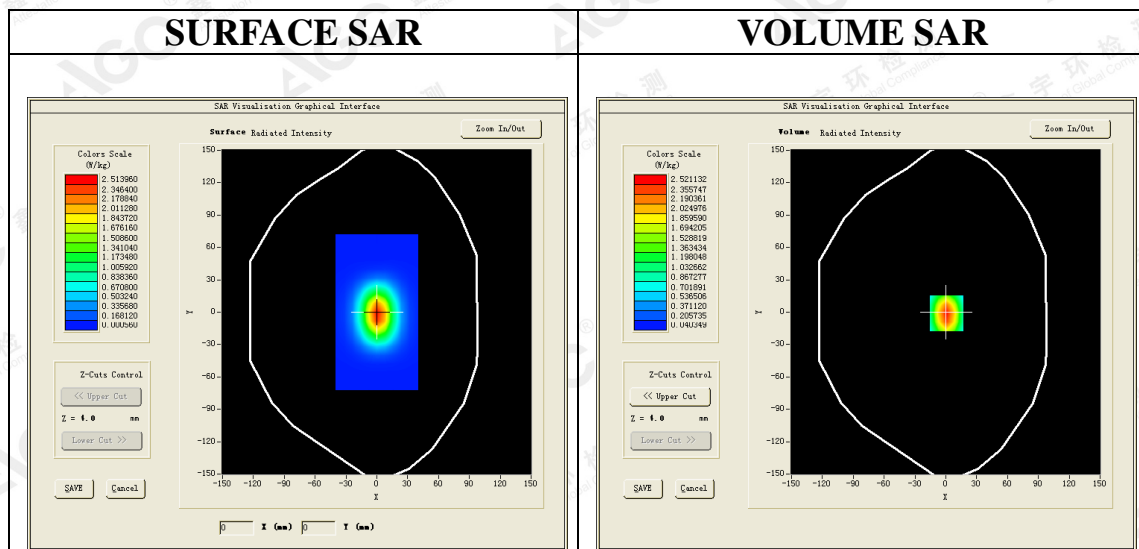

Maximum location: X=1.00, Y=-1.00
SAR Peak: 4.00 W/kg

SAR 10g (W/Kg)	1.240135
SAR 1g (W/Kg)	2.385771

The results shown in this test report refer only to the sample(s) tested unless otherwise stated and the sample(s) are retained for 30 days only. The document is issued by AGC, this document cannot be reproduced except in full with our prior written permission. The more details and the authenticity of the report will be confirmed at <http://www.agc-cert.com>.

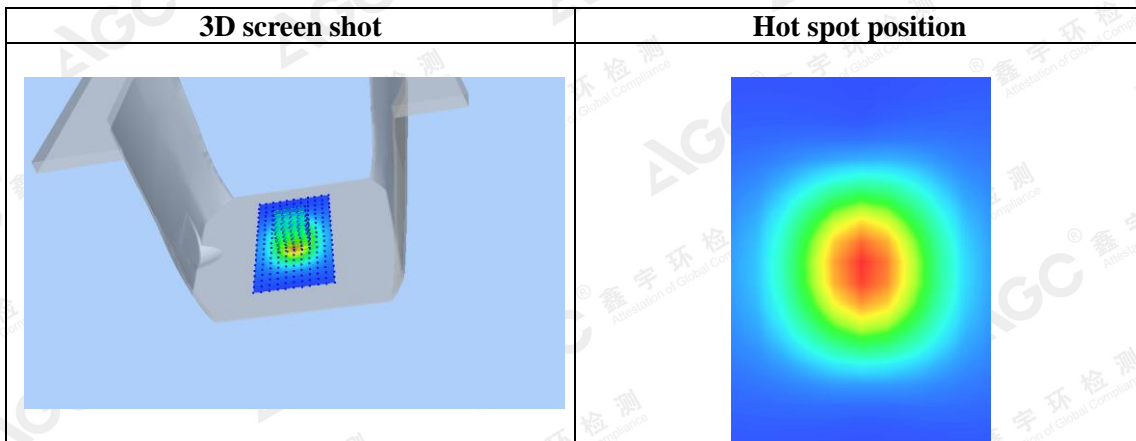
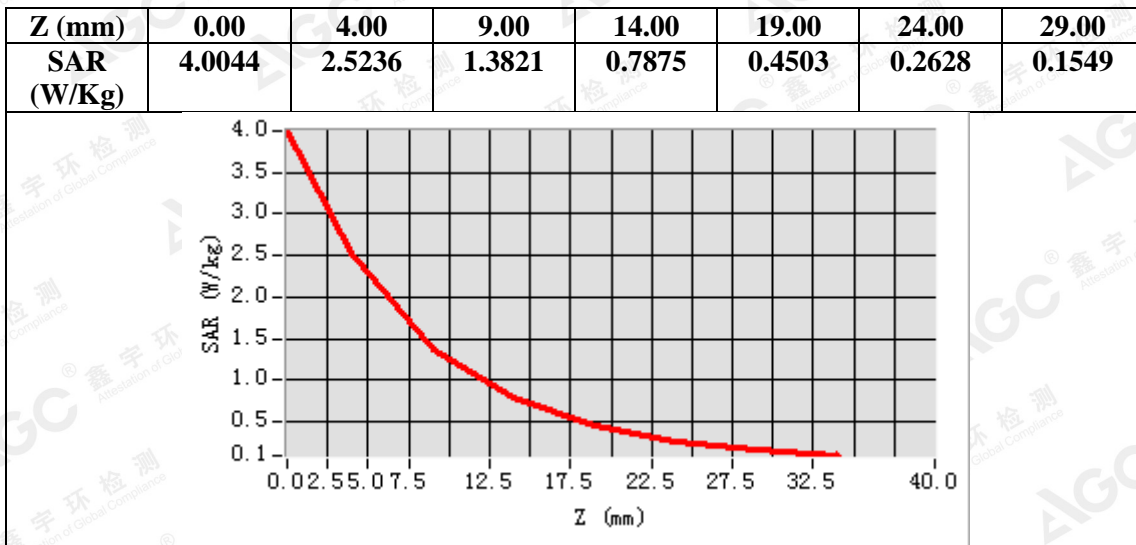

The results shown in this test report refer only to the sample(s) tested otherwise stated and the sample(s) are retained for 30 days only. The document is issued by AGC, this document cannot be reproduced except in full with our prior written permission. The more details and the authenticity of the report will be confirmed at <http://www.agc-cert.com>.

Test Laboratory: AGC Lab

Date: June 25,2018

System Check Head 1900MHz

DUT: Dipole 1900 MHz; Type: SID 1900

Communication System: CW; Communication System Band: D1900 (1900.0 MHz); Duty Cycle:1:1; Conv.F=2.32

Frequency: 1900 MHz; Medium parameters used: $f = 1900$ MHz; $\sigma = 1.40$ mho/m; $\epsilon_r = 40.00$; $\rho = 1000$ kg/m³ ;

Phantom section: Flat Section; Input Power=18dBm

Ambient temperature (°C):21.8, Liquid temperature (°C): 21.2

SATIMO Configuration:

Probe: SSE2; Calibrated: Aug. 08,2017; Serial No.: SN 08/16 EPGO282

- Sensor-Surface: 4mm (Mechanical Surface Detection)

- Phantom: SAM twin phantom

- Measurement SW: OpenSAR V4_02_32

Configuration/System Check 1900MHz Head/Area Scan: Measurement grid: dx=8mm, dy=8mm

Configuration/System Check 1900MHz Head/Zoom Scan: Measurement grid: dx=8mm,dy=8mm, dz=5mm

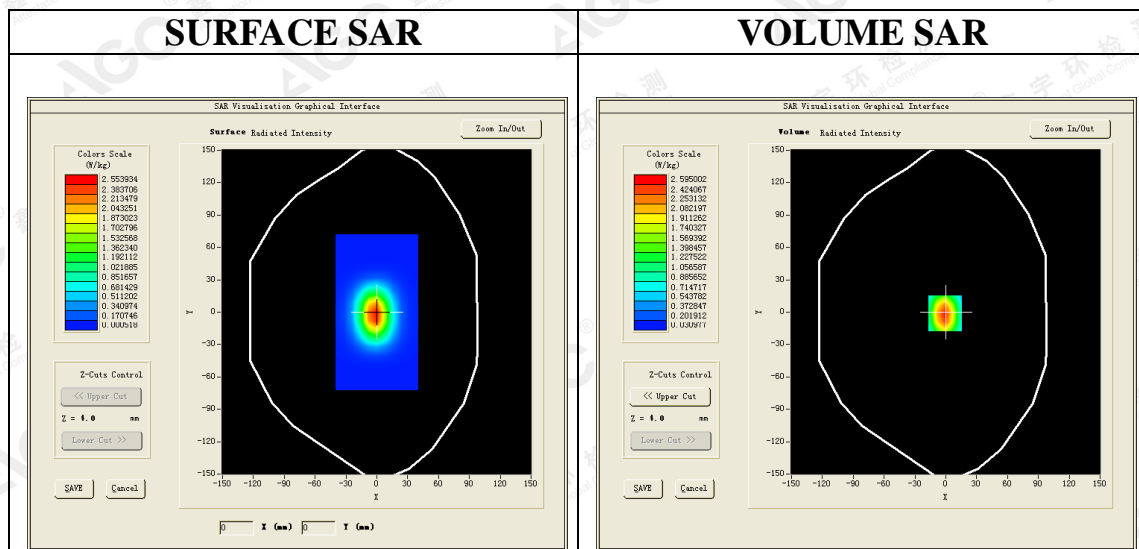

Maximum location: X=-0.00, Y=-0.00

SAR Peak: 4.19 W/kg

SAR 10g (W/Kg)	1.238774
SAR 1g (W/Kg)	2.462418

The results shown in this test report refer only to the sample(s) tested unless otherwise stated and the sample(s) are retained for 30 days only. The document is issued by AGC, this document cannot be reproduced except in full with our prior written permission. The more details and the authenticity of the report will be confirmed at <http://www.agc-cert.com>.