

Instruction Manual for the use and the maintenance of the Radio Remote Control

Original instructions

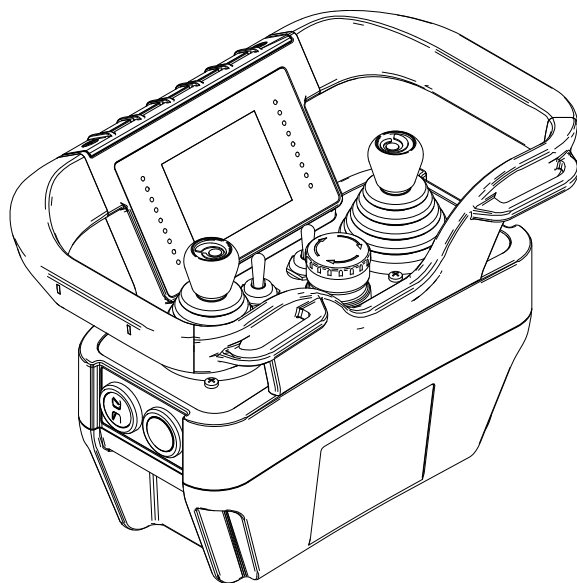

Part C: FJC Transmitting Unit

DYNAMIC SERIES



WARNING

THIS PART OF THE MANUAL CONSISTS OF: Part C - Information, instructions and warnings for the FJC (Model J2F) Transmitting Unit. The Manual consists of Part A – General, Part B – Conformity and Frequencies, Part C – Transmitting Unit, Part D – Receiving Unit, Part E – Battery and Battery Charger, plus the Technical Data Sheet.

THIS MANUAL, INCLUDING ALL PARTS THEREOF, AND ALL INSTRUCTIONS CONTAINED HEREIN, MUST BE READ CAREFULLY AND UNDERSTOOD BEFORE INSTALLING, USING, MAINTAINING OR REPAIRING THE AUTEK RADIO REMOTE CONTROL.

FAILURE TO READ AND COMPLY WITH ALL APPLICABLE WARNINGS AND INSTRUCTIONS OR ANY ONE OF THE LIMITATIONS NOTED IN THIS MANUAL CAN RESULT IN SERIOUS BODILY INJURY OR DEATH, AND/OR PROPERTY DAMAGE.

THE AUTEK RADIO REMOTE CONTROL IS NOT A STANDALONE PRODUCT AND IS INTENDED ONLY AS A COMPONENT ON A MACHINE:

- **ON WHICH AND WHERE THE USE OF A RADIO REMOTE CONTROL IS APPROPRIATE,**
- **THAT CAN BE OPERATED SAFELY AND IN ACCORDANCE WITH ALL APPLICABLE LAWS, REGULATIONS AND STANDARDS BY SUCH REMOTE CONTROL.**

ACCORDINGLY, IT IS THE RESPONSIBILITY OF THE MACHINE MANUFACTURER ON WHICH THE AUTEK REMOTE CONTROL IS INTENDED TO BE INSTALLED, to perform an in-depth and accurate risk assessment to determine if the Autec Radio Remote Control is suitable for operating a Machine in conditions of safety and operational effectiveness, taking into account the conditions of use, the intended uses and the reasonably foreseeable incorrect ones, so that the installation, maintenance and use of the Autec Radio Remote Control, and all its components, are performed only and entirely in compliance with this Manual and in accordance with all local regulations, safety standards and regulations (referred to herein as "Laws, Regulations and Standards").

With reference to the USA market the Laws, Regulations and Standards include all safety rules and regulations of the Occupational Safety & Health Administration (OSHA) (<http://www.osha.gov>), all federal, state and local laws, regulations and building and electrical codes, and all applicable standards, including but not limited to ANSI Standards.

It is also the responsibility of the Manufacturer and of the design professionals of the Machine on which the Autec Radio Remote Control is to be installed and used to be certain that the structure, condition, organization and markings of the Machine as installed at the facility is appropriate for and will allow for the safe and reliable use and control of the Machine through the Autec Radio Remote Control interface.

IT IS THE RESPONSIBILITY OF THE OWNER AND FACILITY OPERATOR, AND THEIR DESIGN PROFESSIONALS, that the installation, maintenance and operation of the Autec Radio Remote Control and all of its components are done solely and completely in accordance with this Manual, and with all applicable Laws, Regulations and Standards, even local. It is also the responsibility of the Manufacturer of the Machine on which the Autec Radio Remote Control is to be installed and used, and their design professionals, to be certain that the structure, condition, organization and markings of the Machine as installed at the facility is appropriate for and will allow for the safe and reliable use and control of the Machine through the Autec Radio Remote Control interface.

ONLY QUALIFIED AND PROPERLY TRAINED PERSONNEL SHOULD BE PERMITTED TO OPERATE OR USE THE AUTEK RADIO REMOTE CONTROL AND THE MACHINE OPERATED BY OR THROUGH THE AUTEK RADIO REMOTE CONTROL. ONLY QUALIFIED AND PROPERLY TRAINED PERSONNEL SHOULD BE PERMITTED TO BE IN THE VICINITY OF MACHINE OPERATED BY OR THROUGH THE AUTEK RADIO REMOTE CONTROL.

FAILURE TO PROPERLY INSTALL, OPERATE, MAINTAIN AND SERVICE THE AUTEK RADIO REMOTE CONTROL CAN RESULT IN SERIOUS BODILY INJURY OR DEATH AND/OR PROPERTY DAMAGE. Refer to this Manual and each of its Parts for further assistance or contact Autec. Autec is not responsible for and shall not be held liable for any installation of the Autec Radio Remote Control not performed by Autec or for any use of the Autec Radio Remote Control not in complete compliance with, and/or not maintained in complete compliance with, all Autec instructions and warnings and all applicable Laws, Regulations and Standards, even local.

Autec is not responsible for and shall not be held liable for any alteration or modification of the Autec Radio Remote Control, or the use of non-Autec components or products used with or incorporated into the Autec Radio Remote Control.

IT IS THE RESPONSIBILITY OF THE OWNER AND FACILITY OPERATOR, AND THEIR DESIGN PROFESSIONALS, to be certain that the Autec Radio Remote Control is properly maintained and serviced at all times in compliance with all Autec instructions and warnings, and with all applicable Laws, Regulations and Standards, even local.

IT IS THE RESPONSIBILITY OF THE OWNER AND FACILITY OPERATOR, AND THEIR OFFICERS, MANAGERS AND SUPERVISORS, to be certain that all Users of the Autec Radio Remote Control and that all Persons who are or will be working with or near the Machine operated by or through the Autec Radio Remote Control are fully and properly educated and trained by qualified Personnel in the proper and safe use of the Autec Radio Remote Control and of the Machine, including without limitation complete familiarity with and understanding of Autec warnings and instructions, and all applicable Laws, Regulations and Standards, even local, and that such Users and other Persons do in fact at all times operate or work with the Autec Radio Remote Control safely and ONLY in compliance with Autec instructions and warnings and with all applicable Laws, Regulations and Standards, even local. FAILURE TO DO SO CAN RESULT IN SERIOUS BODILY INJURY OR DEATH AND/OR PROPERTY DAMAGE.

IT IS THE RESPONSIBILITY OF THE OWNER AND FACILITY OPERATOR, AND THEIR OFFICERS, MANAGERS AND SUPERVISORS, to be certain that the areas in which the Machine operated by or through the Autec Radio Remote Control is located and operates are clearly delineated and marked in accordance with all Autec warnings and instructions, and all applicable Laws, Regulations and Standards, even local, and otherwise sufficient to alert and warn ALL PERSONS that the Machine is operated by or through a Radio Remote Control, and prohibiting any unauthorized access thereto. FAILURE TO DO SO CAN RESULT IN SERIOUS BODILY INJURY OR DEATH AND/OR PROPERTY DAMAGE.

FAILURE TO OPERATE THE AUTEC RADIO REMOTE CONTROL SAFELY AND IN COMPLIANCE WITH AUTEC INSTRUCTIONS AND WARNINGS AND WITH APPLICABLE LAWS, REGULATIONS AND STANDARDS, EVEN LOCAL, AND/OR PERMITTING USERS OR OTHER PERSONS NOT PROPERLY TRAINED IN THE SAFE AND PROPER USE OF THE SYSTEM, OR THE MACHINE ON WHICH IT IS INSTALLED, CAN RESULT IN SERIOUS BODILY INJURY OR DEATH AND/OR PROPERTY DAMAGE.

INDEX

1	Information on the use of instructions	7
1.1	Structure of the Instruction Manual	7
1.2	Caption and terminology	9
1.3	Symbols	9
1.4	To whom the instructions are addressed	10
1.5	Instruction storage	10
1.6	Intellectual property	10
2	Brief product presentation	11
2.1	Series, Radio Remote Control and Unit	11
2.2	Conformity with standards	11
2.3	Contacts and useful addresses	11
2.4	Warranty	11
2.5	Technical assistance and spare parts	11
3	Description of the Transmitting Unit	12
4	Technical data	13
5	Technical Data Sheet	13
6	Plates	14
7	Light and acoustic warning signals	15
7.1	Light signals	15
7.2	Acoustic signals	16
8	General operating instructions	17
8.1	Power keyswitch	17
8.2	START pushbutton	18
8.3	STOP pushbutton	18
8.4	LED and display	19
8.5	Command meaning	21
8.6	Low Power function	23
8.7	Battery	23
8.8	ID internal tx memory	24
8.9	Starting up the Radio Remote Control	24
8.10	Command activation	26
8.11	Radio link interruption	26
8.12	Transmitting Unit automatic switch off	26
8.13	Switching off the Transmitting Unit	27
8.14	"Data Feedback" function	28
8.15	Cable control	29
8.16	BACK-UP UNIT	30
9	Instructions for the User	32
9.1	Usage restrictions	32
9.2	User behaviour	32
9.3	Belt or harness	34
10	Maintenance	39
11	Malfunction signalled by the Transmitting Unit	40
12	Decommissioning and disposal	42

1 Information on the use of instructions



Before reading this part of the Manual, you must read and understand the general part (Part A) of the Manual provided with the Radio Remote Control.

1.1 Structure of the Instruction Manual

The Manual for the use and maintenance of Autec Dynamic series Radio Remote Controls consists of different parts, that altogether form the Manual; the Manual must be read carefully, understood and applied by the Radio Remote Control's Owner, User and by all those Persons that, for any reasons, may operate with the Radio Remote Control or with the Machine where it is installed.

The following table describes the structure of the Instruction Manual for the use and the maintenance of the Radio Remote Control.

Part	Title	Contents
A	General part	<ul style="list-style-type: none"> - General information regarding the series, - directions for risk assessment of the "Machine+Radio Remote Control" system, - warnings for installation of the Radio Remote Control, - warnings for use and maintenance of the Radio Remote Control, - instructions for correct transportation and storage of Radio Remote Control.
B	Conformity and frequencies	<ul style="list-style-type: none"> - Operating frequency bands of the Radio Remote Control, - conformity and law references of the Radio Remote Control.
C	Transmitting Unit	Description and instructions concerning the Transmitting Unit, including: <ul style="list-style-type: none"> - description of operation, - commands, - light signals, - malfunctions, - additional instructions to the general part.
D	Receiving Unit	Description and instructions concerning the Receiving Unit, including: <ul style="list-style-type: none"> - description of operation, - light signals, - malfunctions, - additional instructions to the general part.
E	Battery and Battery Charger	Description, warnings and instructions concerning batteries and Battery Chargers, including: <ul style="list-style-type: none"> - description of operation, - light signals, - malfunctions, - instructions for the User.

Usage and maintenance instructions are supplemented by the Radio Remote Control's Technical Data Sheet, that:

- describes the Transmitting Unit's configuration,
- indicates the relation between commands sent by the Transmitting Unit and those available on the Receiving Unit.

Usage and maintenance instruction as a whole are to be considered as an integral part both of the Autec Radio Remote Control and of the Machine, system, device or Machinery system where the Radio Remote Control is installed.

The Manufacturer of the Machine on which the Autec Radio Remote Control is installed, and the Owner and User of the Machine, must make sure that the Instruction Manual and all of its parts are included in the Instruction Manual of the Machine.

	The CD attached to each Instruction Manual includes the translations of the Manual.
---	---

Act as follows to identify the single Manual parts in the relevant language in the CD:

- choose the desired language,
- select the single parts of the Manual: refer to the code name provided on the cover of each part.

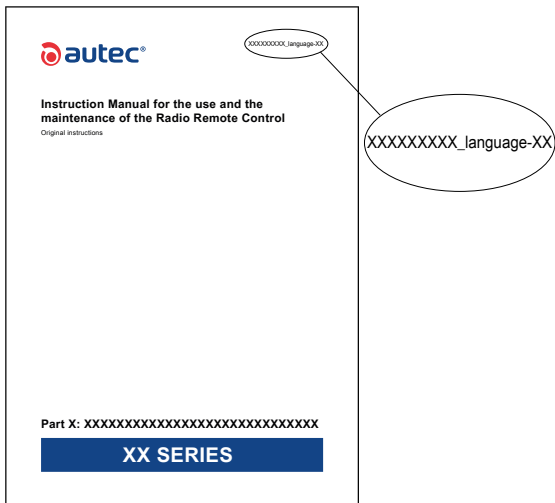

1.2 Caption and terminology

	Contact Autec if any of the instructions, symbols, warnings or images are not clear and understandable, or if you have doubts or questions.
---	---

In this part of the Manual, the terms listed below have the same meaning explained in the corresponding paragraph of the general part (Part A):

- **Unit**
- **Radio Remote Control**
- **Transmitting Unit**
- **Receiving Unit**
- **Machine**
- **Manufacturer**
- **Installer**
- **User**
- **Maintenance Technician**
- **Manual or Instruction Manual**
- **Installation Manual**
- **Person**
- **Owner**

Functions indicated for the Manufacturer, the Installer, the User and the Maintenance Technician may be performed by a single Person, if he/she has the needed competence and undertakes the resulting responsibilities. Each Person must be aware of the instructions contained in the Manual, depending on the activity they carry out.

For example, if a Manufacturer is also the Installer, and/or Maintenance Technician, he must also know and follow the instructions specifically addressed to those Persons. The same applies, for example, if a User is also the Manufacturer and/or the Installer.

1.3 Symbols

	This symbol identifies the parts of text in the Manual that must be read with special attention.
---	--

	This symbol identifies the parts of text in the Manual containing warnings, information and/or instructions that are particularly relevant with regards to safety; failure in understanding them may cause hazards for People and/or property.
---	---

1.4 To whom the instructions are addressed

Addressees of instructions are listed in the paragraph with the same title in the general part: please refer to that part.

1.5 Instruction storage

Regulation for the storage of instructions are described in the paragraph with the same title in the general part: please refer to that part.

1.6 Intellectual property

Restrictions connected to intellectual property are described in the paragraph with the same title in the general part: please refer to that part.

2 Brief product presentation

2.1 Series, Radio Remote Control and Unit

The object of this part of the Manual is the FJC (Model J2F) Transmitting Unit of an Autec Air series' Radio Remote Control.

Autec Dynamic series' Radio Remote Controls are designed to be used on Machines and provide a command interface to their command and control system, to be used from an appropriate distance and position.

2.2 Conformity with standards

The conformity of Radio Remote Controls with standards and with working requirements and conditions in the single Countries is provided in the related specific part "Conformity and frequencies" (Part B) of the Manual.

2.3 Contacts and useful addresses

The Radio Remote Controls are produced by Autec srl – Via Pomaroli, 65 – 36030 Caldogno (VI) – ITALY.

You can find contacts for Autec, its distributors, dealers and authorized service centres on the website www.autecsafety.com.

2.4 Warranty

General warranty conditions are indicated both in the relevant sheet provided together with this documentation, and in the specific page on the website www.autecsafety.com.

2.5 Technical assistance and spare parts

If you need technical services and/or spare parts, please refer to contacts provided in the website www.autecsafety.com.

When applying for technical service to Autec, its distributors, dealers and authorized service centres, the Radio Remote Control's serial number is required; you can find it on the identification plate on the Transmitting Unit and/or on the Receiving Unit.

3 Description of the Transmitting Unit

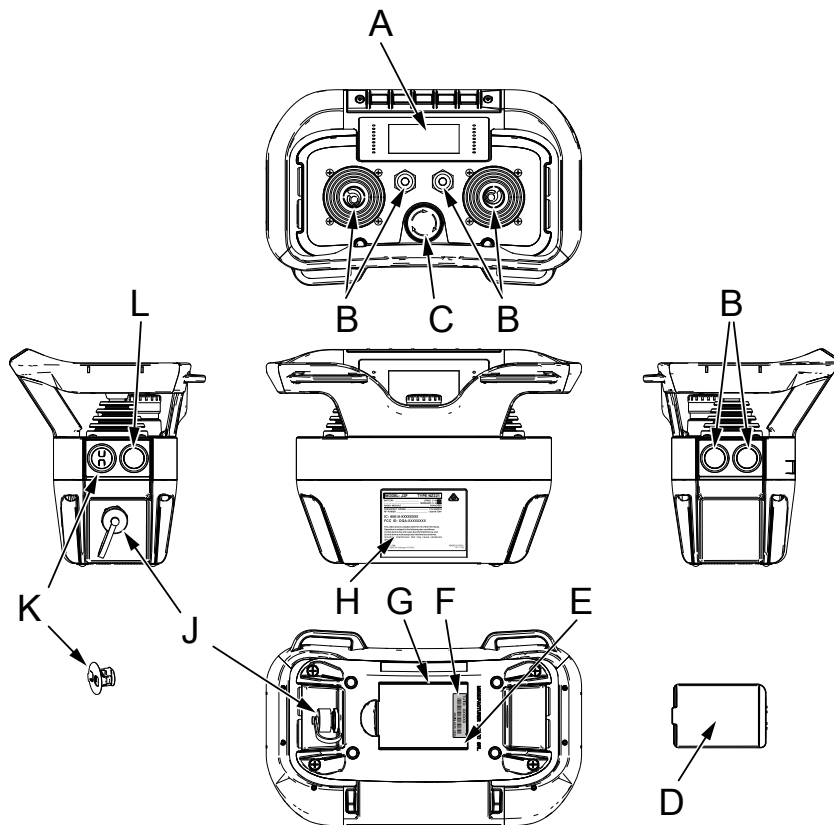

A	Display or LED
B	Actuators (joysticks, selectors, pushbuttons)
C	STOP pushbutton
D	Battery
E	Battery housing
F	Transmitting Unit identification plate

G	Radio Remote Control identification plate (if the "ID internal tx memory" is present)
H	Technical data plate
J	Connector for cable control (if present)
K	Power keyswitch
L	START pushbutton

4 Technical data

Power supply (battery MBM06MH)	7.2V $\overline{=}$
Power supply (battery LPM02)	7.4V $\overline{=}$
Antenna	internal
Housing material	PA 6 (20%fg)
Protection degree	IP65 (NEMA 4)
Dimensions	260x177x161mm (10.2x6.9x6.3In)
Weight	1.8kg (3.9Lb)
Run time at 20°C (68°F):	
- with battery MBM06MH	11h
- with battery LPM02	18.5h
- with LPM02 battery and 2.8" colour display	9h

5 Technical Data Sheet

The Radio Remote Control 's Technical Data Sheet:

- describes the Transmitting Unit's configuration,
- indicates the relation between commands sent by the Transmitting Unit and those available on the Receiving Unit.

The Technical Data Sheet must be filled in, checked and signed by the Installer, who is responsible for correct wiring.

A Technical Data Sheet must always be kept together with this Manual: if you need to use the Technical Data Sheet for administrative purposes (tests, check, etc.), make a copy of it.

 WARNING	<p>The wiring of the Receiving Unit's outputs must always reflect the wiring indicated in the Technical Data Sheet.</p>
--	--

6 Plates

The FJC Transmitting Unit has the following plates:

Plate	Position	Content
Radio Remote Control identification plate	Key ID 0-1 (if present)	The Radio Remote Control serial number
	Battery housing (if the "ID internal tx memory" is present)	
Transmitting Unit identification plate	Battery housing	Manufacturing year, bar code and Transmitting Unit identification number (TU ID)
Technical data plate	Back side of the Transmitting Unit	MODEL, TYPE and main Transmitting Unit technical data, marking and possible Radio Remote Control marks

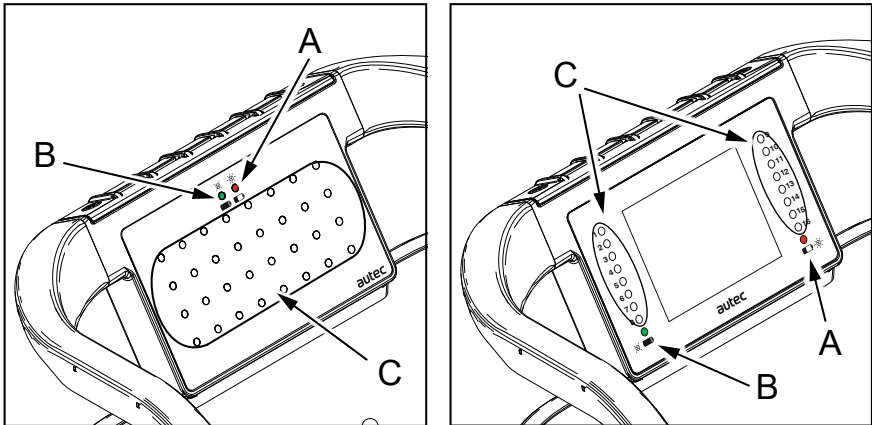

7 Light and acoustic warning signals

7.1 Light signals



A	Red LED
B	Green LED
C	LEDs for "Data Feedback" function

The FJC Transmitting Unit always has a green LED [B] and a red LED [A] that provide information regarding the Radio Remote Control.

Symbol	Meaning
	This symbol identifies the red LED [A].
	This symbol identifies the green LED [B].

 The meaning of signals provided by the LEDs identified with "C" are explained in the "Data Feedback" function part (see paragraph 8.14). The meaning of LEDs related to the "Data Feedback" function are decided and established by the Machine Manufacturer depending on the Machine's functions for which he wants to receive information.

Signals provided by the red LED [A] indicate a Radio Remote Control malfunction. The meaning of these signals and the possible actions to perform are described in chapter 11.

The meaning of signals provided by the green LED [B], when the red LED [A] is off, are described in the following table.

Signal	Meaning
The green LED is off. The red LED is off.	The Transmitting Unit is off.
The green LED blinks fast. The red LED is off.	The Transmitting and Receiving Unit do not communicate.
The green LED blinks slowly. The red LED is off.	The radio remote control is started and the Units communicate with one another.

	The meaning of the red and green LED signals cannot be modified.
---	--

7.2 Acoustic signals

The FJC Transmitting Unit has an acoustic signal device that activates when:

- The battery is nearly flat,
- the Transmitting Unit has been on for eight hours,
- The Transmitting Unit does not work correctly,
- during the Radio Remote Control start-up, the STOP pushbutton is pressed or damaged,
- during the Radio Remote Control start-up, the SAFETY command is activated (see Technical Data Sheet),
- during the Radio Remote Control start-up, one of the commands D2-D20 is activated (see Technical Data Sheet),
- during the Radio Remote Control start-up, one of the commands A1-A8 is activated (see Technical Data Sheet),
- during the Radio Remote Control start-up, one of the commands H1-H8 is activated (see Technical Data Sheet),
- during the Radio Remote Control start-up, one of the commands L1-L8 is activated (see Technical Data Sheet),
- during the Radio Remote Control start-up, the battery is flat.

The acoustic signal device activates whenever the red LED [A] illuminates. The meaning of red LED [A] signals and of the acoustic signal device, and the possible actions to adopt are described in chapter 11.

	The meaning of the acoustic signals cannot be modified.
---	---

8 General operating instructions

8.1 Power keyswitch

The Transmitting Unit have a power keyswitch. It can either be:

- M-Key (see paragraph 8.1.1).
- Key ID 0-1 (see paragraph 8.1.2).

The Radio Remote Control cannot work if the power keyswitch is not inserted in the Transmitting Unit.

8.1.1 M-Key

The M-Key allows to power the Transmitting Unit.

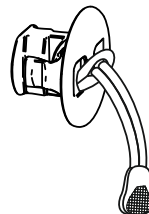

[[key_ID_bis] insertion]

Press the M-Key inside the corresponding housing until it hits the bottom.

M-Key removal

Pull the M-Key by its string to remove it from its housing.

8.1.2 Key ID 0-1

The Key ID 0-1 allows to power the Transmitting Unit.

It stores the Radio Remote Control's address. Therefore, the Key ID 0-1 can only be used in the Transmitting Unit of the Radio Remote Control to which it belongs.

As the Radio Remote Control's address is stored in the Key ID 0-1, this must be used with very strict care.

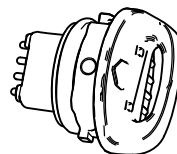

Only use the Key ID 0-1 for the Transmitting Unit with which it was provided.

Key ID 0-1 insertion

Perform the following operations to insert the Key ID 0-1:

1. insert the Key ID 0-1 into the corresponding housing,
2. rotate the Key ID 0-1 clockwise.

Key ID 0-1 removal

Perform the following operations to remove the Key ID 0-1:

3. rotate the Key ID 0-1 anticlockwise,
4. pull the Key ID 0-1 to remove it from its housing.

8.2 START pushbutton

The START pushbutton is used to:

- start the Radio Remote Control (see paragraph 8.9),
- activate the horn when the Radio Remote Control is started.

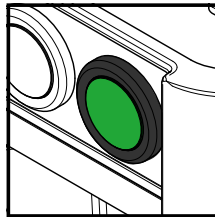

8.3 STOP pushbutton

When the STOP pushbutton is activated, the Machine stops and the Transmitting Unit switches off. To start the Radio Remote Control again and enable it to control the Machine after the STOP pushbutton has been pressed, you need to:

- make sure that the working and usage conditions are safe,
- turn the STOP pushbutton in the arrow direction (see button) to unlock it,
- start the Radio Remote Control following the procedure described in paragraph 8.9.

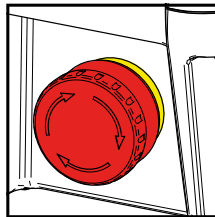
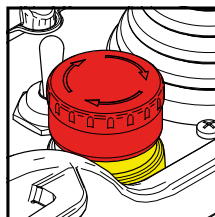

The STOP pushbutton should be pressed when it is necessary to stop the Machine immediately whenever a dangerous condition occurs.

The Machine Manufacturer and/or the Installer must provide the User with the instructions and warnings concerning possible risks that may originate from the Machine stop (by way of example: movement inertia, swinging load...).

8.4 LED and display

8.4.1 LED matrix

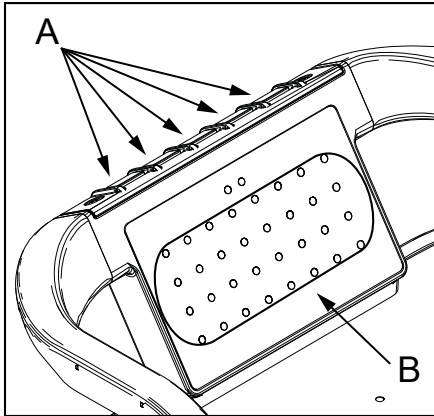

A	Five pushbuttons
B	32 LEDs

Five pushbuttons

The five pushbuttons on the Transmitting Unit are used to interact with the LED matrix.

	<p>Functions carried out by the five pushbuttons are configurable and are decided by the Machine Manufacturer: the User must be properly trained in this respect.</p> <p>No operation or movement of the Machine shall be connected to the use of the buttons described above.</p>
---	--

8.4.2 2.8" display

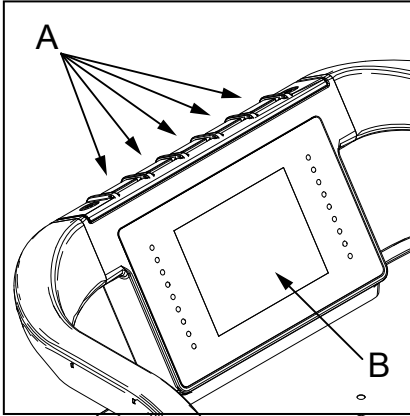

A	Five pushbuttons
B	2.8" display

Five pushbuttons

The five pushbuttons on the Transmitting Unit are used to interact with the 2.8" display.



Functions carried out by the five pushbuttons are configurable and are decided by the Machine Manufacturer: the User must be properly trained in this respect.

No operation or movement of the Machine shall be connected to the use of the buttons described above.

8.5 Command meaning



Commands on the Unit are specified according to the Machine's operations and functions. Their presence and functions are decided and defined by the Machine Manufacturer, who chooses the symbol conventions too.

The control devices described below, when present, perform the following functions (usually the symbol conventions are as in the images).

8.5.1 RPM+/- switch (during normal operation)

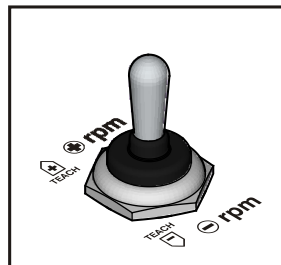
This switch increases (rpm +) or decreases (rpm -) the number of revolutions of a Machine's engine.





Symbol	Meaning
 rpm	This symbol identifies the command that increases the number of revolutions of a Machine's engine.
 rpm	This symbol identifies the command that decreases the number of revolutions of a Machine's engine.

8.5.2 TEACH switch (during REMOTE SETUP)

This switch is used to:

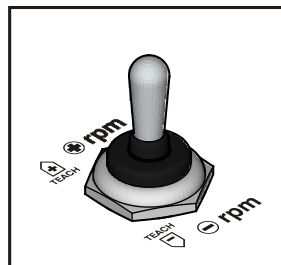
- set maximum and minimum values of proportional outputs (see "Part D" in the Instruction Manual),
- set values related to the rest position of proportional outputs (offset) (see "Part D" in the Instruction Manual),
- invert the movement direction of the joystick's axis (see Installation Manual).



Symbol	Meaning
 TEACH	This symbol identifies the TEACH+ command.
 TEACH	This symbol identifies the TEACH- command.

8.5.3 MOVEMENT SPEED SELECTOR



This switch is used to modify the speed of the Machine movements.

Depending on the configuration:

- it sets two or three speed levels,
- it increases or decreases speed.

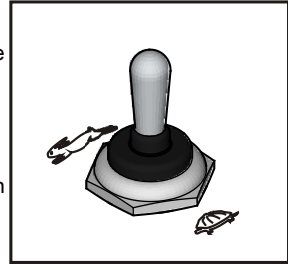
The levels and the speed increase and decrease are chosen by the Machine Manufacturer.





Symbol	Meaning
	Depending on the configuration, this symbol indicates: - the normal speed of the Machine movements or - the increase of speed of the Machine movements.
	Depending on the configuration, this symbol indicates: - the reduced speed of the Machine movements or - the decrease of speed of the Machine movements.
	If this symbol is present, it indicates that the speed of the Machine movements is further reduced.

8.5.4 Engine on/off switch

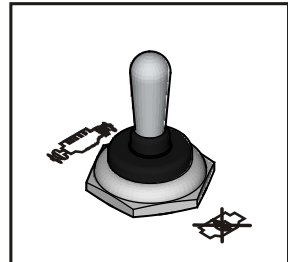
This switch is used to switch on and off a Machine's engine.

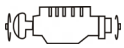

Symbol	Meaning
	This symbol indicates the power on command of a Machine's engine.
	This symbol indicates the switch off command of a Machine's engine.

8.6 Low Power function

The LOW POWER function allows transmission at a power lower than the nominal power and reduces the Radio Remote Control working range (see paragraph "Technical data" in the general part of the Instruction Manual).

This function aims at:

- making it easier to work with several Radio Remote Control in the same working environment (i.e.: many working Machines in the same working area)
- extending the battery run-time.

This function is established by the Machine Manufacturer (see Technical Data Sheet).

8.7 Battery

	<p>The Dynamic series' Transmitting Units can only be powered by Autec rechargeable batteries.</p> <p>For any warnings and instructions regarding the battery, see "Part E" in the Instruction Manual.</p>
---	--

8.7.1 Battery insertion

Push the battery towards the contacts on the Transmitting Unit (1) and insert it inside the housing (2).

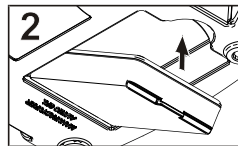
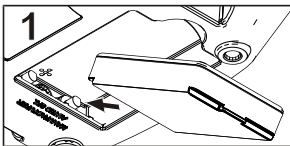

	<p>The battery slides easily into place and ensures that the positive (+) and negative (-) poles are correctly connected only if it is inserted with the plate facing its housing, so that the battery's contacts match the Transmitting Unit's contacts.</p>
---	---

8.7.2 Battery removal

Push the battery towards the contacts on the Transmitting Unit (3) and remove it from the housing (4).

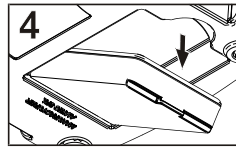
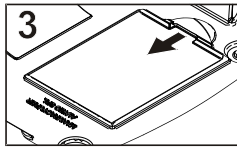

When the Transmitting Unit is not in use, remove the battery if possible.

8.8 ID internal tx memory

The "ID internal tx memory" is a key containing the address that is used to code messages exchanged between the Transmitting Unit and the Receiving Unit.

This key, if present, is inside the Transmitting Unit.

The Transmitting Unit has an "ID internal tx memory" if the Unit has a "M-Key", and not the "Key ID 0-1", as its power keyswitch (see paragraph 8.1).

8.9 Starting up the Radio Remote Control

Starting up the Radio Remote Control consists in establishing a radio link between the Transmitting Unit and the Receiving Unit.

 WARNING	<p>The Radio Remote Control start up is protected by a power keyswitch to prevent unauthorised use of the Machine.</p> <p>To activate the Radio Remote Control it is necessary to insert the power keyswitch as described in the following procedure.</p>
---	---

Perform the following procedure to start the Radio Remote Control:

1. power on the Receiving Unit respecting the voltage limits provided in the technical data (see "Part D" of the Manual). The POWER LED switches on,
2. Insert a charged battery in the Transmitting Unit (see paragraph 8.7.1),
3. insert the power keyswitch in the Transmitting Unit (see paragraph 8.1),
4. press the START pushbutton and hold it down until the green LED blinks slowly. If the red LED lights up, refer to chapter 11.

When the green LED illuminates and blinks slowly, the Radio Remote Control is active and it can send commands and activate the Machine.

8.9.1 Monitored commands

When the START pushbutton is pressed during the Radio Remote Control start up, the Transmitting Unit monitors the status of commands D2-D20, A1-A8, H1-H8 and L1-L8 and signals if any command is active through the LEDs. In this case, the Transmitting Unit automatically switches off when the signal ends. If none of the monitored commands is active, the Radio Remote Control starts.



Commands monitored by the Transmitting Unit during start up are chosen by the Machine Manufacturer according to the risk assessment. If this assessment was positive, the Manufacturer can ask Autec to modify the behaviour of commands D2-D20, A1-A8, H1-H8 and L1-L8 during start up. Look up for monitored and non-monitored commands in the Technical Data Sheet.

Commands D21-D48 and A9-A12 are not monitored during start up.

When the START pushbutton is pressed to start the Radio Remote Control, the commands that are not monitored during start up, if active, immediately activate the Machine functions that are associated with them.

8.10 Command activation

When the Radio Remote Control is started, it is possible to activate movements, functions and commands on the Machine by acting on the related joysticks, switches or pushbuttons, whose functions and symbols are decided by the Manufacturer and/or the Installer. To identify the relation between the actuators and the corresponding Machine movements, the Machine Manufacturer and/or the Installer shall provide relevant instructions and the User shall be properly trained.

8.11 Radio link interruption

When the radio link is incorrect or interrupted for a certain time lapse ("Passive Stop" indicated in the Technical Data Sheet), the automatic stop function activates (see paragraph "Control devices" in "Part A" of the Manual).

The green LED on the Transmitting Unit switches from blinking slowly to fast.

The POWER LED on the Receiving Unit switches from blinking to steady on.

To start the Radio Remote Control, press the START pushbutton and hold it down until the green LED blinks slowly. If the red LED lights up, refer to chapter 11.

When the green LED illuminates and blinks slowly, the Radio Remote Control is active and it can send commands and activate the Machine.



Please note that when the START pushbutton is pressed to start up the Radio Remote Control after the radio link had been interrupted, commands that were enabled before the interruption, and the resulting Machine's functions, are immediately activated. If the reactivation of such Machine's functions can lead to a dangerous situation, the user must perform the following procedure:

- 1. press the STOP pushbutton (so that all the functions enabled before the stop are cancelled),**
- 2. unlock the STOP pushbutton,**
- 3. press the START pushbutton.**

8.12 Transmitting Unit automatic switch off

The Transmitting Unit automatically switches off when:

- the battery is flat (see paragraph 8.12.1),
- the Radio Remote Control is not used for a certain time (see paragraph 8.12.2),
- the Transmitting Unit is powered and never switched off for eight hours non-stop (see paragraph 8.12.3).

The green LED on the Transmitting Unit switches off.

The POWER LED on the Receiving Unit switches from blinking to steady on.

To start the Radio Remote Control, press the START pushbutton and hold it down until the green LED blinks slowly. If the red LED lights up, refer to chapter 11.

When the green LED illuminates and blinks slowly, the Radio Remote Control is active and it can send commands and activate the Machine.

8.12.1 Low battery

The Transmitting Unit indicates if the battery is not sufficiently charged (the red LED blinks and an acoustic signal sounds).

The Transmitting Unit automatically switches off after 3.5 minutes after the onset of the signal. It is necessary to bring the Machine to a safe state and replace the battery with a charged one (see paragraph 8.7).

8.12.2 When the Transmitting Unit is not used

If the Transmitting Unit remains started for a certain time while none of these commands are enabled: SAFETY, D2-D10, H1-H8 or L1-L8, then it automatically switches off. This time frame is specified in the Technical Data Sheet (Automatic Switch Off).



Setting or removal of the automatic switch off time (Automatic Switch Off) is done by Autec and decided by the Machine Manufacturer, according to his risk assessment and to the operation and functions he need on the Machine.

8.12.3 Non-stop use

The Transmitting Unit indicates if it has been on for eight hours non-stop (the red LED blinks and an acoustic signal sounds).

The Transmitting Unit automatically switches off after 3.5 minutes after the onset of the signal. Bring the Machine to a safe state before the Transmitting Unit automatically switches off.

8.13 Switching off the Transmitting Unit



Switch off the Transmitting Unit when not actively using the Radio Remote Control to operate the Machine, or when work is otherwise interrupted, even for short periods. Do not leave the load hanging or the Machine in dangerous conditions (even when charging the Unit or changing the battery).

FAILURE TO DO SO CAN RESULT IN SERIOUS BODILY INJURY OR DEATH AND/OR PROPERTY DAMAGE.

Voluntary switch off of the Transmitting Unit occurs in the following cases:

- when the power keyswitch is turned anti-clockwise or removed;
- when battery is removed (see paragraph 8.7.2),
- when the STOP pushbutton is pressed.

8.14 "Data Feedback" function

The "Data Feedback" function acts through the LED array and/or the display. The User receives information and/or signals concerning some particular situations and the movements of the controlled Machine by means of this function.

During normal Radio Remote Control operation, pay particular attention to the indications displayed and signalled by the display and/or through the LEDs: they can be helpful to evaluate the Machine working status.

 WARNING	<p>Any information shown and signalled on the display and/or through the "Data Feedback" LEDs can never be considered or used as a safety signal or for legal metrology.</p> <p>When operating and moving the Machine, remember that the Radio Remote Control does not operate autonomously when potential hazardous situations are displayed and signalled.</p>
--	--

8.14.1 Operation with display

If the Transmitting Unit has a display, it is possible to show warning icons, the measurements collected from the Machine and their description.

The Machine Manufacturer chooses which information are displayed and the way they are displayed (icons and/or measurements and/or descriptions).

The battery level and the quality of the radio link are also always indicated.

8.14.2 Operation with LED

If the Transmitting Unit has an LED array for the "Data Feedback" function, specific Machine conditions are signalled if they are illuminated (by way of example: load limits, limit switch). The signalled conditions depend on the settings chosen by the Machine Manufacturer.

8.15 Cable control

The cable control is used:

- in particular working conditions, established by the Machine Manufacturer
- when it is not possible to establish a radio link between the Radio Remote Control Units,
- when working in environments where using radio frequencies is not allowed or is dangerous,
- when a fully charged battery is not available.



ATTENTION: The use of the cable control entails risk of electric shock when working near overhead or underground power line's cables.

8.15.1 Description

The cable control connects the Transmitting Unit to the Receiving Unit through a cable that replaces the radio link. The cable shall be plugged in the suitable connectors, one on the Transmitting Unit and the other on the Receiving Unit (or placed where established by the Machine Manufacturer).

When using the cable control, the working features (i.e. the meaning of actuators and the Data Feedback function) do not change.

8.15.2 Operation



Before starting to work, make sure that the cable and the corresponding connectors are intact.

Work organisation, Machines' position, passages, etc. shall be planned so as to avoid that the cable control 's cable may be damaged by moving trolleys or by the ongoing operations.

Do not use the cable control's cable to lift the Transmitting Unit.

Lay the cable control's cable in such a way as to avoid that it is squashed or strained by People or objects. Avoid contact with sharp or cutting objects that can cut the cable's protective sheath.

The cable control cannot be used if the Radio Remote Control is installed on a Machine that controls loads that are not isolated from an AC power supply or from a DC power supply higher than 30V---

	<p>Using the cable control at the same time as the waist belt or the shoulder harness means that there is a physical connection between the User and the Machine: therefore, the User must constantly check that the Machine's movements, especially in case of loss of control (by way of example: risk of overturning, of cable dragging by other Machinery), do not cause hazards. In such situations, the User must pull out the belt or open it by unfastening its buckle(s).</p>
---	---

	<p>The cable control must only be connected and disconnected when the Transmitting Unit is off.</p> <p>When you finish working with the cable control, disconnect the cable from the Transmitting Unit and from the Machine, and protect the connectors with their caps.</p>
---	--

Follow this procedure to control the Machine with the cable control:

1. power on the Receiving Unit respecting the voltage limits provided in the technical data (see "Part D" of the Manual). The POWER LED switches on,
2. make sure that the battery is inside the Transmitting Unit and leave it there even though the power supply comes from the Receiving Unit via the cable control. The battery is not, in any case, recharged through the cable control: it can only be recharged through its appropriate Battery Charger provided together with the system.
3. connect the cable control to its connector in the Receiving Unit (or where arranged by the Machine Manufacturer),
4. connect the cable control to its connector on the Transmitting Unit,
5. insert the power keyswitch in the Transmitting Unit (see paragraph 8.1),
6. press the START pushbutton and hold it down until the green LED blinks slowly. If the red LED lights up, refer to chapter 11.

When the green LED illuminates and blinks slowly, the Radio Remote Control is active and it can send commands and activate the Machine.

When working with the cable control the radio link is cut off:

8.16 BACK-UP UNIT

If the Transmitting Unit cannot be used, it can be replaced with a Transmitting Unit called "BACK-UP UNIT"; you need to ask for it from Autec.

It is identical to the Unit that can no longer be used; the only difference is the presence of the plate "BACK-UP UNIT" on the battery housing.

	<p>Insert in the "BACK-UP UNIT" the "Key ID 0-1" or the "ID internal tx memory" of the Transmitting Unit that cannot be used any longer and perform the address storage procedure described below.</p>
---	---

8.16.1 Address storage

With fully charged battery and power keyswitch in the "BACK-UP UNIT", perform this procedure:

1. press the STOP pushbutton,
2. press the START pushbutton and hold it down until the green LED switches off,
3. unlock the STOP pushbutton,

It is now possible to start the Radio Remote Control and control the Machine with the "BACK-UP UNIT" Transmitting Unit.

9 Instructions for the User

The chapter "Instructions for the User" in "Part A" of the Instruction Manual contains the warnings for the use that add to those provided in this chapter. Therefore, please refer to that part of the Manual.

The following instructions refer to general usage situations for the FJC Transmitting Unit, and indicate how user should or should not behave when using the Unit: these do not cover any possible risk situation and/or drawback that may depend on specific applications of Autec Radio Remote Controls.

However, instructions given in the following paragraphs do not replace nor complete the instructions that must be provided to the User by the Manufacturer of the Machine where an Autec Radio Remote Control (to which the FJC Transmitting Unit belongs) is installed.

9.1 Usage restrictions

	<p>If the Radio Remote Control User wears electronic devices (by way of example: pacemaker, implantable cardiac defibrillator, hearing aids), the Transmitting Unit must be kept at least 15 cm away from those devices when in use.</p>
---	---

9.2 User behaviour

Besides the instructions contained in the General Part (Part A) of the Instruction Manual, when using the FJC Transmitting Unit, the User must:

- observe and comply with all instructions and warnings provided by the Machine Manufacturer;
- observe and comply with all instructions and warnings provided by the Installer;
- observe and comply with all instructions and warnings provided by the Person responsible for the Machine commissioning or making the Machine available for work;
- observe and comply with all instructions and warnings provided in the Radio Remote Control Manual;
- observe and comply with all applicable Laws, Regulations and Standards, even local.
- follow and put into practice the working instructions he received, and/or those he must be aware of because of his work and his tasks;
- avoid using the Radio Remote Control if he has not been properly trained and prepared, and if he has not been qualified for its use by the Person responsible for the work;
- make sure that the Transmitting Unit and the Receiving Unit are whole and work perfectly;
- make sure that the Machine reacts correctly to the commands activated by the Autec Radio Remote Control;
- not perform any operation if the tests mentioned in the previous two points did not give positive results;

- make sure that the Radio Remote Control operation and the consequent Machine movement occur in safety conditions, to prevent hazards to people and/or property;
- adopt the necessary caution to avoid that the Machine operation causes dangerous situations of any type; to this end, the User's physical and health status shall be taken into account too;
- avoid leaving the Transmitting Unit unattended or in such a condition that it may be damaged, tampered with, operated by people who are not qualified or by the movement of people and/or objects (by way of example due to: fall, movement, contact);
- operate the Transmitting Unit by holding it correctly in his hands, so that he can activate the Machine movements correctly and in safe conditions and monitor its light signals;
- keep at a safe distance from any risk situations originating from the use of the Machine where the Autec Radio Remote Control is installed;
- avoid doing anything else while using the Radio Remote Control, such as, by way of example, operate other Machines and/or other devices, eat and/or drink, use communication devices (phone, radio phone, etc.), keyboards, computers, IT devices or AV equipment, or carry out any other action that may pose the User in the situation not to be able to correctly control the Transmitting Unit and/or the Machine;
- activate immediately, and anyway in safe conditions, the stop devices available on the Transmitting Unit and/or on the Machine, in case dangerous situations occur, even if they do not depend on the use of the Machine;
- use the Transmitting Unit in such a way as to avoid contact with objects and/or people, fall and loss of control;
- use the Transmitting Unit with supports such as belts and the like, which are provided with the Radio Remote Control;
- not modify or tamper with the Transmitting Unit, its components and/or its commands; not modify the indications and/or meaning and/or abbreviations and/or symbols and/or original stickers on the Transmitting Unit's panel.

9.3 Belt or harness

The FJC Transmitting Unit always comes with a waist belt or a shoulder harness: the User must mount the belt or the harness to the Transmitting Unit and use it as described in paragraph 9.3.1 or 9.3.2.



Replace the belt or harness if it is damaged or worn.

9.3.1 Waist belt

Assembly

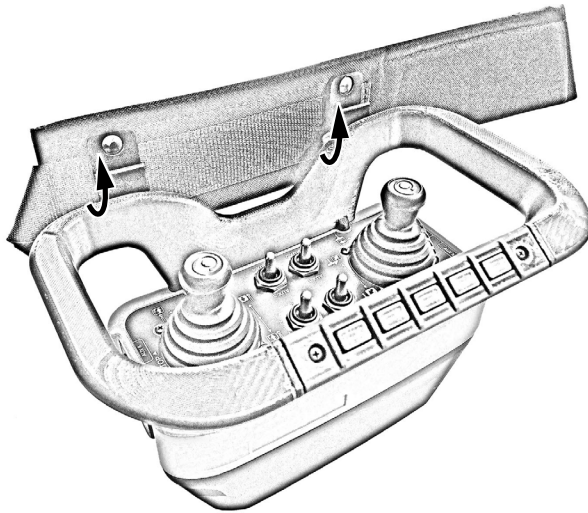

Use

The User must wear the Radio Remote Control with the belt as shown in the photo below, to avoid its fall, loss, loss of control, accidental contact and improper use.



If the Transmitting Unit and the belt are used in a different way from the one described in the above mentioned figure, this constitutes improper use and may lead to damage to the Transmitting Unit, to the User, to people and/or property.

9.3.2 Shoulder harness

Assembly

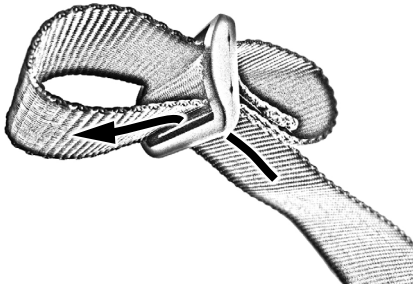

1

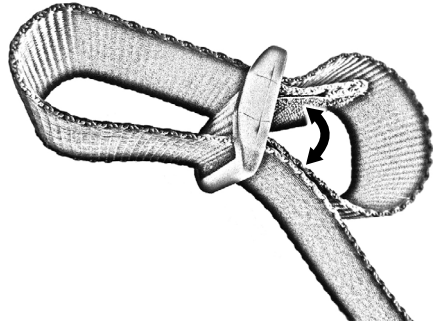

2

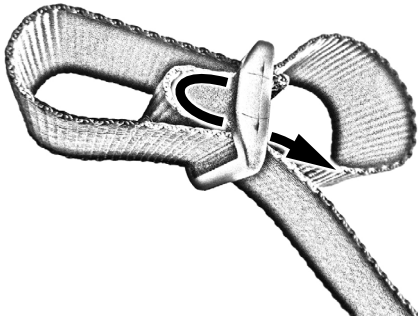

3



4

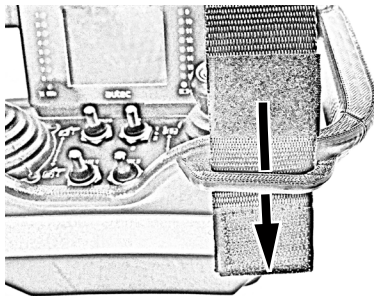

5

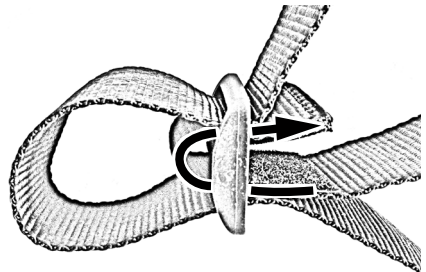

6

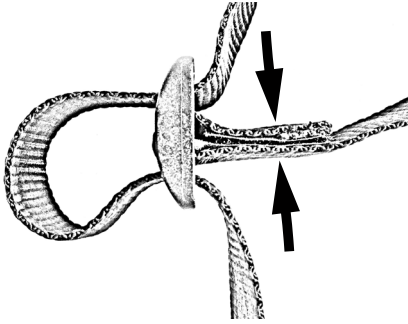

7

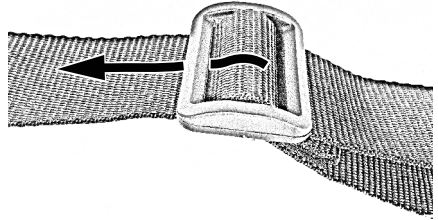

8

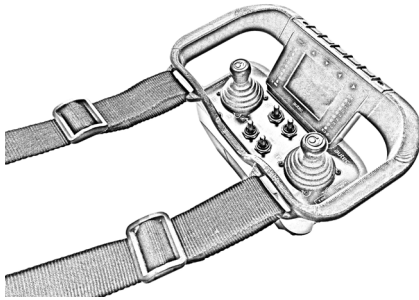

9

Use

The User must wear the Radio Remote Control with the belt as shown in the photo below, to avoid its fall, loss, loss of control, accidental contact and improper use.



If the Transmitting Unit and the belt are used in a different way from the one described in the above mentioned figure, this constitutes improper use and may lead to damage to the Transmitting Unit, to the User, to people and/or property.

10 Maintenance

Instructions for correct Radio Remote Control maintenance are described in the chapter "Maintenance" included in "Part A" of the Instruction Manual. Therefore, please refer to that part of the Manual.

11 Malfunction signalled by the Transmitting Unit

The table below lists malfunctions that are signalled by LEDs on the Transmitting Unit and the solution to those malfunctions.

If the problem persists after attempting the suggested solution, contact the support service of the Machine Manufacturer.

Light signals	Possible reason	Solutions
The green LED blinks fast. The red LED^a blinks for 3.5 minutes.	The battery is not sufficiently charged or the Transmitting Unit has been on for eight hours ^b .	The battery needs to be replaced with a charged one (see paragraph 8.7) or you need to switch off the Transmitting Unit and re-start the Radio Remote Control.
The green LED blinks slowly. The red LED^a blinks for 3.5 minutes.		
The green LED is off. The red LED^a has ONE very long blink.	The Transmitting Unit does not work correctly.	Perform the address storage procedure (see paragraph 8.16.1).
At Radio Remote Control start up, the green LED is off and the red LED^a has ONE long blink^b.	The STOP pushbutton is pressed.	Unlock the STOP pushbutton.
At Radio Remote Control start up, the green LED is off and the red LED^a has TWO long blinks^b.	At least one of the actuators corresponding to commands D2-D20 and SAFETY is activated.	Bring the actuators to the rest position.
At Radio Remote Control start up, the green LED is off and the red LED^a has THREE long blinks^b.	The battery is very low.	The battery needs to be replaced with a charged one (see paragraph 8.7).

Light signals	Possible reason	Solutions
At Radio Remote Control start up, the green LED is off and the red LED^a has FOUR long blinks^b.	At least one of the actuators corresponding to commands A1-A8, H1-H8 and L1-L8 is activated.	Bring the actuators to the rest position.

- a. Whenever the red LED illuminates, the acoustic signal device activates.
- b. After this signal, the Transmitting Unit switches off.
- c. The Transmitting Unit automatically switches off when the signal ends.

12 Decommissioning and disposal

Instructions for correct decommissioning and disposal of Radio Remote Controls are described in chapter "Decommissioning and disposal" in "Part A" of the Instruction Manual. Therefore, please refer to that part of the Manual.



Via Pomaroli, 65 - 36030 Caldogno (VI), ITALY
PH: +39 0444 901000 - Fax: +39 0444 901011
info@autecsafety.com - www.autecsafety.com

MADE IN ITALY