



Test Report - FCC PART 90 (TNB) Applicant: Spectra Engineering Pty. Ltd.

Approved for Release By:

Signature: Bruno Clavier

Name & Title: Bruno Clavier, General Manager

Date of Signature 6/25/2021

This test report shall not be reproduced except in full without the written and signed permission of Timco Engineering Inc. (IIA). This test report relates only to the items tested as identified and is not valid for any subsequent changes or modifications made to the equipment under test.



Table of Contents

1.	APPLICANT INFORMATION.....	4
1.1	PART 90 TEST RESULT SUMMARY	5
2.	LOCATION OF TESTING.....	6
2.1	TEST LABORATORY	6
2.1	TESTING WAS PERFORMED, REVIEWED BY	6
3.	TEST SAMPLE(S) (EUT/DUT).....	7
3.1	DESCRIPTION OF THE EUT.....	7
3.2	CONFIGURATION OF EUT	8
3.3	TEST SETUP OF EUT.....	8
4.	TEST METHODS & APPLICABLE REGULATORY LIMITS.....	9
4.1	TEST METHODS/STANDARDS/GUIDANCE:	9
4.2	APPLIED LIMITS AND REGULATORY LIMITS:.....	9
5.	MEASUREMENT UNCERTAINTY.....	9
6.	ENVIRONMENTAL CONDITIONS	9
6.1	TEMPERATURE & HUMIDITY.....	9
7.	LIST OF TEST EQUIPMENT AND TEST FACILITY.....	10
7.1	LIST OF TEST EQUIPMENT	10
8.	TEST RESULTS	11
8.1	POWER AT THE FINAL AMPLIFIER.....	12
8.2	RF OUTPUT POWER.....	13
8.3	BANDWIDTH & EMISSION.....	14
8.3.1	<i>Bandwidth Plot, 99%, 2.5 kHz FM, 770 MHz</i>	<i>15</i>
8.3.2	<i>Bandwidth Plot, 99%, 4 kHz FM, 770 MHz</i>	<i>16</i>
8.3.3	<i>Bandwidth Plot, 99%, 5 kHz FM, 770 MHz</i>	<i>17</i>
8.3.4	<i>Bandwidth Plot, 99%, C4FM, 770 MHz.....</i>	<i>18</i>
8.3.5	<i>Bandwidth Plot, 99%, LSM, 770 MHz.....</i>	<i>19</i>
8.3.6	<i>Bandwidth Plot, 99%, Phase 2, 770 MHz</i>	<i>20</i>
8.3.7	<i>Bandwidth Plot, 99%, 2.5 kHz FM, 860 MHz.....</i>	<i>21</i>
8.3.8	<i>Bandwidth Plot, 99%, 4 kHz FM, 860 MHz.....</i>	<i>22</i>
8.3.9	<i>Bandwidth Plot, 99%, 5 kHz FM, 860 MHz.....</i>	<i>23</i>
8.3.10	<i>Bandwidth Plot, 99%, C4FM, 860 MHz.....</i>	<i>24</i>
8.3.11	<i>Bandwidth Plot, 99%, LSM, 860 MHz.....</i>	<i>25</i>
8.3.12	<i>Bandwidth Plot, 99%, Phase 2, 860 MHz.....</i>	<i>26</i>
8.4	EMISSION LIMITATIONS, IN-BAND.....	27
8.4.1	<i>Emission Mask, 2.5 kHz FM, 770 MHz.....</i>	<i>28</i>
8.4.2	<i>Emission Mask, 4 kHz FM, 770 MHz.....</i>	<i>29</i>
8.4.3	<i>Emission Mask, 5 kHz FM, 770 MHz.....</i>	<i>30</i>



8.4.4	Emission Mask, C4FM, 770 MHz.....	31
8.4.5	Emission Mask, LSM, 770 MHz.....	32
8.4.6	Emission Mask, Phase 2, 770 MHz.....	33
8.4.7	Emission Mask, 2.5 kHz FM, 860 MHz.....	34
8.4.8	Emission Mask, 4 kHz FM, 860 MHz.....	35
8.4.9	Emission Mask, 5 kHz FM, 860 MHz.....	36
8.4.10	Emission Mask, C4FM, 860 MHz.....	37
8.4.11	Emission Mask, LSM, 860 MHz.....	38
8.4.12	Emission Mask, Phase 2, 860 MHz.....	39
8.5	EMISSION LIMITATIONS, OUT-OF-BAND.....	40
8.5.1	Conducted Emissions Below 1GHz, 770 MHz.....	41
8.5.2	Conducted Emissions Above 1GHz, 770 MHz.....	42
8.5.3	Conducted Emissions Below 1GHz, 860 MHz.....	43
8.5.4	Conducted Emissions Above 1GHz, 860 MHz.....	44
8.6	RADIATED EMISSIONS.....	45
8.6.1	Radiated Emissions, 770 MHz.....	46
8.6.2	Radiated Emissions, 860 MHz.....	47
8.7	MODULATION CHARACTERISTICS.....	48
8.8	FREQUENCY STABILITY.....	49
8.8.1	Frequency Stability Data.....	50
8.8.2	Frequency Stability Plot.....	51
8.9	TRANSIENT FREQUENCY BEHAVIOR.....	52
8.10	ADJACENT CHANNEL POWER LIMITS.....	53
9.	ANNEX-A - PHOTOGRAPHS OF THE EUT.....	54
10.	ANNEX-B – TEST SETUP PHOTOGRAPHS.....	54
11.	HISTORY OF TEST REPORT CHANGES.....	54



Timco Engineering, Inc., an IIA Company
849 NW State Road 45, Newberry, Florida 32669
(352) 472-5500 / testing@timcoengr.com

1. Applicant Information

Applicant: Spectra Engineering Pty. Ltd.
Address: 731 Marshall Road
Malaga, Western Australia, 6090 Australia



1.1 Part 90 Test Result Summary

The following test procedure and guidance were used for measuring FCC PART 90 (PRIVATE LAND MOBILE RADIO SERVICES) known as Licensed Land Mobile; ANSI C63.26-2015. Full test results are available in this report.

The Following is for Test item FCC ID: OKRMXDR7B

Applicable Clauses from Part 2		
FCC Clauses	Description of the requirements	Result: (Pass, Fail, N/A)
2.202	Bandwidth & Emission	Pass
2.1033 (c)(8)	Power at the Final Amplifier	Reported
2.1046 (a)	RF Output Power	Pass
2.1047	Modulation characteristics	n/a
2.1049	Occupied Bandwidth	Pass
2.1051	Spurious emissions at antenna terminals	Pass
2.1053	Field strength of spurious radiation	Pass
2.1055	Frequency stability	Pass

Applicable Clauses from Part 90		
FCC Clauses	Description of the requirements	Result: (Pass, Fail, N/A)
90.205 (r)	Transmitter Power	Pass
90.207 (n)	Emission designator	Reported
90.209 (b) (5) footnote 2	Bandwidth limitations	Pass
90.210 (n)	Emission masks, In-band	Pass
90.210 (n)	Emission masks, Out-of-band	Pass
90.213 (a) footnote 10	Frequency stability	Pass
90.214	Transient Frequency Behavior	n/a
90.221	Adjacent channel power limits	n/a

No additions to the test methods were needed. There were no deviations, or exclusions from the test methods. No test results are from external providers or from the customer. The test results relate only to the items tested. Timco does not offer opinions and interpretations, only a pass/fail statement.



Timco Engineering, Inc., an IIA Company
 849 NW State Road 45, Newberry, Florida 32669
 (352) 472-5500 / testing@timcoengr.com

2. Location of Testing

2.1 Test Laboratory

Timco Engineering Inc. is a subsidiary of Industrial Inspection & Analysis, Inc. ("IIA").

Testing was performed at Timco's permanent laboratory located at 849 NW State Road 45, Newberry, Florida 32669

FCC test firm # 578780

FCC Designation # US1070

FCC site registration is under A2LA certificate # 0955.01

ISED Canada test site registration # 2056A

EU Notified Body # 1177

For all designations see A2LA scope # 0955.01

2.1 Testing was performed, reviewed by

Dates of Testing: 6/25/2021 – 6/25/2021

Signature:

Sr. EMC Engineer
 EMC-003838-NE



Name & Title:

Tim Royer, EMC Engineer

Date of Signature

6/25/2021



3. Test Sample(s) (EUT/DUT)

The test sample was received: 6/25/2021

3.1 Description of the EUT

A description as well as unambiguous identification of the EUT(s) tested. Where more than one sample is required for technical reasons (such as the use of connected units for the purpose of conducted output power testing where the product units will have integral antennas), each specific test shall identify which unit was tested.

Identification	
FCC ID:	OKRMXDR7B
Brief Description	Base Station Transceiver
Type of Modular	N/A
Model(s) #	MXDR7B
Firmware version	n/a
Software version	n/a
Serial Number	n/a

Technical Characteristics	
Technology	Base Station Transceiver
Frequency Range	763-775MHz, 851-869MHz
RF O/P Power (Max.)	100W
Modulation	Analog, Digital
Bandwidth & Emission Class	8K10F1E, 8K10F1D, 9K80F7E, 11K0F3E, 14K0F3E, 16K0F3E
Duty Cycle	100%
Antenna Connector	N-Connector
Voltage Rating (AC or Batt.)	AC

Antenna Characteristics			
Antenna	Frequency Range	Mode / BW	Antenna Gain
1	n/a	n/a	0 dBi
2			



3.2 Configuration of EUT

Test Modes				
Mode (#)	Mode (Type)	Test Frequencies	BW (nominal)	Emission Designator
1	2.5k FM	770 MHz 860 MHz	6.19	F3E
2	4k FM		9.83	F3E, F7E
3	5k FM		10.70	F3E, F7E
4	C4FM		8.05	F1D
5	LSM		8.32	F1D
6	Phase 2		9.64	F1D

Operating conditions during Testing:

The device was operated without the provided antenna(s).

No other modifications of the device under test (including firmware, specific software settings, and input/output signal levels to the EUT) were made.

Peripherals used during Testing:

A laptop provided by the manufacturer was used to program the EUT.

3.3 Test Setup of EUT

Equipment, antenna, and cable arrangement. The setup of the equipment and cable or wire placement on the test site that produces the highest radiated and the highest ac power line conducted emissions shall be shown clearly and described. Information on the orientation of portable equipment during testing shall be included. Drawings or photographs may be used for this purpose.

Test Setups are included in the test report.



4. Test methods & Applicable Regulatory Limits

4.1 Test methods/Standards/Guidance:

Test procedures and guidance for measuring Licensed Part 90 Licensed device:

- 1) ANSI C63.26-2015

4.2 Applied Limits and Regulatory Limits:

- 1) FCC CFR 47 Part 90

5. Measurement Uncertainty

Parameter	Uncertainty (dB)
Conducted Emissions	± 3.14 dB
Radiated Emissions (9kHz – 30 MHz)	± 3.08 dB
Radiated Emissions (30 – 200 MHz)	± 2.16 dB
Radiated Emissions (200 – 1000 MHz)	± 2.15 dB
Radiated Emissions (1 GHz – 18 GHz)	± 2.14 dB
Radiated Emissions (18 GHz – 40 GHz)	± 2.31 dB
Note: The uncertainties provided in this table represent an expanded uncertainty expressed at approximately the 95% confidence level using a coverage factor of K=2.	

6. Environmental Conditions

6.1 Temperature & Humidity

Measurements performed at the test site did not exceed the following:

Temperature	23 C +/- 5%
Humidity	55% +/- 5%
Note: Specific environmental conditions that are applicable to a specific test are available in the test result section.	



7. List of Test Equipment and Test Facility

The test equipment used identified by type, manufacturer, serial number, or other identification and the date on which the next calibration or service check is due.

Description of the firmware or software used to operate EUT for testing purposes.

A complete list of all test equipment used shall be included with the test report. The manufacturer's model and serial numbers, and date of last calibration, and calibration interval shall be included. Measurement cable loss, measuring instrument bandwidth and detector function, video bandwidth, if appropriate, and antenna factors shall also be included where applicable.

7.1 List of Test Equipment

Type	Device	Manufacturer	Model	SN #	Current Cal	Cal Due
Audio Analyzer	Audio Analyzer	HP	8903B	3011A13084	2/20/18	2/19/2021
Function Generator	Function Generator	Standford	DS340	25200	2/21/18	2/20/2021
Modulation Analyzer	Modulation Analyzer	HP	8901A	3050A05856	4/23/20	4/23/2023
Oscilloscope	Oscilloscope	LeCroy	LT364	00414	3/28/19	3/27/2022
Signal Generator	Signal Generator HP 8648C	HP	8648C	3847A04696	9/11/20	9/11/2023
Signal Generator	Signal Generator R&S SMU-200A	Rohde & Schwarz	SMU200A	103195	4/23/18	4/22/2021
Multimeter	Digital Multimeter	Fluke	77	35053830	9/9/20	9/9/2023
Frequency Counter	Frequency Counter	HP	5385A	2730A03025	9/9/20	9/9/2023
Antenna	Active Loop	ETS-Lindgren	6502	00062529	10/20/20	10/20/2023
Antenna	Biconical 1057	Eaton	94455-1	1057	10/16/20	10/16/2023
Antenna, NSA	Log-Periodic 1243	Eaton	96005	1243	4/20/18	4/19/2021
Antenna	Double-Ridged Horn/ETS Horn 1	ETS-Lindgren	3117	00035923	2/25/20	2/24/2023
CHAMBER	CHAMBER	Panashield	3M	N/A	3/12/19	3/11/2021
Pre-amp	Pre-amp	RF-LAMBDA	RLNA00M45GA	NA	2/27/19	2/26/2022
Receiver	EMI Test Receiver R&S ESU 40	Rohde & Schwarz	ESU 40	100320	8/28/18	8/27/2021
Frequency Counter	Frequency Counter Small	HP	5385A	3242A07460	9/9/20	9/9/2023
Thermometer	Type K J Thermometer	Martel	303	080504494	1/6/18	1/5/2021
Receiver	Service Monitor 3920	Aeroflex	3920	299001542	1/10/18	1/9/2021

Software	Author	Version	Validation Or
ESU Firmware	Rohde & Schwarz	4.43 SP3; BIOS v5.1-24-3	2018
RSCCommander	Rohde & Schwarz	1.6.4	2014
ScopeExplorer	LeCroy	v2.25.0.0	2009
Field Strength	Timco	v4.10.7.0	2016



Timco Engineering, Inc., an IIA Company
849 NW State Road 45, Newberry, Florida 32669
(352) 472-5500 / testing@timcoengr.com

8. Test Results

The results of the test are usually indicated in the form of tables, spectrum analyzer plots, charts, sample calculations, as appropriate for each test procedure.

A description and/or a block diagram of the test setup is usually provided.

The measurement results, along with the appropriate limits for comparison, may be presented in tabular or graphical form. In addition, any variation in the measurement environment may be reported if applicable (e.g., a significant change of temperature that could affect the cable loss and amplifier response).

Unless noted otherwise in the referenced standard, the measurements of **ac power-line conducted emissions and conducted power output** will be reported in units of dB μ V. Unless noted otherwise in the referenced standard, the measurements of **radiated emissions** will be reported in units of decibels, referenced to one microvolt per meter (dB μ V/m) for electric fields, or to one ampere per meter (dBA/m) for magnetic fields, at the distance specified in the appropriate standards or requirements. The measurements of antenna-conducted power for receivers may be reported in units of dB μ V if the impedance of the measuring instrument is also reported. Otherwise, antenna-conducted power will be reported in units of decibels referenced to one milliwatt (dBm). All formulas for data conversions and conversion factors, if used, will be included in this measurement report.



8.1 Power at the Final Amplifier

Limits from FCC Part 2.1033 (c)(8). No method of measurement is specified.

Test Results		
EUT Operating Voltage (V)	EUT Current (A)	Power at the Final Amplifier (W)
120	20	2400

8.2 RF Output Power

Limits from FCC Parts 2.1046(a), and 90.205 (r); and test procedure from ANSI C63.26-2015.

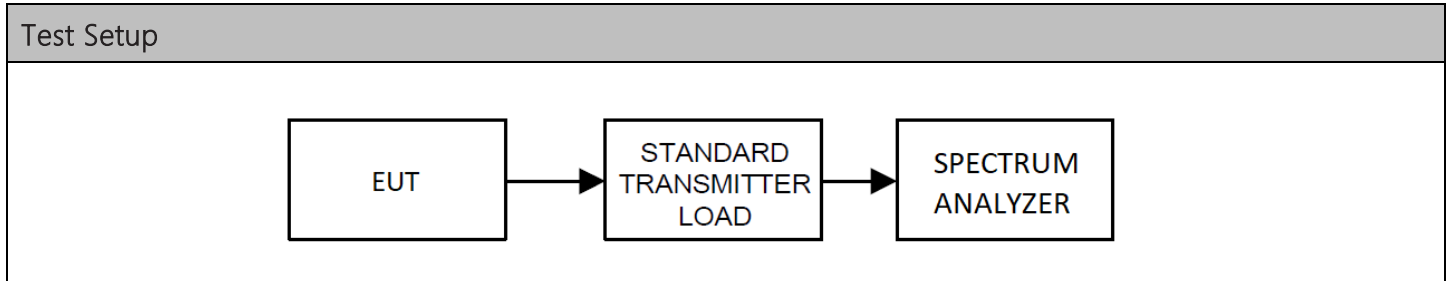

Test Results, Mode 1		
Tuned Frequency (MHz)	Power Output (dBm)	Power Output (W)
770	49.01	79.61
860	49.00	79.43



8.3 Bandwidth & Emission

Limits from FCC Parts 2.1049, and 90.207 & 90.209, and test procedure from ANSI C63.26-2015.

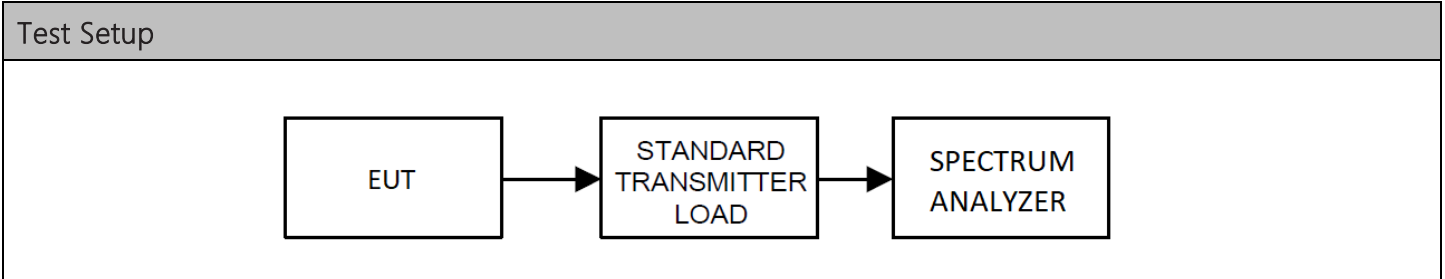

Test Results, Authorized Bandwidth		
Rule Part	Operating Range	Authorized Bandwidth
Part 90	763-778MHz, 851-869MHz	11.25 kHz

Test Results, Occupied Bandwidth				
Tuned Frequency (MHz)	Mode	Emission Designator	Occupied Bandwidth (kHz)	Bandwidth Type
770	1	F3E	6.19	99%
	2	F3E, F7E	9.83	99%
	3	F3E, F7E	10.70	99%
	4	F1D	8.01	99%
	5	F1D	8.32	99%
	6	F1D	9.64	99%
860	1	F3E	6.18	99%
	2	F3E, F7E	9.82	99%
	3	F3E, F7E	10.69	99%
	4	F1D	8.05	99%
	5	F1D	8.21	99%
	6	F1D	9.64	99%

Occupied Bandwidth, Spectrum Plots

8.3.1 Bandwidth Plot, 99%, 2.5 kHz FM, 770 MHz

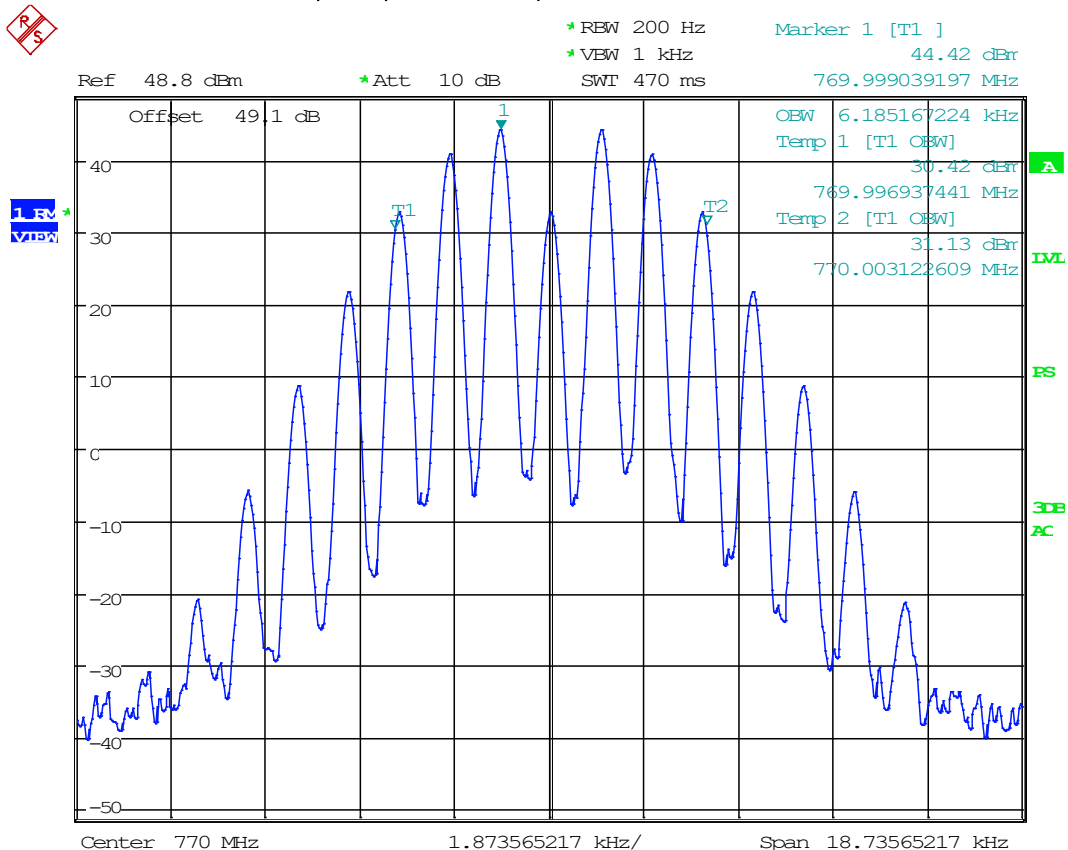

Date: 10.FEB.2003 03:18:22

8.3.2 Bandwidth Plot, 99%, 4 kHz FM, 770 MHz

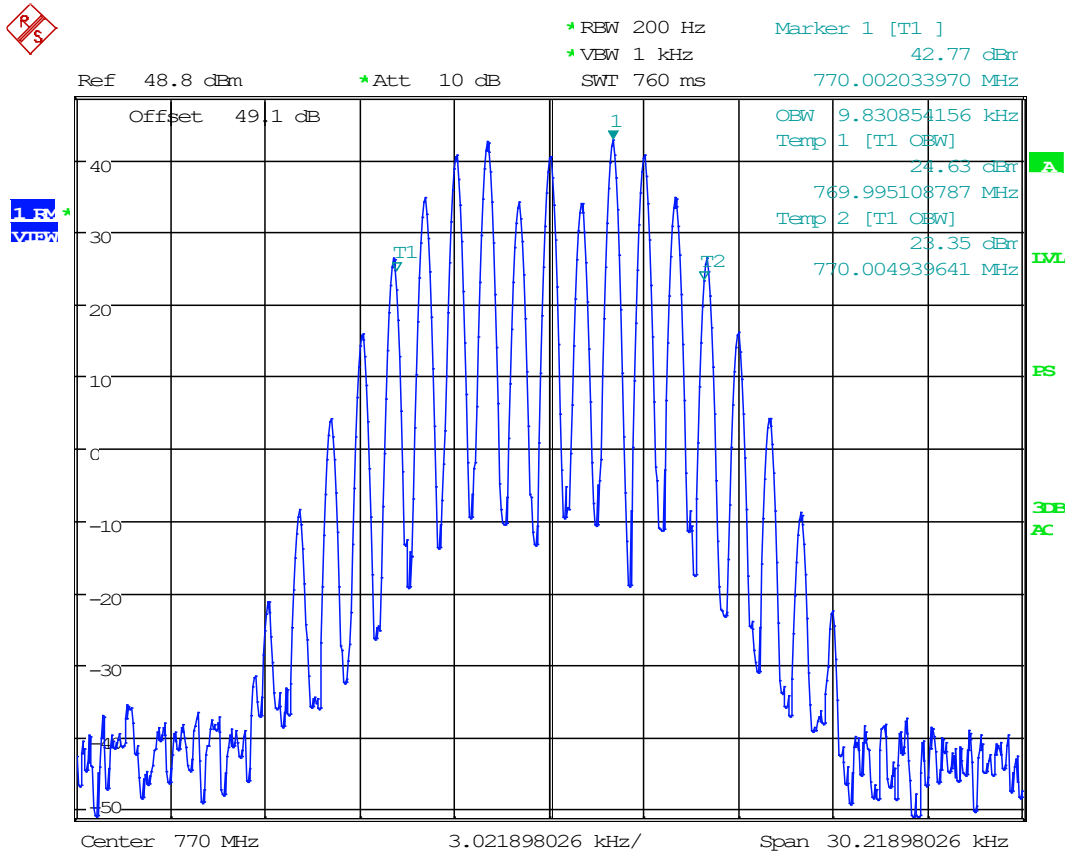

Date: 10.FEB.2003 03:20:42

8.3.3 Bandwidth Plot, 99%, 5 kHz FM, 770 MHz

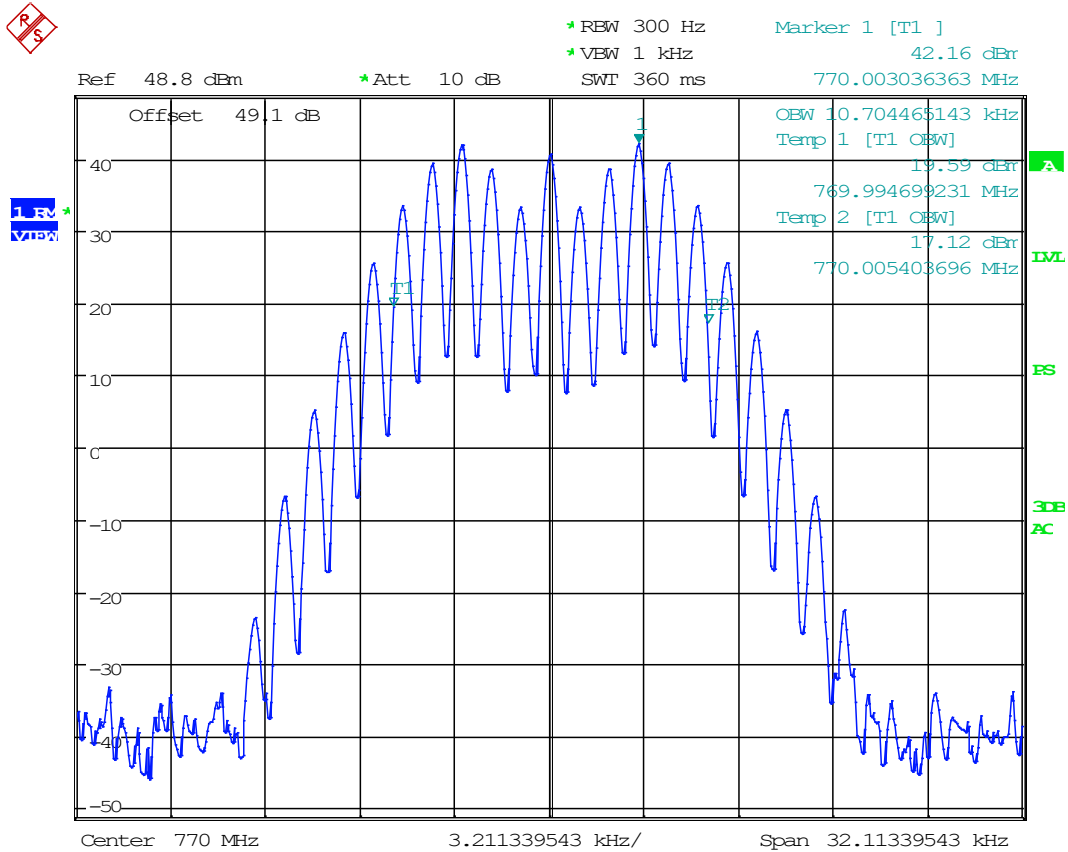

Date: 10.FEB.2003 03:21:48

8.3.4 Bandwidth Plot, 99%, C4FM, 770 MHz

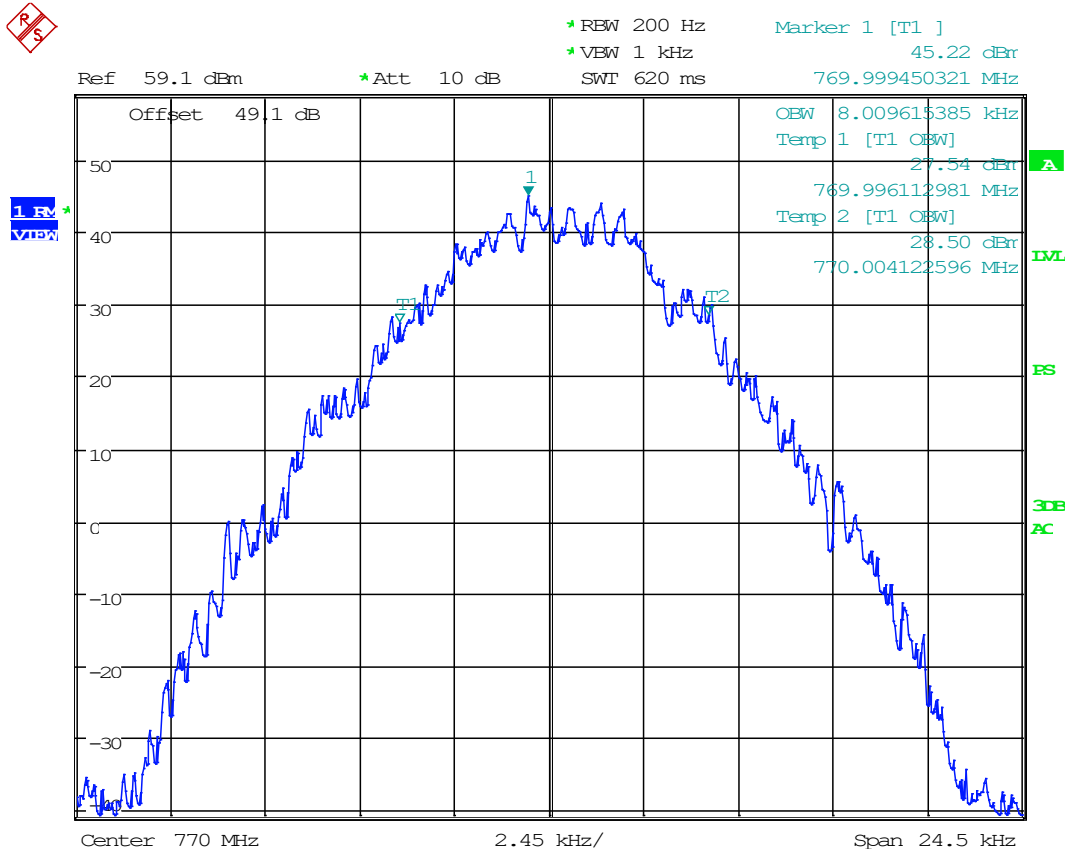

Date: 10.FEB.2003 03:27:51

8.3.5 Bandwidth Plot, 99%, LSM, 770 MHz

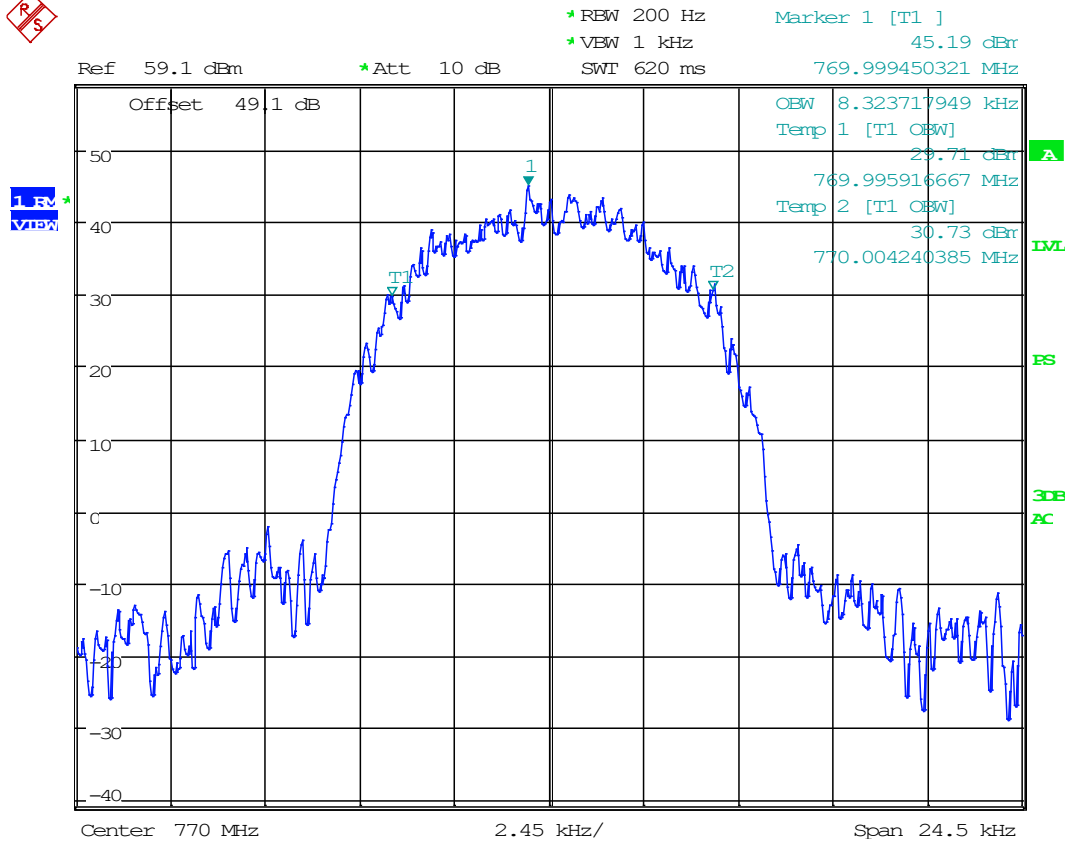

Date: 10.FEB.2003 03:31:09

8.3.6 Bandwidth Plot, 99%, Phase 2, 770 MHz

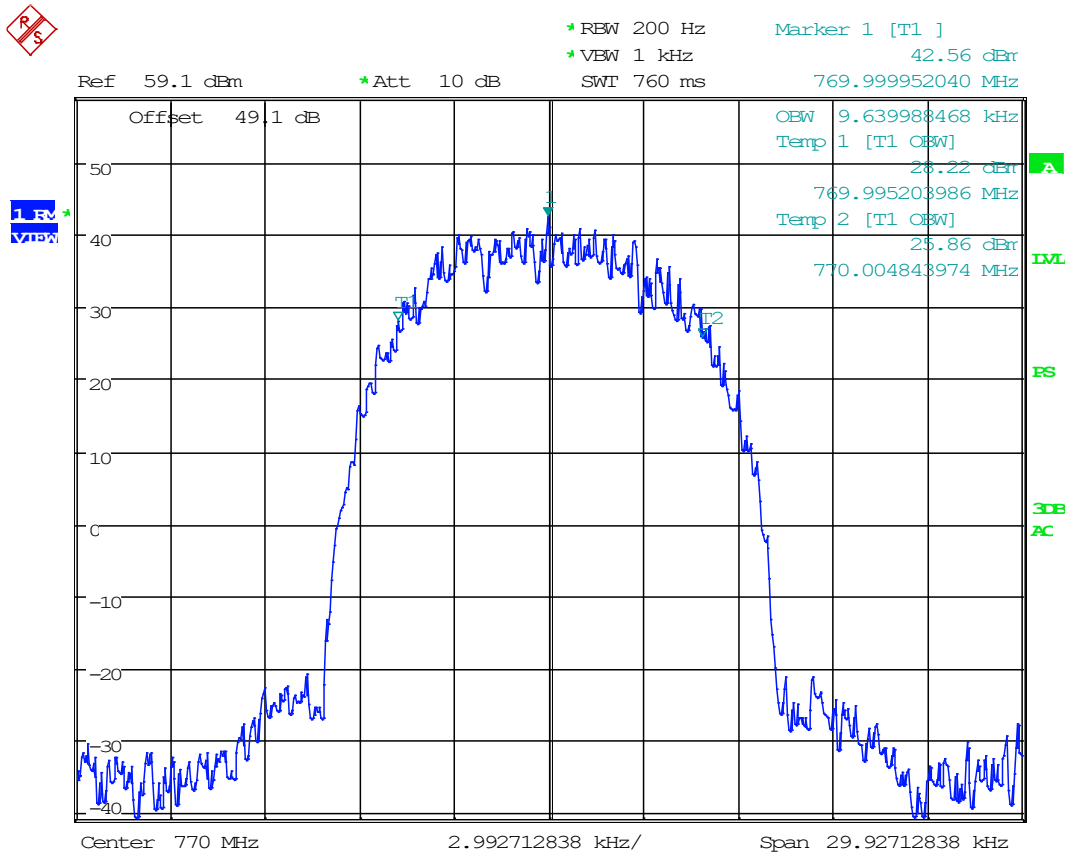

Date: 10.FEB.2003 03:33:27

8.3.7 Bandwidth Plot, 99%, 2.5 kHz FM, 860 MHz

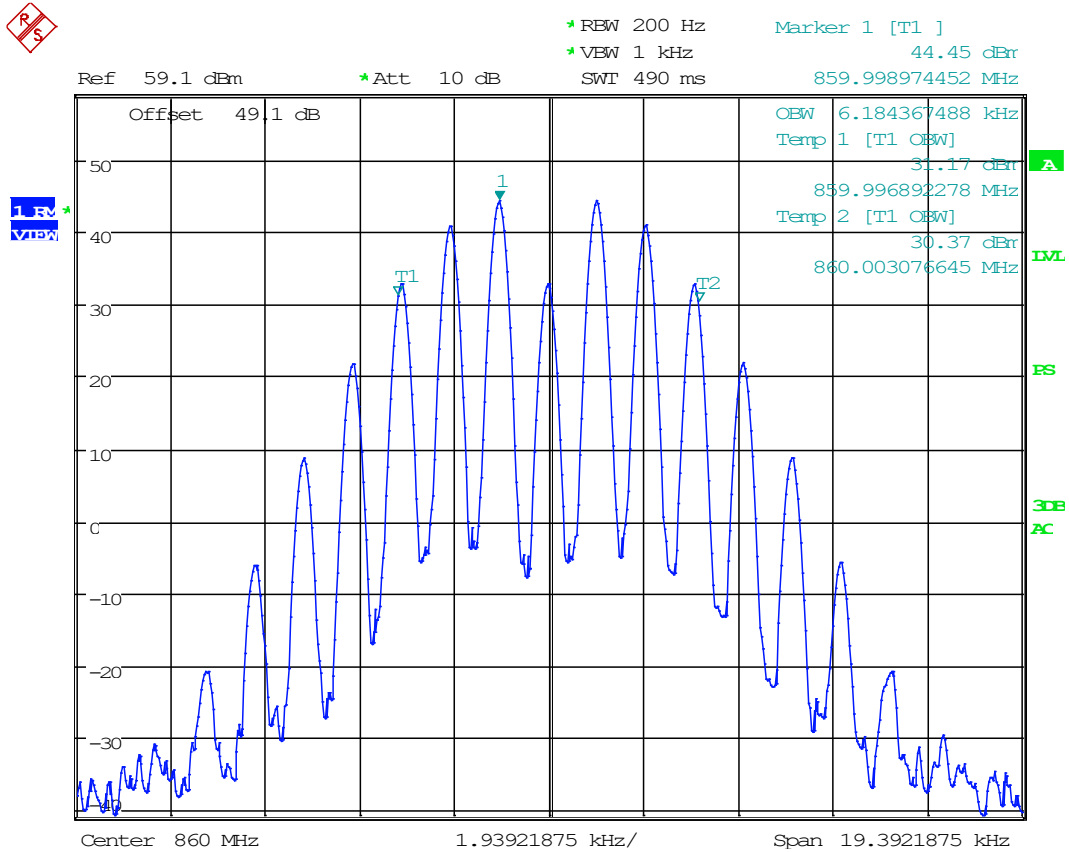

Date: 10.FEB.2003 01:46:17

8.3.8 Bandwidth Plot, 99%, 4 kHz FM, 860 MHz

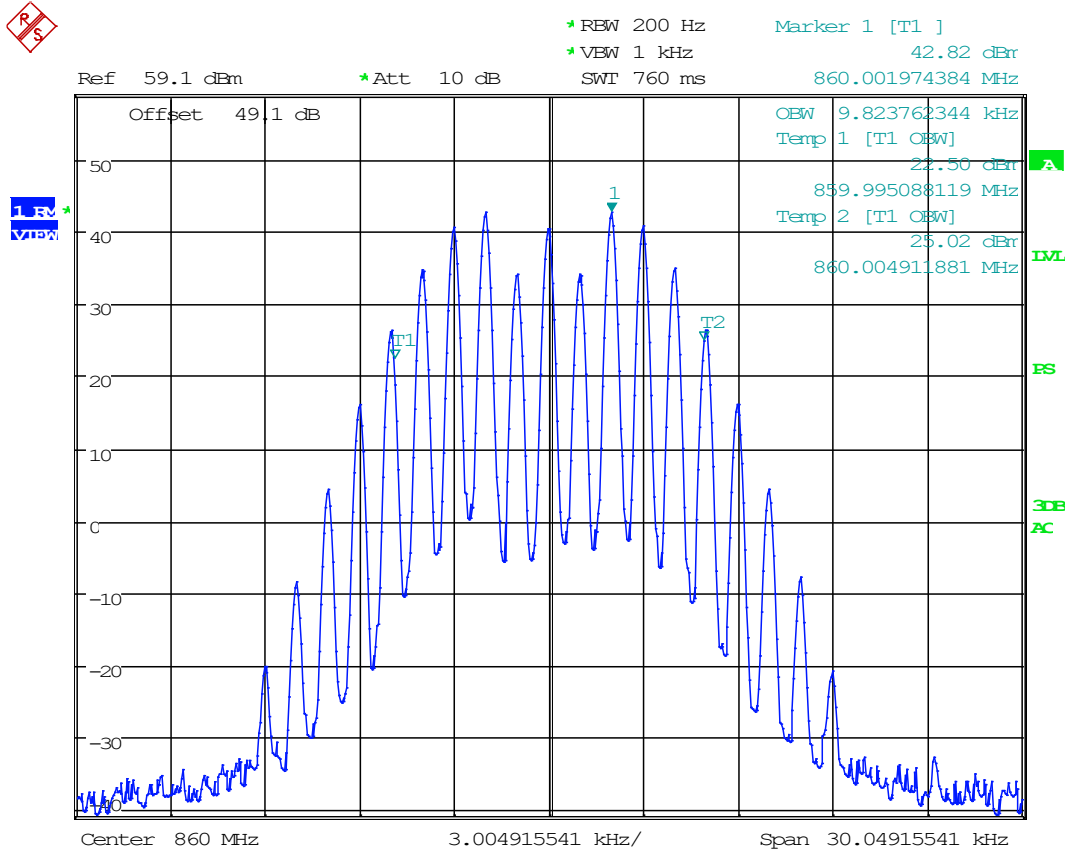

Date: 10.FEB.2003 01:50:31

8.3.9 Bandwidth Plot, 99%, 5 kHz FM, 860 MHz

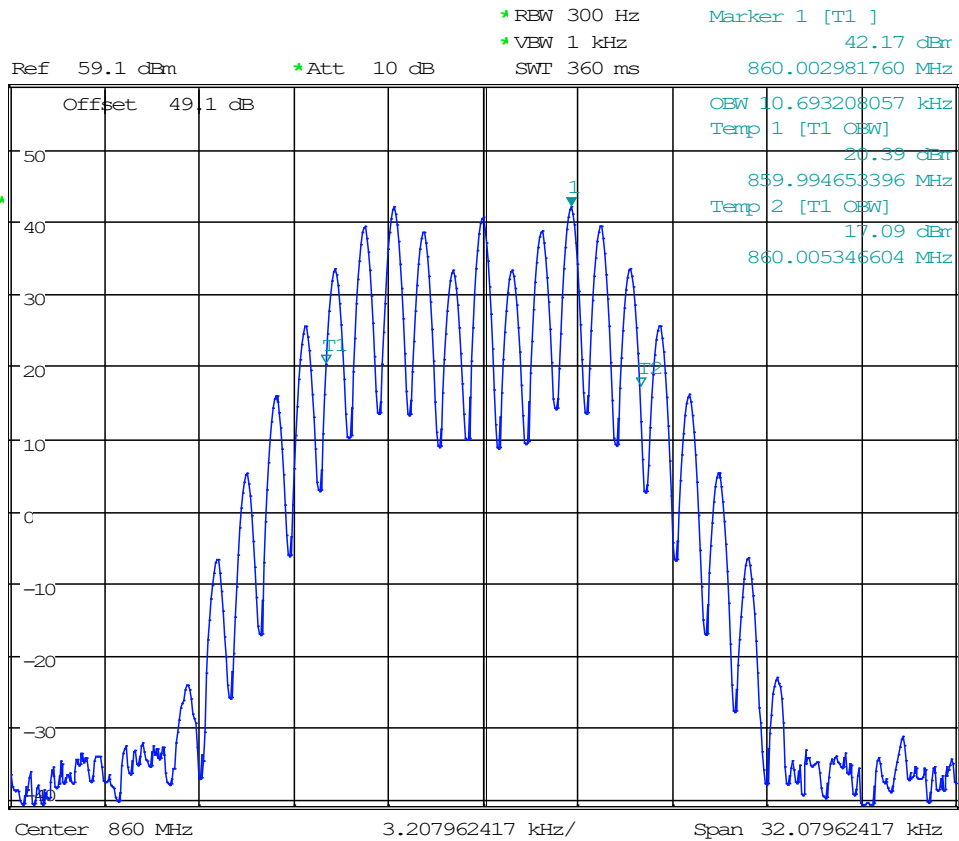

Date: 10.FEB.2003 01:54:45



8.3.10 Bandwidth Plot, 99%, C4FM, 860 MHz

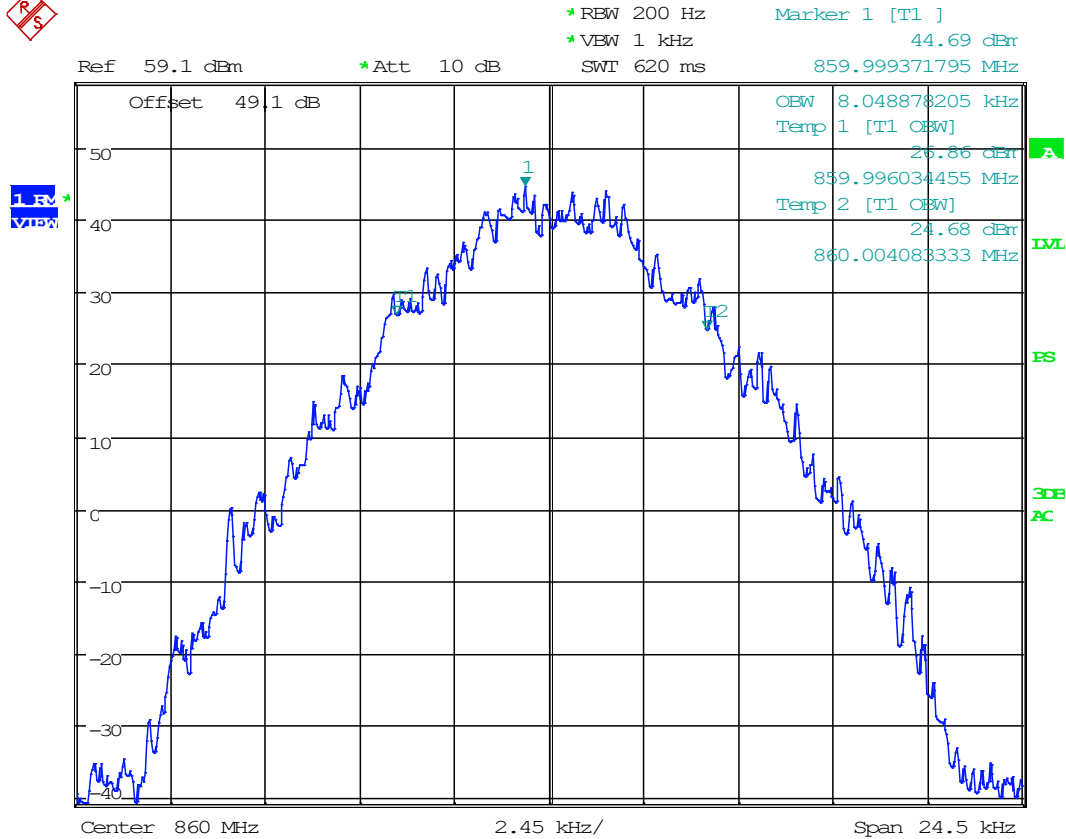

Date: 10.FEB.2003 03:28:57



8.3.11 Bandwidth Plot, 99%, LSM, 860 MHz

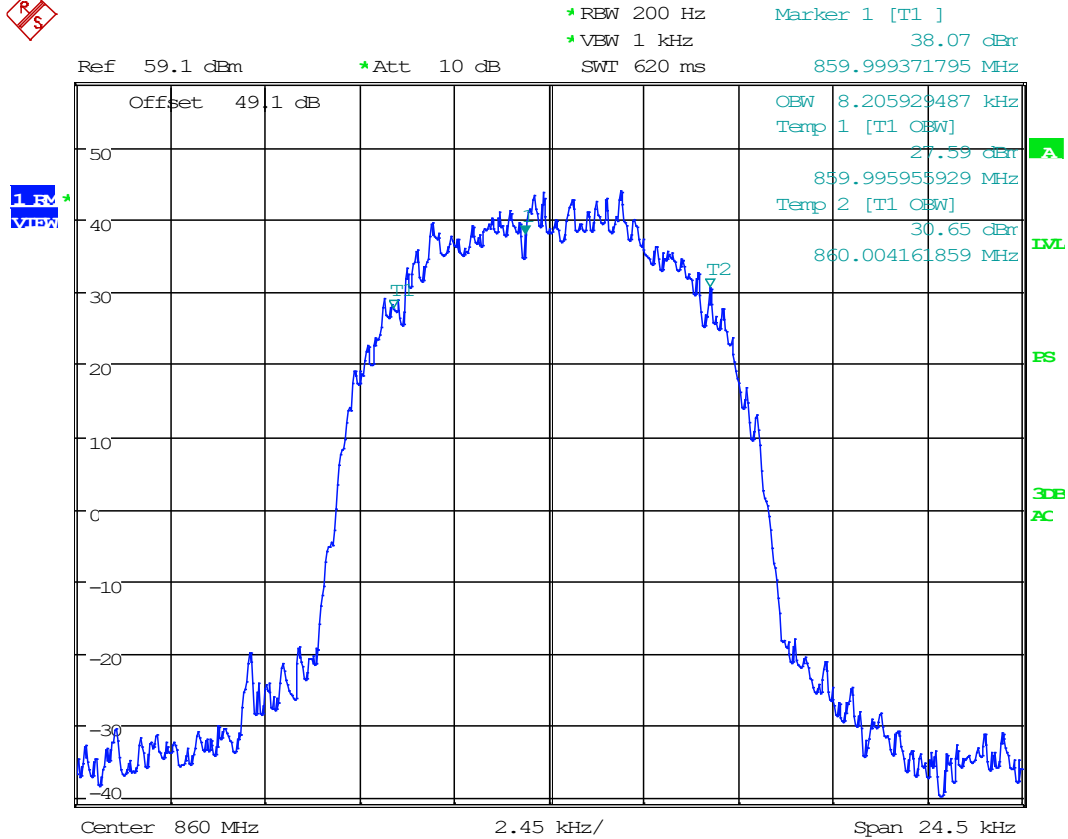

Date: 10.FEB.2003 03:30:02



8.3.12 Bandwidth Plot, 99%, Phase 2, 860 MHz

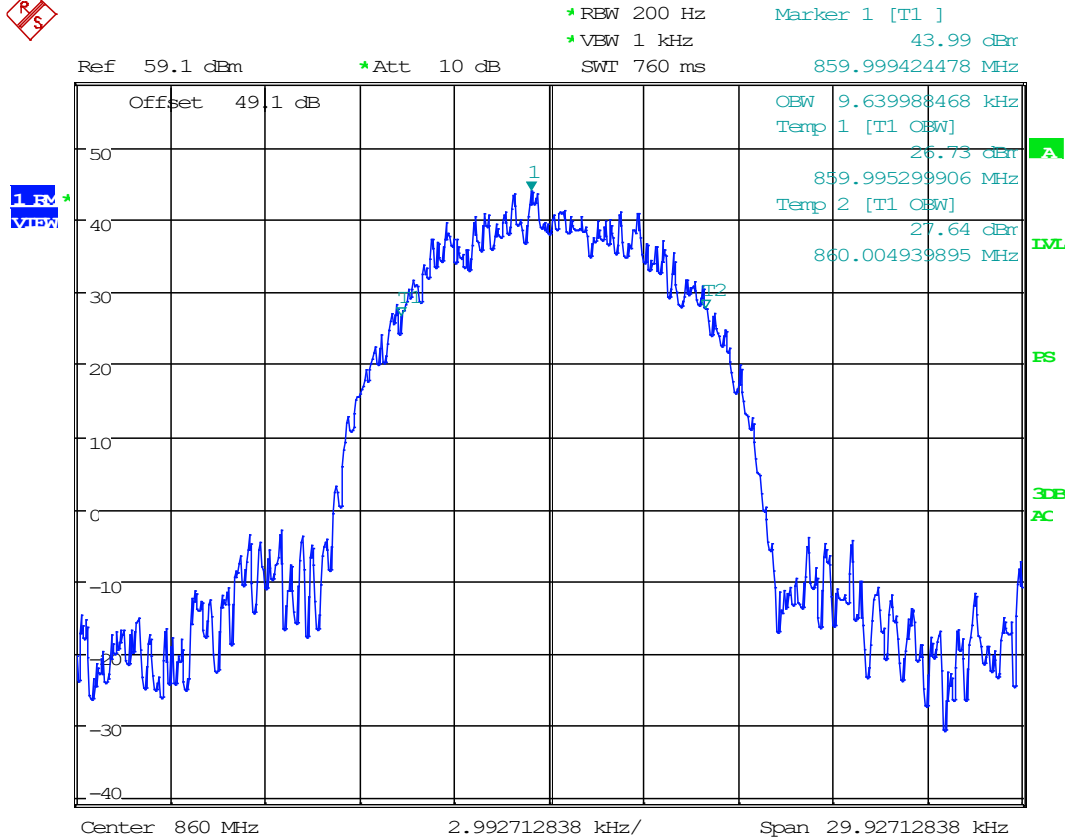

Date: 10.FEB.2003 03:34:15

8.4 Emission Limitations, In-Band

Limits from FCC Part 90.210; and test procedure from ANSI C63.26-2015.

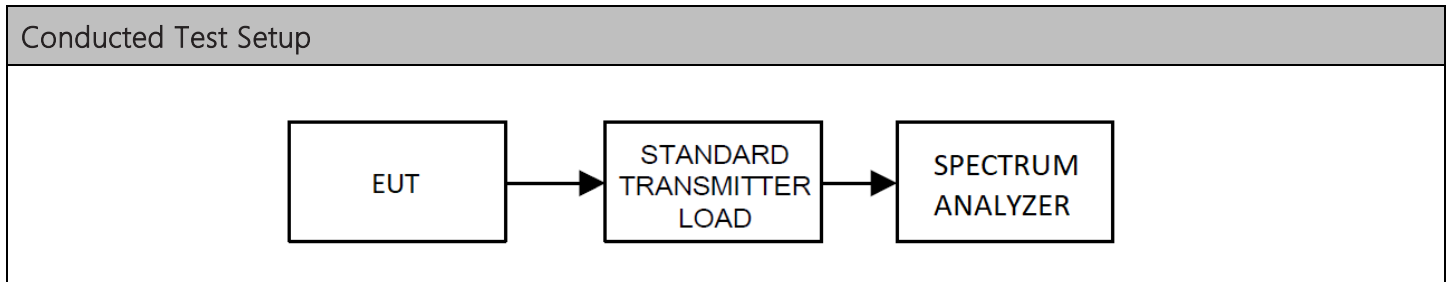



Conducted Emissions Mask, Spectrum Plots

8.4.1 Emission Mask, 2.5 kHz FM, 770 MHz

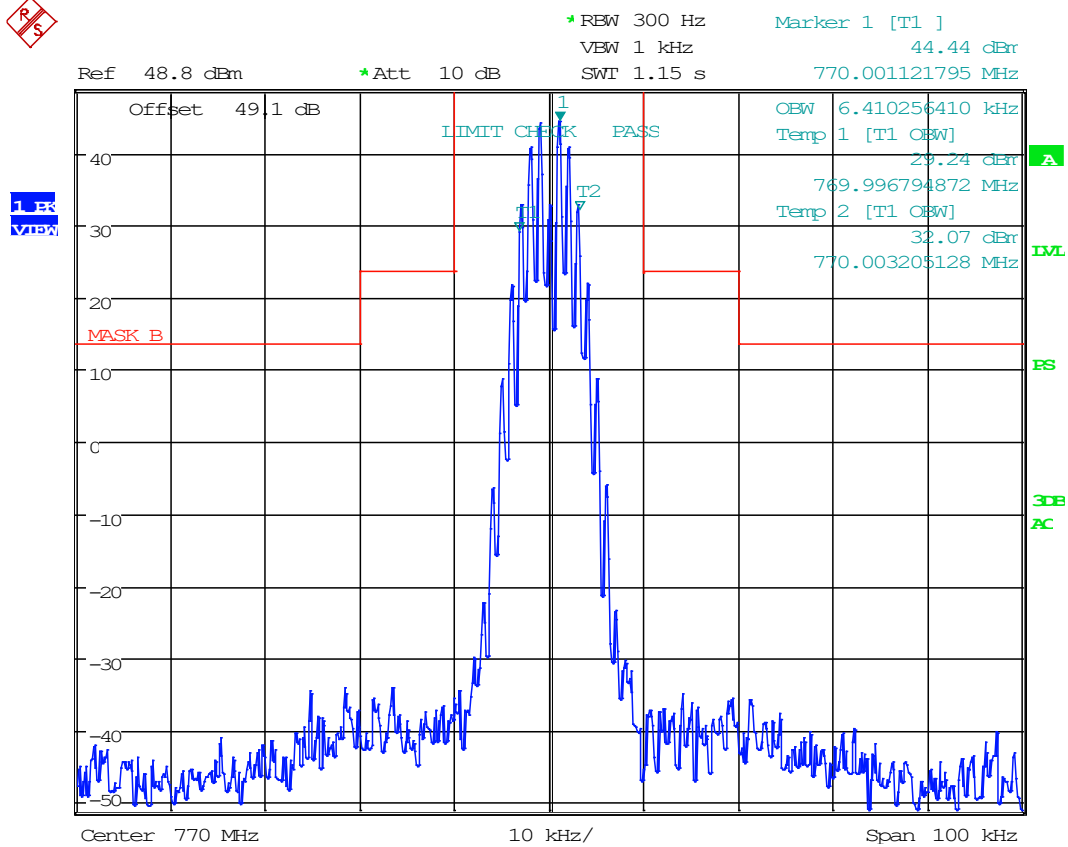

Date: 10.FEB.2003 03:16:12

8.4.2 Emission Mask, 4 kHz FM, 770 MHz

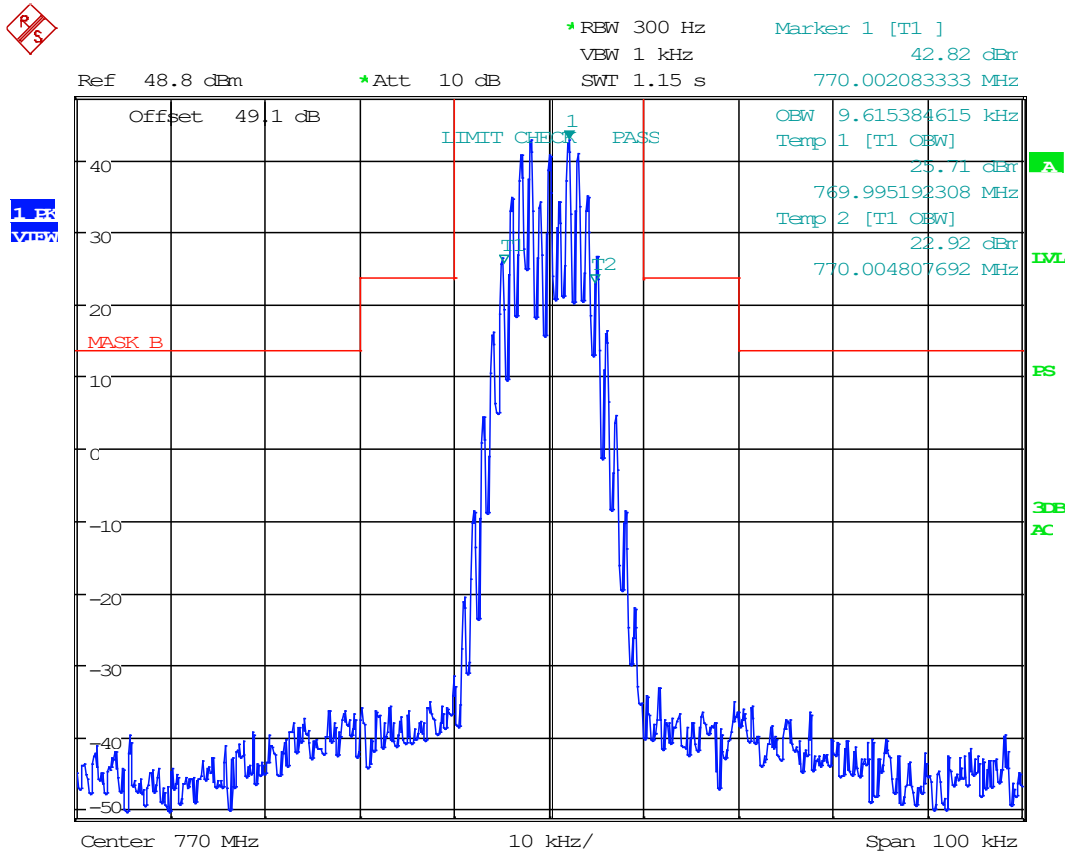

Date: 10.FEB.2003 03:15:35

8.4.3 Emission Mask, 5 kHz FM, 770 MHz

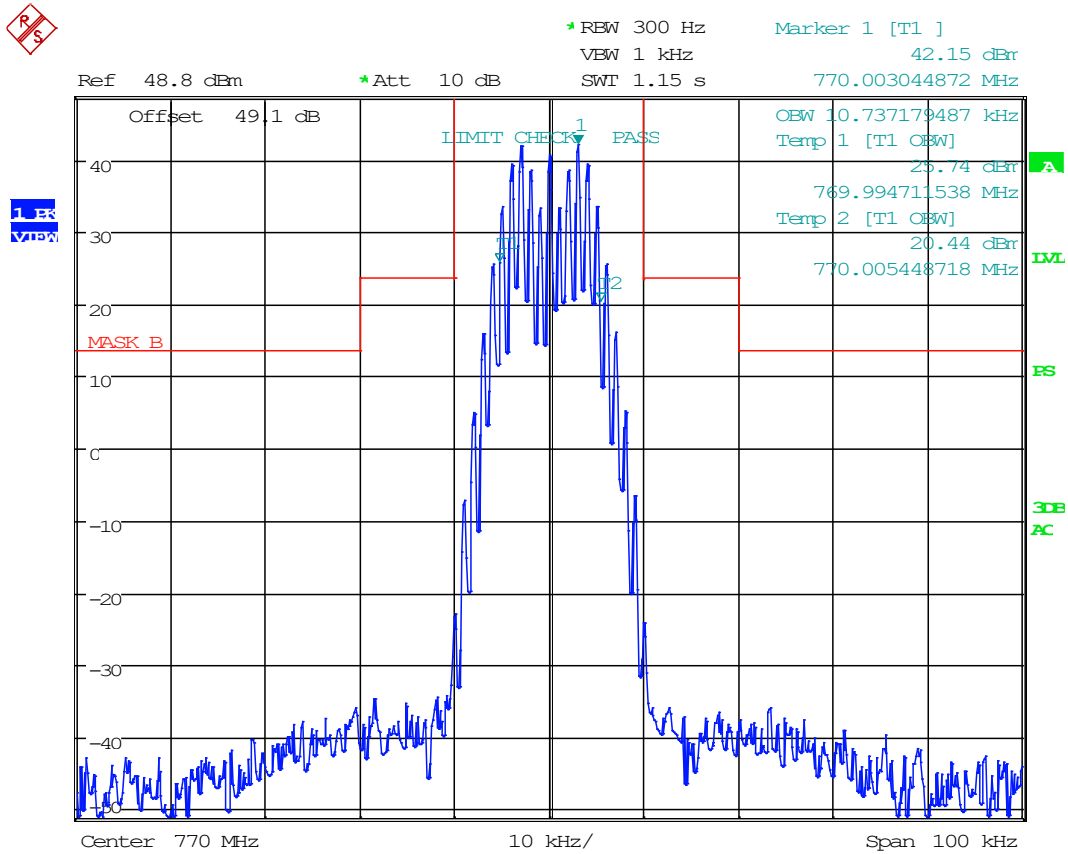

Date: 10.FEB.2003 03:12:43

8.4.4 Emission Mask, C4FM, 770 MHz

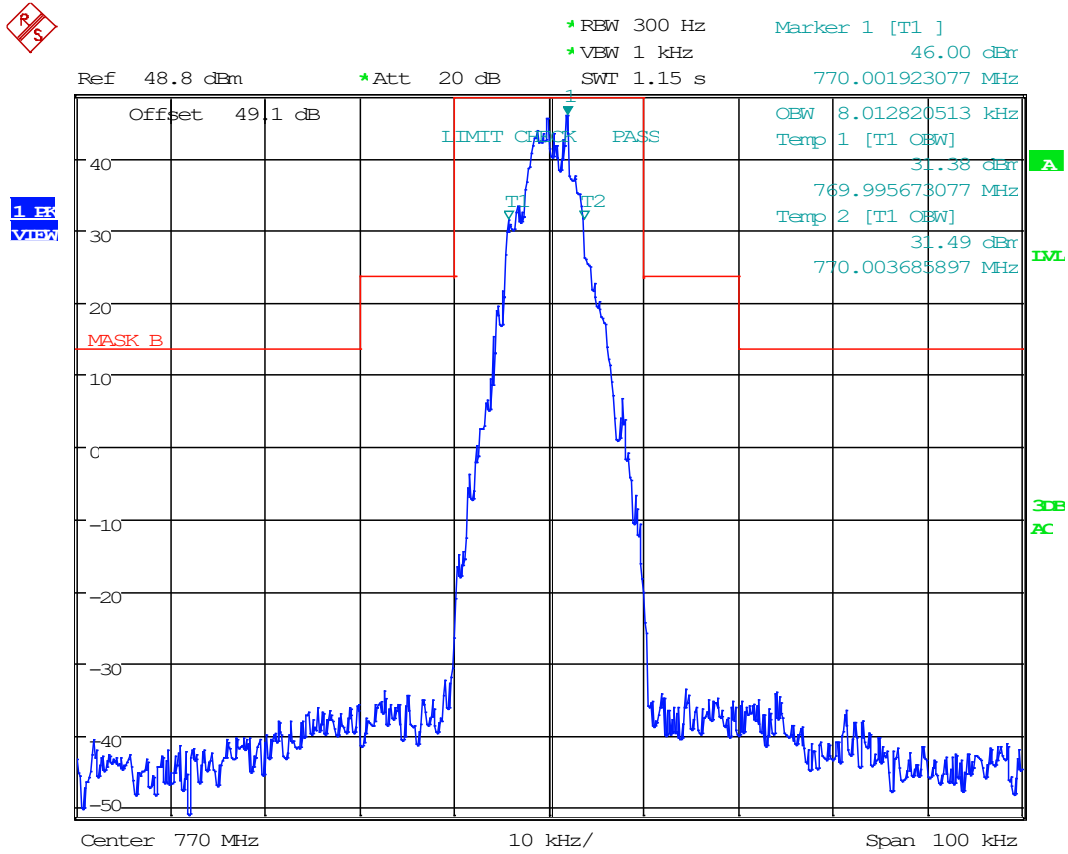

Date: 10.FEB.2003 03:47:44

8.4.5 Emission Mask, LSM, 770 MHz

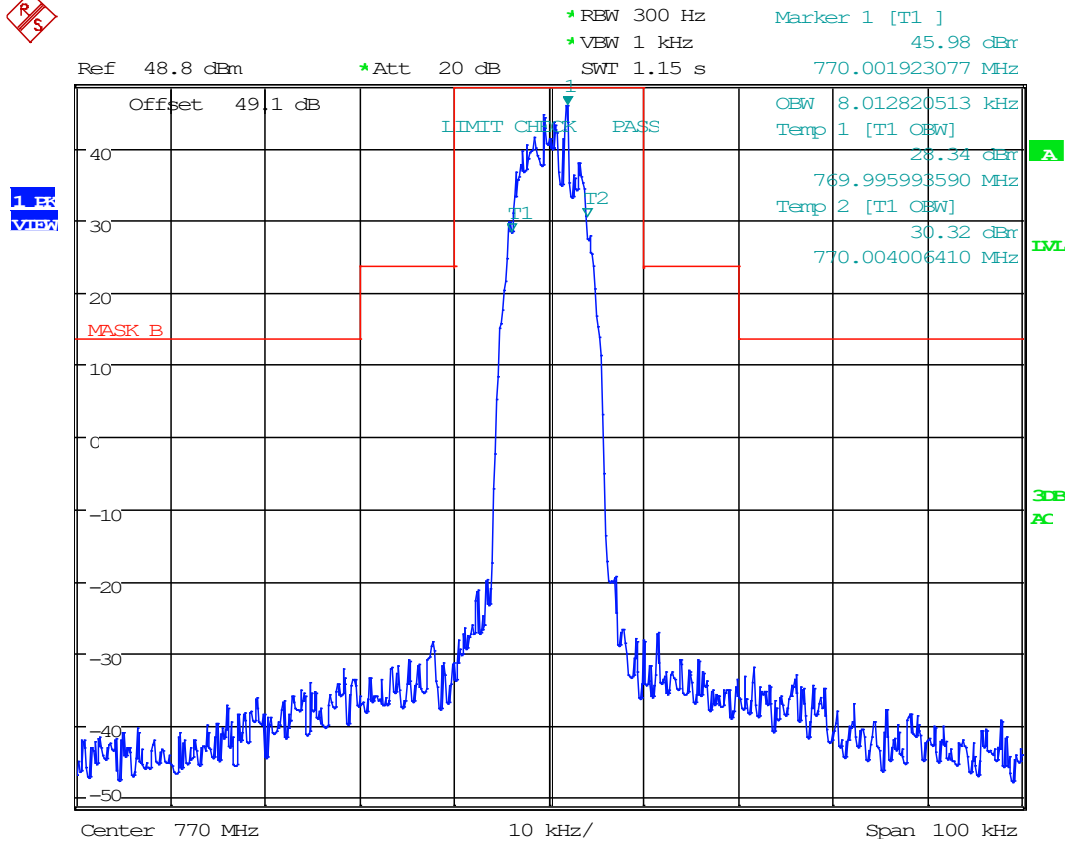

Date: 10.FEB.2003 03:48:51

8.4.6 Emission Mask, Phase 2, 770 MHz

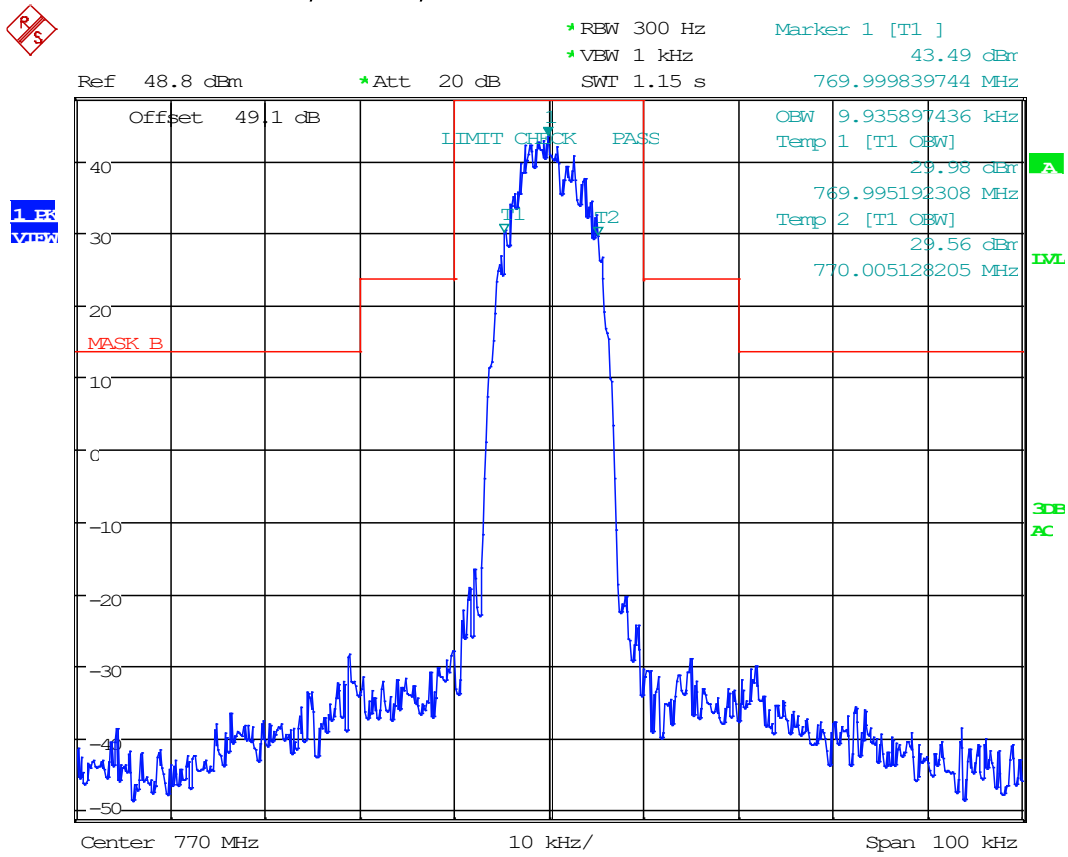

Date: 10.FEB.2003 03:51:54

8.4.7 Emission Mask, 2.5 kHz FM, 860 MHz

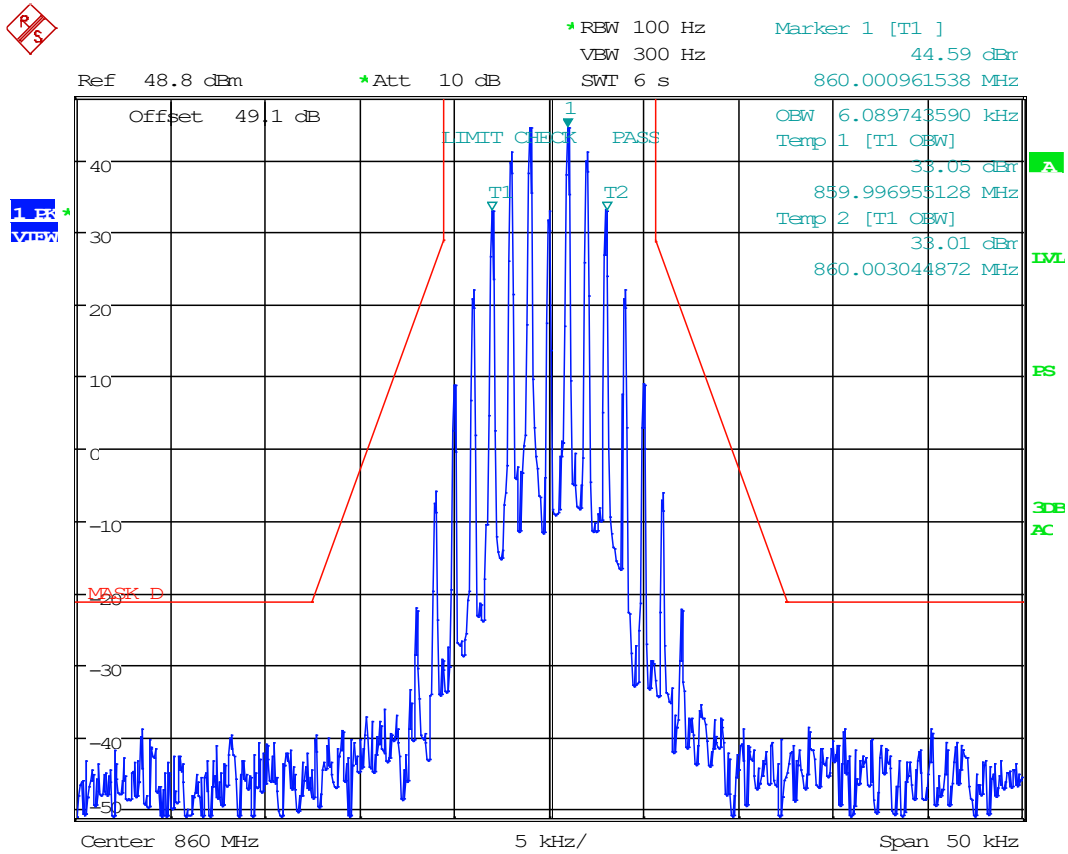

Date: 10.FEB.2003 02:09:31

8.4.8 Emission Mask, 4 kHz FM, 860 MHz

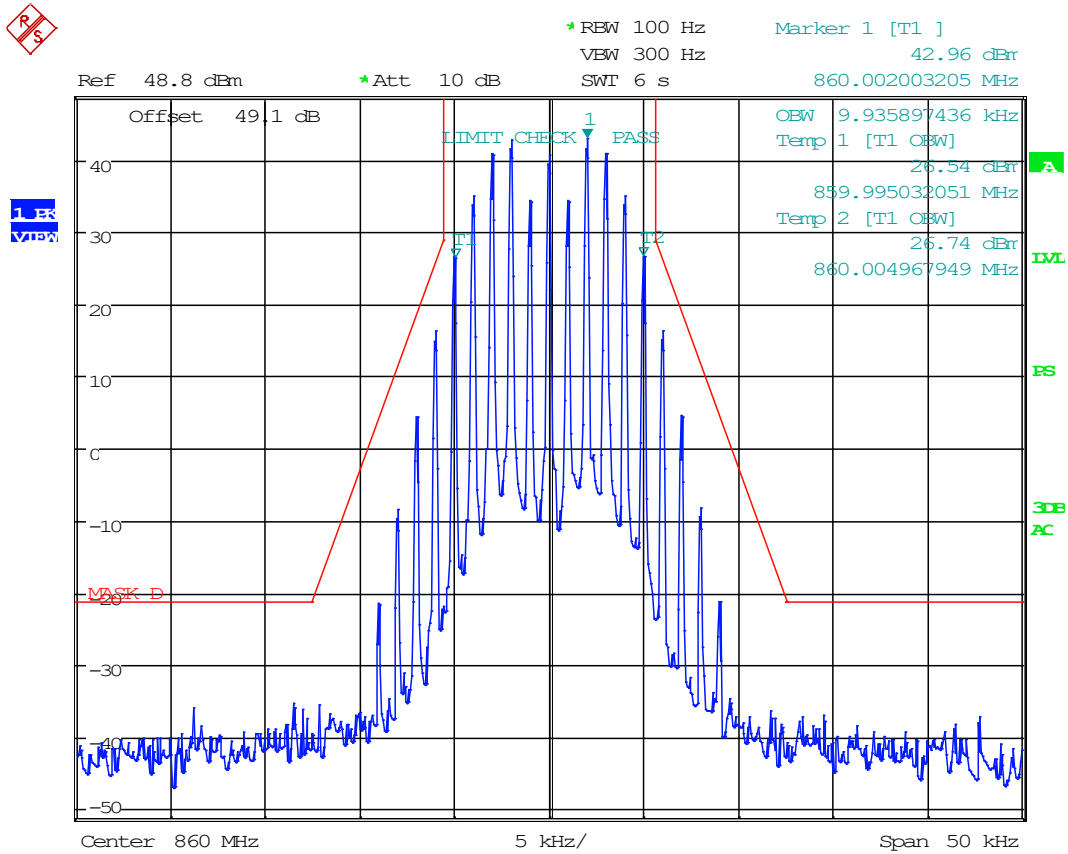

Date: 10.FEB.2003 02:08:36

8.4.9 Emission Mask, 5 kHz FM, 860 MHz

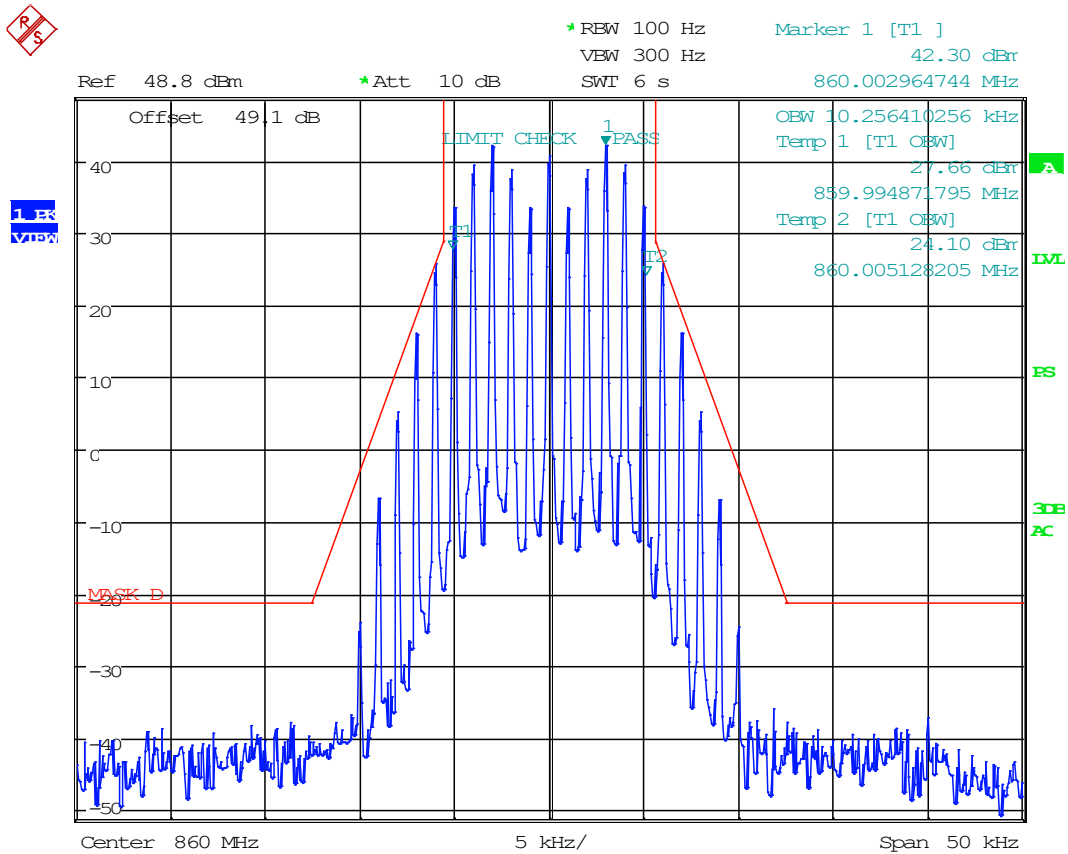

Date: 10.FEB.2003 02:06:48

8.4.11 Emission Mask, LSM, 860 MHz

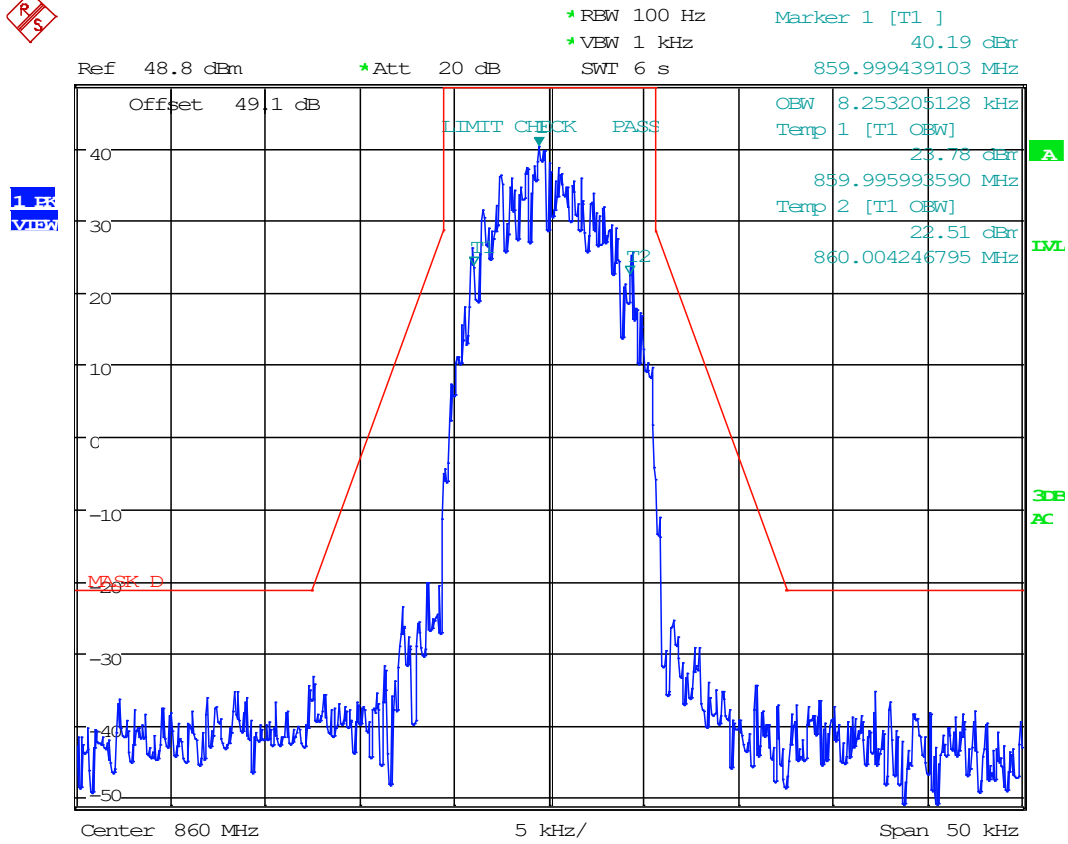

Date: 10.FEB.2003 03:41:39

8.4.12 Emission Mask, Phase 2, 860 MHz

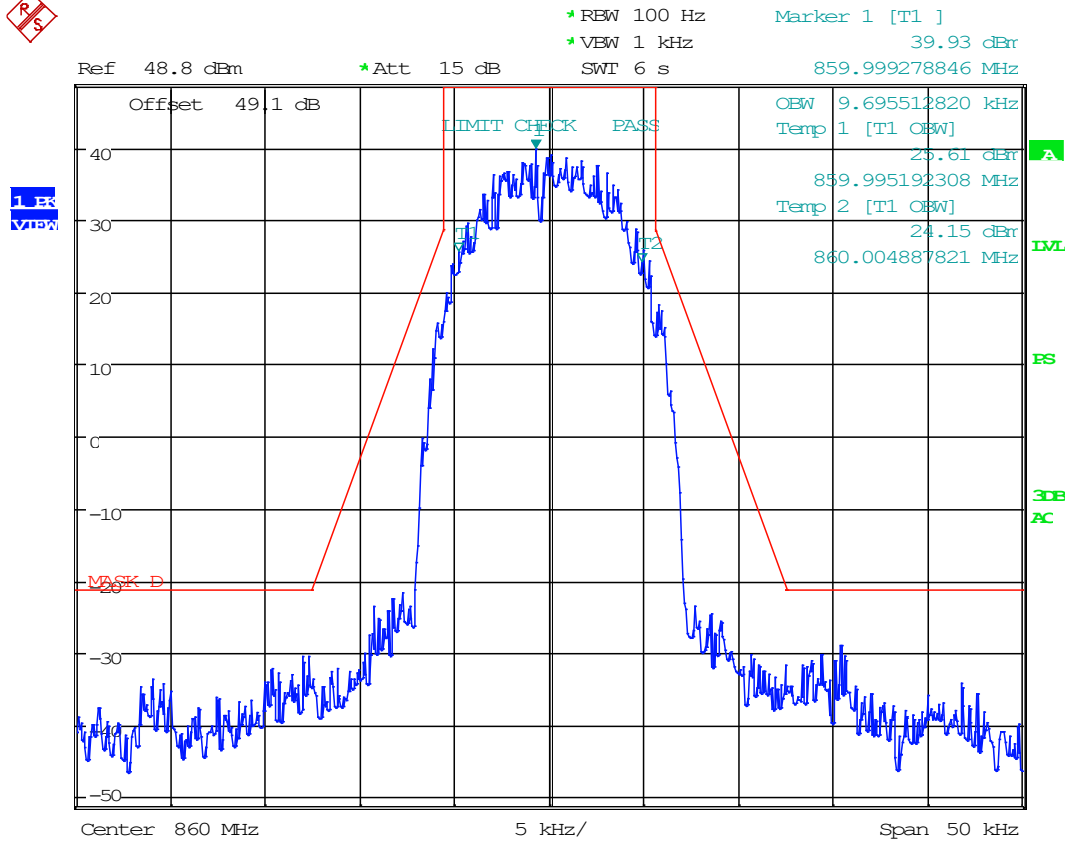

Date: 10.FEB.2003 03:39:27

8.5 Emission Limitations, Out-of-Band

Limits from FCC Parts 2.1051, and 90.210; and test procedure from ANSI C63.26-2015.

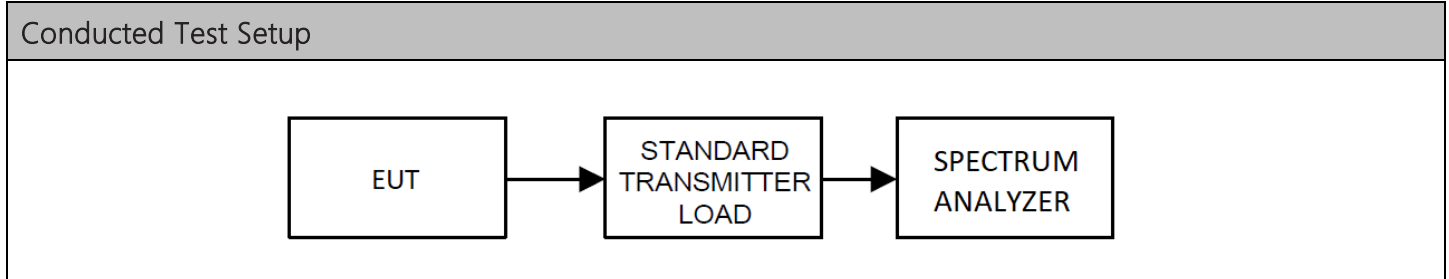



Conducted Emissions Spectrum Plots

8.5.1 Conducted Emissions Below 1GHz, 770 MHz

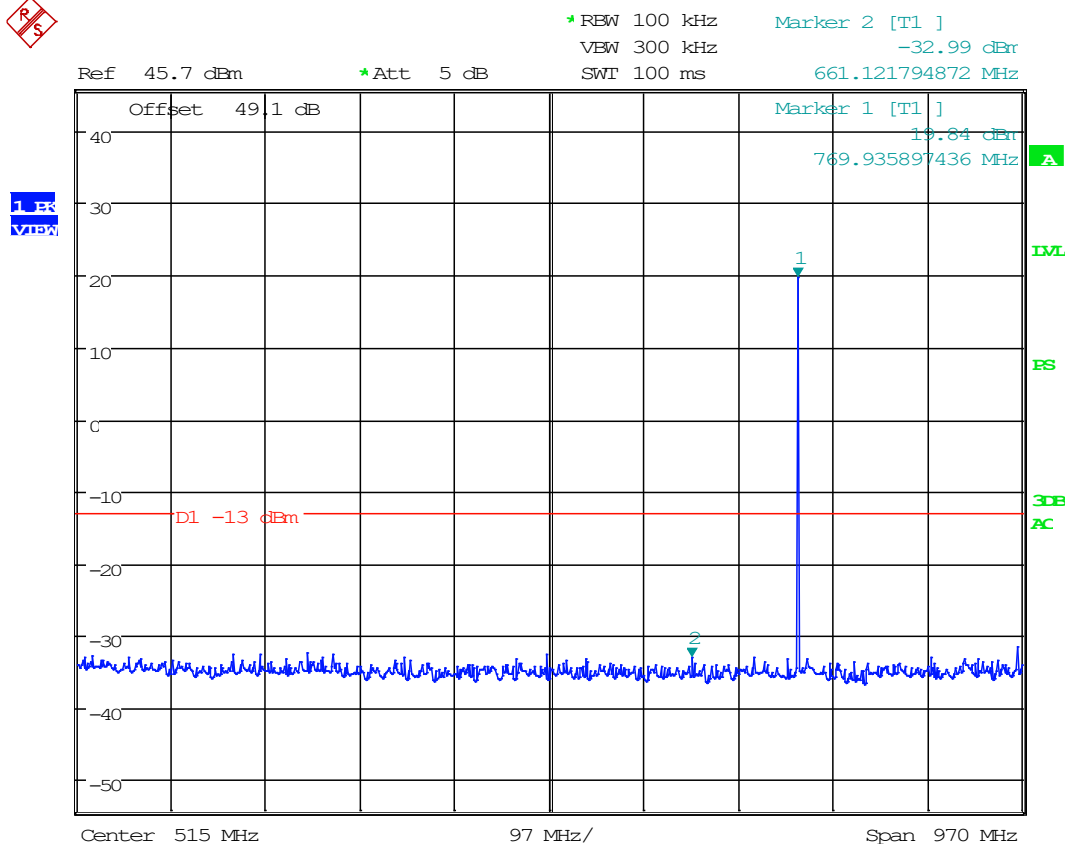

Date: 10.FEB.2003 04:00:29

8.5.2 Conducted Emissions Above 1GHz, 770 MHz

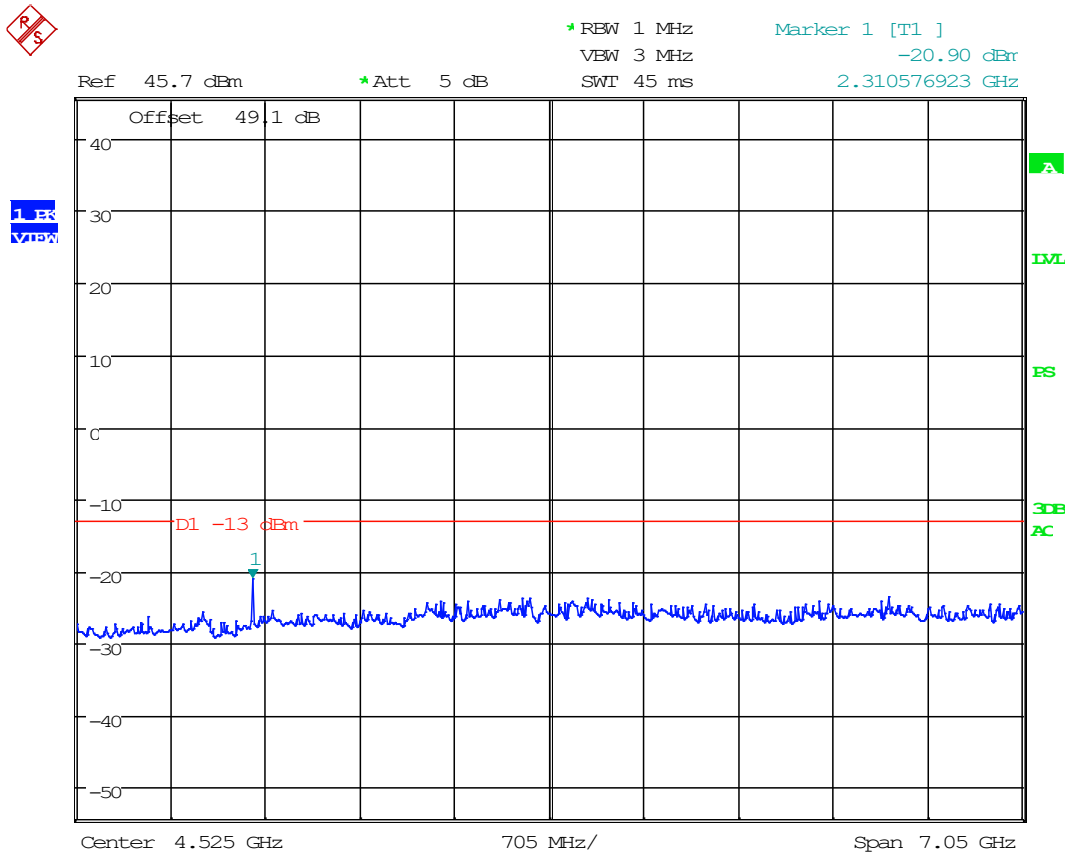

Date: 10.FEB.2003 04:06:51

8.5.3 Conducted Emissions Below 1GHz, 860 MHz

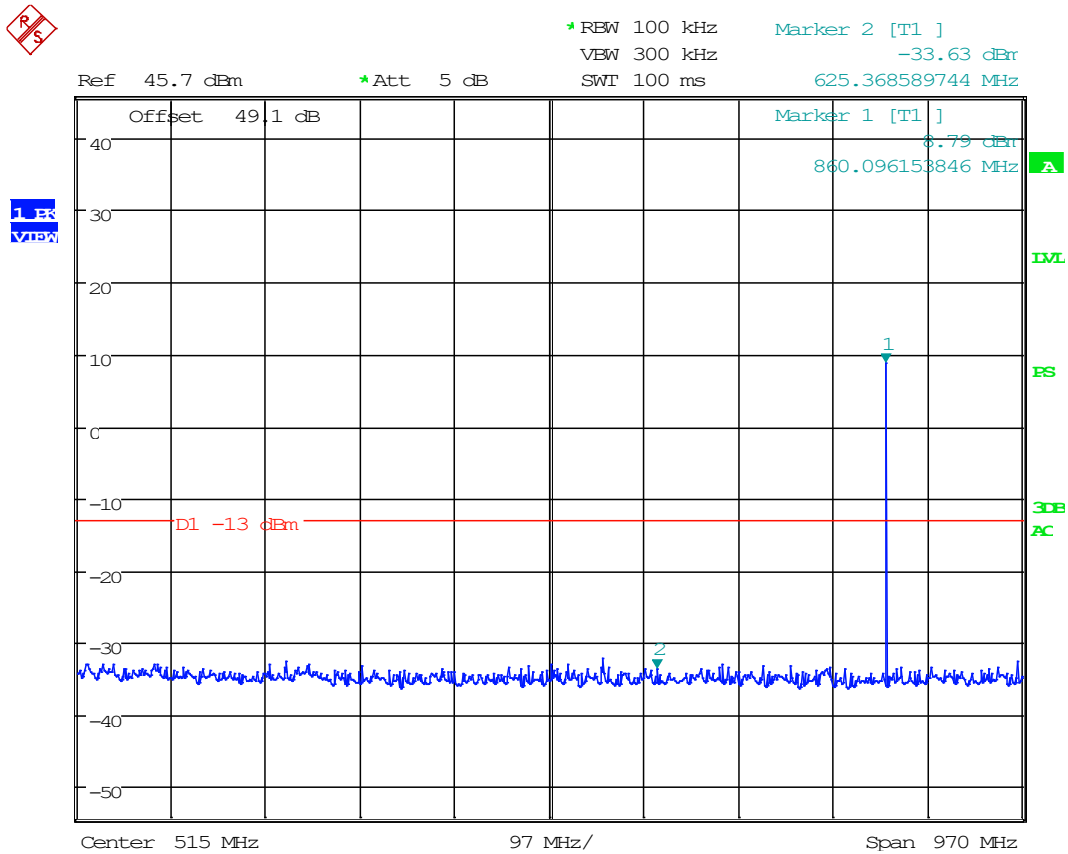

Date: 10.FEB.2003 04:02:25



8.5.4 Conducted Emissions Above 1GHz, 860 MHz

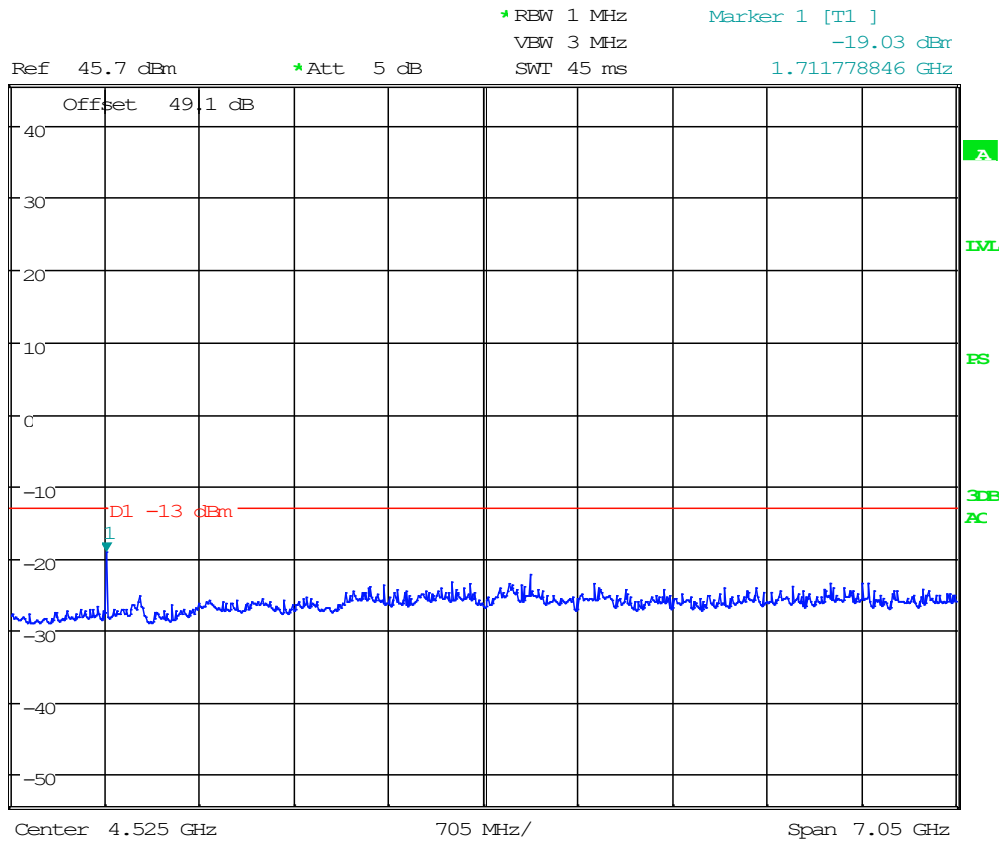

Date: 10.FEB.2003 04:04:12

8.6 Radiated Emissions

Limits from FCC Parts 2.1053, 80.211 (f), 87.139 (a), and 90.210 (n); and test procedure from ANSI C63.26-2015.

Radiated Test Setup, 30 – 1000 MHz

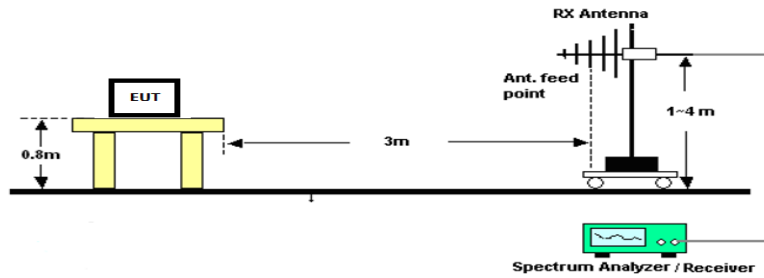

Radiated Test Setup, Above 1000 MHz

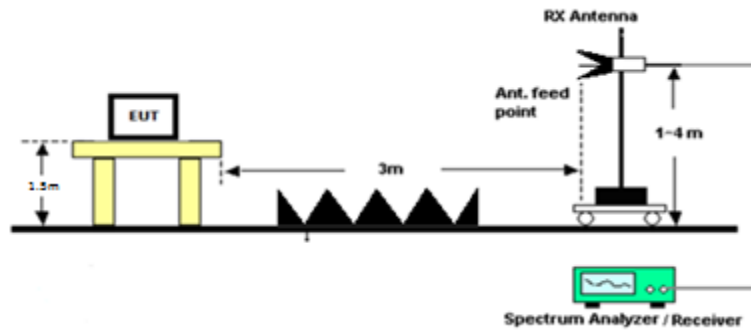



Radiated Emissions, Tabular Data

8.6.1 Radiated Emissions, 770 MHz

Tuned Frequency (MHz)	Emission Frequency (MHz)	Detector	Meter Reading (dBuV)	Antenna Polarity	Coax Loss (dB)	Antenna Correction Factor (dB/m)	Distance (m)	Field Strength (dBuV/m)	ERP (dBm)	Spurious Limit (dBm)	Margin (dB)
770.00	1540.00	PK	11.05	H	4.55	27.76	3.00	43.36	-54.02	-13.00	41.02
770.00	1540.00	PK	19.48	V	4.55	27.76	3.00	51.79	-45.59	-13.00	32.59
770.00	2310.00	PK	11.08	H	5.51	31.60	3.00	48.19	-49.19	-13.00	36.19
770.00	2310.00	PK	29.39	V	5.51	31.60	3.00	66.50	-30.88	-13.00	17.88
770.00	3080.00	PK	13.17	H	6.44	32.71	3.00	52.32	-45.06	-13.00	32.06
770.00	3080.00	PK	13.49	V	6.44	32.71	3.00	52.64	-44.74	-13.00	31.74
770.00	3850.00	PK	8.23	H	6.59	33.20	3.00	48.02	-49.36	-13.00	36.36
770.00	3850.00	PK	10.23	V	6.59	33.20	3.00	50.02	-47.36	-13.00	34.36
770.00	4620.00	PK	9.21	H	7.56	34.00	3.00	50.77	-46.61	-13.00	33.61
770.00	4620.00	PK	9.86	V	7.56	34.00	3.00	51.42	-45.96	-13.00	32.96
770.00	5390.00	PK	9.89	H	8.16	34.34	3.00	52.39	-44.99	-13.00	31.99
770.00	5390.00	PK	10.22	V	8.16	34.34	3.00	52.72	-44.66	-13.00	31.66
770.00	6160.00	PK	8.84	H	8.63	35.34	3.00	52.81	-44.57	-13.00	31.57
770.00	6160.00	PK	6.17	V	8.63	35.34	3.00	50.14	-47.24	-13.00	34.24
770.00	6930.00	PK	10.00	H	9.21	36.04	3.00	55.25	-42.12	-13.00	29.12
770.00	6930.00	PK	10.50	V	9.21	36.04	3.00	55.75	-41.62	-13.00	28.62
770.00	7700.00	PK	9.67	H	10.11	35.87	3.00	55.65	-41.73	-13.00	28.73
770.00	7700.00	PK	10.07	V	10.11	35.87	3.00	56.05	-41.33	-13.00	28.33



8.6.2 Radiated Emissions, 860 MHz

Tuned Frequency (MHz)	Emission Frequency (MHz)	Detector	Meter Reading (dBuV)	Antenna Polarity	Coax Loss (dB)	Antenna Correction Factor (dB/m)	Distance (m)	Field Strength (dBµV/m)	ERP (dBm)	Spurious Limit (dBm)	Margin (dB)
860.00	1720.00	PK	35.76	H	4.81	29.33	3.00	69.90	-27.48	-13.00	14.48
860.00	1720.00	PK	36.03	V	4.81	29.33	3.00	70.17	-27.21	-13.00	14.21
860.00	2580.00	PK	19.46	H	5.75	32.49	3.00	57.70	-39.68	-13.00	26.68
860.00	2580.00	PK	15.61	V	5.75	32.49	3.00	53.85	-43.53	-13.00	30.53
860.00	3440.00	PK	16.56	H	6.88	32.61	3.00	56.04	-41.33	-13.00	28.33
860.00	3440.00	PK	15.74	V	6.88	32.61	3.00	55.22	-42.15	-13.00	29.15
860.00	4300.00	PK	12.73	H	7.48	33.46	3.00	53.67	-43.71	-13.00	30.71
860.00	4300.00	PK	13.04	V	7.48	33.46	3.00	53.98	-43.40	-13.00	30.40
860.00	5160.00	PK	12.53	H	7.87	34.11	3.00	54.51	-42.87	-13.00	29.87
860.00	5160.00	PK	12.62	V	7.87	34.11	3.00	54.60	-42.78	-13.00	29.78
860.00	6020.00	PK	11.84	H	8.66	35.15	3.00	55.65	-41.72	-13.00	28.72
860.00	6020.00	PK	12.07	V	8.66	35.15	3.00	55.88	-41.49	-13.00	28.49
860.00	6880.00	PK	12.43	H	9.22	35.90	3.00	57.55	-39.83	-13.00	26.83
860.00	6880.00	PK	12.15	V	9.22	35.90	3.00	57.27	-40.11	-13.00	27.11
860.00	7740.00	PK	11.51	H	10.12	35.87	3.00	57.50	-39.88	-13.00	26.88
860.00	7740.00	PK	11.70	V	10.12	35.87	3.00	57.69	-39.69	-13.00	26.69
860.00	8600.00	PK	12.22	H	10.13	36.04	3.00	58.39	-38.99	-13.00	25.99
860.00	8600.00	PK	12.03	V	10.13	36.04	3.00	58.20	-39.18	-13.00	26.18

8.7 Modulation Characteristics

Limits from FCC Parts 2.1047 and test procedure from ANSI C63.26-2015

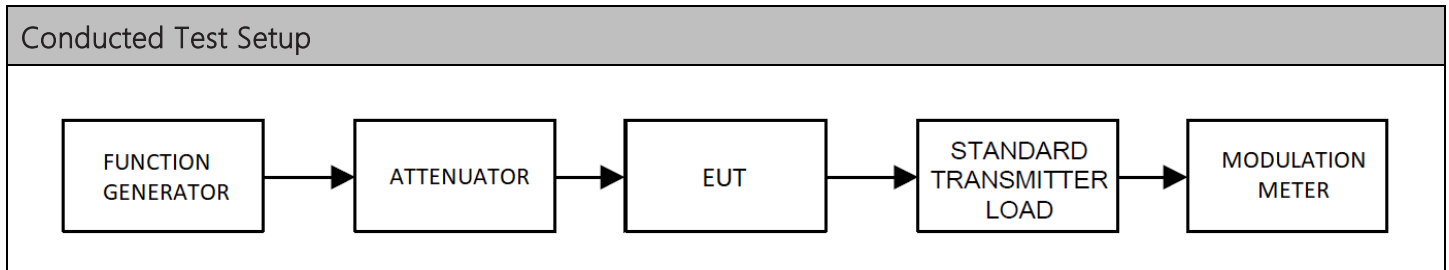

N/A

8.8 Frequency Stability

Limits from FCC Parts 2.1055, and 90.213; and test procedure from ANSI C63.26-2015.

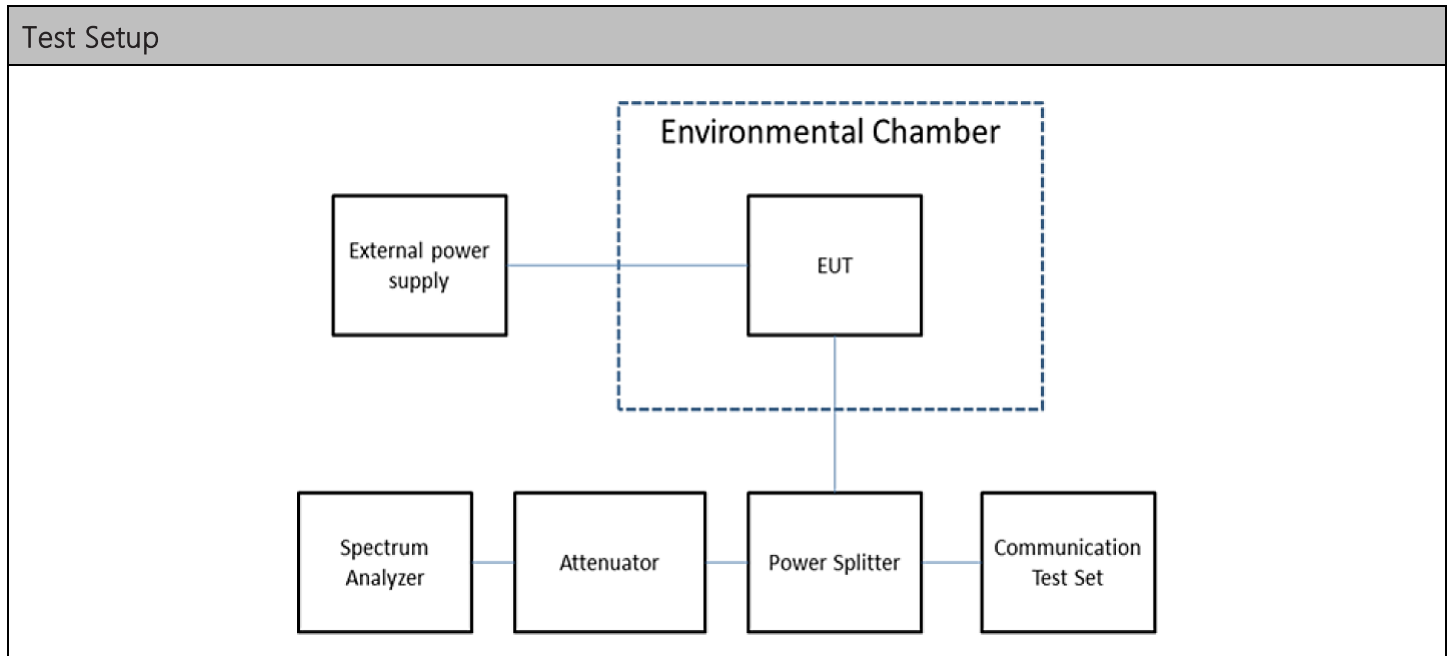

Test Results, Mode 1		
Tuned Frequency (MHz)	Max Deviation	Limit
770	-0.090	1



Frequency Stability, Tabular Data

8.8.1 Frequency Stability Data

FCC Part 90 Limit	1.0	ppm	
FCC Part 90 Limit, as ppb	1000	ppb (Parts per Billion)	
FCC Part 90 Limit, as %	0.00010	%	
Strictest Combined Limit, as Hz	770.000	Hz	
Combined Lower Limit	769.999380	MHz	
Combined Upper Limit	770.000920	MHz	
Rated Supply Voltage	110.0	<input checked="" type="radio"/> AC <input type="radio"/> DC	
Temperature / Voltage Variation			
Temperature (°C)	Supplied Voltage (V)	Frequency (MHz)	Deviation (kHz)
-30	110.0	770.000240	-0.090
-20	110.0	770.000210	-0.060
-10	110.0	770.000190	-0.040
0	110.0	770.000170	-0.020
+10	110.0	770.000160	-0.010
+20 (reference)	110.0	770.000150	0.000
+20	93.5	770.000150	0.000
+20	126.5	770.000150	0.000
+30	110.0	770.000140	0.010
+40	110.0	770.000150	0.000
+50	110.0	770.000150	0.000

8.8.2 Frequency Stability Plot

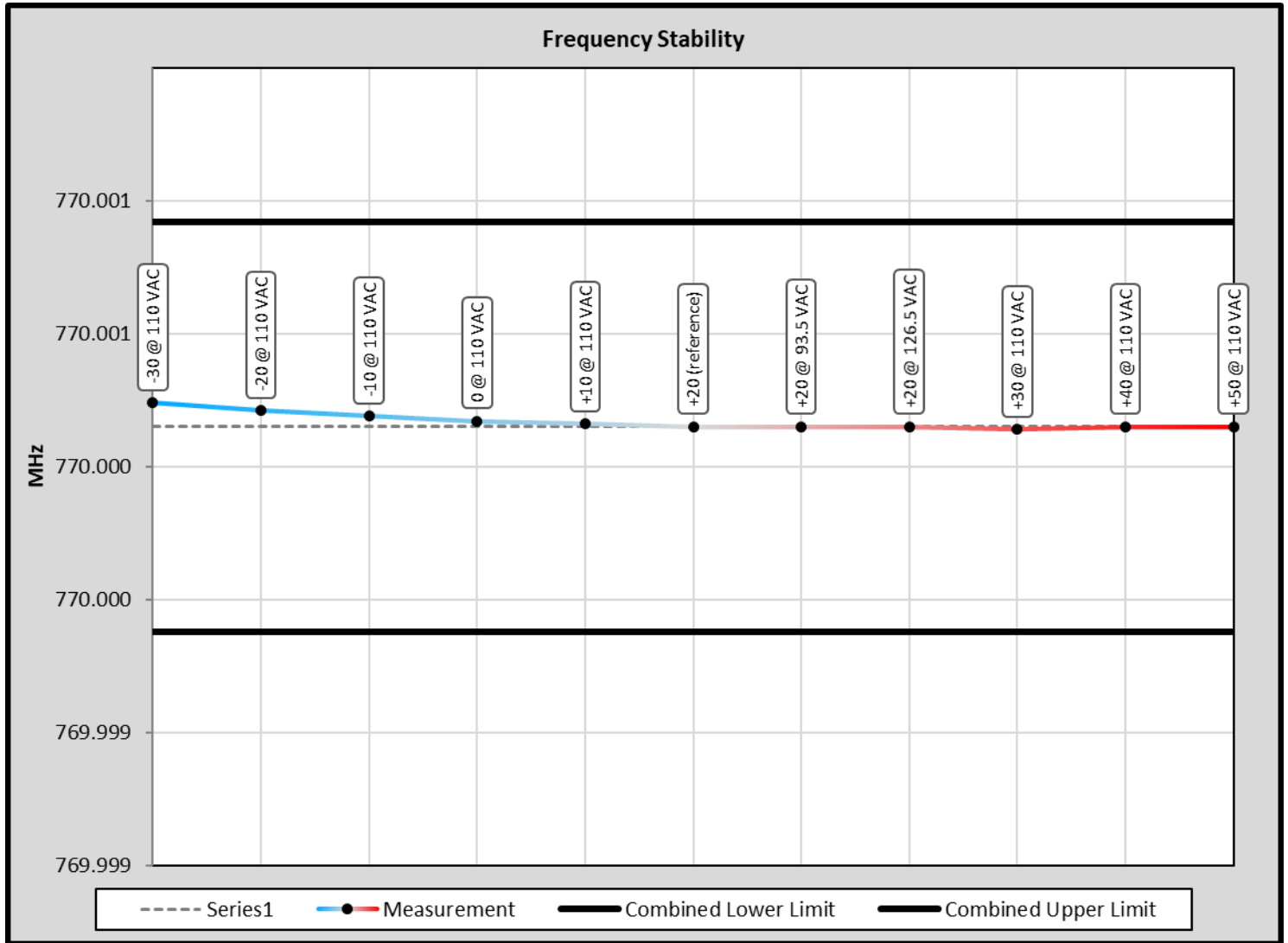

8.9 Transient Frequency Behavior

Limits from FCC Part 90.214; and test procedure from ANSI C63.26-2015.

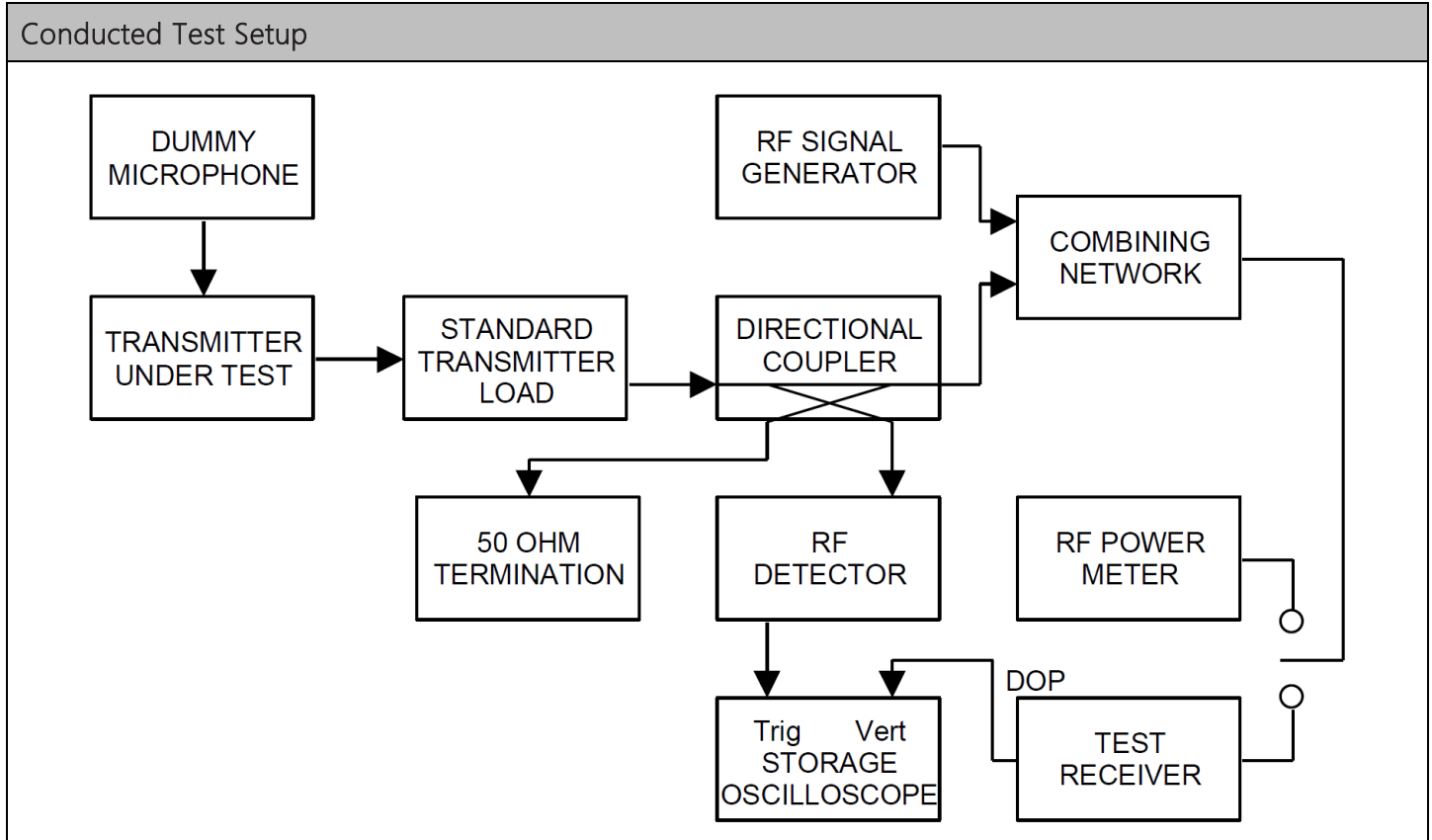

N/A

8.10 Adjacent channel power limits

Limits from FCC Part 90.221, and test procedure from ANSI C63.26-2015.

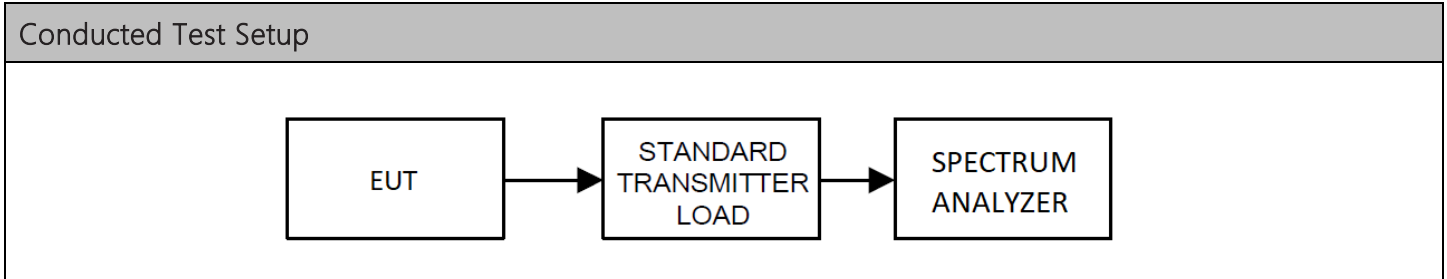

n/a. The EUT does not operate in a band requiring ACP.



9. ANNEX-A - Photographs of the EUT

Photographs of the EUT and any manufacturer supplied accessories to be used with the EUT are in separate supplementary documents labelled EXTERNAL PHOTOS and INTERNAL PHOTOS.

10. ANNEX-B – Test Setup Photographs

Test setup photographs are located in a separate supplementary ANNEX-B document.

11. History of Test Report Changes

Test Report #	Revision #	Description	Date of Issue
TR_3079-21_FCC_PT90_1	1	Initial release	6/25/2021
	2	Updated Pages 1, 14, 48, 49 - 51	8/11/2021



Timco Engineering, Inc., an IIA Company
849 NW State Road 45, Newberry, Florida 32669
(352) 472-5500 / testing@timcoengr.com

END OF TEST REPORT
