



Test Report

Product Name : WLAN PCMCIA CARD

Model No. : KWL-210

FCC ID.: OIBKWL-210

Applicant : KAI-LINK CORPORATION LTD.

Address : No.13-1, Chung Hwa Road, Hsin-Chu Industrial
District, Hsin-Chu, 303, Taiwan, R.O.C.

Date of Receipt : Jan.30, 2002

Date of Test : Feb.04, 2001

Report No. : 022H015FI

The Test Results relate only to the samples tested.

The test report shall not be reproduced except in full without the written approval of Quietek Corporation.
This report must not be used to claim product endorsement by NVLAP any agency of the U.S. Government

Test Report Certification

Test Date : Feb.04, 2001

Report No. : 022H015FI



Accredited by NIST (NVLAP)

NVLAP Lab Code: 200347-0

Product Name : WLAN PCMCIA CARD

Applicant : KAI-LINK CORPORATION LTD.

Address : No.13-1, Chung Hwa Road, Hsin-Chu Industrial District, Hsin-Chu, 303, Taiwan, R.O.C.

Manufacturer : KAI-LINK CORPORATION LTD.

Model No. : KWL-210

FCC ID. : OIBKWL-210

Rated Voltage : DC 3.3V(Power by PC)

Trade Name : KAI-KINK

Measurement Standard : FCC Part 15 Subpart C Paragraph 15.247

Measurement Procedure : ANSI C63.4:1992

Test Result : Complied

The Test Results relate only to the samples tested.

The test report shall not be reproduced except in full without the written approval of Quietek Corporation.

This report must not be used to claim product endorsement by NVLAP any agency of the U.S. Government

Documented By : 
 (Lisa Chen)

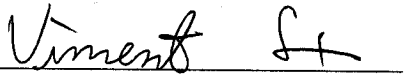
Tested By : 
 (Vincent Lin)

Approved By : 
 (Kevin Wang)

TABLE OF CONTENTS

Description	Page
1. GENERAL INFORMATION.....	5
1.1. EUT Description.....	5
1.2. EUT Description.....	5
1.3. Configuration of tested System	7
1.4. EUT Exercise Software	7
1.5. Test Facility	8
2. Conducted Emission.....	9
2.1. Test Equipment List.....	9
2.2. Test Setup	9
2.3. Limits	9
2.4. Test Procedure	10
2.5. Test Result of Conducted Emission.....	11
3. Peak Power Output	12
3.1. Test Equipment.....	12
3.2. Test Setup	12
3.3. Test Condition	12
3.4. Minimum Standard.....	12
3.5. Test Result of Peak Power Output.....	13
4. RF Exposure Evaluation.....	14
4.1. Friis Formula	14
4.2. EUT Operation condition	14
4.3. Test Result of RF Exposure Evaluation.....	15
5. Radiated Emission.....	16
5.1. Test Equipment.....	16
5.2. Test Setup	16
5.3. Test Condition	17
5.4. Limits	17
5.5. Test Procedure	18
5.6. Test Result of Radiated Emission.....	19
5.7. Test Result of Band Edge	31
6. Occupied Bandwidth.....	35
6.1. Test Equipment.....	35
6.2. Test Setup	35
6.3. Test Condition	35
6.4. Standard Requirement	35
6.5. Test Result of Occupied Bandwidth	36
7. Transmitter Power Density.....	39
7.1. Test Equipment.....	39
7.2. Test Setup	39
7.3. Test Condition	39
7.4. Standard Requirement	39
7.5. Test Result of Transmitter Power Density.....	40

8.	Processing Gain	43
8.1.	Test Condition	43
8.2.	Minimum Standard.....	43
8.3.	Method of Measurement	43
8.4.	Calculation of Processing Gain:	43
8.5.	Test Result of Processing Gain.....	44
9.	EMI Reduction Method During Compliance Testing	74
10.	Attachment.....	75

Attachment 1: EUT Test Photographs

Attachment 2: EUT Detailed Photographs

1. GENERAL INFORMATION

1.1. EUT Description

Product Name	: WLAN PCMCIA CARD	
Trade Name	: KAI-KINK	
FCC ID.	: OIBKWL-210	
Model No.	: KWL-210	
Frequency Range	: 2412MHz to 2462MHz	
Channel Number	: 11	
Frequency of Each Channel	: Channel 01: 2412MHz	Channel 07: 2442MHz
(Working Frequency)	: Channel 02: 2417 MHz	Channel 08: 2447 MHz
	: Channel 03: 2422 MHz	Channel 09: 2452 MHz
	: Channel 04: 2427MHz	Channel 10: 2457MHz
	: Channel 05: 2432MHz	Channel 11: 2462MHz
	: Channel 06: 2437MHz	
Type of Modulation	: Direct Sequence Spread Spectrum	
Channel Control	: Auto	

Note:

1. This device is a 2.4GHz WLAN PCMCIA CARD with USB interface included a 2.4GHz receiving function, a 2.4GHz transmitting function.
2. These tests were conducted on a sample of the equipment for the purpose of demonstrating compliance with Part 15 Subpart C Paragraph 15.247 for spread spectrum devices.
3. This EUT is marketed by the variation of agent as below:
 - 1) CHOU CHIN INDUSTRIAL CO., LTD.
 - 2) ARESKOM
4. This device is a composite device in accordance with Part 15 regulations. The function receiving was measured and made a test report that the report number is 022H015F under Verification.

1.2. EUT Description

EUT is a WLAN PCMCIA CARD with 11 Channels.

This device provided four kind of transmitting Speed 1, 2, 5.5 and 11Mbps. The device of RF Carrier is DBPSK modulation for transmitting Speed 1Mbps, DQPSK modulation for transmitting Speed 2Mbps and CCK modulation for transmitting Speed 5.5Mbps and 11Mbps.

The device was adapted direct sequence Spread Spectrum modulation. The antenna was printed on the PCB directly provides diversity function to improve the transmitting and receiving function.

The PCMCIA Interface provides the connection to PC for data transmission data can be transmitted by the radio signal connect to the local network.

Tested System Details

The types for all equipment, plus descriptions of all cables used in the tested system (including inserted cards) are:

Product	Manufacturer	Model No.	Serial No.	Power Cord	FCC ID
(1) Notebook	DELL	PP01L	2724903568	Non-shielded, 1.8m	DoC
(2) Monitor	HITACHI	CM752ET-311	T8E004439	Shielded, 1.7m	DoC
(3) Printer	HP	C2642A	MY75L1D2XN	Non-Shielded, 0.7m	B94C2642X
(4) Mouse	Logitech	M-M34	LZA824741192	--	DZL211029
(5) USB Mouse	Logitech	M-UE55	LTC93800397	--	DoC
(6) Earphone	BSD	PH136	N/A	--	--
(7) Microphone	DYNAMIC	DM-35	N/A	--	DoC
(8) Modem	ACEEX	1414	980033032	--	IFAXDM1414
(9) Notebook	IBM	Think Pad 570	27L8835	Non-shielded, 1.5m	DoC

Signal Cable Type	Signal Cable Description
A. Notebook Power Cable (IN)	Non-shielded, 1.8m
B. Notebook Power Cable (Out)	Non-shielded, 1.5m
C. VGA Cable	Shielded, 1.8m, two ferrite cores bonded
D. Mouse Cable	Shielded, 1.6m
E. USB Cable	Shielded, 1.0m
F. Modem Cable	Shielded, 1.2m
G. Microphone Cable	Non-shielded, 2.5m
H. Earphone Cable	Non-shielded, 1.2m
I. Printer Cable	Shielded, 1.0m

1.3. Configuration of tested System

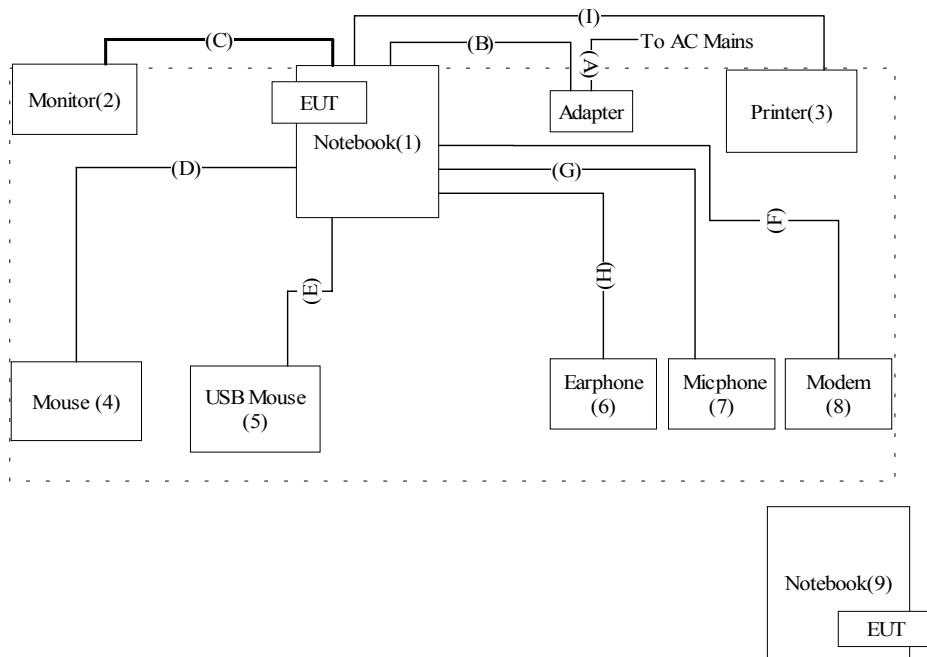

1.4. EUT Exercise Software

- 1.4.1 Setup the EUT and simulators as shown on 1.3.
- 1.4.2 Turn on the power of all equipment.
- 1.4.3 Personal Computer reads data from disk.
- 1.4.4 Data will be transmitted through EUT.
- 1.4.5 The transmission status will be shown on the monitor.
- 1.4.6 Repeat the above procedure 1.4.4 to 1.4.5

1.5. Test Facility

Ambient conditions in the laboratory:

Items	Required (IEC 68-1)	Actual
Temperature (°C)	15-35	20-35
Humidity (%RH)	25-75	50-65
Barometric pressure (mbar)	860-1060	950-1000

Site Description: November 3, 1998 File on
Federal Communications Commission
FCC Engineering Laboratory
7435 Oakland Mills Road
Columbia, MD 21046
Reference 31040/SIT1300F2
August 30, 2001 Accreditation on NVLAP
NVLAP Lab Code: 200347-0



Site Name: Quietek Corporation

Site Address: No.75-1, Wang-Yeh Valley, Yung-Hsing,
Chiung-Lin, Hsin-Chu County,
Taiwa, R.O.C.

2. Conducted Emission

2.1. Test Equipment List

The following test equipment are used during the conducted emission test:

Item	Instrument	Manufacturer	Type No./Serial No	Last Cal.	Remark
1	Test Receiver	R & S	ESCS 30/825442/17	May, 2001	
2	L.I.S.N.	R & S	ESH3-Z5/825016/6	May, 2001	EUT
3	L.I.S.N.	Kyoritsu	KNW-407/8-1420-3	May, 2001	Peripherals
4	Pulse Limiter	R & S	ESH3-Z2	N/A	
5	No.2 Shielded Room			N/A	

Note: All equipment upon which need to calibrated are with calibration period of 1 year.

2.2. Test Setup

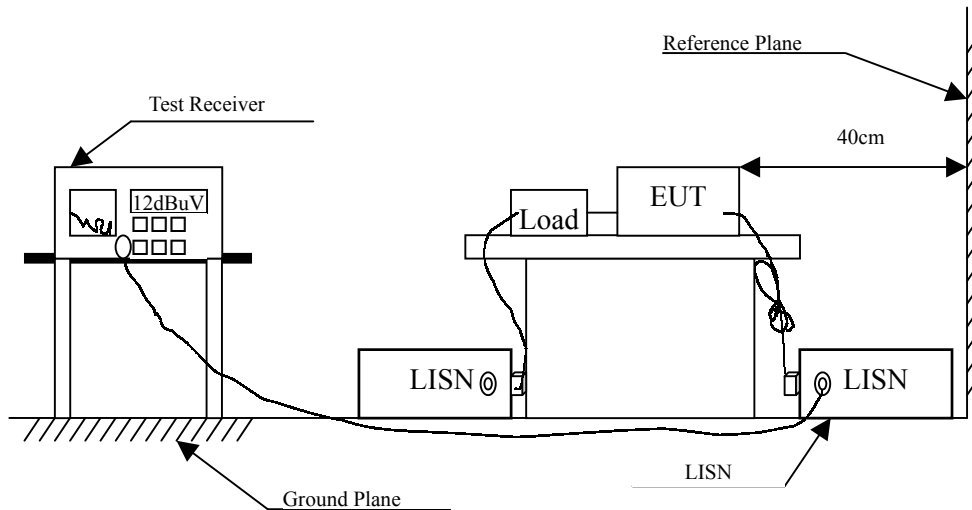

2.3. Limits

FCC Part 15 Paragraph 15.207 (dBuV)		
Frequency MHz	Limits	
	uV	dBuV
0.45 - 30	250	48.0

2.4. Test Procedure

The EUT and simulators are connected to the main power through a line impedance stabilization network (L.I.S.N.). This provides a 50 ohm /50uH coupling impedance for the measuring equipment. The peripheral devices are also connected to the main power through a LISN that provides a 50ohm/50uH coupling impedance with 50ohm termination. (Please refers to the block diagram of the test setup and photographs.)

Both sides of A.C. line are checked for maximum conducted interference. In order to find the maximum emission, the relative positions of equipment and all of the interface cables must be changed according to ANSI C63.4:1992 on conducted measurement.

Conducted emissions were investigated over the frequency range from 0.45MHz to 30MHz using a receiver bandwidth of 9kHz.

2.5. Test Result of Conducted Emission

Product : WLAN PCMCIA CARD
 Test Item : Conducted Emission Test
 Test Mode : Normal Operation

Frequency MHz	Cable Loss dB	LISN Factor dB	Reading Level dBuV	Emission Level dBuV	Limits dBuV
Line 1					
Quasi-Peak:					
0.469	0.06	0.21	22.83	23.10	48.00
* 0.704	0.08	0.25	25.83	26.16	48.00
1.457	0.12	0.31	18.57	19.01	48.00
2.215	0.15	0.35	20.09	20.59	48.00
3.399	0.18	0.39	12.51	13.08	48.00
7.086	0.24	0.46	9.05	9.75	48.00
Line 2					
Quasi-Peak:					
0.466	0.06	0.21	22.17	22.44	48.00
0.520	0.07	0.22	17.04	17.32	48.00
0.703	0.08	0.25	15.54	15.87	48.00
2.101	0.15	0.35	10.65	11.15	48.00
* 3.278	0.17	0.39	22.48	23.04	48.00
3.860	0.18	0.41	19.19	19.78	48.00

Remarks :

1. All Reading Levels are Quasi-Peak value.
2. " * " means that this data is the worst emission level.
3. Emission Level = Reading Level + LISN factor + Cable Loss.

3. Peak Power Output

3.1. Test Equipment

The following test equipments are used during the radiated emission tests:

	Equipment	Manufacturer	Model No./Serial No.	Last Cal.
X	Spectrum Analyzer	Advantest	R3272 / 72421194	May, 2001
X	Power Meter	HP	EPM-441A	May, 2001

Note: 1. All equipment upon which need to calibrated are with calibration period of 1 year.
 2. Mark "X" test instruments are used to measure the final test results.

3.2. Test Setup

Conduction Power Measurement

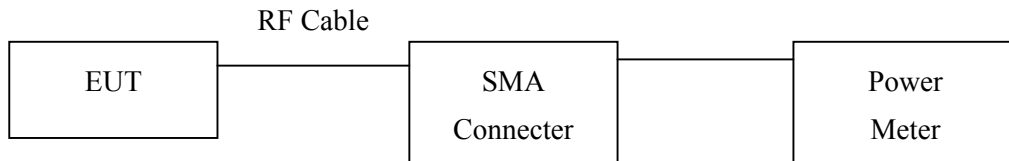

3.3. Test Condition

Standard Temperature and Humidity, Standard Test Voltage

3.4. Minimum Standard

The maximum peak power shall be less 1 Watt.

3.5. Test Result of Peak Power Output

Product : WLAN PCMCIA CARD
 Test Item : Peak Power Output Data
 Test Site : No.1 OATS
 Test Mode : Normal Operation

Data Speed: 1Mbps

Channel No.	Frequency(MHz)	Measurement	Required Limit	Result
1	2412	11.83 dBm	1 Watt= 30 dBm	Pass
6	2436	12.82dBm	1 Watt= 30 dBm	Pass
11	2461	12.90 dBm	1 Watt= 30 dBm	Pass

Data Speed: 11Mbps

Channel No.	Frequency(MHz)	Measurement	Required Limit	Result
1	2412	10.81 dBm	1 Watt= 30 dBm	Pass
6	2436	12.16dBm	1 Watt= 30 dBm	Pass
11	2461	12.87 dBm	1 Watt= 30 dBm	Pass

4. RF Exposure Evaluation

According to FCC 1.1310: The criteria listed in the following table shall be used to evaluate the environment impact of human exposure to radio frequency (RF) radiation as specified in 1.1307(b)
 LIMITS FOR MAXIMUM PERMISSIBLE EXPOSURE (MPE)

Frequency Range (MHz)	Electric Field Strength (V/m)	Magnetic Field Strength (A/m)	Power Density (mW/cm ²)	Average Time (Minutes)
(A) Limits for Occupational/ Control Exposures				
300-1500	--	--	F/300	6
1500-100,000	--	--	5	6
(B) Limits for General Population/ Uncontrolled Exposures				
300-1500	--	--	F/1500	6
1500-100,000	--	--	1	30

F= Frequency in MHz

4.1. Friis Formula

$$\text{Friis transmission formula: } P_d = (P_{out} * G) / (4 * \pi * r^2)$$

Where

P_d = power density in mW/cm²

P_{out} = output power to antenna in mW

G = gain of antenna in linear scale

π = 3.1416

R = distance between observation point and center of the radiator in cm

P_d is the limit of MPE, 1 mW/cm². If we know the maximum gain of the antenna and the total power input to the antenna, through the calculation, we will know the distance r where the MPE limit is reached.

4.2. EUT Operation condition

A software provided by client enabled the EUT to transmit and receive data at lowest, middle and highest channel individually.

4.3. Test Result of RF Exposure Evaluation

Product : WLAN PCMCIA CARD
 Test Item : RF Exposure Evaluation Data
 Test Site : No.1 OATS
 Test Mode : Normal Operation

4.3.1 Antenna Gain

Antenna Gain: The maximum Gain measured in fully anechoic chamber is 1.6dBi or 1.45in linear scale.

4.3.2 Output Power Into Antenna & RF Exposure Evaluation Distance

Channel	Channel Frequency (MHz)	Output Power to Antenna (dBm)	Minimum Allowable Distance ® From Skin(cm)
1 (1Mbps)	2412	11.83	0.99
1 (11Mbps)	2412	10.81	0.88
6 (1Mbps)	2436	12.82	1.10
6 (11Mbps)	2436	12.16	1.02
11 (1Mbps)	2461	12.90	1.11
11 (11Mbps)	2461	12.87	1.11

The distance r (4th column) calculated from the Friis transmission formula is far shorter than 2.5 cm separation requirement. So, RF exposure limit warning or SAR test are not required.

5. Radiated Emission

5.1. Test Equipment

The following test equipment are used during the radiated emission test:

Test Site	Equipment	Manufacturer	Model No./Serial No.	Last Cal.
Site # 1	X Test Receiver	R & S	ESCS 30 / 825442/14	May, 2001
	X Spectrum Analyzer	Advantest	R3261C / 71720140	May, 2001
	X Pre-Amplifier	HP	8447D/3307A01812	May, 2001
	X Bilog Antenna	Chase	CBL6112B / 12452	Sep., 2001
	X Horn Antenna	EM	EM6917 / 103325	May, 2001
Site # 2	Test Receiver	R & S	ESCS 30 / 825442/17	May, 2001
	Spectrum Analyzer	Advantest	R3261C / 71720609	May, 2001
	Pre-Amplifier	HP	8447D/3307A01814	May, 2001
	Bilog Antenna	Chase	CBL6112B / 2455	Sep., 2001
	Horn Antenna	EM	EM6917 / 103325	May, 2001

- Note:
1. All equipments that need to calibrate are with calibration period of 1 year.
 2. Mark "X" test instruments are used to measure the final test results.

5.2. Test Setup

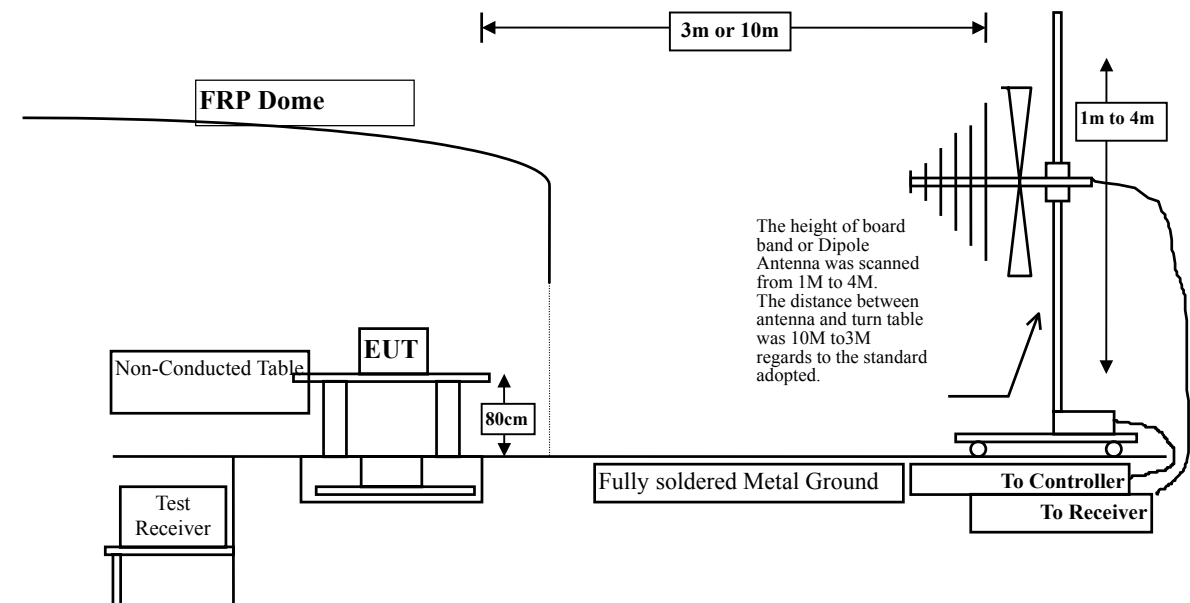

Spurious Emissions
(Band Edge Antenna Radiated)

5.3. Test Condition

Standard Temperature and Humidity, Standard Test Voltage

5.4. Limits

► General Radiated Emission Limits

Emissions radiated outside of the specified frequency bands, except for harmonics, shall be attenuated by at least 20dB below the level of the fundamental or to the general radiated emission limits in paragraph 15.209, whichever is the lesser attenuation.

Frequency MHz	General Radiated Limits (dBuV/m @3m)
30-88	40
88-216	43.5
216-960	46
Above 960	54

- Remarks :
1. RF Voltage (dBuV) = 20 log RF Voltage (uV)
 2. In the Above Table, the tighter limit applies at the band edges.
 3. Distance refers to the distance in meters between the measuring instrument antenna and the closed point of any part of the device or system.

5.5. Test Procedure

The EUT and its simulators are placed on a turn table which is 0.8 meter above ground. The turn table can rotate 360 degrees to determine the position of the maximum emission level. The EUT was positioned such that the distance from antenna to the EUT was 3 meters.

The antenna can move up and down between 1 meter and 4 meters to find out the maximum emission level.

Both horizontal and vertical polarization of the antenna are set on measurement. In order to find the maximum emission, all of the interface cables must be manipulated according to ANSI C63.4:1992 on radiated measurement.

The additional latch filter below 1GHz was used to measure the level of harmonics radiated emission during field strength of harmonics measurement.

The bandwidth below 1GHz setting on the field strength meter (R&S Test Receiver ESCS 30)is 120 kHz, above 1GHz are 1 MHz.

The frequency range from 30MHz to 10th harmonics is checked.

5.6. Test Result of Radiated Emission

Product : WLAN PCMCIA CARD
 Test Item : Harmonic Radiated Emission Data
 Test Mode : Channel 1(1Mbps)

Freq.	Cable Loss	Probe Factor	PreAMP	Reading Level	Emission Level	Margin	Limit
MHz	dB	dB/m	dB	dBuV	dBuV/m	dB	dBuV/m

Peak Detector (Horizontal)

4819.500	6.26	33.48	34.78	35.63	40.59	33.41	74.00
7234.070	8.32	36.24	34.90	37.65	47.31	26.69	74.00
9642.800	10.18	37.43	35.10	34.31	<46.82	27.18	74.00
12052.26	11.90	39.12	34.66	34.72	<51.08	22.92	74.00

Peak Detector (Vertical)

4824.080	6.27	33.50	34.77	36.71	41.71	32.29	74.00
7237.700	8.32	36.24	34.90	39.12	48.78	25.22	74.00
9638.030	10.17	37.43	35.10	34.87	<47.36	26.64	74.00
12051.40	11.90	39.12	34.66	34.60	<50.96	23.04	74.00

Note:

1. All Readings below 1GHz are Quasi-Peak, above are Average value.
2. Emission Level = Reading Level + Probe Factor + Cable loss-PreAMP.
3. The Average measurement was not performed when the Peak measured data under the limit of Average detection.

Product : WLAN PCMCIA CARD
 Test Item : Harmonic Radiated Emission Data
 Test Mode : Channel 6(1Mbps)

Freq.	Cable	Probe	PreAMP	Reading	Emission	Margin Limit	
MHz	Loss	Factor	dB	Level	Level	dB	dBuV/m
	dB	dB/m		dBuV	dBuV/m		

Peak Detector (Horizontal)

4867.690	6.30	33.54	34.76	35.07	40.16	33.84	74.00
7312.940	8.38	36.31	34.90	36.93	46.71	27.29	74.00
9750.040	10.25	37.45	35.10	35.10	<47.70	26.30	74.00
12188.90	11.99	39.17	34.55	34.36	<50.98	23.02	74.00

Peak Detector (Vertical)

4878.270	6.32	33.56	34.75	35.65	40.78	33.22	74.00
7313.540	8.39	36.32	34.90	37.24	47.06	26.94	74.00
9750.600	10.25	37.45	35.10	35.12	<47.72	26.28	74.00
12191.05	11.99	39.17	34.55	34.29	<50.91	23.09	74.00

Note:

1. All Readings below 1GHz are Quasi-Peak, above are Average value.
2. Emission Level = Reading Level + Probe Factor + Cable loss-PreAMP.
3. The Average measurement was not performed when the Peak measured data under the limit of Average detection.

Product : WLAN PCMCIA CARD
 Test Item : Harmonic Radiated Emission Data
 Test Mode : Channel 11(1Mbps)

Freq.	Cable Loss	Probe Factor	PreAMP	Reading Level	Emission Level	Margin	Limit
MHz	dB	dB/m	dB	dBuV	dBuV/m	dB	dBuV/m

Peak Detector (Horizontal)

4925.070	6.37	33.62	34.73	35.18	40.44	33.56	74.00
7381.850	8.43	36.37	34.90	36.26	46.17	27.83	74.00
9844.060	10.32	37.47	35.10	34.99	<47.67	26.33	74.00
12306.50	12.07	39.22	34.46	35.20	<52.04	21.96	74.00

Peak Detector (Vertical)

4920.540	6.37	33.62	34.73	35.14	40.40	33.60	74.00
7382.750	8.43	36.37	34.90	36.20	46.11	27.89	74.00
9842.800	10.32	37.47	35.10	35.76	<48.44	25.56	74.00
12306.90	12.07	39.22	34.46	34.25	<51.09	22.91	74.00

Note:

1. All Readings below 1GHz are Quasi-Peak, above are Average value.
2. Emission Level = Reading Level + Probe Factor + Cable loss-PreAMP.
3. The Average measurement was not performed when the Peak measured data under the limit of Average detection.

Product : WLAN PCMCIA CARD
 Test Item : Harmonic Radiated Emission Data
 Test Mode : Channel 1(11Mbps)

Freq.	Cable Loss	Probe Factor	PreAMP	Reading Level	Emission Level	Margin	Limit
MHz	dB	dB/m	dB	dBuV	dBuV/m	dB	dBuV/m

Peak Detector (Horizontal)

4820.760	6.27	33.50	34.77	35.59	40.59	33.41	74.00
7233.800	8.32	36.24	34.90	36.87	46.53	27.47	74.00
9639.240	10.17	37.43	35.10	34.59	<47.08	26.92	74.00
12048.60	11.90	39.12	34.66	35.20	<51.56	22.44	74.00

Peak Detector (Vertical)

4824.380	6.27	33.50	34.77	35.77	40.77	33.23	74.00
7233.170	8.32	36.24	34.90	38.84	48.50	25.50	74.00
9640.750	10.17	37.43	35.10	35.07	<47.56	26.44	74.00
12051.60	11.90	39.12	34.66	34.70	<51.06	22.94	74.00

Note:

1. All Readings below 1GHz are Quasi-Peak, above are Average value.
2. Emission Level = Reading Level + Probe Factor + Cable loss-PreAMP.
3. The Average measurement was not performed when the Peak measured data under the limit of Average detection.

Product : WLAN PCMCIA CARD
 Test Item : Harmonic Radiated Emission Data
 Test Mode : Channel 6(11Mbps)

Freq.	Cable	Probe	PreAMP	Reading	Emission	Margin	Limit
MHz	Loss	Factor	Level	Level	Level	dB	dBuV/m
	dB	dB/m	dB	dBuV	dBuV/m		

Peak Detector (Horizontal)

4872.800	6.32	33.56	34.75	35.28	40.41	33.59	74.00
7311.400	8.38	36.31	34.90	36.53	46.31	27.69	74.00
9355.400	9.96	37.37	35.10	36.76	<49.00	25.00	74.00
12188.60	11.99	39.17	34.55	35.92	<52.54	21.46	74.00

Peak Detector (Vertical)

4869.500	6.30	33.54	34.76	34.87	39.96	34.04	74.00
7312.300	8.38	36.31	34.90	38.10	47.88	26.12	74.00
9766.600	10.27	37.45	35.10	36.31	<48.93	25.07	74.00
12215.80	12.01	39.19	34.52	36.30	<52.98	21.02	74.00

Note:

1. All Readings below 1GHz are Quasi-Peak, above are Average value.
2. Emission Level = Reading Level + Probe Factor + Cable loss-PreAMP.
3. The Average measurement was not performed when the Peak measured data under the limit of Average detection.

Product : WLAN PCMCIA CARD
 Test Item : Harmonic Radiated Emission Data
 Test Mode : Channel 11(11Mbps)

Freq.	Cable Loss	Probe Factor	PreAMP	Reading Level	Emission Level	Margin	Limit
MHz	dB	dB/m	dB	dBuV	dBuV/m	dB	dBuV/m

Peak Detector (Horizontal)

4924.800	6.37	33.62	34.73	34.26	39.52	34.48	74.00
7382.500	8.43	36.37	34.90	35.50	45.41	28.59	74.00
9838.900	10.32	37.47	35.10	35.60	<48.28	25.72	74.00
12305.90	12.07	39.22	34.46	34.96	<51.80	22.20	74.00

Peak Detector (Vertical)

4919.900	6.37	33.62	34.73	35.55	40.81	33.19	74.00
7383.050	8.43	36.37	34.90	36.11	46.02	27.98	74.00
9844.360	10.32	37.47	35.10	35.67	<48.35	25.65	74.00
12302.30	12.07	39.22	34.46	35.01	<51.85	22.15	74.00

Note:

1. All Readings below 1GHz are Quasi-Peak, above are Average value.
2. Emission Level = Reading Level + Probe Factor + Cable loss-PreAMP.
3. The Average measurement was not performed when the Peak measured data under the limit of Average detection.

Product : WLAN PCMCIA CARD
 Test Item : General Radiated Emission Data
 Test Mode : Channel 1(1Mbps)

Freq.	Cable Loss	Probe Factor	PreAMP	Reading Level	Emission Level	Margin	Limit
MHz	dB	dB/m	dB	dBuV	dBuV/m	dB	dBuV/m

Horizontal:

51.340	1.10	7.47	26.86	38.80	20.52	19.48	40.00
195.870	1.70	12.19	26.91	37.40	24.38	19.12	43.50
399.570	2.54	14.99	26.79	34.00	24.73	21.27	46.00
*456.800	2.77	16.30	26.70	37.40	29.77	16.23	46.00
481.050	2.87	16.86	26.66	34.80	27.86	18.14	46.00
571.260	3.24	18.37	26.52	33.20	28.28	17.72	46.00

Vertical:

65.890	1.16	7.38	26.86	40.80	22.48	17.52	40.00
*195.870	1.70	12.19	26.91	41.20	28.18	15.32	43.50
334.580	2.27	13.64	26.90	37.00	26.01	19.99	46.00
455.830	2.76	16.28	26.70	35.80	28.14	17.86	46.00
575.140	3.26	18.43	26.52	30.80	25.96	20.04	46.00
745.860	3.96	21.24	26.25	29.60	28.55	17.45	46.00

Note:

1. All Readings below 1GHz are Quasi-Peak, above are average value.
2. “ * ”, means this data is the worst emission level.
3. Emission = Reading Level + Probe Factor + Cable loss.- PreAMP.

Product : WLAN PCMCIA CARD
 Test Item : General Radiated Emission Data
 Test Mode : Channel 6(1Mbps)

Freq.	Cable	Probe	PreAMP	Reading	Emission	Margin Limit	
MHz	Loss	Factor	dB	Level	Level	dB	dBuV/m
	dB	dB/m		dBuV	dBuV/m		

Horizontal:

67.830	1.17	7.43	26.86	38.20	19.94	20.06	40.00
196.840	1.70	12.15	26.91	37.40	24.34	19.16	43.50
395.690	2.52	14.91	26.80	32.60	23.23	22.77	46.00
*453.890	2.76	16.23	26.71	37.60	29.88	16.12	46.00
481.050	2.87	16.86	26.66	34.80	27.86	18.14	46.00
588.720	3.31	18.63	26.50	32.20	27.65	18.35	46.00

Vertical:

*34.850	1.04	7.60	26.85	42.60	24.38	15.62	40.00
64.920	1.16	7.35	26.86	40.80	22.44	17.56	40.00
193.930	1.69	12.28	26.91	40.60	27.66	15.84	43.50
339.430	2.29	13.72	26.89	35.00	24.12	21.88	46.00
450.980	2.74	16.17	26.71	35.20	27.40	18.60	46.00
502.390	2.96	17.34	26.63	31.40	25.07	20.93	46.00

Note:

1. All Readings below 1GHz are Quasi-Peak, above are average value.
2. “ * ”, means this data is the worst emission level.
3. Emission = Reading Level + Probe Factor + Cable loss.- PreAMP.

Product : WLAN PCMCIA CARD
 Test Item : General Radiated Emission Data
 Test Mode : Channel 11(1Mbps)

Freq.	Cable Loss	Probe Factor	PreAMP	Reading Level	Emission Level	Margin	Limit
MHz	dB	dB/m	dB	dBuV	dBuV/m	dB	dBuV/m

Horizontal:

68.800	1.18	7.46	26.86	37.20	18.97	21.03	40.00
165.800	1.58	13.58	26.90	30.20	18.46	25.04	43.50
298.690	2.12	12.90	26.95	32.00	20.07	25.93	46.00
430.610	2.66	15.70	26.74	32.40	24.01	21.99	46.00
503.360	2.96	17.36	26.63	32.20	25.89	20.11	46.00
*583.870	3.29	18.56	26.50	31.20	26.55	19.45	46.00

Vertical:

* 49.400	1.10	7.43	26.86	39.00	20.67	19.33	40.00
146.400	1.50	13.93	26.89	31.20	19.73	23.77	43.50
227.880	1.83	12.25	26.92	35.80	22.96	23.04	46.00
344.280	2.31	13.82	26.88	32.00	21.25	24.75	46.00
480.080	2.86	16.84	26.67	31.40	24.44	21.56	46.00
575.140	3.26	18.43	26.52	30.80	25.96	20.04	46.00

Note:

1. All Readings below 1GHz are Quasi-Peak, above are average value.
2. “ * ”, means this data is the worst emission level.
3. Emission = Reading Level + Probe Factor + Cable loss.- PreAMP.

Product : WLAN PCMCIA CARD
 Test Item : General Radiated Emission Data
 Test Site : Chamber
 Test Mode : Channel 1(11Mbps)

Freq.	Cable Loss	Probe Factor	PreAMP	Reading Level	Emission Level	Margin	Limit
MHz	dB	dB/m	dB	dBuV	dBuV/m	dB	dBuV/m

Horizontal:

51.340	1.10	7.47	26.86	37.60	19.32	20.68	40.00
145.430	1.49	13.80	26.89	31.40	19.80	23.70	43.50
300.630	2.13	12.92	26.95	33.60	21.70	24.30	46.00
400.540	2.54	15.00	26.79	34.60	25.35	20.65	46.00
472.320	2.83	16.66	26.68	36.00	28.81	17.19	46.00
*588.720	3.31	18.63	26.50	34.20	29.65	16.35	46.00

Vertical:

* 54.250	1.12	7.38	26.86	41.80	23.44	16.56	40.00
194.900	1.69	12.24	26.91	37.60	24.62	18.88	43.50
330.700	2.25	13.56	26.90	38.00	26.91	19.09	46.00
451.950	2.75	16.19	26.71	35.80	28.03	17.97	46.00
587.750	3.31	18.62	26.50	33.00	28.43	17.57	46.00
744.890	3.95	21.23	26.25	30.00	28.93	17.07	46.00

Note:

1. All Readings below 1GHz are Quasi-Peak, above are average value.
2. “ * ”, means this data is the worst emission level.
3. Emission = Reading Level + Probe Factor + Cable loss.- PreAMP.

Product : WLAN PCMCIA CARD
 Test Item : General Radiated Emission Data
 Test Site : Chamber
 Test Mode : Channel 6(11Mbps)

Freq.	Cable	Probe	PreAMP	Reading	Emission	Margin	Limit
MHz	Loss	Factor	dB	Level	Level	dB	dBuV/m
	dB	dB/m		dBuV	dBuV/m		

Horizontal:

66.860	1.17	7.40	26.86	39.00	20.71	19.29	40.00
198.780	1.71	12.06	26.91	35.60	22.45	21.05	43.50
299.660	2.12	12.90	26.95	33.60	21.67	24.33	46.00
454.860	2.76	16.26	26.71	37.60	29.91	16.09	46.00
571.260	3.24	18.37	26.52	32.40	27.48	18.52	46.00
* 745.860	3.96	21.24	26.25	34.00	32.95	13.05	46.00

Vertical:

49.400	1.10	7.43	26.86	39.20	20.87	19.13	40.00
149.310	1.51	14.20	26.89	33.60	22.41	21.09	43.50
226.910	1.82	12.25	26.92	32.20	19.35	26.65	46.00
323.910	2.22	13.41	26.91	37.00	25.72	20.28	46.00
471.350	2.83	16.64	26.68	32.00	24.78	21.22	46.00
*587.750	3.31	18.62	26.50	33.00	28.43	17.57	46.00

Note:

1. All Readings below 1GHz are Quasi-Peak, above are average value.
2. “ * ”, means this data is the worst emission level.
3. Emission = Reading Level + Probe Factor + Cable loss.- PreAMP.

Product : WLAN PCMCIA CARD
 Test Item : General Radiated Emission Data
 Test Site : Chamber
 Test Mode : Channel 11(11Mbps)

Freq.	Cable	Probe	PreAMP	Reading	Emission	Margin	Limit
MHz	Loss	Factor	Level	Level	Level	dB	dBuV/m
	dB	dB/m	dB	dBuV	dBuV/m		

Horizontal:

62.980	1.15	7.29	26.86	39.40	20.98	19.02	40.00
145.430	1.49	13.80	26.89	31.40	19.80	23.70	43.50
300.630	2.13	12.92	26.95	33.60	21.70	24.30	46.00
397.630	2.53	14.95	26.80	31.80	22.48	23.52	46.00
* 482.020	2.87	16.88	26.66	35.60	28.69	17.31	46.00
583.870	3.29	18.56	26.50	33.00	28.35	17.65	46.00

Vertical:

49.400	1.10	7.43	26.86	39.20	20.87	19.13	40.00
148.340	1.50	14.20	26.89	31.60	20.41	23.09	43.50
229.820	1.84	12.27	26.92	33.60	20.78	25.22	46.00
338.460	2.28	13.70	26.89	35.80	24.89	21.11	46.00
470.380	2.82	16.61	26.68	32.00	24.76	21.24	46.00
*586.780	3.30	18.60	26.50	33.00	28.41	17.59	46.00

Note:

1. All Readings below 1GHz are Quasi-Peak, above are average value.
2. “ * ”, means this data is the worst emission level.
3. Emission = Reading Level + Probe Factor + Cable loss.- PreAMP.

5.7. Test Result of Band Edge

Product : WLAN PCMCIA CARD
 Test Item : Band Edge Data
 Test Site : No.1 OATS
 Test Mode : Channel 1

Channel No.	Frequency (MHz)	Required Limit (dBc)	Result
1 (1Mbps)	<2400	>20	Pass

Figure Channel 1: 1Mbps (Horizontal)

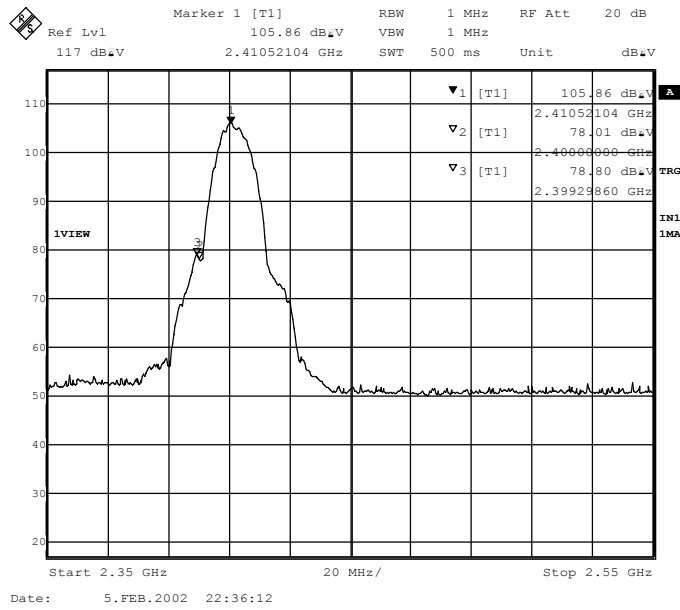
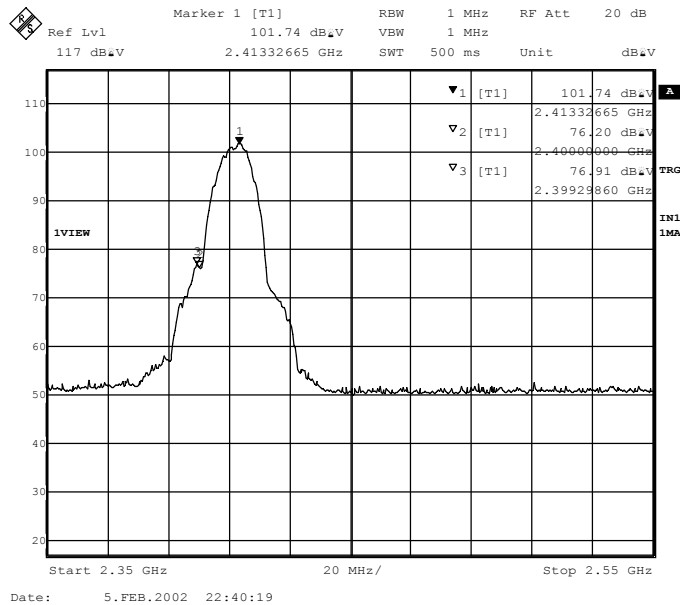

Figure Channel 1: 1Mbps (Vertical)



Product : WLAN PCMCIA CARD
 Test Item : Band Edge Data
 Test Site : No.1 OATS
 Test Mode : Channel 1

Channel No.	Frequency (MHz)	Required Limit (dBc)	Result
1 (11Mbps)	<2400	>20	Pass

Figure Channel 1:11Mbps (Horizontal)

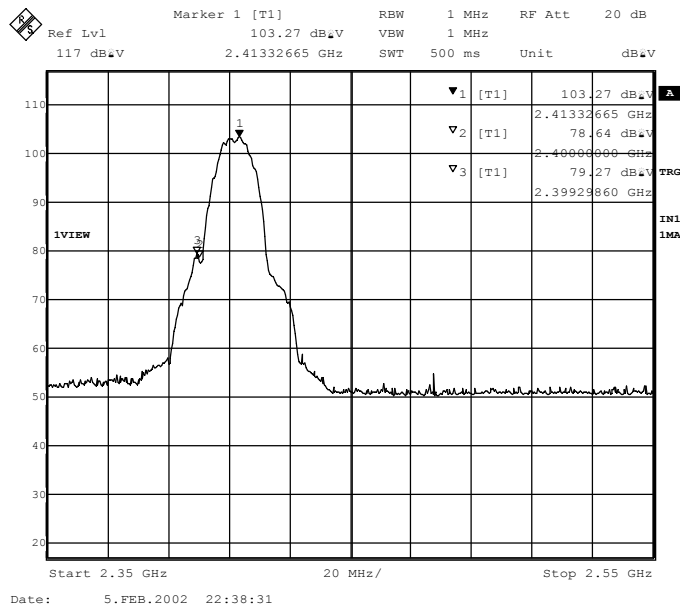
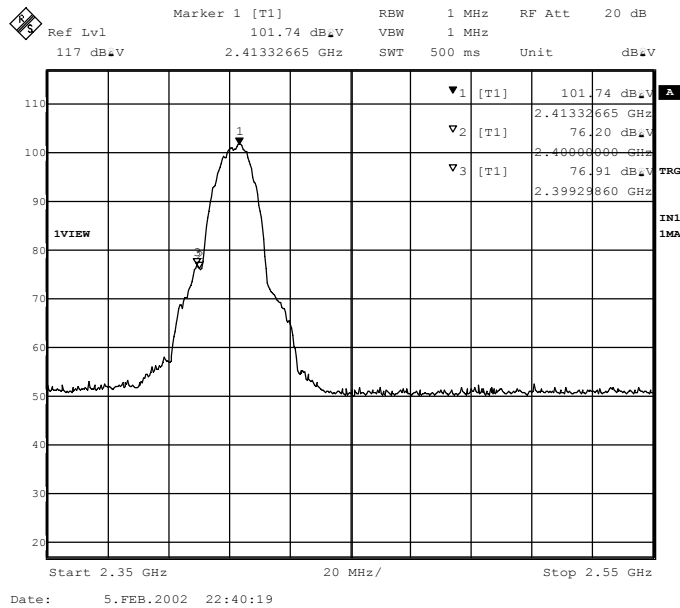

Figure Channel 1:11Mbps (Vertical)



Product : WLAN PCMCIA CARD
 Test Item : Band Edge Data
 Test Site : No.1 OATS
 Test Mode : Channel 11

Band Edge-1 Mbps (Horizontal)

Frequency (MHz).	Reading (dBuV)	Measure (dBuV/m)	Result
2484.27	53.62	52.07	Pass

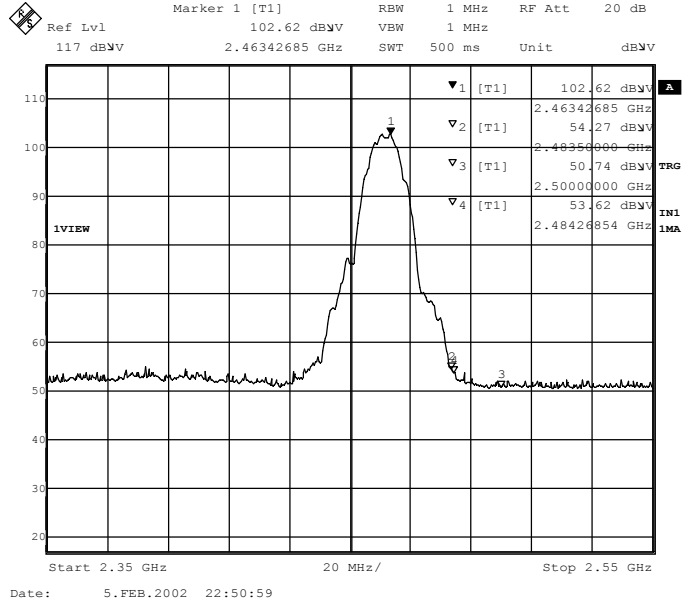

Band Edge-1 Mbps (Vertical)

Frequency (MHz).	Reading (dBuV)	Measure (dBuV/m)	Result
2484.67	52.81	51.26	Pass

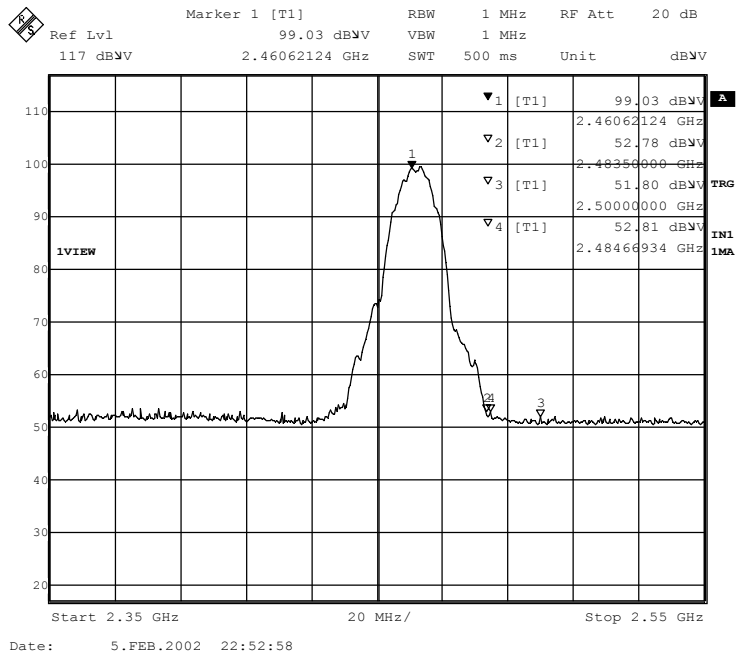

Band Edge-11 Mbps (Horizontal)

Frequency (MHz).	Reading (dBuV)	Measure (dBuV/m)	Result
2485.07	54.2	52.65	Pass

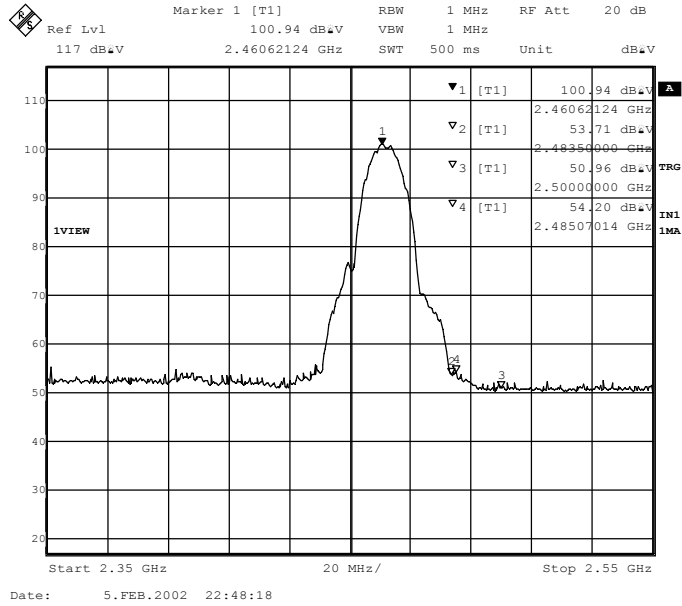

Band Edge-11 Mbps (Vertical)

Frequency (MHz).	Reading (dBuV)	Measure (dBuV/m)	Result
2484.67	53.45	51.9	Pass

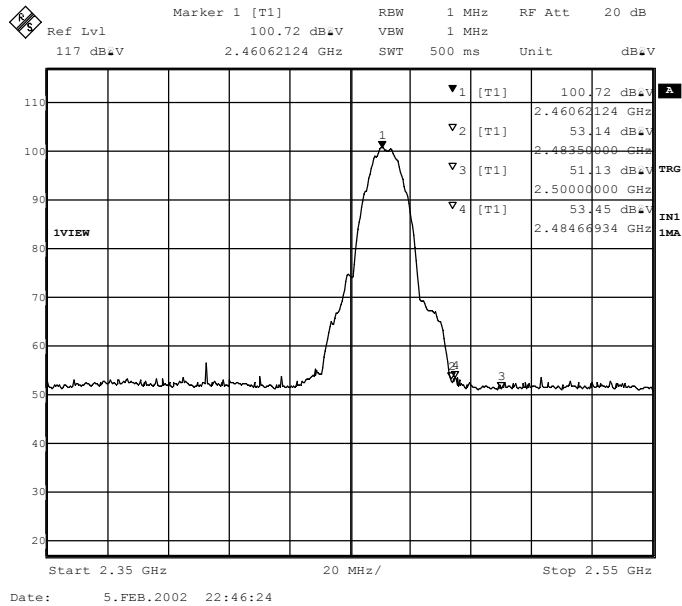

6. Occupied Bandwidth

6.1. Test Equipment

The following test equipments are used during the radiated emission tests:

	Equipment	Manufacturer	Model No./Serial No.	Last Cal.
X	Spectrum Analyzer	Advantest	R3272 / 72421194	May, 2001
X	Horn Antenna	EM	EM6917 / 103325	May, 2001

Note: 1. All equipment upon which need to calibrated are with calibration period of 1 year.
 2. Mark "X" test instruments are used to measure the final test results.

6.2. Test Setup

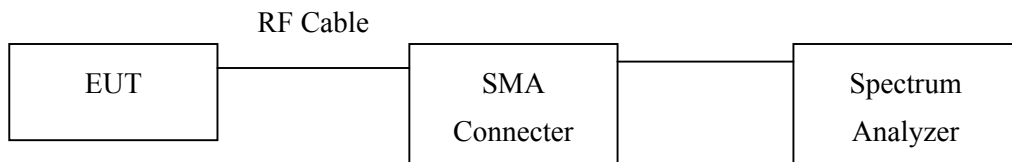

6.3. Test Condition

Standard Temperature and Humidity, Standard Test Voltage

6.4. Standard Requirement

The minimum bandwidth shall be at least 500kHz.

6.5. Test Result of Occupied Bandwidth

Product : WLAN PCMCIA CARD
 Test Item : Occupied Bandwidth Data
 Test Site : No.1 OATS
 Test Mode : Channel 1

Channel No.	Frequency (MHz)	Measurement Level (kHz)	Required Limit (kHz)	Result
1 (1Mbps)	2410.5	11300	>500	Pass
1 (11Mbps)	2410.5	11400	>500	Pass

Figure Channel 1: 1Mbps

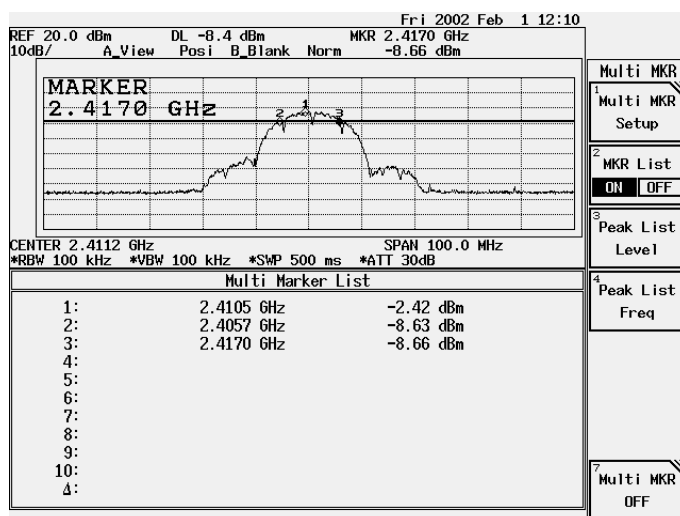
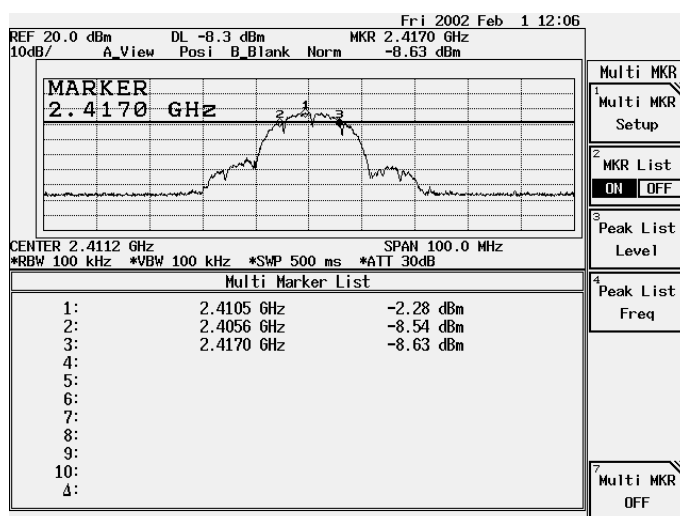

Figure Channel 1: 11Mbps



Product : WLAN PCMCIA CARD
 Test Item : Occupied Bandwidth Data
 Test Site : No.1 OATS
 Test Mode : Channel 6

Channel No.	Frequency (MHz)	Measurement Level (kHz)	Required Limit (kHz)	Result
6 (1Mbps)	2435.5	11400	>500	Pass
6 (11Mbps)	2435.5	11400	>500	Pass

Figure Channel 6: 1Mbps

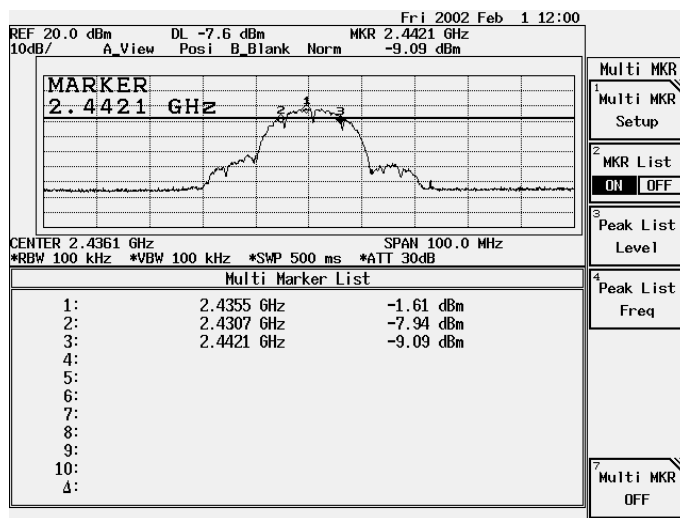
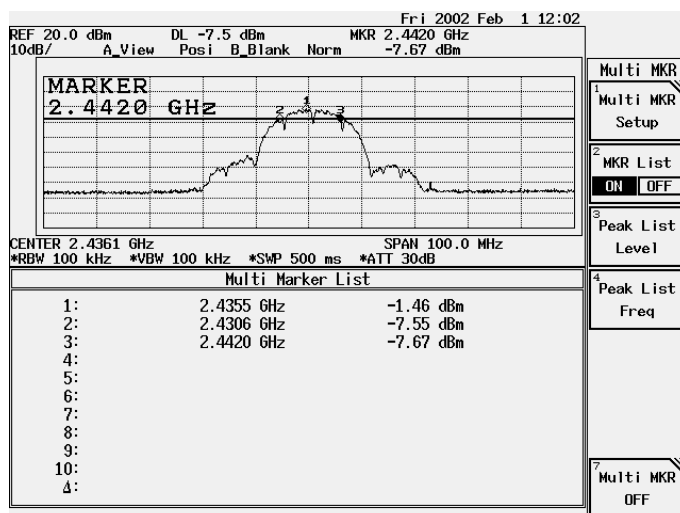

Figure Channel 6: 11Mbps



Product : WLAN PCMCIA CARD
 Test Item : Occupied Bandwidth Data
 Test Site : No.1 OATS
 Test Mode : Channel 11

Channel No.	Frequency (MHz)	Measurement Level (kHz)	Required Limit (kHz)	Result
11 (1Mbps)	2460.5	11300	>500	Pass
11 (11Mbps)	2463.85	11400	>500	Pass

Figure Channel 11: 1Mbps

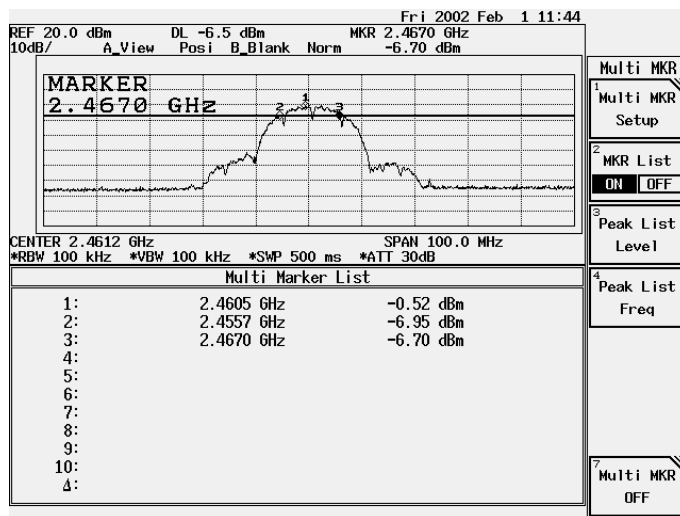
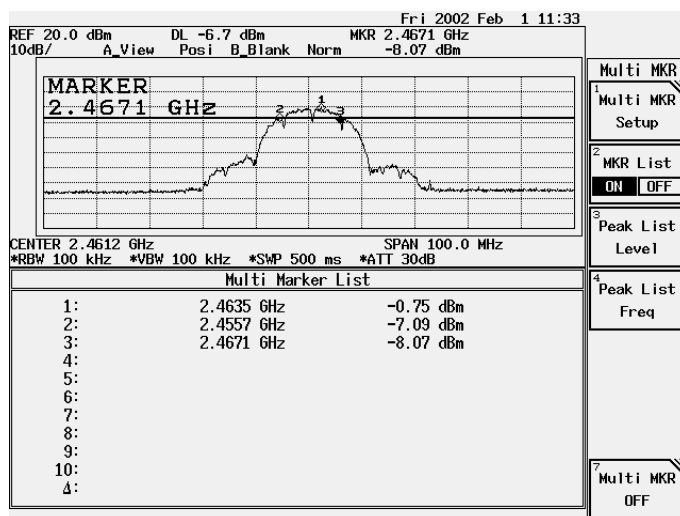

Figure Channel 11: 11Mbps



7. Transmitter Power Density

7.1. Test Equipment

The following test equipments are used during the radiated emission tests:

	Equipment	Manufacturer	Model No./Serial No.	Last Cal.
X	Spectrum Analyzer	Advantest	R3272 / 72421194	May, 2001
X	Attenuator	HP		May, 2001
X	Horn Antenna	EM	EM6917 / 103325	May, 2001

Note: 1. All equipment upon which need to calibrated are with calibration period of 1 year.
 2. Mark "X" test instruments are used to measure the final test results.

7.2. Test Setup

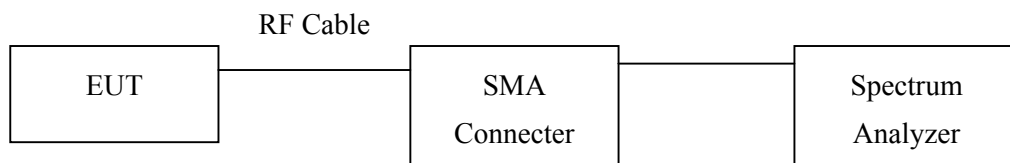

7.3. Test Condition

Standard Temperature and Humidity, Standard Test Voltage

7.4. Standard Requirement

The transmitted power density averaged over any 1 second interval shall not be greater +8dBm in any 3kHz bandwidth.

7.5. Test Result of Transmitter Power Density

Product : WLAN PCMCIA CARD
 Test Item : Transmitter Power Density Data
 Test Site : No.1 OATS
 Test Mode : Normal Operation

Channel No.	Frequency (MHz)	Measurement Level (dBm)	Required Limit (dBm)	Result
1 (1Mbps)	2411.277	-16.53dBm	< 8dBm	Pass
1 (11Mbps)	2409.27	-17.61dBm	< 8dBm	Pass

Figure Channel 1:1Mbps

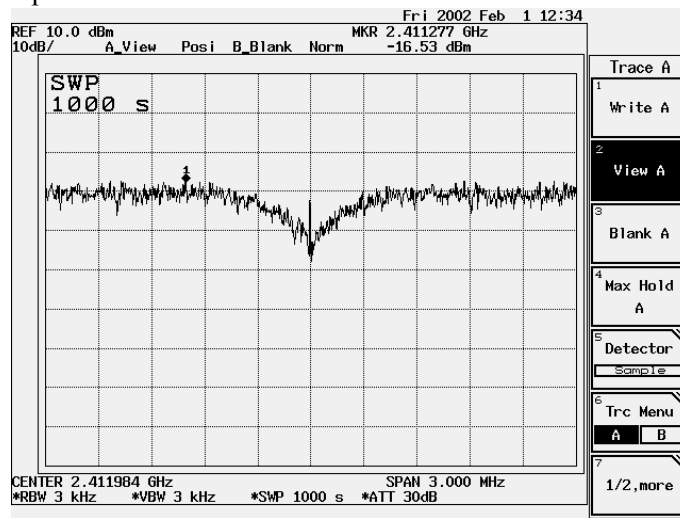
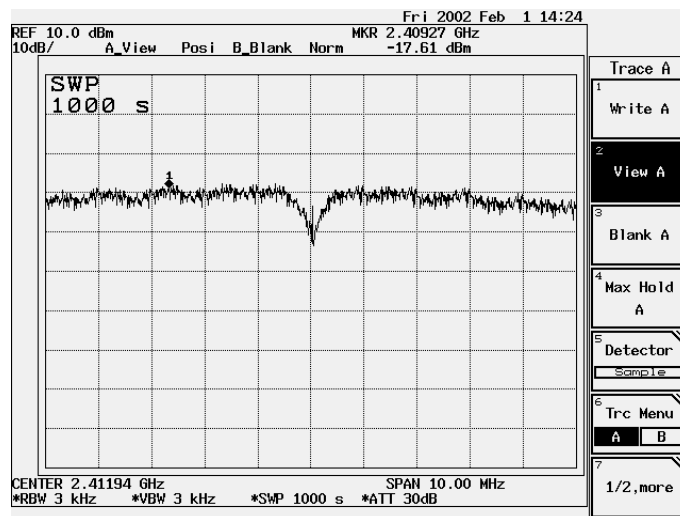

Figure Channel 1:11Mbps



Product : WLAN PCMCIA CARD
 Test Item : Transmitter Power Density Data
 Test Site : No.1 OATS
 Test Mode : Normal Operation

Channel No.	Frequency (MHz)	Measurement Level (dBm)	Required Limit (dBm)	Result
6 (1Mbps)	2436.354	-15.32dBm	< 8dBm	Pass
6 (11Mbps)	2436.276	-16.54dBm	< 8dBm	Pass

Figure Channel 6:1Mbps

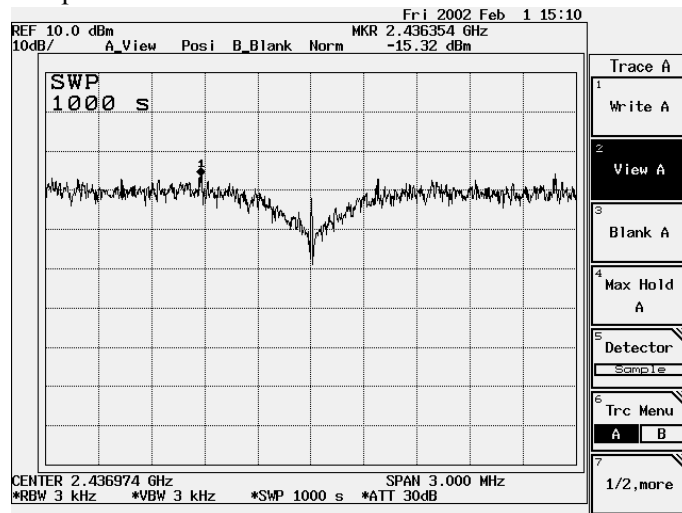
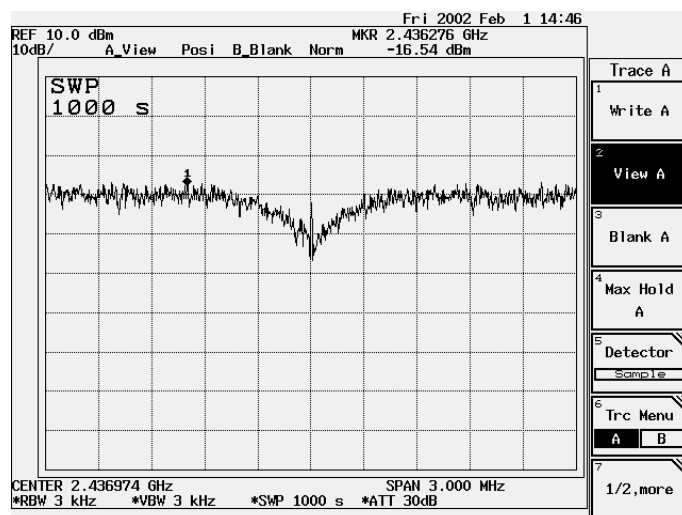

Figure Channel 6:11Mbps



Product : WLAN PCMCIA CARD
 Test Item : Transmitter Power Density Data
 Test Site : No.1 OATS
 Test Mode : Normal Operation

Channel No.	Frequency (MHz)	Measurement Level (dBm)	Required Limit (dBm)	Result
11 (1Mbps)	2461.355	-14.55dBm	< 8dBm	Pass
11 (11Mbps)	2461.277	-16.11dBm	< 8dBm	Pass

Figure Channel 11:1Mbps

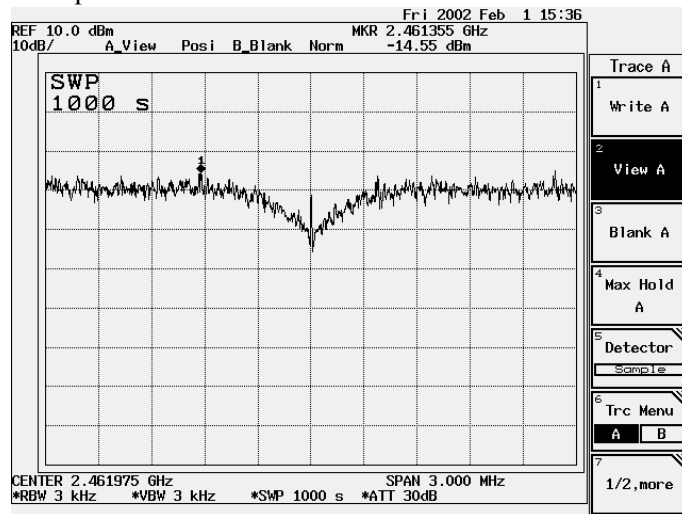
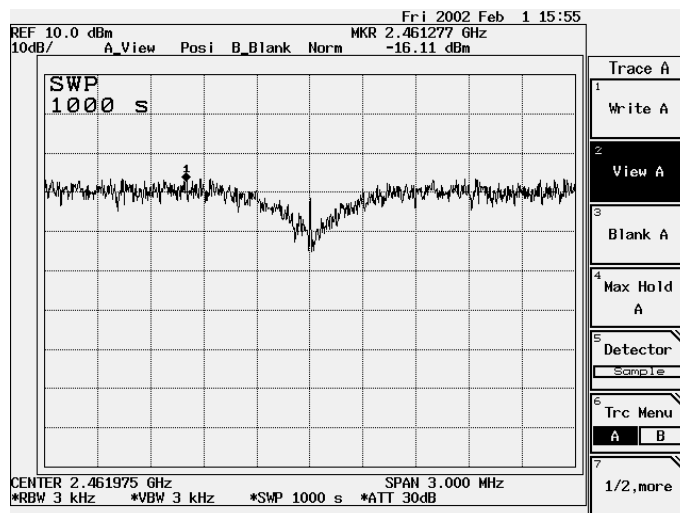

Figure Channel 11:11Mbps



8. Processing Gain

8.1. Test Condition

Standard Temperature and Humidity, Standard Test Voltage

8.2. Minimum Standard

The processing gain shall be at least 10 dB.

8.3. Method of Measurement

The processing gain of this spread spectrum was measured the CW jamming method. The Section 9.1 illustrates the measurement setup. The output power of the spread spectrum transmitter is fixed and the output power of jammer is adjustable. The frequency of jammer was stepped through the pass band of nominal channel in 50kHz steps. In each frequency step of the jammer, the output power of jammer is adjusted to cause the Bit Error Rate (BER) to be 1.0×10^{-6} . The power levels are recorded to calculate the J/S as shown in Table 1.

8.4. Calculation of Processing Gain:

The processing gain was determined by measuring the jamming margin of the EUT and using the following formula:

$$G_p = (S/N)_o + M_j + L_{sys}$$

Where $(S/N)_o$ is the required signal to noise ratio at the receiver output

M_j is the jammer to signal ratio (J/S)

L_{sys} is the system loss

The $(S/N)_o$ is calculated from:

$$P_e = 1/2 \exp(-1/2(S/N)_o) \quad ; \quad P_e = \text{probability of error (BER)}$$

For the $P_e(\text{BER}) = 1.0 \times 10^{-6}$, the required $(S/N)_o$ is 16.4dB

From Measurement, the minimum J/S(M_j) is $\geq 8.4\text{dB}$

We assume the system loss is 2dB.

Therefore the processing gain is calculated below:

$$G_p = (S/N)_o + M_j + L_{sys} = 16.4 + (-8.4) + 2 = 10 \text{ (dB)}$$

8.5. Test Result of Processing Gain

Product : WLAN PCMCIA CARD
 Test Item : Processing Gain Data
 Test Site : No.1 OATS
 Test Mode : Normal Operation

11Mbps CHANNEL 1 Processing Gain							
Gp = (S/N)o + Mj + Lsys							
Freq. (GHz)	Gp (dB)	(S/N)o (dB)	Mj = J/S (dB)	Lsys (dB)	Jammer (dBm)	LVL (dBm)	FER %
2.4035	20	16.4	1.6	2	-38.4	8	6.2
2.40355	19.5	16.4	1.1	2	-38.9	7.5	5.1
2.4036	19.4	16.4	1	2	-39	7.4	6.3
2.40365	19	16.4	0.6	2	-39.4	7	5.6
2.4037	18.9	16.4	0.5	2	-39.5	6.9	5.1
2.40375	18.8	16.4	0.4	2	-39.6	6.8	5.2
2.4038	18.9	16.4	0.5	2	-39.5	6.9	5.0
2.40385	18.9	16.4	0.5	2	-39.5	6.9	6.6
2.4039	19	16.4	0.6	2	-39.4	7	6.3
2.40395	19.1	16.4	0.7	2	-39.3	7.1	5.6
2.404	19.5	16.4	1.1	2	-38.9	7.5	6.6
2.40405	19.8	16.4	1.4	2	-38.6	7.8	6.2
2.4041	19.6	16.4	1.2	2	-38.8	7.6	5.8
2.40415	19.5	16.4	1.1	2	-38.9	7.5	6.1
2.4042	19.6	16.4	1.2	2	-38.8	7.6	5.8
2.40425	19.4	16.4	1	2	-39	7.4	6.2
2.4043	19.3	16.4	0.9	2	-39.1	7.3	4.9
2.40435	19.3	16.4	0.9	2	-39.1	7.3	6.5
2.4044	19.2	16.4	0.8	2	-39.2	7.2	5.8
2.40445	19.1	16.4	0.7	2	-39.3	7.1	6.5
2.4045	19	16.4	0.6	2	-39.4	7	5.5
2.40455	18.6	16.4	0.2	2	-39.8	6.6	5.4
2.4046	18.5	16.4	0.1	2	-39.9	6.5	7.0
2.40465	18.1	16.4	-0.3	2	-40.3	6.1	6.2
2.4047	18.1	16.4	-0.3	2	-40.3	6.1	5.6
2.40475	18	16.4	-0.4	2	-40.4	6	5.4
2.4048	18.1	16.4	-0.3	2	-40.3	6.1	5.9
2.40485	18	16.4	-0.4	2	-40.4	6	5.9
2.4049	18	16.4	-0.4	2	-40.4	6	5.8
2.40495	18.2	16.4	-0.2	2	-40.2	6.2	6.1
2.405	18.5	16.4	0.1	2	-39.9	6.5	6.9
2.40505	18.6	16.4	0.2	2	-39.8	6.6	5.7
2.4051	18.6	16.4	0.2	2	-39.8	6.6	5.8
2.40515	18.5	16.4	0.1	2	-39.9	6.5	7.0
2.4052	18.4	16.4	0	2	-40	6.4	6.4
2.40525	18.3	16.4	-0.1	2	-40.1	6.3	5.5
2.4053	18.3	16.4	-0.1	2	-40.1	6.3	5.6
2.40535	18.2	16.4	-0.2	2	-40.2	6.2	6.2
2.4054	18.2	16.4	-0.2	2	-40.2	6.2	5.6
2.40545	18.1	16.4	-0.3	2	-40.3	6.1	5.8
2.4055	17.8	16.4	-0.6	2	-40.6	5.8	5.5
2.40555	17.4	16.4	-1	2	-41	5.4	4.8

2.4056	17.2	16.4	-1.2	2	-41.2	5.2	6.1
2.40565	17	16.4	-1.4	2	-41.4	5	6.7
2.4057	16.9	16.4	-1.5	2	-41.5	4.9	4.9

11Mbps CHANNEL 1 Processing Gain							
Gp = (S/N)o + Mj + Lsys							
Freq. (GHz)	Gp (dB)	(S/N)o (dB)	Mj = J/S (dB)	Lsys (dB)	Jammer (dBm)	LVL (dBm)	FER %
2.40575	16.8	16.4	-1.6	2	-41.6	4.8	6.3
2.4058	16.7	16.4	-1.7	2	-41.7	4.7	6.1
2.40585	16.7	16.4	-1.7	2	-41.7	4.7	5.8
2.4059	16.6	16.4	-1.8	2	-41.8	4.6	5.7
2.40595	16.7	16.4	-1.7	2	-41.7	4.7	6.5
2.406	16.7	16.4	-1.7	2	-41.7	4.7	4.8
2.40605	16.7	16.4	-1.7	2	-41.7	4.7	5.4
2.4061	16.7	16.4	-1.7	2	-41.7	4.7	6.9
2.40615	16.6	16.4	-1.8	2	-41.8	4.6	6.1
2.4062	16.4	16.4	-2	2	-42	4.4	5.9
2.40625	16.3	16.4	-2.1	2	-42.1	4.3	5.7
2.4063	16	16.4	-2.4	2	-42.4	4	5.6
2.40635	15.9	16.4	-2.5	2	-42.5	3.9	5.7
2.4064	15.7	16.4	-2.7	2	-42.7	3.7	6.2
2.40645	15.6	16.4	-2.8	2	-42.8	3.6	7.0
2.4065	15.4	16.4	-3	2	-43	3.4	7.4
2.40655	15.3	16.4	-3.1	2	-43.1	3.3	6.6
2.4066	15.3	16.4	-3.1	2	-43.1	3.3	6.2
2.40665	15.2	16.4	-3.2	2	-43.2	3.2	5.7
2.4067	15.2	16.4	-3.2	2	-43.2	3.2	6.3
2.40675	15.1	16.4	-3.3	2	-43.3	3.1	5.3
2.4068	15.1	16.4	-3.3	2	-43.3	3.1	5.2
2.40685	15.1	16.4	-3.3	2	-43.3	3.1	4.7
2.4069	15	16.4	-3.4	2	-43.4	3	5.8
2.40695	14.8	16.4	-3.6	2	-43.6	2.8	6.2
2.407	14.7	16.4	-3.7	2	-43.7	2.7	5.8
2.40705	14.5	16.4	-3.9	2	-43.9	2.5	6.5
2.4071	14.4	16.4	-4	2	-44	2.4	5.5
2.40715	14.3	16.4	-4.1	2	-44.1	2.3	6.3
2.4072	14.2	16.4	-4.2	2	-44.2	2.2	6.3
2.40725	14.1	16.4	-4.3	2	-44.3	2.1	6.7
2.4073	14.1	16.4	-4.3	2	-44.3	2.1	6.4
2.40735	14	16.4	-4.4	2	-44.4	2	6.6
2.4074	14	16.4	-4.4	2	-44.4	2	5.8
2.40745	13.9	16.4	-4.5	2	-44.5	1.9	6.2
2.4075	13.8	16.4	-4.6	2	-44.6	1.8	6.3
2.40755	13.7	16.4	-4.7	2	-44.7	1.7	5.9
2.4076	13.6	16.4	-4.8	2	-44.8	1.6	6.9
2.40765	13.5	16.4	-4.9	2	-44.9	1.5	6.4
2.4077	13.4	16.4	-5	2	-45	1.4	5.8
2.40775	13.3	16.4	-5.1	2	-45.1	1.3	7.1
2.4078	13.2	16.4	-5.2	2	-45.2	1.2	7.2
2.40785	13.1	16.4	-5.3	2	-45.3	1.1	6.3
2.4079	13.1	16.4	-5.3	2	-45.3	1.1	6.6
2.40795	13.1	16.4	-5.3	2	-45.3	1.1	6.5

11Mbps CHANNEL 1 Processing Gain							
Gp = (S/N)o + Mj + Lsys							
Freq. (GHz)	Gp (dB)	(S/N)o (dB)	Mj = J/S (dB)	Lsys (dB)	Jammer (dBm)	LVL (dBm)	FER %
2.408	13.1	16.4	-5.3	2	-45.3	1.1	5.8
2.40805	13.1	16.4	-5.3	2	-45.3	1.1	6.8
2.4081	13.1	16.4	-5.3	2	-45.3	1.1	6.5
2.40815	13.2	16.4	-5.2	2	-45.2	1.2	5.5
2.4082	13.1	16.4	-5.3	2	-45.3	1.1	4.8
2.40825	12.9	16.4	-5.5	2	-45.5	1.9	6.1
2.4083	12.7	16.4	-5.7	2	-45.7	0.7	5.2
2.40835	12.7	16.4	-5.7	2	-45.7	0.7	6.3
2.4084	12.5	16.4	-5.9	2	-45.9	0.5	6.7
2.40845	12.4	16.4	-6	2	-46	0.4	7.2
2.4085	12.4	16.4	-6	2	-46	0.4	6.8
2.40855	12.3	16.4	-6.1	2	-46.1	0.3	7.1
2.4086	12.3	16.4	-6.1	2	-46.1	0.3	5.1
2.40865	12.3	16.4	-6.1	2	-46.1	0.3	5.8
2.4087	12.2	16.4	-6.2	2	-46.2	0.2	6.2
2.40875	12.3	16.4	-6.1	2	-46.1	0.3	7.2
2.4088	12.2	16.4	-6.2	2	-46.2	0.2	6.9
2.40885	12.2	16.4	-6.2	2	-46.2	0.2	6.8
2.4089	12	16.4	-6.4	2	-46.4	0	6.3
2.40895	11.9	16.4	-6.5	2	-46.5	-0.1	6.6
2.409	11.7	16.4	-6.7	2	-46.7	-0.3	6.9
2.40905	11.6	16.4	-6.8	2	-46.8	-0.4	6.9
2.4091	11.4	16.4	-7	2	-47	-0.6	6.6
2.40915	11.4	16.4	-7	2	-47	-0.6	5.8
2.4092	11.3	16.4	-7.1	2	-47.1	-0.7	7.5
2.40925	11.2	16.4	-7.2	2	-47.2	-0.8	6.8
2.4093	11.2	16.4	-7.2	2	-47.2	-0.8	6.7
2.40935	11.2	16.4	-7.2	2	-47.2	-0.8	6.7
2.4094	11.3	16.4	-7.1	2	-47.1	-0.7	7.6
2.40945	11.3	16.4	-7.1	2	-47.1	-0.7	6.9
2.4095	11.3	16.4	-7.1	2	-47.1	-0.7	6.3
2.40955	11.4	16.4	-7	2	-47	-0.6	6.9
2.4096	11.4	16.4	-7	2	-47	-0.6	7.4
2.40965	11.4	16.4	-7	2	-47	-0.6	7.3
2.4097	11.3	16.4	-7.1	2	-47.1	-0.7	6.6
2.40975	11.3	16.4	-7.1	2	-47.1	-0.7	5.8
2.4098	11.1	16.4	-7.3	2	-47.3	-0.9	6.7
2.40985	11.1	16.4	-7.3	2	-47.3	-0.9	7.6
2.4099	11	16.4	-7.4	2	-47.4	-1	6.5
2.40995	11	16.4	-7.4	2	-47.4	-1	7.4
2.41	10.9	16.4	-7.5	2	-47.5	-1.1	6.6
2.41005	11	16.4	-7.4	2	-47.4	-1	6.8
2.4101	11	16.4	-7.4	2	-47.4	-1	6.6
2.41015	11.1	16.4	-7.3	2	-47.3	-0.9	7.6
2.4102	11.2	16.4	-7.2	2	-47.2	-0.8	7.7

11Mbps CHANNEL 1 Processing Gain							
Gp = (S/N)o + Mj + Lsys							
Freq.	Gp	(S/N)o	Mj = J/S	Lsys	Jammer	LVL	FER
(GHz)	(dB)	(dB)	(dB)	(dB)	(dBm)	(dBm)	%
2.41025	11.3	16.4	-7.1	2	-47.1	-0.7	7.5
2.4103	11.3	16.4	-7.1	2	-47.1	-0.7	6.3
2.41035	11.4	16.4	-7	2	-47	-0.6	7.8
2.4104	11.3	16.4	-7.1	2	-47.1	-0.7	6.4
2.41045	11.3	16.4	-7.1	2	-47.1	-0.7	6.5
2.4105	11.3	16.4	-7.1	2	-47.1	-0.7	7.3
2.41055	11.2	16.4	-7.2	2	-47.2	-0.8	6.5
2.4106	11.2	16.4	-7.2	2	-47.2	-0.8	6.6
2.41065	11.3	16.4	-7.1	2	-47.1	-0.7	7.6
2.4107	11.3	16.4	-7.1	2	-47.1	-0.7	7.2
2.41075	11.3	16.4	-7.1	2	-47.1	-0.7	6.8
2.4108	11.4	16.4	-7	2	-47	-0.6	6.2
2.41085	11.5	16.4	-6.9	2	-46.9	-0.5	6.5
2.4109	11.6	16.4	-6.8	2	-46.8	-0.4	6.9
2.41095	11.6	16.4	-6.8	2	-46.8	-0.4	6.7
2.411	11.6	16.4	-6.8	2	-46.8	-0.4	7.8
2.41105	11.4	16.4	-7	2	-47	-0.6	7.2
2.4111	11.5	16.4	-6.9	2	-46.9	-0.5	7.2
2.41115	11.6	16.4	-6.8	2	-46.8	-0.4	7.4
2.4112	11.5	16.4	-6.9	2	-46.9	-0.5	6.3
2.41125	11.5	16.4	-6.9	2	-46.9	-0.5	6.6
2.4113	11.5	16.4	-6.9	2	-46.9	-0.5	6.9
2.41135	11.4	16.4	-7	2	-47	-0.6	2.1
2.4114	11.4	16.4	-7	2	-47	-0.6	3.6
2.41145	11.4	16.4	-7	2	-47	-0.6	6.7
2.4115	11.4	16.4	-7	2	-47	-0.6	7.3
2.41155	11.4	16.4	-7	2	-47	-0.6	6.6
2.4116	11.6	16.4	-6.8	2	-46.8	-0.4	7.2
2.41165	11.6	16.4	-6.8	2	-46.8	-0.4	6.6
2.4117	11.5	16.4	-6.9	2	-46.9	-0.5	6.0
2.41175	11.4	16.4	-7	2	-47	-0.6	6.8
2.4118	11.2	16.4	-7.2	2	-47.2	-0.8	5.8
2.41185	11.1	16.4	-7.3	2	-47.3	-0.9	7.1
2.4119	11	16.4	-7.4	2	-47.4	-1	5.6
2.41195	10.8	16.4	-7.6	2	-47.6	-1.2	6.6
2.412	10.9	16.4	-7.5	2	-47.5	-1.1	6.1
2.41205	10.9	16.4	-7.5	2	-47.5	-1.1	3.4
2.4121	11.1	16.4	-7.3	2	-47.3	-0.9	3.5
2.41215	11.4	16.4	-7	2	-47	-0.6	6.5
2.4122	11.5	16.4	-6.9	2	-46.9	-0.5	5.4
2.41225	11.6	16.4	-6.8	2	-46.8	-0.4	7.5
2.4123	11.7	16.4	-6.7	2	-46.7	-0.3	4.5
2.41235	11.7	16.4	-6.7	2	-46.7	-0.3	7.2
2.4124	11.7	16.4	-6.7	2	-46.7	-0.3	6.7
2.41245	11.6	16.4	-6.8	2	-46.8	-0.4	5.9

11Mbps CHANNEL 1 Processing Gain							
Gp = (S/N)o + Mj + Lsys							
Freq. (GHz)	Gp (dB)	(S/N)o (dB)	Mj = J/S (dB)	Lsys (dB)	Jammer (dBm)	LVL (dBm)	FER %
2.4125	11.6	16.4	-6.8	2	-46.8	-0.4	5.6
2.41255	11.6	16.4	-6.8	2	-46.8	-0.4	6.2
2.4126	11.6	16.4	-6.8	2	-46.8	-0.4	5.5
2.41265	11.6	16.4	-6.8	2	-46.8	-0.4	5.6
2.4127	11.7	16.4	-6.7	2	-46.7	-0.3	5.7
2.41275	11.6	16.4	-6.8	2	-46.8	-0.4	7.3
2.4128	11.8	16.4	-6.6	2	-46.6	-0.2	7.2
2.41285	11.8	16.4	-6.6	2	-46.6	-0.2	7.1
2.4129	11.8	16.4	-6.6	2	-46.6	-0.2	6.3
2.41295	11.9	16.4	-6.5	2	-46.5	-0.1	7.7
2.413	11.8	16.4	-6.6	2	-46.6	-0.2	5.9
2.41305	11.8	16.4	-6.6	2	-46.6	-0.2	6.5
2.4131	11.8	16.4	-6.6	2	-46.6	-0.2	7.5
2.41315	11.7	16.4	-6.7	2	-46.7	-0.3	6.3
2.4132	11.6	16.4	-6.8	2	-46.8	-0.4	6.6
2.41325	11.7	16.4	-6.7	2	-46.7	-0.3	6.7
2.4133	11.6	16.4	-6.8	2	-46.8	-0.4	6.8
2.41335	11.6	16.4	-6.8	2	-46.8	-0.4	3.8
2.4134	11.6	16.4	-6.8	2	-46.8	-0.4	6.9
2.41345	11.6	16.4	-6.8	2	-46.8	-0.4	7.5
2.4135	11.6	16.4	-6.8	2	-46.8	-0.4	7.1
2.41355	11.6	16.4	-6.8	2	-46.8	-0.4	6.7
2.4136	11.7	16.4	-6.7	2	-46.7	-0.3	7.8
2.41365	11.7	16.4	-6.7	2	-46.7	-0.3	7.1
2.4137	11.7	16.4	-6.7	2	-46.7	-0.3	6.9
2.41375	11.7	16.4	-6.7	2	-46.7	-0.3	7.3
2.4138	11.6	16.4	-6.8	2	-46.8	-0.4	5.7
2.41385	11.5	16.4	-6.9	2	-46.9	-0.5	6.4
2.4139	11.4	16.4	-7	2	-47	-0.6	7.5
2.41395	11.3	16.4	-7.1	2	-47.1	-0.7	7.5
2.414	11.2	16.4	-7.2	2	-47.2	-0.8	6.3
2.41405	11.2	16.4	-7.2	2	-47.2	-0.8	6.9
2.4141	11.2	16.4	-7.2	2	-47.2	-0.8	6.4
2.41415	11.2	16.4	-7.2	2	-47.2	-0.8	5.6
2.4142	11.3	16.4	-7.1	2	-47.1	-0.7	6.6
2.41425	11.4	16.4	-7	2	-47	-0.6	6.7
2.4143	11.5	16.4	-6.9	2	-46.9	-0.5	7.5
2.41435	11.5	16.4	-6.9	2	-46.9	-0.5	6.3
2.4144	11.5	16.4	-6.9	2	-46.9	-0.5	6.5
2.41445	11.5	16.4	-6.9	2	-46.9	-0.5	7.4
2.4145	11.4	16.4	-7	2	-47	-0.6	6.6
2.41455	11.3	16.4	-7.1	2	-47.1	-0.7	6.2
2.4146	11.3	16.4	-7.1	2	-47.1	-0.7	6.5
2.41465	11.3	16.4	-7.1	2	-47.1	-0.7	7.3
2.4147	11.3	16.4	-7.1	2	-47.1	-0.7	7.3

11Mbps CHANNEL 1 Processing Gain							
Gp = (S/N)o + Mj + Lsys							
Freq. (GHz)	Gp (dB)	(S/N)o (dB)	Mj = J/S (dB)	Lsys (dB)	Jammer (dBm)	LVL (dBm)	FER %
2.41475	11.4	16.4	-7	2	-47	-0.6	7.1
2.4148	11.5	16.4	-6.9	2	-46.9	-0.5	7.6
2.41485	11.6	16.4	-6.8	2	-46.8	-0.4	7.5
2.4149	11.6	16.4	-6.8	2	-46.8	-0.4	6.2
2.41495	11.8	16.4	-6.6	2	-46.6	-0.2	6.5
2.415	11.9	16.4	-6.5	2	-46.5	-0.1	7.2
2.41505	12	16.4	-6.4	2	-46.4	0	7.1
2.4151	12.1	16.4	-6.3	2	-46.3	0.1	6.5
2.41515	12.1	16.4	-6.3	2	-46.3	0.1	6.3
2.4152	12.1	16.4	-6.3	2	-46.3	0.1	6.4
2.41525	12.1	16.4	-6.3	2	-46.3	0.1	6.7
2.4153	12.1	16.4	-6.3	2	-46.3	0.1	6.5
2.41535	12.1	16.4	-6.3	2	-46.3	0.1	7.2
2.4154	12.1	16.4	-6.3	2	-46.3	0.1	6.8
2.41545	12.1	16.4	-6.3	2	-46.3	0.1	6.1
2.4155	12.1	16.4	-6.3	2	-46.3	0.1	5.3
2.41555	12.3	16.4	-6.1	2	-46.1	0.3	7.5
2.4156	12.4	16.4	-6	2	-46	0.4	7.1
2.41565	12.5	16.4	-5.9	2	-45.9	0.5	7.4
2.4157	12.6	16.4	-5.8	2	-45.8	0.6	5.9
2.41575	12.7	16.4	-5.7	2	-45.7	0.7	6.2
2.4158	12.8	16.4	-5.6	2	-45.6	0.8	6.9
2.41585	12.8	16.4	-5.6	2	-45.6	0.8	7.1
2.4159	12.8	16.4	-5.6	2	-45.6	0.8	6.8
2.41595	12.8	16.4	-5.6	2	-45.6	0.8	7.3
2.416	12.8	16.4	-5.6	2	-45.6	0.8	7.7
2.41605	12.8	16.4	-5.6	2	-45.6	0.8	6.4
2.4161	12.9	16.4	-5.5	2	-45.5	0.9	5.8
2.41615	12.9	16.4	-5.5	2	-45.5	0.9	6.7
2.4162	13	16.4	-5.4	2	-45.4	1	5.7
2.41625	13.1	16.4	-5.3	2	-45.3	1.1	6.8
2.4163	13.2	16.4	-5.2	2	-45.2	1.2	6.3
2.41635	13.4	16.4	-5	2	-45	1.4	6.7
2.4164	13.6	16.4	-4.8	2	-44.8	1.6	7.8
2.41645	13.6	16.4	-4.8	2	-44.8	1.6	6.3
2.4165	13.6	16.4	-4.8	2	-44.8	1.6	5.4
2.41655	13.7	16.4	-4.7	2	-44.7	1.7	6.9
2.4166	13.7	16.4	-4.7	2	-44.7	1.7	7.3
2.41665	13.7	16.4	-4.7	2	-44.7	1.7	6.6
2.4167	13.7	16.4	-4.7	2	-44.7	1.7	6.1
2.41675	13.8	16.4	-4.6	2	-44.6	1.8	5.8
2.4168	13.8	16.4	-4.6	2	-44.6	1.8	6.3
2.41685	13.9	16.4	-4.5	2	-44.5	1.9	6.5
2.4169	14	16.4	-4.4	2	-44.4	2	6.2
2.41695	14.2	16.4	-4.2	2	-44.2	2.2	7.2

11Mbps CHANNEL 1 Processing Gain							
Gp = (S/N)o + Mj + Lsys							
Freq. (GHz)	Gp (dB)	(S/N)o (dB)	Mj = J/S (dB)	Lsys (dB)	Jammer (dBm)	LVL (dBm)	FER %
2.417	14.2	16.4	-4.2	2	-44.2	2.2	4.6
2.41705	14.4	16.4	-4	2	-44	2.4	5.2
2.4171	14.6	16.4	-3.8	2	-43.8	2.6	5.9
2.41715	14.8	16.4	-3.6	2	-43.6	2.8	5.7
2.4172	14.9	16.4	-3.5	2	-43.5	2.9	7.7
2.41725	15	16.4	-3.4	2	-43.4	3	5.8
2.4173	15	16.4	-3.4	2	-43.4	3	7.6
2.41735	15	16.4	-3.4	2	-43.4	3	6.6
2.4174	15.1	16.4	-3.3	2	-43.3	3.1	6.7
2.41745	15.2	16.4	-3.2	2	-43.2	3.2	6.6
2.4175	15.4	16.4	-3	2	-43	3.4	7.5
2.41755	15.5	16.4	-2.9	2	-42.9	3.5	6.6
2.4176	15.7	16.4	-2.7	2	-42.7	3.7	6.2
2.41765	15.9	16.4	-2.5	2	-42.5	3.9	6.5
2.4177	16.1	16.4	-2.3	2	-42.3	4.1	6.3
2.41775	16.4	16.4	-2	2	-42	4.4	7.9
2.4178	16.6	16.4	-1.8	2	-41.8	4.6	6.7
2.41785	16.7	16.4	-1.7	2	-41.7	4.7	6.5
2.4179	16.8	16.4	-1.6	2	-41.6	4.8	7.3
2.4195	16.8	16.4	-1.6	2	-41.6	4.8	6.6
2.418	16.9	16.4	-1.5	2	-41.5	4.9	7.4
2.41805	16.7	16.4	-1.7	2	-41.7	4.7	5.3
2.4181	16.7	16.4	-1.7	2	-41.7	4.7	6.7
2.41815	16.7	16.4	-1.7	2	-41.7	4.7	6.1
2.4182	16.7	16.4	-1.7	2	-41.7	4.7	6.1
2.41825	16.8	16.4	-1.6	2	-41.6	4.8	6.7
2.4183	16.9	16.4	-1.5	2	-41.5	4.9	6.8
2.41835	17	16.4	-1.4	2	-41.4	5	6.8
2.4184	17.2	16.4	-1.2	2	-41.2	5.2	6.8
2.41845	17.4	16.4	-1	2	-41	5.4	6.2
2.4185	17.8	16.4	-0.6	2	-40.6	5.8	6.6
2.41855	17.9	16.4	-0.5	2	-40.5	5.9	5.5
2.4186	18.1	16.4	-0.3	2	-40.3	6.1	7.7
2.41865	18.1	16.4	-0.3	2	-40.3	6.1	5.6
2.4187	18.1	16.4	-0.3	2	-40.3	6.1	5.8
2.41875	18.2	16.4	-0.2	2	-40.2	6.2	7.3
2.4188	18.3	16.4	-0.1	2	-40.1	6.3	5.8
2.41885	18.3	16.4	-0.1	2	-40.1	6.3	5.6
2.4189	18.3	16.4	-0.1	2	-40.1	6.3	6.3
2.41895	18.3	16.4	-0.1	2	-40.1	6.3	6.5
2.419	18.2	16.4	-0.2	2	-40.2	6.2	6.5
2.41905	18	16.4	-0.4	2	-40.4	6	7.3
2.4191	17.9	16.4	-0.5	2	-40.5	5.9	7.5
2.41915	17.9	16.4	-0.5	2	-40.5	5.9	6.8
2.4192	17.8	16.4	-0.6	2	-40.6	5.8	5.7

11Mbps CHANNEL 1 Processing Gain							
Gp = (S/N)o + Mj + Lsys							
Freq. (GHz)	Gp (dB)	(S/N)o (dB)	Mj = J/S (dB)	Lsys (dB)	Jammer (dBm)	LVL (dBm)	FER %
2.41925	17.8	16.4	-0.6	2	-40.6	5.8	5.4
2.4193	17.9	16.4	-0.5	2	-40.5	5.9	7.6
2.41935	18	16.4	-0.4	2	-40.4	6	6.8
2.4194	18.1	16.4	-0.3	2	-40.3	6.1	6.5
2.41945	18.4	16.4	0	2	-40	6.4	5.5
2.4195	18.8	16.4	0.4	2	-39.6	6.8	6.7
2.41955	19	16.4	0.6	2	-39.4	7	7.3
2.4196	19.1	16.4	0.7	2	-39.3	7.1	6.7
2.41965	19.1	16.4	0.7	2	-39.3	7.1	5.2
2.4197	19.2	16.4	0.8	2	-39.2	7.2	7.3
2.41975	19.2	16.4	0.8	2	-39.2	7.2	5.6
2.4198	19.3	16.4	0.9	2	-39.1	7.3	6.3
2.41985	19.4	16.4	1	2	-39	7.4	5.7
2.4199	19.4	16.4	1	2	-39	7.4	7.1
2.41995	19.4	16.4	1	2	-39	7.4	5.7
2.42	19.3	16.4	0.9	2	-39.1	7.3	4.6
2.42005	19.1	16.4	0.7	2	-39.3	7.1	7.7
2.4201	18.9	16.4	0.5	2	-39.5	6.9	6.5
2.42015	18.9	16.4	0.5	2	-39.5	6.9	7.9
2.4202	18.8	16.4	0.4	2	-39.6	6.8	5.5
2.42025	18.9	16.4	0.5	2	-39.5	6.9	7.7
2.4203	18.9	16.4	0.5	2	-39.5	6.9	6.3
2.42035	19.1	16.4	0.7	2	-39.3	7.1	7.6
2.4204	19.3	16.4	0.9	2	-39.1	7.3	7.3
2.42045	19.5	16.4	1.1	2	-38.9	7.5	6.6
2.4205	19.9	16.4	1.5	2	-38.5	7.9	5.6
Processing Gain (dB) @ 20 th percentile = 11.5							

11Mbps CHANNEL 6 Processing Gain							
Gp = (S/N)o + Mj + Lsys							
Freq.	Gp	(S/N)o	Mj = J/S	Lsys	Jammer	LVL	FER
(GHz)	(dB)	(dB)	(dB)	(dB)	(dBm)	(dBm)	%
2.4285	19.5	16.4	1.1	2	-38.9	5.2	6.6
2.42855	19.1	16.4	0.7	2	-39.3	4.8	7.7
2.4286	18.8	16.4	0.4	2	-39.6	4.5	6.8
2.42865	18.7	16.4	0.3	2	-39.7	4.4	6.8
2.4287	18.5	16.4	0.1	2	-39.9	4.2	5.6
2.42875	18.5	16.4	0.1	2	-39.9	4.2	6.3
2.4288	18.5	16.4	0.1	2	-39.9	4.2	6.1
2.42885	18.6	16.4	0.2	2	-39.8	4.3	6.9
2.4289	18.6	16.4	0.2	2	-39.8	4.3	5.2
2.42895	18.9	16.4	0.5	2	-39.5	4.6	7.4
2.429	19.3	16.4	0.9	2	-39.1	5	7.5
2.42905	19.3	16.4	0.9	2	-39.1	5	7.4
2.4291	19.2	16.4	0.8	2	-39.2	4.9	5.8
2.42915	19.2	16.4	0.8	2	-39.2	4.9	7.3
2.4292	19.1	16.4	0.7	2	-39.3	4.8	6.4
2.42925	19.1	16.4	0.7	2	-39.3	4.8	7.1
2.4293	19.1	16.4	0.7	2	-39.3	4.8	7.6
2.42935	19	16.4	0.6	2	-39.4	4.7	7.5
2.4294	18.9	16.4	0.5	2	-39.5	4.6	7.5
2.42945	18.8	16.4	0.4	2	-39.6	4.5	7.2
2.4295	18.6	16.4	0.2	2	-39.8	4.3	7.8
2.42955	18.1	16.4	-0.3	2	-40.3	3.8	7.7
2.4296	17.9	16.4	-0.5	2	-40.5	3.6	5.6
2.42965	17.8	16.4	-0.6	2	-40.6	3.5	7.4
2.4297	17.8	16.4	-0.6	2	-40.6	3.5	7.7
2.42975	17.7	16.4	-0.7	2	-40.7	3.4	7.2
2.4298	17.7	16.4	-0.7	2	-40.7	3.4	5.6
2.42985	17.8	16.4	-0.6	2	-40.6	3.5	7.3
2.4299	17.8	16.4	-0.6	2	-40.6	3.5	7.3
2.42995	17.9	16.4	-0.5	2	-40.5	3.6	6.4
2.43	18.2	16.4	-0.2	2	-40.2	3.9	7.3
2.43005	18.2	16.4	-0.2	2	-40.2	3.9	6.2
2.4301	18.2	16.4	-0.2	2	-40.2	3.9	5.6
2.43015	18.2	16.4	-0.2	2	-40.2	3.9	7.3
2.4302	18.1	16.4	-0.3	2	-40.3	3.8	5.6
2.43025	18.1	16.4	-0.3	2	-40.3	3.8	5.7
2.4303	18	16.4	-0.4	2	-40.4	3.7	5.6
2.43035	18	16.4	-0.4	2	-40.4	3.7	6.6
2.4304	17.9	16.4	-0.5	2	-40.5	3.6	5.6
2.43045	17.9	16.4	-0.5	2	-40.5	3.6	7.6
2.4305	17.6	16.4	-0.8	2	-40.8	3.3	7.6

2.43055	17.1	16.4	-1.3	2	-41.3	2.8	5.1
2.4306	16.9	16.4	-1.5	2	-41.5	2.6	5.6
2.43065	16.7	16.4	-1.7	2	-41.7	2.4	6.9

11Mbps CHANNEL 6 Processing Gain							
Gp = (S/N)o + Mj + Lsys							
Freq. (GHz)	Gp (dB)	(S/N)o (dB)	Mj = J/S (dB)	Lsys (dB)	Jammer (dBm)	LVL (dBm)	FER %
2.4307	16.6	16.4	-1.8	2	-41.8	2.3	7.3
2.43075	16.4	16.4	-2	2	-42	2.1	5.3
2.4308	16.4	16.4	-2	2	-42	2.1	6.6
2.43085	16.3	16.4	-2.1	2	-42.1	2	6.5
2.4309	16.3	16.4	-2.1	2	-42.1	2	6.3
2.43095	16.4	16.4	-2	2	-42	2.1	6.3
2.431	16.5	16.4	-1.9	2	-41.9	2.2	7.6
2.43105	16.5	16.4	-1.9	2	-41.9	2.2	7.6
2.4311	16.4	16.4	-2	2	-42	2.1	5.7
2.43115	16.3	16.4	-2.1	2	-42.1	2	7.3
2.4312	16.2	16.4	-2.2	2	-42.2	1.9	7.8
2.43125	16	16.4	-2.4	2	-42.4	1.7	7.6
2.4313	15.8	16.4	-2.6	2	-42.6	1.5	7.4
2.43135	15.6	16.4	-2.8	2	-42.8	1.3	6.8
2.4314	15.5	16.4	-2.9	2	-42.9	1.2	7.3
2.43145	15.3	16.4	-3.1	2	-43.1	1	7.5
2.4315	15.2	16.4	-3.2	2	-43.2	0.9	7.6
2.43155	15	16.4	-3.4	2	-43.4	0.7	6.1
2.4316	15	16.4	-3.4	2	-43.4	0.7	7.1
2.43165	14.9	16.4	-3.5	2	-43.5	0.6	6.3
2.4317	14.9	16.4	-3.5	2	-43.5	0.6	6.8
2.43175	14.9	16.4	-3.5	2	-43.5	0.6	6.9
2.4318	14.9	16.4	-3.5	2	-43.5	0.6	7.3
2.43185	14.8	16.4	-3.6	2	-43.6	0.5	6.7
2.4319	14.7	16.4	-3.7	2	-43.7	0.4	6.9
2.43195	14.5	16.4	-3.9	2	-43.9	0.2	7.1
2.432	14.4	16.4	-4	2	-44	0.1	7.9
2.43205	14.2	16.4	-4.2	2	-44.2	-0.1	6.7
2.4321	14.1	16.4	-4.3	2	-44.3	-0.2	6.6
2.43215	14	16.4	-4.4	2	-44.4	-0.3	6.7
2.4322	14	16.4	-4.4	2	-44.4	-0.3	7.5
2.43225	13.9	16.4	-4.5	2	-44.5	-0.4	7.5
2.4323	13.8	16.4	-4.6	2	-44.6	-0.5	6.1
2.43235	13.8	16.4	-4.6	2	-44.6	-0.5	6.7
2.4324	13.8	16.4	-4.6	2	-44.6	-0.5	7.4
2.43245	13.7	16.4	-4.7	2	-44.7	-0.6	6.8
2.4325	13.7	16.4	-4.7	2	-44.7	-0.6	7.6

2.43255	13.6	16.4	-4.8	2	-44.8	-0.7	7.8
2.4326	13.4	16.4	-5	2	-45	-0.9	6.7
2.43265	13.3	16.4	-5.1	2	-45.1	-1	7.6
2.4327	13.1	16.4	-5.3	2	-45.3	-1.2	6.5
2.43275	13	16.4	-5.4	2	-45.4	-1.3	6.6
2.4328	13	16.4	-5.4	2	-45.4	-1.3	7.6
2.43285	12.9	16.4	-5.5	2	-45.5	-1.4	6.4
2.4329	12.9	16.4	-5.5	2	-45.5	-1.4	7.3

11Mbps CHANNEL 6 Processing Gain							
Gp = (S/N)o + Mj + Lsys							
Freq. (GHz)	Gp (dB)	(S/N)o (dB)	Mj = J/S (dB)	Lsys (dB)	Jammer (dBm)	LVL (dBm)	FER %
2.43295	12.9	16.4	-5.5	2	-45.5	-1.4	5.7
2.433	12.9	16.4	-5.5	2	-45.5	-1.4	6.9
2.43305	12.9	16.4	-5.5	2	-45.5	-1.4	7.2
2.4331	12.9	16.4	-5.5	2	-45.5	-1.4	6.6
2.43315	12.9	16.4	-5.5	2	-45.5	-1.4	6.3
2.4332	12.9	16.4	-5.5	2	-45.5	-1.4	6.7
2.43325	12.8	16.4	-5.6	2	-45.6	-1.5	6.9
2.4333	12.7	16.4	-5.7	2	-45.7	-1.6	7.1
2.43335	12.6	16.4	-5.8	2	-45.8	-1.7	7.9
2.4334	12.4	16.4	-6	2	-46	-1.9	6.5
2.43345	12.3	16.4	-6.1	2	-46.1	-2	7.6
2.4335	12.3	16.4	-6.1	2	-46.1	-2	5.8
2.43355	12.1	16.4	-6.3	2	-46.3	-2.2	6.4
2.4336	12.1	16.4	-6.3	2	-46.3	-2.2	6.7
2.43365	12.1	16.4	-6.3	2	-46.3	-2.2	7.2
2.4337	12.1	16.4	-6.3	2	-46.3	-2.2	7.2
2.43375	12.1	16.4	-6.3	2	-46.3	-2.2	7.5
2.4338	12	16.4	-6.4	2	-46.4	-2.3	6.6
2.43385	12	16.4	-6.4	2	-46.4	-2.3	5.8
2.4339	11.8	16.4	-6.6	2	-46.6	-2.5	6.1
2.43395	11.6	16.4	-6.8	2	-46.8	-2.7	5.7
2.434	11.5	16.4	6.9	2	-46.9	-2.8	4.7
2.43405	11.4	16.4	-7	2	-47	-2.9	7.8
2.4341	11.3	16.4	-7.1	2	-47.1	-3	7.7
2.43415	11.2	16.4	-7.2	2	-47.2	-3.1	7.4
2.4342	11.2	16.4	-7.2	2	-47.2	-3.1	6.8
2.43425	11	16.4	-7.4	2	-47.4	-3.3	6.1
2.4343	11	16.4	-7.4	2	-47.4	-3.3	6.5
2.43435	11	16.4	-7.4	2	-47.4	-3.3	6.7
2.4344	11	16.4	-7.4	2	-47.4	-3.3	6.1
2.43445	11.1	16.4	-7.3	2	-47.3	-3.2	6.2
2.4345	11.2	16.4	-7.2	2	-47.2	-3.1	5.7
2.43455	11.2	16.4	-7.2	2	-47.2	-3.1	6.1

2.4346	11.2	16.4	-7.2	2	-47.2	-3.1	5.7
2.43465	11.3	16.4	-7.1	2	-47.1	-3	6.4
2.4347	11.3	16.4	-7.1	2	-47.1	-3	7.4
2.43475	11.2	16.4	-7.2	2	-47.2	-3.1	6.7
2.4348	11.1	16.4	-7.3	2	-47.3	-3.2	6.9
2.43485	11.1	16.4	-7.3	2	-47.3	-3.2	7.8
2.4349	11	16.4	-7.4	2	-47.4	-3.3	7.4
2.43495	11	16.4	-7.4	2	-47.4	-3.3	6.7
2.435	11	16.4	-7.4	2	-47.4	-3.3	6.7
2.43505	11.1	16.4	-7.3	2	-47.3	-3.2	6.8
2.4351	11.1	16.4	-7.3	2	-47.3	-3.2	7.1
2.43515	11.2	16.4	-7.2	2	-47.2	-3.1	7.3

11Mbps CHANNEL 6 Processing Gain							
Gp = (S/N)o + Mj + Lsys							
Freq. (GHz)	Gp (dB)	(S/N)o (dB)	Mj = J/S (dB)	Lsys (dB)	Jammer (dBm)	LVL (dBm)	FER %
2.4352	11.3	16.4	-7.1	2	-47.1	-3	7.7
2.43525	11.3	16.4	-7.1	2	-47.1	-3	6.6
2.4353	11.4	16.4	-7	2	-47	-2.9	7.7
2.43535	11.4	16.4	-7	2	-47	-2.9	7.8
2.4354	11.3	16.4	-7.1	2	-47.1	-3	7.1
2.43545	11.3	16.4	-7.1	2	-47.1	-3	7.3
2.4355	11.2	16.4	-7.2	2	-47.2	-3.1	6.5
2.43555	11.2	16.4	-7.2	2	-47.2	-3.1	6.4
2.4356	11.2	16.4	-7.2	2	-47.2	-3.1	6.1
2.43565	11.2	16.4	-7.2	2	-47.2	-3.1	6.6
2.4357	11.2	16.4	-7.2	2	-47.2	-3.1	6.5
2.43575	11.3	16.4	-7.1	2	-47.1	-3	7.1
2.4358	11.4	16.4	-7	2	-47	-2.9	7.4
2.43585	11.5	16.4	-6.9	2	-46.9	-2.8	7.2
2.4359	11.5	16.4	-6.9	2	-46.9	-2.8	7.1
2.43595	11.5	16.4	-6.9	2	-46.9	-2.8	6.2
2.436	11.5	16.4	-6.9	2	-46.9	-2.8	6.4
2.43605	11.4	16.4	-7	2	-47	-2.9	7.3
2.4361	11.5	16.4	-6.9	2	-46.9	-2.8	7.4
2.43615	11.5	16.4	-6.9	2	-46.9	-2.8	7.7
2.4362	11.5	16.4	-6.9	2	-46.9	-2.8	7.1
2.43625	11.5	16.4	-6.9	2	-46.9	-2.8	7.5
2.4363	11.5	16.4	-6.9	2	-46.9	-2.8	7.8
2.43635	11.4	16.4	-7	2	-47	-2.9	7.2
2.4364	11.4	16.4	-7	2	-47	-2.9	6.7
2.43645	11.4	16.4	-7	2	-47	-2.9	6.3
2.4365	11.4	16.4	-7	2	-47	-2.9	6.5
2.43655	11.4	16.4	-7	2	-47	-2.9	6.9
2.4366	11.4	16.4	-7	2	-47	-2.9	6.7

2.43665	11.5	16.4	-6.9	2	-46.9	-2.8	7.7
2.4367	11.5	16.4	-6.9	2	-46.9	-2.8	6.3
2.43675	11.4	16.4	-7	2	-47	-2.9	6.7
2.4368	11.3	16.4	-7.1	2	-47.1	-3	7.7
2.43685	11.1	16.4	-7.3	2	-47.3	-3.2	6.4
2.4369	11	16.4	-7.4	2	-47.4	-3.3	6.6
2.43695	10.9	16.4	-7.5	2	-47.5	-3.4	6.5
2.437	10.9	16.4	-7.5	2	-47.5	-3.4	5.6
2.43705	11	16.4	-7.4	2	-47.4	-3.3	6.8
2.4371	11.1	16.4	-7.3	2	-47.3	-3.2	7.2
2.43715	11.2	16.4	-7.2	2	-47.2	-3.1	5.5
2.4372	11.3	16.4	-7.1	2	-47.1	-3	5.3
2.43725	11.5	16.4	-6.9	2	-46.9	-2.8	6.6
2.4373	11.6	16.4	-6.8	2	-46.8	-2.7	6.3
2.43735	11.6	16.4	-6.8	2	-46.8	-2.7	6.1
2.4374	11.5	16.4	-6.9	2	-46.9	-2.8	5.8

11Mbps CHANNEL 6 Processing Gain							
Gp = (S/N)o + Mj + Lsys							
Freq. (GHz)	Gp (dB)	(S/N)o (dB)	Mj = J/S (dB)	Lsys (dB)	Jammer (dBm)	LVL (dBm)	FER %
2.43745	11.4	16.4	-7	2	-47	-2.9	5.6
2.4375	11.4	16.4	-7	2	-47	-2.9	6.3
2.43755	11.5	16.4	-6.9	2	-46.9	-2.8	7.8
2.4376	11.5	16.4	-6.9	2	-46.9	-2.8	7.1
2.43765	11.5	16.4	-6.9	2	-46.9	-2.8	5.6
2.4377	11.5	16.4	-6.9	2	-46.9	-2.8	5.6
2.43775	11.5	16.4	-6.9	2	-46.9	-2.8	7.9
2.4378	11.6	16.4	-6.8	2	-46.8	-2.7	6.4
2.43785	11.7	16.4	-6.7	2	-46.7	-2.6	7.2
2.4379	11.8	16.4	-6.6	2	-46.6	-2.5	6.6
2.43795	11.7	16.4	-6.7	2	-46.7	-2.6	7.4
2.438	11.7	16.4	-6.7	2	-46.7	-2.6	7.8
2.43805	11.6	16.4	-6.8	2	-46.8	-2.7	6.2
2.4381	11.6	16.4	-6.8	2	-46.8	-2.7	7.6
2.43815	11.5	16.4	-6.9	2	-46.9	-2.8	6.4
2.4382	11.5	16.4	-6.9	2	-46.9	-2.8	7.5
2.43825	11.4	16.4	-7	2	-47	-2.9	6.6
2.4383	11.4	16.4	-7	2	-47	-2.9	7.7
2.43835	11.3	16.4	-7.1	2	-47.1	-3	6.8
2.4384	11.3	16.4	-7.1	2	-47.1	-3	7.2
2.43845	11.3	16.4	-7.1	2	-47.1	-3	6.7
2.4385	11.3	16.4	-7.1	2	-47.1	-3	6.3
2.43855	11.4	16.4	-7	2	-47	-2.9	7.8
2.4386	11.4	16.4	-7	2	-47	-2.9	6.2
2.43865	11.4	16.4	-7	2	-47	-2.9	6.8

2.4387	11.4	16.4	-7	2	-47	-2.9	6.5
2.43875	11.4	16.4	-7	2	-47	-2.9	6.9
2.4388	11.3	16.4	-7.1	2	-47.1	-3	6.7
2.43885	11.3	16.4	-7.1	2	-47.1	-3	6.8
2.4389	11.2	16.4	-7.2	2	-47.2	-3.1	7.7
2.43895	11.1	16.4	-7.3	2	-47.3	-3.2	7.1
2.439	11.1	16.4	-7.3	2	-47.3	-3.2	7.8
2.43905	11	16.4	-7.4	2	-47.4	-3.3	6.5
2.4391	11	16.4	-7.4	2	-47.4	-3.3	7.8
2.43915	11	16.4	-7.4	2	-47.4	-3.3	7.8
2.4392	11	16.4	-7.4	2	-47.4	-3.3	6.7
2.43925	11.1	16.4	-7.3	2	-47.3	-3.2	6.8
2.4393	11.2	16.4	-7.2	2	-47.2	-3.1	7.4
2.43935	11.2	16.4	-7.2	2	-47.2	-3.1	6.5
2.4394	11.4	16.4	-7	2	-47	-2.9	6.5
2.43945	11.4	16.4	-7	2	-47	-2.9	6.5
2.4395	11.2	16.4	-7.2	2	-47.2	-3.1	6.5
2.43955	11.3	16.4	-7.1	2	-47.1	-3	6.6
2.4396	11.3	16.4	-7.1	2	-47.1	-3	7.1
2.43965	11.3	16.4	-7.1	2	-47.1	-3	4.8

11Mbps CHANNEL 6 Processing Gain							
Gp = (S/N)o + Mj + Lsys							
Freq. (GHz)	Gp (dB)	(S/N)o (dB)	Mj = J/S (dB)	Lsys (dB)	Jammer (dBm)	LVL (dBm)	FER %
2.4397	11.1	16.4	-7.3	2	-47.3	-3.2	7.8
2.43975	11.1	16.4	-7.3	2	-47.3	-3.2	5.7
2.4398	11.1	16.4	-7.3	2	-47.3	-3.2	6.9
2.43985	11.2	16.4	-7.2	2	-47.2	-3.1	6.5
2.4399	11.3	16.4	-7.1	2	-47.1	-3	6.2
2.43995	11.7	16.4	-6.7	2	-46.7	-2.6	6.3
2.44	11.8	16.4	-6.6	2	-46.6	-2.5	6.8
2.44005	11.9	16.4	-6.5	2	-46.5	-2.4	6.2
2.4401	12.1	16.4	-6.3	2	-46.3	-2.2	7.5
2.44015	12.1	16.4	-6.3	2	-46.3	-2.2	7.7
2.4402	12.1	16.4	-6.3	2	-46.3	-2.2	6.7
2.44025	12.1	16.4	-6.3	2	-46.3	-2.2	6.7
2.4403	12.1	16.4	-6.3	2	-46.3	-2.2	6.5
2.44035	12.1	16.4	-6.3	2	-46.3	-2.2	4.7
2.4404	12.1	16.4	-6.3	2	-46.3	-2.2	6.9
2.44045	12	16.4	-6.4	2	-46.4	-2.3	5.6
2.4405	12.1	16.4	-6.3	2	-46.3	-2.2	6.6
2.44055	12.2	16.4	-6.2	2	-46.2	-2.1	6.1
2.4406	12.4	16.4	-6	2	-46	-1.9	5.8
2.44065	12.5	16.4	-5.9	2	-45.9	-1.8	6.3
2.4407	12.7	16.4	-5.7	2	-45.7	-1.6	7.3

2.44075	12.7	16.4	-5.7	2	-45.7	-1.6	5.8
2.4408	12.8	16.4	-5.6	2	-45.6	-1.5	7.2
2.44085	12.8	16.4	-5.6	2	-45.6	-1.5	7.3
2.4409	12.8	16.4	-5.6	2	-45.6	-1.5	7.3
2.44095	12.8	16.4	-5.6	2	-45.6	-1.5	7.2
2.441	12.8	16.4	-5.6	2	-45.6	-1.5	4.7
2.44105	12.8	16.4	-5.6	2	-45.6	-1.5	7.2
2.4411	12.8	16.4	-5.6	2	-45.6	-1.5	6.3
2.44115	12.9	16.4	-5.5	2	-45.5	-1.4	6.9
2.4412	13	16.4	-5.4	2	-45.4	-1.3	7.2
2.44125	13.1	16.4	-5.3	2	-45.3	-1.2	6.7
2.4413	13.3	16.4	-5.1	2	-45.1	-1	7.6
2.44135	13.4	16.4	-5	2	-45	-0.9	6.8
2.4414	13.5	16.4	-4.9	2	-44.9	-0.8	6.6
2.44145	13.6	16.4	-4.8	2	-44.8	-0.7	6.2
2.4415	13.7	16.4	-4.7	2	-44.7	-0.6	3.7
2.44155	13.7	16.4	-4.7	2	-44.7	-0.6	6.4
2.4416	13.7	16.4	-4.7	2	-44.7	-0.6	6.3
2.44165	13.7	16.4	-4.7	2	-44.7	-0.6	5.7
2.4417	13.8	16.4	-4.6	2	-44.6	-0.5	7.3
2.44175	13.8	16.4	-4.6	2	-44.6	-0.5	6.3
2.4418	13.9	16.4	-4.5	2	-44.5	-0.4	6.9
2.44185	14.1	16.4	-4.3	2	-44.3	-0.2	7.8
2.4419	14.2	16.4	-4.2	2	-44.2	-0.1	7.1
11Mbps CHANNEL 6 Processing Gain							
$G_p = (S/N)_o + M_j + L_{sys}$							
Freq. (GHz)	Gp (dB)	(S/N) _o (dB)	M _j = J/S (dB)	L _{sys} (dB)	Jammer (dBm)	LVL (dBm)	FER %
2.44195	14.3	16.4	-4.1	2	-44.1	0	5.9
2.442	14.5	16.4	-3.9	2	-43.9	0.2	6.6
2.44205	14.7	16.4	-3.7	2	-43.7	0.4	6.9
2.4421	14.8	16.4	-3.6	2	-43.6	0.5	5.7
2.44215	14.9	16.4	-3.5	2	-43.5	0.6	5.5
2.4422	15	16.4	-3.4	2	-43.4	0.7	5.5
2.44225	15.1	16.4	-3.3	2	-43.3	0.8	6.8
2.4423	15.1	16.4	-3.3	2	-43.3	0.8	6.5
2.44235	15.2	16.4	-3.2	2	-43.2	0.9	7.3
2.4424	15.2	16.4	-3.2	2	-43.2	0.9	6.7
2.44245	15.3	16.4	-3.1	2	-43.1	1	6.9
2.4425	15.4	16.4	-3	2	-43	1.1	6.6
2.44255	15.6	16.4	-2.8	2	-42.8	1.3	6.7
2.4426	15.8	16.4	-2.6	2	-42.6	1.5	6.7
2.44265	16	16.4	-2.4	2	-42.4	1.7	6.7
2.4427	16.2	16.4	-2.2	2	-42.2	1.9	6.7
2.44275	16.4	16.4	-2	2	-42	2.1	5.7

2.4428	16.7	16.4	-1.7	2	-41.7	2.4	6.8
2.44285	16.8	16.4	-1.6	2	-41.6	2.5	6.3
2.4429	16.9	16.4	-1.5	2	-41.5	2.6	7.7
2.44295	16.9	16.4	-1.5	2	-41.5	2.6	6.8
2.443	17	16.4	-1.4	2	-41.4	2.7	7.2
2.44305	16.9	16.4	-1.5	2	-41.5	2.6	7.8
2.4431	16.8	16.4	-1.6	2	-41.6	2.5	6.7
2.44315	16.8	16.4	-1.6	2	-41.6	2.5	5.9
2.4432	16.9	16.4	-1.5	2	-41.5	2.6	7.3
2.44325	16.9	16.4	-1.5	2	-41.5	2.6	6.4
2.4433	17	16.4	-1.4	2	-41.4	2.7	6.3
2.44335	17.1	16.4	-1.3	2	-41.3	2.8	6.2
2.4434	17.4	16.4	-1	2	-41	3.1	7.1
2.44345	17.6	16.4	-0.8	2	-40.8	3.3	5.8
2.4435	18	16.4	-0.4	2	-40.4	3.7	5.6
2.44355	18.2	16.4	-0.2	2	-40.2	3.9	7.8
2.4436	18.2	16.4	-0.2	2	-40.2	3.9	6.6
2.44365	18.3	16.4	-0.1	2	-40.1	4	6.8
2.4437	18.3	16.4	-0.1	2	-40.1	4	6.5
2.44375	18.4	16.4	0	2	-40	4.1	7.1
2.4438	18.5	16.4	0.1	2	-39.9	4.2	6.7
2.44385	18.5	16.4	0.1	2	-39.9	4.2	6.7
2.4439	18.5	16.4	0.1	2	-39.9	4.2	5.8
2.44395	18.5	16.4	0.1	2	-39.9	4.2	6.8
2.444	18.4	16.4	0	2	-40	4.1	5.8
2.44405	18.2	16.4	-0.2	2	-40.2	3.9	7.8
2.4441	18.1	16.4	-0.3	2	-40.3	3.8	7.9
2.44415	18	16.4	-0.4	2	-40.4	3.7	5.4

11Mbps CHANNEL 6 Processing Gain

$$G_p = (S/N)_o + M_j + L_{sys}$$

Freq. (GHz)	Gp (dB)	(S/N) _o (dB)	M _j = J/S (dB)	L _{sys} (dB)	Jammer (dBm)	LVL (dBm)	FER %
2.4442	18	16.4	-0.4	2	-40.4	3.7	6.1
2.44425	18.1	16.4	-0.3	2	-40.3	3.8	7.7
2.4443	18.1	16.4	-0.3	2	-40.3	3.8	6.8
2.44435	18.1	16.4	-0.3	2	-40.3	3.8	5.5
2.4444	18.4	16.4	0	2	-40	4.1	6.1
2.44445	18.7	16.4	0.3	2	-39.7	4.4	6.6
2.4445	19	16.4	0.6	2	-39.4	4.7	6.2
2.44455	19.2	16.4	0.8	2	-39.2	4.9	6.6
2.4446	19.3	16.4	0.9	2	-39.1	5	6.3
2.44465	19.3	16.4	0.9	2	-39.1	5	5.6
2.4447	19.4	16.4	1	2	-39	5.1	7.8
2.44475	19.5	16.4	1.1	2	-38.9	5.2	6.5
2.4448	19.5	16.4	1.1	2	-38.9	5.2	7.3

2.44485	19.5	16.4	1.1	2	-38.9	5.2	5.2
2.4449	19.6	16.4	1.2	2	-38.8	5.3	7.5
2.44495	19.6	16.4	1.2	2	-38.8	5.3	3.8
2.445	19.5	16.4	1.1	2	-38.9	5.2	6.8
2.44505	19.2	16.4	0.8	2	-39.2	4.9	6.7
2.4451	19.2	16.4	0.8	2	-39.2	4.9	7.6
2.44515	19	16.4	0.6	2	-39.4	4.7	7.4
2.4452	19	16.4	0.6	2	-39.4	4.7	5.5
2.44525	19	16.4	0.6	2	-39.4	4.7	4.8
2.4453	19.1	16.4	0.7	2	-39.3	4.8	5.9
2.44535	19.3	16.4	0.9	2	-39.1	5	6.6
2.4454	19.5	16.4	1.1	2	-38.9	5.2	5.6
2.44545	19.9	16.4	1.5	2	-38.5	5.6	7.5
2.4455	20.3	16.4	1.9	2	-38.1	6	7.7
Processing Gain(dB) @ 20th Percentile = 11.4							

11Mbps CHANNEL 11 Processing Gain							
Gp = (S/N)o + Mj + Lsys							
Freq. (GHz)	Gp (dB)	(S/N)o (dB)	Mj = J/S (dB)	Lsys (dB)	Jammer (dBm)	LVL (dBm)	FER %
2.4535	19.5	16.4	1.1	2	-38.9	2.9	7.7
2.45355	19.1	16.4	0.7	2	-39.3	2.5	7.4
2.4536	18.8	16.4	0.4	2	-39.6	2.2	6.9
2.45365	18.5	16.4	0.1	2	-39.9	1.9	5.3
2.4537	18.4	16.4	0	2	-40	1.8	4.6
2.45375	18.4	16.4	0	2	-40	1.8	7.2
2.4538	18.4	16.4	0	2	-40	1.8	6.8
2.45385	18.5	16.4	0.1	2	-39.9	1.9	7.4
2.4539	18.6	16.4	0.2	2	-39.8	2	4.7
2.45395	18.8	16.4	0.4	2	-39.6	2.2	6.6
2.454	19.1	16.4	0.7	2	-39.3	2.5	7.1
2.45405	19.1	16.4	0.7	2	-39.3	2.5	5.7
2.4541	19.1	16.4	0.7	2	-39.3	2.5	6.4
2.45415	19	16.4	0.6	2	-39.4	2.4	5.5
2.4542	19	16.4	0.6	2	-39.4	2.4	7.5
2.45425	18.9	16.4	0.5	2	-39.5	2.3	5.4
2.4543	18.9	16.4	0.5	2	-39.5	2.3	6.8
2.45435	18.8	16.4	0.4	2	-39.6	2.2	5.5
2.4544	18.8	16.4	0.4	2	-39.6	2.2	6.4
2.45445	18.7	16.4	0.3	2	-39.7	2.1	6.4
2.4545	18.5	16.4	0.1	2	-39.9	1.9	6.1
2.45455	18.2	16.4	-0.2	2	-40.2	1.6	6.4
2.4546	17.9	16.4	-0.5	2	-40.5	1.3	5.7
2.45465	17.7	16.4	-0.7	2	-40.7	1.1	5.5
2.4547	17.7	16.4	-0.7	2	-40.7	1.1	6.4
2.45475	17.7	16.4	-0.7	2	-40.7	1.1	7.2
2.4548	17.7	16.4	-0.7	2	-40.7	1.1	6.7
2.45485	17.7	16.4	-0.7	2	-40.7	1.1	6.6
2.4549	17.8	16.4	-0.6	2	-40.6	1.2	6.4
2.45495	17.9	16.4	-0.5	2	-40.5	1.3	6.2
2.455	18.1	16.4	-0.3	2	-40.3	1.5	5.6
2.45505	18.2	16.4	-0.2	2	-40.2	1.6	6.6
2.4551	18.2	16.4	-0.2	2	-40.2	1.6	6.5
2.45515	18.1	16.4	-0.3	2	-40.3	1.5	5.3
2.4552	18	16.4	-0.4	2	-40.4	1.4	5.2
2.45525	18	16.4	-0.4	2	-40.4	1.4	7.6
2.4553	17.9	16.4	-0.5	2	-40.5	1.3	5.2
2.45535	17.9	16.4	-0.5	2	-40.5	1.3	5.7
2.4554	17.9	16.4	-0.5	2	-40.5	1.3	6.3
2.45545	17.8	16.4	-0.6	2	-40.6	1.2	5.4
2.4555	17.7	16.4	-0.7	2	-40.7	1.1	7.4

2.45555	17.2	16.4	-1.2	2	-41.2	0.6	6.5
2.4556	16.9	16.4	-1.5	2	-41.5	0.3	6.9
2.45565	16.7	16.4	-1.7	2	-41.7	0.1	6.5
2.4557	16.6	16.4	-1.8	2	-41.8	0	7.3

11Mbps CHANNEL 11 Processing Gain							
Gp = (S/N)o + Mj + Lsys							
Freq. (GHz)	Gp (dB)	(S/N)o (dB)	Mj = J/S (dB)	Lsys (dB)	Jammer (dBm)	LVL (dBm)	FER %
2.45575	16.5	16.4	-1.9	2	-41.9	-0.1	7.2
2.4558	16.4	16.4	-2	2	-42	-0.2	6.9
2.45585	16.3	16.4	-2.1	2	-42.1	-0.3	5.1
2.4559	16.3	16.4	-2.1	2	-42.1	-0.3	5.4
2.45595	16.4	16.4	-2	2	-42	-0.2	6.1
2.456	16.5	16.4	-1.9	2	-41.9	-0.1	7.6
2.45605	16.4	16.4	-2	2	-42	-0.2	5.7
2.4561	16.4	16.4	-2	2	-42	-0.2	6.4
2.45615	16.3	16.4	-2.1	2	-42.1	-0.3	6.7
2.4562	16.2	16.4	-2.2	2	-42.2	-0.4	7.5
2.45625	16	16.4	-2.4	2	-42.4	-0.6	7.1
2.4563	15.8	16.4	-2.6	2	-42.6	-0.8	6.3
2.45635	15.7	16.4	-2.7	2	-42.7	-0.9	4.7
2.4564	15.6	16.4	-2.8	2	-42.8	-1	7.4
2.45645	15.4	16.4	-3	2	-43	-1.2	6.6
2.4565	15.3	16.4	-3.1	2	-43.1	-1.3	7.4
2.45655	15.1	16.4	-3.3	2	-43.3	-1.5	5.6
2.4566	15.1	16.4	-3.3	2	-43.3	-1.5	6.5
2.45665	15	16.4	-3.4	2	-43.4	-1.6	5.6
2.4567	15	16.4	-3.4	2	-43.4	-1.6	6.6
2.45675	15	16.4	-3.4	2	-43.4	-1.6	6.4
2.4568	15	16.4	-3.4	2	-43.4	-1.6	6.7
2.45685	14.9	16.4	-3.5	2	-43.5	-1.7	6.1
2.4569	14.8	16.4	-3.6	2	-43.6	-1.8	6.2
2.45695	14.6	16.4	-3.8	2	-43.8	-2	6.6
2.457	14.5	16.4	-3.9	2	-43.9	-2.1	6.1
2.45705	14.4	16.4	-4	2	-44	-2.2	7.1
2.4571	14.3	16.4	-4.1	2	-44.1	-2.3	7.7
2.45715	14.2	16.4	-4.2	2	-44.2	-2.4	7.6
2.4572	14	16.4	-4.4	2	-44.4	-2.6	5.2
2.45725	14	16.4	-4.4	2	-44.4	-2.6	6.8
2.4573	13.9	16.4	-4.5	2	-44.5	-2.7	6.6
2.45735	13.9	16.4	-4.5	2	-44.5	-2.7	6.9
2.4574	13.9	16.4	-4.5	2	-44.5	-2.7	7.3
2.45745	13.9	16.4	-4.5	2	-44.5	-2.7	4.8
2.4575	13.8	16.4	-4.6	2	-44.6	-2.8	7.3
2.45755	13.7	16.4	-4.7	2	-44.7	-2.9	7.4
2.4576	13.5	16.4	-4.9	2	-44.9	-3.1	6.5
2.45765	13.4	16.4	-5	2	-45	-3.2	7.1
2.4577	13.3	16.4	-5.1	2	-45.1	-3.3	7.5
2.45775	13.2	16.4	-5.2	2	-45.2	-3.4	7.6

2.4578	13.1	16.4	-5.3	2	-45.3	-3.5	6.4
2.45785	13.1	16.4	-5.3	2	-45.3	-3.5	7.1
2.4579	13.1	16.4	-5.3	2	-45.3	-3.5	7.7
2.45795	13.1	16.4	-5.3	2	-45.3	-3.5	7.4
11Mbps CHANNEL 11 Processing Gain							
$G_p = (S/N)_o + M_j + L_{sys}$							
Freq. (GHz)	Gp (dB)	(S/N) _o (dB)	M _j = J/S (dB)	L _{sys} (dB)	Jammer (dBm)	LVL (dBm)	FER %
2.458	13.1	16.4	-5.3	2	-45.3	-3.5	7.4
2.45805	13	16.4	-5.4	2	-45.4	-3.6	6.4
2.4581	13.1	16.4	-5.3	2	-45.3	-3.5	7.1
2.45815	13.1	16.4	-5.3	2	-45.3	-3.5	4.7
2.4582	13	16.4	-5.4	2	-45.4	-3.6	6.3
2.45825	12.9	16.4	-5.5	2	-45.5	-3.7	5.9
2.4583	12.8	16.4	-5.6	2	-45.6	-3.8	6.5
2.45835	12.7	16.4	-5.7	2	-45.7	-3.9	7.6
2.4584	12.6	16.4	-5.8	2	-45.8	-4	7.5
2.45845	12.5	16.4	-5.9	2	-45.9	-4.1	7.5
2.4585	12.4	16.4	-6	2	-46	-4.2	6.7
2.45855	12.4	16.4	-6	2	-46	-4.2	7.4
2.4586	12.4	16.4	-6	2	-46	-4.2	7.6
2.45865	12.4	16.4	-6	2	-46	-4.2	7.4
2.4587	12.4	16.4	-6	2	-46	-4.2	7.4
2.45875	12.4	16.4	-6	2	-46	-4.2	6.6
2.4588	12.5	16.4	-5.9	2	-45.9	-4.1	4.8
2.45885	12.4	16.4	-6	2	-46	-4.2	6.3
2.4589	12.3	16.4	-6.1	2	-46.1	-4.3	6.8
2.45895	12.2	16.4	-6.2	2	-46.2	-4.4	6.5
2.459	12.1	16.4	-6.3	2	-46.3	-4.5	7.1
2.45905	11.9	16.4	-6.5	2	-46.5	-4.7	6.4
2.4591	11.8	16.4	-6.6	2	-46.6	-4.8	6.6
2.45915	11.8	16.4	-6.6	2	-46.6	-4.8	7.3
2.4592	11.7	16.4	-6.7	2	-46.7	-4.9	5.7
2.45925	11.7	16.4	-6.7	2	-46.7	-4.9	7.6
2.4593	11.6	16.4	-6.8	2	-46.8	-5	5.6
2.45935	11.7	16.4	-6.7	2	-46.7	-4.9	7.5
2.4594	11.7	16.4	-6.7	2	-46.7	-4.9	5.7
2.45945	11.7	16.4	-6.7	2	-46.7	-4.9	6.2
2.4595	11.7	16.4	-6.7	2	-46.7	-4.9	5.8
2.45955	11.8	16.4	-6.6	2	-46.6	-4.8	7.1
2.4596	11.8	16.4	-6.6	2	-46.6	-4.8	6.5
2.45965	11.7	16.4	-6.7	2	-46.7	-4.9	5.9
2.4597	11.7	16.4	-6.7	2	-46.7	-4.9	7.6
2.45975	11.6	16.4	-6.8	2	-46.8	-5	5.8
2.4598	11.5	16.4	-6.9	2	-46.9	-5.1	7.1
2.45985	11.4	16.4	-7	2	-47	-5.2	7.5

2.4599	11.4	16.4	-7	2	-47	-5.2	4.8
2.45995	11.3	16.4	-7.1	2	-47.1	-5.3	7.7
2.46	11.3	16.4	-7.1	2	-47.1	-5.3	6.6
2.46005	11.3	16.4	-7.1	2	-47.1	-5.3	6.6
2.4601	11.4	16.4	-7	2	-47	-5.2	7.1
2.46015	11.5	16.4	-6.9	2	-46.9	-5.1	7.1
2.4602	11.5	16.4	-6.9	2	-46.9	-5.1	5.6

11Mbps CHANNEL 11 Processing Gain							
Gp = (S/N)o + Mj + Lsys							
Freq. (GHz)	Gp (dB)	(S/N)o (dB)	Mj = J/S (dB)	Lsys (dB)	Jammer (dBm)	LVL (dBm)	FER %
2.46025	11.6	16.4	-6.8	2	-46.8	-5	6.4
2.4603	11.6	16.4	-6.8	2	-46.8	-5	5.6
2.46035	11.6	16.4	-6.8	2	-46.8	-5	6.8
2.4604	11.6	16.4	-6.8	2	-46.8	-5	7.2
2.46045	11.5	16.4	-6.9	2	-46.9	-5.1	6.6
2.4605	11.5	16.4	-6.9	2	-46.9	-5.1	7.2
2.46055	11.4	16.4	-7	2	-47	-5.2	6.2
2.4606	11.4	16.4	-7	2	-47	-5.2	7.1
2.46065	11.5	16.4	-6.9	2	-46.9	-5.1	5.8
2.4607	11.5	16.4	-6.9	2	-46.9	-5.1	6.7
2.46075	11.6	16.4	-6.8	2	-46.8	-5	7.8
2.4608	11.6	16.4	-6.8	2	-46.8	-5	4.6
2.46085	11.8	16.4	-6.6	2	-46.6	-4.8	7.7
2.4609	11.9	16.4	-6.5	2	-46.5	-4.7	7.3
2.46095	12	16.4	-6.4	2	-46.4	-4.6	7.9
2.461	12	16.4	-6.4	2	-46.4	-4.6	7.2
2.46105	11.9	16.4	-6.5	2	-46.5	-4.7	6.8
2.4611	12	16.4	-6.4	2	-46.4	-4.6	7.7
2.46115	12.1	16.4	-6.3	2	-46.3	-4.5	7.4
2.4612	12.1	16.4	-6.3	2	-46.3	-4.5	6.8
2.46125	12.1	16.4	-6.3	2	-46.3	-4.5	6.5
2.4613	12.1	16.4	-6.3	2	-46.3	-4.5	5.7
2.46135	12.1	16.4	-6.3	2	-46.3	-4.5	6.5
2.4614	12.1	16.4	-6.3	2	-46.3	-4.5	6.5
2.46145	12.1	16.4	-6.3	2	-46.3	-4.5	6.6
2.4615	12.2	16.4	-6.2	2	-46.2	-4.4	7.8
2.46155	12.2	16.4	-6.2	2	-46.2	-4.4	6.8
2.4616	12.3	16.4	-6.1	2	-46.1	-4.3	6.8
2.46165	12.3	16.4	-6.1	2	-46.1	-4.3	5.4
2.4617	12.4	16.4	-6	2	-46	-4.2	7.1
2.46175	12.3	16.4	-6.1	2	-46.1	-4.3	5.8
2.4618	12.2	16.4	-6.2	2	-46.2	-4.4	6.5
2.46185	12.1	16.4	-6.3	2	-46.3	-4.5	5.7
2.4619	12	16.4	-6.4	2	-46.4	-4.6	6.2
2.46195	12	16.4	-6.4	2	-46.4	-4.6	6.7
2.462	11.9	16.4	-6.5	2	-46.5	-4.7	6.2
2.46205	12	16.4	-6.4	2	-46.4	-4.6	6.7
2.4621	12.1	16.4	-6.3	2	-46.3	-4.5	5.7
2.46215	12.2	16.4	-6.2	2	-46.2	-4.4	6.6
2.4622	12.3	16.4	-6.1	2	-46.1	-4.3	5.8
2.46225	12.4	16.4	-6	2	-46	-4.2	5.2

2.4623	12.5	16.4	-5.9	2	-45.9	-4.1	7.3
2.46235	12.4	16.4	-6	2	-46	-4.2	5.5
2.4624	12.4	16.4	-6	2	-46	-4.2	7.3
2.46245	12.3	16.4	-6.1	2	-46.1	-4.3	6.2
11Mbps CHANNEL 11 Processing Gain							
$G_p = (S/N)_o + M_j + L_{sys}$							
Freq. (GHz)	G_p (dB)	$(S/N)_o$ (dB)	$M_j = J/S$ (dB)	L_{sys} (dB)	Jammer (dBm)	LVL (dBm)	FER %
2.4625	12.3	16.4	-6.1	2	-46.1	-4.3	6.4
2.46255	12.3	16.4	-6.1	2	-46.1	-4.3	6.5
2.4626	12.3	16.4	-6.1	2	-46.1	-4.3	7.2
2.46265	12.3	16.4	-6.1	2	-46.1	-4.3	7.6
2.4627	12.2	16.4	-6.2	2	-46.2	-4.4	6.3
2.46275	12.3	16.4	-6.1	2	-46.1	-4.3	7.1
2.4628	12.3	16.4	-6.1	2	-46.1	-4.3	7.9
2.46285	12.3	16.4	-6.1	2	-46.1	-4.3	7.2
2.4629	12.2	16.4	-6.2	2	-46.2	-4.4	6.6
2.46295	12.2	16.4	-6.2	2	-46.2	-4.4	6.7
2.463	12.2	16.4	-6.2	2	-46.2	-4.4	7.8
2.46305	12.1	16.4	-6.3	2	-46.3	-4.5	7.2
2.4631	12	16.4	-6.4	2	-46.4	-4.6	6.5
2.46315	11.9	16.4	-6.5	2	-46.5	-4.7	5.6
2.4632	11.9	16.4	-6.5	2	-46.5	-4.7	7.5
2.46325	11.8	16.4	-6.6	2	-46.6	-4.8	6.3
2.4633	11.8	16.4	-6.6	2	-46.6	-4.8	6.8
2.46335	11.7	16.4	-6.7	2	-46.7	-4.9	5.9
2.4634	11.8	16.4	-6.6	2	-46.6	-4.8	7.1
2.46345	11.8	16.4	-6.6	2	-46.6	-4.8	7.5
2.4635	11.9	16.4	-6.5	2	-46.5	-4.7	5.8
2.46355	11.9	16.4	-6.5	2	-46.5	-4.7	7.2
2.4636	12	16.4	-6.4	2	-46.4	-4.6	7.4
2.46365	12	16.4	-6.4	2	-46.4	-4.6	6.8
2.4637	12.1	16.4	-6.3	2	-46.3	-4.5	7.9
2.46375	12.1	16.4	-6.3	2	-46.3	-4.5	5.8
2.4638	12	16.4	-6.4	2	-46.4	-4.6	6.8
2.46385	12	16.4	-6.4	2	-46.4	-4.6	7.6
2.4639	11.9	16.4	-6.5	2	-46.5	-4.7	5.7
2.46395	11.8	16.4	-6.6	2	-46.6	-4.8	6.9
2.464	11.8	16.4	-6.6	2	-46.6	-4.8	7.5
2.46405	11.8	16.4	-6.6	2	-46.6	-4.8	7.8
2.4641	11.8	16.4	-6.6	2	-46.6	-4.8	7.6
2.46415	11.8	16.4	-6.6	2	-46.6	-4.8	6.6
2.4642	11.9	16.4	-6.5	2	-46.5	-4.7	7.2
2.46425	12	16.4	-6.4	2	-46.4	-4.6	7.4
2.4643	12.1	16.4	-6.3	2	-46.3	-4.5	7.2
2.46435	12.2	16.4	-6.2	2	-46.2	-4.4	7.4

2.4644	12.2	16.4	-6.2	2	-46.2	-4.4	6.8
2.46445	12.2	16.4	-6.2	2	-46.2	-4.4	6.2
2.4645	12.2	16.4	-6.2	2	-46.2	-4.4	7.9
2.46455	12.1	16.4	-6.3	2	-46.3	-4.5	6.8
2.4646	12	16.4	-6.4	2	-46.4	-4.6	6.1
2.46465	12	16.4	-6.4	2	-46.4	-4.6	6.3
2.4647	12.1	16.4	-6.3	2	-46.3	-4.5	7.4

11Mbps CHANNEL 11 Processing Gain							
Gp = (S/N)o + Mj + Lsys							
Freq. (GHz)	Gp (dB)	(S/N)o (dB)	Mj = J/S (dB)	Lsys (dB)	Jammer (dBm)	LVL (dBm)	FER %
2.46475	12.1	16.4	-6.3	2	-46.3	-4.5	6.1
2.4648	12.2	16.4	-6.2	2	-46.2	-4.4	6.7
2.46485	12.3	16.4	-6.1	2	-46.1	-4.3	7.5
2.4649	12.3	16.4	-6.1	2	-46.1	-4.3	5.9
2.46495	12.5	16.4	-5.9	2	-45.9	-4.1	7.5
2.465	12.6	16.4	-5.8	2	-45.8	-4	6.8
2.46505	12.7	16.4	-5.7	2	-45.7	-3.9	6.9
2.4651	12.7	16.4	-5.7	2	-45.7	-3.9	5.8
2.46515	12.8	16.4	-5.6	2	-45.6	-3.8	7.6
2.4652	12.7	16.4	-5.7	2	-45.7	-3.9	6.2
2.46525	12.7	16.4	-5.7	2	-45.7	-3.9	4.7
2.4653	12.7	16.4	-5.7	2	-45.7	-3.9	7.1
2.46535	12.6	16.4	-5.8	2	-45.8	-4	5.9
2.4654	12.7	16.4	-5.7	2	-45.7	-3.9	7.7
2.46545	12.7	16.4	-5.7	2	-45.7	-3.9	5.8
2.4655	12.7	16.4	-5.7	2	-45.7	-3.9	6.2
2.46555	12.9	16.4	-5.5	2	-45.5	-3.7	5.8
2.4656	12.9	16.4	-5.5	2	-45.5	-3.7	6.2
2.46565	13.1	16.4	-5.3	2	-45.3	-3.5	6.7
2.4657	13.2	16.4	-5.2	2	-45.2	-3.4	6.8
2.46575	13.3	16.4	-5.1	2	-45.1	-3.3	6.5
2.4658	13.3	16.4	-5.1	2	-45.1	-3.3	5.7
2.46585	13.4	16.4	-5	2	-45	-3.2	7.1
2.4659	13.4	16.4	-5	2	-45	-3.2	7.1
2.46595	13.4	16.4	-5	2	-45	-3.2	7.4
2.466	13.4	16.4	-5	2	-45	-3.2	7.7
2.46605	13.4	16.4	-5	2	-45	-3.2	7.5
2.4661	13.4	16.4	-5	2	-45	-3.2	6.7
2.46615	13.5	16.4	-4.9	2	-44.9	-3.1	7.2
2.4662	13.6	16.4	-4.8	2	-44.8	-3	7.3
2.46625	13.7	16.4	-4.7	2	-44.7	-2.9	5.7
2.4663	13.8	16.4	-4.6	2	-44.6	-2.8	5.9
2.46635	13.9	16.4	-4.5	2	-44.5	-2.7	6.5
2.4664	14.2	16.4	-4.2	2	-44.2	-2.4	5.8
2.46645	14.2	16.4	-4.2	2	-44.2	-2.4	5.8
2.4665	14.3	16.4	-4.1	2	-44.1	-2.3	6.5
2.46655	14.3	16.4	-4.1	2	-44.1	-2.3	5.8
2.4666	14.3	16.4	-4.1	2	-44.1	-2.3	5.6
2.46665	14.4	16.4	-4	2	-44	-2.2	7.7
2.4667	14.4	16.4	-4	2	-44	-2.2	7.2
2.46675	14.5	16.4	-3.9	2	-43.9	-2.1	7.8

2.4668	14.5	16.4	-3.9	2	-43.9	-2.1	5.7
2.46685	14.6	16.4	-3.8	2	-43.8	-2	6.5
2.4669	14.7	16.4	-3.7	2	-43.7	-1.9	5.6
2.46695	14.9	16.4	-3.5	2	-43.5	-1.7	7.6
11Mbps CHANNEL 11 Processing Gain							
$G_p = (S/N)_o + M_j + L_{sys}$							
Freq. (GHz)	Gp (dB)	(S/N) _o (dB)	M _j = J/S (dB)	L _{sys} (dB)	Jammer (dBm)	LVL (dBm)	FER %
2.467	15	16.4	-3.4	2	-43.4	-1.6	5.6
2.46705	15.1	16.4	-3.3	2	-43.3	-1.5	5.5
2.4671	15.3	16.4	-3.1	2	-43.1	-1.3	5.5
2.46715	15.5	16.4	-2.9	2	-42.9	-1.1	6.4
2.4672	15.6	16.4	-2.8	2	-42.8	-1	7.1
2.46725	15.7	16.4	-2.7	2	-42.7	-0.9	6.8
2.4673	15.6	16.4	-2.8	2	-42.8	-1	5.7
2.46735	15.7	16.4	-2.7	2	-42.7	-0.9	6.7
2.4674	15.8	16.4	-2.6	2	-42.6	-0.8	6.4
2.46745	15.9	16.4	-2.5	2	-42.5	-0.7	6.6
2.4675	16.1	16.4	-2.3	2	-42.3	-0.5	6.8
2.46755	16.2	16.4	-2.2	2	-42.2	-0.4	6.3
2.4676	16.4	16.4	-2	2	-42	-0.2	6.5
2.46765	16.6	16.4	-1.8	2	-41.8	0	6.1
2.4677	16.8	16.4	-1.6	2	-41.6	0.2	5.6
2.46775	17.1	16.4	-1.3	2	-41.3	0.5	7.2
2.4678	17.3	16.4	-1.1	2	-41.1	0.7	6.5
2.46785	17.5	16.4	-0.9	2	-40.9	0.9	7.2
2.4679	17.5	16.4	-0.9	2	-40.9	0.9	6.1
2.46795	17.6	16.4	-0.8	2	-40.8	1	6.8
2.468	17.7	16.4	-0.7	2	-40.7	1.1	7.3
2.46805	17.5	16.4	-0.9	2	-40.9	0.9	5.6
2.4681	17.4	16.4	-1	2	-41	0.8	5.1
2.46815	17.5	16.4	-0.9	2	-40.9	0.9	7.4
2.4682	17.5	16.4	-0.9	2	-40.9	0.9	6.9
2.46825	17.6	16.4	-0.8	2	-40.8	1	5.8
2.4683	17.7	16.4	-0.7	2	-40.7	1.1	7.9
2.46835	17.7	16.4	-0.7	2	-40.7	1.1	4.9
2.4684	18	16.4	-0.4	2	-40.4	1.4	5.6
2.46845	18.3	16.4	-0.1	2	-40.1	1.7	6.2
2.4685	18.7	16.4	0.3	2	-39.7	2.1	7.3
2.46855	18.9	16.4	0.5	2	-39.5	2.3	6.4
2.4686	18.9	16.4	0.5	2	-39.5	2.3	6.5
2.46865	19	16.4	0.6	2	-39.4	2.4	7.5
2.4687	18.9	16.4	0.5	2	-39.5	2.3	6.3
2.46875	19	16.4	0.6	2	-39.4	2.4	7.8
2.4688	19.1	16.4	0.7	2	-39.3	2.5	7.6
2.46885	19.1	16.4	0.7	2	-39.3	2.5	5.8

2.4689	19.1	16.4	0.7	2	-39.3	2.5	5.7
2.46895	19.1	16.4	0.7	2	-39.3	2.5	7.7
2.469	19.1	16.4	0.7	2	-39.3	2.5	5.8
2.46905	18.9	16.4	0.5	2	-39.5	2.3	4.8
2.4691	18.7	16.4	0.3	2	-39.7	2.1	6.4
2.46915	18.6	16.4	0.2	2	-39.8	2	5.6
2.4692	18.6	16.4	0.2	2	-39.8	2	7.1

11Mbps CHANNEL 11 Processing Gain							
Gp = (S/N)o + Mj + Lsys							
Freq. (GHz)	Gp (dB)	(S/N)o (dB)	Mj = J/S (dB)	Lsys (dB)	Jammer (dBm)	LVL (dBm)	FER %
2.46925	18.6	16.4	0.2	2	-39.8	2	6.1
2.4693	18.6	16.4	0.2	2	-39.8	2	5.5
2.46935	18.8	16.4	0.4	2	-39.6	2.2	6.9
2.4694	19	16.4	0.6	2	-39.4	2.4	6.4
2.46945	19.3	16.4	0.9	2	-39.1	2.7	5.9
2.4695	19.6	16.4	1.2	2	-38.8	3	6.3
2.46955	19.8	16.4	1.4	2	-38.6	3.2	6.4
2.4696	19.9	16.4	1.5	2	-38.5	3.3	5.6
2.46965	20	16.4	1.6	2	-38.4	3.4	6.6
2.4697	20	16.4	1.6	2	-38.4	3.4	6.2
2.46975	20.1	16.4	1.7	2	-38.3	3.5	6.9
2.4698	20.1	16.4	1.7	2	-38.3	3.5	6.3
2.46985	20.2	16.4	1.8	2	-38.2	3.6	7.8
2.4699	20.2	16.4	1.8	2	-38.2	3.6	5.5
2.46995	20.2	16.4	1.8	2	-38.2	3.6	5.5
2.47	20.1	16.4	1.7	2	-38.3	3.5	5.7
2.47005	20	16.4	1.6	2	-38.4	3.4	6.8
2.4701	19.8	16.4	1.4	2	-38.6	3.2	7.1
2.47015	19.7	16.4	1.3	2	-38.7	3.1	5.7
2.4702	19.7	16.4	1.3	2	-38.7	3.1	6.4
2.47025	19.7	16.4	1.3	2	-38.7	3.1	6.3
2.4703	19.8	16.4	1.4	2	-38.6	3.2	6.2
2.47035	20	16.4	1.6	2	-38.4	3.4	6.6
2.4704	20.3	16.4	1.9	2	-38.1	3.7	7.6
2.47045	20.5	16.4	2.1	2	-37.9	3.9	6.3
2.4705	20.8	16.4	2.4	2	-37.6	4.2	5.7
Processing Gain(dB) @ 20th Percentile = 12							

9. EMI Reduction Method During Compliance Testing

No modification was made during testing.

10. Attachment

Attachment 1: EUT Test Photographs Number of Pages : 3

Attachment 2: EUT Detailed Photographs Number of Pages : 5

Attachment 1 : EUT Test Photographs

Attachment 2 : EUT Detailed Photographs