



FCC PART 90

TEST REPORT

For

Quanzhou Chierda Electronic Telecom Co., Ltd.

No.8, Zi'an Road, Jiangnan High-tech Industrial Zone Licheng District, Quanzhou Fujian, China

FCC ID: OA8-TC328PLUS

Report Type: Original Report	Product Name: Two Way Radio
Report Number:	<u>2407X57682E-RF-01</u>
Report Date:	<u>2024-12-17</u>
Reviewed By:	<u>Ash Lin</u> <i>Ash Lin</i>
Approved By:	<u>Miles Chen</u>
Prepared By:	Bay Area Compliance Laboratories Corp. (Xiamen) Unit 102, No. 902 Meifeng South Road, Binhai West Avenue, Science and Technology Innovation Park, Torch High tech Zone XiaMen Tel: +86-592-3200111 www.baclcorp.com.cn

TABLE OF CONTENTS

REPORT REVISION HISTORY	4
GENERAL INFORMATION.....	5
PRODUCT DESCRIPTION FOR EQUIPMENT UNDER TEST (EUT).....	5
ANTENNA INFORMATION	5
OBJECTIVE	5
TEST METHODOLOGY	5
MEASUREMENT UNCERTAINTY.....	6
TEST FACILITY	6
SYSTEM TEST CONFIGURATION.....	7
TEST MODE AND VOLTAGE.....	7
TEST FREQUENCY DETAIL	7
DESCRIPTION OF TEST CONFIGURATION	7
SPECIAL ACCESSORIES.....	7
EQUIPMENT MODIFICATIONS	7
SUPPORT EQUIPMENT LIST AND DETAILS	7
BLOCK DIAGRAM OF TEST SETUP	8
SUMMARY OF TEST RESULTS	9
TEST EQUIPMENT LIST	10
FCC §2.1046 & §90.205 RF OUTPUT POWER.....	11
APPLICABLE STANDARD	11
TEST PROCEDURE	11
EUT SETUP BLOCK DIAGRAM	12
TEST DATA	12
FCC §2.1047 - MODULATION CHARACTERISTIC	22
APPLICABLE STANDARD	22
TEST PROCEDURE	22
TEST DATA	23
FCC §2.1049 & §90.209 §90.210- OCCUPIED BANDWIDTH & EMISSION MASK	35
APPLICABLE STANDARD	35
TEST PROCEDURE	35
EUT SETUP BLOCK DIAGRAM	36
TEST DATA	37
FCC § 2.1051 & § 90.210 - SPURIOUS EMISSIONS AT ANTENNA TERMINALS	56
APPLICABLE STANDARD	56
TEST PROCEDURE	56
EUT SETUP BLOCK DIAGRAM	57
TEST DATA	57
FCC §2.1053 & §90.210 - SPURIOUS RADIATED EMISSIONS	85
APPLICABLE STANDARD	85
TEST SETUP	85
TEST PROCEDURE	86
TEST DATA	87
FCC §2.1055 & §90.213 - FREQUENCY STABILITY.....	97
APPLICABLE STANDARD	97
TEST PROCEDURE	97
EUT SETUP BLOCK DIAGRAM	98

TEST DATA	98
FCC §90.214 - TRANSIENT FREQUENCY BEHAVIOR.....	100
APPLICABLE STANDARD	100
TEST PROCEDURE	100
EUT SETUP BLOCK DIAGRAM	100
TEST DATA	101
EUT PHOTOGRAPHS.....	103
TEST SETUP PHOTOGRAPHS	104

REPORT REVISION HISTORY

Number of Revisions	Report No.	Version	Issue Date	Description
0	2407X57682E-RF-01	R1V1	2024-12-17	Initial Release

GENERAL INFORMATION

Product Description for Equipment under Test (EUT)

Applicant:		Quanzhou Chierda Electronic Telecom Co., Ltd.
Tested Model:		TC328Plus
Series Model(s):		TC328D, TC368D, TC338D, TC328Pro
Product Name:		Two Way Radio
Power Supply:		DC 7.4V from battery or DC 5V from charger or DC 5V from adapter
Charger Information	Model:	DC30
	Input:	DC 5V, 1A
	Output:	DC 5V, 1A
Rated Output Power:		4FSK:High Power: 4.5W; Midium Power:4.0W; Low Power: 1.0W FM: High Power: 4.5W; Midium Power:4.0W; Low Power: 1.0W
RF Function:		UHF
Operating Band/Frequency:		400-480MHz
Modulation Type:		FM, 4FSK
Channel Separation:		FM: 12.5 kHz 4FSK: 12.5 kHz
<p><i>Note:</i></p> <p>1. The series models are identical with the tested model except for the model name and sales channel; please refer to declaration letter for more detail.</p> <p>2. All measurement and test data in this report was gathered from production sample serial number: 2S56-1 (Assigned by the BACL (Xiamen). The EUT supplied by the applicant was received on 2024-09-25).</p>		

Antenna Information

Antenna Manufacturer	Antenna Type	Antenna Connector	input impedance (Ohm)	Antenna Gain /Frequency Range
Quanzhou Chierda Electronic Telecom Co., Ltd.	Whip	SMA	50	2.15 dBi / 400-480MHz
<p><i>Note: The Antenna information is provided by applicant.</i></p>				

Objective

This test report is prepared for *Quanzhou Chierda Electronic Telecom Co., Ltd.* in accordance with Part 2, and Part 90 of the Federal Communication Commissions rules.

Test Methodology

All tests and measurements indicated in this document were performed in accordance with the Code of federal Regulations Title 47 Part 2, Sub-part J as well as Part the following individual parts:

Part90-Private Land Mobile Radio Service

Applicable Standards: ANSI C63.26:2015.

All emissions measurement was performed at Bay Area Compliance Laboratories Corp. (Xiamen). The radiated testing was performed at an antenna-to-EUT distance of 3 meters.

Measurement Uncertainty

Item	Ulab
Unwanted Emissions, radiated	3.8dB
Power Spectral Density	±0.61dB
Occupied Channel Bandwidth	0.053kHz
RF output power, conducted	±0.61dB
Unwanted Emissions, conducted	±1.5dB
Temperature	±1°C
Humidity	±5%
DC and low frequency voltages	±0.4%
Duty Cycle	1%
Frequency Error(RF Frequency)	0.082×10 ⁶
Audio Frequency/Low Pass Filter Response	3.98%
Modulation Limiting	1.11%

Test Facility

The test site used by Bay Area Compliance Laboratories Corp. (Xiamen) to collect test data is located on the Unit 102, No. 902 Meifeng South Road, Binhai West Avenue, Science and Technology Innovation Park, Torch High tech Zone Xiamen.

Bay Area Compliance Laboratories Corp. (Xiamen) Lab is accredited to ISO/IEC 17025 by A2LA (Certificate Number: 7134.01) and the lab has been recognized as the FCC accredited lab under the KDB 974614 D01, the FCC Designation No. : CN1384.

SYSTEM TEST CONFIGURATION

Test Mode and Voltage

The system was configured for testing in a typical mode (as normally used by a typical user).	
Test mode:	Transmitting
Test voltage:	DC 7.4V from battery

Test Frequency Detail

Per C63.26-2015, section 5.1, the lowest frequency, middle frequency, and highest frequency was performed the test as below:

Modulation/ Channel Bandwidth	Test Channel	Frequency (MHz)	Rule Part
FM 12.5kHz	Lowest	400.0125	For Part 90
	Middle	453.2125	For Part 90
	Highest	479.9875	For Part 90
4FSK 12.5kHz	Lowest	400.0125	For Part 90
	Middle	453.2125	For Part 90
	Highest	479.9875	For Part 90

Description of Test Configuration

The EUT was configured for testing in an engineering mode which was provided by the manufacturer.

Special Accessories

No special accessory was used.

Equipment Modifications

No modification was made to the EUT tested.

Support Equipment List and Details

Manufacturer	Description	Model	Serial Number
Unknown	50W load	20230613	121901

Block Diagram of Test Setup

For Radiated Emissions
Below 1GHz:

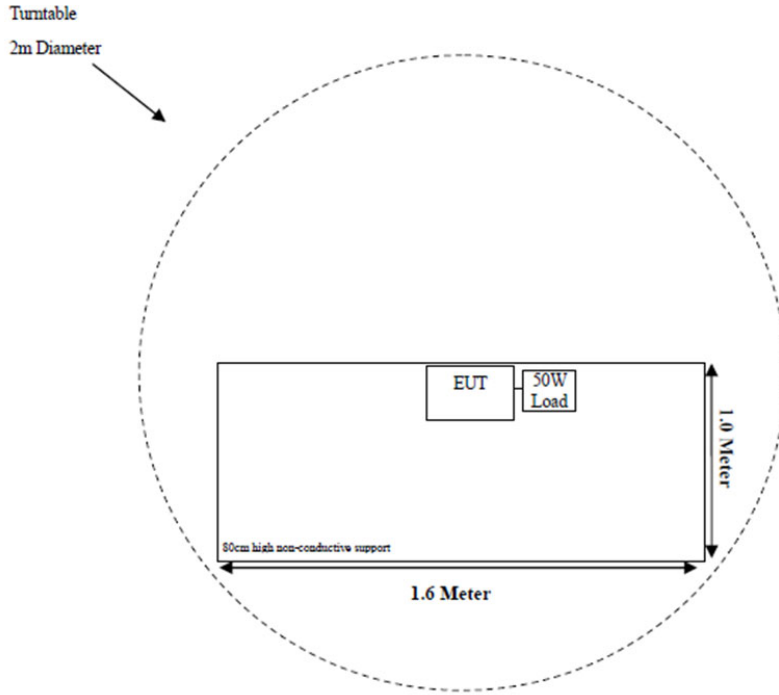

Above 1 GHz:

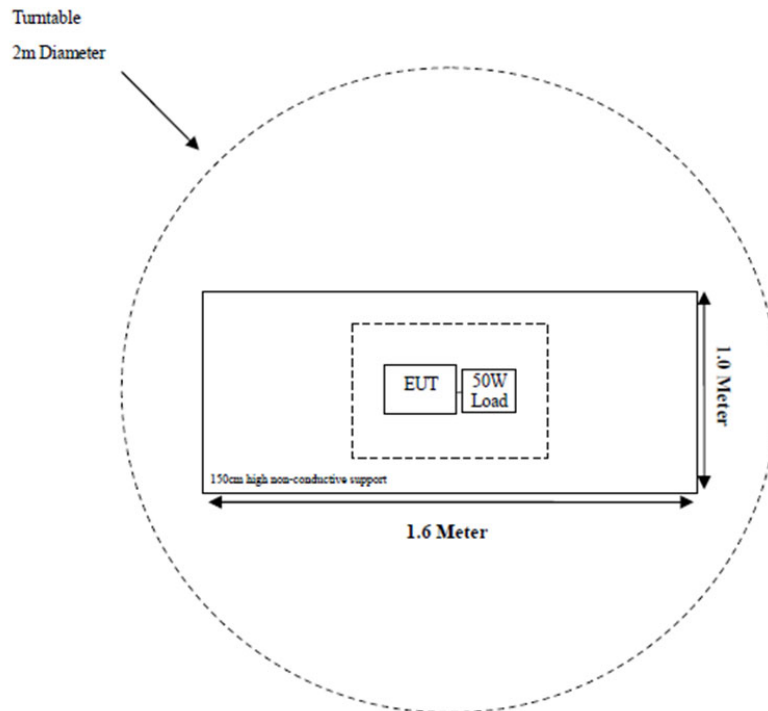

SUMMARY OF TEST RESULTS

FCC Rules	Description of Test	Results
§2.1046, §90.205	RF Output Power	Compliant
§2.1047	Modulation Characteristic	Compliant
§2.1049; §90.209; §90.210	Occupied Bandwidth & Emission Mask	Compliant
§2.1051; §90.210	Spurious Emission at Antenna Terminal	Compliant
§2.1053; §90.210	Spurious Radiated Emissions	Compliant
§2.1055; §90.213	Frequency stability	Compliant
§90.214	Transient Frequency Behavior	Compliant

TEST EQUIPMENT LIST

Test Equipment	Manufacturer	Model	Serial Number	Calibration Date	Calibration Due Date
Radiated Emissions					
Hybrid Antenna	Sunol Sciences	JB6	A122022-5	2023/07/27	2026/07/26
Amplifier	Sonoma	310B	120903	2024/03/29	2025/03/28
EMI Test Receiver	Rohde & Schwarz	ESR	103103	2024/03/29	2025/03/28
Coaxial Cable	XINHANGWEIBO	XH400T-N-4M	CC002	2024/03/29	2025/03/28
Coaxial Cable	XINHANGWEIBO	XH460B-N-2M	CC006	2024/03/29	2025/03/28
Coaxial Cable	XINHANGWEIBO	XH460B-N-12M	CC007	2024/03/29	2025/03/28
Spectrum Analyzer	Rohde & Schwarz	FSV40-N	102051	2024/03/29	2025/03/28
Double Ridge Guide Horn Antenna	A.H.Systems	SAS-571	1980	2023/07/28	2026/07/27
Preamplifier	A.H.Systems	PAM-0118P	489	2024/03/29	2025/03/28
Coaxial Cable	XINHANGWEIBO	XH800A-N-6M	CC003	2024/03/29	2025/03/28
Coaxial Cable	XINHANGWEIBO	XH800A-N-1M	CC005	2024/03/29	2025/03/28
Dipole Antenna	EMCO	3121C	9209-860	N/A	N/A
Double Ridge Guide Horn Antenna	A.R.A	DRG-118/A	1057	2023/07/28	2026/07/27
Microwave Analog Signal Generator	Agilent	N5181A	MY48180319	2024/03/29	2025/03/28
RF Conducted Test					
Spectrum Analyzer	Rohde & Schwarz	FSU	100405	2024/03/29	2025/03/28
Coaxial Cable	N/A	N/A	N/A	Each time	Each time
Attenuator	Electronic Corporation	300-WA-FFN-30	1172435	2024/03/29	2025/03/28
DC Power Supply	MAISHENG	MS-606DS	N/A	N/A	N/A
Multimeter	deli	DL8490	23930192	2024/03/29	2025/03/28
RF Communications test set	HP	8920A	3524A07202	2024/04/26	2025/04/25
constant temperature and humidity testing machine	BACL	BTH-150	30211	2024/03/29	2025/03/28
Spectrum Analyzer	R&S	FSIQ26	831929	2024/03/29	2025/03/28
Audio Analyzer	R&S	UPV	101782	2024/03/29	2025/03/28
2 Way power divider	narda	4426LB-2	1661	Each time	Each time

Statement of Traceability: Bay Area Compliance Laboratories Corp. (Xiamen) attests that all calibrations have been performed in accordance to requirements that traceable to National Primary Standards and International System of Units (SI).

FCC §2.1046 & §90.205 RF OUTPUT POWER

Applicable Standard

FCC § 90.205

(d) 150-174 MHz. (1) The maximum allowable station ERP is dependent upon the station's antenna HAAT and required service area and will be authorized in accordance with table 1. Applicants requesting an ERP in excess of that listed in table 1 must submit an engineering analysis based upon generally accepted engineering practices and standards that includes coverage contours to demonstrate that the requested station parameters will not produce coverage in excess of that which the applicant requires.

(h) 450-470 MHz.

(1) The maximum allowable station effective radiated power (ERP) is dependent upon the station's antenna HAAT and required service area and will be authorized in accordance with table 2. Applicants requesting an ERP in excess of that listed in table 2 must submit an engineering analysis based upon generally accepted engineering practices and standards that includes coverage contours to demonstrate that the requested station parameters will not produce coverage in excess of that which the applicant requires.

(2) Applications for stations where special circumstances exist that make it necessary to deviate from the ERP and antenna heights in Table 2 will be submitted to the frequency coordinator accompanied by a technical analysis, based upon generally accepted engineering practices and standards, that demonstrates that the requested station parameters will not produce a signal strength in excess of 39 dBu at any point along the edge of the requested service area. The coordinator may then recommend any ERP appropriate to meet this condition.

(3) An applicant for a station with a service area radius greater than 32 km (20 mi) must justify the requested service area radius, which may be authorized only in accordance with table 2, note 4. For base stations with service areas greater than 80 km, all operations 80 km or less from the base station will be on a primary basis and all operations outside of 80 km from the base station will be on a secondary basis and will be entitled to no protection from primary operations.

Test Procedure

C63.26-2015, Clause 5.2.3.3

This procedure can be used to measure the peak power in either a CW-like or noise-like narrowband RF signal. The measurement instrument must have a RBW that is greater than or equal to the OBW of the signal to be measured and a VBW $\geq 3 \times$ RBW.

- a) Set the RBW \geq OBW.
- b) Set VBW $\geq 3 \times$ RBW.
- c) Set span $\geq 2 \times$ OBW.
- d) Sweep time $\geq 10 \times$ (number of points in sweep) \times (transmission symbol period).
- e) Detector = peak.
- f) Trace mode = max hold.
- g) Allow trace to fully stabilize.
- h) Use the peak marker function to determine the peak amplitude level

EUT Setup Block Diagram

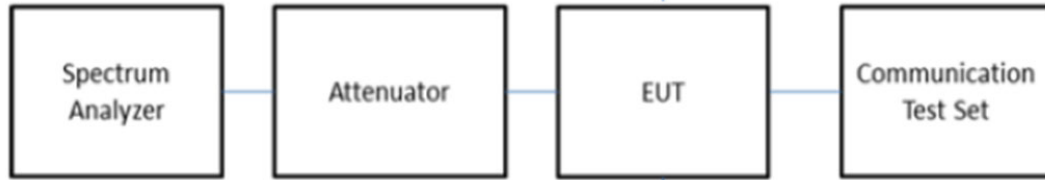

Test Data

Test Mode:	Transmitting	Test Engineer:	Lucas Lin
Test Date:	2024-11-28~2024-12-02	Test Result:	Compliant

Environment Conditions:					
Temperature: (°C)	23.7-24.3	Relative Humidity: (%)	49-51	ATM Pressure: (kPa)	100.1-100.2

Please refer to following table.

Modulation Mode	Channel Separation	f _c MHz	Reading (dBm)			Limit (dBm)		
			High Power Level	Medium Power Level	Low Power Level	High Power Level	Medium Power Level	Low Power Level
FM	12.5kHz	400.0125	36.58	35.99	29.62	35.56~37.32	35.05~36.81	29.03~30.79
		453.2125	36.69	36.33	30.42	35.56~37.32	35.05~36.81	29.03~30.79
		479.9875	36.39	35.97	29.75	35.56~37.32	35.05~36.81	29.03~30.79
4FSK	12.5kHz	400.0125	36.59	36.04	29.15	35.56~37.32	35.05~36.81	29.03~30.79
		453.2125	36.77	36.48	30.67	35.56~37.32	35.05~36.81	29.03~30.79
		479.9875	36.69	36.25	30.14	35.56~37.32	35.05~36.81	29.03~30.79

Note:

1. The rated power level is: 4FSK: 4.5W (36.53dBm), 4W (36.02dBm), 1.0W (30 dBm); FM: 4.5W (36.53dBm), 4W(36.02dBm), 1.0W (30 dBm).

The 31dB is the Insertion loss of the RF cable, Attenuators, which was offset into the Spectrum Analyzer

The output power shall not exceed by more than 20 percent the manufacturer's rated output power for the particular transmitter specifically listed on the authorization.

High Power-400.0125MHz (FM 12.5kHz)

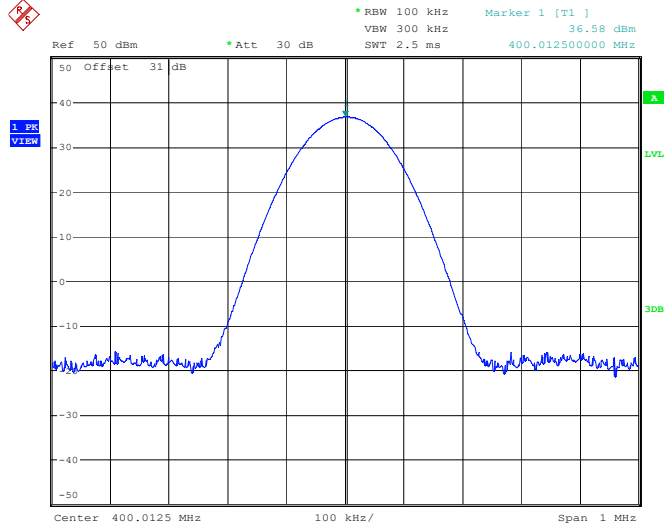

Project No.:2407X57682E-RF Tester:Lucas Lin
Date: 28.NOV.2024 10:34:43

Medium Power-400.0125MHz (FM 12.5kHz)

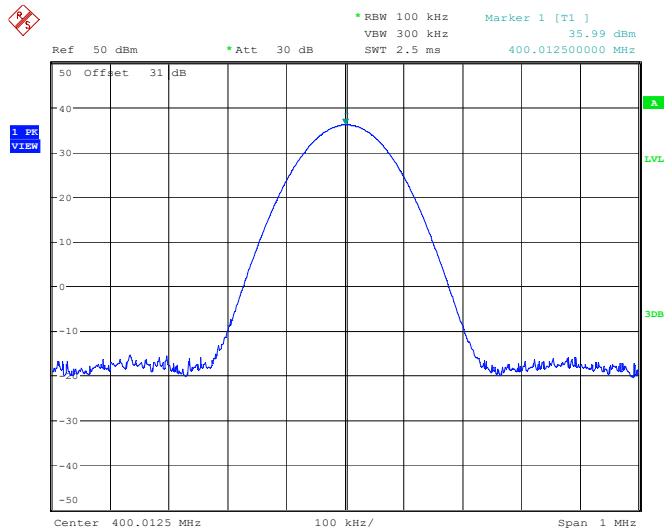

Project No.:2407X57682E-RF Tester:Lucas Lin
Date: 28.NOV.2024 10:37:27

Low Power-400.0125MHz (FM 12.5kHz)

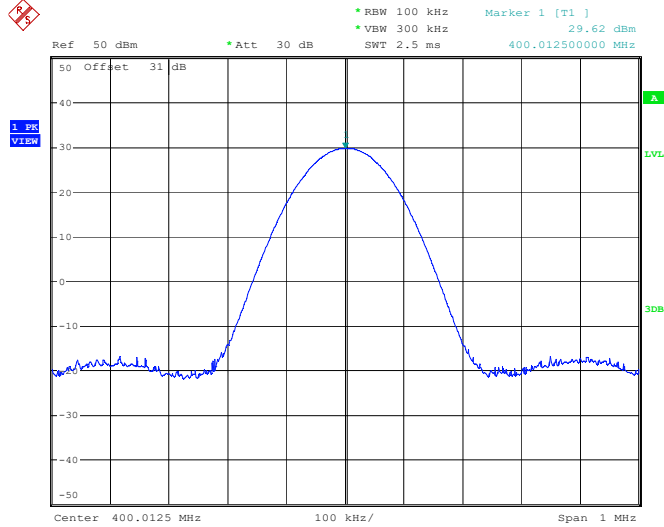

Project No.:2407X57682E-RF Tester:Lucas Lin
Date: 2.DEC.2024 08:51:51

High Power-453.2125MHz (FM 12.5kHz)

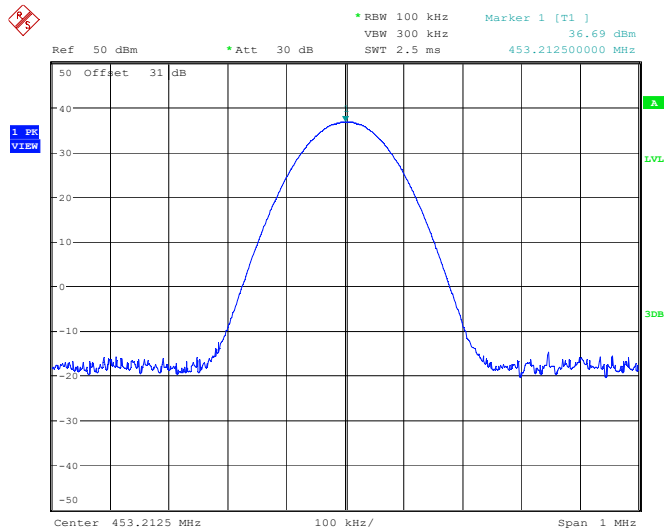

Project No.:2407X57682E-RF Tester:Lucas Lin
Date: 28.NOV.2024 10:37:57

Medium Power-453.2125MHz (FM 12.5kHz)

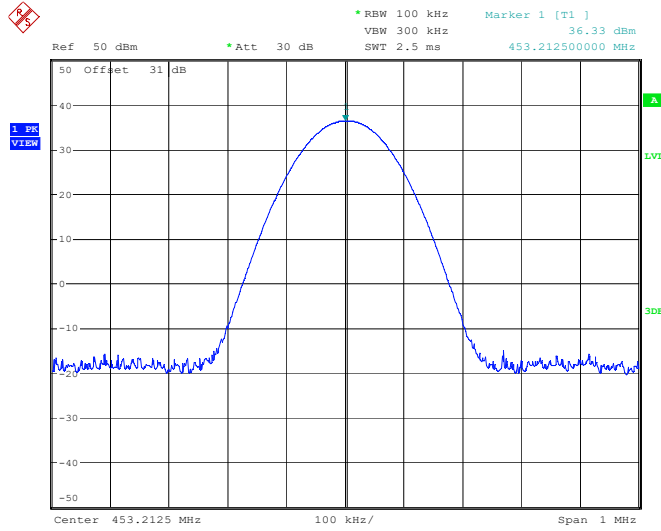

Project No.:2407X57682E-RF Tester:Lucas Lin
Date: 28.NOV.2024 10:38:32

Low Power-453.2125MHz (FM 12.5kHz)

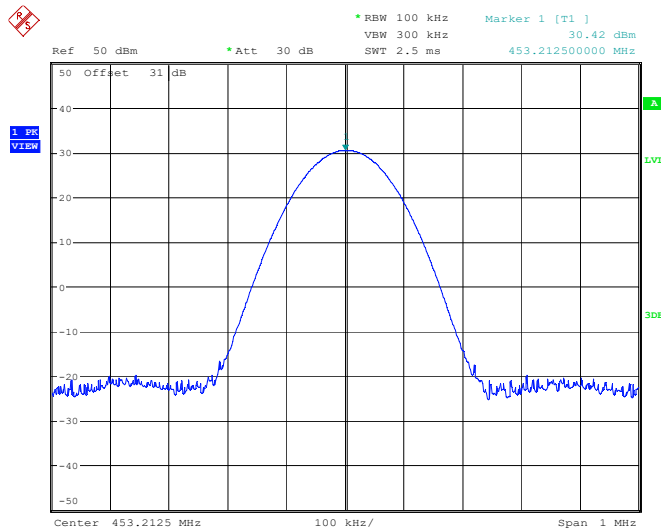

Project No.:2407X57682E-RF Tester:Lucas Lin
Date: 28.NOV.2024 12:52:04

High Power-479.9875MHz (FM 12.5kHz)

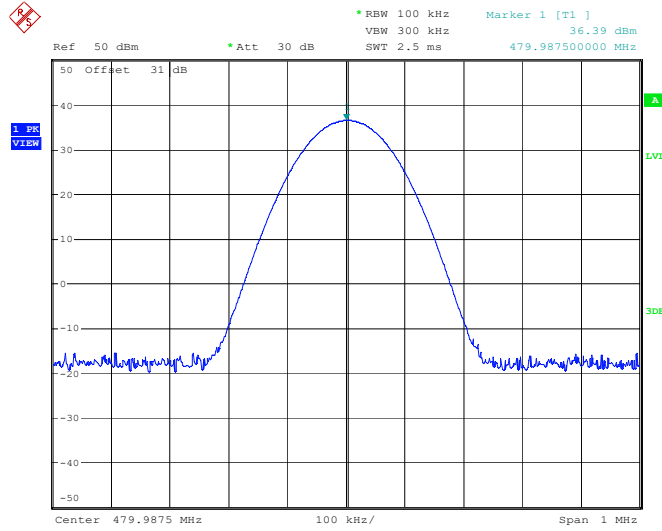

Project No.:2407X57682E-RF Tester:Lucas Lin
Date: 28.NOV.2024 10:39:02

Medium Power-479.9875MHz (FM 12.5kHz)

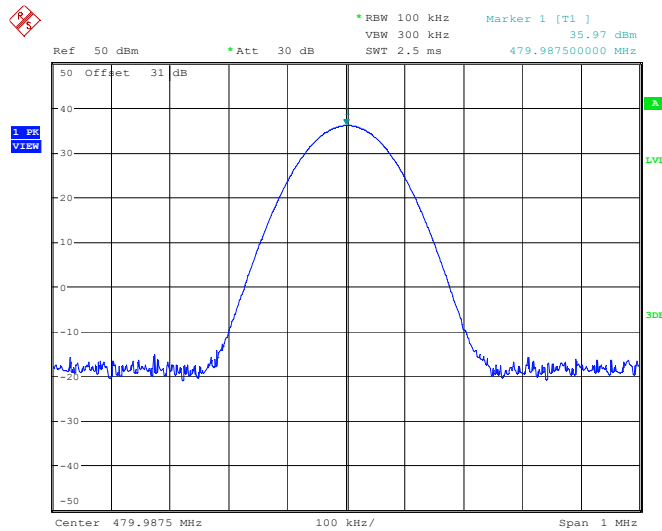

Project No.:2407X57682E-RF Tester:Lucas Lin
Date: 28.NOV.2024 10:39:43

Low Power-479.9875MHz (FM 12.5kHz)

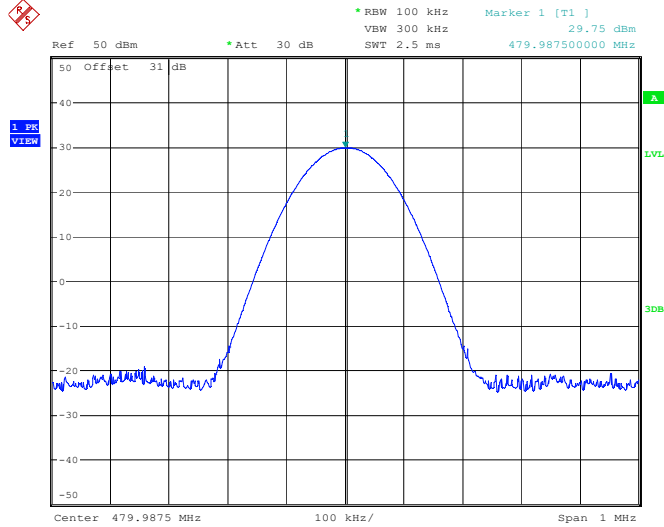

Project No.:2407X57682E-RF Tester:Lucas Lin
Date: 28.NOV.2024 10:56:17

High Power-400.0125MHz (4FSK 12.5kHz)

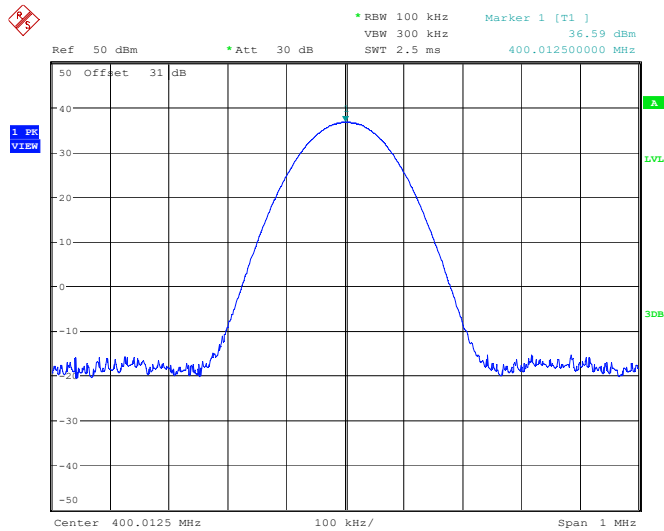

Project No.:2407X57682E-RF Tester:Lucas Lin
Date: 28.NOV.2024 10:42:28

Medium Power-400.0125MHz (4FSK 12.5kHz)

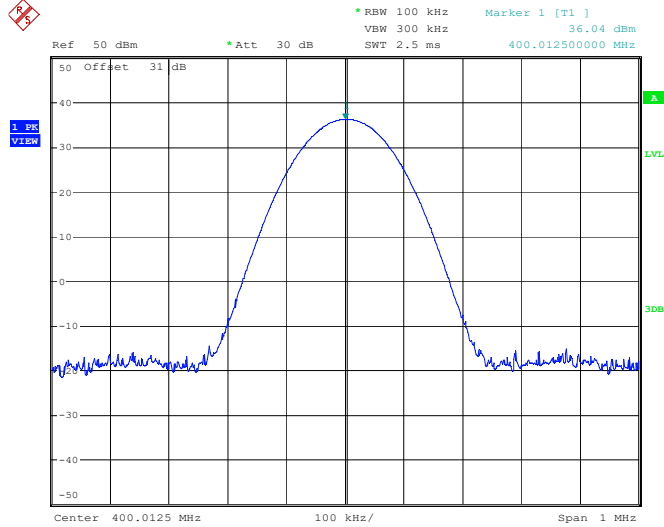

Project No.:2407X57682E-RF Tester:Lucas Lin
Date: 28.NOV.2024 10:43:05

Low Power-400.0125MHz (4FSK 12.5kHz)

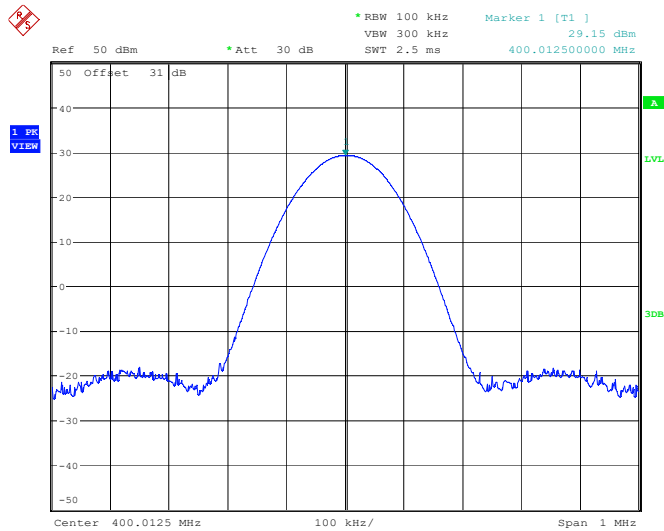

Project No.:2407X57682E-RF Tester:Lucas Lin
Date: 28.NOV.2024 10:42:45

High Power-453.2125MHz (4FSK 12.5kHz)

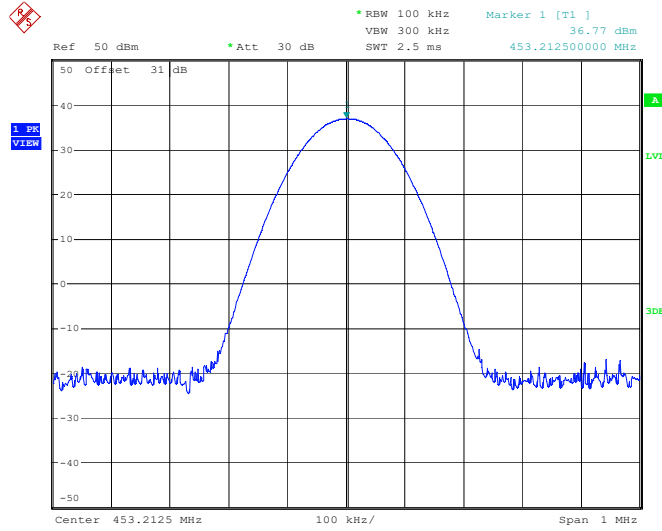

Project No.:2407X57682E-RF Tester:Lucas Lin
Date: 28.NOV.2024 12:14:45

Medium Power-453.2125MHz (4FSK 12.5kHz)

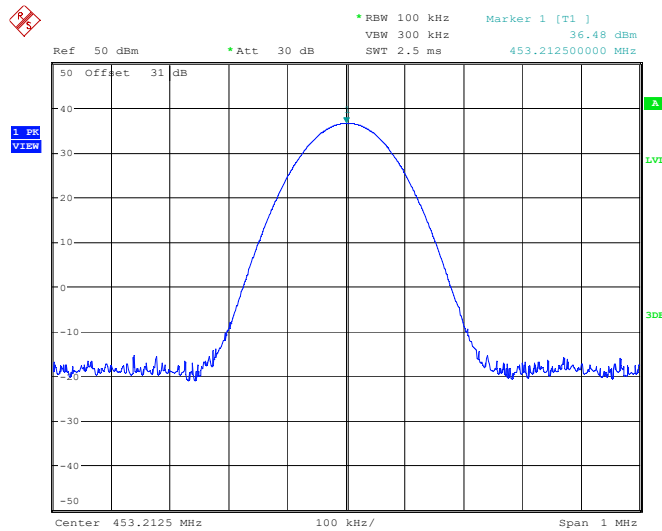

Project No.:2407X57682E-RF Tester:Lucas Lin
Date: 28.NOV.2024 10:42:03

Low Power-453.2125MHz (4FSK 12.5kHz)

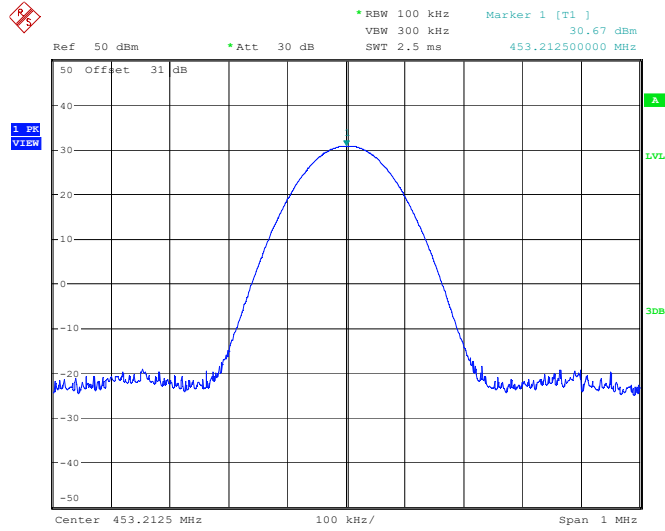

Project No.:2407X57682E-RF Tester:Lucas Lin
Date: 28.NOV.2024 12:50:58

High Power-479.9875MHz (4FSK 12.5kHz)

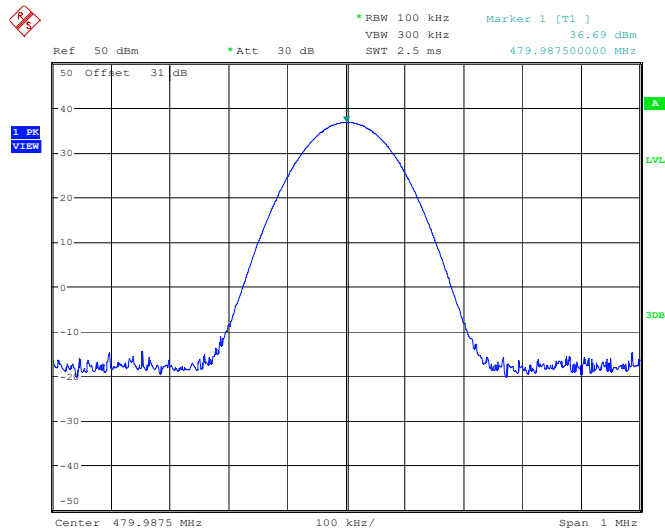

Project No.:2407X57682E-RF Tester:Lucas Lin
Date: 28.NOV.2024 10:40:18

FCC §2.1047 - MODULATION CHARACTERISTIC

Applicable Standard

FCC §2.1047

(a) Voice modulated communication equipment. A curve or equivalent data showing the frequency response of the audio modulating circuit over a range of 100 to 5000 Hz shall be submitted. For equipment required to have an audio low-pass filter, a curve showing the frequency response of the filter, or of all circuitry installed between the modulation limiter and the modulated stage shall be submitted.

(b) Equipment which employs modulation limiting. A curve or family of curves showing the percentage of modulation versus the modulation input voltage shall be supplied. The information submitted shall be sufficient to show modulation limiting capability throughout the range of modulating frequencies and input modulating signal levels employed.

(c) Single sideband and independent sideband radiotelephone transmitters which employ a device or circuit to limit peak envelope power. A curve showing the peak envelope power output versus the modulation input voltage shall be supplied. The modulating signals shall be the same in frequency as specified in paragraph (c) of §2.1049 for the occupied bandwidth tests.

(d) Other types of equipment. A curve or equivalent data which shows that the equipment will meet the modulation requirements of the rules under which the equipment is to be licensed.

Test Procedure

According to ANSI C63.26-2015 Section 5.3.2:

Modulation limiting test methodology

Modulation limiting is the ability of a transmitter circuit to limit the transmitter from producing deviations in excess of a rated system deviation.

- a) Connect the equipment as illustrated in Figure 1.
- b) Adjust the transmitter per the manufacturer's procedure for full rated system deviation.
- c) Set the test receiver to measure peak positive deviation. Set the audio bandwidth for ≤ 0.25 Hz to ≥ 15000 Hz. Turn the de-emphasis function off.
- d) Apply a 1000 Hz modulating signal to the transmitter from the audio frequency generator, and adjust the level to obtain 60% of full rated system deviation. This is the 0 dB reference level.
- e) Increase the level from the audio generator by 20 dB in 5 dB increments recording the deviation as measured from the test receiver in each step. Verify that the audio level used to make the OBW measurement is included in the sweep.
- f) Repeat for step e) at 300 Hz, 2500 Hz and 3000 Hz at a minimum using the 0 dB reference level obtained in step d).
- g) Set the test receiver to measure peak negative deviation and repeat step d) through step f).
- h) The values recorded in step f) and step g) are the modulation limiting.
- i) Plot the data set as a percentage of deviation relative to the 0 dB reference point versus input voltage.

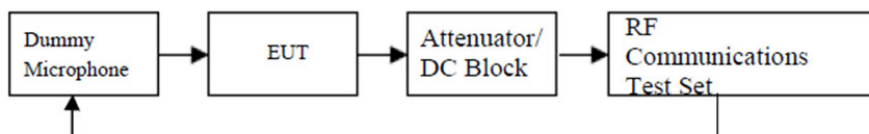

According to ANSI C63.26-2015 Section 5.3.3:

Audio frequency response test methodology—Constant Input

- a) Connect the equipment as illustrated in Figure 3.
- b) Set the test receiver to measure peak positive deviation. Set the audio bandwidth for ≤ 50 Hz to ≥ 15 000Hz. Turn the de-emphasis function off.
- c) Adjust the transmitter per the manufacturer’s procedure for full rated system deviation.
- d) Apply a 1000 Hz tone and adjust the audio frequency generator to produce 20% of the rated system deviation.
- e) Set the test receiver to measure rms deviation and record the deviation reading as DEVREF.
- f) Set the audio frequency generator to the desired test frequency between 300 Hz and 3000 Hz.

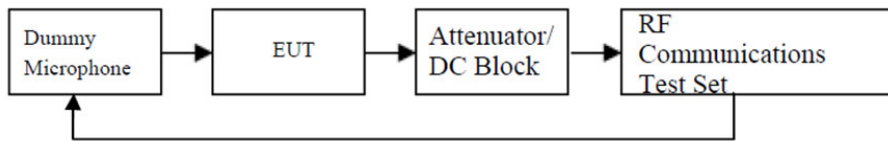

According to ANSI/TIA 603-E-2016 Section 2.2.15:

Audio Low Pass Filter Response

- a) Connect the equipment as illustrated.
- b) Connect the Audio Generator as close as possible the input of the post limiter low pass filter within the transmitter under test.
- c) Connect the RF Communications Test Set to the output of the post limiter low pass filter within the transmitter under test.
- d) Apply a 1000 Hz tone from the audio frequency generator and adjust the level per manufacturer's specifications.
- e) Record the dB level of the 1000 Hz spectral line on the RF Communications Test Set as LEV_{REF} .
- f) Set the audio frequency generator to the desired test frequency between 3000 Hz and the upper low pass filter limit.
- g) Record RF Communications Test Set levels, at the test frequency in step f).
- h) Record the dB level on the RF Communications Test Set as LEV_{FREQ} .

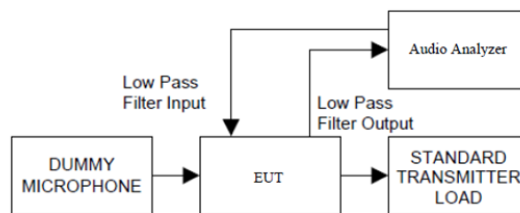

Test Data

Test Mode:	Transmitting	Test Engineer:	Lucas Lin
Test Date:	2024-11-29~2024-12-02	Test Result:	Compliant

Environment Conditions:					
Temperature: (°C)	23.7~24.4	Relative Humidity: (%)	49~50	ATM Pressure: (kPa)	100.1~100.2

Please refer to below table:

Modulation Limiting

PK+

FM 12.5kHz	Carrier Frequency: 400.0125MHz				Limit (kHz)
Audio Input Level (dB)	Deviation (kHz)				
	0.3	1.0	2.5	3.0	
20	2.119	2.113	2.033	1.940	2.5
15	2.098	2.122	2.030	1.923	2.5
10	1.989	2.110	2.022	1.922	2.5
5	1.118	2.088	2.008	1.913	2.5
0	0.646	1.500	1.996	1.903	2.5

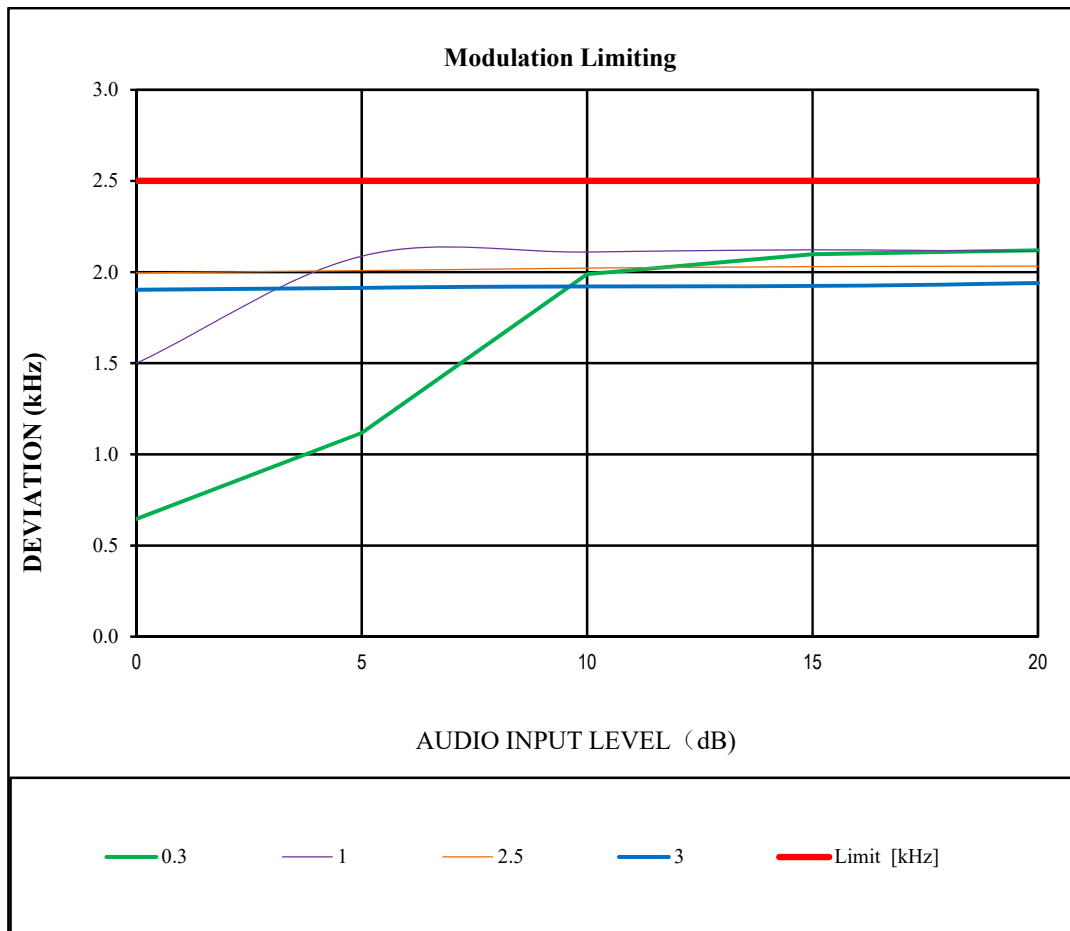

PK-

FM 12.5kHz	Carrier Frequency: 400.0125MHz				
Audio Input Level (dB)	Deviation (kHz)				Limit (kHz)
	0.3	1.0	2.5	3.0	
20	2.113	2.119	2.113	2.087	2.5
15	2.105	2.138	2.115	2.075	2.5
10	2.001	2.120	2.106	2.064	2.5
5	1.116	2.096	2.099	2.044	2.5
0	0.648	1.500	2.080	2.042	2.5

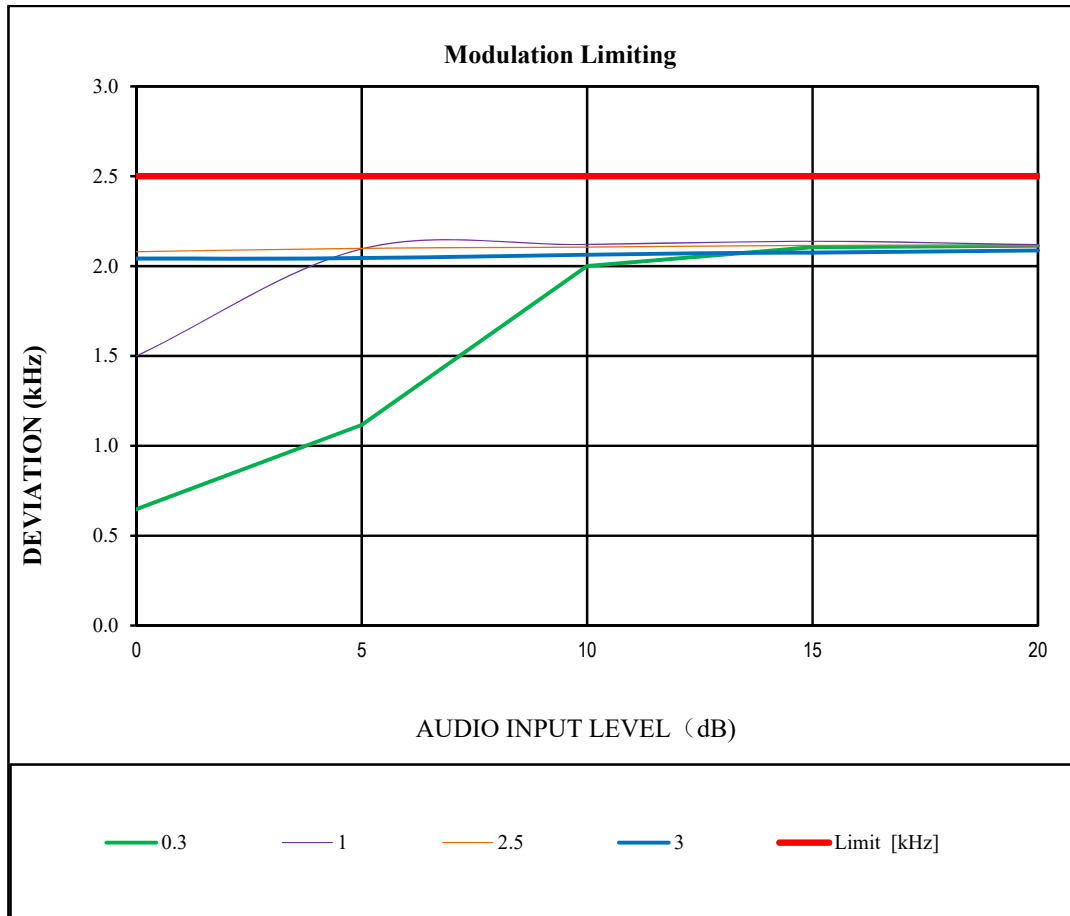

PK+

FM 12.5kHz	Carrier Frequency: 453.2125MHz				
Audio Input Level (dB)	Deviation (kHz)				Limit (kHz)
	0.3	1.0	2.5	3.0	
20	2.122	2.115	2.033	1.949	2.5
15	2.104	2.122	2.031	1.936	2.5
10	1.995	2.109	2.023	1.915	2.5
5	1.119	2.088	2.014	1.913	2.5
0	0.651	1.500	1.997	1.905	2.5

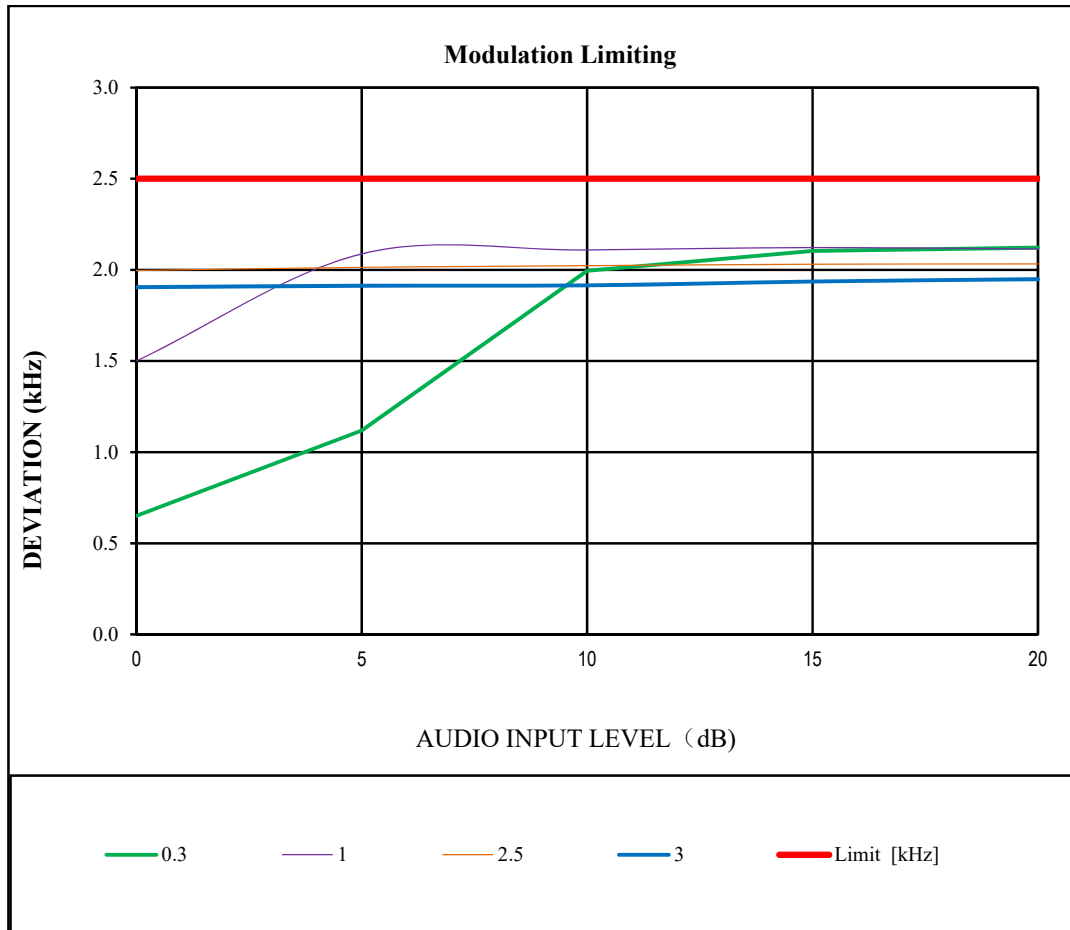

PK-

FM 12.5kHz	Carrier Frequency: 453.2125MHz				
Audio Input Level (dB)	Deviation (kHz)				Limit (kHz)
	0.3	1.0	2.5	3.0	
20	2.115	2.115	2.109	2.076	2.5
15	2.102	2.132	2.105	2.055	2.5
10	1.992	2.121	2.098	2.048	2.5
5	1.119	2.099	2.085	2.050	2.5
0	0.658	1.500	2.072	2.031	2.5

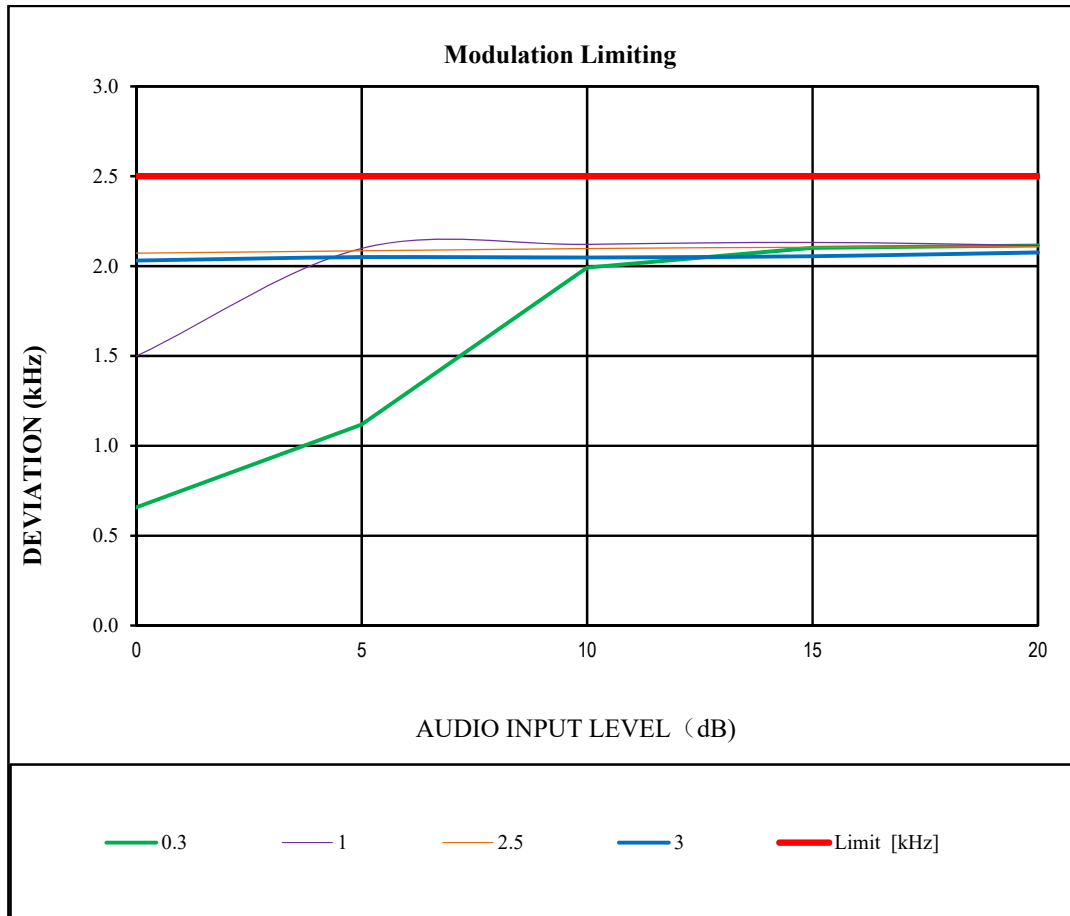

PK+

FM 12.5kHz	Carrier Frequency: 479.9875MHz				
	Deviation (kHz)				Limit (kHz)
	0.3	1.0	2.5	3.0	
20	2.107	2.118	2.041	1.962	2.5
15	2.086	2.120	2.024	1.926	2.5
10	1.993	2.102	2.035	1.941	2.5
5	1.125	2.099	2.019	1.928	2.5
0	0.641	1.500	1.993	1.911	2.5

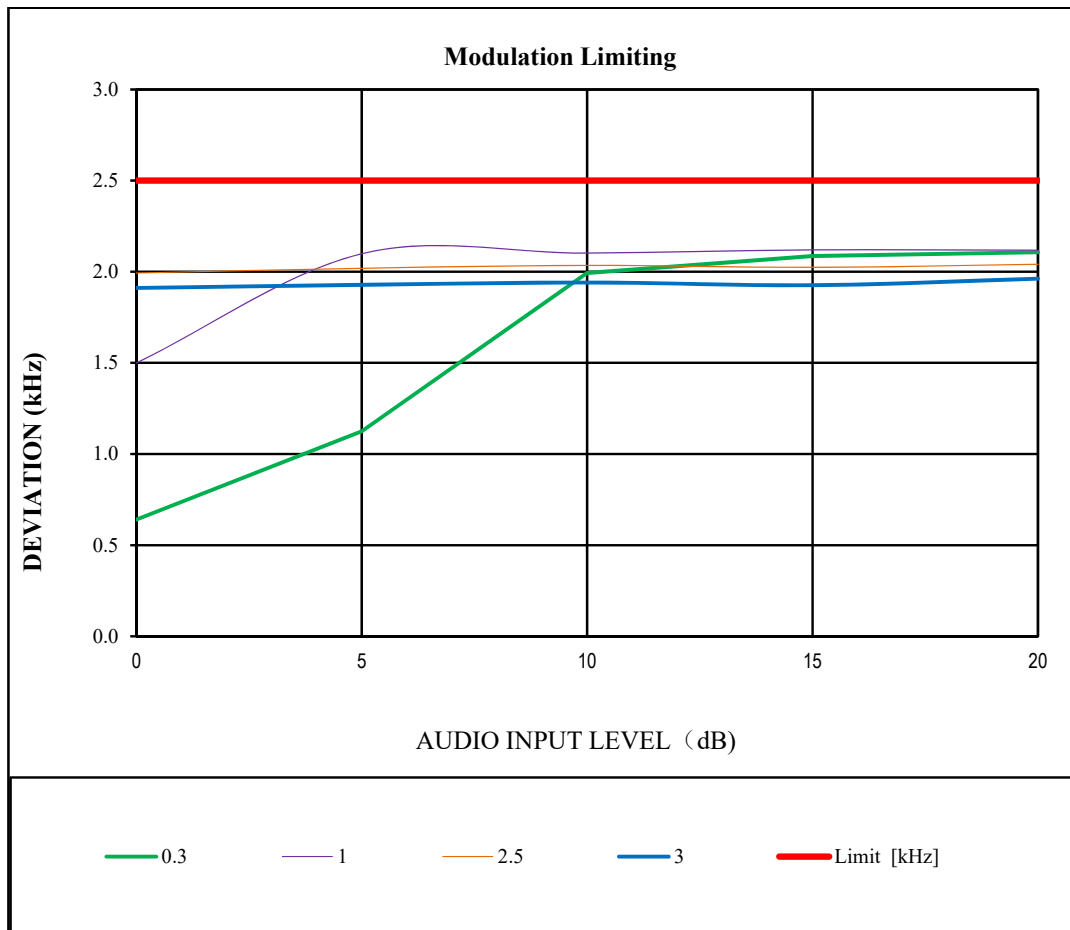

PK-

FM 12.5kHz	Carrier Frequency: 479.9875MHz				
Audio Input Level (dB)	Deviation (kHz)				Limit (kHz)
	0.3	1.0	2.5	3.0	
20	2.124	2.105	2.115	2.071	2.5
15	2.095	2.144	2.129	2.049	2.5
10	1.998	2.112	2.105	2.058	2.5
5	1.127	2.103	2.059	2.053	2.5
0	0.669	1.500	2.081	2.045	2.5

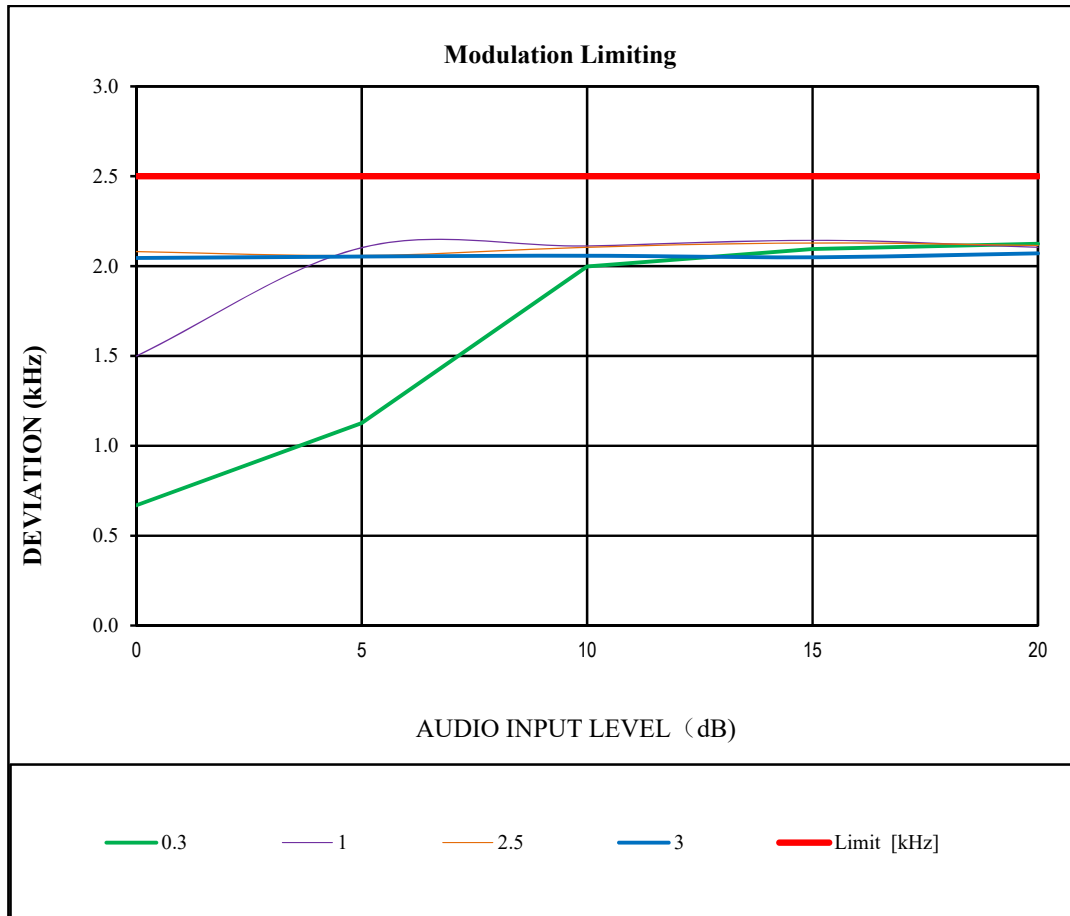

Audio Frequency Response

Carrier Frequency: 400.0125MHz

Audio frequency Hz	Response Attenuation dB
300	-14.58
400	-11.24
500	-8.91
600	-6.96
700	-4.64
800	-2.58
900	-1.05
1000	0.00
1200	1.66
1400	2.94
1600	3.96
1800	4.58
2000	5.09
2200	5.63
2400	6.21
2600	7.42
2800	8.46
3000	7.85

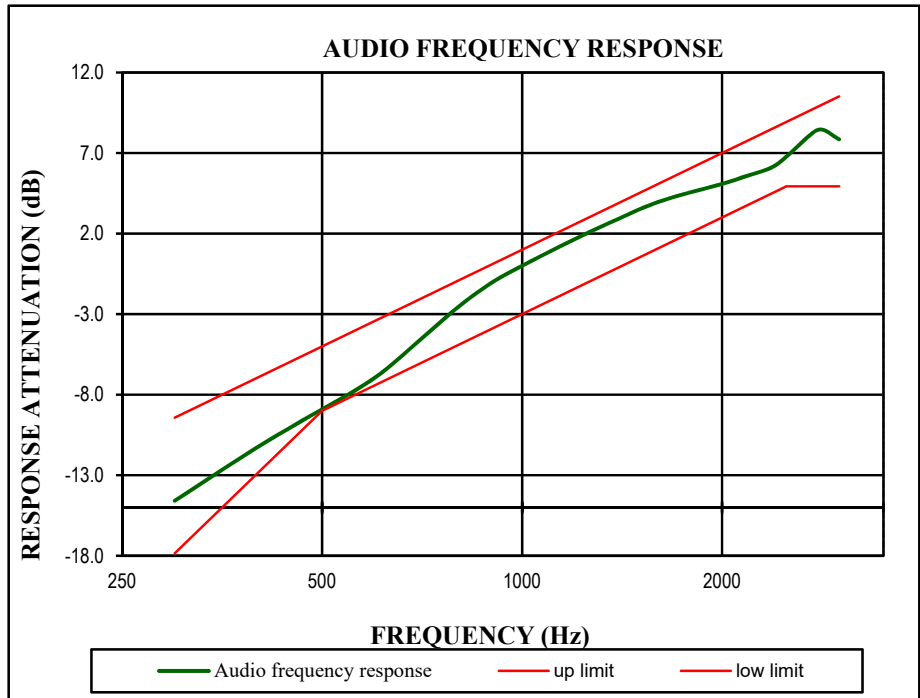

Carrier Frequency: 453.2125MHz

Audio frequency Hz	Response Attenuation dB
300	-14.48
400	-11.23
500	-8.88
600	-6.97
700	-4.67
800	-2.58
900	-1.03
1000	0.00
1200	1.67
1400	2.97
1600	3.96
1800	4.57
2000	5.10
2200	5.64
2400	6.22
2600	7.46
2800	8.49
3000	7.87

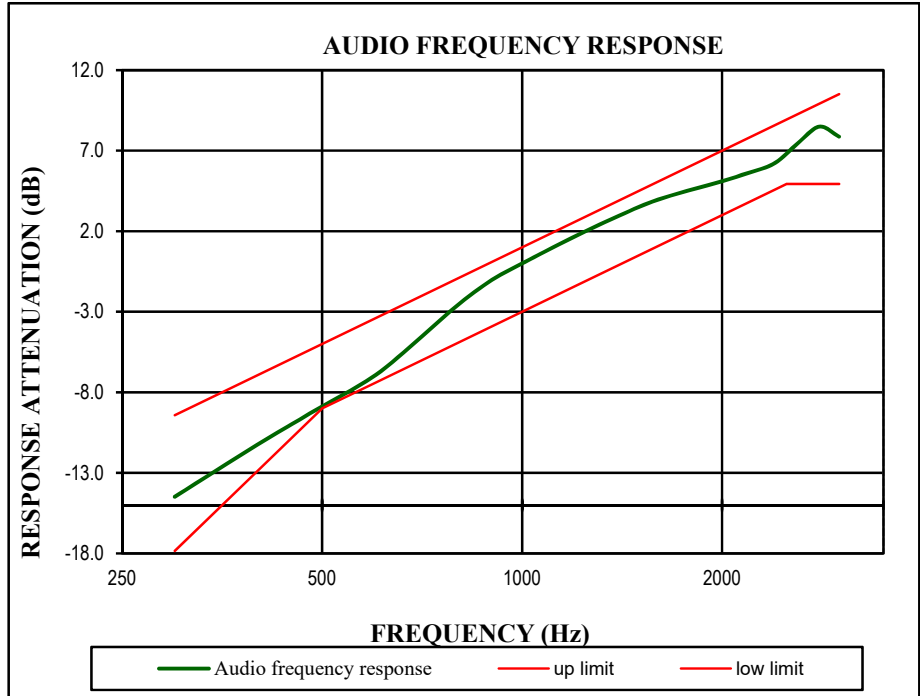

Carrier Frequency: 479.9875MHz

Audio frequency Hz	Response Attenuation dB
300	-14.56
400	-11.22
500	-8.95
600	-6.99
700	-4.66
800	-2.55
900	-1.05
1000	0.00
1200	1.66
1400	2.94
1600	3.95
1800	4.57
2000	5.08
2200	5.62
2400	6.21
2600	7.44
2800	8.47
3000	7.86

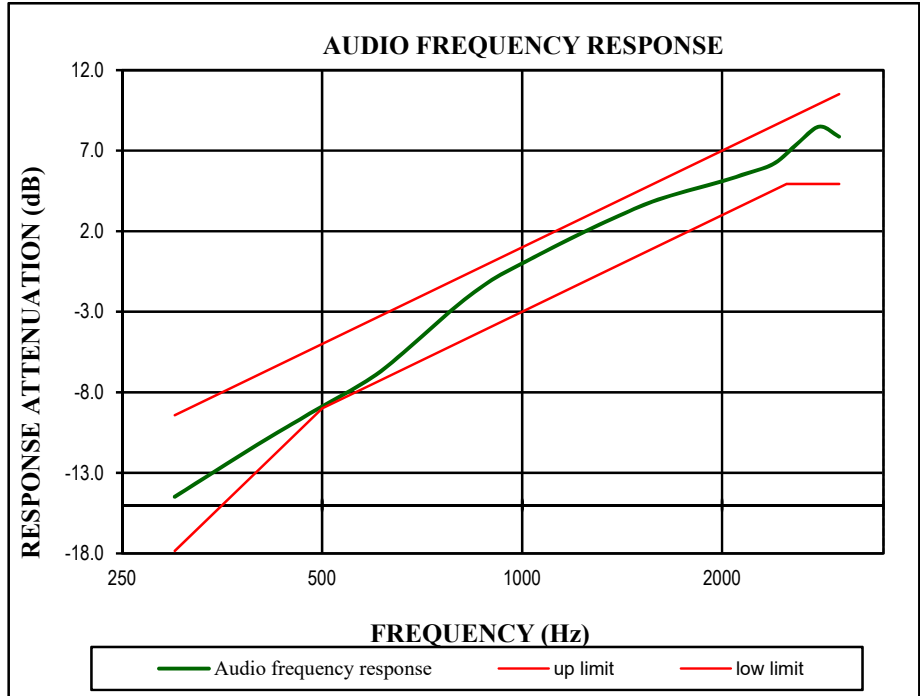

Audio Frequency Low Pass Filter Response

Carrier Frequency: 400.0125MHz

Audio Frequency	Response Attenuation	Limit
kHz	dB	dB
3.0	-5.2	0.0
3.5	-70.4	-6.7
4.0	-72.8	-12.5
5.0	-75.1	-22.2
7.0	-78.5	-36.8
10.0	-81.1	-52.3
15.0	-84.1	-69.9
20.0	-87.7	-82.5

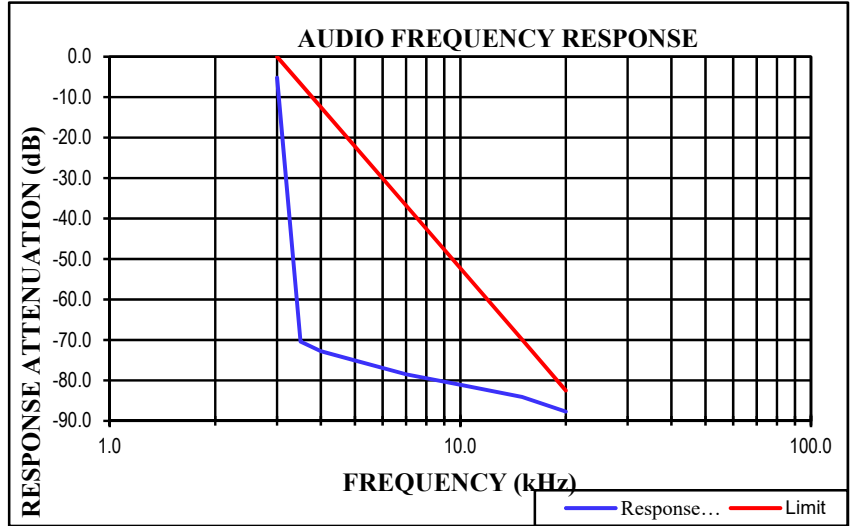

Carrier Frequency: 453.2125MHz

Audio Frequency	Response Attenuation	Limit
kHz	dB	dB
3.0	-4.9	0.0
3.5	-70.9	-6.7
4.0	-72.2	-12.5
5.0	-74.7	-22.2
7.0	-78.8	-36.8
10.0	-80.8	-52.3
15.0	-84.6	-69.9
20.0	-87.2	-82.5

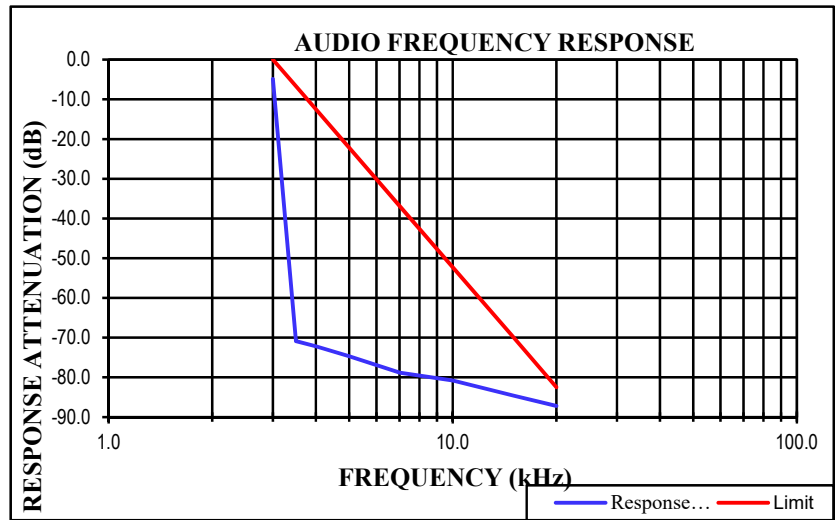

Carrier Frequency: 479.9875MHz

Audio Frequency	Response Attenuation	Limit
kHz	dB	dB
3.0	-5.5	0.0
3.5	-70.1	-6.7
4.0	-72.5	-12.5
5.0	-75.5	-22.2
7.0	-78.1	-36.8
10.0	-81.7	-52.3
15.0	-83.9	-69.9
20.0	-87.4	-82.5

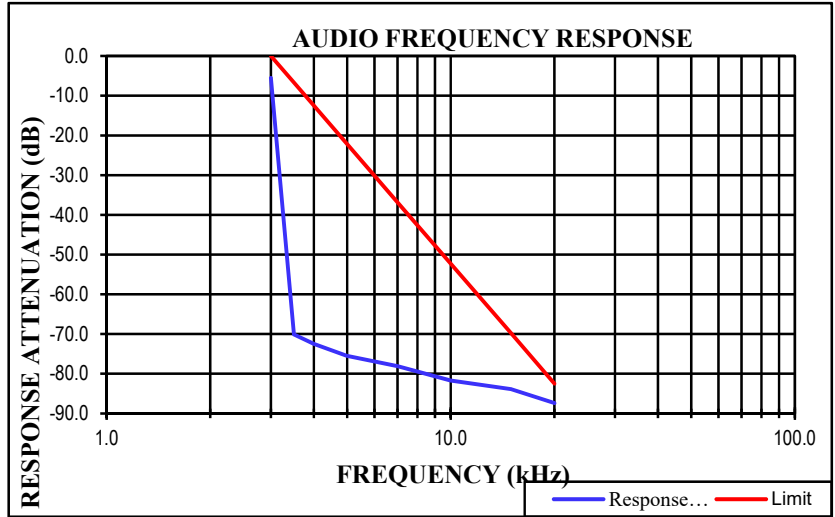

FCC §2.1049 & § 90.209 § 90.210– OCCUPIED BANDWIDTH & EMISSION MASK

Applicable Standard

FCC §90.209

(a) Each authorization issued to a station licensed under this part will show an emission designator representing the class of emission authorized. The designator will be prefixed by a specified necessary bandwidth. This number does not necessarily indicate the bandwidth occupied by the emission at any instant. In those cases where §2.202 of this chapter does not provide a formula for the computation of necessary bandwidth, the occupied bandwidth, as defined in part 2 of this chapter, may be used in lieu of the necessary bandwidth.

(b) (5) Unless specified elsewhere, channel spacings and bandwidths that will be authorized in the following frequency bands are given in the following table: STANDARD CHANNEL SPACING/BANDWIDTH

FCC §90.210

Emission Mask D—12.5 kHz channel bandwidth equipment. For transmitters designed to operate with a 12.5 kHz channel bandwidth, any emission must be attenuated below the power (P) of the highest emission contained within the authorized bandwidth as follows:

(1) On any frequency from the center of the authorized bandwidth f_0 to 5.625 kHz removed from f_0 : Zero dB.

(2) On any frequency removed from the center of the authorized bandwidth by a displacement frequency (f_d in kHz) of more than 5.625 kHz but no more than 12.5 kHz: At least $7.27(f_d - 2.88 \text{ kHz})$ dB.

(3) On any frequency removed from the center of the authorized bandwidth by a displacement frequency (f_d in kHz) of more than 12.5 kHz: At least $50 + 10 \log (P)$ dB or 70 dB, whichever is the lesser attenuation.

(4) The reference level for showing compliance with the emission mask shall be established using a resolution bandwidth sufficiently wide (usually two or three times the channel bandwidth) to capture the true peak emission of the equipment under test. In order to show compliance with the emission mask up to and including 50 kHz removed from the edge of the authorized bandwidth, adjust the resolution bandwidth to 100 Hz with the measuring instrument in a peak hold mode. A sufficient number of sweeps must be measured to insure that the emission profile is developed. If video filtering is used, its bandwidth must not be less than the instrument resolution bandwidth.

For emissions beyond 50 kHz from the edge of the authorized bandwidth, see paragraph (o) of this section. If it can be shown that use of the above instrumentation settings do not accurately represent the true interference potential of the equipment under test, an alternate procedure may be used provided prior Commission approval is obtained.

Test Procedure

According to ANSI C63.26-2015 Section 5.4.4:

The OBW is the frequency bandwidth such that, below its lower and above its upper frequency limits, the mean powers are each equal to 0.5% of the total mean power of the given emission.

The following procedure shall be used for measuring (99%) power bandwidth:

- a) The spectrum analyzer center frequency is set to the nominal EUT channel center frequency. The frequency span for the spectrum analyzer shall be set wide enough to capture all modulation products including the emission skirts (typically a span of $1.5 \times \text{OBW}$ is sufficient).
- b) The nominal IF filter 3 dB bandwidth (RBW) shall be in the range of 1% to 5% of the anticipated OBW, and the VBW shall be set $\geq 3 \times \text{RBW}$.
- c) Set the reference level of the instrument as required to prevent the signal amplitude from exceeding the maximum spectrum analyzer input mixer level for linear operation. See guidance provided in 4.2.3. NOTE—Step a), step b), and step c) may require iteration to adjust within the specified tolerances.
- d) Set the detection mode to peak, and the trace mode to max-hold.
- e) If the instrument does not have a 99% OBW function, recover the trace data points and sum directly in linear power terms. Place the recovered amplitude data points, beginning at the lowest frequency, in a running sum until 0.5% of the total is reached. Record that frequency as the lower OBW frequency. Repeat the process until 99.5% of the total is reached and record that frequency as the upper OBW frequency. The 99% power OBW can be determined by computing the difference these two frequencies.
- f) The OBW shall be reported and plot(s) of the measuring instrument display shall be provided with the test report. The frequency and amplitude axis and scale shall be clearly labeled. Tabular data can be reported in addition to the plot(s).

According to ANSI C63.26-2015 Section 5.7.3:

- f) See Annex I for example emission mask plots.

EUT Setup Block Diagram



Test Data

Test Mode:	Transmitting	Test Engineer:	Lucas Lin
Test Date:	2024-11-29	Test Result:	Compliant

Environment Conditions:					
Temperature: (°C)	23.7	Relative Humidity: (%)	49	ATM Pressure: (kPa)	100.1

Please refer to below table:

Bandwidth:

Modulation Mode	Channel Separation	f _c	High Power Level		Medium Power Level		Low Power Level	
			99% Occupied Bandwidth	26 dB Bandwidth	99% Occupied Bandwidth	26 dB Bandwidth	99% Occupied Bandwidth	26 dB Bandwidth
			MHz	kHz	kHz	kHz	kHz	kHz
FM	12.5kHz	400.0125	5.128	5.449	5.128	5.449	5.128	5.449
		453.2125	5.208	5.369	5.208	5.369	5.208	5.369
		479.9875	5.208	5.369	5.208	5.369	5.208	5.369
4FSK	12.5kHz	400.0125	6.090	9.135	6.090	9.215	6.250	9.455
		453.2125	6.250	9.215	6.170	9.215	6.250	8.974
		479.9875	6.170	9.135	6.090	8.734	6.170	8.974

Emission Mask please refer to the plots. And Emission Mask is tested below attenuation to power (P).

Note:

Emission bandwidth was based on calculation method instead of measurement.

Emission Designator: Per CFR 47 §2.201& §2.202, BW = 2M + 2D

For FM Mode (Channel Spacing: 12.5 kHz)

Emission Designator 11K0F3E

In this case, the maximum modulating frequency is 3.0 kHz with a 2.5 kHz deviation.

$BW = 2(M+D) = 2*(3.0\text{ kHz} + 2.5\text{ kHz}) = 11\text{ kHz} = 11K0$

F3E portion of the designator represents an FM voice transmission

Therefore, the entire designator for 12.5 kHz channel spacing FM mode is 11K0F3E.

For Digital Mode (Channel Spacing: 12.5 kHz)

Emission Designator 7K60F1D and 7K60F1E

The 99% energy rule (title 47CFR 2.1049) was used for digital mode. It basically states that 99% of the modulation energy falls within X kHz, in this case, 7.60 kHz. The emission mask was obtained from 47CFR 90.210(d).

F1D and F1E portion of the designator indicates digital information.

Therefore, the entire designator for 12.5 kHz channel spacing digital mode is 7K60F1D and 7K60F1E.

Note: The 31 dB is the Insertion loss of the RF cable, Attenuators, which was offset into the Spectrum Analyzer.

High Power, Occupied Bandwidth-400.0125 MHz (FM 12.5kHz)

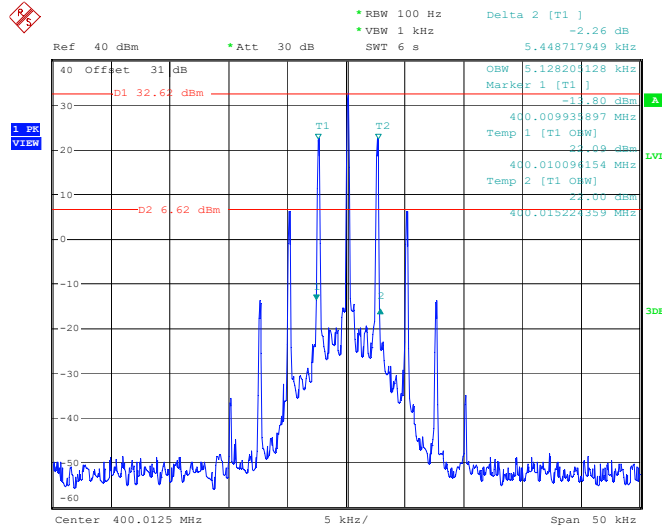

Project No.:2407X57682E-RF Tester:Lucas Lin
 Date: 29.NOV.2024 10:42:30

Emission Mask D

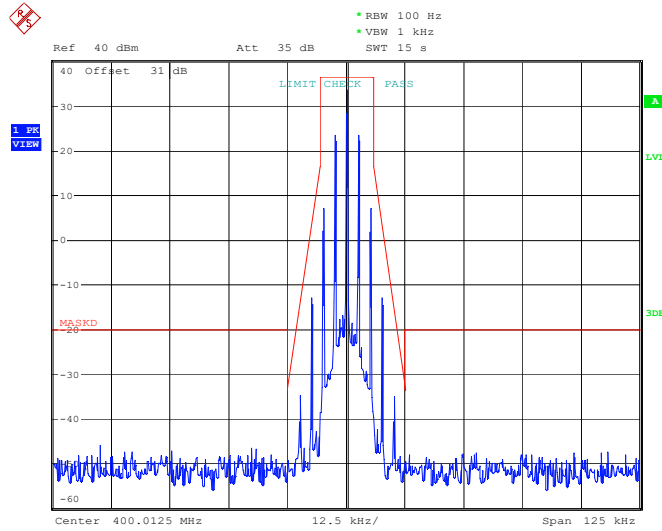

Project No.:2407X57682E-RF Tester:Lucas Lin
 Date: 29.NOV.2024 12:52:54

Medium Power, Occupied Bandwidth-400.0125 MHz (FM 12.5kHz)

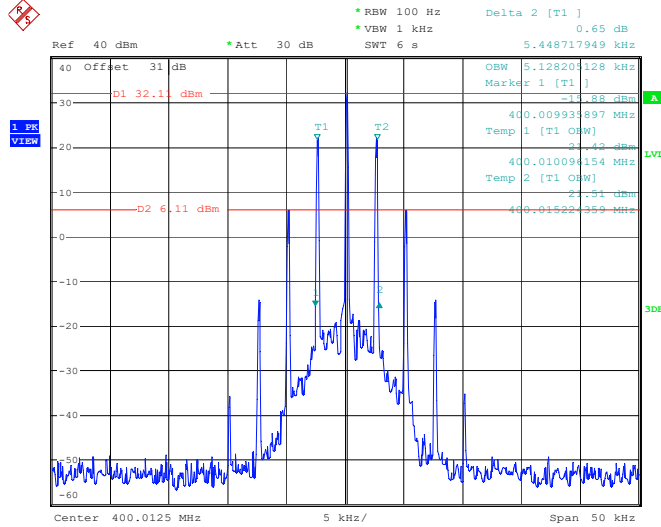

Project No.:2407X57682E-RF Tester:Lucas Lin
 Date: 29.NOV.2024 10:46:15

Emission Mask D

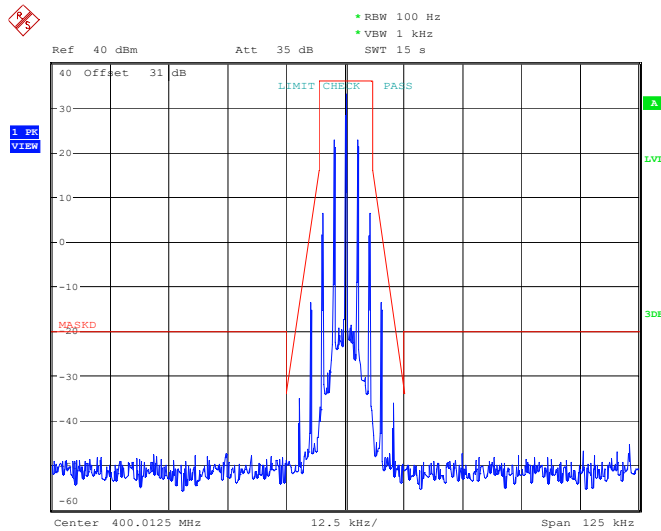

Project No.:2407X57682E-RF Tester:Lucas Lin
 Date: 29.NOV.2024 13:12:58

Low Power, Occupied Bandwidth-400.0125 MHz (FM 12.5kHz)

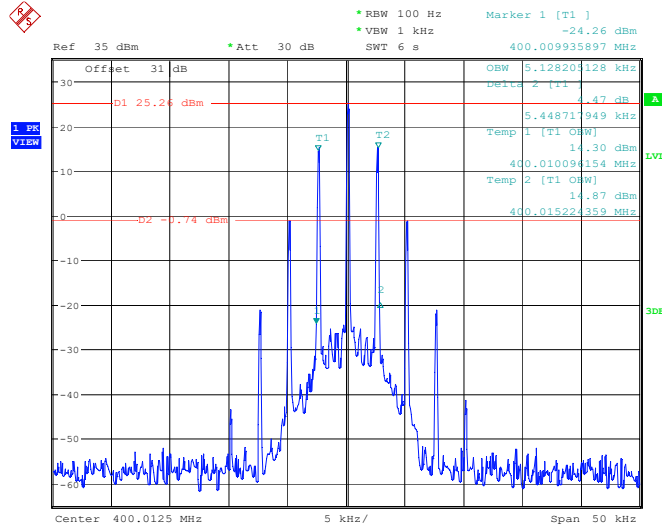

Project No.:2407X57682E-RF Tester:Lucas Lin
 Date: 29.NOV.2024 12:38:49

Emission Mask D

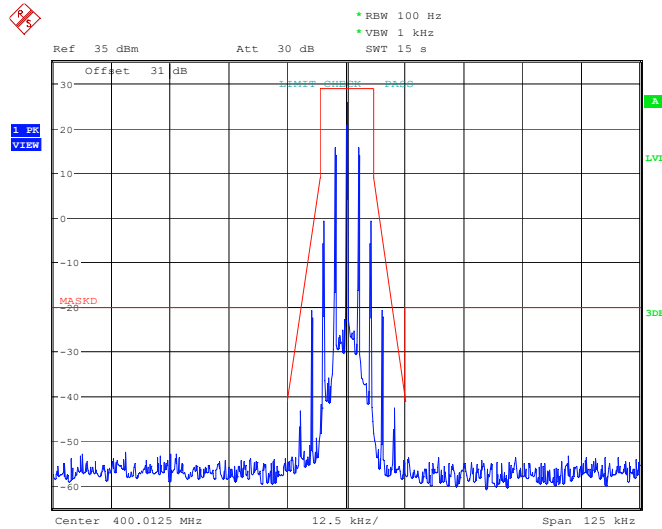

Project No.:2407X57682E-RF Tester:Lucas Lin
 Date: 29.NOV.2024 13:10:51

High Power, Occupied Bandwidth-453.2125 MHz (FM 12.5kHz)

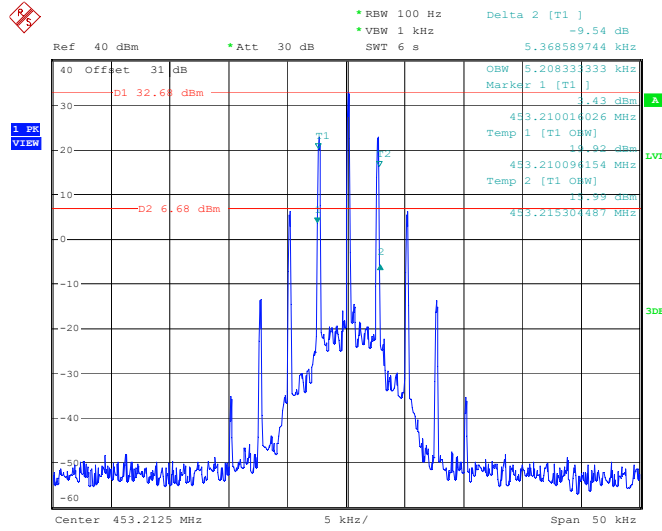

Project No.:2407X57682E-RF Tester:Lucas Lin
 Date: 29.NOV.2024 10:47:59

Emission Mask D

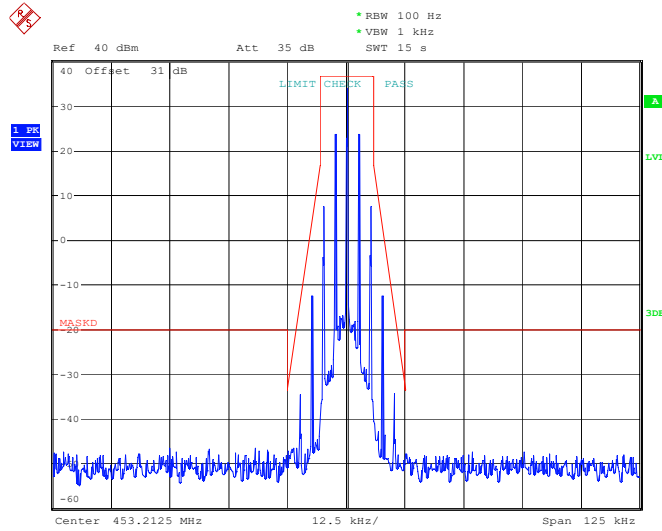

Project No.:2407X57682E-RF Tester:Lucas Lin
 Date: 29.NOV.2024 13:20:39

Medium Power, Occupied Bandwidth-453.2125 MHz (FM 12.5kHz)

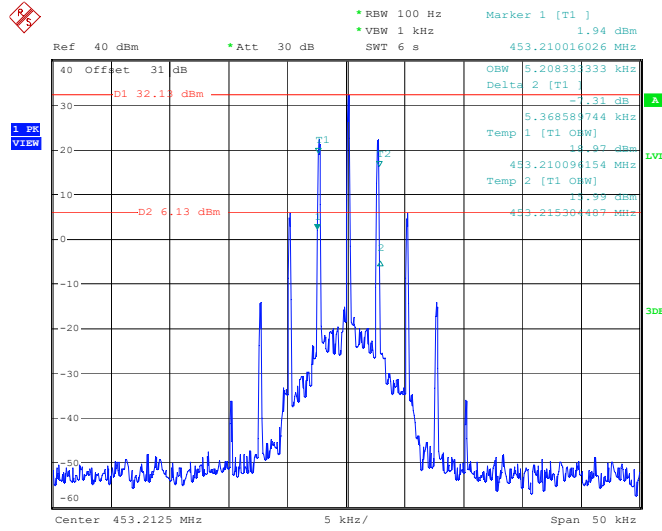

Project No.:2407X57682E-RF Tester:Lucas Lin
Date: 29.NOV.2024 10:49:29

Emission Mask D

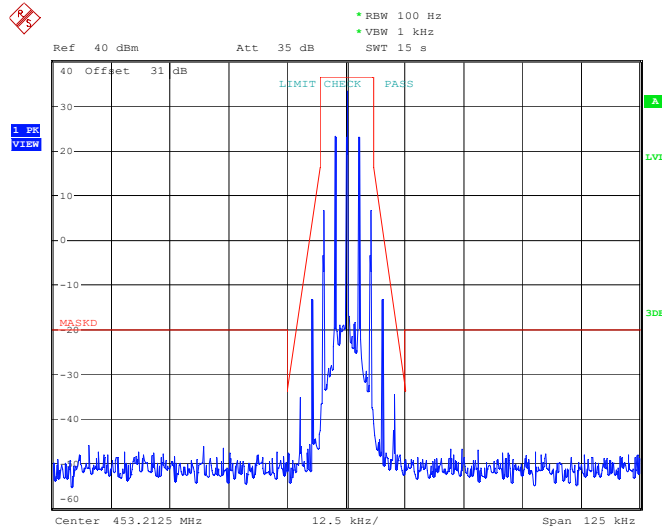

Project No.:2407X57682E-RF Tester:Lucas Lin
Date: 29.NOV.2024 13:18:39

Low Power, Occupied Bandwidth-453.2125 MHz (FM 12.5kHz)

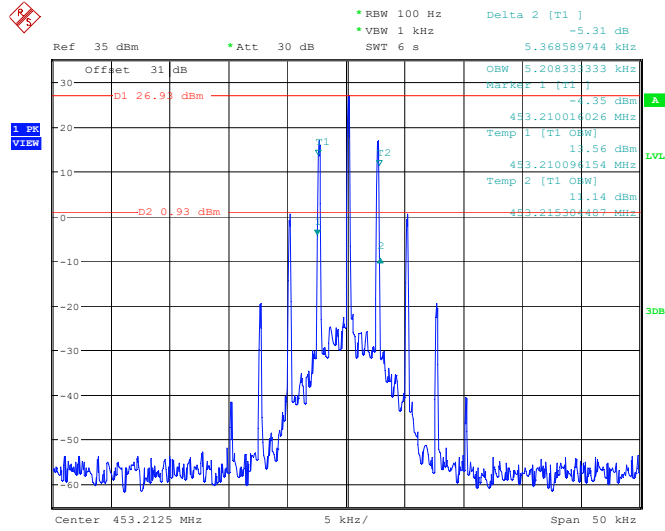

Project No.:2407X57682E-RF Tester:Lucas Lin
 Date: 29.NOV.2024 12:40:05

Emission Mask D

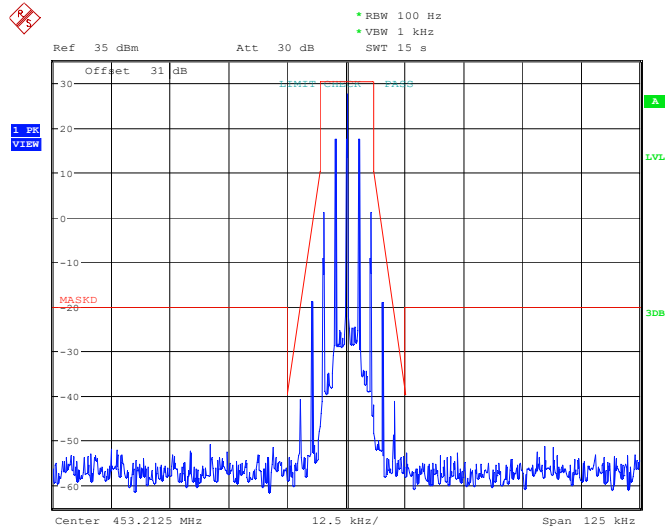

Project No.:2407X57682E-RF Tester:Lucas Lin
 Date: 29.NOV.2024 13:15:45

High Power, Occupied Bandwidth-479.9875 MHz (FM 12.5kHz)

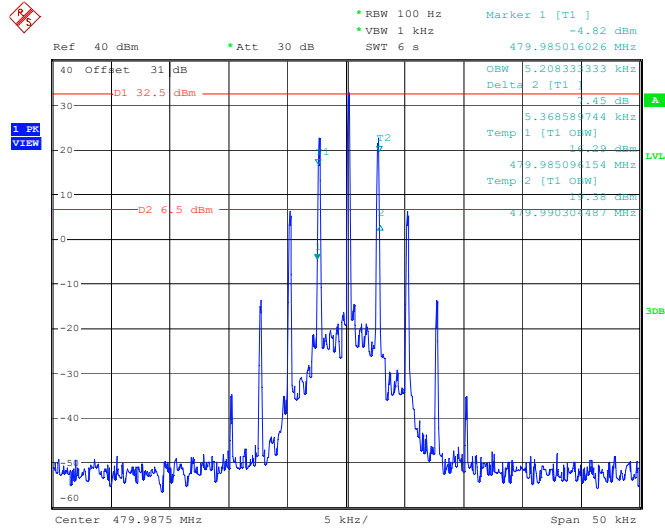

Project No.:2407X57682E-RF Tester:Lucas Lin
 Date: 29.NOV.2024 10:55:04

Emission Mask D

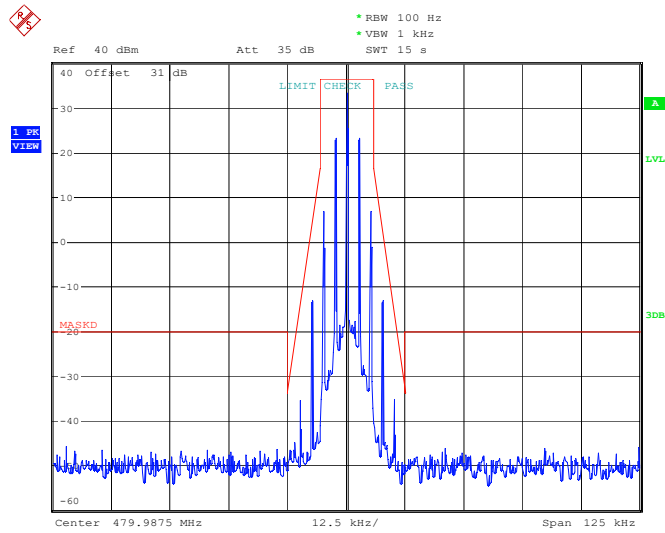

Project No.:2407X57682E-RF Tester:Lucas Lin
 Date: 29.NOV.2024 13:27:08

Medium Power, Occupied Bandwidth-479.9875 MHz (FM 12.5kHz)

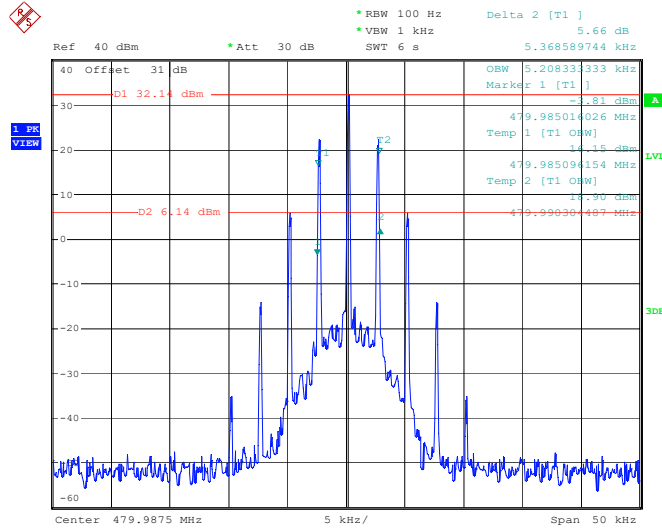

Project No.:2407X57682E-RF Tester:Lucas Lin
Date: 29.NOV.2024 10:53:49

Emission Mask D

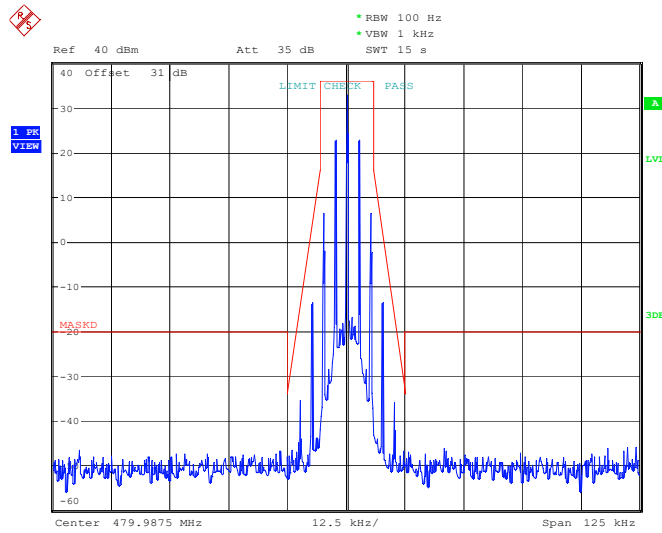

Project No.:2407X57682E-RF Tester:Lucas Lin
Date: 29.NOV.2024 13:24:56

Low Power, Occupied Bandwidth-479.9875 MHz(FM 12.5kHz)

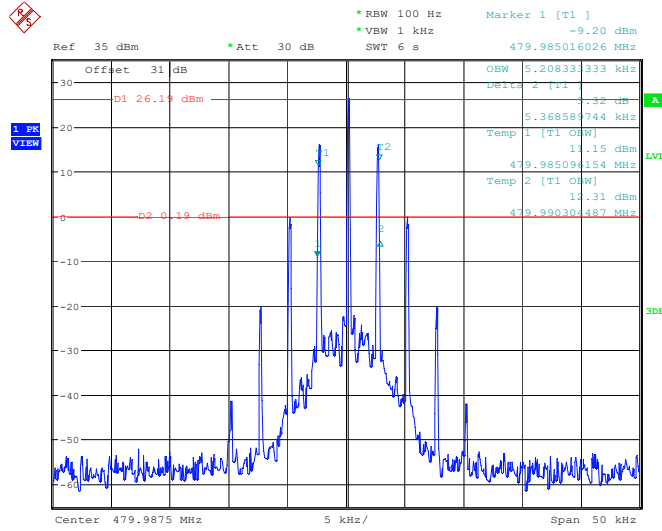

Project No.:2407X57682E-RF Tester:Lucas Lin
 Date: 29.NOV.2024 12:41:27

Emission Mask D

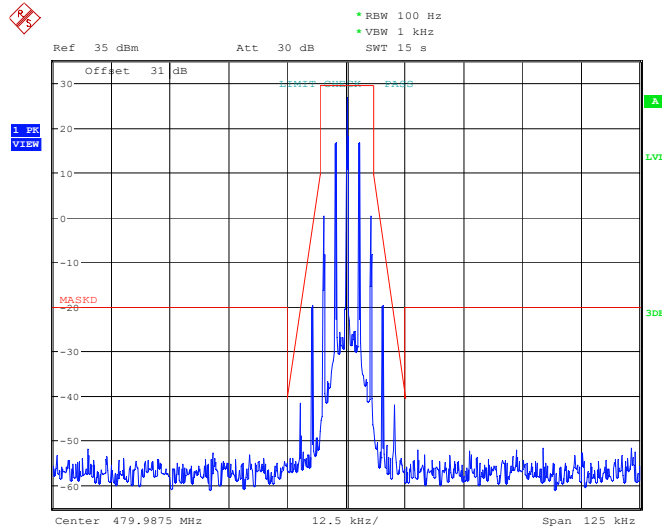

Project No.:2407X57682E-RF Tester:Lucas Lin
 Date: 29.NOV.2024 13:22:55

High Power, Occupied Bandwidth-400.0125 MHz (4FSK 12.5kHz)

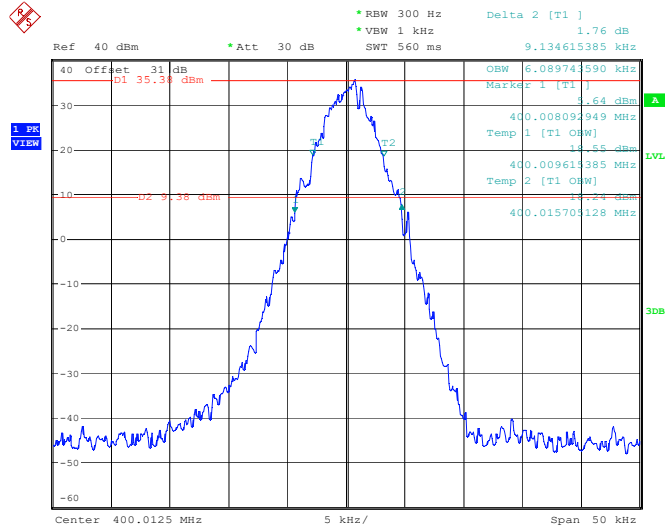

Project No.:2407X57682E-RF Tester:Lucas Lin
Date: 29.NOV.2024 12:21:20

Emission Mask D

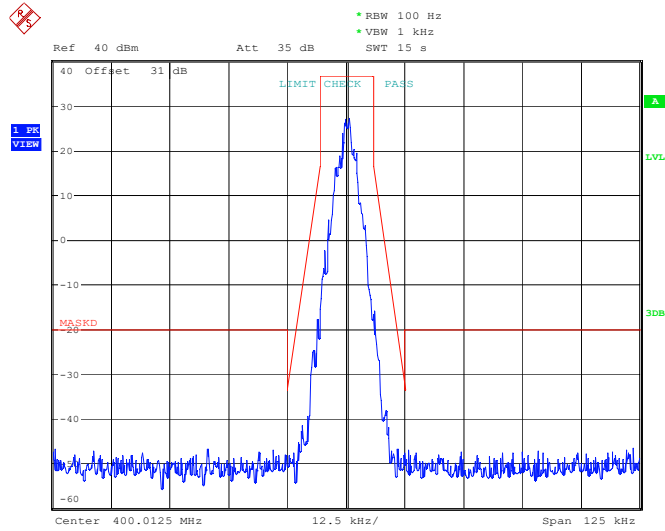

Project No.:2407X57682E-RF Tester:Lucas Lin
Date: 29.NOV.2024 13:37:26

Medium Power, Occupied Bandwidth-400.0125 MHz (4FSK 12.5kHz)

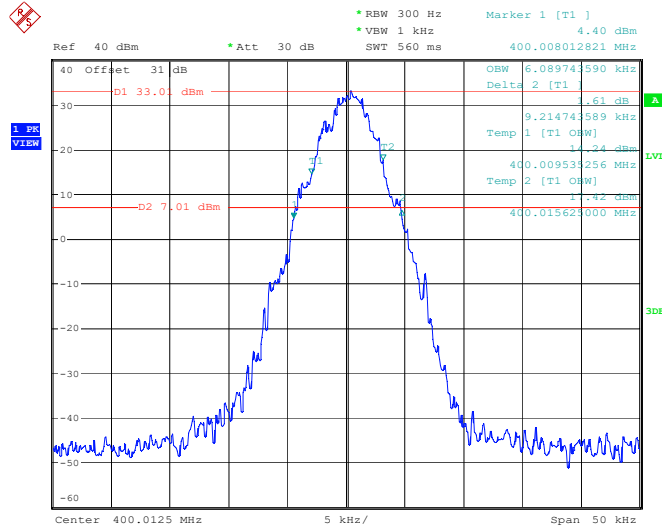

Project No.:2407X57682E-RF Tester:Lucas Lin
 Date: 29.NOV.2024 12:19:36

Emission Mask D

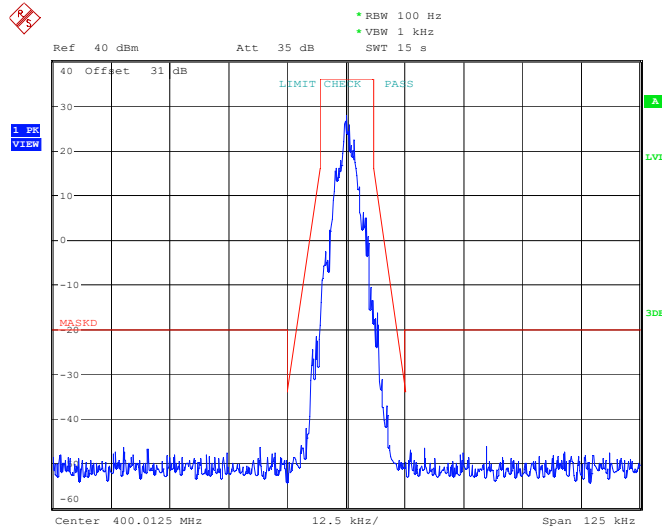

Project No.:2407X57682E-RF Tester:Lucas Lin
 Date: 29.NOV.2024 13:34:46

Low Power, Occupied Bandwidth-400.0125 MHz (4FSK 12.5kHz)

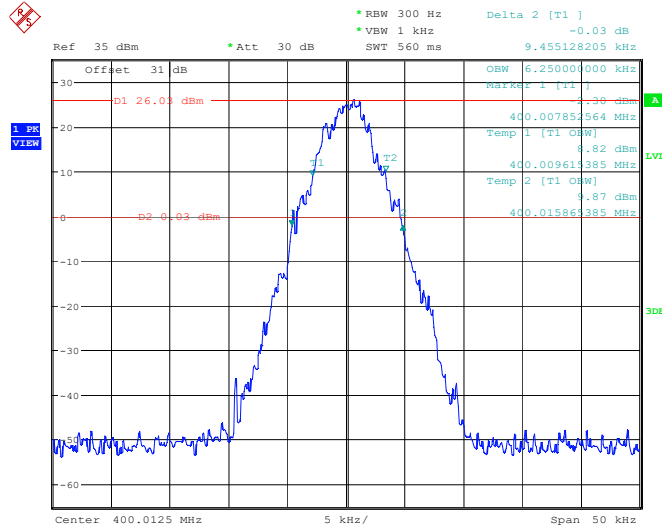

Project No.:2407X57682E-RF Tester:Lucas Lin
 Date: 29.NOV.2024 12:35:47

Emission Mask D

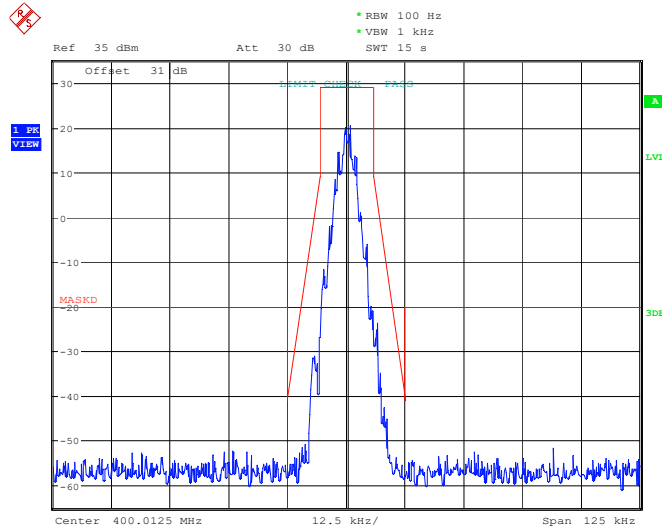

Project No.:2407X57682E-RF Tester:Lucas Lin
 Date: 29.NOV.2024 13:31:47

Medium Power, Occupied Bandwidth-453.2125 MHz (4FSK 12.5kHz)

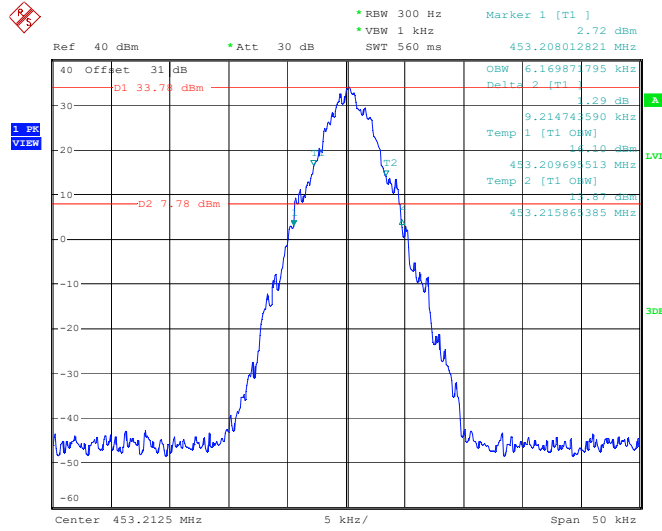

Project No.:2407X57682E-RF Tester:Lucas Lin
 Date: 29.NOV.2024 12:25:47

Emission Mask D

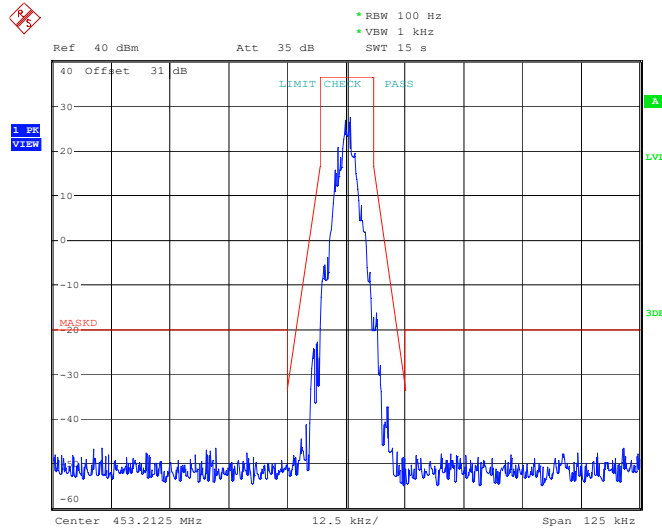

Project No.:2407X57682E-RF Tester:Lucas Lin
 Date: 29.NOV.2024 13:43:27

Low Power, Occupied Bandwidth-453.2125 MHz (4FSK 12.5kHz)

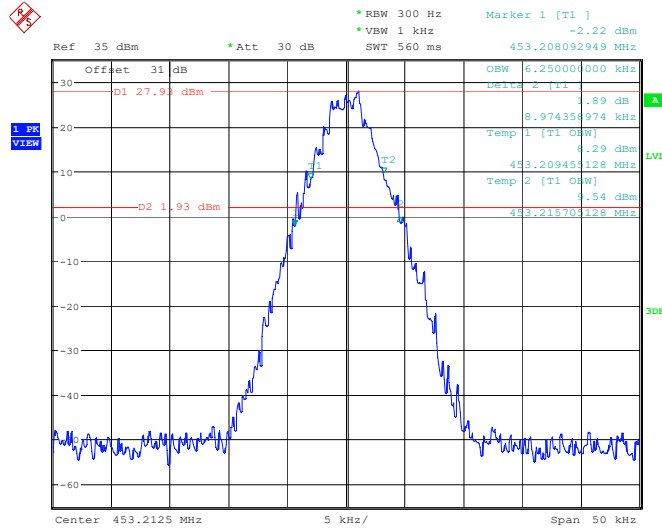

Project No.:2407X57682E-RF Tester:Lucas Lin
 Date: 29.NOV.2024 12:34:22

Emission Mask D

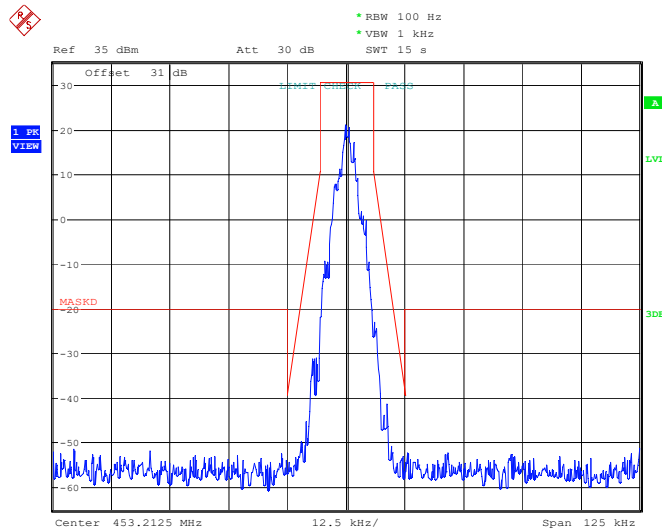

Project No.:2407X57682E-RF Tester:Lucas Lin
 Date: 29.NOV.2024 13:40:51

High Power, Occupied Bandwidth-479.9875 MHz (4FSK 12.5kHz)

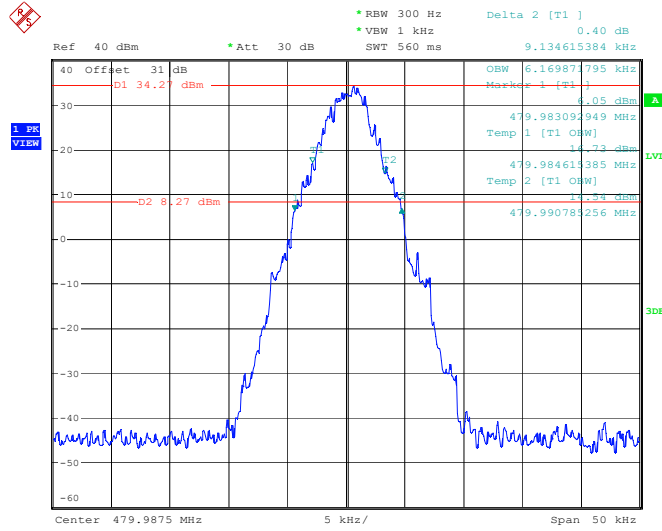

Project No.:2407X57682E-RF Tester:Lucas Lin
 Date: 29.NOV.2024 12:32:23

Emission Mask D

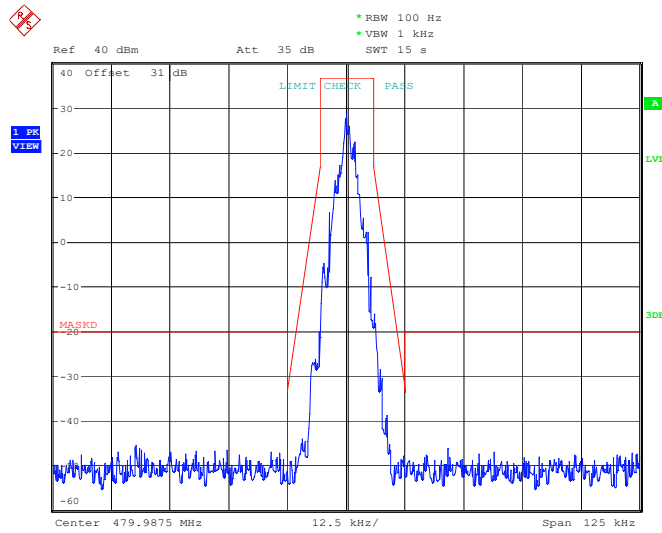

Project No.:2407X57682E-RF Tester:Lucas Lin
 Date: 29.NOV.2024 13:53:41

Medium Power, Occupied Bandwidth-479.9875 MHz (4FSK 12.5kHz)

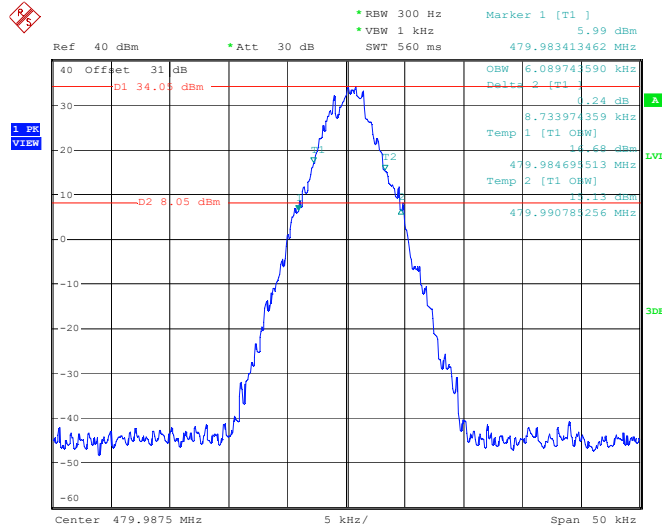

Project No.:2407X57682E-RF Tester:Lucas Lin
 Date: 29.NOV.2024 12:31:09

Emission Mask D

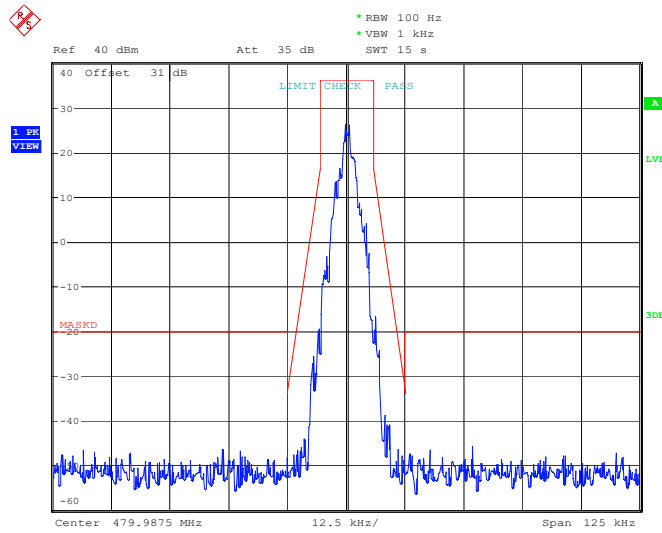

Project No.:2407X57682E-RF Tester:Lucas Lin
 Date: 29.NOV.2024 13:51:43

Low Power, Occupied Bandwidth-479.9875 MHz (4FSK 12.5kHz)

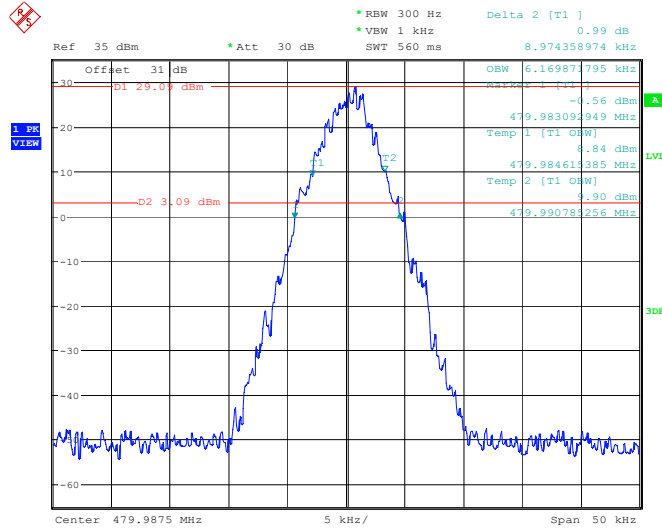

Project No.:2407X57682E-RF Tester:Lucas Lin
 Date: 29.NOV.2024 12:29:36

Emission Mask D

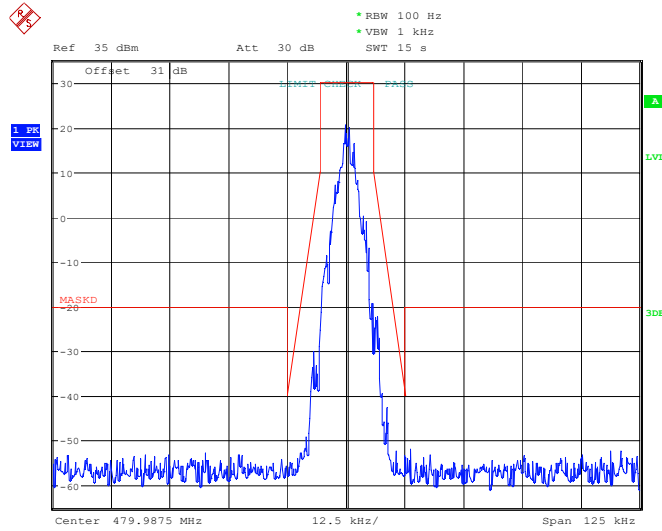

Project No.:2407X57682E-RF Tester:Lucas Lin
 Date: 29.NOV.2024 13:49:33

FCC § 2.1051 & § 90.210 - SPURIOUS EMISSIONS AT ANTENNA TERMINALS

Applicable Standard

FCC §90.210

Emission Mask D—12.5 kHz channel bandwidth equipment. For transmitters designed to operate with a 12.5 kHz channel bandwidth, any emission must be attenuated below the power (P) of the highest emission contained within the authorized bandwidth as follows:

- (1) On any frequency from the center of the authorized bandwidth f_0 to 5.625 kHz removed from f_0 : Zero dB.
- (2) On any frequency removed from the center of the authorized bandwidth by a displacement frequency (f_d in kHz) of more than 5.625 kHz but no more than 12.5 kHz: At least $7.27(f_d - 2.88\text{kHz})$ dB.
- (3) On any frequency removed from the center of the authorized bandwidth by a displacement frequency (f_d in kHz) of more than 12.5 kHz: At least $50 + 10 \log (P)$ dB or 70 dB, whichever is the lesser attenuation.
- (4) The reference level for showing compliance with the emission mask shall be established using a resolution bandwidth sufficiently wide (usually two or three times the channel bandwidth) to capture the true peak emission of the equipment under test. In order to show compliance with the emission mask up to and including 50 kHz removed from the edge of the authorized bandwidth, adjust the resolution bandwidth to 100 Hz with the measuring instrument in a peak hold mode. A sufficient number of sweeps must be measured to insure that the emission profile is developed. If video filtering is used, its bandwidth must not be less than the instrument resolution bandwidth. For emissions beyond 50 kHz from the edge of the authorized bandwidth, see paragraph (o) of this section. If it can be shown that use of the above instrumentation settings do not accurately represent the true interference potential of the equipment under test, an alternate procedure may be used provided prior Commission approval is obtained.

Test Procedure

According to ANSI C63.26-2015 Section 5.7.4:

- a) Set the spectrum analyzer start frequency to the lowest frequency generated by the EUT, without going below 9 kHz, and the stop frequency to the lower frequency covered by the measurements previously performed in 5.7.3. As an alternative, the stop frequency can be set to the value specified in 5.1.1, depending on the EUT operating range, if the resulting plot can clearly demonstrate compliance for all frequencies not addressed by the out-of-band emissions measurements performed as per 5.7.3.
- b) When using an average power (rms) detector, ensure that the number of points in the sweep $\geq 2 \times (\text{span} / \text{RBW})$. This may require that the measurement range defined by the start and stop frequencies be subdivided, depending on the spectrum analyzer capabilities. This requirement does not apply to peak detected power measurements. When average power is specified by the applicable regulation, a peak detector can be utilized for preliminary measurements to accommodate wider frequency spans. Any emissions found in the preliminary measurement to exceed the applicable limit(s) shall be further examined using a power averaging (rms) detector with the minimum number of measurement points as defined above.
- c) The sweep time should be set to auto-couple for performing peak-detector measurements. For measurements that use a power averaging (rms) detector, the sweep time shall be set as described for out-of-band emissions measurements in item d) of 5.7.3.
- d) Identify and measure the highest spurious emission levels in each frequency range. It is not necessary to re-measure the out-of-band emissions as a part of this test. Record the frequencies and amplitudes corresponding to the measured emissions and capture the data plots.
- e) Repeat step b) through step d) for the upper spurious emission frequency range if not already captured

by a wide span measurement performed as per the alternative provided in step a). The upper frequency for this measurement is defined in 5.1.1 as a function of the EUT operating range.

f) Compare the results with the corresponding limit in the applicable regulation.

g) The test report shall include the data plots of the measuring instrument display and the measured data.

EUT Setup Block Diagram

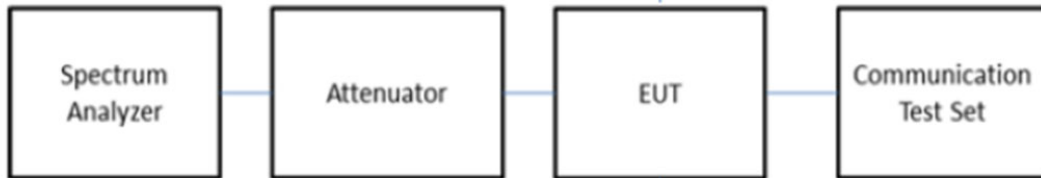

Test Data

Test Mode:	Transmitting	Test Engineer:	Lucas Lin
Test Date:	2024-11-28	Test Result:	Compliant

Environment Conditions:					
Temperature: (°C)	23.7	Relative Humidity: (%)	49	ATM Pressure: (kPa)	100.1

Please refer to following test plots.

Note: The 31 dB is the Insertion loss of the RF cable, Attenuators, which was offset into the Spectrum Analyzer.

Conducted Spurious Emissions at Antenna Port

High Power, 400.0125 MHz, (FM 12.5kHz)

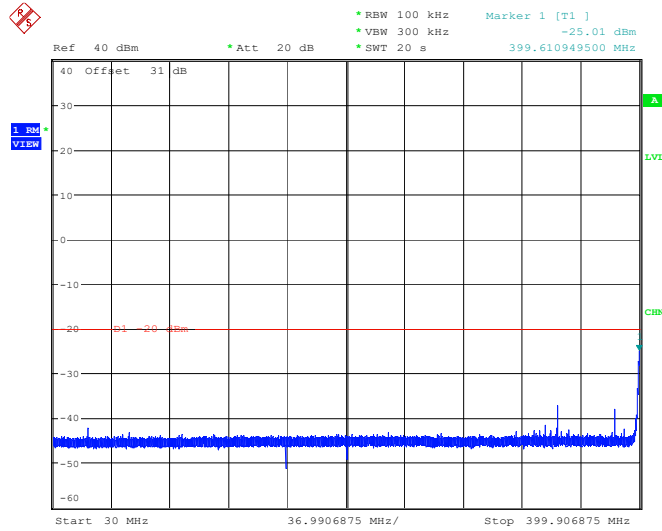

Project No.:2407X57682E-RF Tester:Lucas Lin
Date: 28.NOV.2024 13:07:37

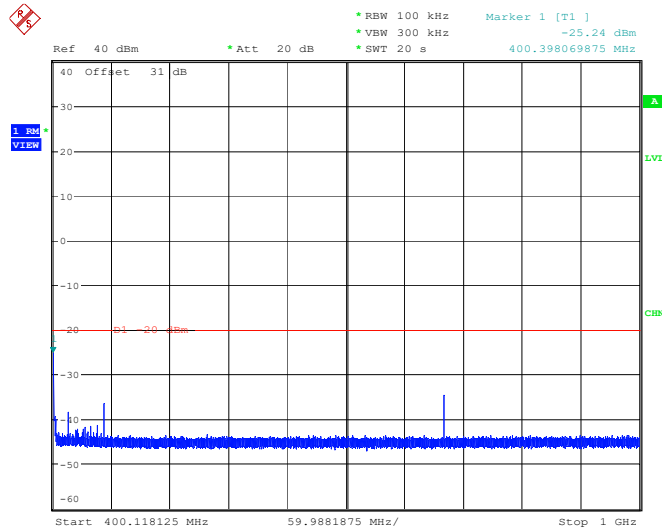

Project No.:2407X57682E-RF Tester:Lucas Lin
Date: 28.NOV.2024 13:22:14

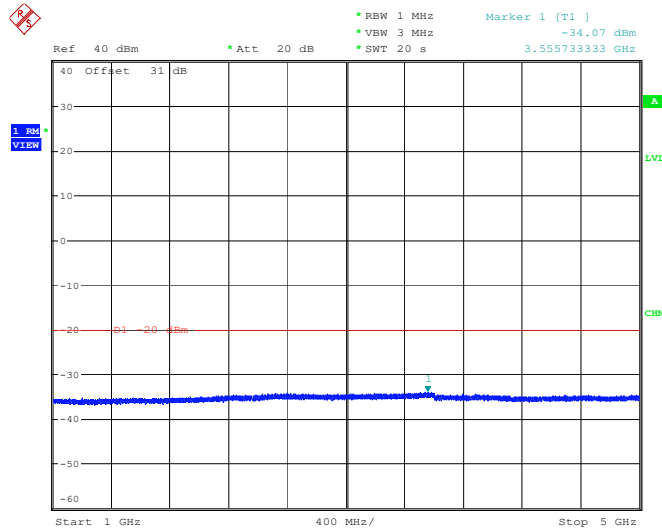

Project No.:2407X57682E-RF Tester:Lucas Lin
Date: 28.NOV.2024 14:07:57

High Power, 453.2125 MHz, (FM 12.5kHz)

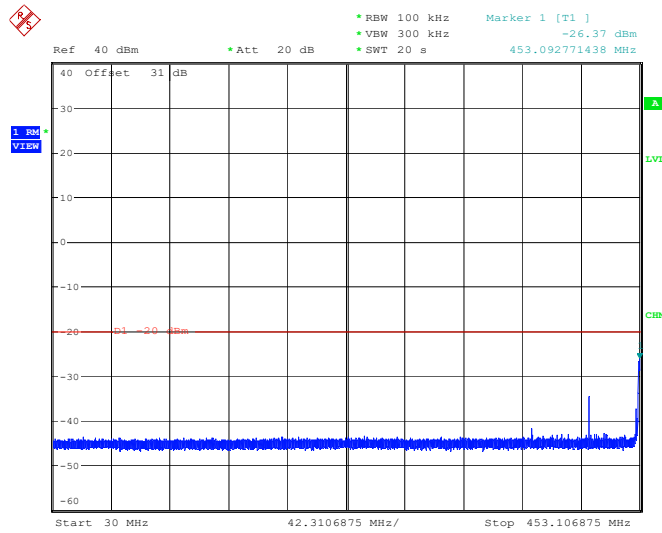

Project No.:2407X57682E-RF Tester:Lucas Lin
Date: 28.NOV.2024 13:26:29

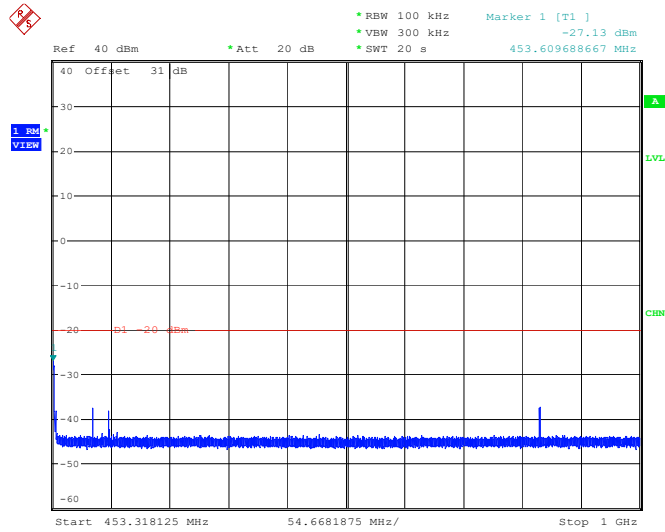

Project No.:2407X57682E-RF Tester:Lucas Lin
Date: 28.NOV.2024 13:40:35

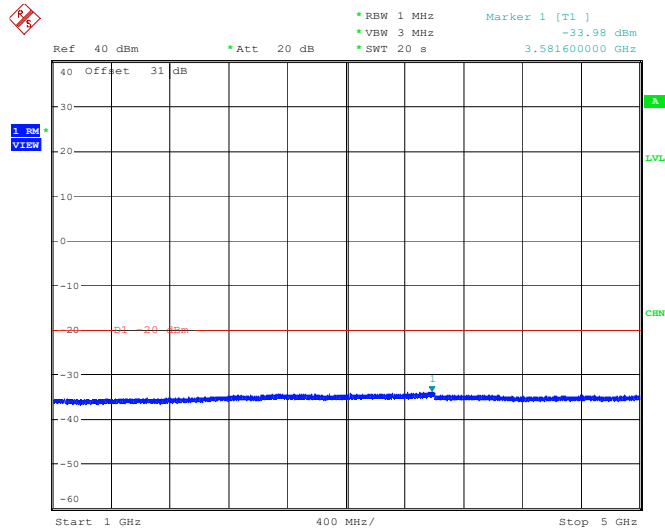

Project No.:2407X57682E-RF Tester:Lucas Lin
Date: 28.NOV.2024 14:09:25

High Power, 479.9875 MHz, (FM 12.5kHz)

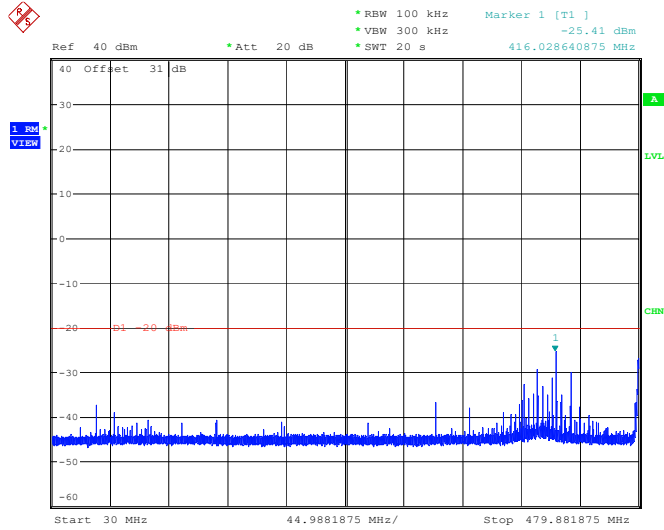

Project No.:2407X57682E-RF Tester:Lucas Lin
Date: 28.NOV.2024 13:46:29

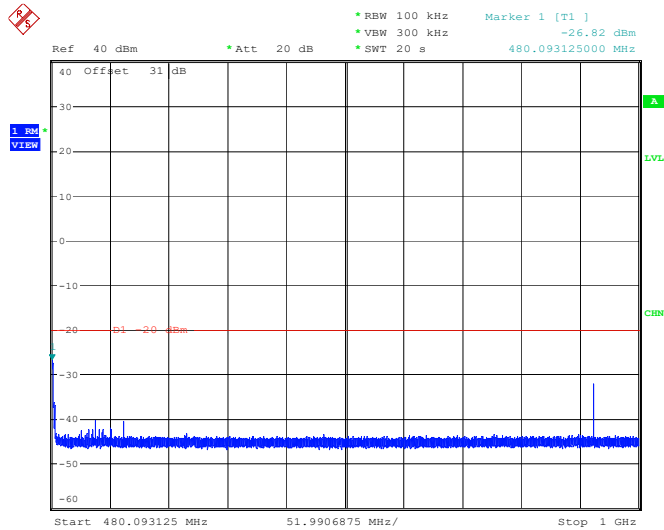

Project No.:2407X57682E-RF Tester:Lucas Lin
Date: 28.NOV.2024 14:01:32

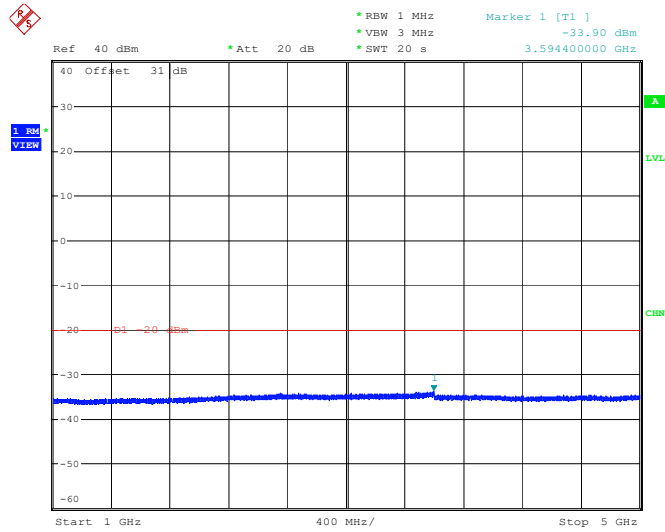

Project No.:2407X57682E-RF Tester:Lucas Lin
Date: 28.NOV.2024 14:12:50

Medium Power, 400.0125 MHz, (FM 12.5kHz)

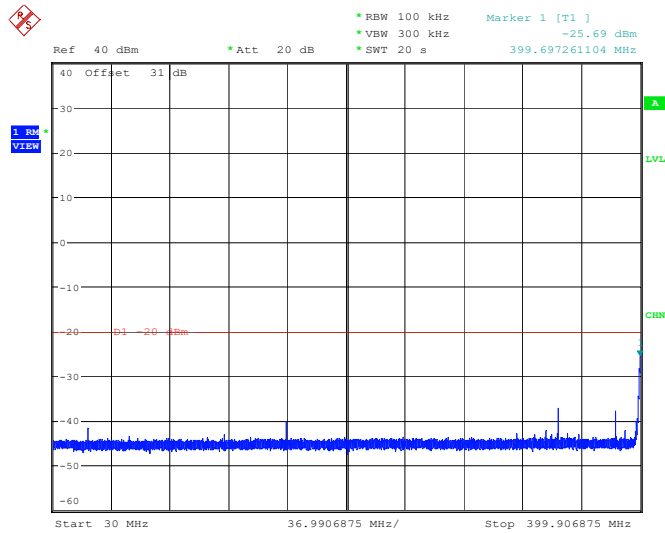

Project No.:2407X57682E-RF Tester:Lucas Lin
Date: 28.NOV.2024 13:11:22

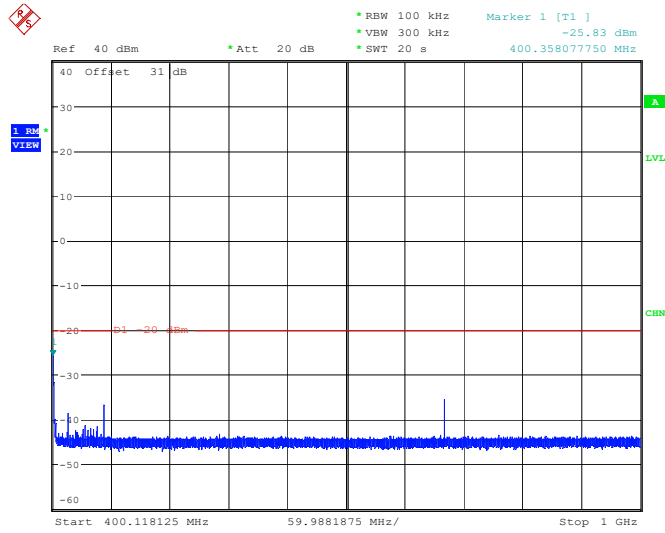

Project No.:2407X57682E-RF Tester:Lucas Lin
Date: 28.NOV.2024 13:24:31

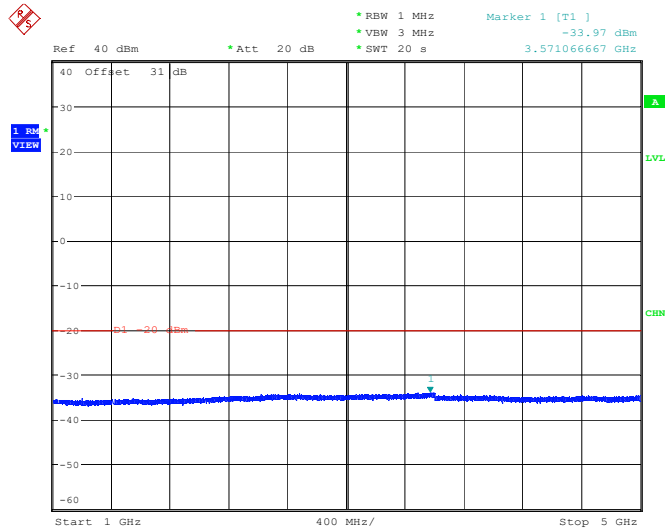

Project No.:2407X57682E-RF Tester:Lucas Lin
Date: 28.NOV.2024 14:07:18

Medium Power, 453.2125 MHz, (FM 12.5kHz)

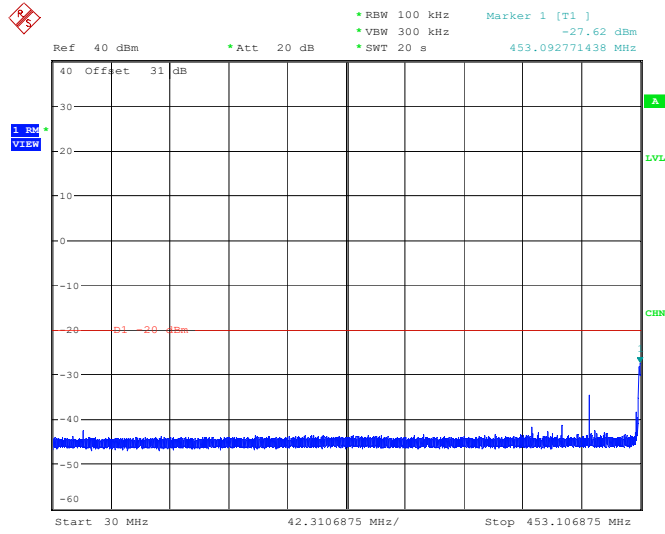

Project No.:2407X57682E-RF Tester:Lucas Lin
Date: 28.NOV.2024 13:28:54

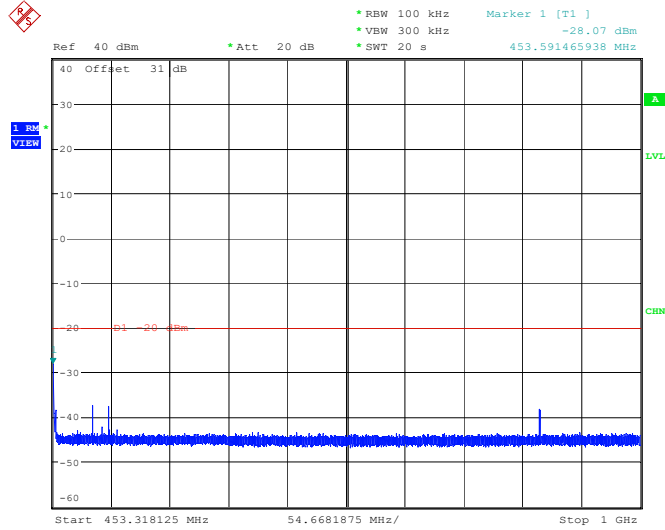

Project No.:2407X57682E-RF Tester:Lucas Lin
Date: 28.NOV.2024 13:42:53

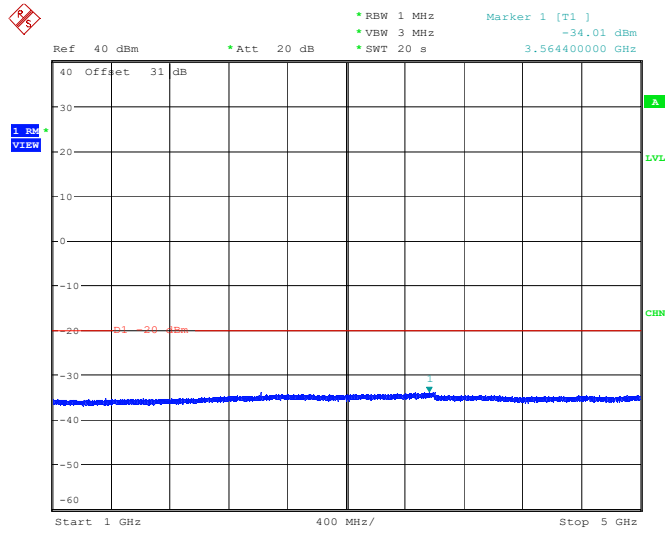

Project No.:2407X57682E-RF Tester:Lucas Lin
Date: 28.NOV.2024 14:12:05

Medium Power, 479.9875 MHz, (FM 12.5kHz)

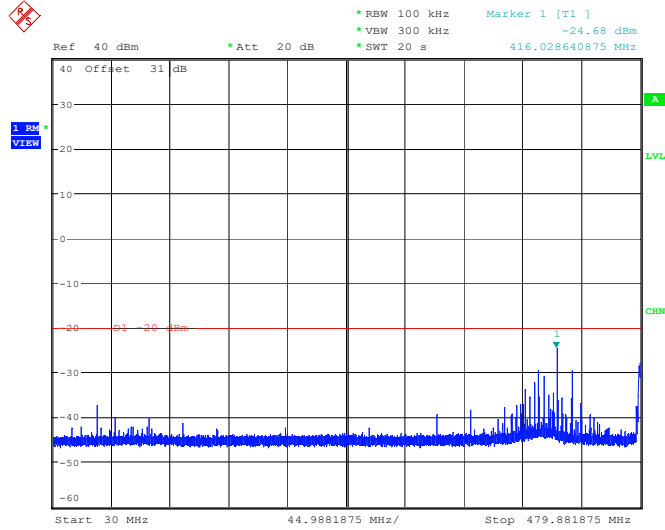

Project No.:2407X57682E-RF Tester:Lucas Lin
Date: 28.NOV.2024 13:49:17

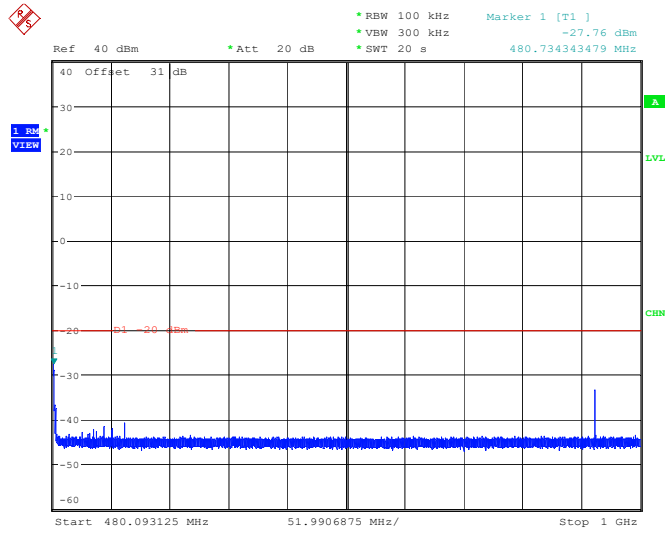

Project No.:2407X57682E-RF Tester:Lucas Lin
Date: 28.NOV.2024 14:03:44

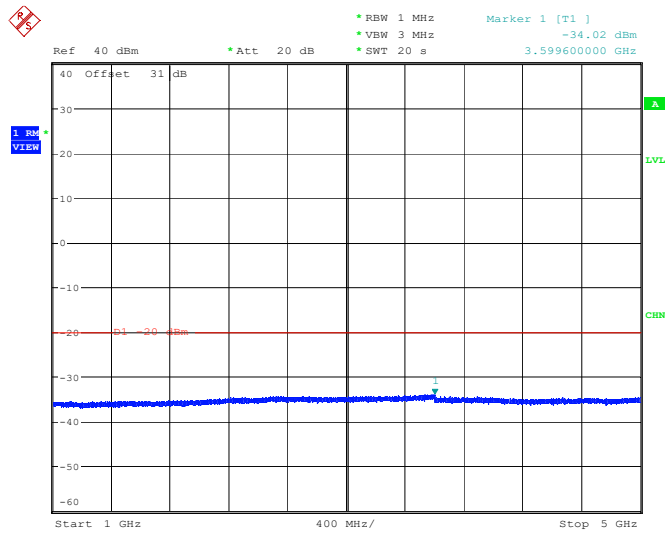

Project No.:2407X57682E-RF Tester:Lucas Lin
Date: 28.NOV.2024 14:14:20

Low Power, 400.0125 MHz, (FM 12.5kHz)

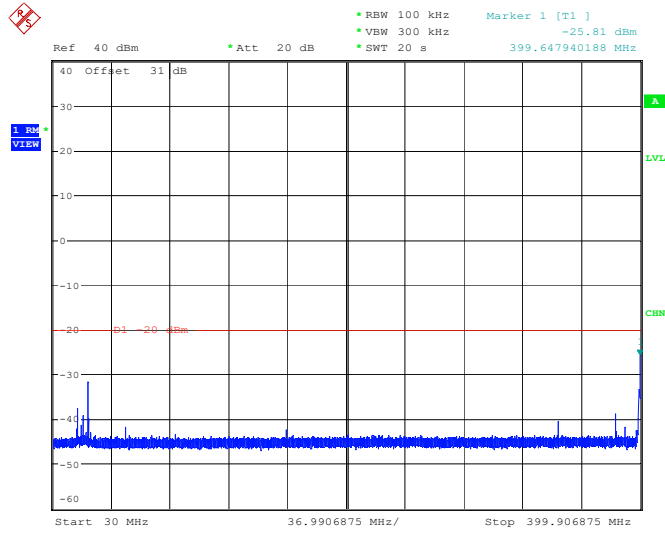

Project No.:2407X57682E-RF Tester:Lucas Lin
Date: 28.NOV.2024 13:12:27

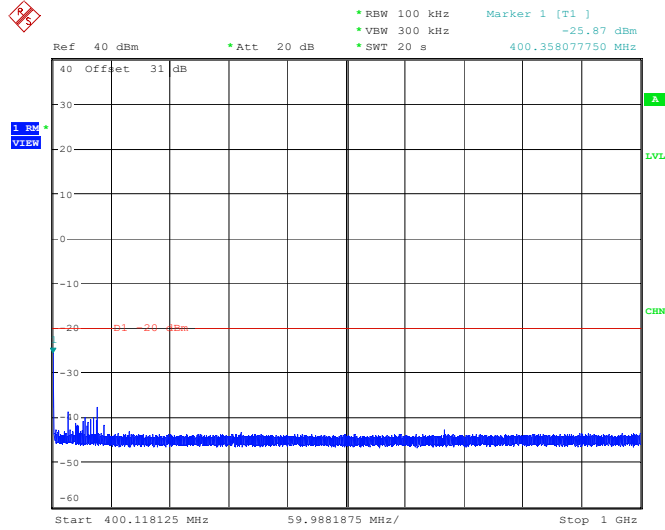

Project No.:2407X57682E-RF Tester:Lucas Lin
Date: 28.NOV.2024 13:23:24

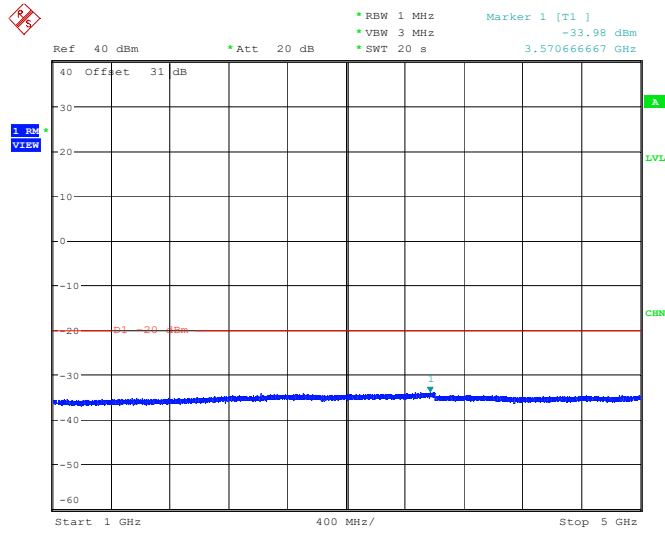

Project No.:2407X57682E-RF Tester:Lucas Lin
Date: 28.NOV.2024 14:08:37

Low Power, 453.2125 MHz, (FM 12.5kHz)

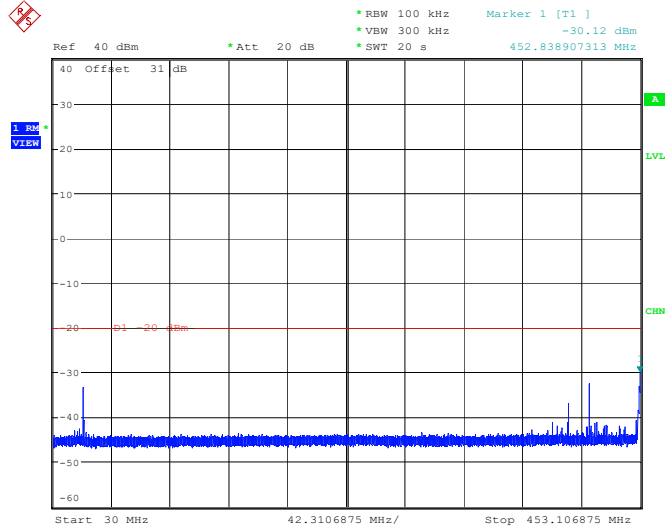

Project No.:2407X57682E-RF Tester:Lucas Lin
Date: 28.NOV.2024 13:27:41

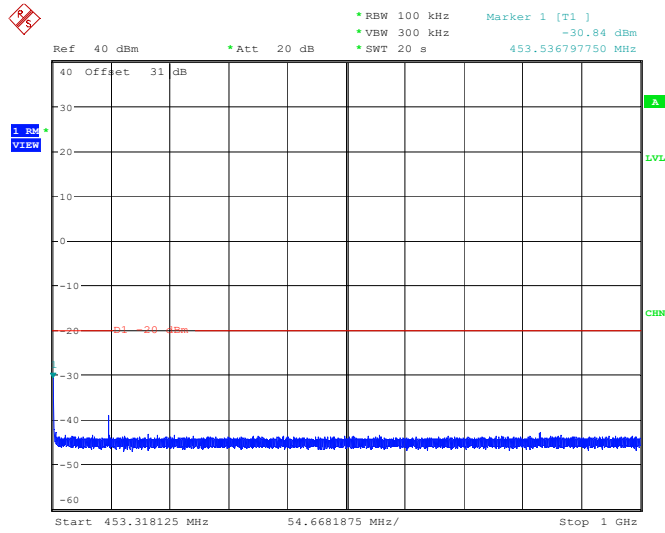

Project No.:2407X57682E-RF Tester:Lucas Lin
Date: 28.NOV.2024 13:41:43

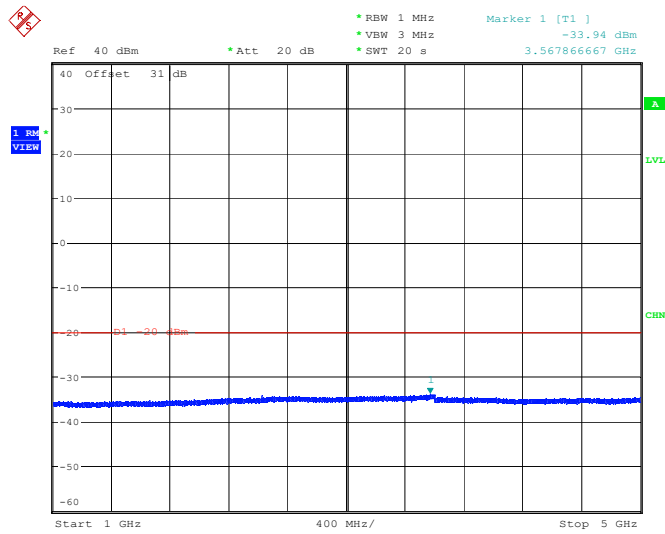

Project No.:2407X57682E-RF Tester:Lucas Lin
Date: 28.NOV.2024 14:11:15

Low Power, 479.9875 MHz, (FM 12.5kHz)

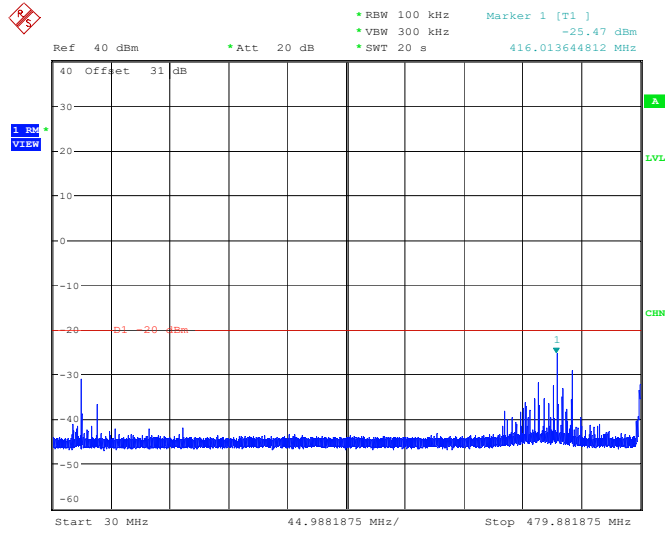

Project No.:2407X57682E-RF Tester:Lucas Lin
Date: 28.NOV.2024 13:47:49

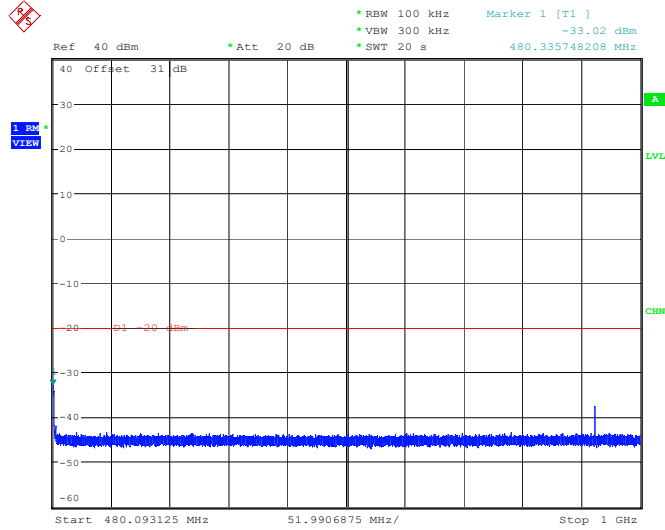

Project No.:2407X57682E-RF Tester:Lucas Lin
Date: 28.NOV.2024 14:02:39

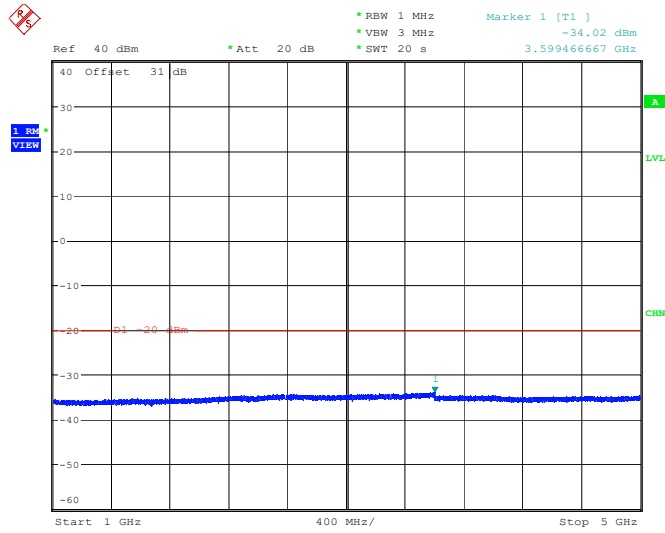

Project No.:2407X57682E-RF Tester:Lucas Lin
Date: 28.NOV.2024 14:13:31

High Power, 400.0125 MHz, (4FSK 12.5kHz)

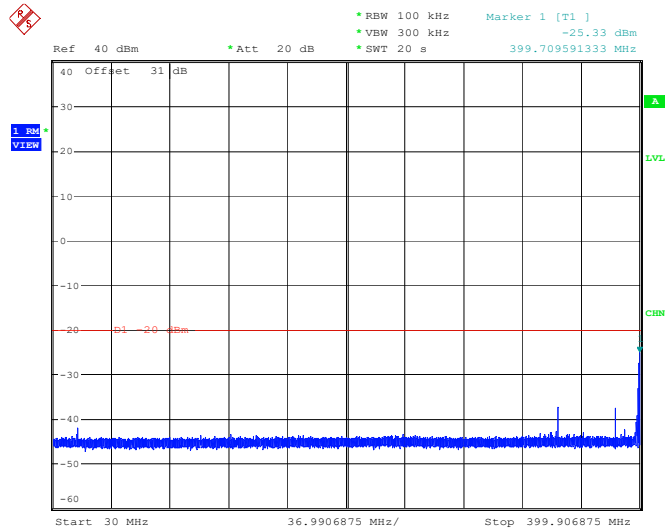

Project No.:2407X57682E-RF Tester:Lucas Lin
Date: 28.NOV.2024 13:14:09

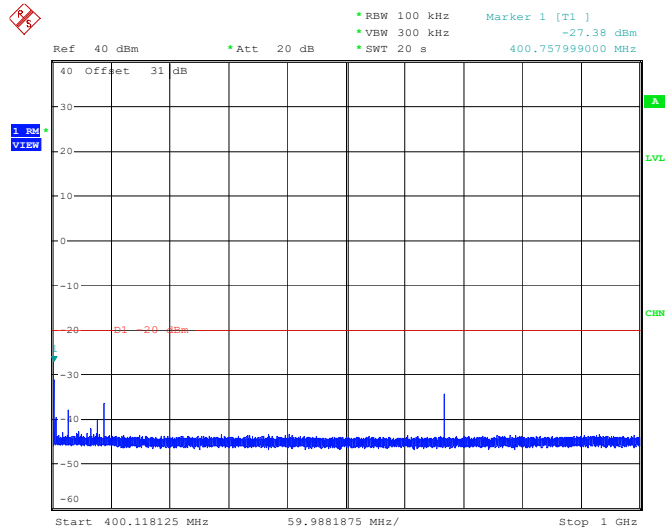

Project No.:2407X57682E-RF Tester:Lucas Lin
Date: 28.NOV.2024 13:18:11

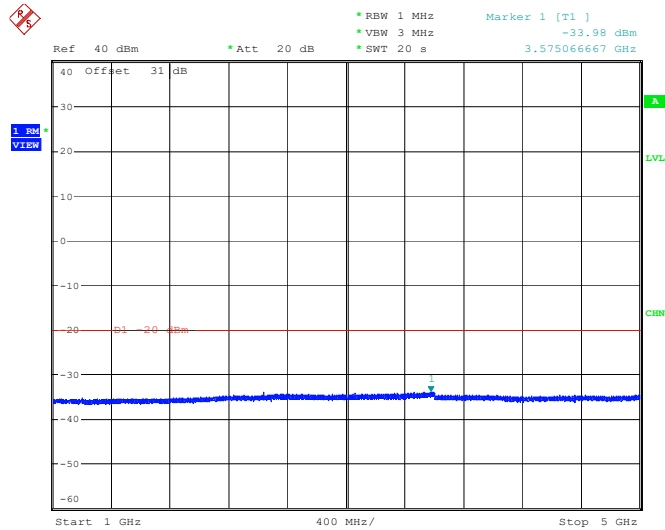

Project No.:2407X57682E-RF Tester:Lucas Lin
Date: 28.NOV.2024 14:15:02

High Power, 453.2125 MHz, (4FSK 12.5kHz)

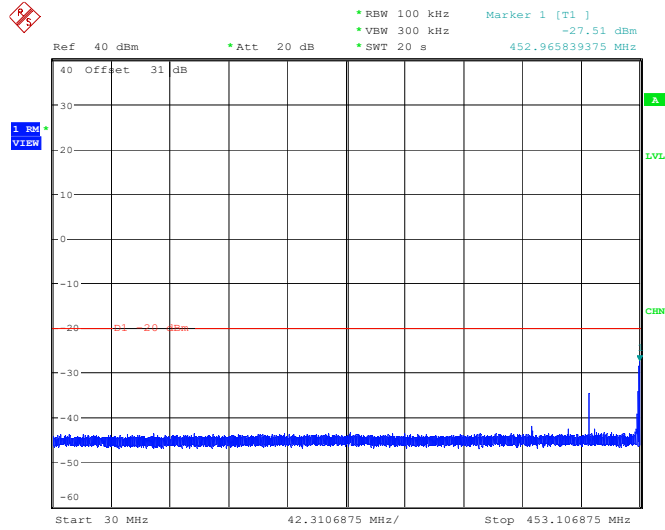

Project No.:2407X57682E-RF Tester:Lucas Lin
Date: 28.NOV.2024 13:30:12

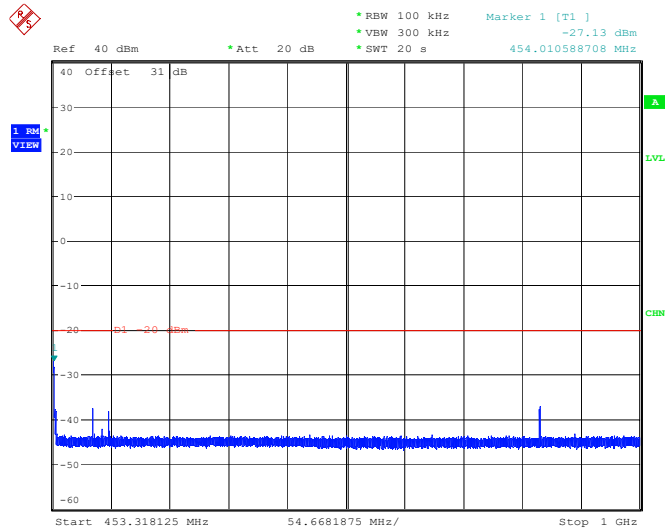

Project No.:2407X57682E-RF Tester:Lucas Lin
Date: 28.NOV.2024 13:34:56

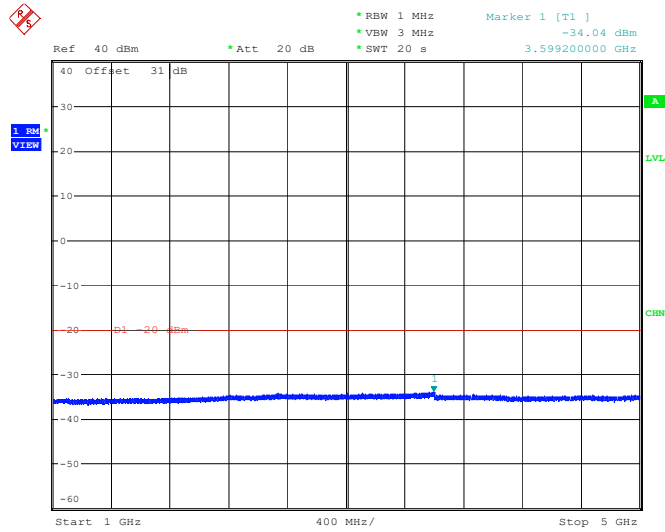

Project No.:2407X57682E-RF Tester:Lucas Lin
Date: 28.NOV.2024 14:19:02

High Power, 479.9875 MHz, (4FSK 12.5kHz)

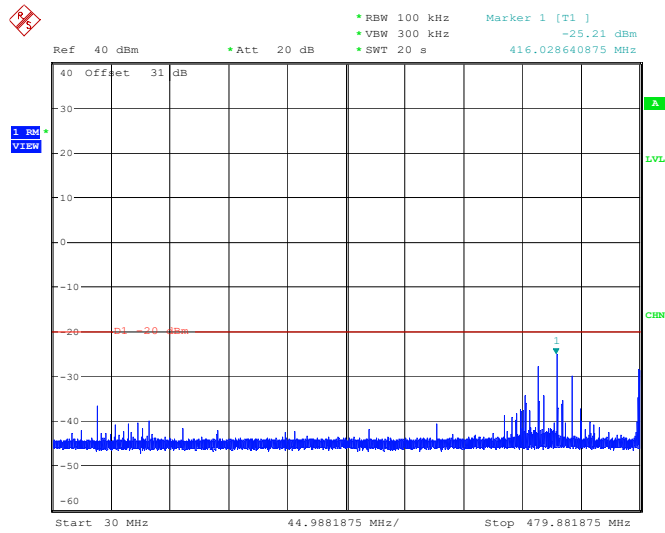

Project No.:2407X57682E-RF Tester:Lucas Lin
Date: 28.NOV.2024 13:52:24

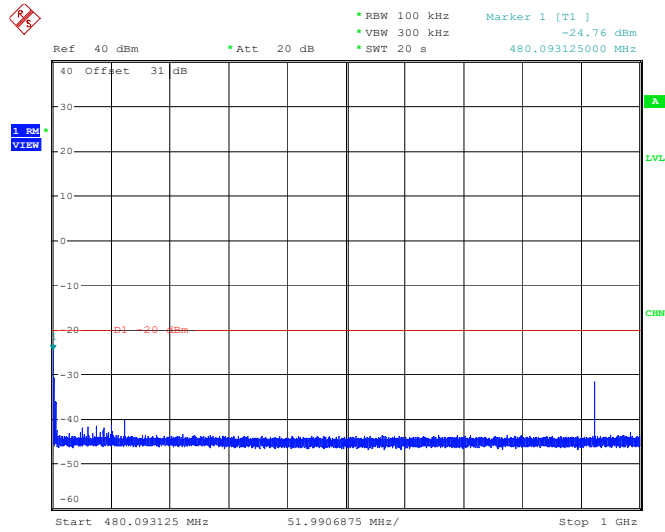

Project No.:2407X57682E-RF Tester:Lucas Lin
Date: 28.NOV.2024 13:58:06

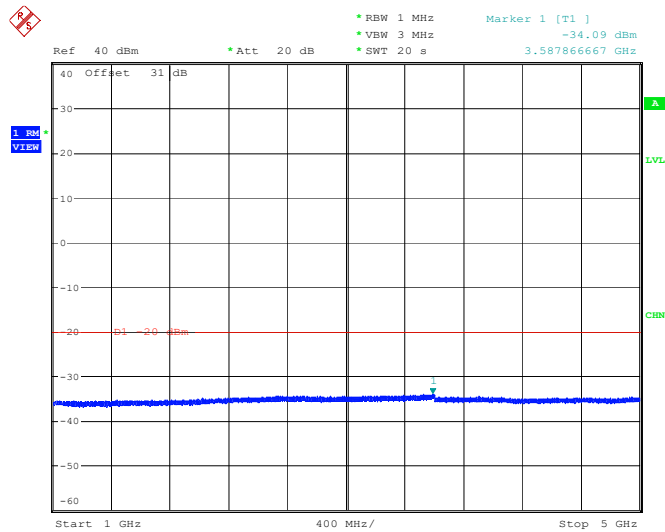

Project No.:2407X57682E-RF Tester:Lucas Lin
Date: 28.NOV.2024 14:21:55

Medium Power, 400.0125 MHz, (4FSK 12.5kHz)

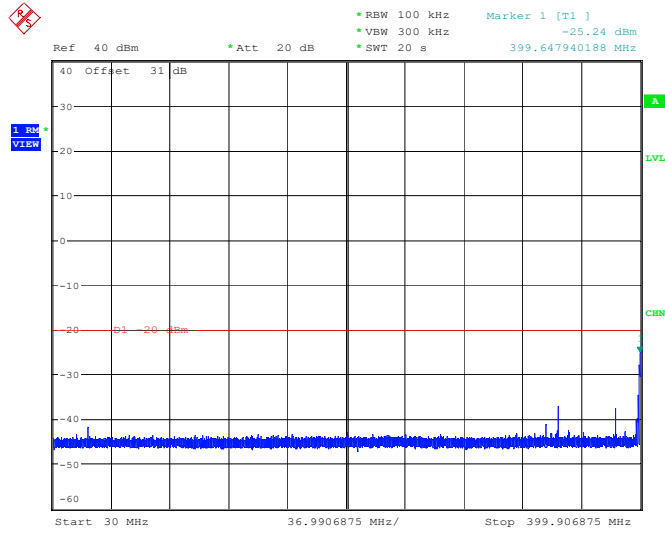

Project No.:2407X57682E-RF Tester:Lucas Lin
Date: 28.NOV.2024 13:16:28

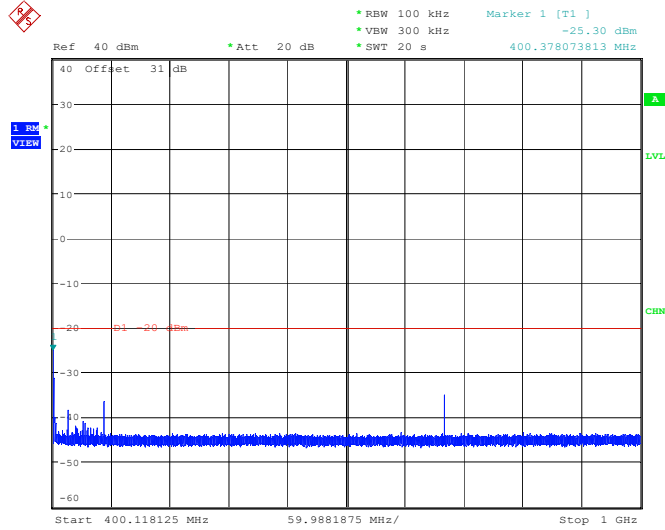

Project No.:2407X57682E-RF Tester:Lucas Lin
Date: 28.NOV.2024 13:20:31

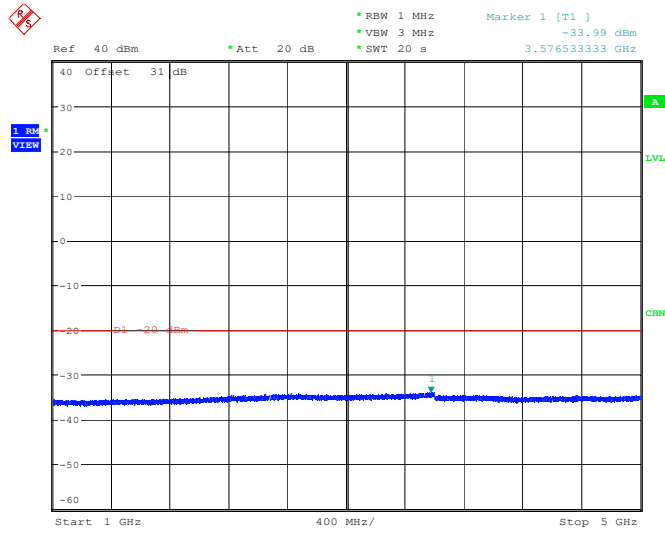

Project No.:2407X57682E-RF Tester:Lucas Lin
Date: 28.NOV.2024 14:18:17

Medium Power, 453.2125 MHz, (4FSK 12.5kHz)

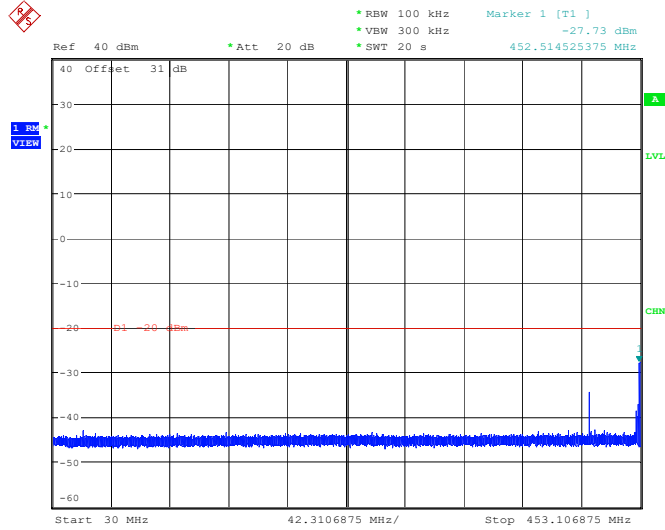

Project No.:2407X57682E-RF Tester:Lucas Lin
Date: 28.NOV.2024 13:32:28

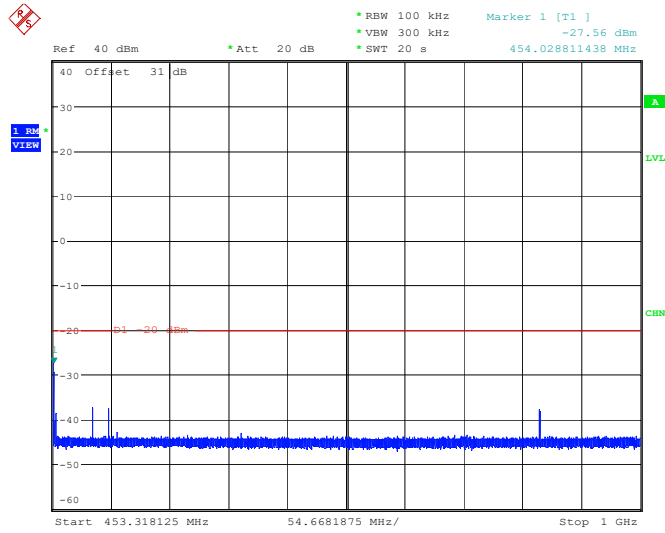

Project No.:2407X57682E-RF Tester:Lucas Lin
Date: 28.NOV.2024 13:39:01

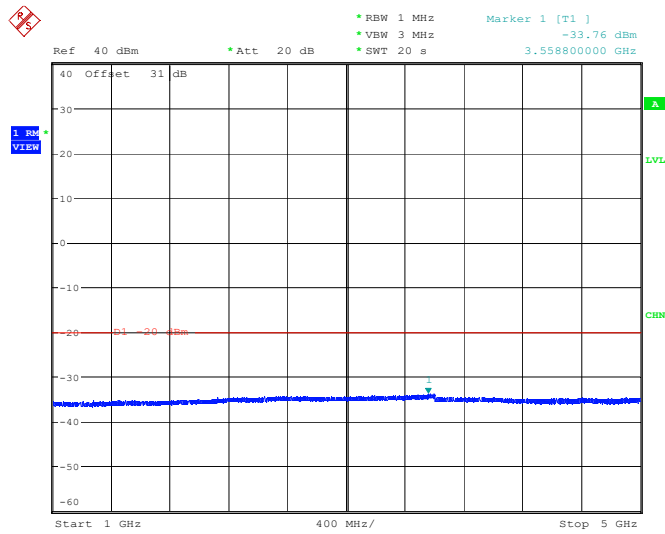

Project No.:2407X57682E-RF Tester:Lucas Lin
Date: 28.NOV.2024 14:20:45

Medium Power, 479.9875 MHz, (4FSK 12.5kHz)

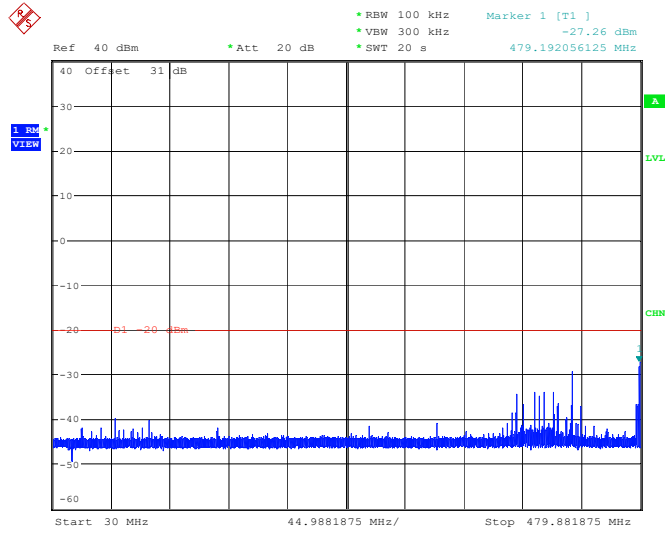

Project No.:2407X57682E-RF Tester:Lucas Lin
Date: 28.NOV.2024 13:54:38

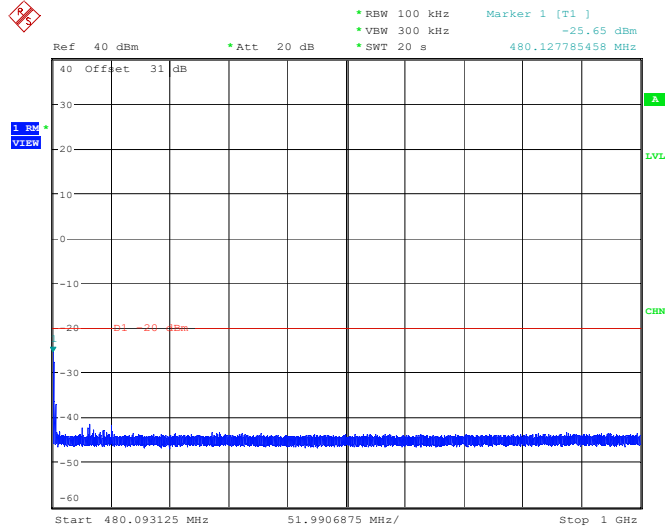

Project No.:2407X57682E-RF Tester:Lucas Lin
Date: 28.NOV.2024 14:00:21

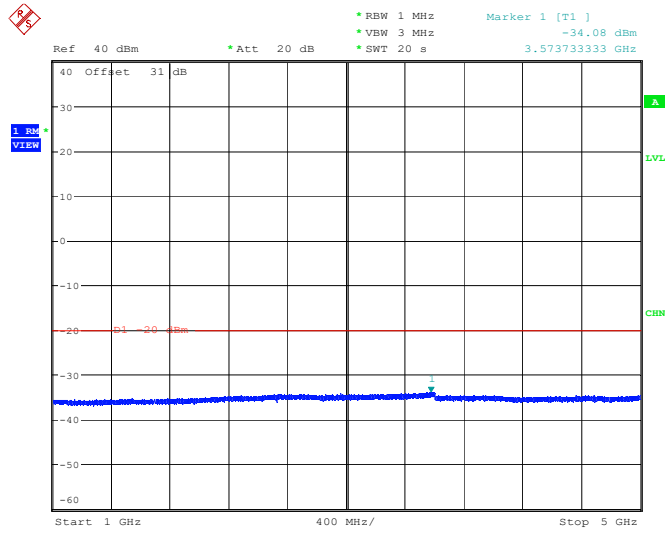

Project No.:2407X57682E-RF Tester:Lucas Lin
Date: 28.NOV.2024 14:24:16

Low Power, 400.0125 MHz, (4FSK 12.5kHz)

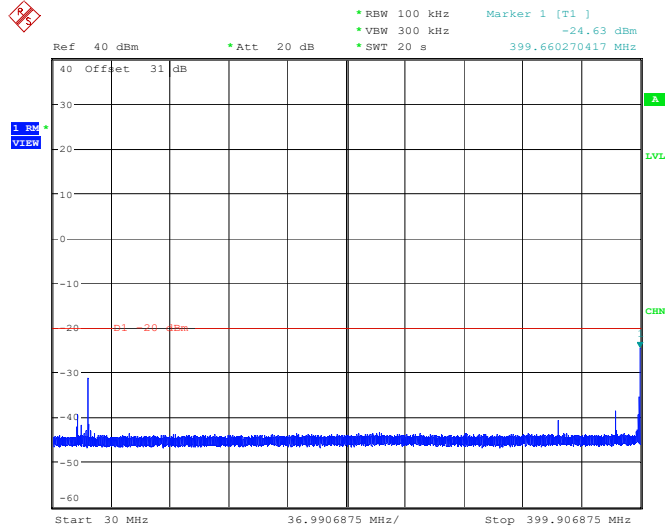

Project No.:2407X57682E-RF Tester:Lucas Lin
Date: 28.NOV.2024 13:15:19

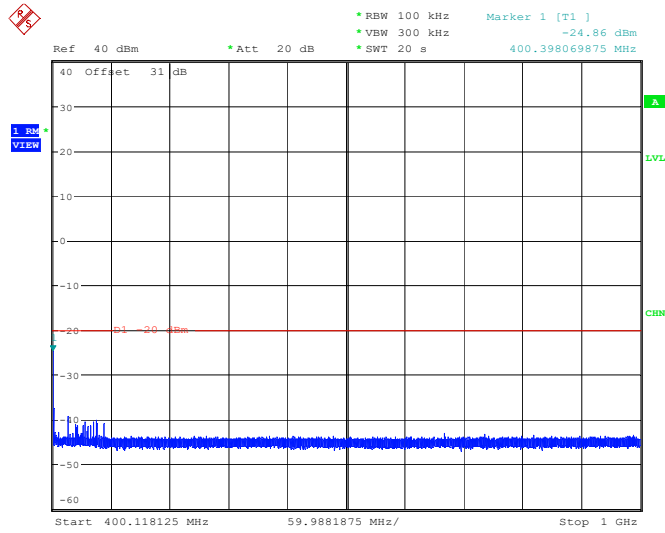

Project No.:2407X57682E-RF Tester:Lucas Lin
Date: 28.NOV.2024 13:19:21

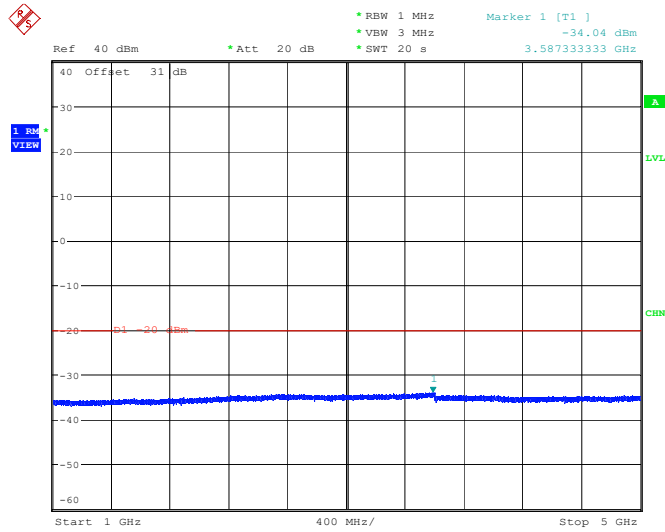

Project No.:2407X57682E-RF Tester:Lucas Lin
Date: 28.NOV.2024 14:17:23

Low Power, 453.2125 MHz, (4FSK 12.5kHz)

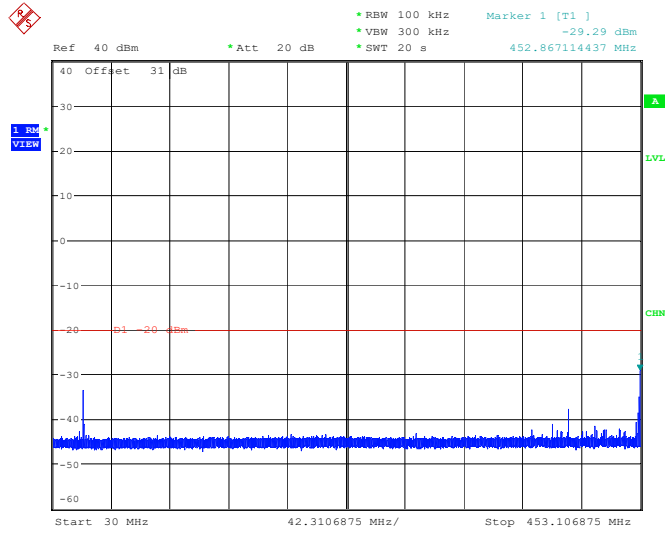

Project No.:2407X57682E-RF Tester:Lucas Lin
Date: 28.NOV.2024 13:31:22

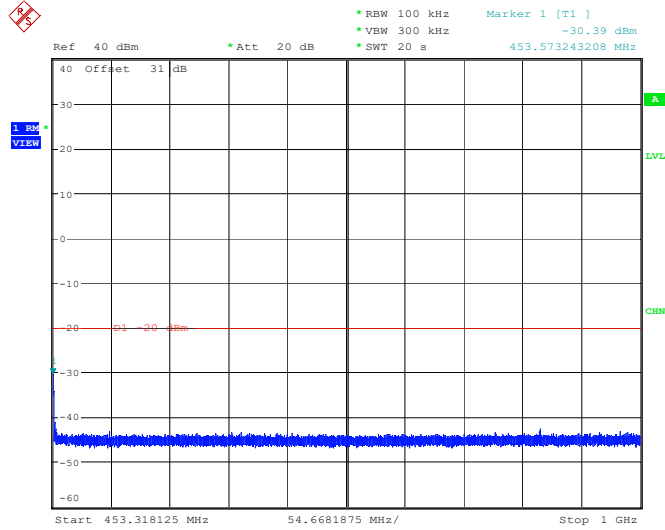

Project No.:2407X57682E-RF Tester:Lucas Lin
Date: 28.NOV.2024 13:37:55

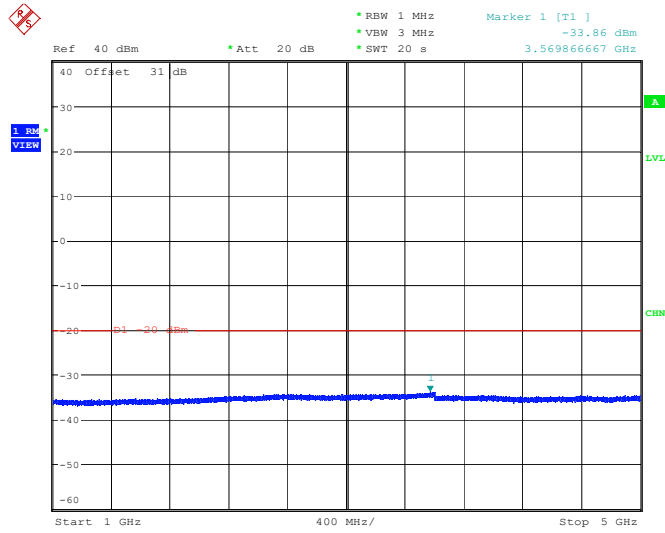

Project No.:2407X57682E-RF Tester:Lucas Lin
Date: 28.NOV.2024 14:19:46

Low Power, 479.9875 MHz, (4FSK 12.5kHz)

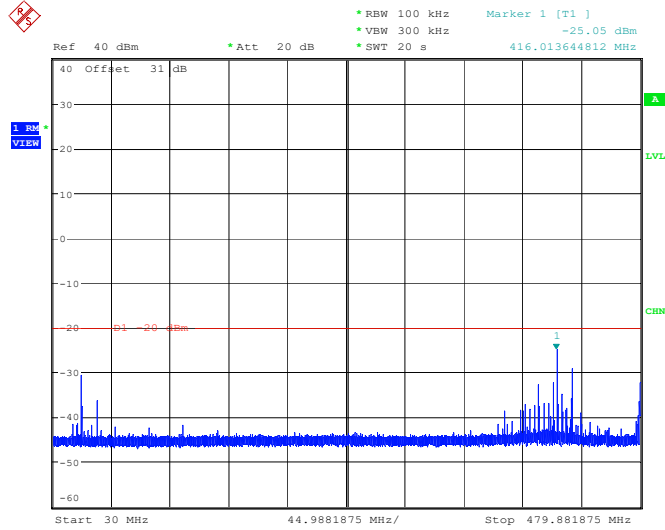

Project No.:2407X57682E-RF Tester:Lucas Lin
Date: 28.NOV.2024 13:53:34

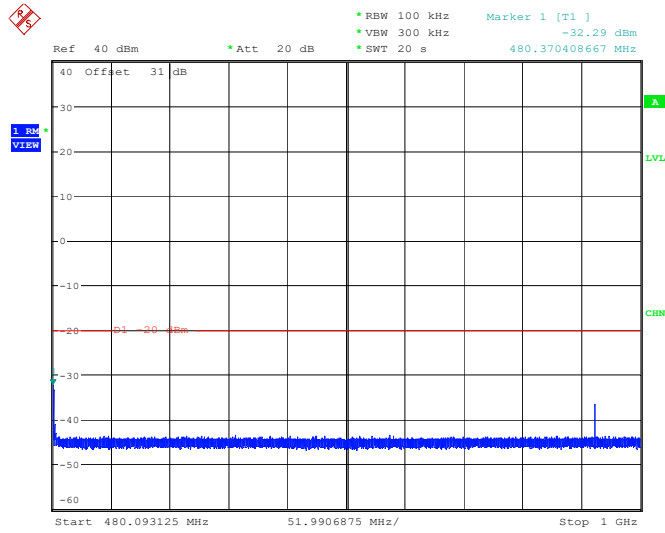

Project No.:2407X57682E-RF Tester:Lucas Lin
Date: 28.NOV.2024 13:59:17

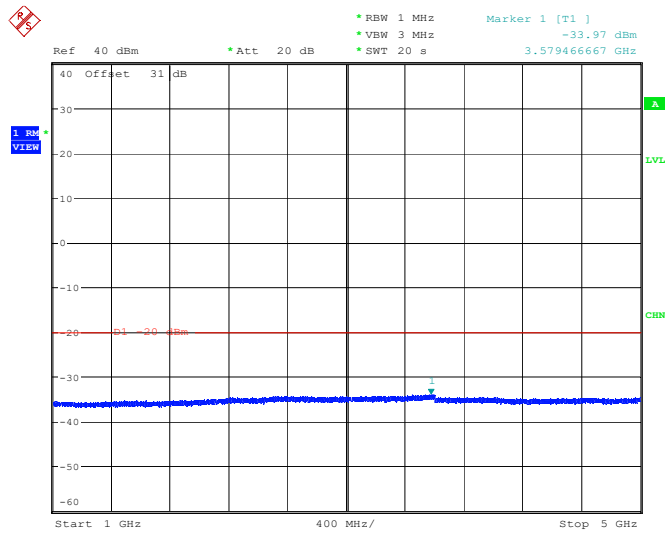

Project No.:2407X57682E-RF Tester:Lucas Lin
Date: 28.NOV.2024 14:23:00

FCC § 2.1053 & §90.210 - SPURIOUS RADIATED EMISSIONS

Applicable Standard

FCC §90.210

Emission Mask D—12.5 kHz channel bandwidth equipment. For transmitters designed to operate with a 12.5 kHz channel bandwidth, any emission must be attenuated below the power (P) of the highest emission contained within the authorized bandwidth as follows:

- (1) On any frequency from the center of the authorized bandwidth f_0 to 5.625 kHz removed from f_0 : Zero dB.
- (2) On any frequency removed from the center of the authorized bandwidth by a displacement frequency (f_d in kHz) of more than 5.625 kHz but no more than 12.5 kHz: At least $7.27(f_d - 2.88 \text{ kHz})$ dB.
- (3) On any frequency removed from the center of the authorized bandwidth by a displacement frequency (f_d in kHz) of more than 12.5 kHz: At least $50 + 10 \log (P)$ dB or 70 dB, whichever is the lesser attenuation.
- (4) The reference level for showing compliance with the emission mask shall be established using a resolution bandwidth sufficiently wide (usually two or three times the channel bandwidth) to capture the true peak emission of the equipment under test. In order to show compliance with the emission mask up to and including 50 kHz removed from the edge of the authorized bandwidth, adjust the resolution bandwidth to 100 Hz with the measuring instrument in a peak hold mode. A sufficient number of sweeps must be measured to insure that the emission profile is developed. If video filtering is used, its bandwidth must not be less than the instrument resolution bandwidth. For emissions beyond 50 kHz from the edge of the authorized bandwidth, see paragraph (o) of this section. If it can be shown that use of the above instrumentation settings do not accurately represent the true interference potential of the equipment under test, an alternate procedure may be used provided prior Commission approval is obtained.

Test setup

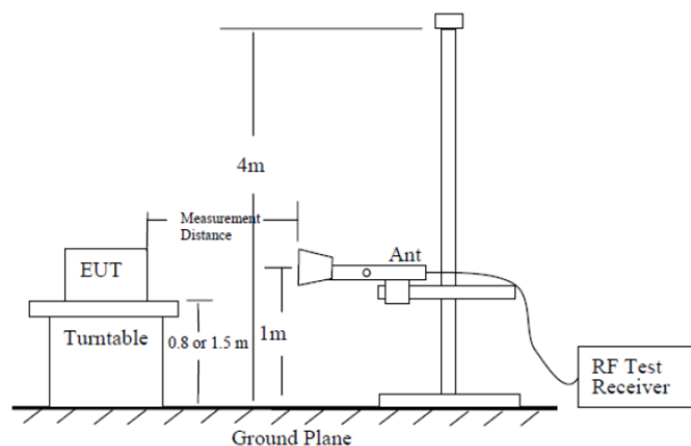

Figure 6—Test site-up for radiated ERP and/or EIRP measurements

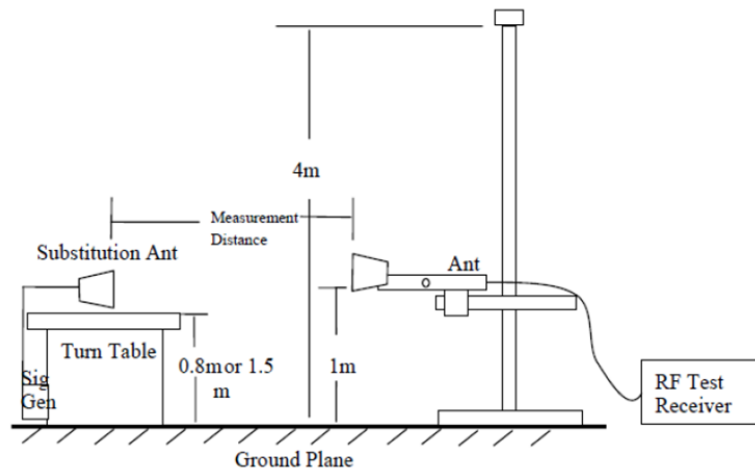

Figure 7—Substitution method set-up for radiated emission

Test Procedure

- a) Place the EUT in the center of the turntable. The EUT shall be configured to transmit into the standard non-radiating load (for measuring radiated spurious emissions), connected with cables of minimal length unless specified otherwise. If the EUT uses an adjustable antenna, the antenna shall be positioned to the length that produces the worst case emission at the fundamental operating frequency.
- b) Each emission under consideration shall be evaluated:
 - 1) Raise and lower the measurement antenna in accordance 5.5.2, as necessary to enable detection of the maximum emission amplitude relative to measurement antenna height.
 - 2) Rotate the EUT through 360° to determine the maximum emission level relative to the axial position.
 - 3) Return the turntable to the azimuth where the highest emission amplitude level was observed.
 - 4) Vary the measurement antenna height again through 1 m to 4 m again to find the height associated with the maximum emission amplitude.
 - 5) Record the measured emission amplitude level and frequency using the appropriate RBW.
- c) Repeat step b) for each emission frequency with the measurement antenna oriented in both the horizontal and vertical polarizations to determine the orientation that gives the maximum emissions amplitude.
- d) Set-up the substitution measurement with the reference point of the substitution antenna located as near as possible to where the center of the EUT radiating element was located during the initial EUT measurement.
- e) Maintain the previous measurement instrument settings and test set-up, with the exception that the EUT is removed and replaced by the substitution antenna.
- f) Connect a signal generator to the substitution antenna; locate the signal generator so as to minimize any potential influences on the measurement results. Set the signal generator to the frequency where emissions are detected, and set an output power level such that the radiated signal can be detected by the measurement instrument, with sufficient dynamic range relative to the noise floor.
- g) For each emission that was detected and measured in the initial test [i.e., in step b) and step c)]:
 - 1) Vary the measurement antenna height between 1 m to 4 m to maximize the received (measured) signal amplitude.
 - 2) Adjust the signal generator output power level until the amplitude detected by the measurement instrument equals the amplitude level of the emission previously measured directly in step b) and step c).
 - 3) Record the output power level of the signal generator when equivalence is achieved in step 2).
- h) Repeat step e) through step g) with the measurement antenna oriented in the opposite polarization.
- i) Calculate the emission power in dBm referenced to a half-wave dipole using the following equation:

$$P_e = P_s(\text{dBm}) - \text{cable loss (dB)} + \text{antenna gain (dBd)}$$
 Where
 P_e = equivalent emission power in dBm
 P_s = source (signal generator) power in dBm

NOTE—dBd refers to the measured antenna gain in decibels relative to a half-wave dipole.

- j) Correct the antenna gain of the substitution antenna if necessary to reference the emission power to a half-wave dipole. When using measurement antennas with the gain specified in dBi, the equivalent dipole-referenced gain can be determined from: gain (dBd) - gain (dBi)-2.15 dB. If necessary, the antenna gain can be calculated from calibrated antenna factor information.
- k) Provide the complete measurement results as a part of the test report.

Test Data

Test Mode:	Transmitting	Test Engineer:	Lucas Lin
Test Date:	2024-12-14	Test Result:	Compliant

Environment Conditions:					
Temperature: (°C)	23.5	Relative Humidity: (%)	50	ATM Pressure: (kPa)	100.1

Please refer to below table.

30MHz - 5GHz:

Frequency (MHz)	Polar (H/V)	Receiver Reading (dBµV)	Substituted Method			Absolute Level (dBm)	Limit (dBm)	Margin (dB)
			Substituted Level (dBm)	Antenna Gain (dBd/dBi)	Cable Loss (dB)			
FM, High Power, Frequency: 400.0125 MHz(12.5kHz)								
800.03	H	71.58	-28.54	0.00	0.41	-28.95	-20.00	8.95
800.03	V	71.29	-28.35	0.00	0.41	-28.76	-20.00	8.76
1200.038	H	79.88	-30.73	7.30	1.43	-24.86	-20.00	4.86
1200.038	V	74.74	-35.89	7.30	1.43	-30.02	-20.00	10.02
1600.050	H	68.69	-39.62	8.10	1.62	-33.14	-20.00	13.14
1600.050	V	66.25	-42.14	8.10	1.62	-35.66	-20.00	15.66
2000.063	H	66.74	-35.07	3.10	1.78	-33.75	-20.00	13.75
2000.063	V	66.55	-36.30	3.10	1.78	-34.98	-20.00	14.98
2400.075	H	57.88	-41.19	3.00	1.95	-40.14	-20.00	20.14
2400.075	V	55.06	-45.79	3.00	1.95	-44.74	-20.00	24.74
2800.088	H	50.70	-48.67	3.90	2.10	-46.87	-20.00	26.87
2800.088	V	51.73	-48.27	3.90	2.10	-46.47	-20.00	26.47
3200.100	H	50.29	-49.73	3.40	2.24	-48.57	-20.00	28.57
3200.100	V	51.93	-47.97	3.40	2.24	-46.81	-20.00	26.81
3600.113	H	57.12	-42.61	6.00	2.37	-38.98	-20.00	18.98
3600.113	V	57.77	-42.46	6.00	2.37	-38.83	-20.00	18.83
4000.125	H	59.42	-39.18	6.80	2.46	-34.84	-20.00	14.84
4000.125	V	55.60	-45.13	6.80	2.46	-40.79	-20.00	20.79
FM, Medium Power, Frequency: 400.0125 MHz(12.5kHz)								
800.03	H	70.25	-29.87	0.00	0.41	-30.28	-20.00	10.28
800.03	V	69.47	-30.17	0.00	0.41	-30.58	-20.00	10.58
1200.038	H	77.93	-32.68	7.30	1.43	-26.81	-20.00	6.81
1200.038	V	71.68	-38.95	7.30	1.43	-33.08	-20.00	13.08
1600.050	H	66.25	-42.06	8.10	1.62	-35.58	-20.00	15.58
1600.050	V	63.78	-44.61	8.10	1.62	-38.13	-20.00	18.13
2000.063	H	64.02	-37.79	3.10	1.78	-36.47	-20.00	16.47
2000.063	V	63.85	-39.00	3.10	1.78	-37.68	-20.00	17.68
2400.075	H	55.46	-43.61	3.00	1.95	-42.56	-20.00	22.56
2400.075	V	53.79	-47.06	3.00	1.95	-46.01	-20.00	26.01
2800.088	H	48.16	-51.21	3.90	2.10	-49.41	-20.00	29.41
2800.088	V	48.23	-51.77	3.90	2.10	-49.97	-20.00	29.97
3200.100	H	47.06	-52.96	3.40	2.24	-51.80	-20.00	31.80
3200.100	V	50.87	-49.03	3.40	2.24	-47.87	-20.00	27.87
3600.113	H	55.64	-44.09	6.00	2.37	-40.46	-20.00	20.46
3600.113	V	56.87	-43.36	6.00	2.37	-39.73	-20.00	19.73
4000.125	H	57.26	-41.34	6.80	2.46	-37.00	-20.00	17.00
4000.125	V	53.66	-47.07	6.80	2.46	-42.73	-20.00	22.73

Frequency (MHz)	Polar (H/V)	Receiver Reading (dBμV)	Substituted Method			Absolute Level (dBm)	Limit (dBm)	Margin (dB)
			Substituted Level (dBm)	Antenna Gain (dBd/dBi)	Cable Loss (dB)			
FM, Low Power, Frequency: 400.0125 MHz(12.5kHz)								
800.03	H	66.76	-33.36	0.00	0.41	-33.77	-20.00	13.77
800.03	V	62.23	-37.41	0.00	0.41	-37.82	-20.00	17.82
1200.038	H	74.19	-36.42	7.30	1.43	-30.55	-20.00	10.55
1200.038	V	68.76	-41.87	7.30	1.43	-36.00	-20.00	16.00
1600.050	H	64.52	-43.79	8.10	1.62	-37.31	-20.00	17.31
1600.050	V	61.35	-47.04	8.10	1.62	-40.56	-20.00	20.56
2000.063	H	60.08	-41.73	3.10	1.78	-40.41	-20.00	20.41
2000.063	V	61.38	-41.47	3.10	1.78	-40.15	-20.00	20.15
2400.075	H	52.72	-46.35	3.00	1.95	-45.30	-20.00	25.30
2400.075	V	50.81	-50.04	3.00	1.95	-48.99	-20.00	28.99
2800.088	H	46.23	-53.14	3.90	2.10	-51.34	-20.00	31.34
2800.088	V	44.61	-55.39	3.90	2.10	-53.59	-20.00	33.59
3200.100	H	44.94	-55.08	3.40	2.24	-53.92	-20.00	33.92
3200.100	V	47.82	-52.08	3.40	2.24	-50.92	-20.00	30.92
3600.113	H	52.38	-47.35	6.00	2.37	-43.72	-20.00	23.72
3600.113	V	54.18	-46.05	6.00	2.37	-42.42	-20.00	22.42
4000.125	H	53.89	-44.71	6.80	2.46	-40.37	-20.00	20.37
4000.125	V	51.82	-48.91	6.80	2.46	-44.57	-20.00	24.57
4FSK, High Power, Frequency: 400.0125 MHz(12.5kHz)								
800.03	H	71.51	-28.61	0.00	0.41	-29.02	-20.00	9.02
800.03	V	70.83	-28.81	0.00	0.41	-29.22	-20.00	9.22
1200.038	H	76.31	-34.30	7.30	1.43	-28.43	-20.00	8.43
1200.038	V	80.88	-29.75	7.30	1.43	-23.88	-20.00	3.88
1600.050	H	66.93	-41.38	8.10	1.62	-34.90	-20.00	14.90
1600.050	V	70.32	-38.07	8.10	1.62	-31.59	-20.00	11.59
2000.063	H	68.90	-32.91	3.10	1.78	-31.59	-20.00	11.59
2000.063	V	66.96	-35.89	3.10	1.78	-34.57	-20.00	14.57
2400.075	H	56.01	-43.06	3.00	1.95	-42.01	-20.00	22.01
2400.075	V	57.95	-42.90	3.00	1.95	-41.85	-20.00	21.85
2800.088	H	51.61	-47.76	3.90	2.10	-45.96	-20.00	25.96
2800.088	V	52.73	-47.27	3.90	2.10	-45.47	-20.00	25.47
3200.100	H	50.28	-49.74	3.40	2.24	-48.58	-20.00	28.58
3200.100	V	50.52	-49.38	3.40	2.24	-48.22	-20.00	28.22
3600.113	H	58.26	-41.47	6.00	2.37	-37.84	-20.00	17.84
3600.113	V	56.20	-44.03	6.00	2.37	-40.40	-20.00	20.40
4000.125	H	55.16	-43.44	6.80	2.46	-39.10	-20.00	19.10
4000.125	V	59.91	-40.82	6.80	2.46	-36.48	-20.00	16.48

Frequency (MHz)	Polar (H/V)	Receiver Reading (dBμV)	Substituted Method			Absolute Level (dBm)	Limit (dBm)	Margin (dB)
			Substituted Level (dBm)	Antenna Gain (dBd/dBi)	Cable Loss (dB)			
4FSK, Medium Power, Frequency: 400.0125 MHz(12.5kHz)								
800.03	H	69.82	-30.30	0.00	0.41	-30.71	-20.00	10.71
800.03	V	68.86	-30.78	0.00	0.41	-31.19	-20.00	11.19
1200.038	H	74.35	-36.26	7.30	1.43	-30.39	-20.00	10.39
1200.038	V	79.72	-30.91	7.30	1.43	-25.04	-20.00	5.04
1600.050	H	63.47	-44.84	8.10	1.62	-38.36	-20.00	18.36
1600.050	V	68.67	-39.72	8.10	1.62	-33.24	-20.00	13.24
2000.063	H	67.11	-34.70	3.10	1.78	-33.38	-20.00	13.38
2000.063	V	66.25	-36.60	3.10	1.78	-35.28	-20.00	15.28
2400.075	H	56.68	-42.39	3.00	1.95	-41.34	-20.00	21.34
2400.075	V	55.91	-44.94	3.00	1.95	-43.89	-20.00	23.89
2800.088	H	50.23	-49.14	3.90	2.10	-47.34	-20.00	27.34
2800.088	V	50.48	-49.52	3.90	2.10	-47.72	-20.00	27.72
3200.100	H	48.97	-51.05	3.40	2.24	-49.89	-20.00	29.89
3200.100	V	51.34	-48.56	3.40	2.24	-47.40	-20.00	27.40
3600.113	H	56.62	-43.11	6.00	2.37	-39.48	-20.00	19.48
3600.113	V	57.73	-42.50	6.00	2.37	-38.87	-20.00	18.87
4000.125	H	53.73	-44.87	6.80	2.46	-40.53	-20.00	20.53
4000.125	V	58.56	-42.17	6.80	2.46	-37.83	-20.00	17.83
4FSK, Low Power, Frequency: 400.0125 MHz(12.5kHz)								
800.03	H	65.90	-34.22	0.00	0.41	-34.63	-20.00	14.63
800.03	V	65.46	-34.18	0.00	0.41	-34.59	-20.00	14.59
1200.038	H	71.24	-39.37	7.30	1.43	-33.50	-20.00	13.50
1200.038	V	74.35	-36.28	7.30	1.43	-30.41	-20.00	10.41
1600.050	H	60.12	-48.19	8.10	1.62	-41.71	-20.00	21.71
1600.050	V	64.91	-43.48	8.10	1.62	-37.00	-20.00	17.00
2000.063	H	65.87	-35.94	3.10	1.78	-34.62	-20.00	14.62
2000.063	V	62.34	-40.51	3.10	1.78	-39.19	-20.00	19.19
2400.075	H	51.25	-47.82	3.00	1.95	-46.77	-20.00	26.77
2400.075	V	53.65	-47.20	3.00	1.95	-46.15	-20.00	26.15
2800.088	H	48.33	-51.04	3.90	2.10	-49.24	-20.00	29.24
2800.088	V	46.21	-53.79	3.90	2.10	-51.99	-20.00	31.99
3200.100	H	45.15	-54.87	3.40	2.24	-53.71	-20.00	33.71
3200.100	V	47.79	-52.11	3.40	2.24	-50.95	-20.00	30.95
3600.113	H	54.74	-44.99	6.00	2.37	-41.36	-20.00	21.36
3600.113	V	53.99	-46.24	6.00	2.37	-42.61	-20.00	22.61
4000.125	H	50.28	-48.32	6.80	2.46	-43.98	-20.00	23.98
4000.125	V	55.16	-45.57	6.80	2.46	-41.23	-20.00	21.23

Frequency (MHz)	Polar (H/V)	Receiver Reading (dBμV)	Substituted Method			Absolute Level (dBm)	Limit (dBm)	Margin (dB)
			Substituted Level (dBm)	Antenna Gain (dBd/dBi)	Cable Loss (dB)			
FM, High Power, Frequency: 453.2125 MHz(12.5kHz)								
906.43	H	64.91	-23.35	0.00	0.42	-23.77	-20.00	3.77
906.43	V	67.34	-20.74	0.00	0.42	-21.16	-20.00	1.16
1359.638	H	75.54	-34.71	7.54	1.51	-28.68	-20.00	8.68
1359.638	V	72.23	-37.94	7.54	1.51	-31.91	-20.00	11.91
1812.850	H	72.60	-32.25	6.70	1.71	-27.26	-20.00	7.26
1812.850	V	72.09	-33.35	6.70	1.71	-28.36	-20.00	8.36
2266.063	H	65.23	-34.76	3.73	1.89	-32.92	-20.00	12.92
2266.063	V	63.30	-38.22	3.73	1.89	-36.38	-20.00	16.38
2719.275	H	67.82	-31.29	3.62	2.07	-29.74	-20.00	9.74
2719.275	V	68.32	-31.77	3.62	2.07	-30.22	-20.00	10.22
3172.488	H	58.31	-41.71	3.34	2.23	-40.60	-20.00	20.60
3172.488	V	55.20	-44.68	3.34	2.23	-43.57	-20.00	23.57
3625.700	H	64.98	-34.68	6.00	2.38	-31.06	-20.00	11.06
3625.700	V	63.38	-36.89	6.00	2.38	-33.27	-20.00	13.27
4078.913	H	69.08	-29.65	6.87	2.49	-25.27	-20.00	5.27
4078.913	V	67.37	-32.65	6.87	2.49	-28.27	-20.00	8.27
4532.125	H	65.75	-33.68	9.83	2.63	-26.48	-20.00	6.48
4532.125	V	63.28	-33.11	9.83	2.63	-25.91	-20.00	5.91
FM, Medium Power, Frequency: 453.2125 MHz(12.5kHz)								
906.43	H	63.77	-24.49	0.00	0.42	-24.91	-20.00	4.91
906.43	V	65.87	-22.21	0.00	0.42	-22.63	-20.00	2.63
1359.638	H	73.77	-36.48	7.54	1.51	-30.45	-20.00	10.45
1359.638	V	70.34	-39.83	7.54	1.51	-33.80	-20.00	13.80
1812.850	H	70.05	-34.80	6.70	1.71	-29.81	-20.00	9.81
1812.850	V	69.68	-35.76	6.70	1.71	-30.77	-20.00	10.77
2266.063	H	62.86	-37.13	3.73	1.89	-35.29	-20.00	15.29
2266.063	V	61.28	-40.24	3.73	1.89	-38.40	-20.00	18.40
2719.275	H	65.97	-33.14	3.62	2.07	-31.59	-20.00	11.59
2719.275	V	66.04	-34.05	3.62	2.07	-32.50	-20.00	12.50
3172.488	H	55.83	-44.19	3.34	2.23	-43.08	-20.00	23.08
3172.488	V	52.90	-46.98	3.34	2.23	-45.87	-20.00	25.87
3625.700	H	61.46	-38.20	6.00	2.38	-34.58	-20.00	14.58
3625.700	V	60.13	-40.14	6.00	2.38	-36.52	-20.00	16.52
4078.913	H	66.84	-31.89	6.87	2.49	-27.51	-20.00	7.51
4078.913	V	64.51	-35.51	6.87	2.49	-31.13	-20.00	11.13
4532.125	H	62.58	-36.85	9.83	2.63	-29.65	-20.00	9.65
4532.125	V	60.43	-35.96	9.83	2.63	-28.76	-20.00	8.76

Frequency (MHz)	Polar (H/V)	Receiver Reading (dBμV)	Substituted Method			Absolute Level (dBm)	Limit (dBm)	Margin (dB)
			Substituted Level (dBm)	Antenna Gain (dBd/dBi)	Cable Loss (dB)			
FM, Low Power, Frequency: 453.2125 MHz(12.5kHz)								
906.43	H	57.13	-31.13	0.00	0.42	-31.55	-20.00	11.55
906.43	V	61.04	-27.04	0.00	0.42	-27.46	-20.00	7.46
1359.638	H	71.67	-38.58	7.54	1.51	-32.55	-20.00	12.55
1359.638	V	68.13	-42.04	7.54	1.51	-36.01	-20.00	16.01
1812.850	H	67.59	-37.26	6.70	1.71	-32.27	-20.00	12.27
1812.850	V	66.22	-39.22	6.70	1.71	-34.23	-20.00	14.23
2266.063	H	60.28	-39.71	3.73	1.89	-37.87	-20.00	17.87
2266.063	V	58.94	-42.58	3.73	1.89	-40.74	-20.00	20.74
2719.275	H	61.56	-37.55	3.62	2.07	-36.00	-20.00	16.00
2719.275	V	64.26	-35.83	3.62	2.07	-34.28	-20.00	14.28
3172.488	H	53.21	-46.81	3.34	2.23	-45.70	-20.00	25.70
3172.488	V	49.89	-49.99	3.34	2.23	-48.88	-20.00	28.88
3625.700	H	58.48	-41.18	6.00	2.38	-37.56	-20.00	17.56
3625.700	V	57.77	-42.50	6.00	2.38	-38.88	-20.00	18.88
4078.913	H	63.24	-35.49	6.87	2.49	-31.11	-20.00	11.11
4078.913	V	61.03	-38.99	6.87	2.49	-34.61	-20.00	14.61
4532.125	H	58.92	-40.51	9.83	2.63	-33.31	-20.00	13.31
4532.125	V	57.36	-39.03	9.83	2.63	-31.83	-20.00	11.83
4FSK, High Power, Frequency: 453.2125 MHz(12.5kHz)								
906.43	H	63.36	-24.90	0.00	0.42	-25.32	-20.00	5.32
906.43	V	66.81	-21.27	0.00	0.42	-21.69	-20.00	1.69
1359.638	H	75.45	-34.80	7.54	1.51	-28.77	-20.00	8.77
1359.638	V	71.80	-38.37	7.54	1.51	-32.34	-20.00	12.34
1812.850	H	65.64	-39.21	6.70	1.71	-34.22	-20.00	14.22
1812.850	V	68.02	-37.42	6.70	1.71	-32.43	-20.00	12.43
2266.063	H	62.78	-37.21	3.73	1.89	-35.37	-20.00	15.37
2266.063	V	64.25	-37.27	3.73	1.89	-35.43	-20.00	15.43
2719.275	H	65.66	-33.45	3.62	2.07	-31.90	-20.00	11.90
2719.275	V	62.87	-37.22	3.62	2.07	-35.67	-20.00	15.67
3172.488	H	56.47	-43.55	3.34	2.23	-42.44	-20.00	22.44
3172.488	V	54.87	-45.01	3.34	2.23	-43.90	-20.00	23.90
3625.700	H	63.11	-36.55	6.00	2.38	-32.93	-20.00	12.93
3625.700	V	59.90	-40.37	6.00	2.38	-36.75	-20.00	16.75
4078.913	H	68.24	-30.49	6.87	2.49	-26.11	-20.00	6.11
4078.913	V	65.47	-34.55	6.87	2.49	-30.17	-20.00	10.17
4532.125	H	68.84	-30.59	9.83	2.63	-23.39	-20.00	3.39
4532.125	V	61.38	-35.01	9.83	2.63	-27.81	-20.00	7.81

Frequency (MHz)	Polar (H/V)	Receiver Reading (dBμV)	Substituted Method			Absolute Level (dBm)	Limit (dBm)	Margin (dB)
			Substituted Level (dBm)	Antenna Gain (dBd/dBi)	Cable Loss (dB)			
4FSK, Medium Power, Frequency: 453.2125 MHz(12.5kHz)								
906.43	H	63.22	-25.04	0.00	0.42	-25.46	-20.00	5.46
906.43	V	65.01	-23.07	0.00	0.42	-23.49	-20.00	3.49
1359.638	H	72.98	-37.27	7.54	1.51	-31.24	-20.00	11.24
1359.638	V	70.35	-39.82	7.54	1.51	-33.79	-20.00	13.79
1812.850	H	62.72	-42.13	6.70	1.71	-37.14	-20.00	17.14
1812.850	V	65.84	-39.60	6.70	1.71	-34.61	-20.00	14.61
2266.063	H	60.42	-39.57	3.73	1.89	-37.73	-20.00	17.73
2266.063	V	61.37	-40.15	3.73	1.89	-38.31	-20.00	18.31
2719.275	H	63.05	-36.06	3.62	2.07	-34.51	-20.00	14.51
2719.275	V	60.14	-39.95	3.62	2.07	-38.40	-20.00	18.40
3172.488	H	54.78	-45.24	3.34	2.23	-44.13	-20.00	24.13
3172.488	V	52.36	-47.52	3.34	2.23	-46.41	-20.00	26.41
3625.700	H	60.79	-38.87	6.00	2.38	-35.25	-20.00	15.25
3625.700	V	57.56	-42.71	6.00	2.38	-39.09	-20.00	19.09
4078.913	H	66.32	-32.41	6.87	2.49	-28.03	-20.00	8.03
4078.913	V	62.74	-37.28	6.87	2.49	-32.90	-20.00	12.90
4532.125	H	65.19	-34.24	9.83	2.63	-27.04	-20.00	7.04
4532.125	V	59.83	-36.56	9.83	2.63	-29.36	-20.00	9.36
4FSK, Low Power, Frequency: 453.2125 MHz(12.5kHz)								
906.43	H	59.19	-29.07	0.00	0.42	-29.49	-20.00	9.49
906.43	V	60.43	-27.65	0.00	0.42	-28.07	-20.00	8.07
1359.638	H	70.32	-39.93	7.54	1.51	-33.90	-20.00	13.90
1359.638	V	68.26	-41.91	7.54	1.51	-35.88	-20.00	15.88
1812.850	H	60.12	-44.73	6.70	1.71	-39.74	-20.00	19.74
1812.850	V	62.63	-42.81	6.70	1.71	-37.82	-20.00	17.82
2266.063	H	57.94	-42.05	3.73	1.89	-40.21	-20.00	20.21
2266.063	V	59.32	-42.20	3.73	1.89	-40.36	-20.00	20.36
2719.275	H	60.25	-38.86	3.62	2.07	-37.31	-20.00	17.31
2719.275	V	57.82	-42.27	3.62	2.07	-40.72	-20.00	20.72
3172.488	H	51.02	-49.00	3.34	2.23	-47.89	-20.00	27.89
3172.488	V	49.98	-49.90	3.34	2.23	-48.79	-20.00	28.79
3625.700	H	57.25	-42.41	6.00	2.38	-38.79	-20.00	18.79
3625.700	V	54.79	-45.48	6.00	2.38	-41.86	-20.00	21.86
4078.913	H	64.58	-34.15	6.87	2.49	-29.77	-20.00	9.77
4078.913	V	60.13	-39.89	6.87	2.49	-35.51	-20.00	15.51
4532.125	H	62.35	-37.08	9.83	2.63	-29.88	-20.00	9.88
4532.125	V	56.73	-39.66	9.83	2.63	-32.46	-20.00	12.46

Frequency (MHz)	Polar (H/V)	Receiver Reading (dBμV)	Substituted Method			Absolute Level (dBm)	Limit (dBm)	Margin (dB)
			Substituted Level (dBm)	Antenna Gain (dBd/dBi)	Cable Loss (dB)			
FM, High Power, Frequency: 479.9875 MHz(12.5kHz)								
959.98	H	66.13	-24.41	0.00	0.43	-24.84	-20.00	4.84
959.98	V	68.81	-21.56	0.00	0.43	-21.99	-20.00	1.99
1439.963	H	69.05	-41.02	7.86	1.55	-34.71	-20.00	14.71
1439.963	V	63.37	-46.57	7.86	1.55	-40.26	-20.00	20.26
1919.950	H	57.34	-45.77	5.04	1.75	-42.48	-20.00	22.48
1919.950	V	54.24	-49.72	5.04	1.75	-46.43	-20.00	26.43
2399.938	H	54.99	-44.08	3.00	1.95	-43.03	-20.00	23.03
2399.938	V	55.62	-45.23	3.00	1.95	-44.18	-20.00	24.18
2879.925	H	55.84	-43.80	3.96	2.13	-41.97	-20.00	21.97
2879.925	V	53.47	-46.43	3.96	2.13	-44.60	-20.00	24.60
3359.913	H	51.85	-48.17	4.68	2.30	-45.79	-20.00	25.79
3359.913	V	53.96	-46.05	4.68	2.30	-43.67	-20.00	23.67
3839.900	H	58.56	-40.49	6.32	2.42	-36.59	-20.00	16.59
3839.900	V	62.56	-37.97	6.32	2.42	-34.07	-20.00	14.07
4319.888	H	53.87	-45.25	8.18	2.56	-39.63	-20.00	19.63
4319.888	V	54.70	-43.16	8.18	2.56	-37.54	-20.00	17.54
4799.875	H	46.80	-52.69	11.80	2.69	-43.58	-20.00	23.58
4799.875	V	47.26	-50.27	11.80	2.69	-41.16	-20.00	21.16
FM, Medium Power, Frequency: 479.9875 MHz(12.5kHz)								
959.98	H	65.09	-25.45	0.00	0.43	-25.88	-20.00	5.88
959.98	V	68.26	-22.11	0.00	0.43	-22.54	-20.00	2.54
1439.963	H	67.59	-42.48	7.86	1.55	-36.17	-20.00	16.17
1439.963	V	60.25	-49.69	7.86	1.55	-43.38	-20.00	23.38
1919.950	H	54.61	-48.50	5.04	1.75	-45.21	-20.00	25.21
1919.950	V	51.27	-52.69	5.04	1.75	-49.40	-20.00	29.40
2399.938	H	51.12	-47.95	3.00	1.95	-46.90	-20.00	26.90
2399.938	V	52.06	-48.79	3.00	1.95	-47.74	-20.00	27.74
2879.925	H	52.97	-46.67	3.96	2.13	-44.84	-20.00	24.84
2879.925	V	50.42	-49.48	3.96	2.13	-47.65	-20.00	27.65
3359.913	H	48.63	-51.39	4.68	2.30	-49.01	-20.00	29.01
3359.913	V	50.28	-49.73	4.68	2.30	-47.35	-20.00	27.35
3839.900	H	56.32	-42.73	6.32	2.42	-38.83	-20.00	18.83
3839.900	V	60.34	-40.19	6.32	2.42	-36.29	-20.00	16.29
4319.888	H	50.78	-48.34	8.18	2.56	-42.72	-20.00	22.72
4319.888	V	51.54	-46.32	8.18	2.56	-40.70	-20.00	20.70
4799.875	H	44.92	-54.57	11.80	2.69	-45.46	-20.00	25.46
4799.875	V	43.53	-54.00	11.80	2.69	-44.89	-20.00	24.89

Frequency (MHz)	Polar (H/V)	Receiver Reading (dBμV)	Substituted Method			Absolute Level (dBm)	Limit (dBm)	Margin (dB)
			Substituted Level (dBm)	Antenna Gain (dBd/dBi)	Cable Loss (dB)			
FM, Low Power, Frequency: 479.9875 MHz(12.5kHz)								
959.98	H	60.97	-29.57	0.00	0.43	-30.00	-20.00	10.00
959.98	V	66.68	-23.69	0.00	0.43	-24.12	-20.00	4.12
1439.963	H	64.98	-45.09	7.86	1.55	-38.78	-20.00	18.78
1439.963	V	57.52	-52.42	7.86	1.55	-46.11	-20.00	26.11
1919.950	H	52.43	-50.68	5.04	1.75	-47.39	-20.00	27.39
1919.950	V	48.38	-55.58	5.04	1.75	-52.29	-20.00	32.29
2399.938	H	48.72	-50.35	3.00	1.95	-49.30	-20.00	29.30
2399.938	V	50.29	-50.56	3.00	1.95	-49.51	-20.00	29.51
2879.925	H	50.14	-49.50	3.96	2.13	-47.67	-20.00	27.67
2879.925	V	47.67	-52.23	3.96	2.13	-50.40	-20.00	30.40
3359.913	H	46.32	-53.70	4.68	2.30	-51.32	-20.00	31.32
3359.913	V	48.16	-51.85	4.68	2.30	-49.47	-20.00	29.47
3839.900	H	53.41	-45.64	6.32	2.42	-41.74	-20.00	21.74
3839.900	V	57.05	-43.48	6.32	2.42	-39.58	-20.00	19.58
4319.888	H	47.76	-51.36	8.18	2.56	-45.74	-20.00	25.74
4319.888	V	49.14	-48.72	8.18	2.56	-43.10	-20.00	23.10
4799.875	H	41.72	-57.77	11.80	2.69	-48.66	-20.00	28.66
4799.875	V	40.55	-56.98	11.80	2.69	-47.87	-20.00	27.87
4FSK, High Power, Frequency: 479.9875 MHz(12.5kHz)								
959.98	H	64.99	-25.55	0.00	0.43	-25.98	-20.00	5.98
959.98	V	69.03	-21.34	0.00	0.43	-21.77	-20.00	1.77
1439.963	H	67.61	-42.46	7.86	1.55	-36.15	-20.00	16.15
1439.963	V	64.52	-45.42	7.86	1.55	-39.11	-20.00	19.11
1919.950	H	58.51	-44.60	5.04	1.75	-41.31	-20.00	21.31
1919.950	V	55.94	-48.02	5.04	1.75	-44.73	-20.00	24.73
2399.938	H	56.38	-42.69	3.00	1.95	-41.64	-20.00	21.64
2399.938	V	58.85	-42.00	3.00	1.95	-40.95	-20.00	20.95
2879.925	H	60.02	-39.62	3.96	2.13	-37.79	-20.00	17.79
2879.925	V	57.59	-42.31	3.96	2.13	-40.48	-20.00	20.48
3359.913	H	55.33	-44.69	4.68	2.30	-42.31	-20.00	22.31
3359.913	V	53.80	-46.21	4.68	2.30	-43.83	-20.00	23.83
3839.900	H	59.48	-39.57	6.32	2.42	-35.67	-20.00	15.67
3839.900	V	62.59	-37.94	6.32	2.42	-34.04	-20.00	14.04
4319.888	H	52.82	-46.30	8.18	2.56	-40.68	-20.00	20.68
4319.888	V	52.99	-44.87	8.18	2.56	-39.25	-20.00	19.25
4799.875	H	44.59	-54.90	11.80	2.69	-45.79	-20.00	25.79
4799.875	V	46.31	-51.22	11.80	2.69	-42.11	-20.00	22.11

Frequency (MHz)	Polar (H/V)	Receiver Reading (dBμV)	Substituted Method			Absolute Level (dBm)	Limit (dBm)	Margin (dB)
			Substituted Level (dBm)	Antenna Gain (dBd/dBi)	Cable Loss (dB)			
4FSK, Medium Power, Frequency: 479.9875 MHz(12.5kHz)								
959.98	H	62.31	-28.23	0.00	0.43	-28.66	-20.00	8.66
959.98	V	68.23	-22.14	0.00	0.43	-22.57	-20.00	2.57
1439.963	H	64.75	-45.32	7.86	1.55	-39.01	-20.00	19.01
1439.963	V	62.59	-47.35	7.86	1.55	-41.04	-20.00	21.04
1919.950	H	56.28	-46.83	5.04	1.75	-43.54	-20.00	23.54
1919.950	V	53.12	-50.84	5.04	1.75	-47.55	-20.00	27.55
2399.938	H	54.72	-44.35	3.00	1.95	-43.30	-20.00	23.30
2399.938	V	55.03	-45.82	3.00	1.95	-44.77	-20.00	24.77
2879.925	H	58.93	-40.71	3.96	2.13	-38.88	-20.00	18.88
2879.925	V	55.05	-44.85	3.96	2.13	-43.02	-20.00	23.02
3359.913	H	52.26	-47.76	4.68	2.30	-45.38	-20.00	25.38
3359.913	V	51.44	-48.57	4.68	2.30	-46.19	-20.00	26.19
3839.900	H	57.13	-41.92	6.32	2.42	-38.02	-20.00	18.02
3839.900	V	60.02	-40.51	6.32	2.42	-36.61	-20.00	16.61
4319.888	H	50.72	-48.40	8.18	2.56	-42.78	-20.00	22.78
4319.888	V	49.87	-47.99	8.18	2.56	-42.37	-20.00	22.37
4799.875	H	42.53	-56.96	11.80	2.69	-47.85	-20.00	27.85
4799.875	V	44.13	-53.40	11.80	2.69	-44.29	-20.00	24.29
4FSK, Low Power, Frequency: 479.9875 MHz(12.5kHz)								
959.98	H	61.33	-29.21	0.00	0.43	-29.64	-20.00	9.64
959.98	V	67.41	-22.96	0.00	0.43	-23.39	-20.00	3.39
1439.963	H	61.54	-48.53	7.86	1.55	-42.22	-20.00	22.22
1439.963	V	60.32	-49.62	7.86	1.55	-43.31	-20.00	23.31
1919.950	H	54.79	-48.32	5.04	1.75	-45.03	-20.00	25.03
1919.950	V	50.51	-53.45	5.04	1.75	-50.16	-20.00	30.16
2399.938	H	51.68	-47.39	3.00	1.95	-46.34	-20.00	26.34
2399.938	V	53.14	-47.71	3.00	1.95	-46.66	-20.00	26.66
2879.925	H	57.84	-41.80	3.96	2.13	-39.97	-20.00	19.97
2879.925	V	53.02	-46.88	3.96	2.13	-45.05	-20.00	25.05
3359.913	H	49.94	-50.08	4.68	2.30	-47.70	-20.00	27.70
3359.913	V	47.53	-52.48	4.68	2.30	-50.10	-20.00	30.10
3839.900	H	54.62	-44.43	6.32	2.42	-40.53	-20.00	20.53
3839.900	V	57.41	-43.12	6.32	2.42	-39.22	-20.00	19.22
4319.888	H	47.85	-51.27	8.18	2.56	-45.65	-20.00	25.65
4319.888	V	47.25	-50.61	8.18	2.56	-44.99	-20.00	24.99
4799.875	H	40.03	-59.46	11.80	2.69	-50.35	-20.00	30.35
4799.875	V	41.26	-56.27	11.80	2.69	-47.16	-20.00	27.16

Note:

- 1) Antenna gain is dBd for frequency below 1GHz and is dBi for frequency above 1GHz.
- 2) Absolute Level = Substituted Level (dBm) - Cable loss + Antenna Gain
- 3) Margin = Limit- Absolute Level

FCC § 2.1055 & §90.213 - FREQUENCY STABILITY

Applicable Standard

FCC §90.213

In the 150-174 MHz band, fixed and base stations with a 12.5 kHz channel bandwidth must have a frequency stability of 2.5 ppm. Fixed and base stations with a 6.25 kHz channel bandwidth must have a frequency stability of 1.0 ppm.

In the 150-174 MHz band, mobile stations designed to operate with a 12.5 kHz channel bandwidth or designed to operate on a frequency specifically designated for itinerant use or designed for low-power operation of two watts or less, must have a frequency stability of 5.0 ppm. Mobile stations designed to operate with a 6.25 kHz channel bandwidth must have a frequency stability of 2.0 ppm.

In the 421-512 MHz band, mobile stations designed to operate with a 12.5 kHz channel bandwidth must have a frequency stability of 2.5 ppm. Mobile stations designed to operate with a 6.25 kHz channel bandwidth must have a frequency stability of 1.0 ppm.

Test Procedure

According to ANSI C63.26-2015 Section 5.6:

Frequency stability is a measure of the frequency drift due to temperature and supply voltage variations, with reference to the frequency measured at +20 °C and rated supply voltage.

The operating carrier frequency shall be set up in accordance with the manufacturer's published operation and instruction manual prior to the commencement of these tests. No adjustment of any frequency determining circuit element shall be made subsequent to this initial set-up. Frequency stability is tested:

- a) At 10 °C intervals of temperatures between -30 °C and +50 °C at the manufacturer's rated supply voltage, and
- b) At +20 °C temperature and ±15% supply voltage variations. If a product is specified to operate over a range of input voltage then the -15% variation is applied to the lowermost voltage and the +15% is applied to the uppermost voltage.

During the test all necessary settings, adjustments and control of the EUT have to be performed without disturbing the test environment, i.e., without opening the environmental chamber. The frequency stabilities can be maintained to a lesser temperature range provided that the transmitter is automatically inhibited from operating outside the lesser temperature range. For handheld equipment that is only capable of operating from internal batteries and the supply voltage cannot be varied, the frequency stability tests shall be performed at the nominal battery voltage and the battery end point voltage specified by the manufacturer. An external supply voltage can be used and set at the internal battery nominal voltage, and again at the battery operating end point voltage which shall be specified by the equipment manufacturer. If an unmodulated carrier is not available, the mean frequency of a modulated carrier can be obtained by using a frequency counter with gating time set to an appropriately large multiple of bit periods (gating time depending on the required accuracy). Full details on the choice of values shall be included in the test report.

EUT Setup Block Diagram

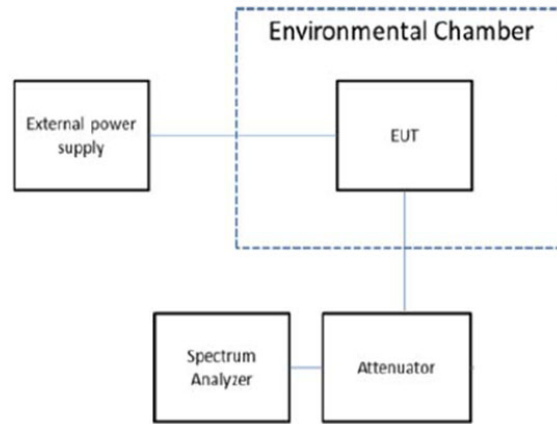

Test Data

Test Mode:	Transmitting	Test Engineer:	Lucas Lin
Test Date:	2024-11-29	Test Result:	Compliant

Environment Conditions:					
Temperature: (°C)	23.7	Relative Humidity: (%)	49	ATM Pressure: (kPa)	100.1

Please refer to below table:

High Power, $f_c = 453.2125 \text{ MHz}$ 12.5kHz				
Temperature	★Voltage	Reading	Frequency Error	Limit
°C	Vdc	MHz	ppm	ppm
-30	7.4	453.2126892	0.42	2.5
-20		453.2126581	0.35	
-10		453.2126327	0.29	
0		453.2126026	0.23	
10		453.2125698	0.15	
20		453.2125321	0.07	
30		453.2125916	0.20	
40		453.2126614	0.36	
50		453.2126903	0.42	
20		6.2	453.2126203	
20	8.4	453.2126311	0.29	

Middle Power, fc =453.2125 MHz 12.5kHz				
Temperature	★Voltage	Reading	Frequency Error	Limit
°C	Vdc	MHz	ppm	ppm
-30	7.4	453.2126993	0.44	2.5
-20		453.2126746	0.39	
-10		453.2126546	0.34	
0		453.2126412	0.31	
10		453.2126289	0.28	
20		453.2125321	0.07	
30		453.2126058	0.23	
40		453.2126572	0.35	
50		453.2127022	0.45	
20	6.2	453.2126423	0.31	
20	8.4	453.2126502	0.33	

Low Power, fc =453.2125 MHz 12.5kHz				
Temperature	★Voltage	Reading	Frequency Error	Limit
°C	Vdc	MHz	ppm	ppm
-30	7.4	453.2127357	0.52	2.5
-20		453.2127011	0.44	
-10		453.2126852	0.41	
0		453.2126682	0.37	
10		453.2126281	0.28	
20		453.2125321	0.07	
30		453.2126150	0.25	
40		453.2126696	0.37	
50		453.2127168	0.48	
20	6.2	453.2126352	0.30	
20	8.4	453.2126408	0.31	

Note:

1. The Operation Voltage range was provided by manufacturer.
2. The measurement was measured in the absence of modulation.

FCC §90.214 - TRANSIENT FREQUENCY BEHAVIOR

Applicable Standard

FCC §90.214

Transmitters designed to operate in the 150-174 MHz and 421-512 MHz frequency bands must maintain transient frequencies within the maximum frequency difference limits during the time intervals indicated:

Time intervals ^{1,2}	Maximum frequency difference ³	All equipment	
		150 to 174 MHz	421 to 512 MHz
Transient Frequency Behavior for Equipment Designed to Operate on 12.5 kHz Channels			
t ₁ ⁴	±12.5 kHz	5.0 ms	10.0 ms
t ₂	±6.25 kHz	20.0 ms	25.0 ms
t ₃ ⁴	±12.5 kHz	5.0 ms	10.0 ms

Test Procedure

According to ANSI C63.26-2015 Section 6.5.2.2:

- a) Connect the equipment as illustrated.
- b) Connect the output of the transmitter to the signal analyzer with modulation domain analyzer function.
- c) Set the modulation domain analyzer to trigger on the rising edge of the waveform in order to capture a single-shot turn-on of the transmitter signal.
- d) Adjust the display of the modulation domain analyzer for proper viewing of the transmitter transient behavior. Set the timebase reference to the left for observing the transmitter turn-on transient.
- e) Key the transmitter.
- f) Observe the stored display of the modulation domain analyzer. The signal trace shall be maintained within the allowable limits during the periods t₁ and t₂, and shall also remain within limits following t₂.
- g) Adjust the modulation domain analyzer to trigger on the falling edge of the transmitter waveform in order to capture a single-shot turn-off transient of the transmitter signal.
- h) Adjust the display of the modulation domain analyzer for proper viewing of the transmitter transient behavior. Set the timebase reference to the right for observing the transmitter turn-off transient.
- i) Unkey the transmitter.
- j) Observe the stored display of the modulation domain analyzer. The signal trace shall be maintained within the allowable limits during the period t₃.

EUT Setup Block Diagram

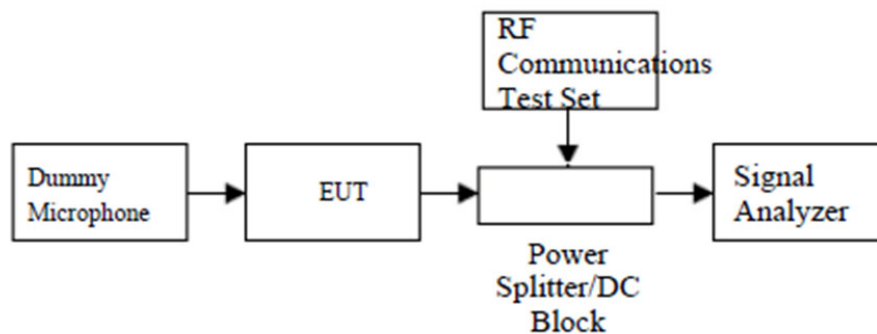

Test Data

Test Mode:	Transmitting	Test Engineer:	Lucas Lin
Test Date:	2024-11-29	Test Result:	Compliant

Environment Conditions:					
Temperature: (°C)	23.7	Relative Humidity: (%)	49	ATM Pressure: (kPa)	100.1

Note: Test only was performed at high power level.

Channel Spacing (kHz)	Transient Period (ms)	Transient Frequency	Result
12.5	10(t1)	±12.5kHz	Pass
	25(t2)	±6.25kHz	
	10(t3)	±12.5kHz	

Note: During the time from the end of t2 to the beginning of t3, the frequency difference must not exceed the limits specified in §90.213:
 For 453.2125 MHz 12.5kHz mode, limit is: $453.2125 \text{ MHz} * 2.5\text{ppm} = 1.13\text{kHz}$

Please refer to the following plots:

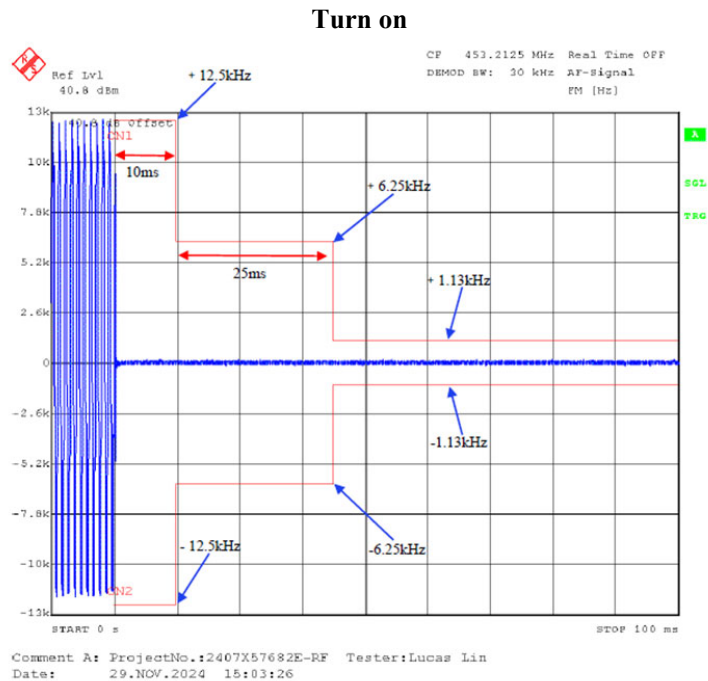

Turn off

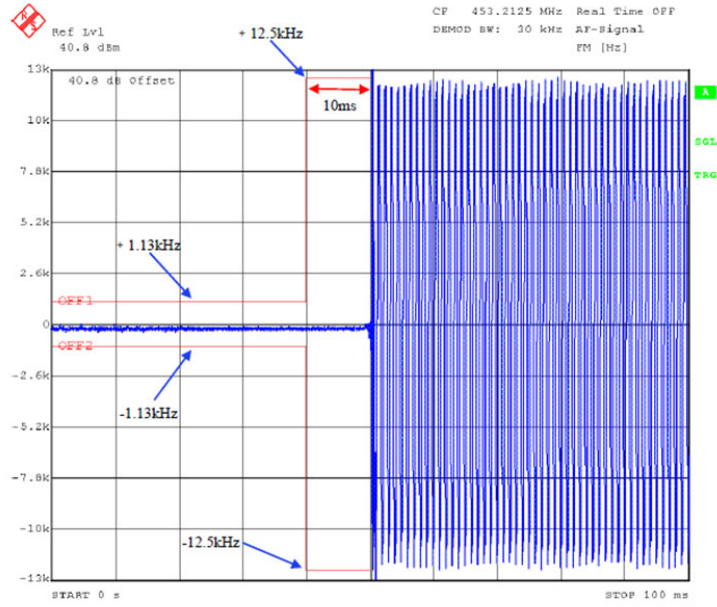

Comment A: ProjectNo.:2407X57682E-RF Tester:Lucas Lin
Date: 29.NOV.2024 15:26:17

EUT PHOTOGRAPHS

Please refer to the attachment 2407X57682E-RF-EXP EUT EXTERNAL PHOTOGRAPHS and 2407X57682E-RF-INP EUT INTERNAL PHOTOGRAPHS.

TEST SETUP PHOTOGRAPHS

Please refer to the attachment 2407X57682E-RF-TSP TEST SETUP PHOTOGRAPHS.

Declarations

1. Bay Area Compliance Laboratories Corp. (Xiamen) is not responsible for authenticity of any information provided by the applicant. Information from the applicant that may affect test results are marked with an asterisk “★”.
2. Unless otherwise stated, the results shown in this test report refer only to the sample(s) tested.
3. Unless required by the rule provided by the applicant or product regulations, then decision rule in this report did not consider the uncertainty.
4. The extended uncertainty given in this report is obtained by combining the standard uncertainty times the coverage factor $k=2$ with the 95% confidence interval.
5. This report cannot be reproduced except in full, without prior written approval of Bay Area Compliance Laboratories Corp. (Xiamen).
6. This report is valid only with a valid digital signature. The digital signature may be available only under the adobe software above version 7.0.

******* END OF REPORT*******