



**In accordance with the requirements of
FCC 47 CFR Part 2(2.1093), ANSI/IEEE C95.1-1992 and
IEEE Std 1528-2013**

FCC SAR EVALUATION REPORT

Product Name : 10.1 inch Full Ruggedized Tablet

Trademark : n/a

Model Name : xTablet T1550

Serial Model : n/a

Report No. : NTEK-2016NT12220835HF

FCC ID : O86T1550

Prepared for

MobileDemand, LC.

1501 Boyson Square Drive Hiawatha, Iowa 52233

Prepared by

NTEK Testing Technology Co., Ltd.

1/F, Building E, Fenda Science Park, Sanwei Community, Xixiang Street,
Bao'an District, Shenzhen 518126 P.R.China.

Tel.: +86-755-61156588 Fax.: +86-755-61156599

Website: <http://www.ntek.org.cn>

TEST RESULT CERTIFICATION

Applicant's name.....: MobileDemand, LC.

Address.....: 1501 Boyson Square Drive Hiawatha, Iowa 52233

Manufacturer's Name.....: Emdoor Information Co.,Ltd

Address.....: 3A 1/F Jinfulai Tower, No.49-1, Dabao Road, Baoan 28 District,
Shenzhen

Product description

Product name.....: 10.1 inch Full Ruggedized Tablet

Trademark.....: n/a

Model and/or type reference : xTablet T1550

Serial Model.....: n/a

FCC 47 CFR Part 2(2.1093)

ANSI/IEEE C95.1-1992

Standards.....: IEEE Std 1528-2013

Published RF exposure KDB procedures

This device described above has been tested by Shenzhen NTEK. In accordance with the measurement methods and procedures specified in IEEE Std 1528-2013 and KDB 865664 D01. Testing has shown that this device is capable of compliance with localized specific absorption rate (SAR) specified in FCC 47 CFR Part 2(2.1093) and ANSI/IEEE C95.1-1992. The test results in this report apply only to the tested sample of the stated device/equipment. Other similar device/equipment will not necessarily produce the same results due to production tolerance and measurement uncertainties.

This report shall not be reproduced except in full, without the written approval of Shenzhen NTEK, this document may be altered or revised by Shenzhen NTEK, personal only, and shall be noted in the revision of the document.

Date of Test

Date (s) of performance of tests.....: Jan. 04, 2017 ~ Jan. 06, 2017

Date of Issue.....: Feb. 24, 2017

Test Result.....: **Pass**

Prepared By
(Test Engineer)

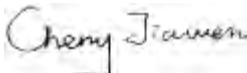
: 

(Cheng Jiawen)

Approved By
(Lab Manager)

: 

(Sam Chen)

※ ※ Revision History ※ ※

REV.	DESCRIPTION	ISSUED DATE	REMARK
Rev.1.0	Initial Test Report Release	Feb. 24, 2017	Cheng Jiawen

TABLE OF CONTENTS

1. General Information	6
1.1. RF exposure limits.....	6
1.2. Statement of Compliance	7
1.3. EUT Description	8
1.4. Test specification(s)	9
1.5. Ambient Condition.....	9
2. SAR Measurement System	10
2.1. SATIMO SAR Measurement Set-up Diagram	10
2.2. Robot	11
2.3. E-Field Probe.....	12
2.3.1. E-Field Probe Calibration	12
2.4. SAM phantoms	13
2.4.1. Technical Data	13
2.5. Device Holder	15
2.6. Test Equipment List	16
3. SAR Measurement Procedures	18
3.1. Power Reference	18
3.2. Area scan & Zoom scan.....	18
3.3. Description of interpolation/extrapolation scheme	20
3.4. Volumetric Scan.....	20
3.5. Power Drift	20
4. System Verification Procedure	21
4.1. Tissue Verification	21
4.1.1. Tissue Dielectric Parameter Check Results	21
4.2. System Verification Procedure	22
4.2.1. System Verification Results	23
5. SAR Measurement variability and uncertainty	24
5.1. SAR measurement variability.....	24
5.2. SAR measurement uncertainty	24
6. RF Exposure Conditions	25
6.1. Tablet host platform exposure conditions.....	25
7. RF Output Power	26
7.1. Maximum Tune-up Limit.....	26
7.2. Wi-Fi Output Power	26
7.3. BT Output Power.....	27
8. Antenna Location.....	28
9. SAR Measurement Results.....	31
10. SAR Measurement Results.....	32
10.1. SAR measurement results.....	32
10.1.1. SAR measurement Result of Wi-Fi.....	33

10.1.2. SAR measurement Result of Wi-Fi.....	34
11. Appendix A. Photo documentation	35
12. Appendix B. System Check Plots.....	40
13. Appendix C. Plots of High SAR Measurement.....	44
14. Appendix D. Calibration Certificate	48

1. General Information

1.1. RF exposure limits

(A).Limits for Occupational/Controlled Exposure (W/kg)

Whole-Body	Partial-Body	Hands, Wrists, Feet and Ankles
0.4	8.0	20.0

(B).Limits for General Population/Uncontrolled Exposure (W/kg)

Whole-Body	Partial-Body	Hands, Wrists, Feet and Ankles
0.08	1.6	4.0

NOTE: **Whole-Body SAR** is averaged over the entire body, **partial-body SAR** is averaged over any 1 gram of tissue defined as a tissue volume in the shape of a cube. **SAR for hands, wrists, feet and ankles** is averaged over any 10 grams of tissue defined as a tissue volume in the shape of a cube.

Occupational/Controlled Environments:

Are defined as locations where there is exposure that may be incurred by people who are aware of the potential for exposure, (i.e. as a result of employment or occupation).

General Population/Uncontrolled Environments:

Are defined as locations where there is the exposure of individuals who have no knowledge or control of their exposure.

NOTE
 HEAD AND TRUNK LIMIT
 1.6 W/kg
 APPLIED TO THIS EUT

1.2. Statement of Compliance

The maximum results of Specific Absorption Rate (SAR) found during testing for xTablet T1550 are as follows.

Band	Max. Reported SAR (W/kg)
	1-g Body (Separation distance of 0mm)
Wi-Fi 2.4G	0.785
Wi-Fi 5.2G	0.765
Wi-Fi 5.8G	0.627

This device is in compliance with Specific Absorption Rate (SAR) for general population/uncontrolled exposure limits (1.6 W/kg) specified in FCC 47 CFR Part 2(2.1093) and ANSI/IEEE C95.1-1992, and had been tested in accordance with the measurement methods and procedures specified in IEEE Std 1528-2013 & KDB 865664 D01.

1.3. EUT Description

Device Information			
Product Name	10.1 inch Full Ruggedized Tablet		
Trademark	n/a		
Model Name	xTablet T1550		
Serial Model	n/a		
FCC ID	O86T1550		
Device Phase	Identical Prototype		
Exposure Category	General population / Uncontrolled environment		
Antenna Type	FPCB Antenna		
Battery Information	DC 3.7V, 10000mAh		
Device Operating Configurations			
Supporting Mode(s)	Wi-Fi 2.4G/5G, BT		
Test Modulation	Wi-Fi(DSSS/OFDM)		
Operating Frequency Range(s)	Band	Tx (MHz)	Rx (MHz)
	Wi-Fi 2.4G	2412-2462	
	Wi-Fi 5.2G	5180-5240	
	Wi-Fi 5.8G	5745-5825	
	BT	2402-2480	
Test Channels (low-mid-high)	1-6-11(Wi-Fi 2.4G) 36-40-48(Wi-Fi 5.2G) 149-157-165(Wi-Fi 5.8G)		

1.4. Test specification(s)

FCC 47 CFR Part 2(2.1093)
ANSI/IEEE C95.1-1992
IEEE Std 1528-2013
KDB 865664 D01 SAR measurement 100 MHz to 6 GHz
KDB 865664 D02 RF Exposure Reporting
KDB 447498 D01 General RF Exposure Guidance
KDB 248227 D01 802.11 Wi-Fi SAR
KDB 616217 D04 SAR for laptop and tablets

1.5. Ambient Condition

Ambient temperature	20°C – 24°C
Relative Humidity	30% – 70%

2. SAR Measurement System

2.1. SATIMO SAR Measurement Set-up Diagram

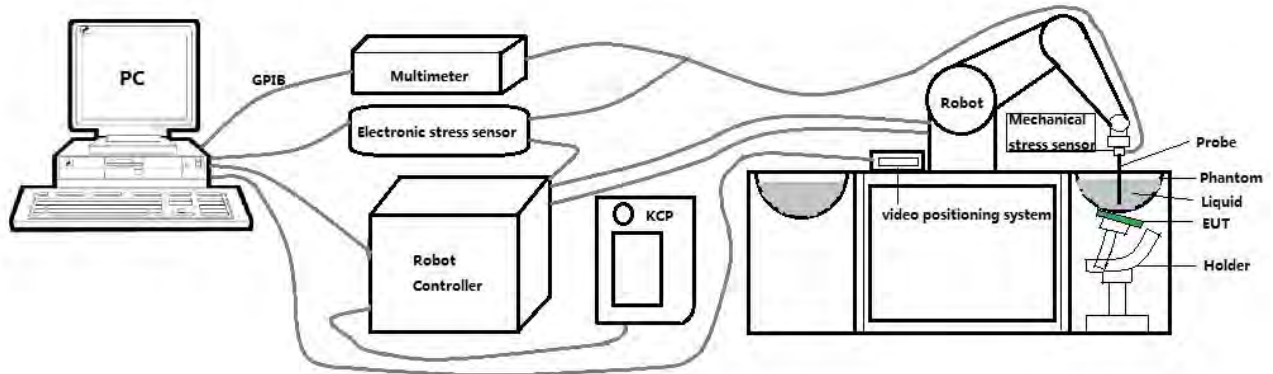

These measurements were performed with the automated near-field scanning system OPENSAR from SATIMO. The system is based on a high precision robot (working range: 901 mm), which positions the probes with a positional repeatability of better than ± 0.03 mm. The SAR measurements were conducted with dosimetric probe (manufactured by SATIMO), designed in the classical triangular configuration and optimized for dosimetric evaluation.

The first step of the field measurement is the evaluation of the voltages induced on the probe by the device under test. Probe diode detectors are nonlinear. Below the diode compression point, the output voltage is proportional to the square of the applied E-field; above the diode compression point, it is linear to the applied E-field. The compression point depends on the diode, and a calibration procedure is necessary for each sensor of the probe.

The Keithley multimeter reads the voltage of each sensor and send these three values to the PC. The corresponding E field value is calculated using the probe calibration factors, which are stored in the working directory. This evaluation includes linearization of the diode characteristics. The field calculation is done separately for each sensor. Each component of the E field is displayed on the "Dipole Area Scan Interface" and the total E field is displayed on the "3D Interface"

2.2. Robot

The SATIMO SAR system uses the high precision robots from KUKA. For the 6-axis controller system, the robot controller version (KUKA) from KUKA is used. The KUKA robot series have many features that are important for our application:



- High precision (repeatability ± 0.03 mm)
- High reliability (industrial design)
- Jerk-free straight movements
- Low ELF interference (the closed metallic construction shields against motor control fields)

2.3. E-Field Probe

This E-field detection probe is composed of three orthogonal dipoles linked to special Schottky diodes with low detection thresholds. The probe allows the measurement of electric fields in liquids such as the one defined in the IEEE and CENELEC standards.

For the measurements the Specific Dosimetric E-Field Probe SN 08/16 EPGO287 with following specifications is used



- Dynamic range: 0.01-100 W/kg
 - Tip Diameter : 2.5 mm
 - Distance between probe tip and sensor center: 1 mm
 - Distance between sensor center and the inner phantom surface: 4 mm (repeatability better than ± 1 mm).
 - Probe linearity: ± 0.08 dB
 - Axial isotropy: < 0.25 dB
 - Hemispherical Isotropy: < 0.50 dB
 - Calibration range: 450MHz to 6000MHz for head & body simulating liquid.
 - Lower detection limit: 8mW/kg
- Angle between probe axis (evaluation axis) and surface normal line: less than 30° .

2.3.1. E-Field Probe Calibration

Each probe needs to be calibrated according to a dosimetric assessment procedure with accuracy better than $\pm 10\%$. The spherical isotropy shall be evaluated and within ± 0.25 dB. The sensitivity parameters (Norm X, Norm Y, and Norm Z), the diode compression parameter (DCP) and the conversion factor (Conv F) of the probe are tested. The calibration data can be referred to appendix D of this report.

2.4. SAM phantoms

Photo of SAM phantom SN 16/15 SAM119



The SAM phantom is used to measure the SAR relative to people exposed to electro-magnetic field radiated by mobile phones.

2.4.1. Technical Data

Serial Number	Shell thickness	Filling volume	Dimensions	Positionner Material	Permittivity	Loss Tangent
SN 16/15 SAM119	2 mm \pm 0.2 mm	27 liters	Length:1000 mm Width:500 mm Height:200 mm	Gelcoat with fiberglass	3.4	0.02

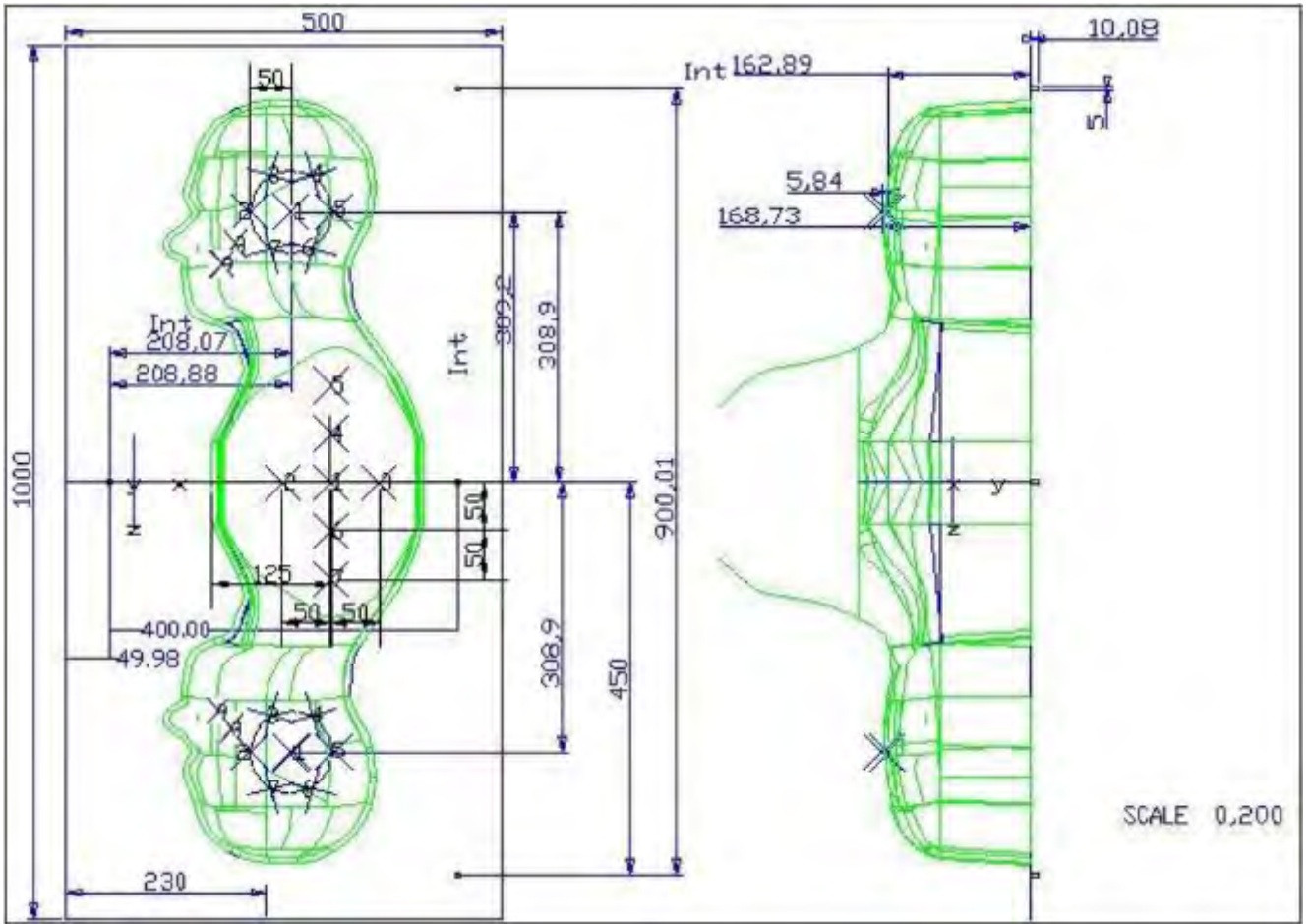

Serial Number	Left Head		Right Head		Flat Part	
SN 16/15 SAM119	2	2.02	2	2.08	1	2.09
	3	2.05	3	2.06	2	2.06
	4	2.07	4	2.07	3	2.08
	5	2.08	5	2.08	4	2.10
	6	2.05	6	2.07	5	2.10
	7	2.05	7	2.05	6	2.07
	8	2.07	8	2.06	7	2.07
	9	2.08	9	2.06	-	-

The test, based on ultrasonic system, allows measuring the thickness with an accuracy of 10 µm.

2.5. Device Holder

The positioning system allows obtaining cheek and tilting position with a very good accuracy. In compliance with CENELEC, the tilt angle uncertainty is lower than 1 degree.

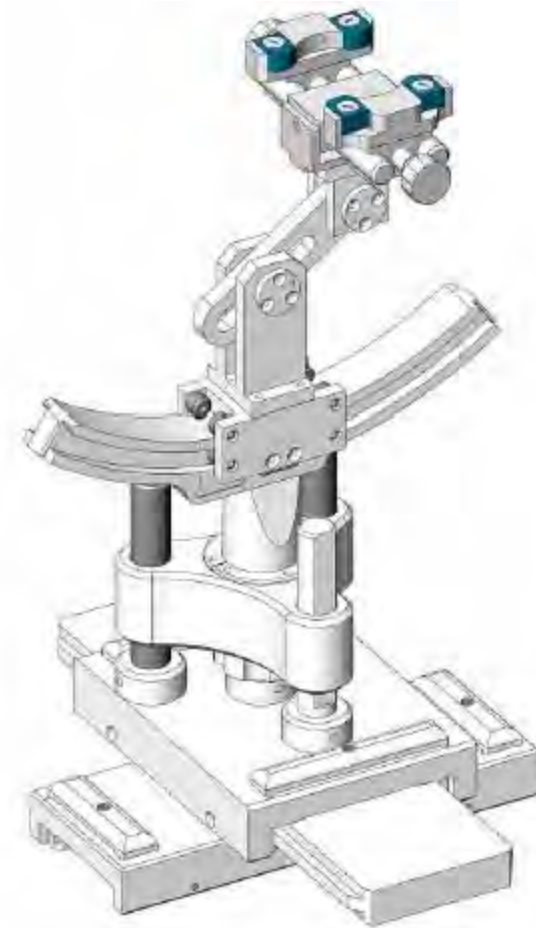

Serial Number	Holder Material	Permittivity	Loss Tangent
SN 16/15 MSH100	Delrin	3.7	0.005

2.6. Test Equipment List

This table gives a complete overview of the SAR measurement equipment.

Devices used during the test described are marked

	Manufacturer	Name of Equipment	Type/Model	Serial Number	Calibration	
					Last Cal.	Due Date
<input checked="" type="checkbox"/>	MVG	E FIELD PROBE	SSE2	SN 08/16 EPGO287	Sep. 08, 2016	Sep. 07, 2017
<input type="checkbox"/>	MVG	450 MHz Dipole	SID450	SN 03/15 DIP 0G450-345	Apr. 06, 2015	Apr. 05, 2018
<input type="checkbox"/>	MVG	750 MHz Dipole	SID750	SN 03/15 DIP 0G750-355	Apr. 06, 2015	Apr. 05, 2018
<input type="checkbox"/>	MVG	835 MHz Dipole	SID835	SN 03/15 DIP 0G835-347	Apr. 06, 2015	Apr. 05, 2018
<input type="checkbox"/>	MVG	900 MHz Dipole	SID900	SN 03/15 DIP 0G900-348	Apr. 06, 2015	Apr. 05, 2018
<input type="checkbox"/>	MVG	1800 MHz Dipole	SID1800	SN 03/15 DIP 1G800-349	Apr. 06, 2015	Apr. 05, 2018
<input type="checkbox"/>	MVG	1900 MHz Dipole	SID1900	SN 03/15 DIP 1G900-350	Apr. 06, 2015	Apr. 05, 2018
<input type="checkbox"/>	MVG	2000 MHz Dipole	SID2000	SN 03/15 DIP 2G000-351	Apr. 06, 2015	Apr. 05, 2018
<input checked="" type="checkbox"/>	MVG	2450 MHz Dipole	SID2450	SN 03/15 DIP 2G450-352	Apr. 06, 2015	Apr. 05, 2018
<input type="checkbox"/>	MVG	2600 MHz Dipole	SID2600	SN 03/15 DIP 2G600-356	Apr. 06, 2015	Apr. 05, 2018
<input checked="" type="checkbox"/>	MVG	5000 MHz Dipole	SWG5500	SN 13/14 WGA 33	Apr. 06, 2015	Apr. 05, 2018
<input checked="" type="checkbox"/>	MVG	Liquid measurement Kit	SCLMP	SN 21/15 OCPG 72	NCR	NCR
<input checked="" type="checkbox"/>	MVG	Power Amplifier	N.A	AMPLISAR_28/14_003	NCR	NCR
<input checked="" type="checkbox"/>	KEITHLEY	Millivoltmeter	2000	4072790	NCR	NCR
<input type="checkbox"/>	R&S	Universal radio communication tester	CMU200	117858	Aug. 09, 2016	Aug. 08, 2017
<input type="checkbox"/>	R&S	Wideband radio communication tester	CMW500	148500	Jun. 26, 2016	Jun. 25, 2017
<input checked="" type="checkbox"/>	HP	Network Analyzer	8753D	3410J01136	Aug. 09, 2016	Aug. 08, 2017

<input checked="" type="checkbox"/>	Agilent	PSG Analog Signal Generator	E8257D	MY51110112	Aug. 09, 2016	Aug. 08, 2017
<input checked="" type="checkbox"/>	Agilent	Power meter	E4419B	MY45102538	Aug. 09, 2016	Aug. 08, 2017
<input checked="" type="checkbox"/>	Agilent	Power sensor	E9301A	MY41495644	Aug. 09, 2016	Aug. 08, 2017
<input checked="" type="checkbox"/>	Agilent	Power sensor	E9301A	US39212148	Aug. 09, 2016	Aug. 08, 2017
<input checked="" type="checkbox"/>	MCLI/USA	Directional Coupler	CB11-20	0D2L51502	Aug. 09, 2016	Aug. 08, 2017

3. SAR Measurement Procedures

The measurement procedures are as follows:

<Conducted power measurement>

- (a) For WWAN power measurement, use base station simulator to configure EUT WWAN transmission in conducted connection with RF cable, at maximum power in each supported wireless interface and frequency band.
- (b) Read the WWAN RF power level from the base station simulator.
- (c) For Wi-Fi/BT power measurement, use engineering software to configure EUT Wi-Fi/BT continuously transmission, at maximum RF power in each supported wireless interface and frequency band.
- (d) Connect EUT RF port through RF cable to the power meter, and measure Wi-Fi/BT output power.

<SAR measurement>

- (a) Use base station simulator to configure EUT WWAN transmission in radiated connection, and engineering software to configure EUT Wi-Fi/BT continuously transmission, at maximum RF power, in the highest power channel.
- (b) Place the EUT in the positions as Appendix A demonstrates.
- (c) Set scan area, grid size and other setting on the OPENSAR software.
- (d) Measure SAR results for the highest power channel on each testing position.
- (e) Find out the largest SAR result on these testing positions of each band.
- (f) Measure SAR results for other channels in worst SAR testing position if the reported SAR of highest power channel is larger than 0.8 W/kg.

According to the test standard, the recommended procedure for assessing the peak spatial-average SAR value consists of the following steps:

- (a) Power reference measurement
- (b) Area scan
- (c) Zoom scan
- (d) Power drift measurement

3.1. Power Reference

The Power Reference Measurement and Power Drift Measurements are for monitoring the power drift of the device under test in the batch process. The minimum distance of probe sensors to surface determines the closest measurement point to phantom surface. This distance cannot be smaller than the distance of sensor calibration points to probe tip as defined in the probe properties.

3.2. Area scan & Zoom scan

The area scan is a 2D scan to find the hot spot location on the DUT. The zoom scan is a 3D scan above the hot spot to calculate the 1g and 10g SAR value.

Measurement of the SAR distribution with a grid of 8 to 16 mm * 8 to 16 mm and a constant distance to

the inner surface of the phantom. Since the sensors cannot directly measure at the inner phantom surface, the values between the sensors and the inner phantom surface are extrapolated. With these values the area of the maximum SAR is calculated by an interpolation scheme. Around this point, a cube of 30 * 30 * 30 mm or 32 * 32 * 32 mm is assessed by measuring 5 or 8 * 5 or 8 * 4 or 5 mm. With these data, the peak spatial-average SAR value can be calculated.

From the scanned SAR distribution, identify the position of the maximum SAR value, in addition identify the positions of any local maxima with SAR values within 2 dB of the maximum value that will not be within the zoom scan of other peaks; additional peaks shall be measured only when the primary peak is within 2 dB of the SAR compliance limit (e.g., 1 W/kg for 1,6 W/kg 1 g limit, or 1,26 W/kg for 2 W/kg, 10 g limit).

Area scan & Zoom scan scan parameters extracted from FCC KDB 865664 D01 SAR measurement 100 MHz to 6 GHz.

		≤ 3 GHz	> 3 GHz
Maximum distance from closest measurement point (geometric center of probe sensors) to phantom surface		5 ± 1 mm	½·δ·ln(2) ± 0.5 mm
Maximum probe angle from probe axis to phantom surface normal at the measurement location		30° ± 1°	20° ± 1°
Maximum area scan spatial resolution: Δx _{Area} , Δy _{Area}		≤ 2 GHz: ≤ 15 mm 2 – 3 GHz: ≤ 12 mm	3 – 4 GHz: ≤ 12 mm 4 – 6 GHz: ≤ 10 mm
		When the x or y dimension of the test device, in the measurement plane orientation, is smaller than the above, the measurement resolution must be ≤ the corresponding x or y dimension of the test device with at least one measurement point on the test device.	
Maximum zoom scan spatial resolution: Δx _{Zoom} , Δy _{Zoom}		≤ 2 GHz: ≤ 8 mm 2 – 3 GHz: ≤ 5 mm*	3 – 4 GHz: ≤ 5 mm* 4 – 6 GHz: ≤ 4 mm*
Maximum zoom scan spatial resolution, normal to phantom surface	uniform grid: Δz _{Zoom} (n)	≤ 5 mm	3 – 4 GHz: ≤ 4 mm 4 – 5 GHz: ≤ 3 mm 5 – 6 GHz: ≤ 2 mm
	graded grid	Δz _{Zoom} (1): between 1 st two points closest to phantom surface	≤ 4 mm 3 – 4 GHz: ≤ 3 mm 4 – 5 GHz: ≤ 2.5 mm 5 – 6 GHz: ≤ 2 mm
		Δz _{Zoom} (n>1): between subsequent points	≤ 1.5·Δz _{Zoom} (n-1)
Minimum zoom scan volume	x, y, z	≥ 30 mm	3 – 4 GHz: ≥ 28 mm 4 – 5 GHz: ≥ 25 mm 5 – 6 GHz: ≥ 22 mm

Note: δ is the penetration depth of a plane-wave at normal incidence to the tissue medium; see draft standard IEEE P1528-2011 for details.

* When zoom scan is required and the *reported* SAR from the *area scan based 1-g SAR estimation* procedures of KDB 447498 is ≤ 1.4 W/kg, ≤ 8 mm, ≤ 7 mm and ≤ 5 mm zoom scan resolution may be applied, respectively, for 2 GHz to 3 GHz, 3 GHz to 4 GHz and 4 GHz to 6 GHz.

3.3. Description of interpolation/extrapolation scheme

The local SAR inside the phantom is measured using small dipole sensing elements inside a probe body. The probe tip must not be in contact with the phantom surface in order to minimise measurements errors, but the highest local SAR will occur at the surface of the phantom.

An extrapolation is used to determine this highest local SAR value. The extrapolation is based on a fourth-order least-square polynomial fit of measured data. The local SAR value is then extrapolated from the liquid surface with a 1 mm step.

The measurements have to be performed over a limited time (due to the duration of the battery) so the step of measurement is high. It could vary between 5 and 8 mm. To obtain an accurate assessment of the maximum SAR averaged over 10 grams and 1 gram requires a very fine resolution in the three dimensional scanned data array.

3.4. Volumetric Scan

The volumetric scan consists to a full 3D scan over a specific area. This 3D scan is useful for multi Tx SAR measurement. Indeed, it is possible with OpenSAR to add, point by point, several volumetric scans to calculate the SAR value of the combined measurement as it is defined in the standard IEEE1528 and IEC62209.

3.5. Power Drift

All SAR testing is under the EUT install full charged battery and transmit maximum output power. In OpenSAR measurement software, the power reference measurement and power drift measurement procedures are used for monitoring the power drift of EUT during SAR test. Both these procedures measure the field at a specified reference position before and after the SAR testing. The software will calculate the field difference in V/m. If the power drifts more than $\pm 5\%$, the SAR will be retested.

4. System Verification Procedure

4.1. Tissue Verification

The following tissue formulations are provided for reference only as some of the parameters have not been thoroughly verified. The composition of ingredients may be modified accordingly to achieve the desired target tissue parameters required for routine SAR evaluation.

Ingredients (% of weight)	Head Tissue									
	750	835	900	1800	1900	2000	2450	2600	5200	5800
Frequency Band (MHz)										
Water	34.40	34.40	34.40	55.36	55.36	57.87	57.87	57.87	65.53	65.53
NaCl	0.79	0.79	0.79	0.35	0.35	0.16	0.16	0.16	0.00	0.00
1,2-Propanediol	64.81	64.81	64.81	0.00	0.00	0.00	0.00	0.00	0.00	0.00
Triton X-100	0.00	0.00	0.00	30.45	30.45	19.97	19.97	19.97	24.24	24.24
DGBE	0.00	0.00	0.00	13.84	13.84	22.00	22.00	22.00	10.23	10.23
Ingredients (% of weight)	Body Tissue									
	750	835	900	1800	1900	2000	2450	2600	5200	5800
Frequency Band (MHz)										
Water	50.30	50.30	50.30	69.91	69.91	71.88	71.88	71.88	79.54	79.54
NaCl	0.60	0.60	0.60	0.13	0.13	0.16	0.16	0.16	0.00	0.00
1,2-Propanediol	49.10	49.10	49.10	0.00	0.00	0.00	0.00	0.00	0.00	0.00
Triton X-100	0.00	0.00	0.00	9.99	9.99	19.97	19.97	19.97	11.24	11.24
DGBE	0.00	0.00	0.00	19.97	19.97	7.99	7.99	7.99	9.22	9.22

4.1.1. Tissue Dielectric Parameter Check Results

The simulating liquids should be checked at the beginning of a series of SAR measurements to determine if the dielectric parameters are within the tolerances of the specified target values. The measured conductivity and relative permittivity should be within $\pm 5\%$ of the target values.

Tissue Type	Measured Frequency (MHz)	Target Tissue		Measured Tissue		Liquid Temp.	Test Date
		ϵ_r ($\pm 5\%$)	σ (S/m) ($\pm 5\%$)	ϵ_r	σ (S/m)		
Body 2450	2450	52.70 (50.07~55.33)	1.95 (1.85~2.04)	51.53	1.92	21.4 °C	Jan. 04, 2017
Body 5000	5200	49.00 (44.10~53.90)	5.30 (4.77~5.83)	49.92	5.30	21.3 °C	Jan. 05, 2017
Body 5000	5800	48.20 (43.38~53.02)	6.00 (5.40~6.60)	49.05	6.00	21.3 °C	Jan. 06, 2017

NOTE: The dielectric parameters of the tissue-equivalent liquid should be measured under similar ambient conditions and within 2 °C of the conditions expected during the SAR evaluation to satisfy

protocol requirements.

4.2. System Verification Procedure

The system verification is performed for verifying the accuracy of the complete measurement system and performance of the software. The dipole is connected to the signal source consisting of signal generator and amplifier via a directional coupler, N-connector cable and adaption to SMA. It is fed with a power of 100mW (below 5GHz) or 100mW (above 5GHz). To adjust this power a power meter is used. The power sensor is connected to the cable before the system verification to measure the power at this point and do adjustments at the signal generator. At the outputs of the directional coupler both return loss as well as forward power are controlled during the system verification to make sure that emitted power at the dipole is kept constant. This can also be checked by the power drift measurement after the test (result on plot).

The system verification is shown as below picture:

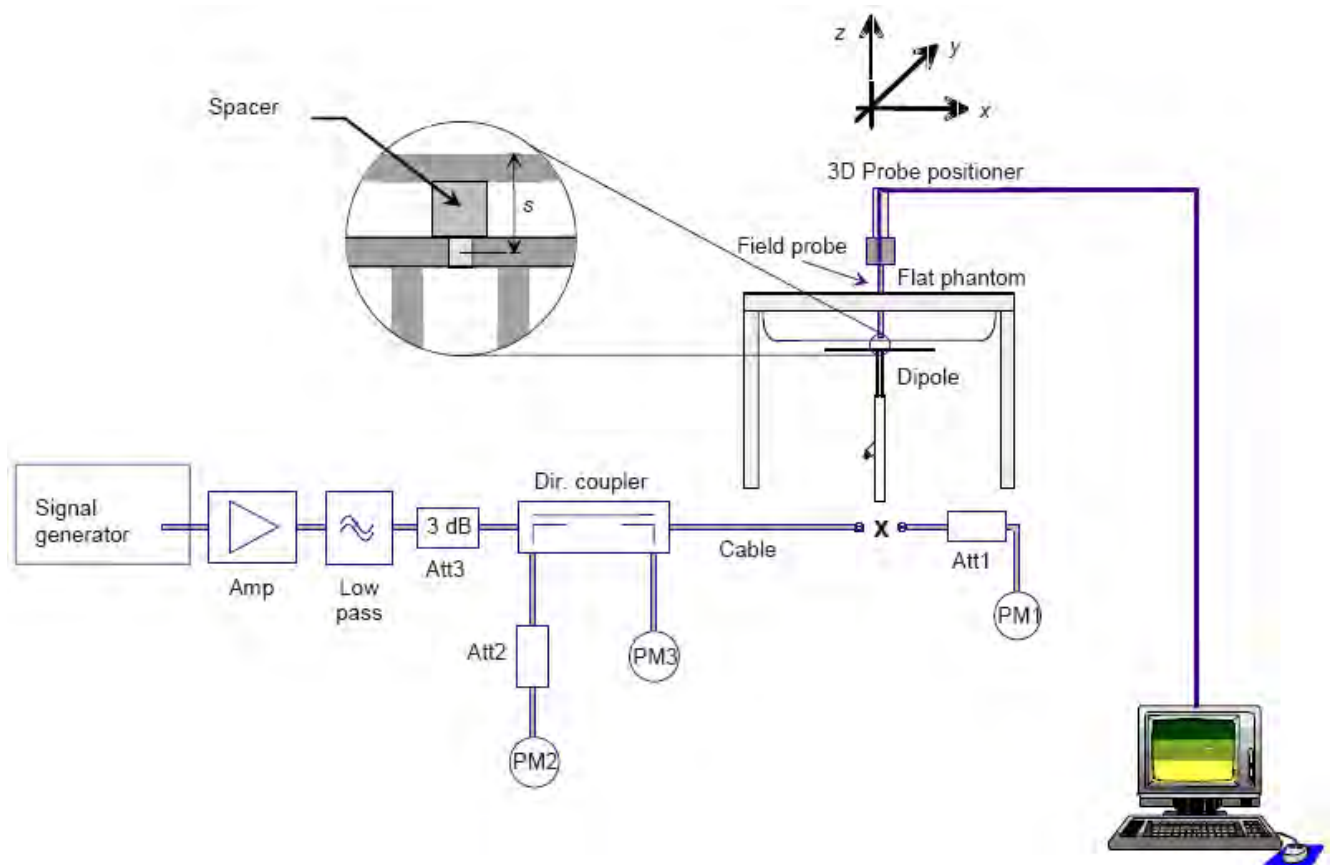

4.2.1. System Verification Results

Comparing to the original SAR value provided by SATIMO, the verification data should be within its specification of $\pm 10\%$. Below table shows the target SAR and measured SAR after normalized to 1W input power. The table below indicates the system performance verification can meet the variation criterion and the plots can be referred to Appendix B of this report.

System Verification	Target SAR (1W) ($\pm 10\%$)		Measured SAR (Normalized to 1W)		Liquid Temp.	Test Date
	1-g (W/Kg)	10-g (W/Kg)	1-g (W/Kg)	10-g (W/Kg)		
2450MHz Body	49.32 (44.39~54.25)	22.89 (20.60~25.17)	46.18	21.83	21.4 °C	Jan. 04, 2017
5200MHz Body	150.06 (135.05~165.07)	53.20 (47.88~58.52)	157.84	54.84	21.3 °C	Jan. 05, 2017
5800MHz Body	173.64 (156.28~191.00)	59.29 (53.36~65.22)	179.95	61.63	21.3 °C	Jan. 06, 2017

5. SAR Measurement variability and uncertainty

5.1. SAR measurement variability

Per KDB865664 D01 SAR measurement 100 MHz to 6 GHz, SAR measurement variability must be assessed for each frequency band, which is determined by the SAR probe calibration point and tissue-equivalent medium used for the device measurements. The additional measurements are repeated after the completion of all measurements requiring the same head or body tissue-equivalent medium in a frequency band. The test device should be returned to ambient conditions (normal room temperature) with the battery fully charged before it is re-mounted on the device holder for the repeated measurement(s) to minimize any unexpected variations in the repeated results.

- 1) Repeated measurement is not required when the original highest measured SAR is < 0.80 W/kg; steps 2) through 4) do not apply.
- 2) When the original highest measured SAR is ≥ 0.80 W/kg, repeat that measurement once.
- 3) Perform a second repeated measurement only if the ratio of largest to smallest SAR for the original and first repeated measurements is > 1.20 or when the original or repeated measurement is ≥ 1.45 W/kg (~ 10% from the 1-g SAR limit).
- 4) Perform a third repeated measurement only if the original, first or second repeated measurement is ≥ 1.5 W/kg and the ratio of largest to smallest SAR for the original, first and second repeated measurements is > 1.20 .

5.2. SAR measurement uncertainty

Per KDB865664 D01 SAR Measurement 100 MHz to 6 GHz, when the highest measured 1-g SAR within a frequency band is < 1.5 W/kg, the extensive SAR measurement uncertainty analysis described in IEEE Std 1528-2013 is not required in SAR reports submitted for equipment approval. The equivalent ratio (1.5/1.6) is applied to extremity and occupational exposure conditions.

6. RF Exposure Conditions

6.1. Tablet host platform exposure conditions

Per KDB616217 D04, When the modular approach is used, transmitters and modules must be initially tested for standalone operations in generic host conditions according to the following minimum test separation distance and antenna installation requirements for incorporation in the tablet platform. The separation distance required for incorporation in qualified hosts is described in KDB 447498; item 5) of section 4.1 and item 1) of section 5.2.2 etc.

- ≤ 5 mm between the antenna and user for both back surface and edge exposure conditions
- the antennas used by the host must have been tested for equipment approval or qualify for SAR test exclusion
- the antenna polarization, physical orientation, rotation and installation configurations used by the host must have been tested for compliance or qualify for test exclusion
- when the *SAR Test Exclusion Threshold* in KDB 447498 applies, a *test separation distance* of 5 mm is required to determine test exclusion for the tablet platform

The antennas embedded in tablets are typically ≤ 5 mm from the outer housing. The required antenna to user test separation distance is a “not to exceed test” distance required to apply the modular approach. Instead of the typical zero gap tablet edge test requirement between the edge of a tablet and the user, when an antenna has been tested at ≤ 5 mm according to the modular approach it can be incorporated into tablets with at least twice the tested distance from the outer housing of the tablet edge; otherwise, the tablet edge zero gap test requirement applies. When the dedicated host approach is applied, the back surface and edges of the tablet should be tested for SAR compliance with the tablet touching the phantom.

7. RF Output Power

7.1. Maximum Tune-up Limit

Band	Mode	The Tune-up Maximum Power (Customer Declared)(dBm)	Range	Measured Output Maximum Power(dBm)	
Wi-Fi 2.4G	802.11b	11±1	10~12	11.40	
	802.11g	10±1	9~11	10.70	
	802.11n-HT20	10±1	9~11	10.10	
Wi-Fi 5.2G	802.11a	16.5±1	15.5~17.5	17.00	
	802.11n (20M)	13.5±1	12.5~14.5	13.90	
	802.11n (40M)	13.5±1	12.5~14.5	14.30	
	802.11ac (20M)	12.5±1	11.5~13.5	13.00	
	802.11ac (40M)	11.5±1	10.5~12.5	11.60	
Wi-Fi 5.8G	802.11a	13±1	12~14	13.50	
	802.11n (20M)	9±1	8~10	9.50	
	802.11n (40M)	9±1	8~10	9.80	
	802.11ac (20M)	9±1	8~10	9.40	
	802.11ac (40M)	7±1	6~8	7.00	
BT	3.0	1M	0±1	-1~1	0.77
		2M	-3.5±1	-4.5~-2.5	-3.01
		3M	-3±1	-4~-2	-2.48
	4.0	-1±1	-2~0	-0.23	

7.2. Wi-Fi Output Power

Mode	Channel	Frequency (MHz)	Tune-up	Output Power (dBm)
802.11b	1	2412	12.00	11.40
	6	2437	12.00	11.30
	11	2462	12.00	11.20
802.11g	1	2412	11.00	10.70
	6	2437	11.00	10.30
	11	2462	11.00	10.30
802.11n (HT20)	1	2412	11.00	10.10
	6	2437	11.00	10.00
	11	2462	11.00	9.90
802.11a	36	5180	17.50	17.00
	40	5200	17.50	16.90
	48	5240	17.50	16.80

802.11n (20M)	36	5180	14.50	13.90
	40	5200	14.50	13.90
	48	5240	14.50	13.70
802.11n (40M)	38	5190	14.50	14.10
	46	5230	14.50	14.30
802.11ac (20M)	36	5180	13.50	12.90
	40	5200	13.50	13.00
	48	5240	13.50	13.00
802.11ac (40M)	38	5190	12.50	11.60
	46	5230	12.50	11.40
802.11a	149	5745	14.00	13.50
	157	5785	14.00	13.00
	165	5825	14.00	12.50
802.11n (20M)	149	5745	10.00	9.50
	157	5785	10.00	9.40
	165	5825	10.00	9.00
802.11n (40M)	151	5755	10.00	9.80
	159	5795	10.00	9.40
802.11ac (20M)	149	5745	10.00	9.40
	157	5785	10.00	9.00
	165	5825	10.00	8.80
802.11ac (40M)	151	5755	8.00	7.00
	159	5795	8.00	6.70

7.3. BT Output Power

The output power of BT is as following:

BT	Output Power (dBm)			
	Tune-up	0CH	39CH	78CH
1M	1.00	0.49	-0.88	0.77
2M	-2.50	-3.01	-3.84	-4.17
3M	-2.00	-2.48	-3.31	-3.61

BT(4.0)	Channel	Tune-up	Output Power (dBm)
	0CH	0.00	-0.23
	19CH	0.00	-1.41
	39CH	0.00	-1.36

8. Antenna Location

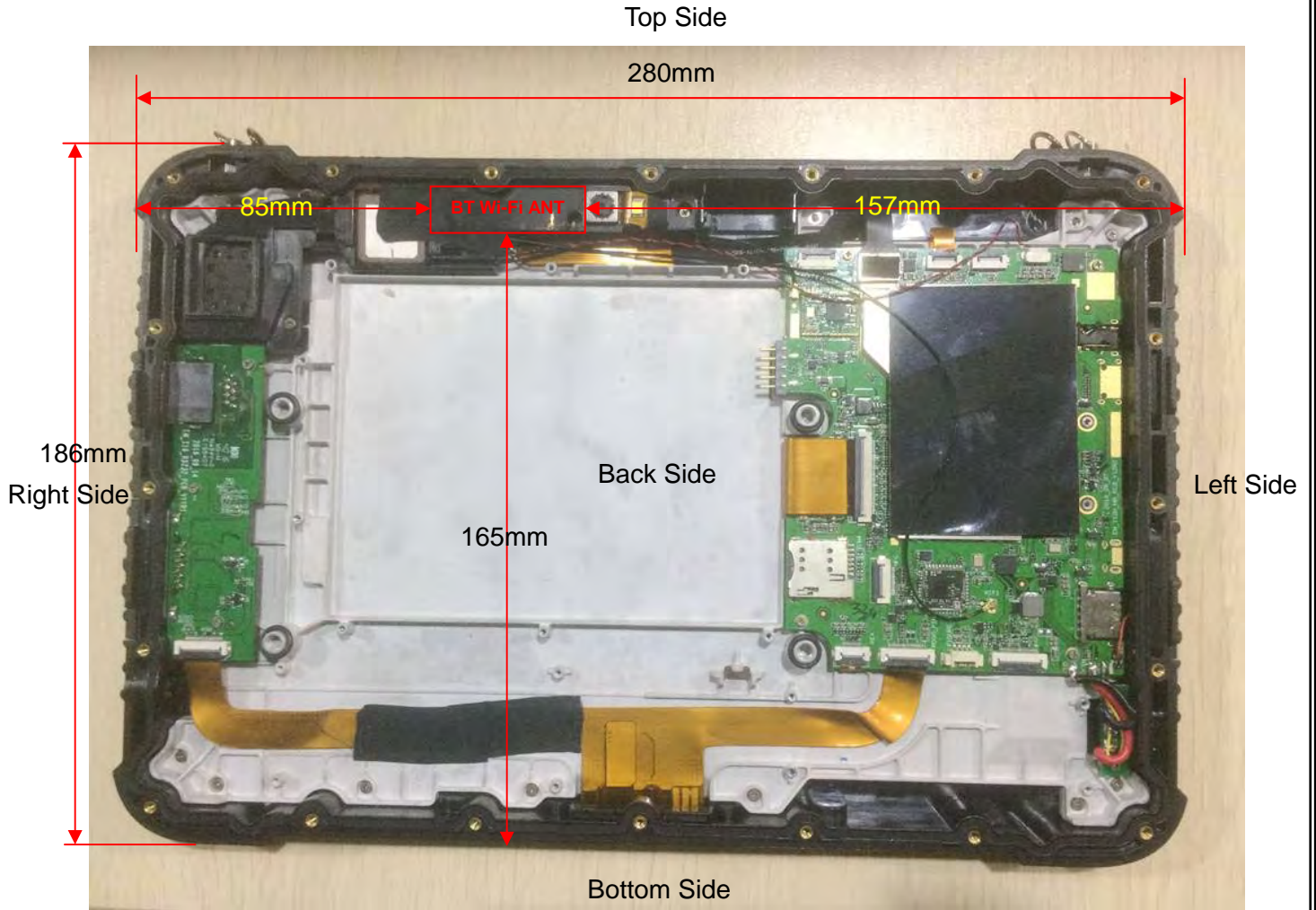

Distance of the Antenna to the EUT surface/edge						
Antennas	Front Side	Back Side	Left Side	Right Side	Top Side	Bottom Side
WLAN & BT	20mm	8mm	157mm	85mm	10mm	165mm

Positions for SAR tests		
Test separation distances \leq 50 mm		
Exposure Positions	Tune-up Maximum power of 802.11b	
	12dBm	
Front Side	Antenna to user(mm)	20
	SAR exclusion threshold	1.283
	SAR testing required?	NO
Back Side	Antenna to user(mm)	8
	SAR exclusion threshold	3.207
	SAR testing required?	YES
Top Side	Antenna to user(mm)	10
	SAR exclusion threshold	2.565
	SAR testing required?	NO
Exposure Positions	Tune-up Maximum power of 802.11a(5.2G)	
	17.5dBm	
Front Side	Antenna to user(mm)	20
	SAR exclusion threshold	6.436
	SAR testing required?	YES
Back Side	Antenna to user(mm)	8
	SAR exclusion threshold	16.091
	SAR testing required?	YES
Top Side	Antenna to user(mm)	10
	SAR exclusion threshold	12.873
	SAR testing required?	YES
Exposure Positions	Tune-up Maximum power of 802.11a(5.8G)	
	14dBm	
Front Side	Antenna to user(mm)	20
	SAR exclusion threshold	3.031
	SAR testing required?	YES
Back Side	Antenna to user(mm)	8
	SAR exclusion threshold	7.578
	SAR testing required?	YES
Top Side	Antenna to user(mm)	10
	SAR exclusion threshold	6.062
	SAR testing required?	YES

NOTE: Refer to section 4.3.1 of KDB 447498 D01.

Positions for SAR tests		
Test separation distances > 50 mm		
Exposure Positions	Tune-up Maximum power of 802.11b	
	12dBm	15.85mW
Left Side	Antenna to user(mm)	157
	SAR exclusion threshold(mW)	1166
	SAR testing required?	NO
Right Side	Antenna to user(mm)	85
	SAR exclusion threshold(mW)	446
	SAR testing required?	NO
Bottom Side	Antenna to user(mm)	165
	SAR exclusion threshold(mW)	1246
	SAR testing required?	NO
Exposure Positions	Tune-up Maximum power of 802.11a(5.2G)	
	17.5dBm	56.23mW
Left Side	Antenna to user(mm)	157
	SAR exclusion threshold(mW)	1136
	SAR testing required?	NO
Right Side	Antenna to user(mm)	85
	SAR exclusion threshold(mW)	416
	SAR testing required?	NO
Bottom Side	Antenna to user(mm)	165
	SAR exclusion threshold(mW)	1216
	SAR testing required?	NO
Exposure Positions	Tune-up Maximum power of 802.11a(5.8G)	
	14dBm	25.12mW
Left Side	Antenna to user(mm)	157
	SAR exclusion threshold(mW)	1132
	SAR testing required?	NO
Right Side	Antenna to user(mm)	85
	SAR exclusion threshold(mW)	412
	SAR testing required?	NO
Bottom Side	Antenna to user(mm)	165
	SAR exclusion threshold(mW)	1212
	SAR testing required?	NO

NOTE: Refer to section 4.3.1 of KDB 447498 D01.

9. SAR Measurement Results

Refer to KDB 447498 D01, the 1-g SAR and 10-g SAR test exclusion thresholds for 100 MHz to 6 GHz at test separation distances ≤ 50 mm are determined by:

$[(\text{max. power of channel, including tune-up tolerance, mW})/(\text{min. test separation distance, mm})] \cdot [\sqrt{f_{\text{(GHz)}}}] \leq 3.0$ for 1-g SAR and ≤ 7.5 for 10-g extremity SAR, where:

- $f_{\text{(GHz)}}$ is the RF channel transmit frequency in GHz
- Power and distance are rounded to the nearest mW and mm before calculation
- The result is rounded to one decimal place for comparison

When the minimum test separation distance is < 5 mm, a distance of 5 mm is applied to determine SAR test exclusion.

Mode	P_{max} (dBm)	P_{max} (mW)	Distance (mm)	f (GHz)	Calculation Result	SAR Exclusion threshold	SAR test exclusion
BT	1	1.26	5	2.462	0.4	3.0	Yes

NOTE: Standalone SAR test exclusion for BT

When standalone SAR test exclusion applies to an antenna that transmits simultaneously with other antennas, the standalone SAR must be estimated according to following to determine simultaneous transmission SAR test exclusion:

$[(\text{max. power of channel, including tune-up tolerance, mW})/(\text{min. test separation distance, mm})] \cdot [\sqrt{f_{\text{(GHz)}}/x}] \text{ W/kg}$ for test separation distances $\leq 50\text{mm}$, where $x = 7.5$ for 1-g SAR and $x = 18.75$ for 10-g SAR.

When the minimum test separation distance is < 5 mm, a distance of 5 mm is applied to determine SAR test exclusion.

Mode	Position	P_{max} (dBm)	P_{max} (mW)	Distance (mm)	f (GHz)	x	Estimated SAR (W/Kg)
BT	Body	1	1.26	5	2.462	7.5	0.053

NOTE: Estimated SAR calculation for BT

10. SAR Measurement Results

10.1. SAR measurement results

General Notes:

- 1) Per KDB447498 D01, all measurement SAR results are scaled to the maximum tune-up tolerance limit to demonstrate compliant.
- 2) Per KDB447498 D01, testing of other required channels within the operating mode of a frequency band is not required when the reported 1-g or 10-g SAR for the mid-band or highest output power channel is: ≤ 0.8 W/kg or 2.0 W/kg, for 1-g or 10-g respectively, when the transmission band is ≤ 100 MHz. When the maximum output power variation across the required test channels is $> \frac{1}{2}$ dB, instead of the middle channel, the highest output power channel must be used.
- 3) Per KDB865664 D01, for each frequency band, repeated SAR measurement is required only when the measured SAR is ≥ 0.8 W/Kg; if the deviation among the repeated measurement is $\leq 20\%$, and the measured SAR < 1.45 W/Kg, only one repeated measurement is required.
- 4) Per KDB865664 D02, SAR plot is only required for the highest measured SAR in each exposure configuration, wireless mode and frequency band combination; Plots are also required when the measured SAR is > 1.5 W/kg, or > 7.0 W/kg for occupational exposure. The published RF exposure KDB procedures may require additional plots; for example, to support SAR to peak location separation ratio test exclusion and/or volume scan post-processing(Refer to appendix C for details).

10.1.1. SAR measurement Result of Wi-Fi

Test Position of Body with 0mm	Test channel /Freq.	Test Mode	SAR Value (W/kg)		Power Drift (±5%)	Conducted power (dBm)	Tune-up power (dBm)	Scaled SAR 1g (W/Kg)
			1g	10g				
Back Side	1/2412	802.11b	0.684	0.328	-1.18	11.40	12.00	0.785

NOTE: Body SAR test results of Wi-Fi 2.4G

Test Position of Body with 0mm	Test channel /Freq.	Test Mode	SAR Value (W/kg)		Power Drift (±5%)	Conducted power (dBm)	Tune-up power (dBm)	Scaled SAR 1g (W/Kg)
			1g	10g				
Front Side	36/5180	802.11a	0.157	0.104	-3.61	17.00	17.50	0.176
Back Side	36/5180	802.11a	0.682	0.354	-0.40	17.00	17.50	0.765
Top Side	36/5180	802.11a	0.347	0.124	4.92	17.00	17.50	0.389

NOTE: Body SAR test results of Wi-Fi 5.2G

Test Position of Body with 0mm	Test channel /Freq.	Test Mode	SAR Value (W/kg)		Power Drift (±5%)	Conducted power (dBm)	Tune-up power (dBm)	Scaled SAR 1g (W/Kg)
			1g	10g				
Front Side	149/5745	802.11a	0.077	0.032	-3.57	13.50	14.00	0.086
Back Side	149/5745	802.11a	0.559	0.176	0.77	13.50	14.00	0.627
Top Side	149/5745	802.11a	0.176	0.069	-3.65	13.50	14.00	0.197

NOTE: Body SAR test results of Wi-Fi 5.8G

10.1.2. SAR measurement Result of Wi-Fi

Wi-Fi 2.4/5GHz and BT share the same antenna, and cannot transmit simultaneously.

11. Appendix A. Photo documentation



Table of contents
Test Facility
Product Photo
Test Positions
Liquid depth

Test Facility



Measurement System SATIMO

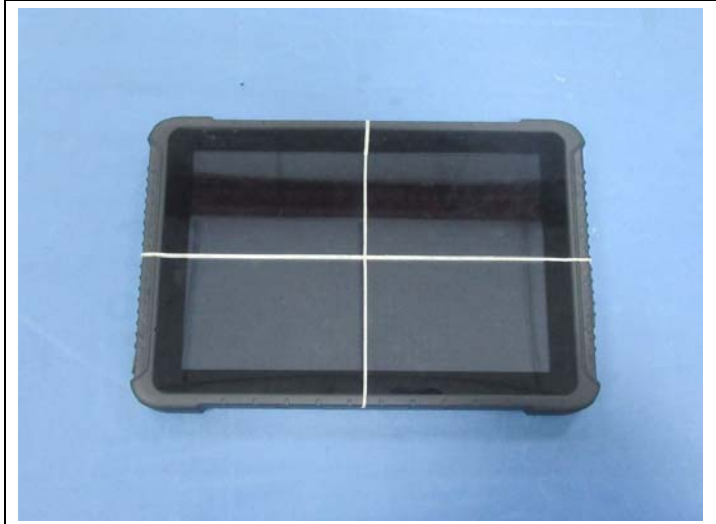

Product Photo

Front View	Back View
	
Reference Line	n/a
	n/a

Test Positions

<p>Front Side (Separation distance of 0mm)</p>	<p>Back Side (Separation distance of 0mm)</p>
	
<p>Top Side (Separation distance of 0mm)</p>	<p>n/a</p>
	<p>n/a</p>

Liquid depth

Body Position with 2450MHz liquid depth (15.2cm)



Body Position with 5000MHz liquid depth (15.4cm)



12. Appendix B. System Check Plots

Table of contents
System Performance Check - 2450MHz
System Performance Check - 5200MHz
System Performance Check - 5800MHz

System Performance Check - 2450MHz

Date of measurement:	Jan. 04, 2017
Signal:	Communication System: CW; Frequency: 2450MHz; Duty Cycle: 1:1.00
ConvF:	2.10
Liquid Parameters:	Relative permittivity (real part): 51.53; Conductivity (S/m): 1.92;
Device Position:	Dipole
Area Scan:	dx=12mm dy=12mm, h=5.00mm
Zoom Scan:	7x7x7, dx=5mm dy=5mm dz=5mm, h=5.00mm

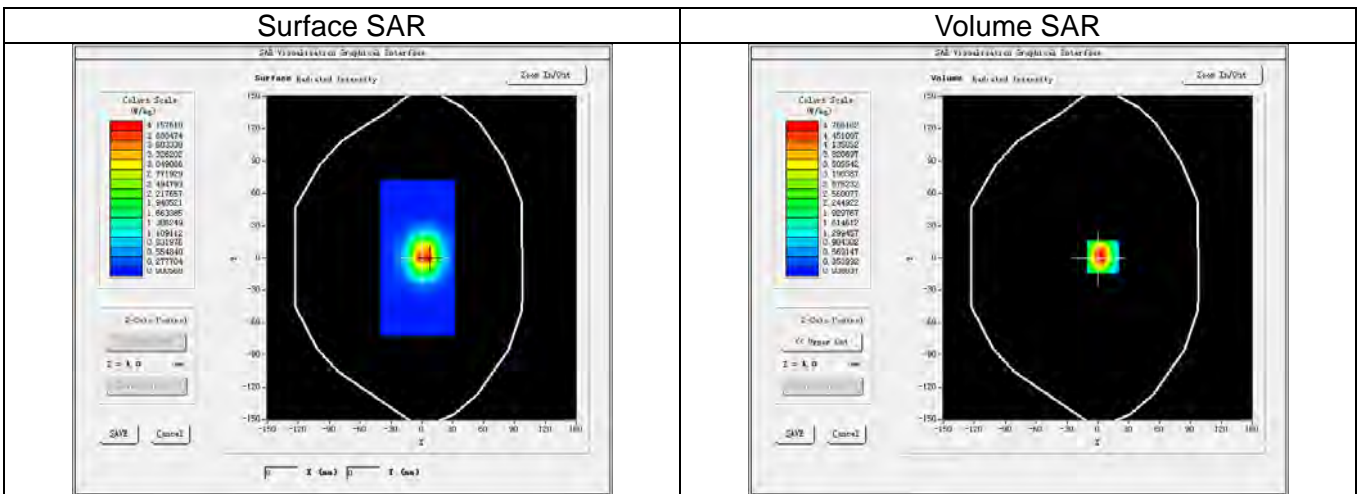

3D screen shot

Hot spot position

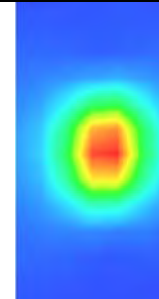
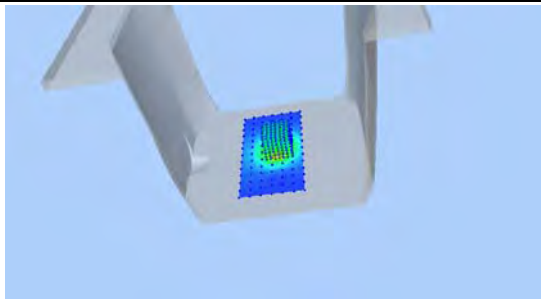

Maximum location: X=5.00, Y=1.00
SAR Peak: 7.86 W/kg

SAR 1g (W/Kg)		4.618					
SAR 10g (W/Kg)		2.183					
Power Drift (±5%):		-0.31					
Z (mm)	0.00	4.00	9.00	14.00	19.00	24.00	29.00
SAR (W/Kg)	7.6174	4.7662	2.5623	1.3810	0.7600	0.4138	0.2288

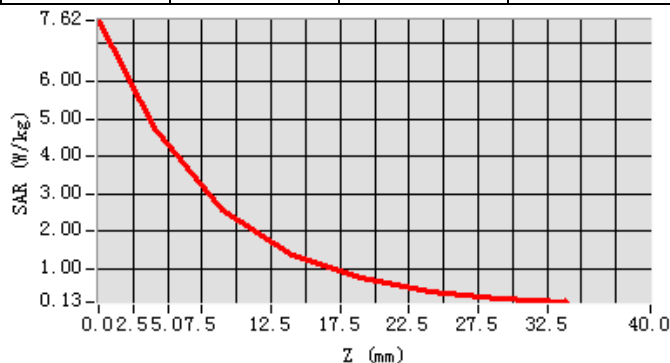

System Performance Check - 5200MHz

Date of measurement:	Jan. 05, 2017
Signal:	Communication System: CW; Frequency: 5200MHz; Duty Cycle: 1:1.00
ConvF:	2.04
Liquid Parameters:	Relative permittivity (real part): 49.92; Conductivity (S/m): 5.30;
Device Position:	Dipole
Area Scan:	dx=10mm dy=10mm, h=5.00mm
Zoom Scan:	7x7x12, dx=4mm dy=4mm dz=2mm, h=5.00mm

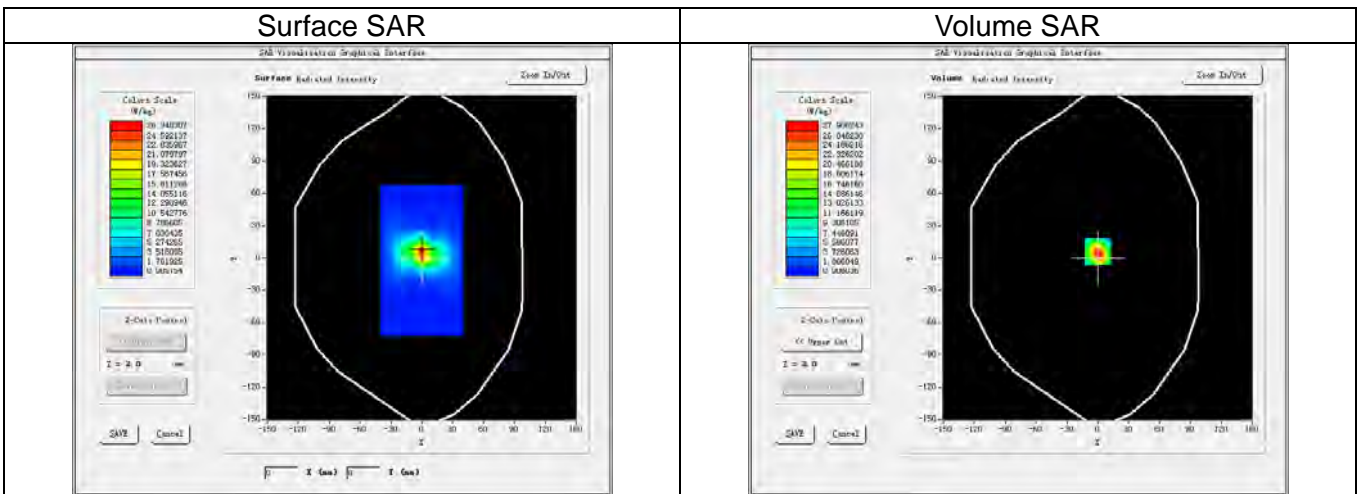

3D screen shot

Hot spot position

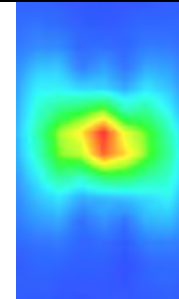
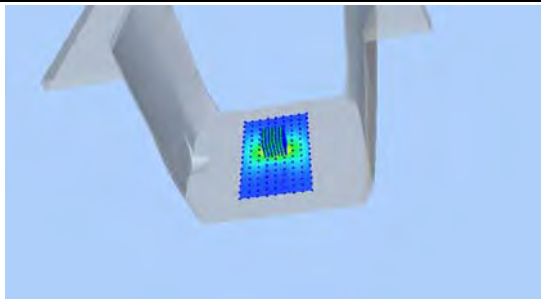

Maximum location: X=0.00, Y=6.00
SAR Peak: 50.21 W/kg

SAR 1g (W/Kg)		15.784					
SAR 10g (W/Kg)		5.484					
Power Drift (±5%):		-0.08					
Z (mm)	0.00	4.00	8.00	12.00	16.00	20.00	22.00
SAR (W/Kg)	47.1859	14.2157	3.5816	0.9069	0.2339	0.0718	0.0408

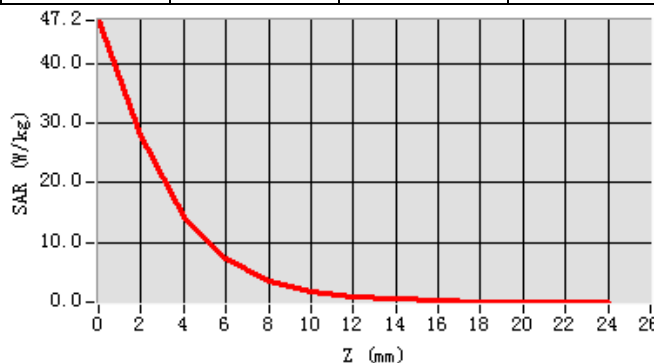

System Performance Check - 5800MHz

Date of measurement:	Jan. 06, 2017
Signal:	Communication System: CW; Frequency: 5800MHz; Duty Cycle: 1:1.00
ConvF:	2.07
Liquid Parameters:	Relative permittivity (real part): 49.05; Conductivity (S/m): 6.00;
Device Position:	Dipole
Area Scan:	dx=10mm dy=10mm, h=5.00mm
Zoom Scan:	7x7x12, dx=4mm dy=4mm dz=2mm, h=5.00mm

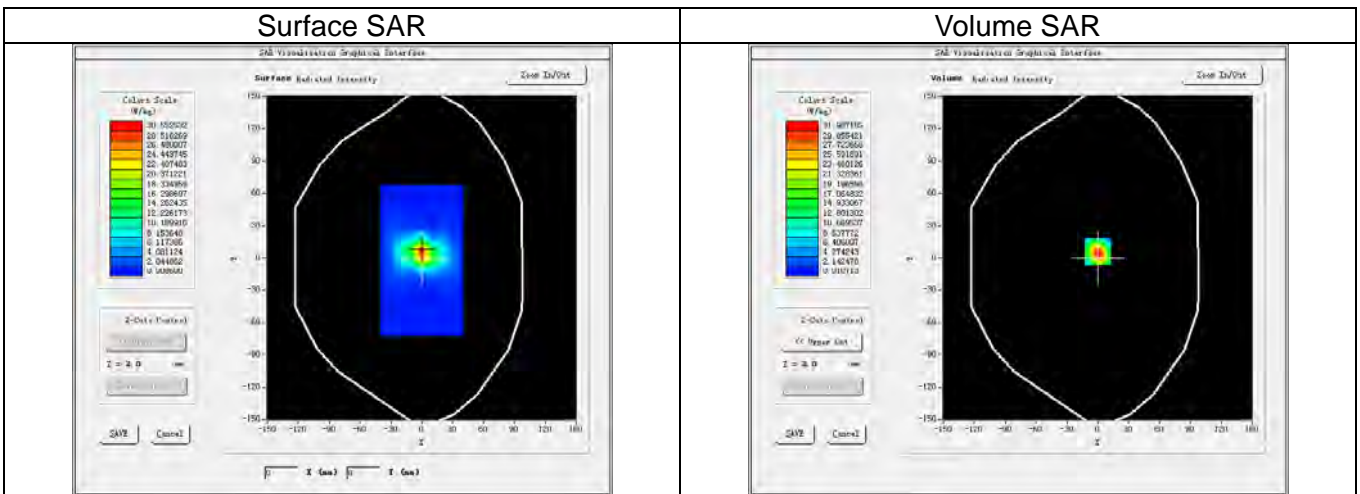

3D screen shot

Hot spot position

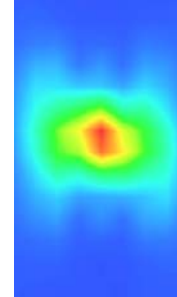
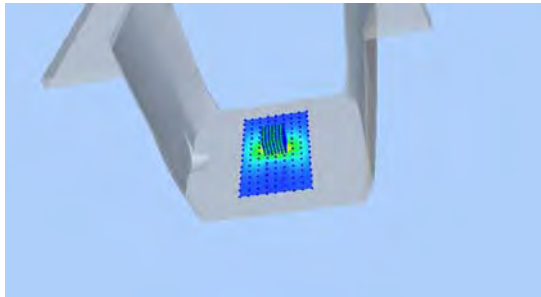

Maximum location: X=0.00, Y=6.00
SAR Peak: 57.20 W/kg

SAR 1g (W/Kg)		17.995					
SAR 10g (W/Kg)		6.163					
Power Drift (±5%):		-0.32					
Z (mm)	0.00	4.00	8.00	12.00	16.00	20.00	22.00
SAR (W/Kg)	54.1397	16.3513	4.0829	1.0345	0.2729	0.0755	0.0502

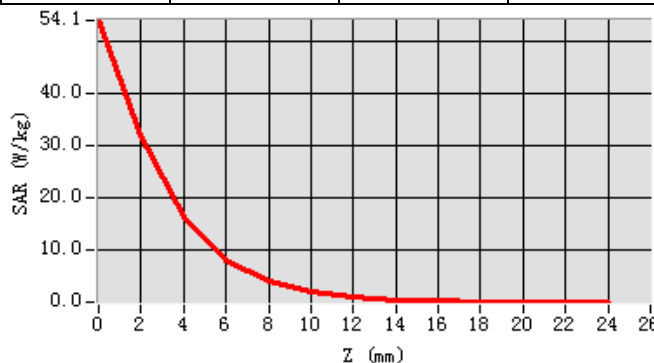

13. Appendix C. Plots of High SAR Measurement

Table of contents
Wi-Fi 2.4G Body
Wi-Fi 5.2G Body
Wi-Fi 5.8G Body

Wi-Fi 2.4G_802.11b_Ch1_Back Side_0mm

Date of measurement:	Jan. 04, 2017
Signal:	Communication System: Wi-Fi 802.11a/b/g/n/ac; Frequency: 2412MHz; Duty Cycle: 1:1.00
ConvF:	2.10
Liquid Parameters:	Relative permittivity (real part): 51.63; Conductivity (S/m): 1.98;
Device Position:	Body
Area Scan:	dx=12mm dy=12mm, h=5.00mm
Zoom Scan:	7x7x7, dx=5mm dy=5mm dz=5mm, h=5.00mm

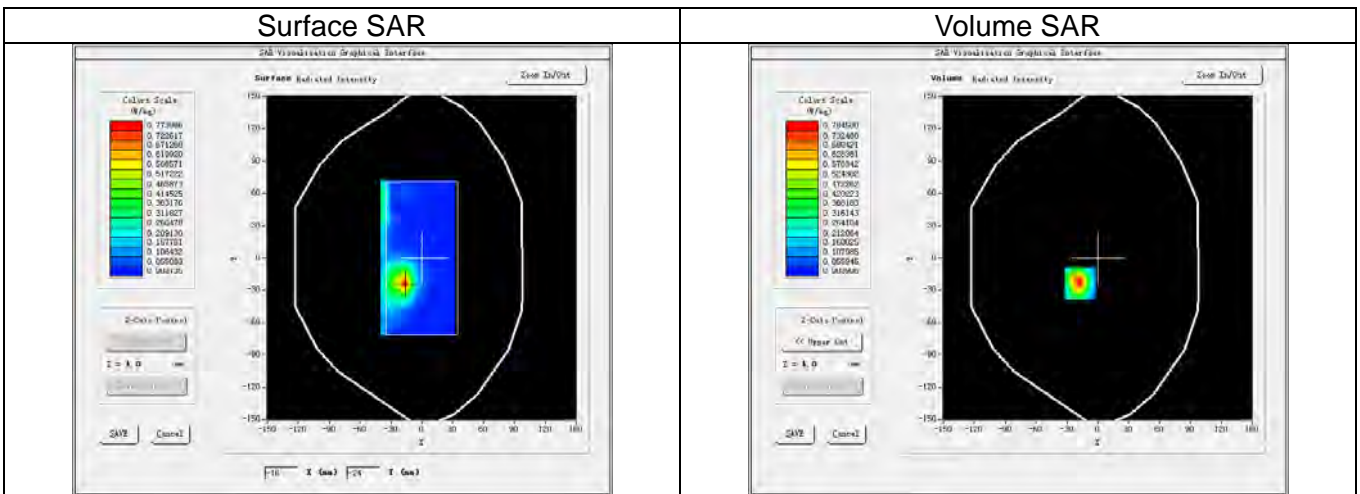

3D screen shot

Hot spot position

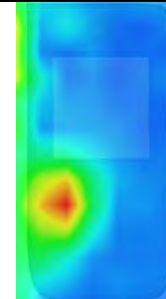
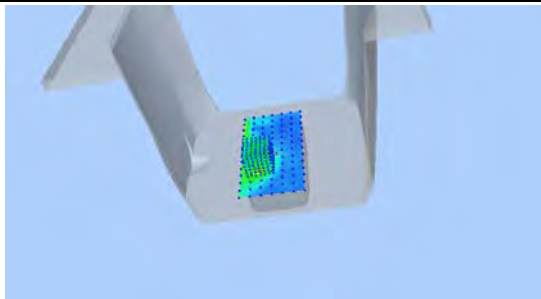

Maximum location: X=-17.00, Y=-24.00
SAR Peak: 1.30 W/kg

SAR 1g (W/Kg)		0.684					
SAR 10g (W/Kg)		0.328					
Power Drift (±5%):		-1.18					
Z (mm)	0.00	4.00	9.00	14.00	19.00	24.00	29.00
SAR (W/Kg)	1.1922	0.7845	0.4132	0.2506	0.1818	0.1515	0.1086

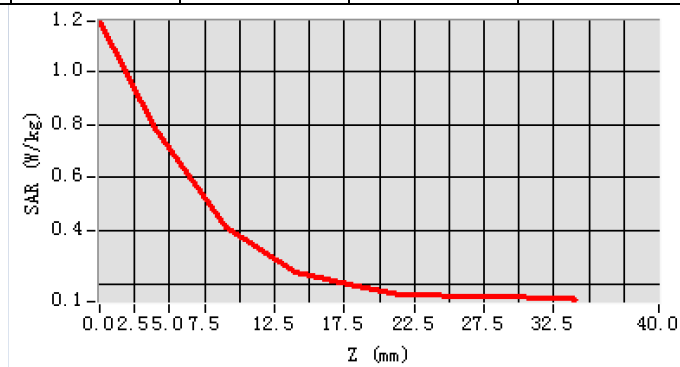

Wi-Fi 5.2G_802.11a_Ch36_Back Side_0mm

Date of measurement:	Jan. 05, 2017
Signal:	Communication System: Wi-Fi 802.11a/b/g/n/ac; Frequency: 5180MHz; Duty Cycle: 1:1.00
ConvF:	2.04
Liquid Parameters:	Relative permittivity (real part): 49.99; Conductivity (S/m): 5.28;
Device Position:	Body
Area Scan:	dx=10mm dy=10mm, h=5.00mm
Zoom Scan:	7x7x12, dx=4mm dy=4mm dz=2mm, h=5.00mm

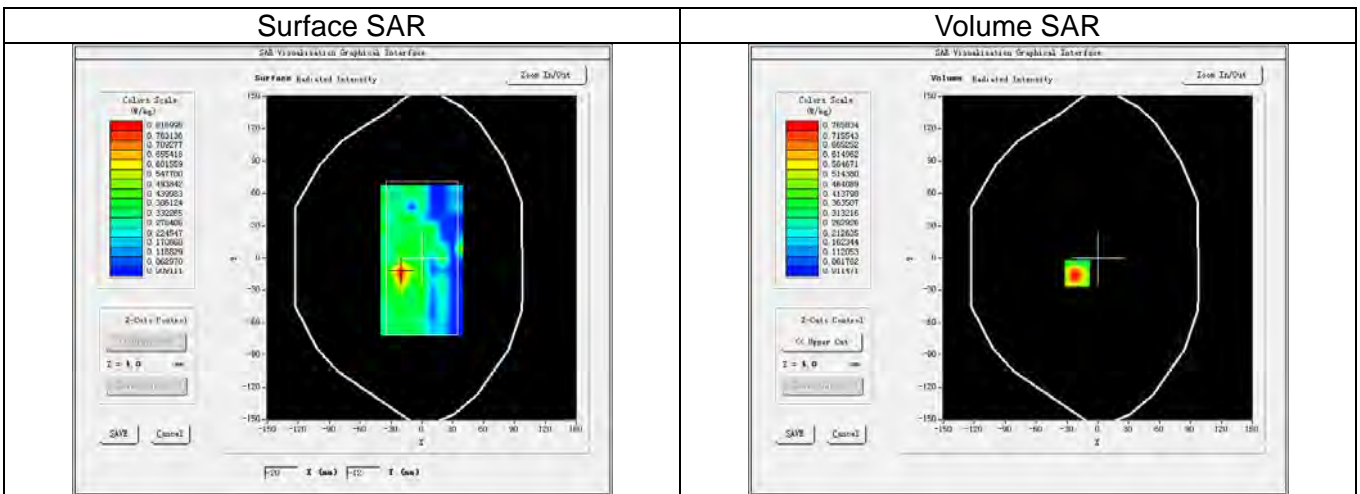

3D screen shot

Hot spot position

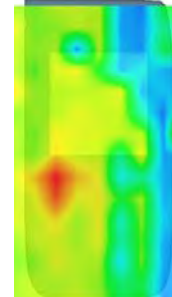
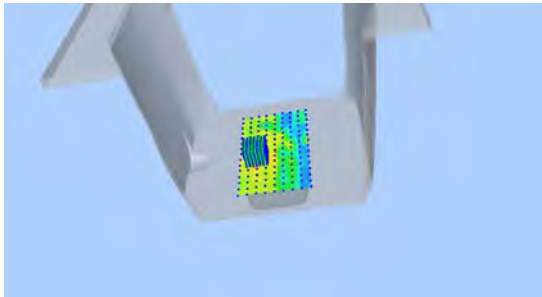

Maximum location: X=-20.00, Y=-14.00
SAR Peak: 2.16 W/kg

SAR 1g (W/Kg)		0.682					
SAR 10g (W/Kg)		0.354					
Power Drift (±5%):		-0.40					
Z (mm)	0.00	6.00	10.00	14.00	18.00	22.00	24.00
SAR (W/Kg)	1.4879	0.4648	0.2481	0.2082	0.1518	0.1019	0.0795

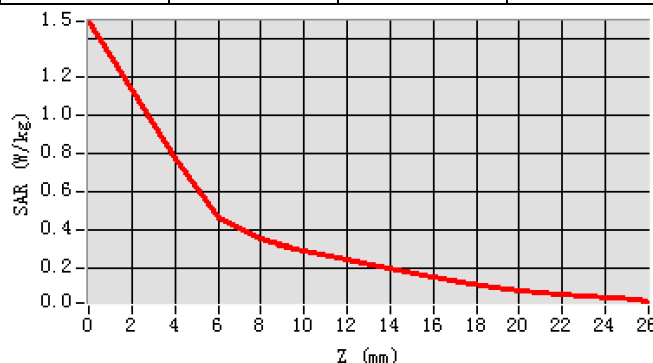

Wi-Fi 5.8G_802.11a_Ch149_Back Side_0mm

Date of measurement:	Jan. 06, 2017
Signal:	Communication System: Wi-Fi 802.11a/b/g/n/ac; Frequency: 5745MHz; Duty Cycle: 1:1.00
ConvF:	2.07
Liquid Parameters:	Relative permittivity (real part): 49.18; Conductivity (S/m): 5.95;
Device Position:	Body
Area Scan:	dx=10mm dy=10mm, h=5.00mm
Zoom Scan:	7x7x12, dx=4mm dy=4mm dz=2mm, h=5.00mm

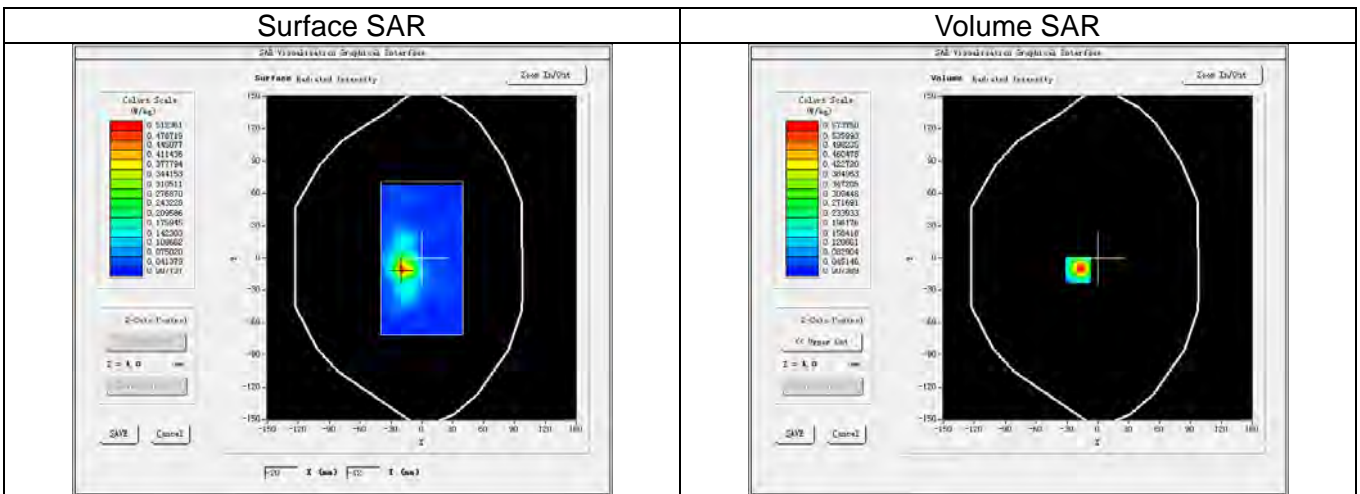

3D screen shot

Hot spot position

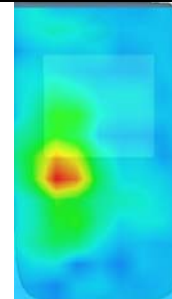
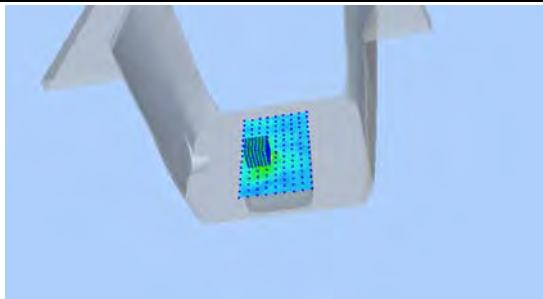

Maximum location: X=-19.00, Y=-11.00
SAR Peak: 1.67 W/kg

SAR 1g (W/Kg)		0.559					
SAR 10g (W/Kg)		0.176					
Power Drift (±5%):		0.77					
Z (mm)	0.00	6.00	10.00	14.00	18.00	22.00	24.00
SAR (W/Kg)	1.7432	0.1998	0.0452	0.0257	0.0139	0.0209	0.0106

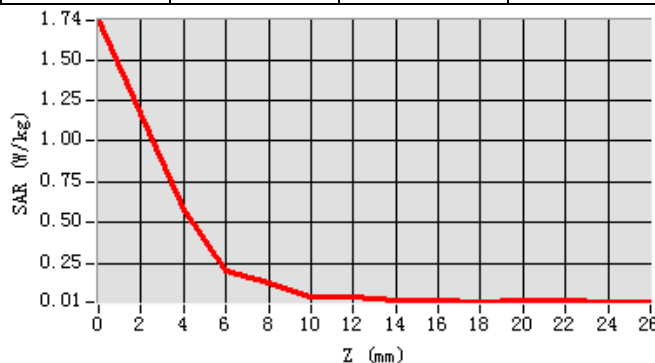

14. Appendix D. Calibration Certificate

Table of contents
E Field Probe - SN 08/16 EPGO287
2450 MHz Dipole - SN 03/15 DIP 2G450-352
5000-6000 MHz Dipole - SN 13/14 WGA 33
Extended Calibration Certificate



COMOSAR E-Field Probe Calibration Report

Ref : ACR.263.1.16.SATU.A

NTEK TESTING TECHNOLOGY CO., LTD.
BUILDING E, FENDA SCIENCE PARK, SANWEI
COMMUNITY, XIXIANG STREET,
BAO'AN DISTRICT, SHENZHEN GUANGDONG, CHINA
MVG COMOSAR DOSIMETRIC E-FIELD PROBE
SERIAL NO.: SN 08/16 EPGO287

Calibrated at MVG US
2105 Barrett Park Dr. - Kennesaw, GA 30144



Calibration Date: 09/08/2016

Summary:

This document presents the method and results from an accredited COMOSAR Dosimetric E-Field Probe calibration performed in MVG USA using the CALISAR / CALIBAIR test bench, for use with a COMOSAR system only. All calibration results are traceable to national metrology institutions.



COMOSAR E-FIELD PROBE CALIBRATION REPORT

Ref ACR.263.1.16.SATU.A

	<i>Name</i>	<i>Function</i>	<i>Date</i>	<i>Signature</i>
<i>Prepared by :</i>	Jérôme LUC	Product Manager	9/19/2016	<i>JS</i>
<i>Checked by :</i>	Jérôme LUC	Product Manager	9/19/2016	<i>JS</i>
<i>Approved by :</i>	Kim RUTKOWSKI	Quality Manager	9/19/2016	<i>Kim Rutkowski</i>

<i>Distribution :</i>	<i>Customer Name</i> NTEK TESTING TECHNOLOGY CO., LTD.
-----------------------	---

<i>Issue</i>	<i>Date</i>	<i>Modifications</i>
A	9/19/2016	Initial release



COMOSAR E-FIELD PROBE CALIBRATION REPORT

Ref: ACR.263.1.16.SATU.A

TABLE OF CONTENTS

1 Device Under Test 4

2 Product Description 4

 2.1 General Information 4

3 Measurement Method 4

 3.1 Linearity 4

 3.2 Sensitivity 5

 3.3 Lower Detection Limit 5

 3.4 Isotropy 5

 3.5 Boundary Effect 5

4 Measurement Uncertainty 5

5 Calibration Measurement Results 6

 5.1 Sensitivity in air 6

 5.2 Linearity 7

 5.3 Sensitivity in liquid 7

 5.4 Isotropy 8

6 List of Equipment 10



COMOSAR E-FIELD PROBE CALIBRATION REPORT

Ref: ACR.263.1.16.SATU.A

1 DEVICE UNDER TEST

Device Under Test	
Device Type	COMOSAR DOSIMETRIC E FIELD PROBE
Manufacturer	MVG
Model	SSE2
Serial Number	SN 08/16 EPGO287
Product Condition (new / used)	New
Frequency Range of Probe	0.7 GHz-6GHz
Resistance of Three Dipoles at Connector	Dipole 1: R1=0.206 MΩ Dipole 2: R2=0.193 MΩ Dipole 3: R3=0.194 MΩ

A yearly calibration interval is recommended.

2 PRODUCT DESCRIPTION

2.1 GENERAL INFORMATION

MVG’s COMOSAR E field Probes are built in accordance to the IEEE 1528, OET 65 Bulletin C and CEI/IEC 62209 standards.



Figure 1 – MVG COMOSAR Dosimetric E field Dipole

Probe Length	330 mm
Length of Individual Dipoles	2 mm
Maximum external diameter	8 mm
Probe Tip External Diameter	2.5 mm
Distance between dipoles / probe extremity	1 mm

3 MEASUREMENT METHOD

The IEEE 1528, OET 65 Bulletin C, CENELEC EN50361 and CEI/IEC 62209 standards provide recommended practices for the probe calibrations, including the performance characteristics of interest and methods by which to assess their affect. All calibrations / measurements performed meet the fore mentioned standards.

3.1 LINEARITY

The evaluation of the linearity was done in free space using the waveguide, performing a power sweep to cover the SAR range 0.01W/kg to 100W/kg.



COMOSAR E-FIELD PROBE CALIBRATION REPORT

Ref: ACR.263.1.16.SATU.A

3.2 SENSITIVITY

The sensitivity factors of the three dipoles were determined using a two step calibration method (air and tissue simulating liquid) using waveguides as outlined in the standards.

3.3 LOWER DETECTION LIMIT

The lower detection limit was assessed using the same measurement set up as used for the linearity measurement. The required lower detection limit is 10 mW/kg.

3.4 ISOTROPY

The axial isotropy was evaluated by exposing the probe to a reference wave from a standard dipole with the dipole mounted under the flat phantom in the test configuration suggested for system validations and checks. The probe was rotated along its main axis from 0 - 360 degrees in 15 degree steps. The hemispherical isotropy is determined by inserting the probe in a thin plastic box filled with tissue-equivalent liquid, with the plastic box illuminated with the fields from a half wave dipole. The dipole is rotated about its axis (0°–180°) in 15° increments. At each step the probe is rotated about its axis (0°–360°).

3.5 BOUNDARY EFFECT

The boundary effect is defined as the deviation between the SAR measured data and the expected exponential decay in the liquid when the probe is oriented normal to the interface. To evaluate this effect, the liquid filled flat phantom is exposed to fields from either a reference dipole or waveguide. With the probe normal to the phantom surface, the peak spatial average SAR is measured and compared to the analytical value at the surface.

4 MEASUREMENT UNCERTAINTY

The guidelines outlined in the IEEE 1528, OET 65 Bulletin C, CENELEC EN50361 and CEI/IEC 62209 standards were followed to generate the measurement uncertainty associated with an E-field probe calibration using the waveguide technique. All uncertainties listed below represent an expanded uncertainty expressed at approximately the 95% confidence level using a coverage factor of k=2, traceable to the Internationally Accepted Guides to Measurement Uncertainty.

Uncertainty analysis of the probe calibration in waveguide					
ERROR SOURCES	Uncertainty value (%)	Probability Distribution	Divisor	ci	Standard Uncertainty (%)
Incident or forward power	3.00%	Rectangular	$\sqrt{3}$	1	1.732%
Reflected power	3.00%	Rectangular	$\sqrt{3}$		1.732%
Liquid conductivity	5.00%	Rectangular	$\sqrt{3}$		2.887%
Liquid permittivity	4.00%	Rectangular	$\sqrt{3}$		2.309%
Field homogeneity	3.00%	Rectangular	$\sqrt{3}$		1.732%
Field probe positioning	5.00%	Rectangular	$\sqrt{3}$		2.887%



COMOSAR E-FIELD PROBE CALIBRATION REPORT

Ref: ACR.263.1.16.SATU.A

Field probe linearity	3.00%	Rectangular	$\sqrt{3}$	1	1.732%
Combined standard uncertainty					5.831%
Expanded uncertainty 95 % confidence level k = 2					12.0%

5 CALIBRATION MEASUREMENT RESULTS

Calibration Parameters	
Liquid Temperature	21 °C
Lab Temperature	21 °C
Lab Humidity	45 %

5.1 SENSITIVITY IN AIR

Normx dipole 1 ($\mu\text{V}/(\text{V}/\text{m})^2$)	Normy dipole 2 ($\mu\text{V}/(\text{V}/\text{m})^2$)	Normz dipole 3 ($\mu\text{V}/(\text{V}/\text{m})^2$)
0.70	0.81	0.63

DCP dipole 1 (mV)	DCP dipole 2 (mV)	DCP dipole 3 (mV)
91	90	94

Calibration curves $e_i=f(V)$ ($i=1,2,3$) allow to obtain H-field value using the formula:

$$E = \sqrt{E_1^2 + E_2^2 + E_3^2}$$

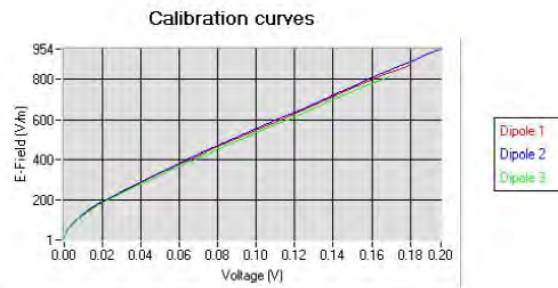



COMOSAR E-FIELD PROBE CALIBRATION REPORT

Ref: ACR.263.1.16.SATU.A

5.2 LINEARITY

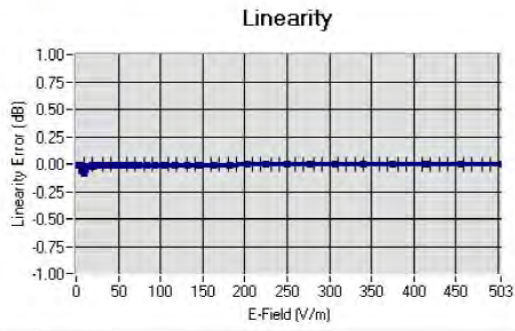

Linearity: $\pm 1.83\%$ ($\pm 0.08\text{dB}$)

5.3 SENSITIVITY IN LIQUID

Liquid	Frequency (MHz +/- 100MHz)	Permittivity	Epsilon (S/m)	ConvF
HL450	450	42.17	0.86	1.51
BL450	450	57.65	0.95	1.55
HL750	750	40.03	0.93	1.36
BL750	750	56.83	1.00	1.41
HL850	835	42.19	0.90	1.53
BL850	835	54.67	1.01	1.59
HL900	900	42.08	1.01	1.43
BL900	900	55.25	1.08	1.48
HL1800	1800	41.68	1.46	1.66
BL1800	1800	53.86	1.46	1.69
HL1900	1900	38.45	1.45	1.94
BL1900	1900	53.32	1.56	2.00
HL2000	2000	38.26	1.38	1.87
BL2000	2000	52.70	1.51	1.94
HL2450	2450	37.50	1.80	2.03
BL2450	2450	53.22	1.89	2.10
HL2600	2600	39.80	1.99	2.11
BL2600	2600	52.52	2.23	2.17
HL5200	5200	35.64	4.67	1.99
BL5200	5200	48.64	5.51	2.04
HL5400	5400	36.44	4.87	2.09
BL5400	5400	46.52	5.77	2.16
HL5600	5600	36.66	5.17	2.10
BL5600	5600	46.79	5.77	2.17
HL5800	5800	35.31	5.31	2.02
BL5800	5800	47.04	6.10	2.07

LOWER DETECTION LIMIT: 8mW/kg



COMOSAR E-FIELD PROBE CALIBRATION REPORT

Ref: ACR.263.1.16.SATU.A

5.4 ISOTROPY

HL900 MHz

- Axial isotropy: 0.04 dB
- Hemispherical isotropy: 0.07 dB

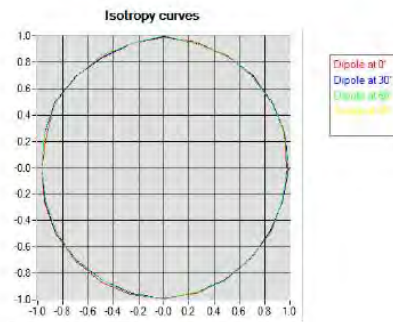

HL1800 MHz

- Axial isotropy: 0.05 dB
- Hemispherical isotropy: 0.07 dB

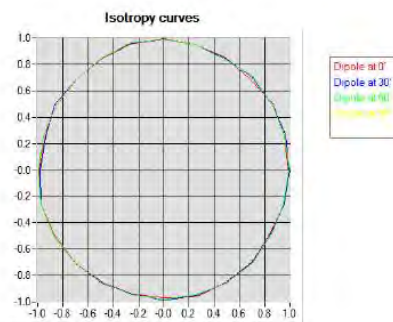



COMOSAR E-FIELD PROBE CALIBRATION REPORT

Ref: ACR.263.1.16.SATU.A

HL5600 MHz

- Axial isotropy: 0.06 dB
- Hemispherical isotropy: 0.10 dB

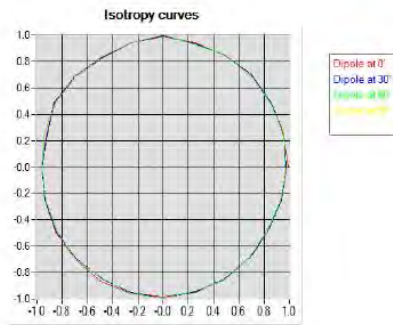



COMOSAR E-FIELD PROBE CALIBRATION REPORT

Ref: ACR.263.1.16.SATU.A

6 LIST OF EQUIPMENT

Equipment Summary Sheet				
Equipment Description	Manufacturer / Model	Identification No.	Current Calibration Date	Next Calibration Date
Flat Phantom	MVG	SN-20/09-SAM71	Validated. No cal required.	Validated. No cal required.
COMOSAR Test Bench	Version 3	NA	Validated. No cal required.	Validated. No cal required.
Network Analyzer	Rhode & Schwarz ZVA	SN100132	02/2016	02/2019
Reference Probe	MVG	EP 94 SN 37/08	10/2015	10/2016
Multimeter	Keithley 2000	1188656	12/2013	12/2016
Signal Generator	Agilent E4438C	MY49070581	12/2013	12/2016
Amplifier	Aethercomm	SN 046	Characterized prior to test. No cal required.	Characterized prior to test. No cal required.
Power Meter	HP E4418A	US38261498	12/2013	12/2016
Power Sensor	HP ECP-E26A	US37181460	12/2013	12/2016
Directional Coupler	Narda 4216-20	01386	Characterized prior to test. No cal required.	Characterized prior to test. No cal required.
Waveguide	Mega Industries	069Y7-158-13-712	Validated. No cal required.	Validated. No cal required.
Waveguide Transition	Mega Industries	069Y7-158-13-701	Validated. No cal required.	Validated. No cal required.
Waveguide Termination	Mega Industries	069Y7-158-13-701	Validated. No cal required.	Validated. No cal required.
Temperature / Humidity Sensor	Control Company	150798832	10/2015	10/2017



SAR Reference Dipole Calibration Report

Ref : ACR.139.9.15.SATU.A

NTEK TESTING TECHNOLOGY CO., LTD.
BUILDING E, FENDA SCIENCE PARK, SANWEI
COMMUNITY, XIXIANG STREET,
BAO'AN DISTRICT, SHENZHEN GUANGDONG, CHINA
MVG COMOSAR REFERENCE DIPOLE
FREQUENCY: 2450 MHZ
SERIAL NO.: SN 03/15 DIP 2G450-352

Calibrated at MVG US
2105 Barrett Park Dr. - Kennesaw, GA 30144



04/06/2015

Summary:

This document presents the method and results from an accredited SAR reference dipole calibration performed in MVG USA using the COMOSAR test bench. All calibration results are traceable to national metrology institutions.



SAR REFERENCE DIPOLE CALIBRATION REPORT

Ref: ACR.139.9.15.SATU.A

	<i>Name</i>	<i>Function</i>	<i>Date</i>	<i>Signature</i>
<i>Prepared by :</i>	Jérôme LUC	Product Manager	5/19/2015	<i>JL</i>
<i>Checked by :</i>	Jérôme LUC	Product Manager	5/19/2015	<i>JL</i>
<i>Approved by :</i>	Kim RUTKOWSKI	Quality Manager	5/19/2015	<i>Kim Rutkowski</i>

	<i>Customer Name</i>
<i>Distribution :</i>	NTEK TESTING TECHNOLOGY CO., LTD.

<i>Issue</i>	<i>Date</i>	<i>Modifications</i>
A	5/19/2015	Initial release



TABLE OF CONTENTS

1	Introduction.....	4
2	Device Under Test	4
3	Product Description	4
3.1	General Information	4
4	Measurement Method	5
4.1	Return Loss Requirements	5
4.2	Mechanical Requirements	5
5	Measurement Uncertainty.....	5
5.1	Return Loss	5
5.2	Dimension Measurement	5
5.3	Validation Measurement	5
6	Calibration Measurement Results.....	6
6.1	Return Loss and Impedance In Head Liquid	6
6.2	Return Loss and Impedance In Body Liquid	6
6.3	Mechanical Dimensions	6
7	Validation measurement	7
7.1	Head Liquid Measurement	7
7.2	SAR Measurement Result With Head Liquid	8
7.3	Body Liquid Measurement	9
7.4	SAR Measurement Result With Body Liquid	10
8	List of Equipment	11



SAR REFERENCE DIPOLE CALIBRATION REPORT

Ref: ACR.139.9.15.SATU.A

1 INTRODUCTION

This document contains a summary of the requirements set forth by the IEEE 1528, FCC KDBs and CEI/IEC 62209 standards for reference dipoles used for SAR measurement system validations and the measurements that were performed to verify that the product complies with the fore mentioned standards.

2 DEVICE UNDER TEST

Device Under Test	
Device Type	COMOSAR 2450 MHz REFERENCE DIPOLE
Manufacturer	MVG
Model	SID2450
Serial Number	SN 03/15 DIP 2G450-352
Product Condition (new / used)	New

A yearly calibration interval is recommended.

3 PRODUCT DESCRIPTION

3.1 GENERAL INFORMATION

MVG's COMOSAR Validation Dipoles are built in accordance to the IEEE 1528, FCC KDBs and CEI/IEC 62209 standards. The product is designed for use with the COMOSAR test bench only.



Figure 1 – MVG COMOSAR Validation Dipole



4 MEASUREMENT METHOD

The IEEE 1528, FCC KDBs and CEI/IEC 62209 standards provide requirements for reference dipoles used for system validation measurements. The following measurements were performed to verify that the product complies with the fore mentioned standards.

4.1 RETURN LOSS REQUIREMENTS

The dipole used for SAR system validation measurements and checks must have a return loss of -20 dB or better. The return loss measurement shall be performed against a liquid filled flat phantom, with the phantom constructed as outlined in the fore mentioned standards.

4.2 MECHANICAL REQUIREMENTS

The IEEE Std. 1528 and CEI/IEC 62209 standards specify the mechanical components and dimensions of the validation dipoles, with the dimensions frequency and phantom shell thickness dependent. The COMOSAR test bench employs a 2 mm phantom shell thickness therefore the dipoles sold for use with the COMOSAR test bench comply with the requirements set forth for a 2 mm phantom shell thickness.

5 MEASUREMENT UNCERTAINTY

All uncertainties listed below represent an expanded uncertainty expressed at approximately the 95% confidence level using a coverage factor of k=2, traceable to the Internationally Accepted Guides to Measurement Uncertainty.

5.1 RETURN LOSS

The following uncertainties apply to the return loss measurement:

Frequency band	Expanded Uncertainty on Return Loss
400-6000MHz	0.1 dB

5.2 DIMENSION MEASUREMENT

The following uncertainties apply to the dimension measurements:

Length (mm)	Expanded Uncertainty on Length
3 - 300	0.05 mm

5.3 VALIDATION MEASUREMENT

The guidelines outlined in the IEEE 1528, FCC KDBs, CENELEC EN50361 and CEI/IEC 62209 standards were followed to generate the measurement uncertainty for validation measurements.

Scan Volume	Expanded Uncertainty
1 g	20.3 %



SAR REFERENCE DIPOLE CALIBRATION REPORT

Ref: ACR.139.9.15.SATU.A

10 g	20.1 %
------	--------

6 CALIBRATION MEASUREMENT RESULTS

6.1 RETURN LOSS AND IMPEDANCE IN HEAD LIQUID

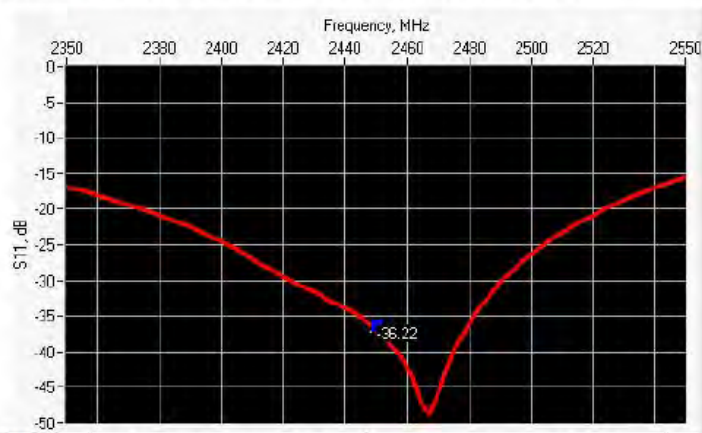

Frequency (MHz)	Return Loss (dB)	Requirement (dB)	Impedance
2450	-36.22	-20	48.9 Ω + 1.1 jΩ

6.2 RETURN LOSS AND IMPEDANCE IN BODY LIQUID

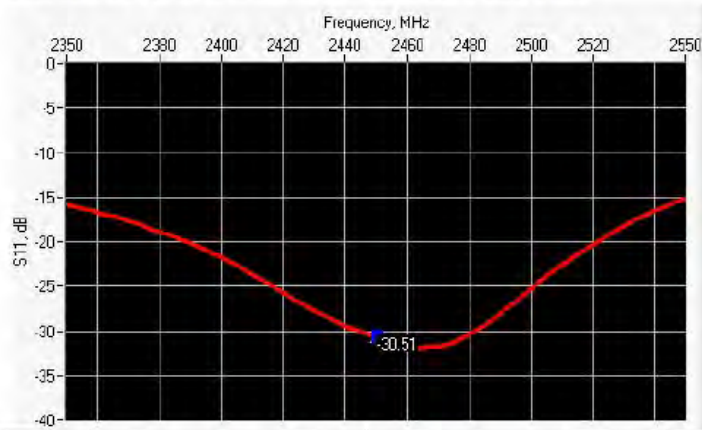

Frequency (MHz)	Return Loss (dB)	Requirement (dB)	Impedance
2450	-30.51	-20	52.2 Ω + 2.0 jΩ

6.3 MECHANICAL DIMENSIONS

Frequency MHz	L mm		h mm		d mm	
	required	measured	required	measured	required	measured
300	420.0 ±1 %		250.0 ±1 %		6.35 ±1 %	



SAR REFERENCE DIPOLE CALIBRATION REPORT

Ref. ACR.139.9.15.SATU.A

450	290.0 ±1 %.		166.7 ±1 %.		6.35 ±1 %.	
750	176.0 ±1 %.		100.0 ±1 %.		6.35 ±1 %.	
835	161.0 ±1 %.		89.8 ±1 %.		3.6 ±1 %.	
900	149.0 ±1 %.		83.3 ±1 %.		3.6 ±1 %.	
1450	89.1 ±1 %.		51.7 ±1 %.		3.6 ±1 %.	
1500	80.5 ±1 %.		50.0 ±1 %.		3.6 ±1 %.	
1640	79.0 ±1 %.		45.7 ±1 %.		3.6 ±1 %.	
1750	75.2 ±1 %.		42.9 ±1 %.		3.6 ±1 %.	
1800	72.0 ±1 %.		41.7 ±1 %.		3.6 ±1 %.	
1900	68.0 ±1 %.		39.5 ±1 %.		3.6 ±1 %.	
1950	66.3 ±1 %.		38.5 ±1 %.		3.6 ±1 %.	
2000	64.5 ±1 %.		37.5 ±1 %.		3.6 ±1 %.	
2100	61.0 ±1 %.		35.7 ±1 %.		3.6 ±1 %.	
2300	55.5 ±1 %.		32.6 ±1 %.		3.6 ±1 %.	
2450	51.5 ±1 %.	PASS	30.4 ±1 %.	PASS	3.6 ±1 %.	PASS
2600	48.5 ±1 %.		28.8 ±1 %.		3.6 ±1 %.	
3000	41.5 ±1 %.		25.0 ±1 %.		3.6 ±1 %.	
3500	37.0 ±1 %.		26.4 ±1 %.		3.6 ±1 %.	
3700	34.7 ±1 %.		26.4 ±1 %.		3.6 ±1 %.	

7 VALIDATION MEASUREMENT

The IEEE Std. 1528, FCC KDBs and CEI/IEC 62209 standards state that the system validation measurements must be performed using a reference dipole meeting the fore mentioned return loss and mechanical dimension requirements. The validation measurement must be performed against a liquid filled flat phantom, with the phantom constructed as outlined in the fore mentioned standards. Per the standards, the dipole shall be positioned below the bottom of the phantom, with the dipole length centered and parallel to the longest dimension of the flat phantom, with the top surface of the dipole at the described distance from the bottom surface of the phantom.

7.1 HEAD LIQUID MEASUREMENT

Frequency MHz	Relative permittivity (ε _r)		Conductivity (σ) S/m	
	required	measured	required	measured
300	45.3 ±5 %		0.87 ±5 %	
450	43.5 ±5 %		0.87 ±5 %	
750	41.9 ±5 %		0.89 ±5 %	
835	41.5 ±5 %		0.90 ±5 %	
900	41.5 ±5 %		0.97 ±5 %	
1450	40.5 ±5 %		1.20 ±5 %	
1500	40.4 ±5 %		1.23 ±5 %	
1640	40.2 ±5 %		1.31 ±5 %	
1750	40.1 ±5 %		1.37 ±5 %	



SAR REFERENCE DIPOLE CALIBRATION REPORT

Ref: ACR.139.9.15.SATU.A

1800	40.0 ±5 %		1.40 ±5 %	
1900	40.0 ±5 %		1.40 ±5 %	
1950	40.0 ±5 %		1.40 ±5 %	
2000	40.0 ±5 %		1.40 ±5 %	
2100	39.8 ±5 %		1.49 ±5 %	
2300	39.5 ±5 %		1.67 ±5 %	
2450	39.2 ±5 %	PASS	1.80 ±5 %	PASS
2600	39.0 ±5 %		1.96 ±5 %	
3000	38.5 ±5 %		2.40 ±5 %	
3500	37.9 ±5 %		2.91 ±5 %	

7.2 SAR MEASUREMENT RESULT WITH HEAD LIQUID

The IEEE Std. 1528 and CEI/IEC 62209 standards state that the system validation measurements should produce the SAR values shown below (for phantom thickness of 2 mm), within the uncertainty for the system validation. All SAR values are normalized to 1 W forward power. In bracket, the measured SAR is given with the used input power.

Software	OPENSAR V4
Phantom	SN 20/09 SAM71
Probe	SN 18/11 EPG122
Liquid	Head Liquid Values: eps' : 38.3 sigma : 1.80
Distance between dipole center and liquid	10.0 mm
Area scan resolution	dx=8mm/dy=8mm
Zoon Scan Resolution	dx=5mm/dy=5mm/dz=5mm
Frequency	2450 MHz
Input power	20 dBm
Liquid Temperature	21 °C
Lab Temperature	21 °C
Lab Humidity	45 %

Frequency MHz	1 g SAR (W/kg/W)		10 g SAR (W/kg/W)	
	required	measured	required	measured
300	2.85		1.94	
450	4.58		3.06	
750	8.49		5.55	
835	9.56		6.22	
900	10.9		6.99	
1450	29		16	
1500	30.5		16.8	
1640	34.2		18.4	
1750	36.4		19.3	
1800	38.4		20.1	



SAR REFERENCE DIPOLE CALIBRATION REPORT

Ref. ACR.139.9.15.SATU.A

1900	39.7		20.5	
1950	40.5		20.9	
2000	41.1		21.1	
2100	43.6		21.9	
2300	48.7		23.3	
2450	52.4	52.28 (5.23)	24	23.80 (2.38)
2600	55.3		24.6	
3000	63.8		25.7	
3500	67.1		25	

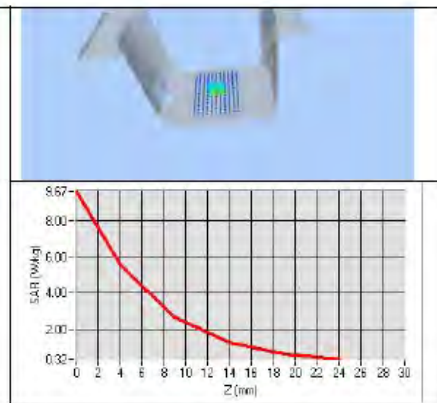
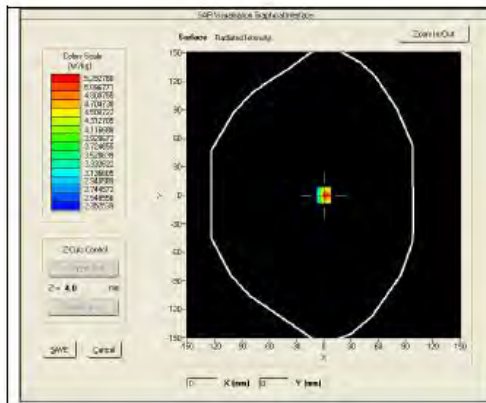

7.3 BODY LIQUID MEASUREMENT

Frequency MHz	Relative permittivity (ϵ_r')		Conductivity (σ) S/m	
	required	measured	required	measured
150	61.9 ±5 %		0.80 ±5 %	
300	58.2 ±5 %		0.92 ±5 %	
450	56.7 ±5 %		0.94 ±5 %	
750	55.5 ±5 %		0.96 ±5 %	
835	55.2 ±5 %		0.97 ±5 %	
900	55.0 ±5 %		1.05 ±5 %	
915	55.0 ±5 %		1.06 ±5 %	
1450	54.0 ±5 %		1.30 ±5 %	
1610	53.8 ±5 %		1.40 ±5 %	
1800	53.3 ±5 %		1.52 ±5 %	
1900	53.3 ±5 %		1.52 ±5 %	
2000	53.3 ±5 %		1.52 ±5 %	
2100	53.2 ±5 %		1.62 ±5 %	
2450	52.7 ±5 %	PASS	1.95 ±5 %	PASS



SAR REFERENCE DIPOLE CALIBRATION REPORT

Ref: ACR.139.9.15.SATU.A

2600	52.5 ±5 %		2.16 ±5 %
3000	52.0 ±5 %		2.73 ±5 %
3500	51.3 ±5 %		3.31 ±5 %
5200	49.0 ±10 %		5.30 ±10 %
5300	48.9 ±10 %		5.42 ±10 %
5400	48.7 ±10 %		5.53 ±10 %
5500	48.6 ±10 %		5.65 ±10 %
5600	48.5 ±10 %		5.77 ±10 %
5800	48.2 ±10 %		6.00 ±10 %

7.4 SAR MEASUREMENT RESULT WITH BODY LIQUID

Software	OPENSAR V4
Phantom	SN 20/09 SAM71
Probe	SN 18/11 EPG122
Liquid	Body Liquid Values: $\epsilon_s' : 52.7$ $\sigma : 1.94$
Distance between dipole center and liquid	10.0 mm
Area scan resolution	$dx=8mm/dy=8mm$
Zoon Scan Resolution	$dx=5mm/dy=5mm/dz=5mm$
Frequency	2450 MHz
Input power	20 dBm
Liquid Temperature	21 °C
Lab Temperature	21 °C
Lab Humidity	45 %

Frequency MHz	1 g SAR (W/kg/W)	10 g SAR (W/kg/W)
	measured	measured
2450	49.32 (4.93)	22.89 (2.29)

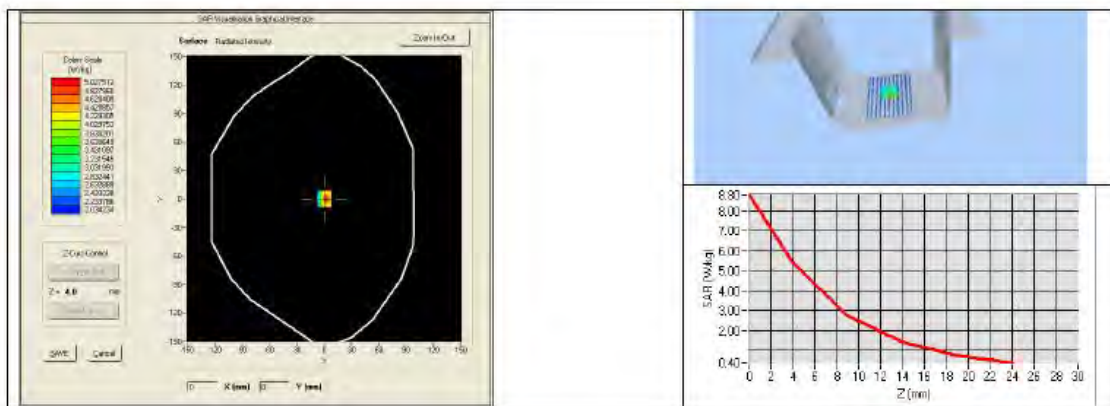



SAR REFERENCE DIPOLE CALIBRATION REPORT

Ref. ACR.139.9.15.SATU.A

8 LIST OF EQUIPMENT

Equipment Summary Sheet				
Equipment Description	Manufacturer / Model	Identification No.	Current Calibration Date	Next Calibration Date
SAM Phantom	MVG	SN-20/09-SAM71	Validated. No cal required.	Validated. No cal required.
COMOSAR Test Bench	Version 3	NA	Validated. No cal required.	Validated. No cal required.
Network Analyzer	Rhode & Schwarz ZVA	SN100132	02/2013	02/2016
Calipers	Carrera	CALIPER-01	12/2013	12/2016
Reference Probe	MVG	EPG122 SN 18/11	10/2014	10/2015
Multimeter	Keithley 2000	1188656	12/2013	12/2016
Signal Generator	Agilent E4438C	MY49070581	12/2013	12/2016
Amplifier	Aethercomm	SN 046	Characterized prior to test. No cal required.	Characterized prior to test. No cal required.
Power Meter	HP E4418A	US38261498	12/2013	12/2016
Power Sensor	HP ECP-E26A	US37181460	12/2013	12/2016
Directional Coupler	Narda 4216-20	01386	Characterized prior to test. No cal required.	Characterized prior to test. No cal required.
Temperature and Humidity Sensor	Control Company	11-661-9	8/2012	8/2015



SAR Reference Waveguide Calibration Report

Ref: ACR.139.11.15.SATU.A

NTEK TESTING TECHNOLOGY CO., LTD.
BUILDING E, FENDA SCIENCE PARK, SANWEI
COMMUNITY, XIXIANG STREET,
BAO'AN DISTRICT, SHENZHEN GUANGDONG, CHINA
MVG COMOSAR REFERENCE WAVEGUIDE
FREQUENCY: 5000-6000 MHZ
SERIAL NO.: SN 13/14 WGA 33

Calibrated at MVG US
2105 Barrett Park Dr. - Kennesaw, GA 30144



04/06/2015

Summary:

This document presents the method and results from an accredited SAR reference waveguide calibration performed in MVG USA using the COMOSAR test bench. All calibration results are traceable to national metrology institutions.



SAR REFERENCE WAVEGUIDE CALIBRATION REPORT

Ref: ACR.139.11.15.SATU.A

	<i>Name</i>	<i>Function</i>	<i>Date</i>	<i>Signature</i>
<i>Prepared by :</i>	Jérôme LUC	Product Manager	5/19/2015	<i>JL</i>
<i>Checked by :</i>	Jérôme LUC	Product Manager	5/19/2015	<i>JL</i>
<i>Approved by :</i>	Kim RUTKOWSKI	Quality Manager	5/19/2015	<i>Kim Rutkowski</i>

	<i>Customer Name</i>
<i>Distribution :</i>	NTEK TESTING TECHNOLOGY CO., LTD.

<i>Issue</i>	<i>Date</i>	<i>Modifications</i>
A	5/19/2015	Initial release



TABLE OF CONTENTS

1	Introduction.....	4
2	Device Under Test	4
3	Product Description	4
3.1	General Information	4
4	Measurement Method	4
4.1	Return Loss Requirements	4
4.2	Mechanical Requirements	4
5	Measurement Uncertainty	5
5.1	Return Loss	5
5.2	Dimension Measurement	5
5.3	Validation Measurement	5
6	Calibration Measurement Results	5
6.1	Return Loss	5
6.2	Mechanical Dimensions	6
7	Validation measurement	7
7.1	Head Liquid Measurement	7
7.2	Measurement Result	7
7.3	Body Measurement Result	10
8	List of Equipment	13



SAR REFERENCE WAVEGUIDE CALIBRATION REPORT

Ref: ACR.139.11.15.SATU.A

1 INTRODUCTION

This document contains a summary of the requirements set forth by the IEEE 1528 and CEI/IEC 62209 standards for reference waveguides used for SAR measurement system validations and the measurements that were performed to verify that the product complies with the fore mentioned standards.

2 DEVICE UNDER TEST

Device Under Test	
Device Type	COMOSAR 5000-6000 MHz REFERENCE WAVEGUIDE
Manufacturer	MVG
Model	SWG5500
Serial Number	SN 13/14 WGA 33
Product Condition (new / used)	New

A yearly calibration interval is recommended.

3 PRODUCT DESCRIPTION

3.1 GENERAL INFORMATION

MVG’s COMOSAR Validation Waveguides are built in accordance to the IEEE 1528 and CEI/IEC 62209 standards.

4 MEASUREMENT METHOD

The IEEE 1528 and CEI/IEC 62209 standards provide requirements for reference waveguides used for system validation measurements. The following measurements were performed to verify that the product complies with the fore mentioned standards.

4.1 RETURN LOSS REQUIREMENTS

The waveguide used for SAR system validation measurements and checks must have a return loss of -8 dB or better. The return loss measurement shall be performed with matching layer placed in the open end of the waveguide, with the waveguide and matching layer in direct contact with the phantom shell as outlined in the fore mentioned standards.

4.2 MECHANICAL REQUIREMENTS

The IEEE 1528 and CEI/IEC 62209 standards specify the mechanical dimensions of the validation waveguide, the specified dimensions are as shown in Section 6.2. Figure 1 shows how the dimensions relate to the physical construction of the waveguide.



SAR REFERENCE WAVEGUIDE CALIBRATION REPORT

Ref: ACR.139.11.15.SATU.A

5 MEASUREMENT UNCERTAINTY

All uncertainties listed below represent an expanded uncertainty expressed at approximately the 95% confidence level using a coverage factor of k=2, traceable to the Internationally Accepted Guides to Measurement Uncertainty.

5.1 RETURN LOSS

The following uncertainties apply to the return loss measurement:

Frequency band	Expanded Uncertainty on Return Loss
400-6000MHz	0.1 dB

5.2 DIMENSION MEASUREMENT

The following uncertainties apply to the dimension measurements:

Length (mm)	Expanded Uncertainty on Length
3 - 300	0.05 mm

5.3 VALIDATION MEASUREMENT

The guidelines outlined in the IEEE 1528 and CEI/IEC 62209 standards were followed to generate the measurement uncertainty for validation measurements.

Scan Volume	Expanded Uncertainty
1 g	20.3 %
10 g	20.1 %

6 CALIBRATION MEASUREMENT RESULTS

6.1 RETURN LOSS IN HEAD LIQUID

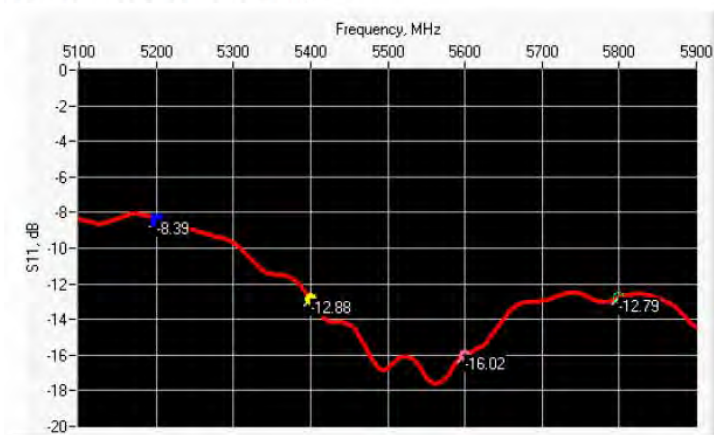



SAR REFERENCE WAVEGUIDE CALIBRATION REPORT

Ref: ACR.139.11.15.SATU.A

Frequency (MHz)	Return Loss (dB)	Requirement (dB)	Impedance
5200	-8.39	-8	19.30 Ω + 15.12 jΩ
5400	-12.88	-8	70.60 Ω + 6.57 jΩ
5600	-16.02	-8	34.64 Ω - 1.46 jΩ
5800	-12.79	-8	55.89 Ω + 21.44 jΩ

6.2 RETURN LOSS IN BODY LIQUID

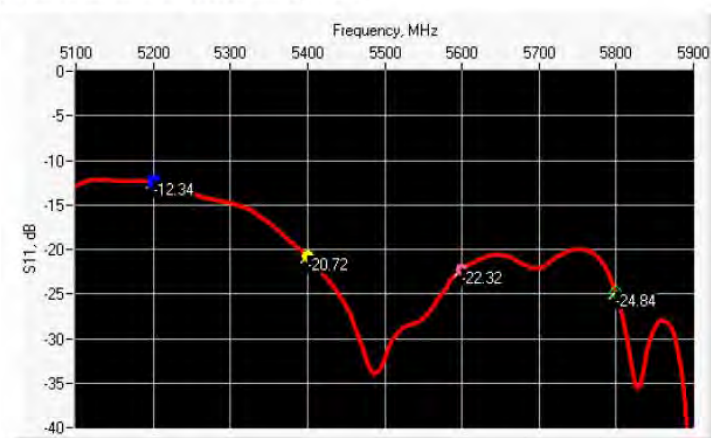

Frequency (MHz)	Return Loss (dB)	Requirement (dB)	Impedance
5200	-12.34	-8	28.10 Ω + 6.80 jΩ
5400	-20.72	-8	54.65 Ω + 7.88 jΩ
5600	-22.32	-8	45.52 Ω + 6.18 jΩ
5800	-24.84	-8	53.64 Ω + 4.41 jΩ

6.3 MECHANICAL DIMENSIONS

Frequency (MHz)	L (mm)		W (mm)		L _f (mm)		W _f (mm)		T (mm)	
	Requirement	Measured	Requirement	Measured	Requirement	Measured	Requirement	Measured	Requirement	Measured
5200	40.39 ± 0.13	PASS	20.19 ± 0.13	PASS	81.03 ± 0.13	PASS	61.98 ± 0.13	PASS	5.3*	PASS
5800	40.39 ± 0.13	PASS	20.19 ± 0.13	PASS	81.03 ± 0.13	PASS	61.98 ± 0.13	PASS	4.3*	PASS

* The tolerance for the matching layer is included in the return loss measurement.

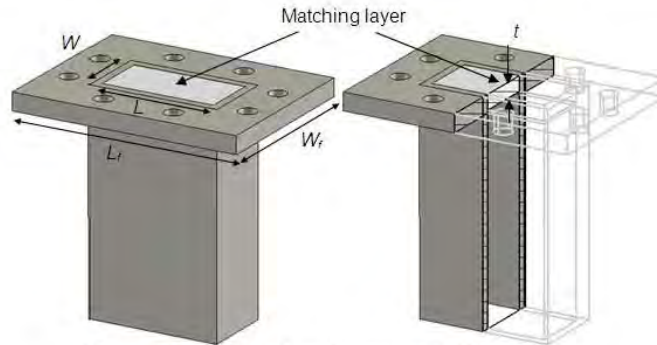

Figure 1: Validation Waveguide Dimensions

7 VALIDATION MEASUREMENT

The IEEE Std. 1528 and CEI/IEC 62209 standards state that the system validation measurements must be performed using a reference waveguide meeting the fore mentioned return loss and mechanical dimension requirements. The validation measurement must be performed with the matching layer placed in the open end of the waveguide, with the waveguide and matching layer in direct contact with the phantom shell.

7.1 HEAD LIQUID MEASUREMENT

Frequency MHz	Relative permittivity (ϵ_r')		Conductivity (σ) S/m	
	required	measured	required	measured
5000	36.2 ±10 %		4.45 ±10 %	
5100	36.1 ±10 %		4.56 ±10 %	
5200	36.0 ±10 %	PASS	4.66 ±10 %	PASS
5300	35.9 ±10 %		4.76 ±10 %	
5400	35.8 ±10 %	PASS	4.86 ±10 %	PASS
5500	35.6 ±10 %		4.97 ±10 %	
5600	35.5 ±10 %	PASS	5.07 ±10 %	PASS
5700	35.4 ±10 %		5.17 ±10 %	
5800	35.3 ±10 %	PASS	5.27 ±10 %	PASS
5900	35.2 ±10 %		5.38 ±10 %	
6000	35.1 ±10 %		5.48 ±10 %	

7.2 SAR MEASUREMENT RESULT WITH HEAD LIQUID

At those frequencies, the target SAR value can not be generic. Hereunder is the target SAR value defined by MVG, within the uncertainty for the system validation. All SAR values are normalized to 1 W net power. In bracket, the measured SAR is given with the used input power.



SAR REFERENCE WAVEGUIDE CALIBRATION REPORT

Ref: ACR.139.11.15.SATU.A

Software	OPENSAR V4
Phantom	SN 20/09 SAM71
Probe	SN 18/11 EPG122
Liquid	Head Liquid Values 5200 MHz: eps' :36.44 sigma : 4.79 Head Liquid Values 5400 MHz: eps' :35.99 sigma : 4.91 Head Liquid Values 5600 MHz: eps' :35.22 sigma : 5.18 Head Liquid Values 5800 MHz: eps' :34.95 sigma : 5.42
Distance between dipole waveguide and liquid	0 mm
Area scan resolution	dx=8mm/dy=8mm
Zoon Scan Resolution	dx=4mm/dy=4m/dz=2mm
Frequency	5200 MHz 5400 MHz 5600 MHz 5800 MHz
Input power	20 dBm
Liquid Temperature	21 °C
Lab Temperature	21 °C
Lab Humidity	45 %

Frequency (MHz)	1 g SAR (W/kg)		10 g SAR (W/kg)	
	required	measured	required	measured
5200	159.00	155.40 (15.54)	56.90	54.22 (5.42)
5400	166.40	161.85 (16.18)	58.43	55.86 (5.59)
5600	173.80	170.22 (17.02)	59.97	58.11 (5.81)
5800	181.20	178.96 (17.90)	61.50	60.45 (6.05)

SAR MEASUREMENT PLOTS @ 5200 MHz

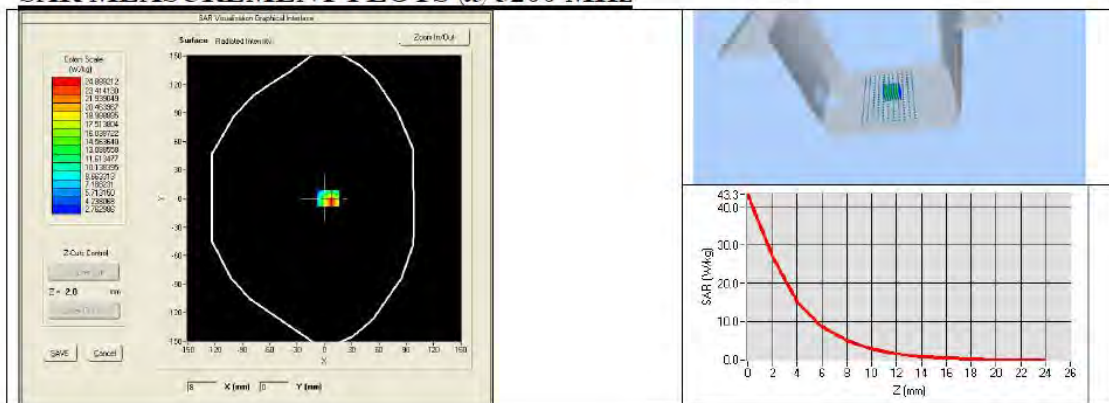



SAR REFERENCE WAVEGUIDE CALIBRATION REPORT

Ref: ACR 139.11.15.SATU.A

SAR MEASUREMENT PLOTS @ 5400 MHz

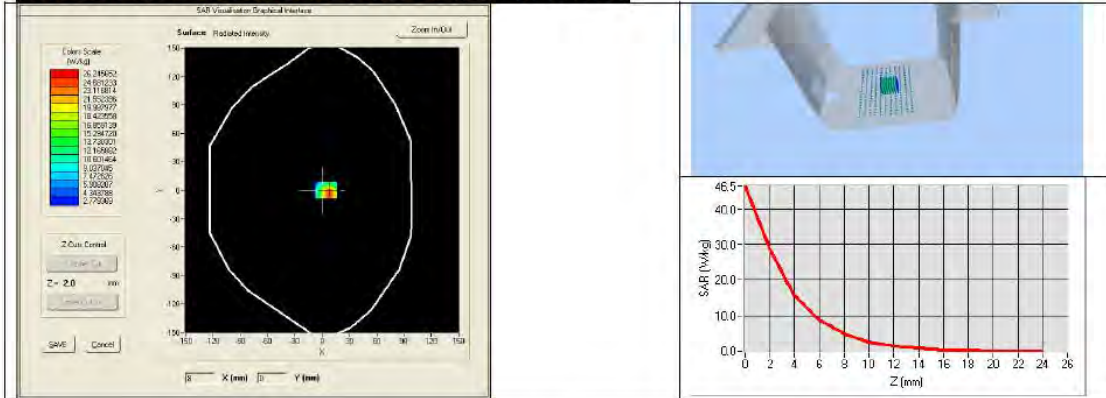

SAR MEASUREMENT PLOTS @ 5600 MHz

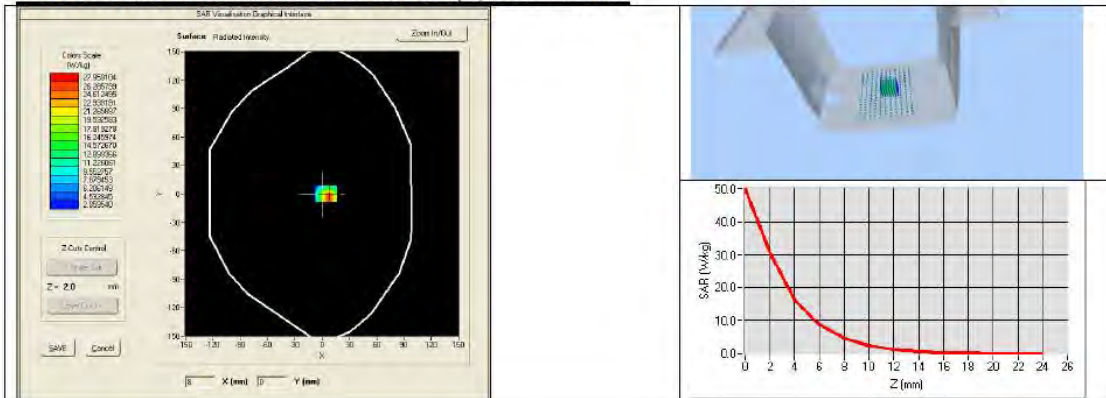

SAR MEASUREMENT PLOTS @ 5800 MHz

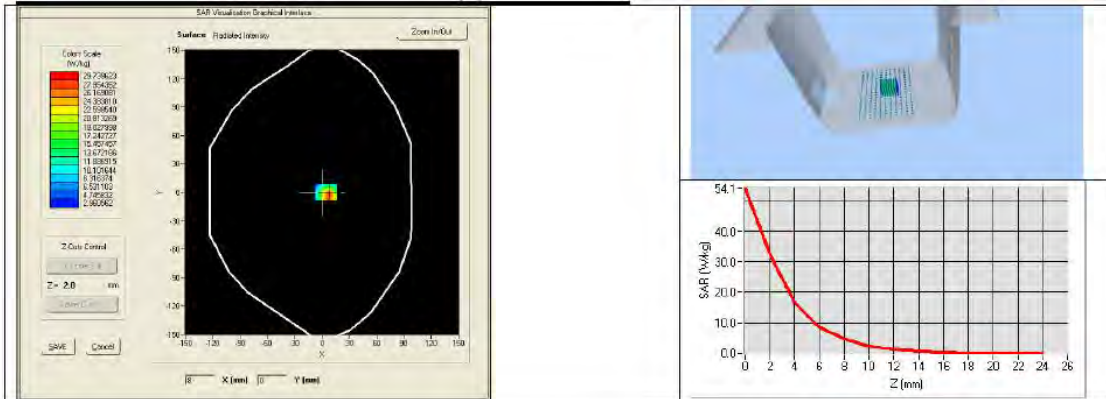



SAR REFERENCE WAVEGUIDE CALIBRATION REPORT

Ref: ACR.139.11.15.SATU.A

7.3 BODY LIQUID MEASUREMENT

Frequency MHz	Relative permittivity (ϵ_r')		Conductivity (σ) S/m	
	required	measured	required	measured
5200	49.0 ±10 %	PASS	5.30 ±10 %	PASS
5300	48.9 ±10 %		5.42 ±10 %	
5400	48.7 ±10 %	PASS	5.53 ±10 %	PASS
5500	48.6 ±10 %		5.65 ±10 %	
5600	48.5 ±10 %	PASS	5.77 ±10 %	PASS
5800	48.2 ±10 %	PASS	6.00 ±10 %	PASS

7.4 SAR MEASUREMENT RESULT WITH BODY LIQUID

Software	OPENSAR V4
Phantom	SN 20/09 SAM71
Probe	SN 18/11 EPG122
Liquid	Body Liquid Values 5200 MHz: ϵ_r' :50.70 sigma : 5.11 Body Liquid Values 5400 MHz: ϵ_r' :50.01 sigma : 5.64 Body Liquid Values 5600 MHz: ϵ_r' :49.34 sigma : 5.85 Body Liquid Values 5800 MHz: ϵ_r' :48.54 sigma : 6.22
Distance between dipole waveguide and liquid	0 mm
Area scan resolution	dx=8mm/dy=8mm
Zoon Scan Resolution	dx=4mm/dy=4m/dz=2mm
Frequency	5200 MHz 5400 MHz 5600 MHz 5800 MHz
Input power	20 dBm
Liquid Temperature	21 °C
Lab Temperature	21 °C
Lab Humidity	45 %

Frequency (MHz)	1 g SAR (W/kg) measured	10 g SAR (W/kg) measured
5200	150.06 (15.01)	53.20 (5.32)
5400	160.86 (16.09)	56.15 (5.61)
5600	165.84 (16.58)	57.05 (5.70)
5800	173.64 (17.36)	59.29 (5.93)



SAR REFERENCE WAVEGUIDE CALIBRATION REPORT

Ref: ACR.139.11.15.SATU.A

BODY SAR MEASUREMENT PLOTS @ 5200 MHz

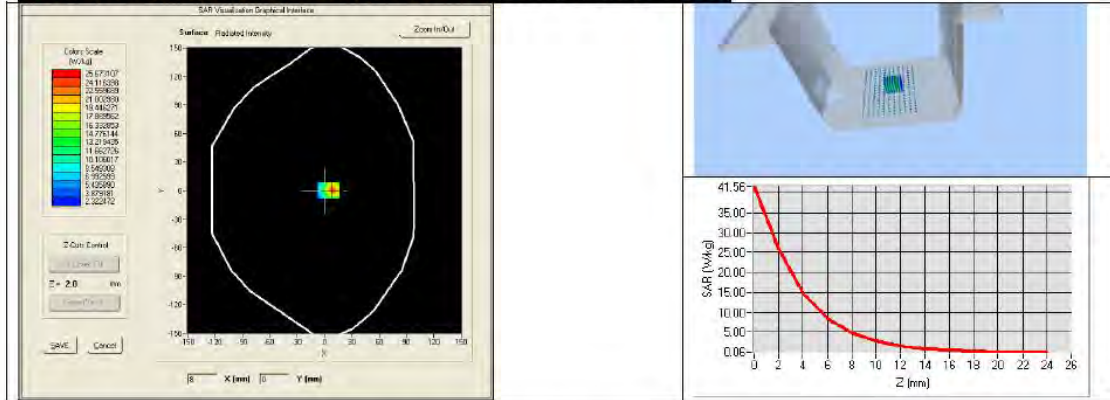

BODY SAR MEASUREMENT PLOTS @ 5400 MHz

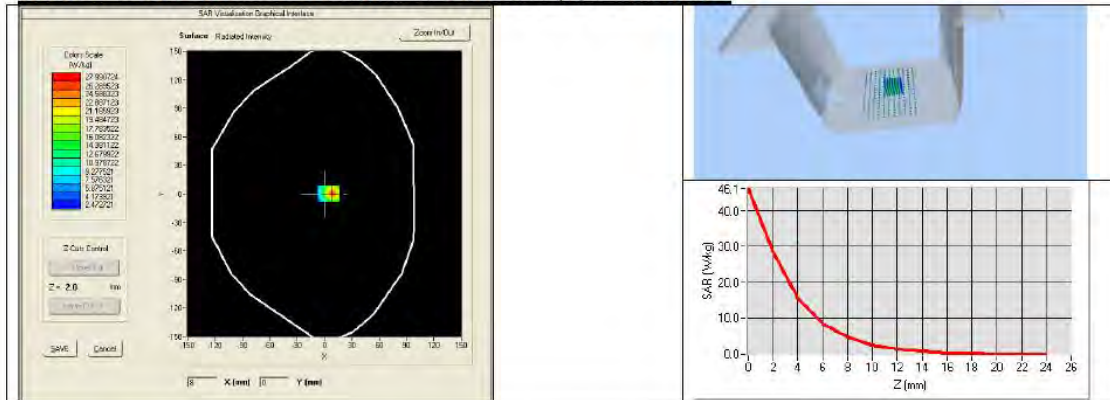

BODY SAR MEASUREMENT PLOTS @ 5600 MHz

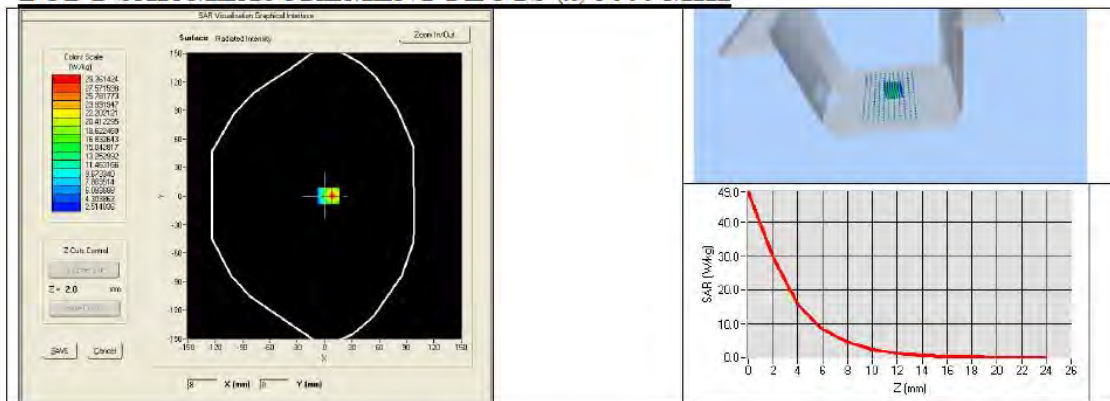



SAR REFERENCE WAVEGUIDE CALIBRATION REPORT

Ref: ACR.139.11.15.SATU.A

BODY SAR MEASUREMENT PLOTS @ 5800 MHz

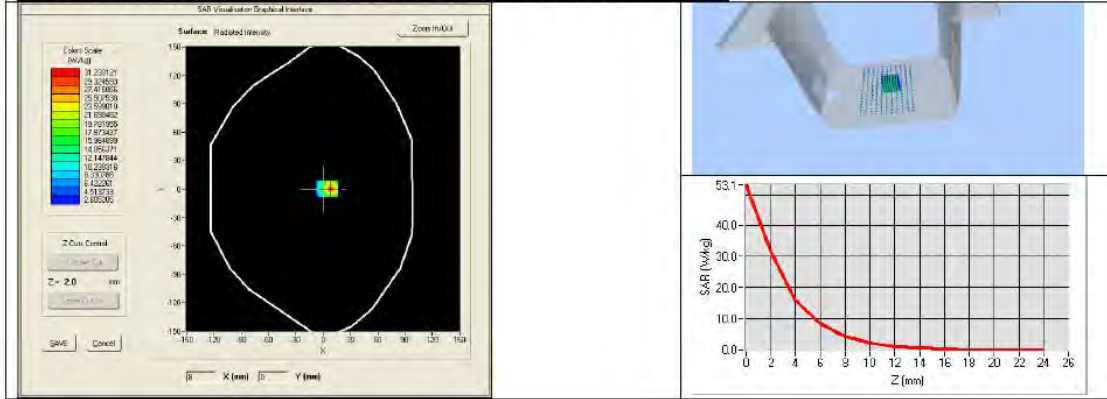



8 LIST OF EQUIPMENT

Equipment Summary Sheet				
Equipment Description	Manufacturer / Model	Identification No.	Current Calibration Date	Next Calibration Date
Flat Phantom	MVG	SN-20/09-SAM71	Validated. No cal required.	Validated. No cal required.
COMOSAR Test Bench	Version 3	NA	Validated. No cal required.	Validated. No cal required.
Network Analyzer	Rhode & Schwarz ZVA	SN100132	02/2013	02/2016
Calipers	Carrera	CALIPER-01	12/2013	12/2016
Reference Probe	MVG	EPG122 SN 18/11	10/2014	10/2015
Multimeter	Keithley 2000	1188656	12/2013	12/2016
Signal Generator	Agilent E4438C	MY49070581	12/2013	12/2016
Amplifier	Aethercomm	SN 046	Characterized prior to test. No cal required.	Characterized prior to test. No cal required.
Power Meter	HP E4418A	US38261498	12/2013	12/2016
Power Sensor	HP ECP-E26A	US37181460	12/2013	12/2016
Directional Coupler	Narda 4216-20	01386	Characterized prior to test. No cal required.	Characterized prior to test. No cal required.
Temperature and Humidity Sensor	Control Company	11-661-9	8/2012	8/2015

<Justification of the extended calibration>

If dipoles are verified in return loss(<-20dB, within 20% of prior calibration for below 3GHz, and <-8dB, within 20% of prior calibration for 5GHz to 6GHz),and in impedance (within 5 ohm of prior calibration), the annual calibration is not necessary and the calibration interval can be extended.

<Body 2450MHz>

Return Loss (dB)	Delta (%)	Impedance	Delta(ohm)	Date of Measurement
-30.51	-	52.2	-	Apr. 06, 2015
-30.498	0.039	52.16	0.04	Apr. 05, 2016

The return loss is <-20dB, within 20% of prior calibration; the impedance is within 5 ohm of prior calibration. Therefore the verification result should support extended calibration.

Dipole Verification Data

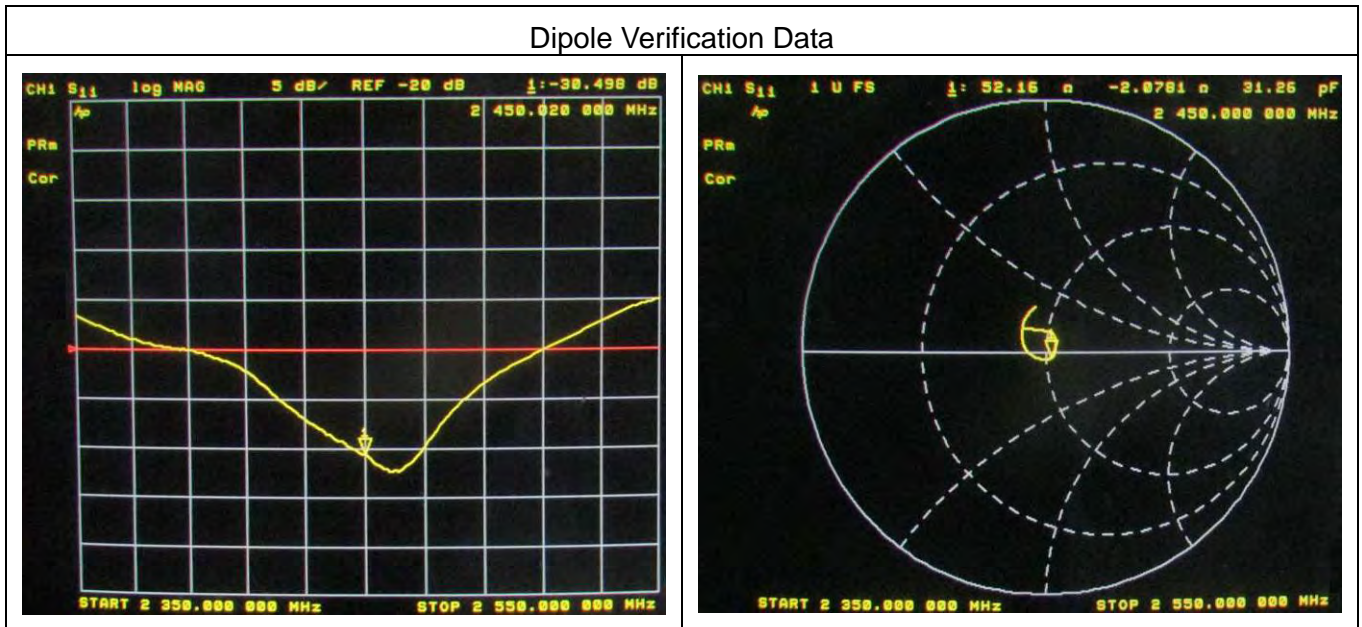

<Body 5200MHz>

Return Loss (dB)	Delta (%)	Impedance	Delta(ohm)	Date of Measurement
-12.34	-	28.1	-	Apr. 06, 2015
-12.379	0.316	28.389	0.289	Apr. 05, 2016

The return loss is <-8dB, within 20% of prior calibration; the impedance is within 5 ohm of prior calibration. Therefore the verification result should support extended calibration.

Dipole Verification Data

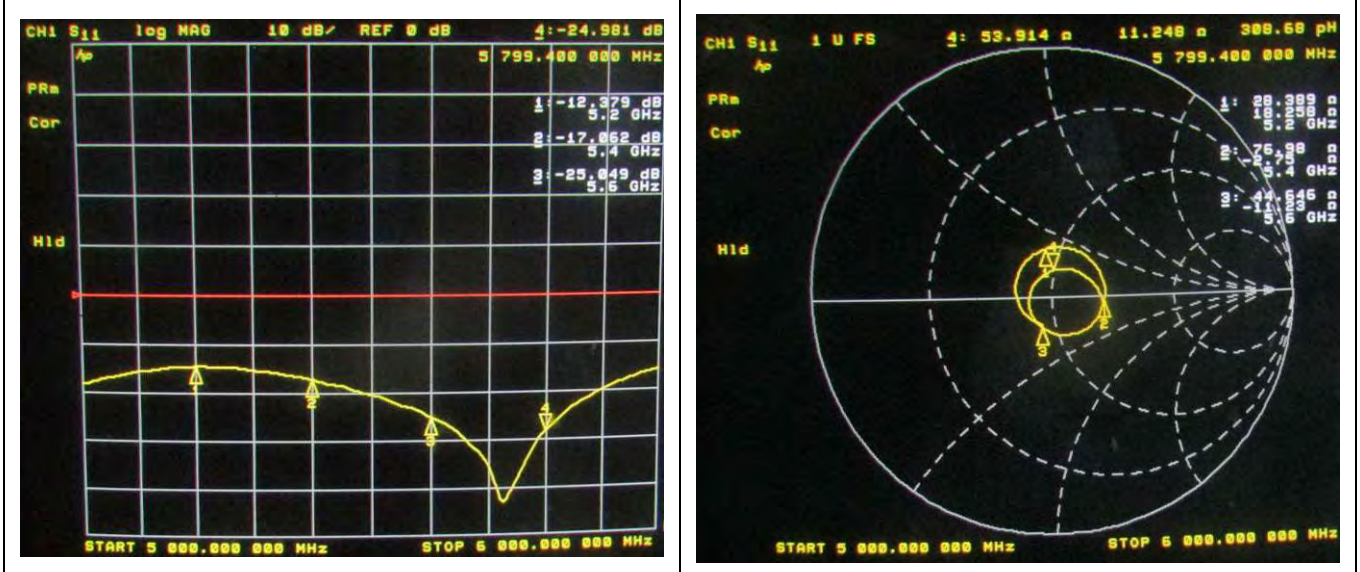

<Body 5800MHz>

Return Loss (dB)	Delta (%)	Impedance	Delta(ohm)	Date of Measurement
-24.84	-	53.64	-	Apr. 06, 2015
-24.981	0.568	53.914	0.274	Apr. 05, 2016

The return loss is <-8dB, within 20% of prior calibration; the impedance is within 5 ohm of prior calibration. Therefore the verification result should support extended calibration.

Dipole Verification Data

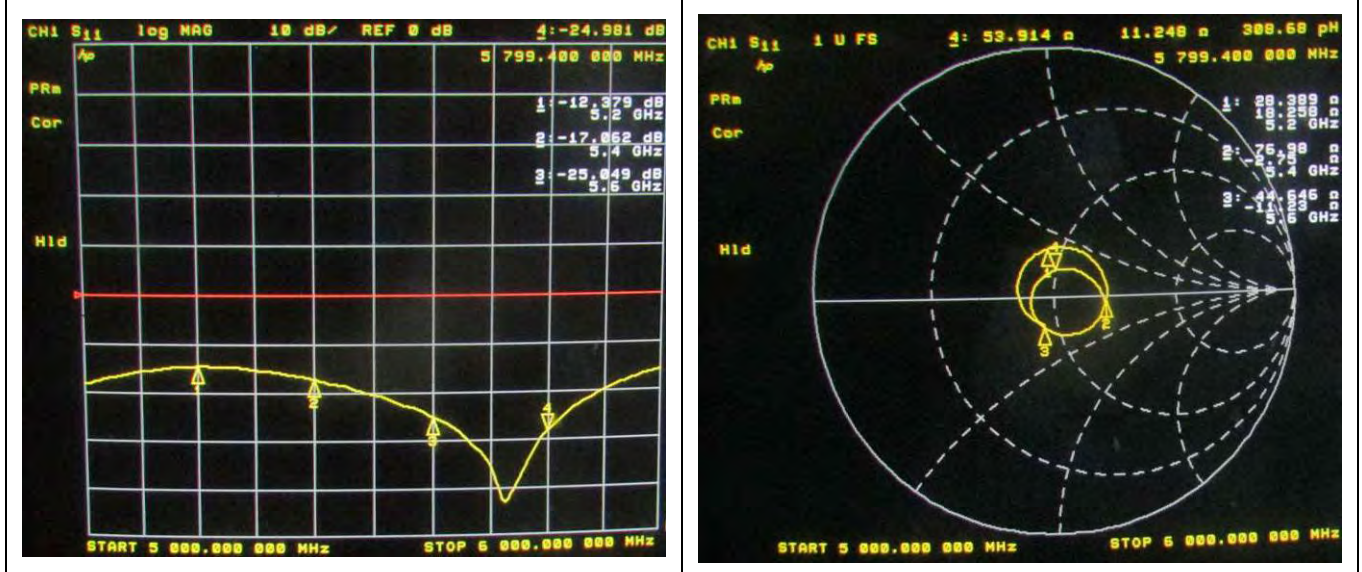

END