

AIT2000 Installation & Operation Manual



Table of Contents

1	NOTICES	4
1.1	Safety Warnings.....	4
1.2	Position source	4
1.3	Compass safe distance.....	4
1.4	RF emissions notice	4
1.5	Warranty.....	5
1.6	Disposal of this product and packaging.....	5
1.8	Declaration of conformity	5
1.9	FCC notice.....	5
1.10	Industry Canada notice.....	6
2	ABOUT YOUR AIS CLASS B TRANSPONDER	7
2.1	About AIS	7
2.2	Static and dynamic vessel data.....	7
2.3	Important information for US customers.....	8
3	WHAT'S IN THE BOX ?.....	9
3.1	Digital Yacht Software and Driver CD	9
3.2	GPS Antenna	9
3.3	Power/Data and USB Cables.....	10
3.4	Electrical Connections	10
4	INSTALLATION.....	11
4.1	Preparing for Installation.....	11
4.2	Optional "Silent" switch	12
4.3	VHF antenna cable.....	12
4.4	Power and data cable	13
4.5	Chart plotter	13
4.6	Connection to a PC or Mac	13
5	INSTALLATION PROCEDURES.....	14
5.1	Installing the AIS transponder	14
5.2	Installing the external GPS antenna	15
5.3	Connecting to the VHF antenna	15
5.4	Connecting the Power/Data cable.....	15
5.5	Connecting a "Silent" switch (optional).....	16
5.6	Connecting to NMEA0183 compatible equipment	16
5.7	Connection to an NMEA2000 network (optional).....	18

5.8	USB Connection (optional)	18
5.9	Connecting to a power supply	19
6	CONFIGURING YOUR AIS TRANSPONDER	20
6.1	Plugging the AIT2000 in to a Windows PC	20
6.2	Plugging the AIT2000 in to a Mac	21
7	OPERATION	25
7.1	Switch functions	25
7.2	Indicator functions	25
8	TROUBLESHOOTING	27
9	SPECIFICATIONS	28

1 NOTICES



When reading this manual please pay attention to warnings marked with the warning triangle shown on the left. These are important messages for safety, installation and usage of the product.

1.1 Safety Warnings



This equipment must be installed in accordance with the instructions provided in this manual. DO NOT install the equipment in a flammable atmosphere such as in an engine room or near to fuel tanks.



The Digital Yacht AIT2000 is an aid to navigation and must not be relied upon to provide accurate navigation information. AIS is not a replacement for vigilant human lookouts and other navigation aids such as Radar. The performance of the AIT2000 may be seriously impaired if not installed as instructed in the user manual, or due to other factors such as weather and or nearby transmitting devices. Compatibility with other systems is reliant on third party systems recognising the standard outputs from the AIT2000. Digital Yacht reserves the right to update and change these specifications at any time and without notice.

1.2 Position source

All marine Automatic Identification System (AIS) transponders utilise a satellite based location system such as the Global Positioning Satellite (GPS) network. The accuracy of a GPS position fix is variable and is affected by factors such as the antenna positioning, how many satellites are used to determine a position and how long satellite information has been received for.

1.3 Compass safe distance

The compass safe distance of this unit is 0.5m or greater for 0.3° deviation. We suggest you always mount the unit 1m away from any compass and check for any localised interference

1.4 RF emissions notice

Caution: The AIS transponder generates and radiates radio frequency electromagnetic energy. This equipment must be installed and operated according to the instructions contained in this manual. Failure to do so can result in personal injury and / or AIS transponder malfunction. Caution: Never operate the AIS transponder unless it is connected to a VHF antenna.

To maximise performance and minimise human exposure to radio frequency electromagnetic energy you must make sure that the antenna is mounted at least 1.5 metres away from the AIS transponder and is connected to the AIS transponder before power is applied. The system has a Maximum Permissible Exposure (MPE) radius of 1.5m. This has been determined assuming the maximum power of the AIS transponder and using antennas with a maximum gain of 3dBi. The antenna should be mounted 3.5m above the deck in order to meet RF exposure requirements. Higher gain antennas will require a greater MPE radius. Do not operate the unit when anyone is within the MPE radius of the antenna (unless they are shielded from the antenna field by a grounded metallic barrier). The antenna should not be co-located or operated in conjunction with any other transmitting antenna. The required antenna impedance is 50 Ohms.

1.5 Warranty

The AIT2000 is supplied with a standard 2 year return to base warranty as defined in the accompanying warranty information. Any attempt to tamper with or damage this product will invalidate the warranty. Physical damage and damage caused by salt water ingress are not covered under this warranty.

1.6 Disposal of this product and packaging

Please dispose of the AIS transponder in accordance with the European WEEE Directive or with the applicable local regulations for disposal of electrical equipment. Every effort has been made to ensure the packaging for this product is recyclable. Please dispose of the packaging in an environmentally friendly manner.

1.7 Accuracy of this manual

The AIS transponder may be upgraded from time to time and future versions of the AIS transponder may therefore not correspond exactly with this manual. Information contained in this manual is liable to change without notice. The manufacturer of this product disclaims any liability for consequences arising from omissions or inaccuracies in this manual and any other documentation provided with this product.

1.8 Declaration of conformity

Digital Yacht declare that this product is in compliance with the essential requirements and other provisions of the R&TTE directive 1995/5/EC.

The product carries the CE mark, notified body number and alert symbol as required by the R&TTE directive.

The AIT2000 is intended for sale in the following member states: United Kingdom, France, Spain, Sweden, Austria, Netherlands, Portugal, Denmark, Norway, Belgium, Italy, Finland, Ireland, Luxembourg, Germany and Czech Rep.

1.9 FCC notice

This equipment has been tested and found to comply with the limits for a class B digital device, pursuant to part 15 of the FCC Rules. These limits are designed to provide reasonable protection against harmful interference in a residential installation.

This equipment generates, uses and can radiate radio frequency energy and, if not installed and used in accordance with the instructions, may cause harmful interference to radio communications.

This device complies with part 15 of the FCC Rules. Operation is subject to the following two conditions: (1) This device may not cause harmful interference, and (2) this device must accept any interference received, including interference that may cause undesired operation.

Changes or modifications not expressly approved by the party responsible for compliance could void the user's authority to operate the equipment.



WARNING: It is a violation of the rules of the Federal Communications Commission to input an MMSI that has not been properly assigned to the end user, or to otherwise input any inaccurate data in this device.

1.10 Industry Canada notice

This device complies with Industry Canada licence-exempt RSS standard(s). Operation is subject to the following two conditions:

1. This device may not cause interference, and
2. This device must accept any interference, including interference that may cause undesired operation of the device.

This Class B digital apparatus complies with Canadian ICES-003.

Le présent appareil est conforme aux CNR d'Industrie Canada applicables aux appareils radio exempts de licence. L'exploitation est autorisée aux deux conditions suivantes :

1. L'appareil ne doit pas produire de brouillage, et
2. L'utilisateur de l'appareil doit accepter tout brouillage radioélectrique subi, même si le brouillage est susceptible d'en compromettre le Fonctionnement.

Cet appareil numérique de la classe B est conforme à la norme NMB-003 du Canada.

2 ABOUT YOUR AIS CLASS B TRANSPONDER

2.1 About AIS

The marine Automatic Identification System (AIS) is a location and vessel information reporting system. It allows vessels equipped with AIS to automatically and dynamically share and regularly update their position, speed, course and other information such as vessel identity with similarly equipped vessels. Position is derived from the Global Positioning System (GPS) and communication between vessels is by Very High Frequency (VHF) digital transmissions.

There are a number of types of AIS device as follows:

Class A transponders

These are similar to class B transponders, but are designed to be fitted to large vessels such as cargo ships and large passenger vessels. Class A transponders transmit at a higher VHF signal power than class B transponders and therefore can be received by more distant vessels. They also transmit Class A transponders are mandatory on all vessels over 300 gross tonnes on international voyages and certain types of passenger vessels under SOLAS regulations.

Class B transponders

Similar to class A transponders in many ways, but are normally lower cost due to the less stringent performance requirements. Class B transponders transmit at a lower power and at a lower reporting rate than class A transponders.

AIS base stations

AIS base stations are used by Vessel Traffic Systems to monitor and control the transmissions of AIS transponders.

Aids to Navigation (AtoN) transponders

AtoNs are transponders mounted on buoys or other hazards to shipping which transmit details of their location to the surrounding vessels.

AIS receivers

AIS receivers will generally receive transmissions from class A transponders, class B transponders, AtoNs and AIS base stations but do not transmit any information about the vessel on which they are installed.

This product is an AIS Class B transponder.

2.2 Static and dynamic vessel data

There are two categories of information transmitted by an AIS transponder: static and dynamic data.

The vessel's dynamic data, which includes location, speed over ground (SOG) and course over ground (COG), is calculated automatically using the internal GPS receiver.

Static data is information about the vessel which must be programmed into the AIS transponder. This includes:

- Maritime Mobile Service Identity (MMSI)

- Vessel name
- Vessel call sign (if available)
- Vessel type
- Vessel dimensions

In most countries the operation of an AIS transponder is included under the vessel's marine VHF licence provisions. The vessel on to which the AIS unit is to be installed must therefore possess a current VHF radiotelephone licence which lists the AIS system, vessel Call Sign and MMSI number.



An MMSI number is required in order for the AIS transceiver to operate. Please contact the relevant authority in your country for more information.

2.3 Important information for US customers

There are specific laws in the USA regarding the configuration of AIS class B transponders.

If you are a US resident and intend to use your AIS class B transponder in US waters, you should make sure that your retailer has configured your product prior to supplying it to you. If your AIS transponder has not been pre-configured please contact your dealer for details of how to have it configured.

3 WHAT'S IN THE BOX ?

These items are included with your AIS transponder purchase.

- ***AIT2000 Transponder (with integrated connections for power, NMEA and USB)***
- ***GPS ANTENNA***
- ***QUICK START GUIDE***
- ***DIGITAL YACHT SOFTWARE AND DRIVER CD***

The following sections give a brief overview of each item. Please ensure all items are present and if any of the items are not present contact your dealer.

3.1 Digital Yacht Software and Driver CD

The CD supplied with the package contains the following:

- proAIS2 software tool necessary to configure the AIS transponder. Two versions of the program are on the CD, one for PCs running Windows and one for Macs running OSX (Intel only). Please refer to section

- **6 CONFIGURING YOUR AIS TRANSPONDER** for details of the configuration process and how to use the proAIS2 tool. NOTE - products supplied in the USA will be pre-programmed by a dealer or competent authority.
- USB drivers required by Windows to connect to the AIS transponder via USB (installed with the proAIS 2 software). The USB drivers for Mac are already included in the OSX operating system and are automatically installed when you plug the AIT2000 USB lead in to the Mac.
- Alternative language versions of this manual.
- A Quick start guide, that gives a handy reference for installation process.
- Product manual - This document is the product manual and should be read thoroughly prior to any attempt to install or use the AIS transponder.
- SmarterTrack Lite AIS Viewing Software
- Other useful programs and utilities

3.2 GPS Antenna

The AIS transponder requires an external GPS antenna (as supplied). The supplied GPS antenna is designed to be fitted to a standard 1"×14 TPI threaded VHF pole mount, which are available in many different styles from all good marine electronic dealers and chandleries.

It is possible to use any existing GPS antenna as long as it is a passive GPS type antenna with a 3v or 5v pre-amplifier. It is not possible to connect another GPS unit to the AIT2000 via NMEA. The international Class B Transponder specification states that a transponder must have its own GPS to ensure that it can work entirely on its own without being reliant upon other external equipment.

The GPS antenna supplied with the AIT2000 comes complete with 10m of cable and is terminated in a TNC connector. The cable can be lengthened but this should be done using a suitable TNC (Male) to TNC (Female) extension cable or carried out by an experienced and qualified Marine Electronics Dealer. Any joins in the cable should be made to a professional standard suitable for the marine environment.

3.3 Power/Data and USB Cables

The integral 1 metre Power and Data cable allows power, NMEA 0183 data and an optional "Silent Switch" to be connected to the AIT2000 transponder. This twelve core cable can be extended using suitable marine grade cables. To aid installation, a table of the wire connections and colours, is printed on the AIT2000 product label.

The integral 1 metre USB cable allows a power and data connection between the AIT2000 and a computer. The AIT2000 will take enough power from the USB connection to operate as an AIS Receiver. This is useful for initial programming/configuration of the AIT2000 with your MMSI number and other vessel data, which can be done at home or in the office without the need of an additional 12v DC supply. It should be noted that the AIT2000 will not operate as a Transponder without an external power supply connected to the Red and Black Wires of the Power/Data cable.

3.4 Electrical Connections

The AIT2000 transponder has the following electrical connections:

- Power supply 12v or 24v
- Two NMEA0183 data ports for connection to chart plotters and other NMEA0183 compatible equipment
- USB for connection to a PC or Mac
- External switch input for silent mode control (on power/data cable)
- NMEA2000 port for connection to NMEA2000 compatible equipment
- In addition there are two other connections for the VHF antenna and the external GPS antenna.

Figure 1 shows the electrical connections to the AIT2000 transponder.



Figure 1

4 INSTALLATION

4.1 Preparing for Installation

Figure 2 below shows a typical installation of an AIT2000. Please take the time to familiarise yourself with the system elements and their connections prior to attempting installation.

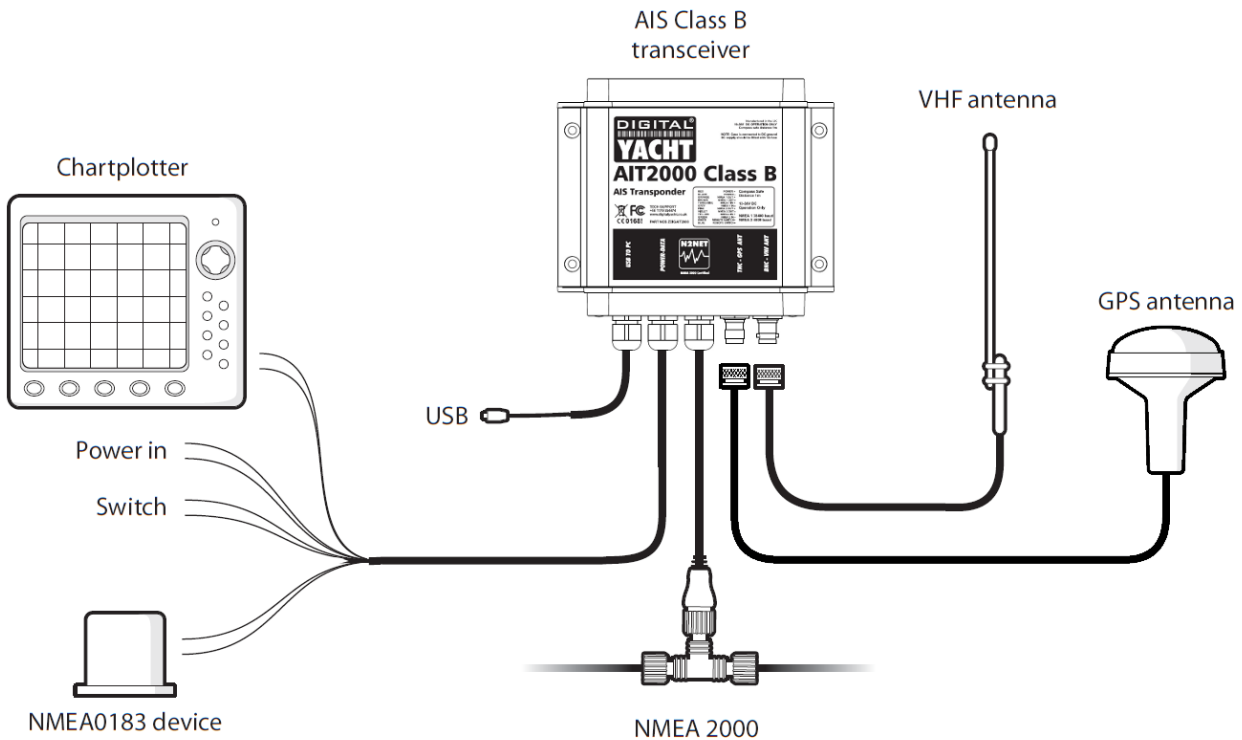

Figure 2

In addition to the items provided with your AIS transponder the following items will be required for installation:

- VHF antenna or suitable splitter if you intend to use your existing VHF antenna
- Four M4 screws or other fixings for the AIT2000 appropriate to the mounting location
- A suitable 1" x 14TPI thread mount for the GPS Antenna (not supplied)

Connection to a suitable VHF antenna will be required for the AIS transponder to operate. A standard marine band VHF antenna can be used, however, many manufacturers are now offering AIS tuned (162MHz) antennas that offer even better performance. Digital Yacht have a selection of suitable VHF antennas.



Alternatively, if you wish to use the vessel's existing VHF antenna, our SPL2000 antenna splitter product is available which allows the existing antenna to be used by the VHF voice radio and the AIT2000. On the following page Figure 3, shows a typical splitter installation diagram showing how the AIT2000 and SPL2000 should be connected to the vessel's existing VHF antenna.

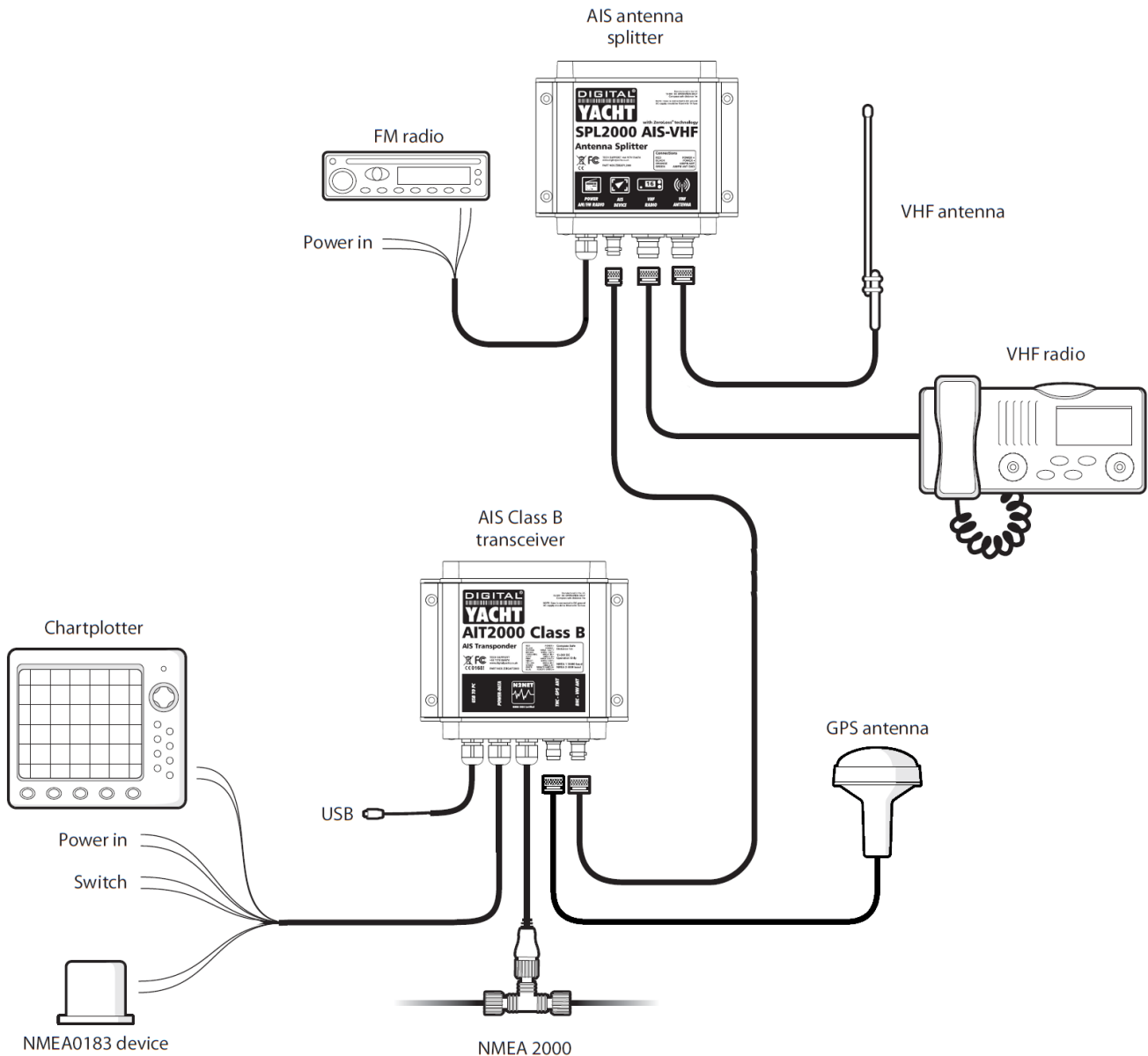

Figure 3

4.2 Optional “Silent” switch

A switch can be connected to the transponder to enable and disable 'silent mode'. A standard “Single Pole Single Throw” (SPST) toggle switch is required to use this feature. When the switch is “closed” the AIT2000 stops transmitting and when the switch is “open” the AIT2000 starts transmitting again.

4.3 VHF antenna cable

Please check that the VHF antenna you intend to use has sufficient cable to reach between the VHF antenna and the AIS transponder unit. If it is not sufficient you will need an extension cable. Please contact your dealer for details of suitable products. For reference the VHF antenna connector type on the AIS transponder unit is BNC female, and is intended to mate with a BNC male connector.

4.4 Power and data cable

The AIS transponder unit is supplied with a 1m long power and data cable integrated into the unit. If you require longer cables to reach your power supply, please ensure the cables are capable of carrying currents of up to 2A peak and 200mA on average. Means of connecting the cables together will also be required. The use of Scotchlok type connectors is recommended for this purpose.

4.5 Chart plotter

To display received AIS messages as other vessels on your chart plotter, you will need to connect your AIS transponder to your chart plotter. This is usually done via NMEA 0183 or via NMEA 2000, which are the marine industry standards for digital communication.

Please refer to the user manual supplied with your chart plotter for details of how to connect and configure your chart plotter for use with AIS devices. For NMEA 0183 data connections, your chart plotter should be configured to accept NMEA data at 38400 baud (sometimes referred to as 'NMEA HS' in the plotter configuration menu). You may also need to enable the display of AIS targets in the chart options.

Alternatively if you use an NMEA2000 network on your vessel it is possible to connect the AIS transponder to the NMEA2000 network via the integral cable. Assuming that you are connecting to an existing NMEA2000 network, you should be able to simply "plug and play" the AIT2000 in to a spare "T-piece" connector on the network.

Please refer to your dealer and to the chart plotter manual for more information on NMEA2000 networking.

4.6 Connection to a PC or Mac

If you choose to use a PC or Mac with suitable charting software to display received AIS messages as other vessels, this can be accomplished by connecting the USB cable integrated into the unit.

5 INSTALLATION PROCEDURES

It is strongly recommended that you read all of the instructions in this manual prior to installation.

If after reading this manual you are unsure about any element of the installation process please contact your dealer for advice.

The following sections explain the installation process step by step for each of the main elements of the system.

5.1 Installing the AIS transponder

Please note the following guidelines when selecting a location for your AIS transponder:

- The AIS transponder must be fitted in a location where it is at least 0.5m from a compass or any magnetic device.
- There should be adequate space around the AIS transponder for routing of cables. See drawing below for details of the AIS transponder dimensions.
- The ambient temperature around the AIS transponder should be maintained between -25°C and +55°C.
- The AIS transponder should not be located in a flammable or hazardous atmosphere such as in an engine room or near to fuel tanks.

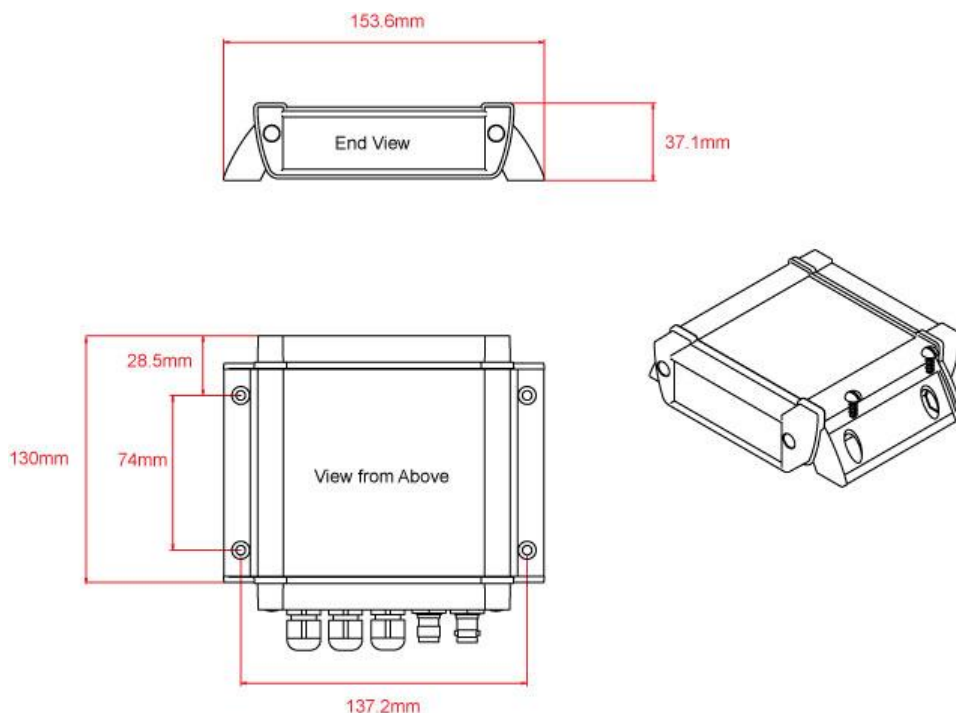

- The AIS transponder is fully waterproof to ingress protection rating IPx5, however it is recommended that the AIS transponder is not subjected to extended periods of exposure to spray or submersion.
- It is recommended that the AIS transponder is installed in a 'below decks' environment.
- It is acceptable to mount the AIS transponder either vertically or horizontally.
- Remove the green décor strips to expose 4 mounting holes to screw the unit to a suitable bulkhead or surface.
- The AIS transponder should be mounted in a location where the indicators are readily visible as these provide important information on the status of the AIS transponder.

5.2 Installing the external GPS antenna

- For mounting of the optional external GPS antenna you will require a 1" x 14 TPI thread pole, deck base or rail mount
- You should ensure the GPS antenna has a good clear view of the entire sky.
- It is not recommended that the GPS antenna is mounted up a mast where the motion of the vessel will cause the antenna to swing and potentially reduce the accuracy of the GPS position.
- Do not mount your antenna in the direct path of a radar transmitter.
- Feed the ten metre long cable attached to the GPS antenna cable through the pole and screw the antenna onto the pole mount as shown in Figure 4.
- Route the cable to your AIS transponder unit, adding any necessary extension cables.
- Connect the cable from the GPS antenna to the GPS connector on the AIS transponder



Figure 4

5.3 Connecting to the VHF antenna

Route the cable from the VHF antenna or splitter to the AIS transponder and connect to the VHF connector on the AIS transponder.

- A standard marine band VHF antenna or AIS antenna should be used with the AIS transponder. The connector type on the AIS transponder is a BNC. Your chosen VHF antenna requires a BNC male connector to mate with this. If your VHF antenna does not use this type of connector please contact your dealer for details of available adaptors.
- If you are using an antenna splitter, connect the AIS connection on the splitter to the VHF (BNC) connector on the AIT2000.
- NOTE – if you intend to use a splitter, it is important that the splitter is designed for use with a Class B Transponder. Some lower cost splitters are only designed for use with AIS receivers and will not work properly with the AIT2000.

5.4 Connecting the Power/Data cable

- The integral 1m Power/Data cable allows connection of DC power, NMEA data (two inputs and two outputs) and the remote Silent Switch. The cable is terminated inside the unit and the other end of the cable has twelve colour coded bare wires ready for connection.
- Table 1 on the following page lists the function of each colour coded wire for reference.

Wire colour	Description	Function
RED	Power in +	Power supply connections
BLACK	Power in -	
BLUE	Switch input-	External switch connection for silent mode
WHITE	Switch input+	
ORANGE	NMEA0183 port 1 TX+	High speed NMEA0183 output (38,400 baud) intended for connection to chart plotters
BROWN	NMEA0183 port 1 TX-	
TURQUOISE	NMEA0183 port 1 RX+	High speed NMEA0183 input (38,400 baud) Not normally used
GREY	NMEA0183 port 1 RX-	
PINK	NMEA0183 port 2 TX+	Low speed NMEA0183 Output (4,800baud) intended for connection to other NMEA0183 devices requiring a GPS feed. Note AIS data is not available on this output.
VIOLET	NMEA0183 port 2 TX-	
YELLOW	NMEA0183 port 2 RX+	Low speed NMEA0183 input (4,800baud) intended for connection to other NMEA0183 compatible sensors for multiplexing of data to the chart plotter
GREEN	NMEA0183 port 2 RX-	

Table 1

5.5 Connecting a “Silent” switch (optional)

A toggle switch can be connected to the AIS transponder to provide remote control of silent mode.

- Connect the toggle switch between the White(+) and Blue(-) wires as shown below. Connection of an external switch to toggle silent mode is optional and not essential for normal operation of the product.

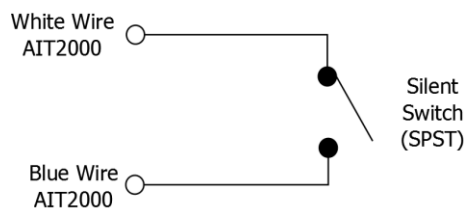

Switch Closed = Silent Mode (No Transmit)
Switch Open = Normal Mode (Transmit)

Figure 5

5.6 Connecting to NMEA0183 compatible equipment

- The AIT2000 has two independent NMEA0183 data ports which are pre-configured at the following data rates; Port 1 = 38400 baud and Port 2 = 4800 baud.
- Each port consists of a two wire Input and a two wire Output, which are colour coded as shown in Table 1.
- Connect the wires to the appropriate connections on your NMEA0183 compatible equipment. Please refer to your equipment manual for more information and pay particular attention to any menu settings that must be configured to configure and display AIS or other NMEA data.
- The high speed NMEA Output port 1 is intended primarily to connect to a chart plotter, while the low speed NMEA Input and Output of port 2 are intended to connect to other NMEA0183 devices.

- A multiplexing feature is provided, which means any messages which are received on the low speed Input 2 port are automatically transmitted on the high speed Output 1 port. This is particularly useful when using a chart plotter having only a single NMEA0183 port.
- Instrument data or additional sensors such as a gyro-compass can be connected to the AIS transponder via the low speed port and all of this data, plus the AIS and GPS data will be transmitted on the high speed Output 1 port to the chart plotter. Please ensure your equipment is configured to use the correct baud rate for the port it is connected to.
- On many vessels fitted with a modern VHF Radio that requires GPS data for the DSC functions, the low speed NMEA Output 2 can be used to give GPS data to the VHF radio. On this port are the following common NMEA 0183 GPS position sentences; GLL, GGA and RMC.
- Figure 6 below is a diagram of a typical installation showing the NMEA 0183 data connections. The Heading data (or any instrument data) received on Input 1 is multiplexed (combined) with the AIT2000's own AIS and GPS data and sent to the Chart Plotter on Output 1 (38400 baud). The GPS inside the AIT2000 is used to provide the VHF DSC radio with GPS position data on Output 2 (4800 baud).

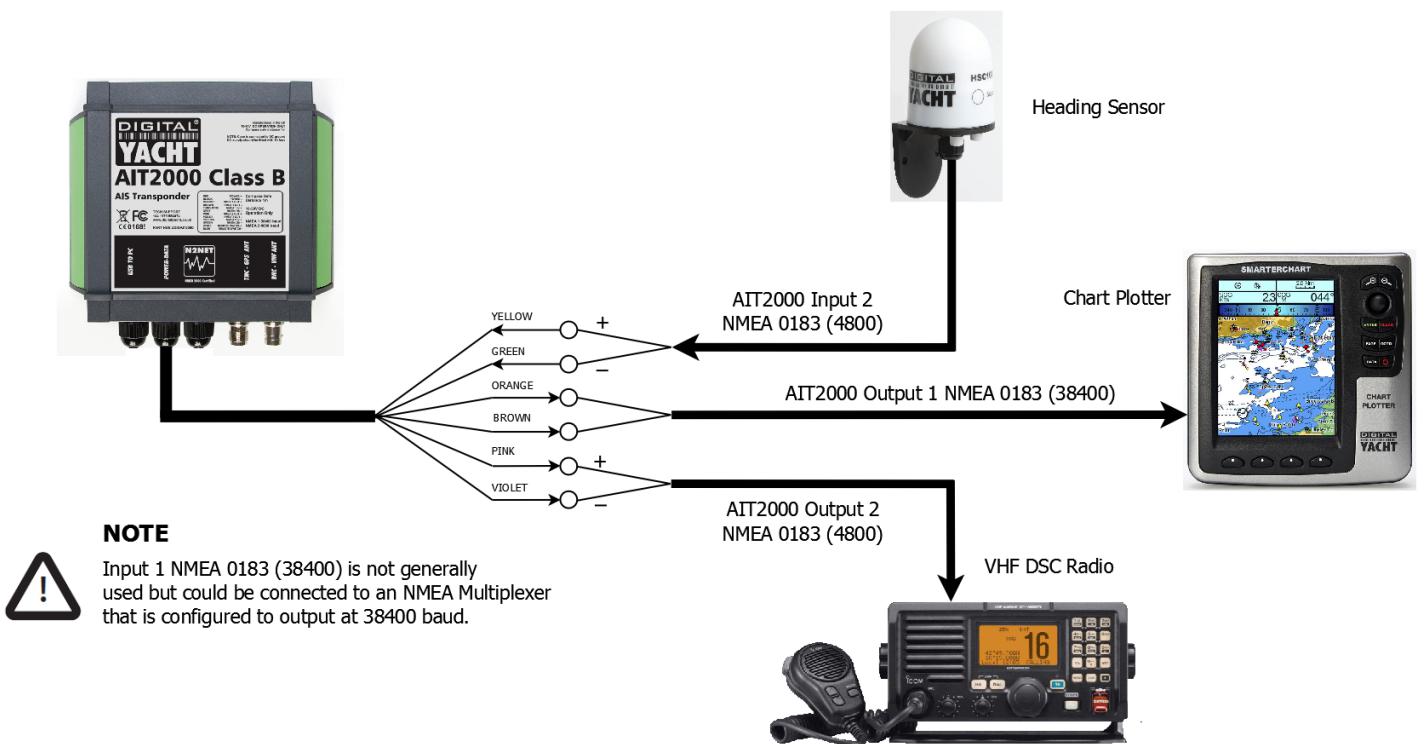

Figure 6

5.7 Connection to an NMEA2000 network (optional)

- The AIT2000 also has an N2Net connection which is Digital Yacht’s NMEA2000 compliant interface. To connect to other NMEA2000 products, simply find or add a spare NMEA2000 “T” piece on the existing NMEA2000 network and connect the receiver’s N2Net connector to the “T” piece.
- The N2Net cable is just over 1m long and is terminated in an NMEA2000 Micro Male Connector.



The AIS200N2NET does not take any power from the NMEA2000 network. The Load Equivalency Number (LEN) of the AIT2000 is 1.

- The AIT2000 only outputs AIS data on to the network, it does not output any GPS data on to the network or provide any NMEA2000 to NMEA0183 conversion.
- The list of AIS PGNs that the AIT2000 outputs is listed below in Table 2;

PGN No.	PGN Title
129038	Class A Position Report
129039	Class B Position Report
129040	Class B Extended Position Report
129793	AIS UTC and Date report
129794	AIS Class A Static and Voyage Related Data
129800	AIS UTC/Date Inquiry
129801	AIS Address Safety Message
129802	AIS Broadcast Safety Message
129810	AIS Class B static data part B
129809	AIS Class B static data part A
129041	AtoN position report

Table 2

5.8 USB Connection (optional)

The AIS transponder is supplied with a USB cable for connection to a PC or Mac. The USB connector can be connected directly to the USB port on the PC or Mac via the supplied USB cable. To enable connection of the AIS transponder to a PC the USB drivers, supplied on the product CD, must first be installed.



Driver installation is only necessary on a Windows PC as the drivers are pre-installed in the Mac operating system and automatically load when the AIT2000 is plugged in.

To install the drivers on a Windows PC please follows the steps below:

- Insert the product CD into the PC and install proAIS2 with administrator rights. At the end of the installation, you will be asked if you wish to install the drivers. Select this option.
- Once installed the AIS unit can be connected to the PC. The USB drivers will be installed automatically and the AIS will appear as a new COM port device.
- Select the AIS COM port and a baud rate of 38,400 in PC based navigation software to make use of the AIS data.

5.9 Connecting to a power supply

The AIT2000 should be connected to the ship's 12V or 24V DC power supply typically provided by the vessel's battery.

It is recommended that crimped and soldered lugs are used to connect the AIS transponder to the power source. It is recommended that the power supply is connected via a suitable circuit breaker and/or 3A fuse

- Connect the red wire to a 12V or 24V power supply positive terminal.
- Connect the black wire to the supply negative terminal.

The AIT2000 will only operate correctly as a Class B transponder when it is connected to an external supply that has a voltage greater than 9.6v. If the supply voltage is less than 9.6v or the AIT2000 is only powered through the USB cable, then the AIT2000's GPS circuitry will be powered down and the unit will only operate in AIS Receiver mode.



The AIT2000 can be powered from the USB port for configuring the unit (programming MMSI number, etc.) which is useful for initially setting the unit up when first purchased. The following section explains how to configure the AIT2000 for correct operation.

6 CONFIGURING YOUR AIS TRANSPONDER

Until correctly configured your AIS class B transponder will only receive AIS messages and will not transmit AIS messages. Before you can configure your AIT2000, it is necessary for you to have a unique MMSI number that has been issued to you by the relevant radio or marine authority in your country. If you already have an MMSI number for your DSC VHF Radio, then this is the MMSI number that you will also program in to the AIT2000.

There are two potential ways in which your AIS transponder can be configured:

- a) Configuration in advance by your dealer or installer, in which case you will need to provide them with all of the boat's data i.e. MMSI number, call sign, vessel name, etc.
- b) Configuration using proAIS2

Providing it is acceptable to do so under your local legislation it is possible to configure your AIS transponder yourself using the proAIS2 software provided with the product. proAIS2 is available for both Windows and Mac OSX and setup/installer programs for each operating system are included on the Digital Yacht Software and Driver CD, supplied with the AIT2000.

The proAIS2 software provides the facility to configure, monitor and diagnose issues with your AIS transponder. proAIS2 can provide assistance when ensuring that a satisfactory GPS signal is being received. It can also display alarm messages generated by the transponder regarding poor VHF antenna quality or that the power being supplied is outside the range specified for operation. proAIS2 can also be used to activate 'silent mode' which disables AIS transmissions.

Once your AIT2000 is configured, it is not necessary to run proAIS2 again unless you want to use it for controlling or fault finding the AIT2000. If you do not have a compatible chart plotter or PC program for displaying AIS data, then a free copy of our SmarterTrack Lite software is also included on the CD which will run on a Windows PC and provide an AIS "radar" type display of targets on your PC screen.

If your AIS transponder has been configured for you by your dealer or installer you can proceed to the Operation section.

For configuration purposes only, it is possible to power the AIS transponder via its USB connection. This is useful if you wish to configure your AIS transponder away from the vessel power supply. The AIS transponder will not transmit any data or acquire a GPS position fix whilst powered by USB, but it will receive AIS targets if the AIS/VHF antenna is connected and you are in range of other AIS equipped vessels.

6.1 Plugging the AIT2000 in to a Windows PC

If you are using a Windows PC, it is necessary to install the AIT2000 USB drivers before plugging the AIT2000 in to a spare USB port on the computer. The drivers are installed automatically when you run the proAIS2 Setup.Exe program that you will find in the "proAIS2 for AIT2000" folder on the Software and Drivers CD-Rom.



On Windows 7 and Windows Vista PCs, problems can occur installing the USB drivers due to the Windows User Account Control (UAC) system which stops malicious or unnecessary changes to system files. It is very important that you run this Setup.Exe program as an Administrator.

To do this, from Windows Explorer, right click the Setup.Exe and select "Run as administrator" as shown in Figure 7. By running as administrator, you are giving the Setup program permission to install the drivers and everything will automatically install without any problems.

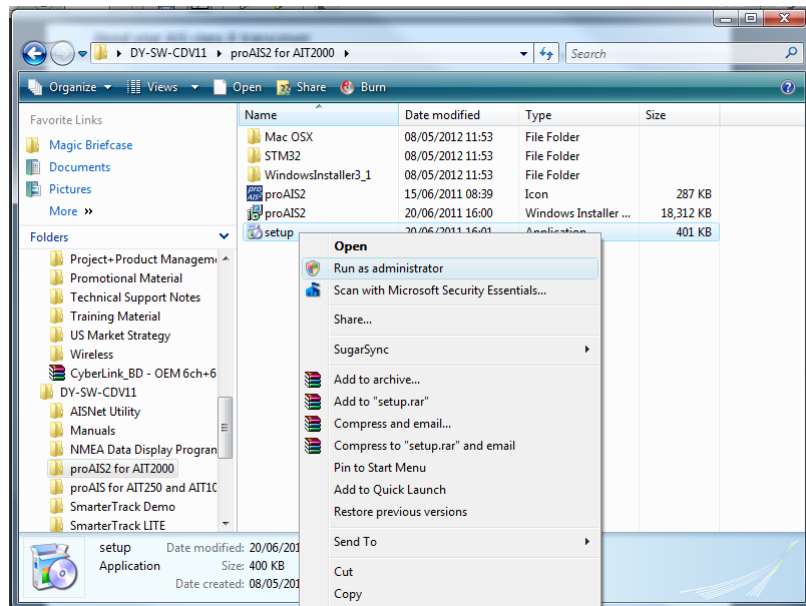

Figure 7

Once the proAIS2 and drivers are installed, you can plug the AIT2000 in to a spare USB port on the computer and Windows will see the new hardware and complete the driver registration. You should receive a brief pop-up message saying that your new hardware is ready to use.

6.2 Plugging the AIT2000 in to a Mac

If you are using a Mac, it is not necessary to install any drivers, simply plug your AIT2000 in to a spare USB port and OSX will automatically load the driver from its pre-configured driver library and your AIT2000 will be ready to use. If you need to configure the AIT2000, install the proAIS2.dmg file that is in the “proAIS2 for AIT2000\Mac OSX” folder on the Software and Drivers CD-Rom.

6.3 Running proAIS2

Locate the proAIS2 application on your computer and launch the program. You will see a screen like the one shown at the top of the next page.

In order for the program to communicate with the AIT2000, the proAIS2 needs to know which port the USB interface has been allocated by the computer’s operating system. For Windows and OSX, the AIT2000 USB interface will be installed as an “AIS Virtual COM Port”.

In most cases the proAIS2 software will show the “AIS Virtual COM Port” as the default device to connect to, but if you have other serial port adaptors on your computer, you may have to click on the selection box and select “AIS Virtual COM Port” as the device to connect to – see Figure 8.

Once selected, click the “Connect” button and the proAIS2 software will start querying the AIT2000 to see what settings it has. Assuming that the AIT2000 is a new unit, the Data boxes will all be blank and you are now ready to enter your own vessel’s static data and program it in to the AIT2000.

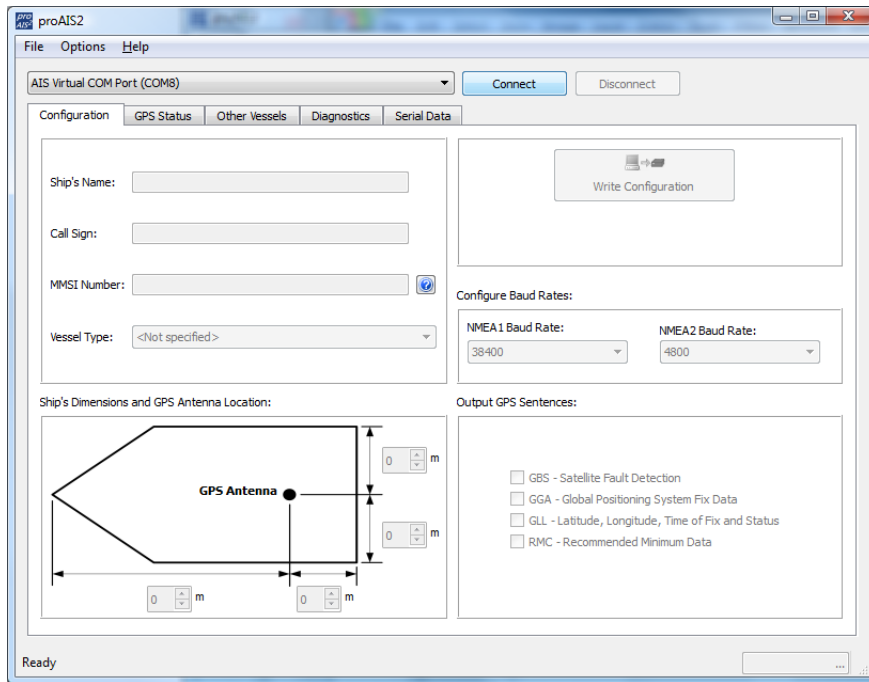

Figure 8

You should enter the following information in order to configure your AIS transponder:

- Your unique MMSI number
- The Vessel's Registered Name
- Vessel type
- VHF Call sign
- Vessel dimensions and position of your GPS antenna installation.

Below is a screen shot showing how the data can be entered.

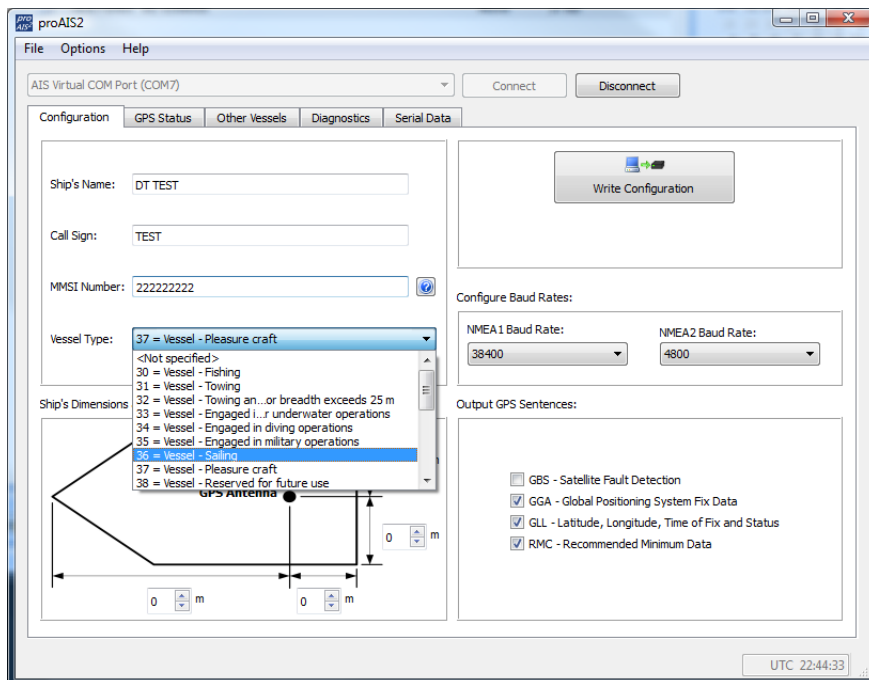
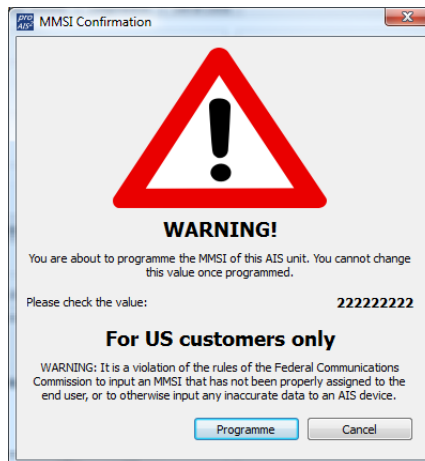

Figure 9

It is recommended that all Baud Rates and GPS Output Sentences are not changed from these defaults, which have been chosen for maximum compatibility with the most common installations.

Once this data is entered, please double check all of the values, paying particular attention to the MMSI number as once set this cannot be changed without the unit being returned to Digital Yacht.

Once you have checked that the data is correct, click the “Write Configuration” button and you will see the final warning window shown in Figure 10.



If you are 100% sure that everything is correct, click the “Programme” button and your AIT2000 will now be programmed/configured with the data you have entered.

If your AIT2000 is installed and fully powered up from the boat’s 12v or 24v supply, then the AIT2000’s GPS will now start to operate. Click on the “GPS Status” tab to see what the satellite signal strengths are like – you need a minimum of 3-4 satellites with >20 signal strength to get a position fix.

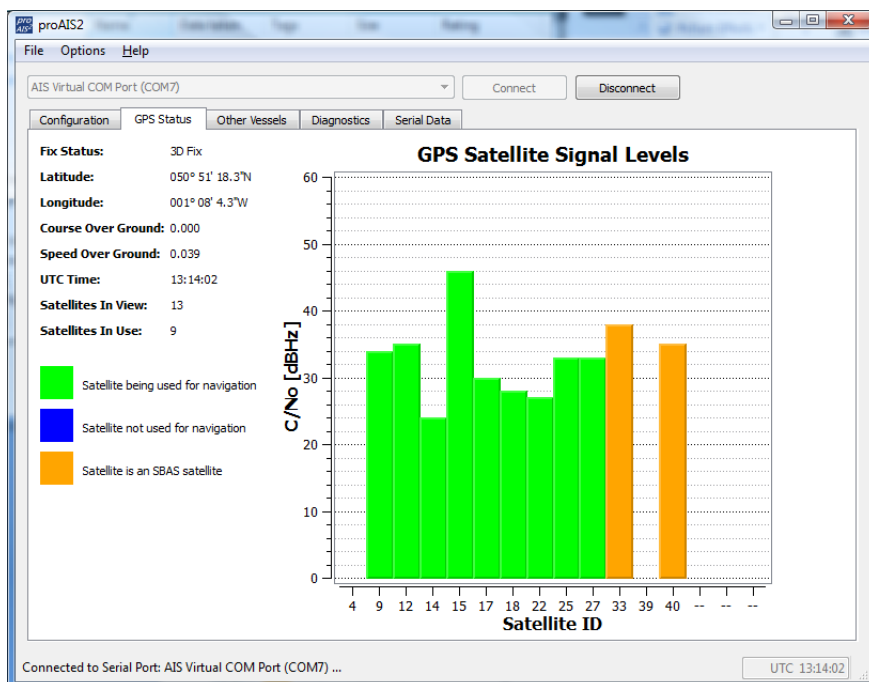
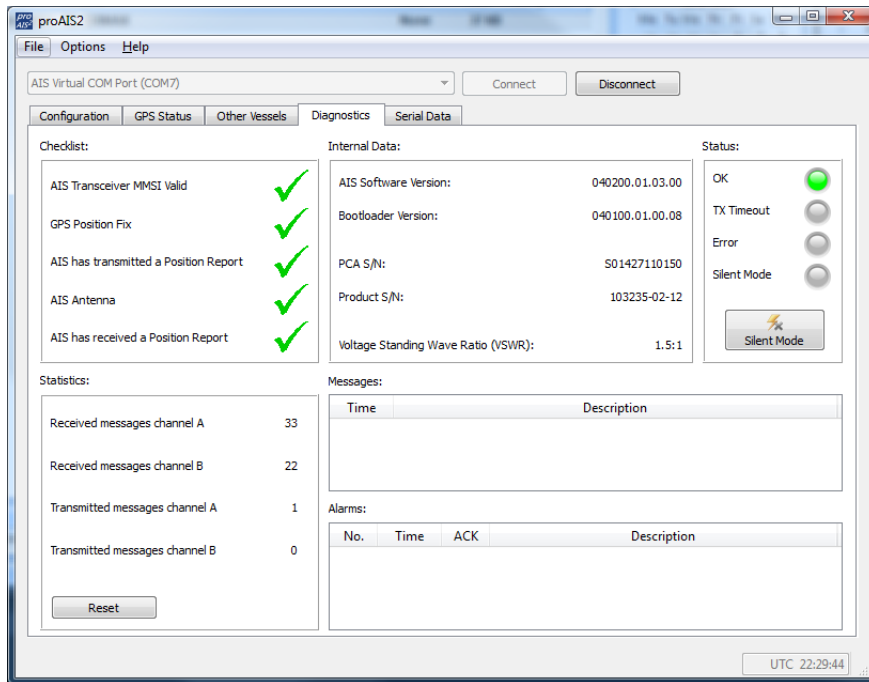

Figure 10

Once a GPS position fix is received, the AIT2000 will attempt to make a transmission report. To see occur, click on the “Diagnostics” tab and within a few minutes, the AIT2000 should make its first transmission report, five green ticks should be displayed as shown in Figure 11.



From this screen it is also possible to control the AIT2000 and stop it transmitting your position by clicking on the “Silent Mode” button. To start it transmitting again, simply click the same button again which is now labelled “Stop Silent Mode”.



For further assistance in configuring your AIS transponder please refer to the Help menu within proAIS2.

7 OPERATION

Switching on your AIS transponder for the first time

The following section assumes that the AIT2000 has either been pre-configured by a dealer or that you have configured it yourself using proAIS2. If this is not the case, please consult Section 6 before continuing.

When the AIT2000 powers up, the Green LED will illuminate briefly, then all four LEDs will flash once and then one or more of the LEDs will illuminate depending upon the configuration state of the unit. The table below shows the functions of the four indicators.

Indicator	Function
Green	Unit is powered up and operating normally
Amber	Unit is in a 'transmit timeout' period
Red	Unit has experienced an error
Blue	Silent mode is activated

Under normal circumstances, the Yellow LED will illuminate whilst the AIT2000 is waiting for the GPS to get a position fix and make its first AIS transmission. This usually takes less than 3-4 minutes and once completed the Yellow LED will go out and the Green LED will illuminate.

The AIT2000 is now transmitting your position and as long as the Green LED is illuminated, you can be sure that the AIT2000 is working correctly. The unit is constantly monitoring the supply voltage, GPS position and AIS transmission and if any of these go outside of the normal operating specification, the AIT2000 will turn off the Green LED and turn on the Red LED.

7.1 Switch functions

If you have installed an external "Silence" switch or you are using the proAIS2 software to control the AIT2000, you can put the AIT2000 into 'silent mode'. In silent mode the transmission of your own vessel position ceases, whilst the reception of other vessel's AIS position continues.

With the number of AIS equipped vessels increasing, it is good etiquette to only transmit in poor visibility, when crossing a busy shipping lane or if taking part in a yacht race. At all other times you should use silent mode to stop your AIS transmission from creating unnecessary clutter on other vessels chart systems.

When silent mode is active the blue indicator will be illuminated.

7.2 Indicator functions

The AIS transponder includes four coloured indicators as shown below. The state of the indicators provides information regarding the status of the AIS transponder.

The meaning of typical indicator configurations is shown in Table 3 on the next page.







	<p>Green indicator only</p> <ul style="list-style-type: none"> The AIS transponder is powered up, has a position fix and has transmitted at least one vessel information report. Everything is working correctly.
	<p>Red indicator only</p> <ul style="list-style-type: none"> During normal operation the AIS transponder has detected a system error. See the troubleshooting guide in Section 8 and/or check the Diagnostic messages displayed in proAIS2 which may help find the cause of the error.
	<p>Green and Blue indicators</p> <ul style="list-style-type: none"> The “Silent” switch has just been operated and transmitting has stopped. Within 3 minutes the LED combination will change to Yellow and Blue.
	<p>Yellow and Blue indicators</p> <ul style="list-style-type: none"> “Silent mode” has been activated using the optional silent mode switch or via proAIS2 and this combination of indicators is illuminated to show that the transmitter is disabled.
	<p>Red and Blue indicators</p> <ul style="list-style-type: none"> This indicates that a system error has occurred whilst the unit is in “Silent mode” unless the cause of the error is removed, the unit will not be able to start transmitting again when “Silent mode” is exited.
	<p>Yellow indicator only</p> <ul style="list-style-type: none"> The unit has just turned on and is obtaining a position fix prior to transmitting its first vessel information report (typically takes 3-4 minutes). Position fix has been lost. The AIS transponder will attempt to regain position fix for 30 minutes before entering an error state. The AIS radio channels are exceptionally busy so there is currently no available timeslot for transmission. The unit has just exited silent mode and this yellow indicator will illuminate until the first AIS message has been sent. The AIS transponder has been commanded by the local authority (via an AIS base station) to cease transmissions.
	<p>Red and Yellow indicators</p> <ul style="list-style-type: none"> This is a new AIT2000 unit that has not yet been properly configured with an MMSI number. The unit is only getting power via the USB cable.

Table 3

8 TROUBLESHOOTING

Issue	Possible cause and remedy
No data is being received by the chart plotter	<ul style="list-style-type: none"> • Check that the power supply is connected correctly. • Check that the power supply is a 12V or 24V supply. • Check that the connections to the chart plotter are correct. • If connected via NMEA0183, ensure that you have set the input port on the chart plotter to 38400 baud
No indicators are illuminated	<ul style="list-style-type: none"> • Check that the power supply is connected correctly. • Check that the power supply is a 12V or 24V supply.
The Red 'error' indicator is illuminated	<ul style="list-style-type: none"> • The unit may not have a valid MMSI. Check that the AIS transponder is correctly configured with a valid MMSI. • The VHF antenna may be faulty. Please check the connection to the VHF antenna and that the VHF antenna is not damaged. The red indicator may illuminate briefly if the power supply is interrupted or the VHF antenna characteristics are briefly affected. • No GPS position fix can be obtained. Please check the transceiver is located where the internal GPS antenna has a clear sky view or that an external GPS antenna is properly connected and installed. Review the GPS signal strength graph available in proAIS2. • The power supply is outside the allowable range. Check that the power supply is within the range 9.6V to 31.2V. • If none of the above correct the error condition please contact your dealer for advice. • Check for error and alarm messages in proAIS2
My MMSI is being received by other vessels but my vessel name is not shown on their chart plotter or PC	<ul style="list-style-type: none"> • Some older AIS devices and chart plotters do not process the specific NMEA0183 Class B AIS message which provides the vessel name (message 24). This is not a fault of your AIS transponder. A software upgrade may be available for older chart plotters which will correct this issue. The other vessel should update its AIS unit or chart plotting software to receive AIS message 24. • Some newer chart plotters do not accept the Class B static data PGN via NMEA2000. Contact the manufacturer of your chart plotter to see if a software upgrade to fix this problem is available.



For more troubleshooting information on the AIT2000 transponder please consult Tech Note 00036-2012 in the Support section of www.digitalyacht.co.uk

9 SPECIFICATIONS

Parameter	Value
Dimensions	150mm x 155mm x 37.5mm (L x W x D)
Weight	850g (transponder unit only)
Power	DC (9.6V - 31.2V) Average power consumption 170mA at 12VDC Peak current rating 2A
GPS Receiver (AIS Internal)	50 channel IEC 61108-1 compliant
Electrical Interfaces	USB NMEA0183 38,400kBaud output NMEA0183 4,800kBaud input/output NMEA2000 – LEN = 1 (Load Equivalency Number)
Connectors	VHF antenna connector (BNC) External GPS antenna connector (TNC) USB type A 1m cable NMEA2000 standard connector with 1m cable 12 way power input / NMEA0183/External switch
VHF Transponder	Transmitter x 1 Receiver x 2 (One receiver time shared between AIS and DSC) Frequency: 156.025 to 162.025 MHz in 25 kHz steps
Output Power	33dBm ± 1.5 dB
Channel Bandwidth	25kHz
Channel Step	25kHz
Modulation Modes	25kHz GMSK (AIS, TX and RX) 25kHz AFSK (DSC, RX only)
Bit rate	9600 b/s ± 50 ppm (GMSK) 1200 b/s ± 30 ppm (FSK)
RX Sensitivity	Less than -107dBm at 20% PER Co-channel 10dB Adjacent channel 70dB IMD 65dB Blocking 84dB
Environmental	Water resistant to IPx5 Operating temperature: -25 C to +55 C
Indicators	Power, TX timeout, Error, Silent Mode Status