

DECLARATION OF COMPLIANCE SAR RF EXPOSURE EVALUATION

<p><u>Test Lab</u></p> <p>CELLTECH LABS INC. Testing and Engineering Services 1955 Moss Court Kelowna, B.C. Canada V1Y 9L3 Phone: 250-448-7047 Fax: 250-448-7046 e-mail: info@celltechlabs.com web site: www.celltechlabs.com</p>	<p><u>Applicant Information</u></p> <p>UTSTARCOM INC. 33 Wood Ave. South, 3rd Floor Iselin, NJ 08830 United States</p>
<p>FCC IDENTIFIER: O6Y-UT611 Model(s): UT611</p>	
<p>FCC Rule Part(s): 47 CFR §2.1093 Test Procedure(s): FCC OET Bulletin 65, Supplement C (Edition 01-01) IEEE Standard 1528-2003 FCC Classification: Part 24 Licensed Portable Transmitter held to ear (PCE) Device Description: Portable Single-Mode PAS PHS Handset</p>	
<p>Tx Frequency Range: 1880.15 - 1909.85 MHz Access Method: TDMA (Time Division Multiple Access) Max. RF Output Power Levels Measured: 202 mW / 23.06 dBm EIRP (1880.15 MHz) 208 mW / 23.18 dBm EIRP (1895.15 MHz) 232 mW / 23.66 dBm EIRP (1909.85 MHz) Source-Based Time-Av. Duty Cycle Tested: 11.7 % (Crest Factor: 1:8.5) Max. Source-Based Time-Av. Power Tested: 27.1 mW EIRP (1909.85 MHz)</p>	
<p>Antenna Type(s) Tested: Fixed Stubby Battery Type(s) Tested: Lithium-Polymer 3.6V, 580 mAh (P/N: HZSL033450E) Body-worn Accessories Tested: None (0.0 cm air-gap spacing) Audio Accessories Tested: Ear-Microphone (Model: EE-610-41)</p>	
<p>Max. SAR Level(s) Evaluated: Head: 0.0652 W/kg (1g average) Body: 0.395 W/Kg (1g average)</p>	

Celltech Labs Inc. declares under its sole responsibility that this wireless portable device has demonstrated compliance with the Specific Absorption Rate (SAR) RF exposure requirements specified in FCC 47 CFR §2.1093. The device was tested in accordance with the measurement standards and procedures specified in FCC OET Bulletin 65, Supplement C (Edition 01-01) and IEEE Standard 1528-2003 for the General Population / Uncontrolled Exposure environment. All measurements were performed in accordance with the SAR system manufacturer recommendations.

I attest to the accuracy of data. All measurements were performed by me or were made under my supervision and are correct to the best of my knowledge and belief. I assume full responsibility for the completeness of these measurements and vouch for the qualifications of all persons taking them.

This test report shall not be reproduced partially, or in full, without the prior written approval of Celltech Labs Inc. The results and statements contained in this report pertain only to the device(s) evaluated.

Performed By:



Spencer Watson
Compliance Technologist
Celltech Labs Inc.

Reviewed By:



Russell W. Pipe
Senior Compliance Technologist
Celltech Labs Inc.



Applicant: UTStarcom Inc.	Model: UT611	FCC ID: O6Y-UT611	
DUT Type: Portable Single-Mode PAS PHS TDMA Handset	Freq. Range: 1880.15 - 1909.85 MHz		
2005 Celltech Labs Inc. This document is not to be reproduced in whole or in part without the written permission of Celltech Labs Inc.			1 of 49

TABLE OF CONTENTS	
1.0 INTRODUCTION	3
2.0 DESCRIPTION of Device Under Test (DUT)	3
3.0 SAR MEASUREMENT SYSTEM	4
4.0 MEASUREMENT SUMMARY	5
5.0 DETAILS OF SAR EVALUATION	7
6.0 EVALUATION PROCEDURES	8
7.0 SYSTEM PERFORMANCE CHECK	10
8.0 SIMULATED EQUIVALENT TISSUES	11
9.0 SAR SAFETY LIMITS	11
10.0 ROBOT SYSTEM SPECIFICATIONS	12
11.0 PROBE SPECIFICATION (ET3DV6)	13
12.0 SAM PHANTOM V4.0C	13
13.0 DEVICE HOLDER	13
14.0 TEST EQUIPMENT LIST	14
15.0 MEASUREMENT UNCERTAINTIES	15
16.0 REFERENCES	17
APPENDIX A - SAR MEASUREMENT DATA	18
APPENDIX B - SYSTEM PERFORMANCE CHECK DATA	30
APPENDIX C - MEASURED FLUID DIELECTRIC PARAMETERS	33
APPENDIX D - SAR TEST SETUP & DUT PHOTOGRAPHS	36
APPENDIX E - SYSTEM VALIDATION	47
APPENDIX F - PROBE CALIBRATION	48
APPENDIX G - SAM PHANTOM CERTIFICATE OF CONFORMITY	49

1.0 INTRODUCTION

This measurement report demonstrates that the UTSTARCOM INC. Model: UT611 Portable Single-Mode PAS PHS Handset FCC ID: O6Y-UT611 complies with the SAR (Specific Absorption Rate) RF exposure requirements specified in FCC 47 CFR §2.1093 (see reference [1]) for the General Population / Uncontrolled Exposure environment. The test procedures described in FCC OET Bulletin 65, Supplement C, Edition 01-01 (see reference [2]), and IEEE Standard 1528-2003 (see reference [3]) were employed. A description of the product and operating configuration, detailed summary of the test results, methodology and procedures used in the evaluation, equipment used, and the provisions of the rules are included within this test report.

2.0 DESCRIPTION of Device Under Test (DUT)

FCC Device Classification	Licensed Portable Transmitter Held to Ear (PCE)			
FCC Rule Part(s)	47 CFR §2.1093			
Test Procedure(s)	FCC OET Bulletin 65, Supplement C (01-01)			
	IEEE Standard 1528-2003			
Device Description	Portable Single-Mode PAS PHS Handset			
FCC IDENTIFIER	O6Y-UT611			
Model No.(s)	UT611			
Serial No.	FCC2	Production Unit		
Tx Frequency Range	1880.15 - 1909.85 MHz			
Access Method	TDMA	Time Division Multiple Access		
Max. RF Output Power Measured	202 mW	23.06 dBm	EIRP	1880.15 MHz
	208 mW	23.18 dBm	EIRP	1895.15 MHz
	232 mW	23.66 dBm	EIRP	1909.85 MHz
Source-Based Time-Averaged RF Output Power Tested	24.3 mW	13.86 dBm	EIRP	1895.15 MHz
	27.1 mW	14.33 dBm	EIRP	1909.85 MHz
Source-Based Time-Averaged Duty Cycle Tested	11.7 %		Crest Factor: 1:8.5	
Battery Type(s) Tested	Lithium-Polymer	3.6 V	580 mAh	P/N: HZSL033450E
Antenna Type(s) Tested	Fixed Stubby			
Body-Worn Accessories Tested	None		0.0 cm Air-Gap Spacing	
Audio Accessories Tested	Ear-Microphone		Model: EE-610-41	

3.0 SAR MEASUREMENT SYSTEM

Celltech Labs Inc. SAR measurement facility utilizes the Dosimetric Assessment System (DASY™) manufactured by Schmid & Partner Engineering AG (SPEAG™) of Zurich, Switzerland. The DASY4 measurement system is comprised of the measurement server, robot controller, computer, near-field probe, probe alignment sensor, specific anthropomorphic mannequin (SAM) phantom, and various planar phantoms for brain and/or body SAR evaluations. The robot is a six-axis industrial robot performing precise movements to position the probe to the location (points) of maximum electromagnetic field (EMF). A cell controller system contains the power supply, robot controller, teach pendant (Joystick), and remote control, is used to drive the robot motors. The Staubli robot is connected to the cell controller to allow software manipulation of the robot. A data acquisition electronic (DAE) circuit performs the signal amplification, signal multiplexing, AD-conversion, offset measurements, mechanical surface detection, collision detection, etc. is connected to the Electro-optical coupler (EOC). The EOC performs the conversion from the optical into digital electric signal of the DAE and transfers data to the DASY4 measurement server. The DAE4 utilizes a highly sensitive electrometer-grade preamplifier with auto-zeroing, a channel and gain-switching multiplexer, a fast 16-bit AD-converter and a command decoder and control logic unit. Transmission to the DASY4 measurement server is accomplished through an optical downlink for data and status information and an optical uplink for commands and clock lines. The mechanical probe-mounting device includes two different sensor systems for frontal and sidewise probe contacts. The sensor systems are also used for mechanical surface detection and probe collision detection. The robot uses its own controller with a built in VME-bus computer.



DASY4 Measurement System with SAM Phantom



DASY4 Measurement System with SAM Phantom

Applicant:	UTStarcom Inc.	Model:	UT611	FCC ID:	O6Y-UT611	
DUT Type:	Portable Single-Mode PAS PHS TDMA Handset	Freq. Range:	1880.15 - 1909.85 MHz			
2005 Celltech Labs Inc.		This document is not to be reproduced in whole or in part without the written permission of Celltech Labs Inc.				4 of 49

4.0 MEASUREMENT SUMMARY

HEAD SAR EVALUATION RESULTS

Freq. (MHz)	Chan.	Test Mode	Battery Type	Antenna Position	Phantom Section	Test Position	Start Power EIRP (mW)		Measured SAR 1g (W/kg)	SAR Drift During Test (dB)	Scaled SAR 1g (W/kg)
							Measured	SBTA			
1895.15	1	TDMA	Lithium-Polymer	Fixed	Right Ear	Ear/Tilt (15°)	208	24.3	0.0169	0.0456	0.0169
1895.15	1	TDMA	Lithium-Polymer	Fixed	Right Ear	Cheek/Touch	208	24.3	0.0575	-0.0327	0.0579
1909.85	50	TDMA	Lithium-Polymer	Fixed	Right Ear	Cheek/Touch	232	27.1	0.0595	0.00546	0.0595
1895.15	1	TDMA	Lithium-Polymer	Fixed	Left Ear	Ear/Tilt (15°)	208	24.3	0.0160	0.102	0.0160
1895.15	1	TDMA	Lithium-Polymer	Fixed	Left Ear	Cheek/Touch	208	24.3	0.0640	0.00575	0.0640
1909.85	50	TDMA	Lithium-Polymer	Fixed	Left Ear	Cheek/Touch	232	27.1	0.0652	0.0114	0.0652

ANSI / IEEE C95.1 1999 - SAFETY LIMIT
BRAIN: 1.6 W/kg (averaged over 1 gram)
Spatial Peak - Uncontrolled Exposure / General Population

Test Date(s)	May 11, 2005			Relative Humidity	34	%
Measured Fluid Type	1900 MHz Brain			Atmospheric Pressure	102.3	kPa
Dielectric Constant ϵ_r	IEEE Target	Measured	Deviation	Ambient Temperature	22.4	°C
	40.0	± 5%	38.6	-3.5%	Fluid Temperature	22.1
Conductivity σ (mho/m)	IEEE Target	Measured	Deviation	Fluid Depth	≥ 15	cm
	1.40	± 5%	1.43	+2.1%	ρ (Kg/m³)	1000

Note(s):

- The measurement results were obtained with the DUT tested in the conditions described in this report. Detailed measurement data and plots showing the maximum SAR location of the DUT are reported in Appendix A.
- If the scaled SAR levels evaluated at the mid channel were ≥ 3 dB below the SAR limit, SAR evaluation for the low and high channels was optional (per FCC OET Bulletin 65, Supplement C, Edition 01-01 - see reference [2]). The EIRP reference power level measured at the high channel was 24 mW higher than the mid channel EIRP, therefore SAR evaluations were subsequently performed at the high channel in the worst-case mid channel test position for both right and left ear in order to show compliance at the higher power level as shown in the above test data table. The low channel was not evaluated for SAR based on lower EIRP measurement.
- The power droop measured by the DASY4 system for the duration of the SAR evaluation (Right Ear, Cheek/Touch, Mid Channel) was added to the measured SAR to report a scaled SAR level as shown in the above test data table.
- The ambient and fluid temperatures were measured prior to, and during, the fluid dielectric parameter check and the SAR evaluations. The temperatures reported were consistent for all measurement periods.
- The dielectric parameters of the simulated tissue mixture were measured prior to the evaluations using an ALS-PR-DIEL Dielectric Probe Kit and an HP 8753E Network Analyzer (see Appendix C for printout of measured fluid dielectric parameters).
- The SAR measurements were performed within 24 hours of the system performance check.

MEASUREMENT SUMMARY (Cont.)

BODY-WORN SAR EVALUATION RESULTS

Freq. (MHz)	Chan.	Test Mode	Battery Type	Antenna Position	Phantom Section	DUT Test Position	Separation Distance to Planar Phantom (cm)		Accessories		Start Power EIRP (mW)		Meas. SAR 1g (W/kg)	SAR Drift During Test (dB)	Scaled SAR 1g (W/kg)
									Body-Worn	Audio	Meas.	SBTA			
1895.15	1	TDMA	Lithium Polymer	Fixed	Planar	Front Side	0.0	air-gap	None	Ear-Mic	208	24.3	0.0466	0.0466	0.0466
1895.15	1	TDMA	Lithium Polymer	Fixed	Planar	Back Side	0.0	air-gap	None	Ear-Mic	208	24.3	0.305	-0.0938	0.312
1909.85	50	TDMA	Lithium Polymer	Fixed	Planar	Back Side	0.0	air-gap	None	Ear-Mic	232	27.1	0.395	0.142	0.395

ANSI / IEEE C95.1 1999 - SAFETY LIMIT
BODY: 1.6 W/kg (averaged over 1 gram)
Spatial Peak - Uncontrolled Exposure / General Population

Test Date(s)	May 11, 2005			Relative Humidity	33	%
Measured Fluid Type	1900 MHz Body			Atmospheric Pressure	102.0	kPa
Dielectric Constant ϵ_r	IEEE Target	Measured	Deviation	Ambient Temperature	24.3	°C
	53.3	± 5%	50.8	-4.7%	Fluid Temperature	22.4
Conductivity σ (mho/m)	IEEE Target	Measured	Deviation	Fluid Depth	≥ 15	cm
	1.52	± 5%	1.54	+1.3%	ρ (Kg/m ³)	1000

Note(s):

- The measurement results were obtained with the DUT tested in the conditions described in this report. Detailed measurement data and plots showing the maximum SAR location of the DUT are reported in Appendix A.
- If the scaled SAR levels evaluated at the mid channel were ≥ 3 dB below the SAR limit, SAR evaluation for the low and high channels was optional (per FCC OET Bulletin 65, Supplement C, Edition 01-01 - see reference [2]). The EIRP reference power level measured at the high channel was 24 mW higher than the mid channel EIRP, therefore SAR evaluations were subsequently performed at the high channel in the worst-case mid channel test position for both right and left ear in order to show compliance at the higher power level as shown in the above test data table. The low channel was not evaluated for SAR based on lower EIRP measurement.
- The power droop measured by the DASY4 system for the duration of the SAR evaluation (Back Side of DUT, Mid Channel) was added to the measured SAR to report a scaled SAR level as shown in the above test data table.
- The ambient and fluid temperatures were measured prior to, and during, the fluid dielectric parameter check and the SAR evaluations. The temperatures reported were consistent for all measurement periods.
- The dielectric parameters of the simulated tissue mixture were measured prior to the evaluations using an ALS-PR-DIEL Dielectric Probe Kit and an HP 8753E Network Analyzer (see Appendix C for printout of measured fluid dielectric parameters).
- The SAR measurements were performed within 24 hours of the system performance check.

5.0 DETAILS OF SAR EVALUATION

The UTSTARCOM INC. Model: UT611 Portable Single-Mode PAS PHS Handset FCC ID: O6Y-UT611 was compliant for localized Specific Absorption Rate (SAR) based on the test provisions and conditions described below. The detailed test setup photographs are shown in Appendix D.

Ear-held Configuration

- 1) The DUT was tested in an ear-held configuration on both the left and right sections of the SAM phantom at the mid channel of the operating band. If the SAR level at the mid channel of the frequency band for each test configuration (left ear, right ear, cheek/touch, ear/tilt) was ≥ 3 dB below the SAR limit, measurements at the low and high channels were optional (per FCC OET Bulletin 65, Supplement C, Edition 01-01 - see reference [3]).
 - a) The handset was placed in the device holder in a normal operating position with the test device reference point located along the vertical centerline on the front of the device aligned to the ear reference point, with the center of the earpiece touching the center of the ear spacer of the SAM phantom.
 - b) With the handset positioned parallel to the cheek, the test device reference point was aligned to the ear reference point on the head phantom, and the vertical centerline was aligned to the phantom reference plane (initial ear position).
 - c) While maintaining the three alignments, the body of the handset was gradually adjusted to each of the following test positions:
 - Cheek/Touch Position: the handset was brought toward the mouth of the head phantom by pivoting against the ear reference point until any point of the mouthpiece or keypad touched the phantom.

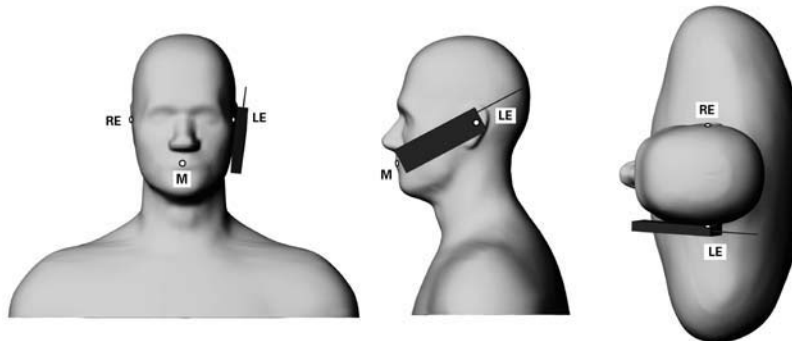

Figure 1. Phone position 1, "cheek" or "touch" position. The reference points for the right ear (RE), left ear (LE) and mouth (M), which define the reference plane for phone positioning, are indicated (Shoulders are shown for illustration only).

- Ear/Tilt Position: With the phone aligned in the Cheek/Touch position, the handset was tilted away from the mouth with respect to the test device reference point by 15 degrees.

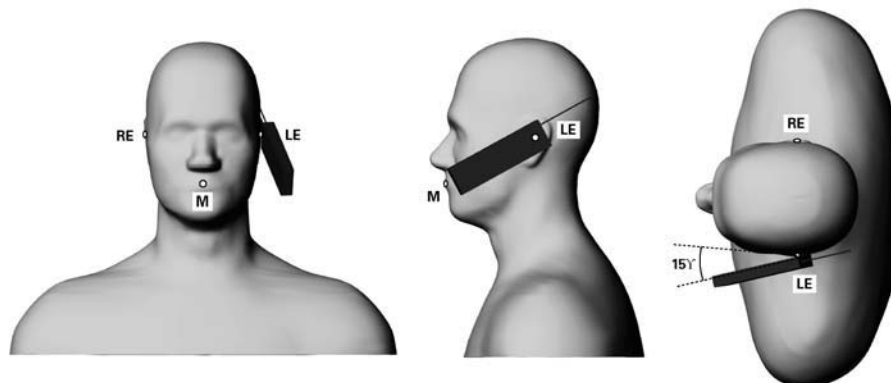

Figure 2. Phone position 2 - "tilted position." The reference points for the right ear (RE), left ear (LE) and mouth (M), which define the reference plane for phone positioning, are indicated (Shoulders are shown for illustration only).

DETAILS OF SAR EVALUATION (Cont.)

Body-worn Configuration

- 2) The DUT was tested in a body-worn configuration with the front side of the DUT facing parallel to the outer surface of the SAM phantom (planar section) with a 0.0 cm air-gap spacing between the front side of the DUT and the outer surface of the SAM phantom (planar section). The DUT was evaluated for body-worn SAR with an ear-microphone audio accessory connected to the audio port.
- 3) The DUT was tested in a body-worn configuration with the back side of the DUT facing parallel to the outer surface of the SAM phantom (planar section) with a 0.0 cm air-gap spacing between the back side of the DUT and the outer surface of the SAM phantom (planar section). The DUT was evaluated for body-worn SAR with an ear-microphone audio accessory connected to the audio port.

Test Modes & Power Settings

- 4) The DUT was placed into test mode using internal software controlled by the keypad.
- 5) The DUT was tested in TDMA mode at a duty cycle of 11.7% and a crest factor of 1:8.5.
- 6) The RF conducted output power of the DUT could not be measured for the SAR evaluations due to a non-detachable antenna. The DUT was evaluated for SAR at the maximum RF conducted power level preset by the manufacturer.
- 7) The DUT was evaluated for SAR at the maximum EIRP level measured prior to the SAR evaluations on a 3-meter Open Area Test Site using the signal substitution method in accordance with ANSI/TIA-603-C-2004 (see reference [4]).
- 8) The power droops measured by the DASY4 system for the duration of the SAR evaluations were added to the measured SAR levels to report scaled SAR results as shown in the test data tables (page 5-6).
- 9) The ambient and fluid temperatures were measured prior to, and during, the fluid dielectric parameter check and the SAR evaluations. The temperatures reported were consistent for all measurement periods.
- 10) The dielectric parameters of the simulated tissue mixtures were measured prior to the SAR evaluations using an ALS-PR-DIEL Dielectric Probe Kit and an HP 8753ET Network Analyzer (see Appendix C for printout of measured fluid dielectric parameters).
- 11) The DUT was evaluated with a fully charged battery for each test.
- 12) The SAR measurements were performed within 24 hours of the system performance check.

6.0 EVALUATION PROCEDURES

- a. (i) The evaluation was performed in the applicable area of the phantom depending on the type of device being tested. For devices held to the ear during normal operation, both the left and right ear positions were evaluated using the SAM phantom.
(ii) For body-worn and face-held devices a planar phantom was used.
- b. The SAR was determined by a pre-defined procedure within the DASY4 software. Upon completion of a reference and optical surface check, the exposed region of the phantom was scanned near the inner surface with a grid spacing of 15mm x 15mm.

An area scan was determined as follows:

- c. Based on the defined area scan grid, a more detailed grid is created to increase the points by a factor of 10. The interpolation function then evaluates all field values between corresponding measurement points.
- d. A linear search is applied to find all the candidate maxima. Subsequently, all maxima are removed that are >2 dB from the global maximum. The remaining maxima are then used to position the cube scans.

A 1g and 10g spatial peak SAR was determined as follows:

- e. Extrapolation is used to find the points between the dipole center of the probe and the surface of the phantom. This data cannot be measured, since the center of the dipoles is 2.7 mm away from the tip of the probe and the distance between the surface and the lowest measuring point is 1.3 mm (see probe calibration document in Appendix F). The extrapolation was based on trivariate quadratics computed from the previously calculated 3D interpolated points nearest the phantom surface.
- f. Interpolated data is used to calculate the average SAR over 1g and 10g cubes by spatially discretizing the entire measured cube. The volume used to determine the averaged SAR is a 1mm grid (42875 interpolated points).
- g. A zoom scan volume of 32 mm x 32 mm x 30 mm (5x5x7 points) centered at the peak SAR location determined from the area scan is used for all zoom scans for devices with a transmit frequency < 800 MHz. Zoom scans for frequencies ≥ 800 MHz are determined with a scan volume of 30 mm x 30 mm x 30 mm (7x7x7) to ensure complete capture of the peak spatial-average SAR.

EVALUATION Procedures (Cont.)

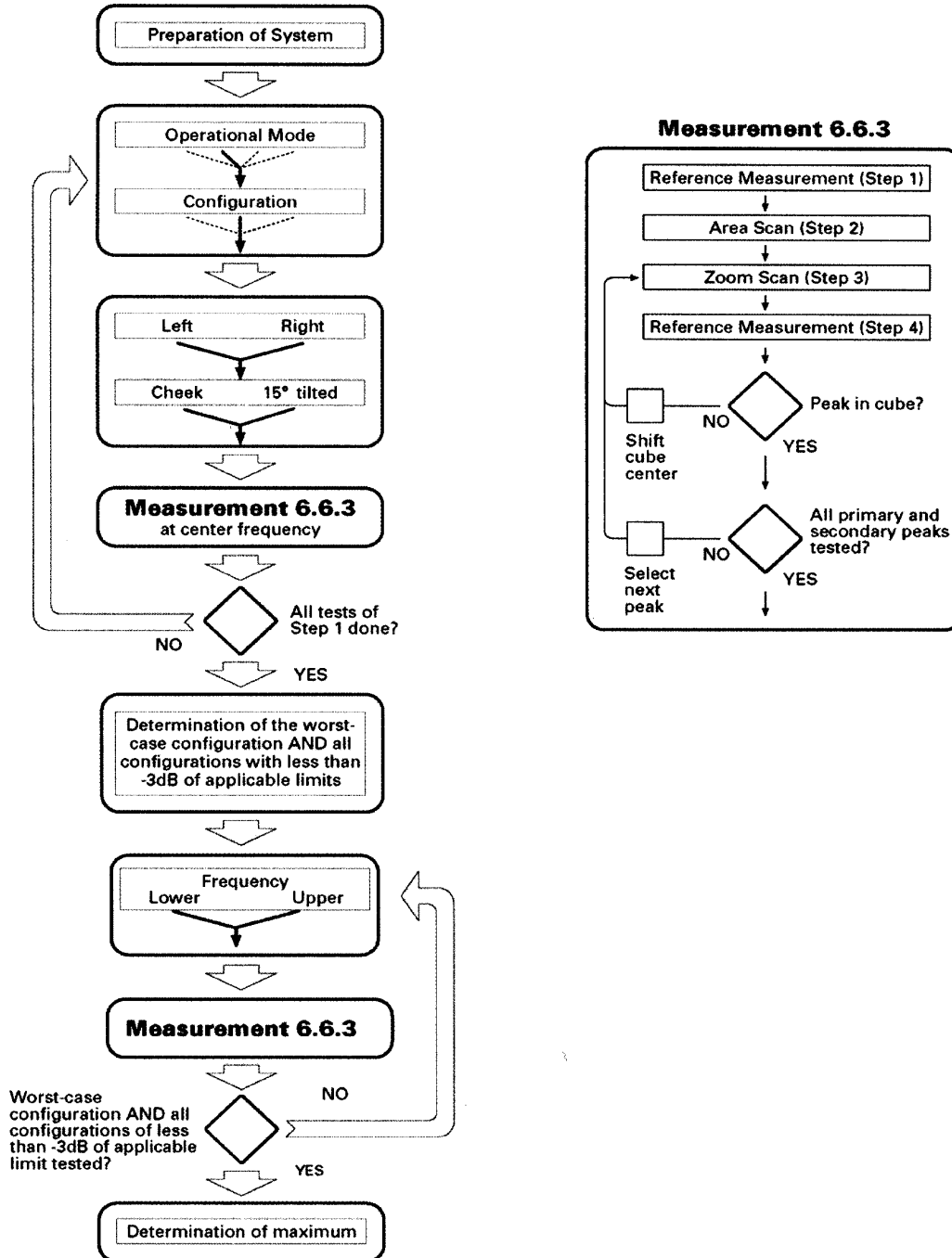

Figure 3. Flow Chart for determining the largest peak spatial-average SAR from all device configurations per IEEE Standard 1528-2003 (see reference [5]).

7.0 SYSTEM PERFORMANCE CHECK

Prior to the SAR evaluation a system check was performed at the planar section of the SAM phantom with a 1900MHz dipole (see Appendix E for system validation procedures). The dielectric parameters of the simulated tissue mixture were measured prior to the system performance check using an ALS-PR-DIEL Dielectric Probe Kit and an HP 8753ET Network Analyzer (see Appendix C for printout of measured fluid dielectric parameters). A forward power of 250mW was applied to the dipole and the system was verified to a tolerance of $\pm 10\%$ (see Appendix B for system performance check test plot).

SYSTEM PERFORMANCE CHECK																
Test Date	1900MHz Equiv. Tissue	SAR 1g (W/kg)			Dielectric Constant ϵ_r			Conductivity σ (mho/m)			ρ (Kg/m ³)	Amb. Temp. (°C)	Fluid Temp. (°C)	Fluid Depth (cm)	Humid. (%)	Barom. Press. (kPa)
		IEEE Target	Meas.	Dev.	IEEE Target	Meas.	Dev.	IEEE Target	Meas.	Dev.						
5/11/05	Brain	9.93 $\pm 10\%$	10.8	+8.8%	40.0 $\pm 5\%$	38.6	-3.5%	1.40 $\pm 5\%$	1.43	+2.1%	1000	22.4	22.1	≥ 15	34	102.4

Note(s):

- The ambient and fluid temperatures were measured prior to, and during, the fluid dielectric parameter check and the system performance check. The temperatures listed in the table above were consistent for all measurement periods.

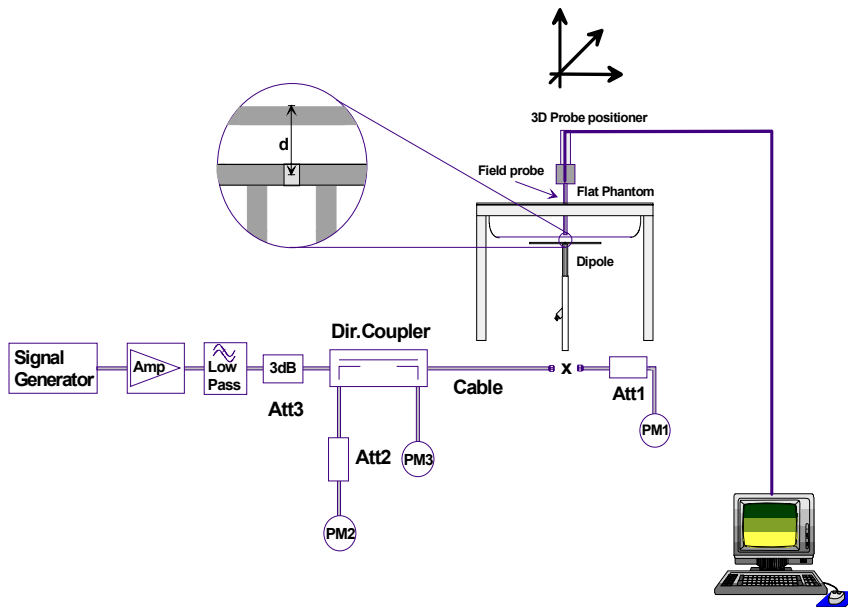

Figure 4. System Performance Check Setup Diagram



1900MHz Dipole Setup

8.0 SIMULATED EQUIVALENT TISSUES

The 1900MHz simulated equivalent tissue mixtures consist of Glycol-monobutyl, water, and salt. The fluids were prepared according to standardized procedures and measured for dielectric parameters (permittivity and conductivity).

1900MHz SIMULATED TISSUE MIXTURES		
INGREDIENT	1900MHz Brain	1900MHz Body
	System Performance Check & DUT Evaluation	DUT Evaluation
Water	55.85 %	69.85 %
Glycol Monobutyl	44.00 %	29.89 %
Salt	0.15 %	0.26 %

9.0 SAR SAFETY LIMITS

EXPOSURE LIMITS	SAR (W/kg)	
	(General Population / Uncontrolled Exposure Environment)	(Occupational / Controlled Exposure Environment)
Spatial Average (averaged over the whole body)	0.08	0.4
Spatial Peak (averaged over any 1 g of tissue)	1.60	8.0
Spatial Peak (hands/wrists/feet/ankles averaged over 10 g)	4.0	20.0

Notes:

1. Uncontrolled environments are defined as locations where there is potential exposure of individuals who have no knowledge or control of their potential exposure.
2. Controlled environments are defined as locations where there is potential exposure of individuals who have knowledge of their potential exposure and can exercise control over their exposure.

10.0 ROBOT SYSTEM SPECIFICATIONS

Specifications

POSITIONER: Stäubli Unimation Corp. Robot Model: RX60L
Repeatability: 0.02 mm
No. of axis: 6

Data Acquisition Electronic (DAE) System

Cell Controller

Processor: AMD Athlon XP 2400+
Clock Speed: 2.0 GHz
Operating System: Windows XP Professional

Data Converter

Features: Signal Amplifier, multiplexer, A/D converter, and control logic
Software: DASY4 software
Connecting Lines: Optical downlink for data and status info.
 Optical uplink for commands and clock

DASY4 Measurement Server

Function: Real-time data evaluation for field measurements and surface detection
Hardware: PC/104 166MHz Pentium CPU; 32 MB chipdisk; 64 MB RAM
Connections: COM1, COM2, DAE, Robot, Ethernet, Service Interface

E-Field Probe

Model: ET3DV6
Serial No.: 1387
Construction: Triangular core fiber optic detection system
Frequency: 10 MHz to 6 GHz
Linearity: ± 0.2 dB (30 MHz to 3 GHz)

Phantom(s)

Type: SAM V4.0C
Shell Material: Fiberglass
Thickness: 2.0 ± 0.1 mm
Volume: Approx. 25 liters

11.0 PROBE SPECIFICATION (ET3DV6)

Construction:	Symmetrical design with triangular core Built-in shielding against static charges PEEK enclosure material (resistant to organic solvents, e.g. glycol)
Calibration:	In air from 10 MHz to 2.5 GHz In brain simulating tissue at frequencies of 900 MHz and 1.8 GHz (accuracy $\pm 8\%$)
Frequency:	10 MHz to >6 GHz; Linearity: ± 0.2 dB (30 MHz to 3 GHz)
Directivity:	± 0.2 dB in brain tissue (rotation around probe axis) ± 0.4 dB in brain tissue (rotation normal to probe axis)
Dynamic Range:	5 μ W/g to >100 mW/g; Linearity: ± 0.2 dB
Surface Detection:	± 0.2 mm repeatability in air and clear liquids over diffuse reflecting surfaces
Dimensions:	Overall length: 330 mm Tip length: 16 mm Body diameter: 12 mm Tip diameter: 6.8 mm Distance from probe tip to dipole centers: 2.7 mm
Application:	General dosimetry up to 3 GHz Compliance tests of portable phone



ET3DV6 E-Field Probe

12.0 SAM PHANTOM V4.0C

The SAM phantom V4.0C is a fiberglass shell phantom with a 2.0 mm (+/-0.2 mm) shell thickness for left and right head and flat planar area integrated in a wooden table. The shape of the fiberglass shell corresponds to the phantom defined by SCC34-SC2. The device holder positions are adjusted to the standard measurement positions in the three sections (see Appendix G for specifications of the SAM phantom V4.0C).

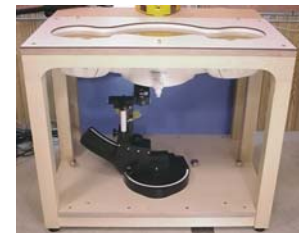

SAM Phantom V4.0C

13.0 DEVICE HOLDER

The DASY4 device holder has two scales for device rotation (with respect to the body axis) and the device inclination (with respect to the line between the ear openings). The plane between the ear openings and the mouth tip has a rotation angle of 65°. The bottom plate contains three pair of bolts for locking the device holder. The device holder positions are adjusted to the standard measurement positions in the three sections.



Device Holder

Applicant:	UTStarcom Inc.	Model:	UT611	FCC ID:	O6Y-UT611	
DUT Type:	Portable Single-Mode PAS PHS TDMA Handset	Freq. Range:	1880.15 - 1909.85 MHz			
2005 Celltech Labs Inc.		This document is not to be reproduced in whole or in part without the written permission of Celltech Labs Inc.				13 of 49

14.0 TEST EQUIPMENT LIST

USED	TEST EQUIPMENT DESCRIPTION	ASSET NO.	SERIAL NO.	DATE CALIBRATED	CALIBRATION DUE DATE
x	Schmid & Partner DASY4 System	-	-	-	-
x	-DASY4 Measurement Server	00158	1078	N/A	N/A
x	-Robot	00046	599396-01	N/A	N/A
x	-DAE3	00019	353	06Jul04	06Jul05
	-DAE3	00018	370	25Jan05	25Jan06
x	-ET3DV6 E-Field Probe	00016	1387	18Mar05	18Mar06
	-ET3DV6 E-Field Probe	00017	1590	24May04	24May05
	-EX3DV4 E-Field Probe	00125	3547	21Jan05	21Jan06
	-300MHz Validation Dipole	00023	135	26Oct04	26Oct05
	-450MHz Validation Dipole	00024	136	04Nov04	04Nov05
	-835MHz Validation Dipole	00022	411	30Mar05	30Mar06
	-900MHz Validation Dipole	00020	054	10Jun04	10Jun05
	-1800MHz Validation Dipole	00021	247	08Jun04	08Jun05
x	-1900MHz Validation Dipole	00032	151	18Jun04	18Jun05
	-2450MHz Validation Dipole	00025	150	30Sep04	30Sep05
	-5000MHz Validation Dipole	00126	1031	11Jan05	11Jan06
x	-SAM Phantom V4.0C	00154	1033	N/A	N/A
	-Barski Planar Phantom	00155	03-01	N/A	N/A
	-Plexiglas Planar Phantom	00156	161	N/A	N/A
	-Validation Planar Phantom	00157	137	N/A	N/A
	HP 85070C Dielectric Probe Kit	00033	N/A	N/A	N/A
x	ALS-PR-DIEL Dielectric Probe Kit	00160	260-00953	N/A	N/A
	Gigatronics 8652A Power Meter	00110	1835801	16Apr05	16Apr06
x	Gigatronics 8652A Power Meter	00008	1835267	29Apr05	29Apr06
	Gigatronics 8652A Power Meter	00007	1835272	18Oct04	18Oct05
x	Gigatronics 80701A Power Sensor	00013	1833713	11Oct04	11Oct05
	Gigatronics 80701A Power Sensor	00011	1833542	08Oct04	08Oct05
x	Gigatronics 80701A Power Sensor	00109	1834366	16Apr05	16Apr06
x	HP 8753ET Network Analyzer	00134	US39170292	04May05	04May06
x	HP 8648D Signal Generator	00005	3847A00611	29Apr05	29Apr06
	Rohde & Schwarz SMR40 Signal Generator	00006	100104	12Apr05	12Apr06
x	Amplifier Research 5S1G4 Power Amplifier	00106	26235	N/A	N/A

15.0 MEASUREMENT UNCERTAINTIES

UNCERTAINTY BUDGET FOR DEVICE EVALUATION						
Error Description	Uncertainty Value ±%	Probability Distribution	Divisor	C _i 1g	Standard Uncertainty ±% (1g)	V _i or V _{eff}
Measurement System						
Probe calibration	± 5.5	Normal	1	1	± 5.5	∞
Axial isotropy of the probe	± 4.7	Rectangular	√3	(1-c _p)	± 1.9	∞
Spherical isotropy of the probe	± 9.6	Rectangular	√3	(c _p)	± 3.9	∞
Spatial resolution	± 0.0	Rectangular	√3	1	± 0.0	∞
Boundary effects	± 5.5	Rectangular	√3	1	± 3.2	∞
Probe linearity	± 4.7	Rectangular	√3	1	± 2.7	∞
Detection limit	± 1.0	Rectangular	√3	1	± 0.6	∞
Readout electronics	± 1.0	Normal	1	1	± 1.0	∞
Response time	± 0.8	Rectangular	√3	1	± 0.5	∞
Integration time	± 1.4	Rectangular	√3	1	± 0.8	∞
RF ambient conditions	± 3.0	Rectangular	√3	1	± 1.7	∞
Mech. constraints of robot	± 0.4	Rectangular	√3	1	± 0.2	∞
Probe positioning	± 2.9	Rectangular	√3	1	± 1.7	∞
Extrapolation & integration	± 3.9	Rectangular	√3	1	± 2.3	∞
Test Sample Related						
Device positioning	± 6.0	Normal	√3	1	± 6.7	12
Device holder uncertainty	± 5.0	Normal	√3	1	± 5.9	8
Power drift	± 5.0	Rectangular	√3		± 2.9	∞
Phantom and Setup						
Phantom uncertainty	± 4.0	Rectangular	√3	1	± 2.3	∞
Liquid conductivity (target)	± 5.0	Rectangular	√3	0.6	± 1.7	∞
Liquid conductivity (measured)	± 5.0	Rectangular	√3	0.6	± 1.7	∞
Liquid permittivity (target)	± 5.0	Rectangular	√3	0.6	± 1.7	∞
Liquid permittivity (measured)	± 5.0	Rectangular	√3	0.6	± 1.7	∞
Combined Standard Uncertainty					± 13.57	
Expanded Uncertainty (k=2)					± 27.14	

Measurement Uncertainty Table in accordance with IEEE Standard 1528-2003 (see reference [3])

MEASUREMENT UNCERTAINTIES (Cont.)

UNCERTAINTY BUDGET FOR SYSTEM VALIDATION						
Error Description	Uncertainty Value ±%	Probability Distribution	Divisor	C_i 1g	Standard Uncertainty ±% (1g)	V_i or V_{eff}
Measurement System						
Probe calibration	± 5.5	Normal	1	1	± 5.5	∞
Axial isotropy of the probe	± 4.7	Rectangular	√3	(1- c_p)	± 1.9	∞
Spherical isotropy of the probe	± 9.6	Rectangular	√3	(c_p)	± 3.9	∞
Spatial resolution	± 0.0	Rectangular	√3	1	± 0.0	∞
Boundary effects	± 5.5	Rectangular	√3	1	± 3.2	∞
Probe linearity	± 4.7	Rectangular	√3	1	± 2.7	∞
Detection limit	± 1.0	Rectangular	√3	1	± 0.6	∞
Readout electronics	± 1.0	Normal	1	1	± 1.0	∞
Response time	± 0.8	Rectangular	√3	1	± 0.5	∞
Integration time	± 1.4	Rectangular	√3	1	± 0.8	∞
RF ambient conditions	± 3.0	Rectangular	√3	1	± 1.7	∞
Mech. constraints of robot	± 0.4	Rectangular	√3	1	± 0.2	∞
Probe positioning	± 2.9	Rectangular	√3	1	± 1.7	∞
Extrapolation & integration	± 3.9	Rectangular	√3	1	± 2.3	∞
Dipole						
Dipole Axis to Liquid Distance	± 2.0	Rectangular	√3	1	± 1.2	∞
Input Power	± 4.7	Rectangular	√3	1	± 2.7	∞
Phantom and Setup						
Phantom uncertainty	± 4.0	Rectangular	√3	1	± 2.3	∞
Liquid conductivity (target)	± 5.0	Rectangular	√3	0.6	± 1.7	∞
Liquid conductivity (measured)	± 5.0	Rectangular	√3	0.6	± 1.7	∞
Liquid permittivity (target)	± 5.0	Rectangular	√3	0.6	± 1.7	∞
Liquid permittivity (measured)	± 5.0	Rectangular	√3	0.6	± 1.7	∞
Combined Standard Uncertainty					± 10.30	
Expanded Uncertainty (k=2)					± 20.60	

Measurement Uncertainty Table in accordance with IEEE Standard 1528-2003 (see reference [3])

Test Report Serial No.:	050905O6Y-T637-S24T
Test Date(s):	May 11, 2005
Test Type:	FCC SAR Evaluation

16.0 REFERENCES

- [1] Federal Communications Commission, "Radiofrequency radiation exposure evaluation: portable devices", Rule Part 47 CFR §2.1093: 1999.
- [2] Federal Communications Commission, "Evaluating Compliance with FCC Guidelines for Human Exposure to Radio frequency Electromagnetic Fields", OET Bulletin 65, Supplement C (Edition 01-01), FCC, Washington, D.C.: June 2001.
- [3] IEEE Std 1528-2003, "Recommended Practice for Determining the Peak Spatial-Average Specific Absorption Rate (SAR) in the Human Head from Wireless Communications Devices: Measurement Techniques": December 2003.
- [4] ANSI/TIA-603-C, "Land Mobile FM or PM Communications Equipment - Measurement and Performance Standards": December 2004.

Test Report Serial No.:	050905O6Y-T637-S24T
Test Date(s):	May 11, 2005
Test Type:	FCC SAR Evaluation

APPENDIX A - SAR MEASUREMENT DATA

Applicant:	UTStarcom Inc.	Model:	UT611	FCC ID:	O6Y-UT611	
DUT Type:	Portable Single-Mode PAS PHS TDMA Handset	Freq. Range:	1880.15 - 1909.85 MHz			
2005 Celltech Labs Inc. This document is not to be reproduced in whole or in part without the written permission of Celltech Labs Inc. 18 of 49						

Date Tested: 05/11/2005

Head SAR - Right Ear - Tilt Position (15°)

DUT: UTStarcom Model: UT611; Type: Portable Single-Mode PAS PHS Handset; Serial: FCC2

Ambient Temp: 22.4 °C; Fluid Temp: 22.1 °C; Barometric Pressure: 102.3 kPa; Humidity: 34%

Communication System: TDMA
 RF Output Power: 208 mW (EIRP)
 Frequency: 1895.15 MHz; Channel 1; Duty Cycle: 1:8.5
 Li-Polymer Battery Pack, 3.6V 580mAh (P/N: HZSL033450E)
 Medium: HSL1900 ($\sigma = 1.43 \text{ mho/m}$; $\epsilon_r = 38.6$; $\rho = 1000 \text{ kg/m}^3$)

- Probe: ET3DV6 - SN1387; ConvF(5.18, 5.18, 5.18); Calibrated: 18/03/2005
- Sensor-Surface: 4mm (Mechanical And Optical Surface Detection)
- Electronics: DAE3 Sn353; Calibrated: 06/07/2004
- Phantom: SAM 4.0; Type: Fibreglas; Serial: 1033
- Measurement SW: DASy4, V4.5 Build 19; Postprocessing SW: SEMCAD, V1.8 Build 146

Head SAR - Right Ear - Tilt Position (15°) - Mid Channel/Area Scan (8x14x1):
 Measurement grid: dx=10mm, dy=10mm

Head SAR - Right Ear - Tilt Position (15°) - Mid Channel/Zoom Scan (7x7x7)/Cube 0:
 Measurement grid: dx=5mm, dy=5mm, dz=5mm
 Reference Value = 3.83 V/m; Power Drift = 0.0456 dB
 Peak SAR (extrapolated) = 0.042 W/kg
SAR(1 g) = 0.0169 mW/g; SAR(10 g) = 0.00966 mW/g

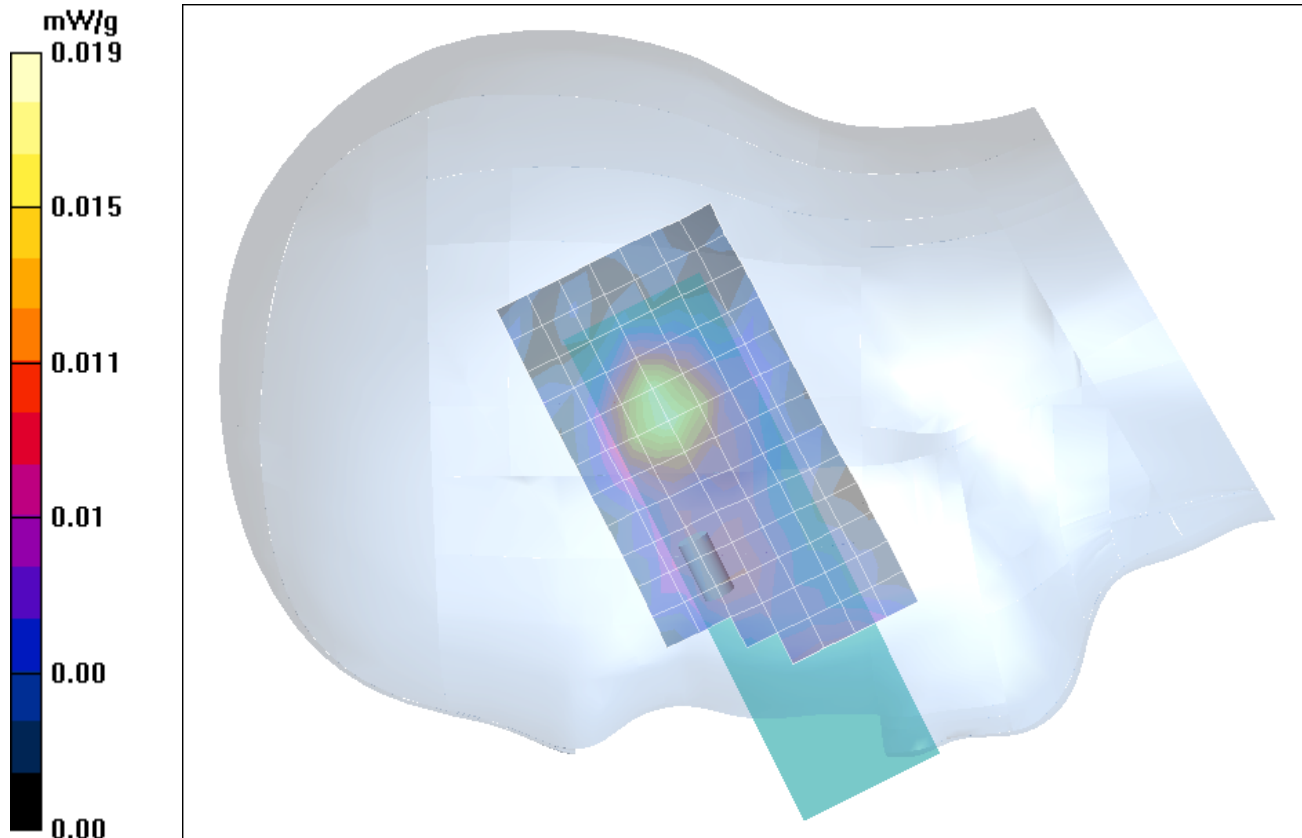

Date Tested: 05/11/2005

Head SAR - Right Ear - Cheek/Touch Position

DUT: UTStarcom Model: UT611; Type: Portable Single-Mode PAS PHS Handset; Serial: FCC2

Ambient Temp: 22.4 °C; Fluid Temp: 22.1 °C; Barometric Pressure: 102.3 kPa; Humidity: 34%

Communication System: TDMA
 RF Output Power: 208 mW (EIRP)
 Frequency: 1895.15 MHz; Channel 1; Duty Cycle: 1:8.5
 Li-Polymer Battery Pack, 3.6V 580mAh (P/N: HZSL033450E)
 Medium: HSL1900 ($\sigma = 1.43 \text{ mho/m}$; $\epsilon_r = 38.6$; $\rho = 1000 \text{ kg/m}^3$)

- Probe: ET3DV6 - SN1387; ConvF(5.18, 5.18, 5.18); Calibrated: 18/03/2005
- Sensor-Surface: 4mm (Mechanical And Optical Surface Detection)
- Electronics: DAE3 Sn353; Calibrated: 06/07/2004
- Phantom: SAM 4.0; Type: Fibreglas; Serial: 1033
- Measurement SW: DASY4, V4.5 Build 19; Postprocessing SW: SEMCAD, V1.8 Build 146

Head SAR - Right Ear - Cheek/Touch Position - Mid Channel/Area Scan (8x14x1):

Measurement grid: dx=10mm, dy=10mm

Head SAR - Right Ear - Cheek/Touch Position - Mid Channel/Zoom Scan (7x7x7)/Cube 0:

Measurement grid: dx=5mm, dy=5mm, dz=5mm
 Reference Value = 6.92 V/m; Power Drift = -0.0327 dB
 Peak SAR (extrapolated) = 0.093 W/kg
SAR(1 g) = 0.0575 mW/g; SAR(10 g) = 0.033 mW/g

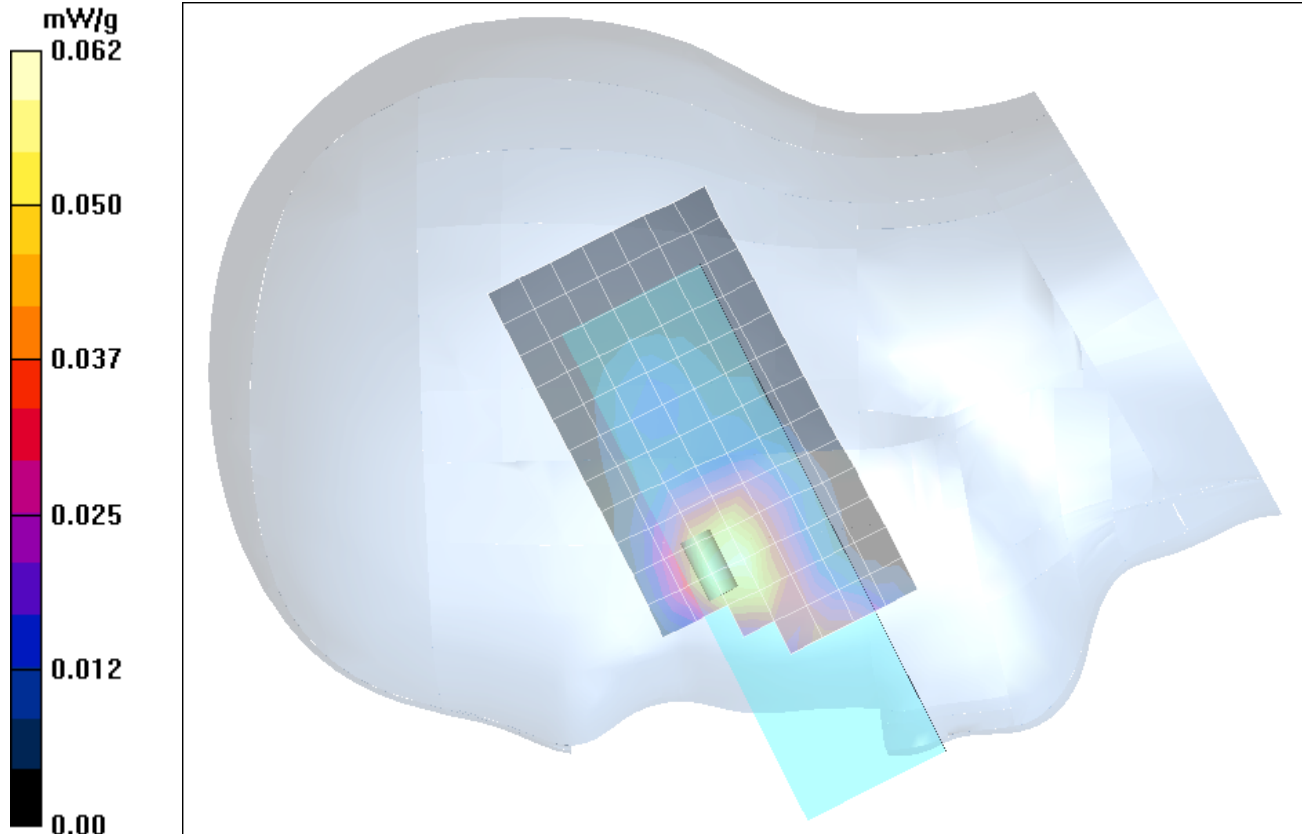

Date Tested: 05/11/2005

Head SAR - Right Ear - Cheek/Touch Position

DUT: UTStarcom Model: UT611; Type: Portable Single-Mode PAS PHS Handset; Serial: FCC2

Ambient Temp: 22.4 °C; Fluid Temp: 22.1 °C; Barometric Pressure: 102.3 kPa; Humidity: 34%

Communication System: TDMA
 RF Output Power: 232 mW (EIRP)
 Frequency: 1909.85 MHz; Channel 50; Duty Cycle: 1:8.5
 Li-Polymer Battery Pack, 3.6V 580mAh (P/N: HZSL033450E)
 Medium: HSL1900 ($\sigma = 1.43 \text{ mho/m}$; $\epsilon_r = 38.6$; $\rho = 1000 \text{ kg/m}^3$)

- Probe: ET3DV6 - SN1387; ConvF(5.18, 5.18, 5.18); Calibrated: 18/03/2005
- Sensor-Surface: 4mm (Mechanical And Optical Surface Detection)
- Electronics: DAE3 Sn353; Calibrated: 06/07/2004
- Phantom: SAM 4.0; Type: Fibreglas; Serial: 1033
- Measurement SW: DASy4, V4.5 Build 19; Postprocessing SW: SEMCAD, V1.8 Build 146

Head SAR - Right Ear - Cheek/Touch Position - High Channel/Area Scan (8x14x1):

Measurement grid: dx=10mm, dy=10mm

Head SAR - Right Ear - Cheek/Touch Position - High Channel/Zoom Scan (7x7x7)/Cube 0:

Measurement grid: dx=5mm, dy=5mm, dz=5mm
 Reference Value = 7.16 V/m; Power Drift = 0.00546 dB
 Peak SAR (extrapolated) = 0.092 W/kg
SAR(1 g) = 0.0595 mW/g; SAR(10 g) = 0.034 mW/g

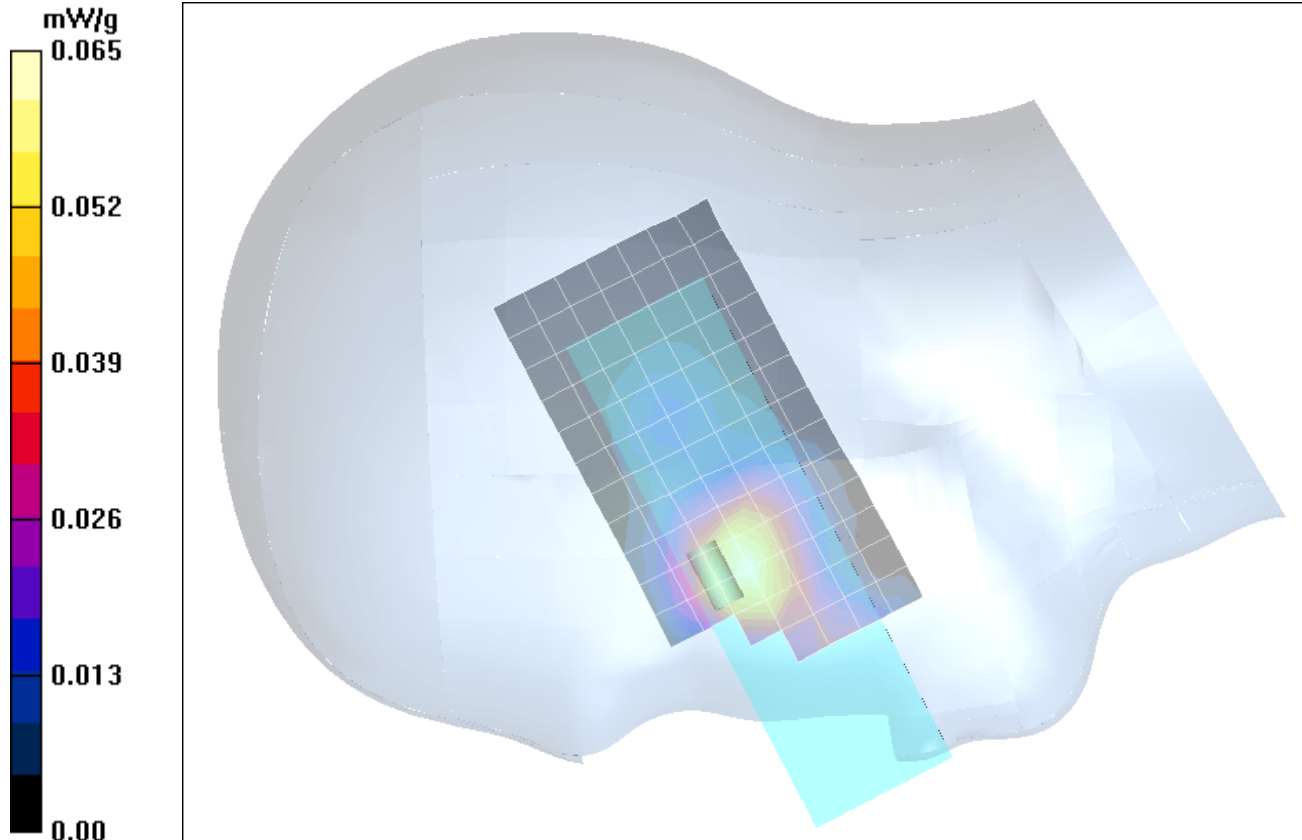

Date Tested: 05/11/2005

Head SAR - Left Ear - Tilt Position (15°)

DUT: UTStarcom Model: UT611; Type: Portable Single-Mode PAS PHS Handset; Serial: FCC2

Ambient Temp: 22.4 °C; Fluid Temp: 22.1 °C; Barometric Pressure: 102.3 kPa; Humidity: 34%

Communication System: TDMA
 RF Output Power: 208 mW (EIRP)
 Frequency: 1895.15 MHz; Channel 1; Duty Cycle: 1:8.5
 Li-Polymer Battery Pack, 3.6V 580mAh (P/N: HZSL033450E)
 Medium: HSL1900 ($\sigma = 1.43 \text{ mho/m}$; $\epsilon_r = 38.6$; $\rho = 1000 \text{ kg/m}^3$)

- Probe: ET3DV6 - SN1387; ConvF(5.18, 5.18, 5.18); Calibrated: 18/03/2005
- Sensor-Surface: 4mm (Mechanical And Optical Surface Detection)
- Electronics: DAE3 Sn353; Calibrated: 06/07/2004
- Phantom: SAM 4.0; Type: Fiberglass; Serial: 1033
- Measurement SW: DASY4, V4.5 Build 19; Postprocessing SW: SEMCAD, V1.8 Build 146

Head SAR - Left Ear - Tilt Position (15°) - Mid Channel/Area Scan (8x14x1):

Measurement grid: dx=10mm, dy=10mm

Head SAR - Left Ear - Tilt Position (15°) - Mid Channel/Zoom Scan (7x7x7)/Cube 0:

Measurement grid: dx=5mm, dy=5mm, dz=5mm
 Reference Value = 3.61 V/m; Power Drift = 0.102 dB
 Peak SAR (extrapolated) = 0.029 W/kg
SAR(1 g) = 0.0160 mW/g; SAR(10 g) = 0.00982 mW/g

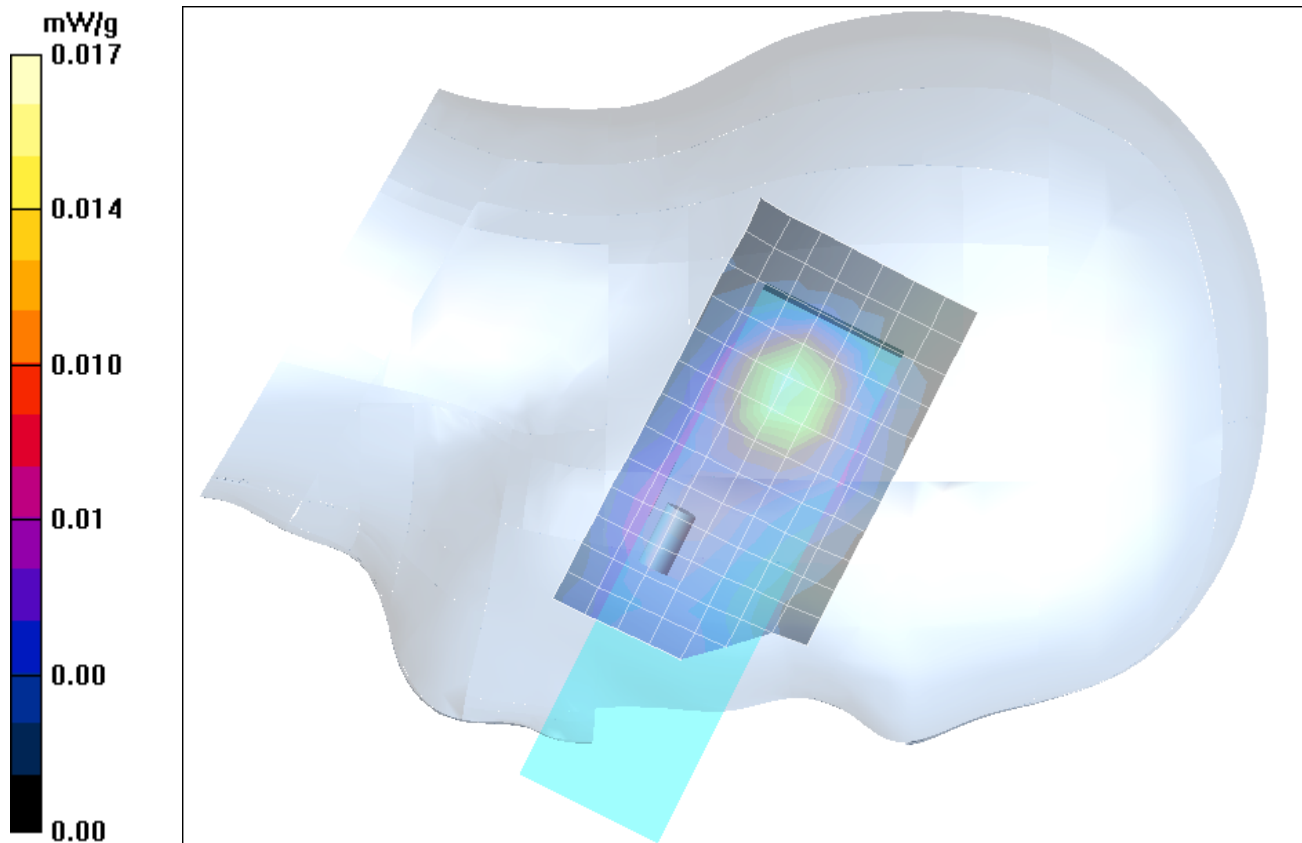

Date Tested: 05/11/2005

Head SAR - Left Ear - Cheek/Touch Position

DUT: UTStarcom Model: UT611; Type: Portable Single-Mode PAS PHS Handset; Serial: FCC2

Ambient Temp: 22.4 °C; Fluid Temp: 22.1 °C; Barometric Pressure: 102.3 kPa; Humidity: 34%

Communication System: TDMA
 RF Output Power: 208 mW (EIRP)
 Frequency: 1895.15 MHz; Channel 1; Duty Cycle: 1:8.5
 Li-Polymer Battery Pack, 3.6V 580mAh (P/N: HZSL033450E)
 Medium: HSL1900 ($\sigma = 1.43 \text{ mho/m}$; $\epsilon_r = 38.6$; $\rho = 1000 \text{ kg/m}^3$)

- Probe: ET3DV6 - SN1387; ConvF(5.18, 5.18, 5.18); Calibrated: 18/03/2005
- Sensor-Surface: 4mm (Mechanical And Optical Surface Detection)
- Electronics: DAE3 Sn353; Calibrated: 06/07/2004
- Phantom: SAM 4.0; Type: Fiberglass; Serial: 1033
- Measurement SW: DASY4, V4.5 Build 19; Postprocessing SW: SEMCAD, V1.8 Build 146

Head SAR - Left Ear - Cheek/Touch Position - Mid Channel/Area Scan (8x14x1):

Measurement grid: dx=10mm, dy=10mm

Head SAR - Left Ear - Cheek/Touch Position - Mid Channel/Zoom Scan (7x7x7)/Cube 0:

Measurement grid: dx=5mm, dy=5mm, dz=5mm
 Reference Value = 7.07 V/m; Power Drift = 0.00575 dB
 Peak SAR (extrapolated) = 0.097 W/kg
SAR(1 g) = 0.0640 mW/g; SAR(10 g) = 0.037 mW/g

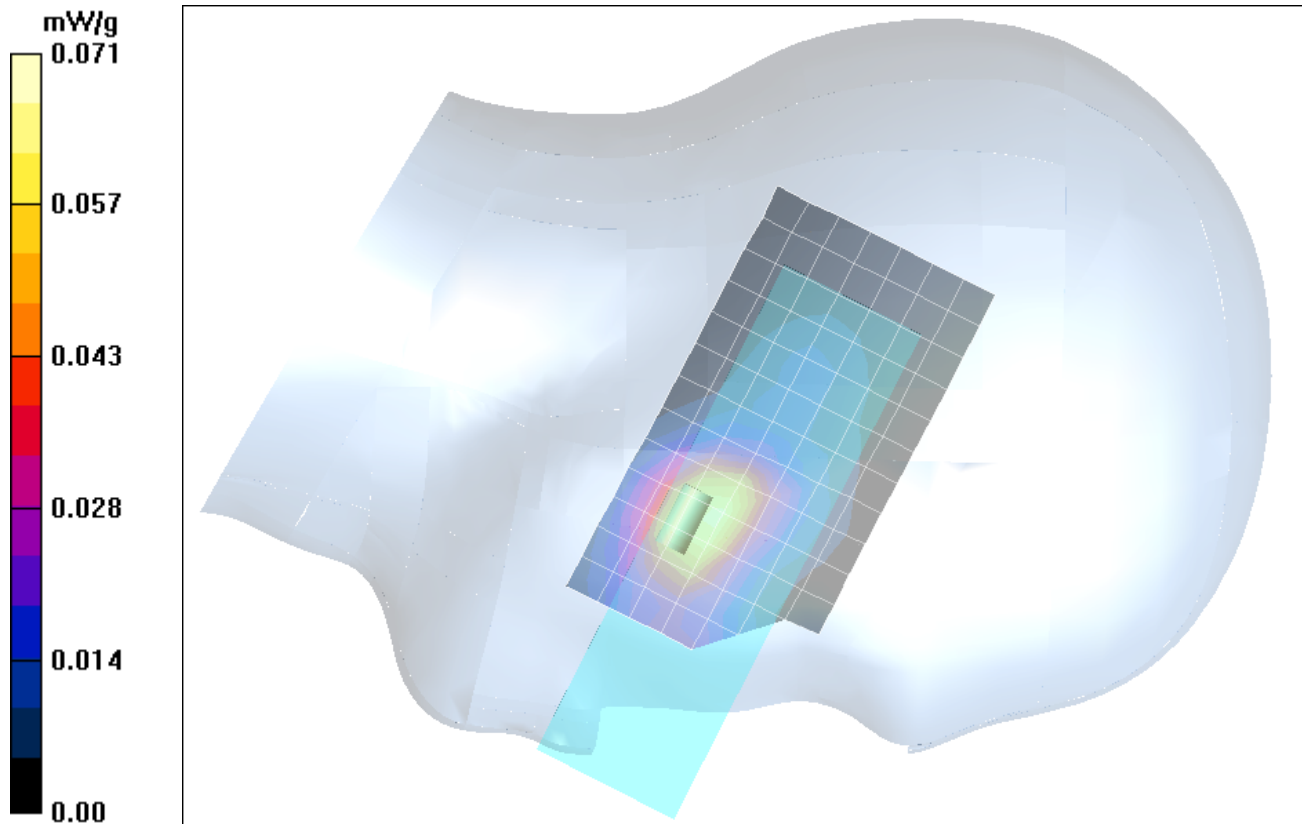

Date Tested: 05/11/2005

Head SAR - Left Ear - Cheek/Touch Position

DUT: UTStarcom Model: UT611; Type: Portable Single-Mode PAS PHS Handset; Serial: FCC2

Ambient Temp: 22.4 °C; Fluid Temp: 22.1 °C; Barometric Pressure: 102.3 kPa; Humidity: 34%

Communication System: TDMA
 RF Output Power: 232 mW (EIRP)
 Frequency: 1909.85 MHz; Channel 50; Duty Cycle: 1:8.5
 Li-Polymer Battery Pack, 3.6V 580mAh (P/N: HZSL033450E)
 Medium: HSL1900 ($\sigma = 1.43 \text{ mho/m}$; $\epsilon_r = 38.6$; $\rho = 1000 \text{ kg/m}^3$)

- Probe: ET3DV6 - SN1387; ConvF(5.18, 5.18, 5.18); Calibrated: 18/03/2005
- Sensor-Surface: 4mm (Mechanical And Optical Surface Detection)
- Electronics: DAE3 Sn353; Calibrated: 06/07/2004
- Phantom: SAM 4.0; Type: Fibreglas; Serial: 1033
- Measurement SW: DASY4, V4.5 Build 19; Postprocessing SW: SEMCAD, V1.8 Build 146

Head SAR - Left Ear - Cheek/Touch Position - High Channel/Area Scan (8x14x1):

Measurement grid: dx=10mm, dy=10mm

Head SAR - Left Ear - Cheek/Touch Position - High Channel/Zoom Scan (7x7x7)/Cube 0:

Measurement grid: dx=5mm, dy=5mm, dz=5mm
 Reference Value = 7.12 V/m; Power Drift = 0.0114 dB
 Peak SAR (extrapolated) = 0.104 W/kg
SAR(1 g) = 0.0652 mW/g; SAR(10 g) = 0.038 mW/g

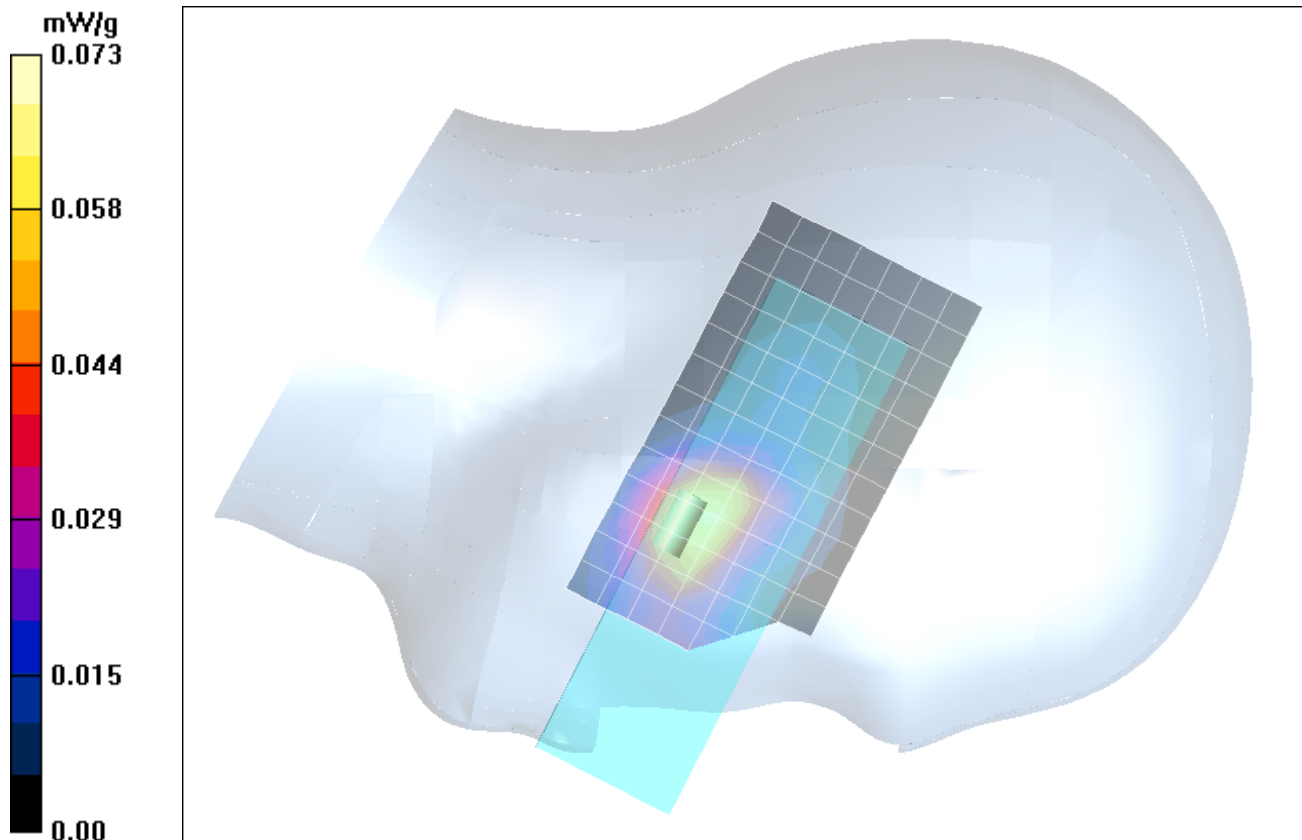

Z-Axis Scan

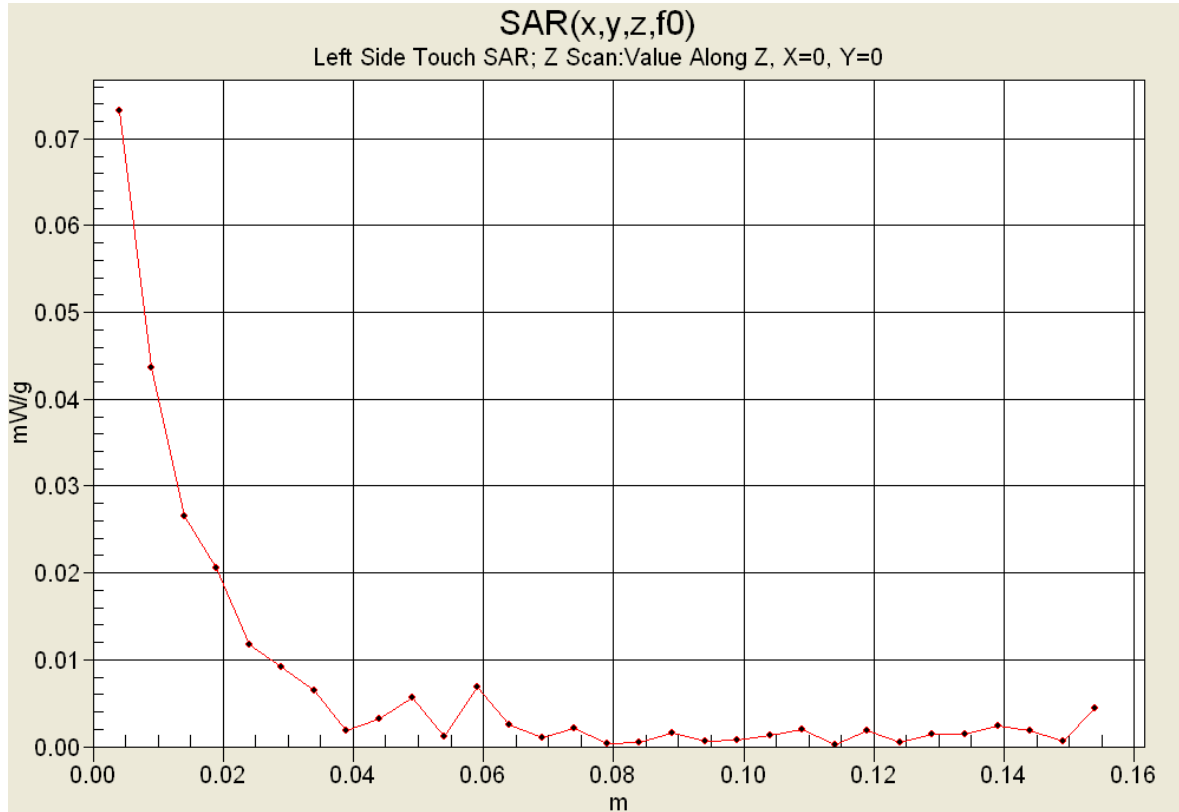

Fluid Depth >15 cm

Applicant:	UTStarcom Inc.	Model:	UT611	FCC ID:	O6Y-UT611	
DUT Type:	Portable Single-Mode PAS PHS TDMA Handset	Freq. Range:	1880.15 - 1909.85 MHz			
2005 Celltech Labs Inc. This document is not to be reproduced in whole or in part without the written permission of Celltech Labs Inc.						25 of 49

Date Tested: 05/11/2005

Body-Worn SAR - Front Side of DUT - LCD Closed Position - 0.0 cm Air-Gap Spacing

DUT: UTStarcom Model: UT611; Type: Portable Single-Mode PAS PHS Handset; Serial: FCC2

Audio Accessory: Ear-Microphone (Model: EE-610-41)

Ambient Temp: 24.3 °C; Fluid Temp: 22.4 °C; Barometric Pressure: 102.0 kPa; Humidity: 33%

Communication System: TDMA
 RF Output Power: 208 mW (EIRP)
 Frequency: 1895.15 MHz; Channel 1; Duty Cycle: 1:8.5
 Li-Polymer Battery Pack, 3.6V 580mAh (P/N: HZSL033450E)
 Medium: M1900 ($\sigma = 1.54 \text{ mho/m}$; $\epsilon_r = 50.8$; $\rho = 1000 \text{ kg/m}^3$)

- Probe: ET3DV6 - SN1387; ConvF(4.75, 4.75, 4.75); Calibrated: 18/03/2005
- Sensor-Surface: 4mm (Mechanical And Optical Surface Detection)
- Electronics: DAE3 Sn353; Calibrated: 06/07/2004
- Phantom: SAM 4.0; Type: Fiberglas; Serial: 1033
- Measurement SW: DASY4, V4.5 Build 19; Postprocessing SW: SEMCAD, V1.8 Build 146

Body-Worn - 0.0 cm Air-Gap Spacing from Front Side of DUT to Planar Phantom (LCD Closed) - Mid Channel Area Scan (6x9x1): Measurement grid: dx=15mm, dy=15mm

Body-Worn - 0.0 cm Air-Gap Spacing from Front Side of DUT to Planar Phantom (LCD Closed) - Mid Channel Zoom Scan (7x7x7)/Cube 0: Measurement grid: dx=5mm, dy=5mm, dz=5mm

Reference Value = 5.16 V/m; Power Drift = 0.0466 dB
 Peak SAR (extrapolated) = 0.073 W/kg
SAR(1 g) = 0.0466 mW/g; SAR(10 g) = 0.0267 mW/g

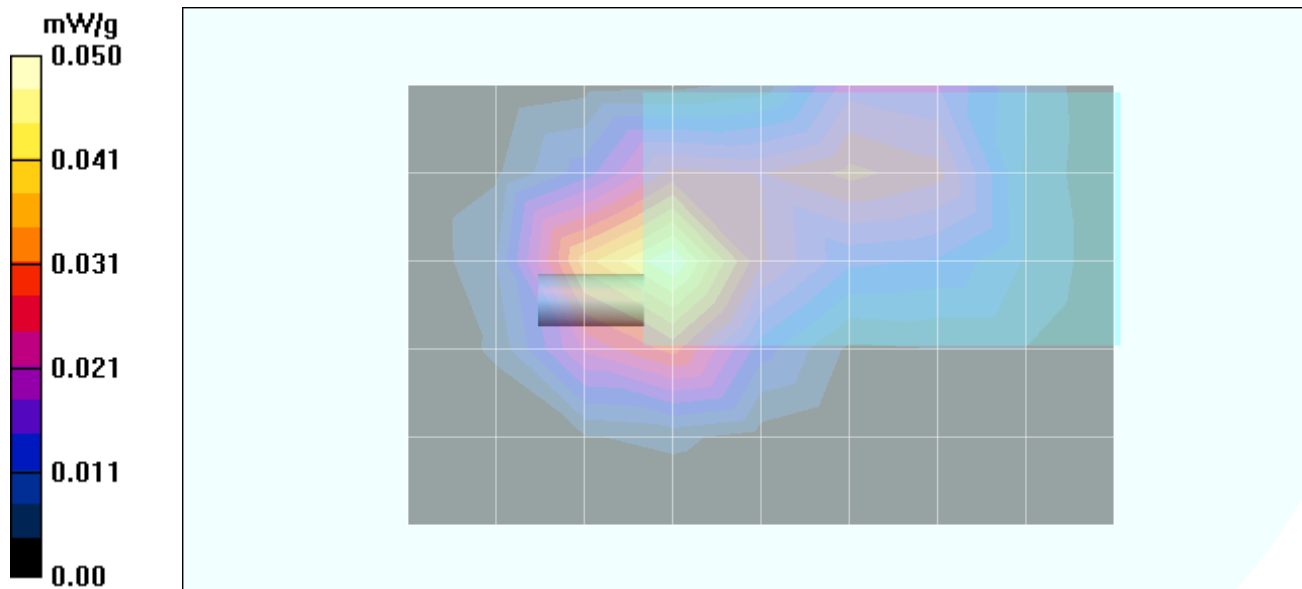

Date Tested: 05/11/2005

Body-Worn SAR - Back Side of DUT - LCD Closed Position - 0.0 cm Air-Gap Spacing

DUT: UTStarcom Model: UT611; Type: Portable Single-Mode PAS PHS Handset; Serial: FCC2

Audio Accessory: Ear-Microphone (Model: EE-610-41)

Ambient Temp: 24.3 °C; Fluid Temp: 22.4 °C; Barometric Pressure: 102.0 kPa; Humidity: 33%

Communication System: TDMA
 RF Output Power: 208 mW (EIRP)
 Frequency: 1895.15 MHz; Channel 1; Duty Cycle: 1:8.5
 Li-Polymer Battery Pack, 3.6V 580mAh (P/N: HZSL033450E)
 Medium: M1900 ($\sigma = 1.54$ mho/m; $\epsilon_r = 50.8$; $\rho = 1000$ kg/m³)

- Probe: ET3DV6 - SN1387; ConvF(4.75, 4.75, 4.75); Calibrated: 18/03/2005
- Sensor-Surface: 4mm (Mechanical And Optical Surface Detection)
- Electronics: DAE3 Sn353; Calibrated: 06/07/2004
- Phantom: SAM 4.0; Type: Fiberglass; Serial: 1033
- Measurement SW: DASY4, V4.5 Build 19; Postprocessing SW: SEMCAD, V1.8 Build 146

Body-Worn - 0.0 cm Air-Gap Spacing from Back Side of DUT to Planar Phantom (LCD Closed) - Mid Channel Area Scan (6x9x1): Measurement grid: dx=15mm, dy=15mm

Body-Worn - 0.0 cm Air-Gap Spacing from Back Side of DUT to Planar Phantom (LCD Closed) - Mid Channel Zoom Scan (7x7x7)/Cube 0: Measurement grid: dx=5mm, dy=5mm, dz=5mm

Reference Value = 9.36 V/m; Power Drift = -0.0938 dB
 Peak SAR (extrapolated) = 0.627 W/kg
SAR(1 g) = 0.305 mW/g; SAR(10 g) = 0.136 mW/g

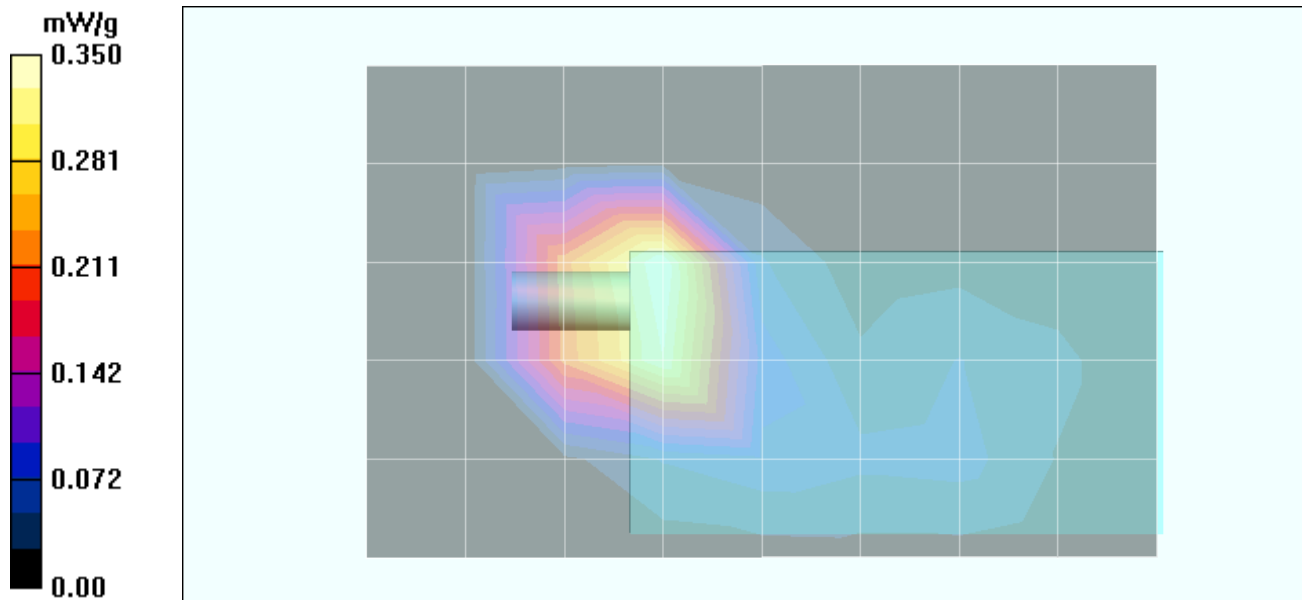

Date Tested: 05/11/2005

Body-Worn SAR - Back Side of DUT - LCD Closed Position - 0.0 cm Air-Gap Spacing

DUT: UTStarcom Model: UT611; Type: Portable Single-Mode PAS PHS Handset; Serial: FCC2

Audio Accessory: Ear-Microphone (Model: EE-610-41)

Ambient Temp: 24.3 °C; Fluid Temp: 22.4 °C; Barometric Pressure: 102.0 kPa; Humidity: 33%

Communication System: TDMA
 RF Output Power: 232 mW (EIRP)
 Frequency: 1909.85 MHz; Channel 50; Duty Cycle: 1:8.5
 Li-Polymer Battery Pack, 3.6V 580mAh (P/N: HZSL033450E)
 Medium: M1900 ($\sigma = 1.54 \text{ mho/m}$; $\epsilon_r = 50.8$; $\rho = 1000 \text{ kg/m}^3$)

- Probe: ET3DV6 - SN1387; ConvF(4.75, 4.75, 4.75); Calibrated: 18/03/2005
- Sensor-Surface: 4mm (Mechanical And Optical Surface Detection)
- Electronics: DAE3 Sn353; Calibrated: 06/07/2004
- Phantom: SAM 4.0; Type: Fiberglas; Serial: 1033
- Measurement SW: DASY4, V4.5 Build 19; Postprocessing SW: SEMCAD, V1.8 Build 146

Body-Worn - 0.0 cm Air-Gap Spacing from Back Side of DUT to Planar Phantom (LCD Closed) - High Channel Area Scan (6x9x1): Measurement grid: dx=15mm, dy=15mm

Body-Worn - 0.0 cm Air-Gap Spacing from Back Side of DUT to Planar Phantom (LCD Closed) - High Channel Zoom Scan (7x7x7)/Cube 0: Measurement grid: dx=5mm, dy=5mm, dz=5mm
 Reference Value = 10.3 V/m; Power Drift = 0.142 dB
 Peak SAR (extrapolated) = 0.802 W/kg
SAR(1 g) = 0.395 mW/g; SAR(10 g) = 0.171 mW/g

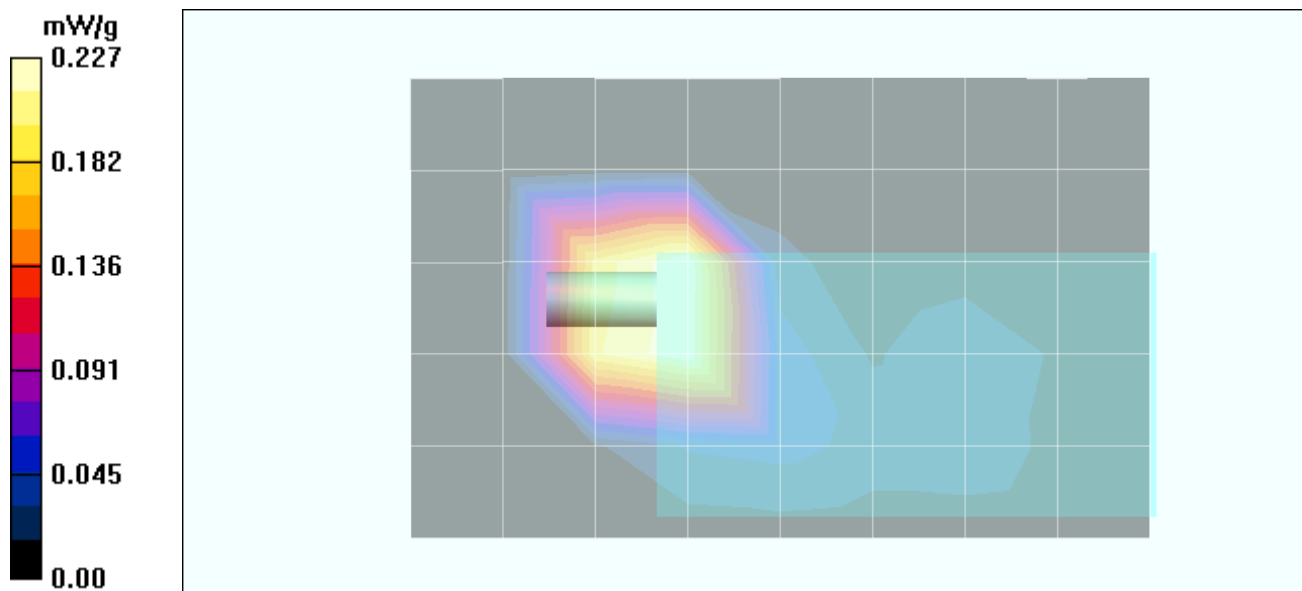

Z-Axis Scan

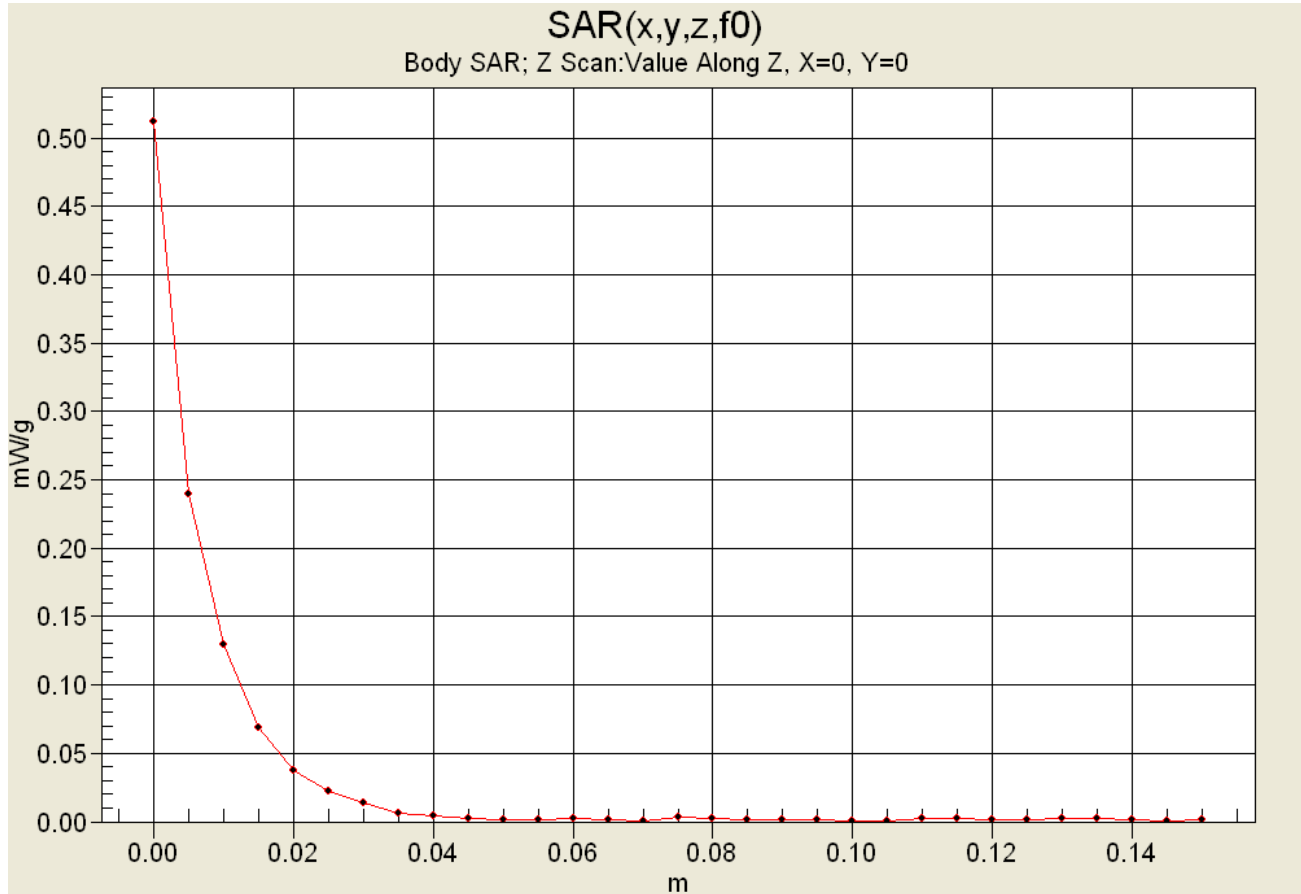

Test Report Serial No.:	050905O6Y-T637-S24T
Test Date(s):	May 11, 2005
Test Type:	FCC SAR Evaluation

APPENDIX B - SYSTEM PERFORMANCE CHECK DATA

Applicant:	UTStarcom Inc.	Model:	UT611	FCC ID:	O6Y-UT611	
DUT Type:	Portable Single-Mode PAS PHS TDMA Handset	Freq. Range:	1880.15 - 1909.85 MHz			
2005 Celltech Labs Inc. This document is not to be reproduced in whole or in part without the written permission of Celltech Labs Inc.						30 of 49

Date Tested: 05/11/2005

System Performance Check - 1900 MHz Dipole

DUT: Dipole 1900 MHz; Model: D1900V2; Type: System Performance Check; Serial: 151; Calibrated: 06/18/2004

Ambient Temp: 22.4 °C; Fluid Temp: 22.1 °C; Barometric Pressure: 102.4 kPa; Humidity: 34%

Communication System: CW
 Forward Conducted Power: 250 mW
 Frequency: 1900 MHz; Duty Cycle: 1:1
 Medium: HSL1900 ($\sigma = 1.43 \text{ mho/m}$; $\epsilon_r = 38.6$; $\rho = 1000 \text{ kg/m}^3$)

- Probe: ET3DV6 - SN1387; ConvF(5.18, 5.18, 5.18); Calibrated: 18/03/2005
- Sensor-Surface: 4mm (Mechanical And Optical Surface Detection)
- Electronics: DAE3 Sn353; Calibrated: 06/07/2004
- Phantom: SAM 4.0; Type: Fiberglas; Serial: 1033
- Measurement SW: DASY4, V4.5 Build 19; Postprocessing SW: SEMCAD, V1.8 Build 146

1900 MHz Dipole - System Performance Check/Area Scan (5x8x1):

Measurement grid: dx=15mm, dy=15mm

1900 MHz Dipole - System Performance Check/Zoom Scan (7x7x7)/Cube 0:

Measurement grid: dx=5mm, dy=5mm, dz=5mm
 Reference Value = 97.6 V/m; Power Drift = -0.078 dB
 Peak SAR (extrapolated) = 19.0 W/kg
SAR(1 g) = 10.8 mW/g; SAR(10 g) = 5.6 mW/g

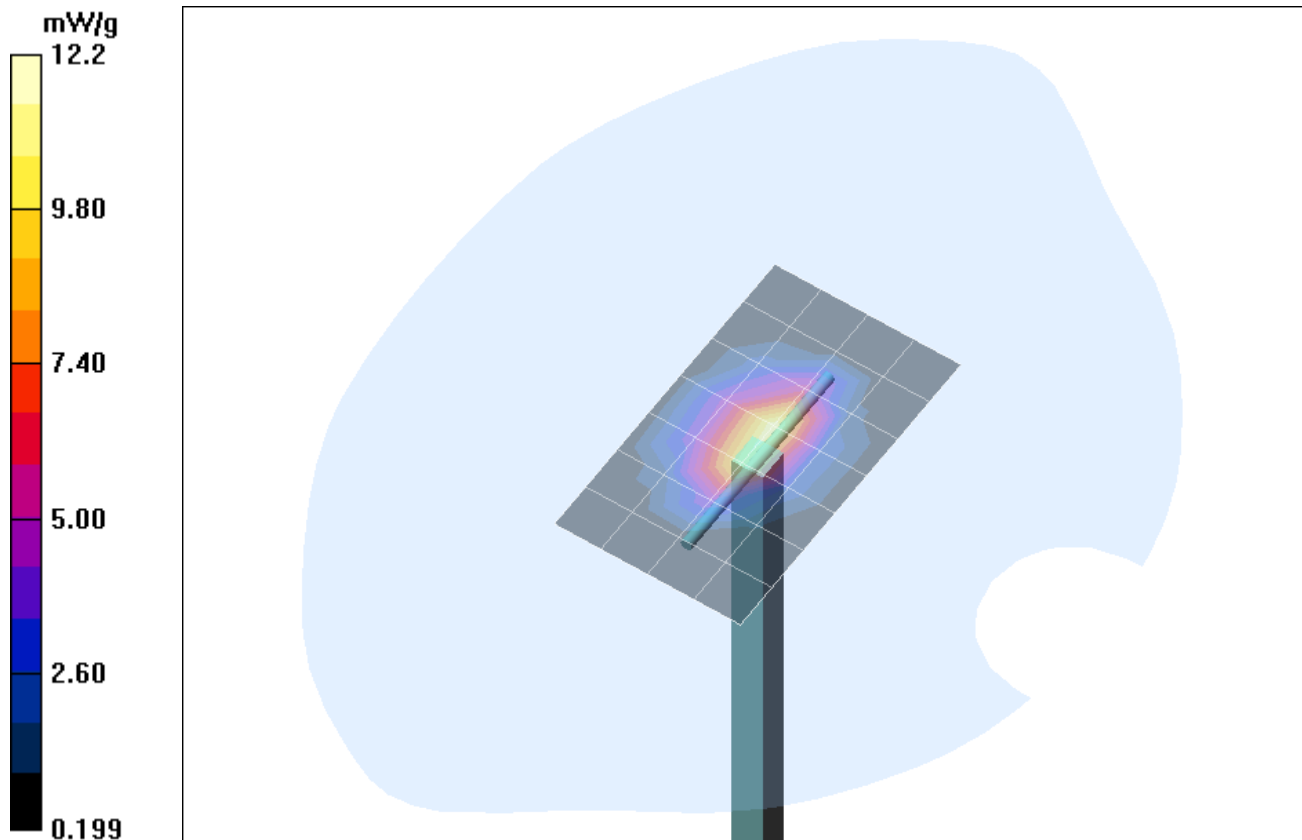

Applicant:	UTStarcom Inc.	Model:	UT611	FCC ID:	O6Y-UT611	
DUT Type:	Portable Single-Mode PAS PHS TDMA Handset	Freq. Range:	1880.15 - 1909.85 MHz			
2005 Celltech Labs Inc.		This document is not to be reproduced in whole or in part without the written permission of Celltech Labs Inc.				31 of 49

Z-Axis Scan

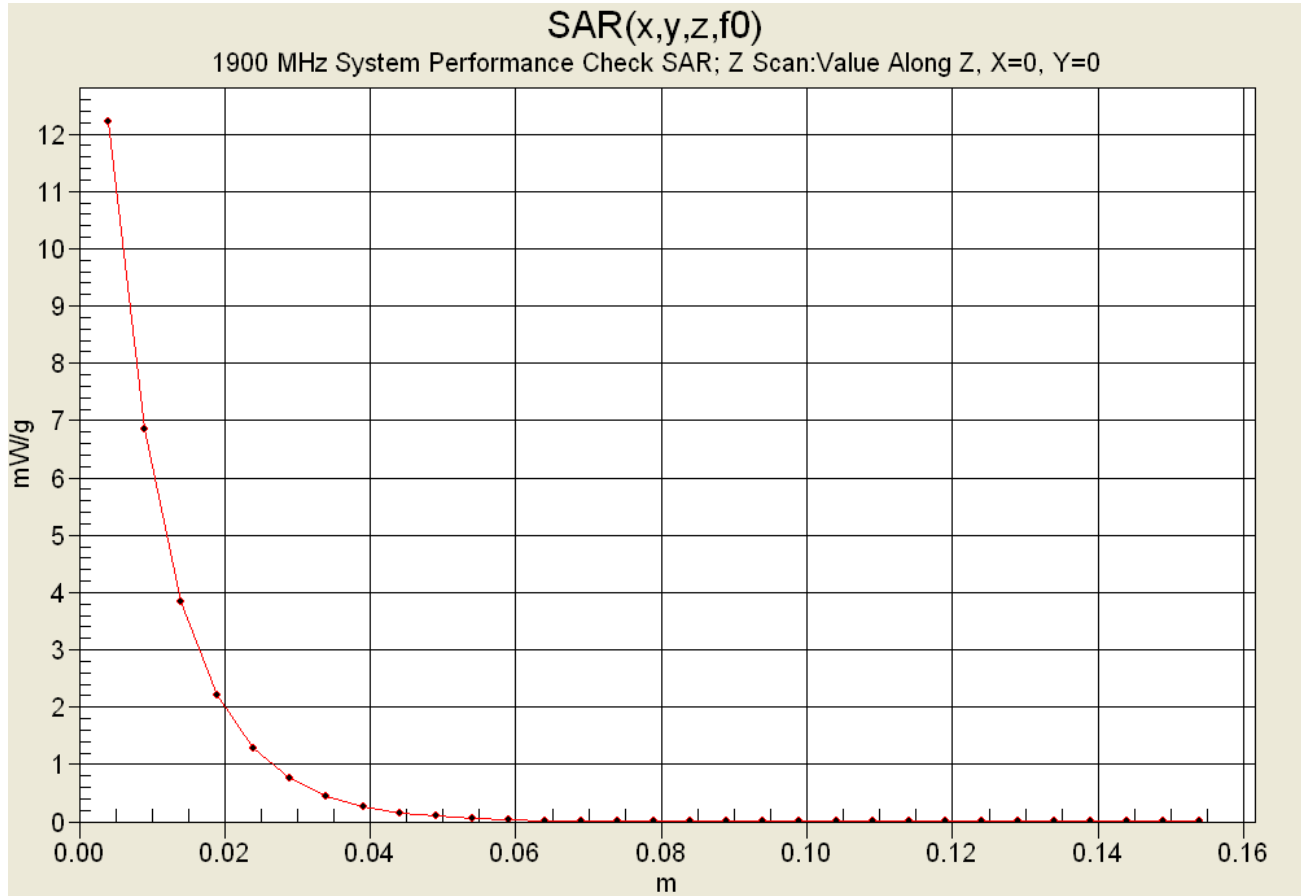

Test Report Serial No.:	050905O6Y-T637-S24T
Test Date(s):	May 11, 2005
Test Type:	FCC SAR Evaluation

APPENDIX C - MEASURED FLUID DIELECTRIC PARAMETERS

Applicant:	UTStarcom Inc.	Model:	UT611	FCC ID:	O6Y-UT611	
DUT Type:	Portable Single-Mode PAS PHS TDMA Handset	Freq. Range:	1880.15 - 1909.85 MHz			
2005 Celltech Labs Inc.		This document is not to be reproduced in whole or in part without the written permission of Celltech Labs Inc.				33 of 49

1900 MHz System Performance Check & DUT Evaluation (Head)

Celltech Labs Inc.

Test Result for UIM Dielectric Parameter

wed 11/May/2005

Freq Frequency(GHz)

FCC_eH FCC OET 65 Supplement C (June 2001) Limits for Head Epsilon

FCC_sH FCC OET 65 Supplement C (June 2001) Limits for Head Sigma

Test_e Epsilon of UIM

Test_s Sigma of UIM

Freq	FCC_eH	FCC_sH	Test_e	Test_s
1.8000	40.00	1.40	39.13	1.33
1.8100	40.00	1.40	39.00	1.35
1.8200	40.00	1.40	38.97	1.35
1.8300	40.00	1.40	38.85	1.36
1.8400	40.00	1.40	38.82	1.38
1.8500	40.00	1.40	38.80	1.38
1.8600	40.00	1.40	38.77	1.39
1.8700	40.00	1.40	38.76	1.40
1.8800	40.00	1.40	38.63	1.40
1.8900	40.00	1.40	38.60	1.41
1.9000	40.00	1.40	38.55	1.43
1.9100	40.00	1.40	38.48	1.44
1.9200	40.00	1.40	38.43	1.44
1.9300	40.00	1.40	38.44	1.46
1.9400	40.00	1.40	38.33	1.47
1.9500	40.00	1.40	38.27	1.48
1.9600	40.00	1.40	38.13	1.49
1.9700	40.00	1.40	38.27	1.50
1.9800	40.00	1.40	38.19	1.51
1.9900	40.00	1.40	38.03	1.52
2.0000	40.00	1.40	38.00	1.53

Applicant:	UTStarcom Inc.	Model:	UT611	FCC ID:	O6Y-UT611	
DUT Type:	Portable Single-Mode PAS PHS TDMA Handset	Freq. Range:	1880.15 - 1909.85 MHz			
2005 Celltech Labs Inc. This document is not to be reproduced in whole or in part without the written permission of Celltech Labs Inc. 34 of 49						

1900 MHz DUT Evaluation (Body)

Celltech Labs Inc.

Test Result for UIM Dielectric Parameter

wed 11/May/2005

Freq Frequency(GHz)

FCC_eH FCC Bulletin 65 Supplement C (June 2001) Limits for Head Epsilon

FCC_sH FCC Bulletin 65 Supplement C (June 2001) Limits for Head Sigma

FCC_eB FCC Limits for Body Epsilon

FCC_sB FCC Limits for Body Sigma

Test_e Epsilon of UIM

Test_s Sigma of UIM

Freq	FCC_eB	FCC_sB	Test_e	Test_s
1.8000	53.30	1.52	51.43	1.44
1.8100	53.30	1.52	51.39	1.45
1.8200	53.30	1.52	51.33	1.47
1.8300	53.30	1.52	51.25	1.47
1.8400	53.30	1.52	51.13	1.49
1.8500	53.30	1.52	51.14	1.49
1.8600	53.30	1.52	50.99	1.50
1.8700	53.30	1.52	51.12	1.50
1.8800	53.30	1.52	50.90	1.51
1.8900	53.30	1.52	50.86	1.54
1.9000	53.30	1.52	50.84	1.54
1.9100	53.30	1.52	50.76	1.56
1.9200	53.30	1.52	50.69	1.55
1.9300	53.30	1.52	50.68	1.57
1.9400	53.30	1.52	50.62	1.58
1.9500	53.30	1.52	50.56	1.60
1.9600	53.30	1.52	50.54	1.61
1.9700	53.30	1.52	50.69	1.62
1.9800	53.30	1.52	50.51	1.63
1.9900	53.30	1.52	50.41	1.63
2.0000	53.30	1.52	50.28	1.66

Test Report Serial No.:	050905O6Y-T637-S24T
Test Date(s):	May 11, 2005
Test Type:	FCC SAR Evaluation

APPENDIX D - SAR TEST SETUP & DUT PHOTOGRAPHS

Applicant:	UTStarcom Inc.	Model:	UT611	FCC ID:	O6Y-UT611	
DUT Type:	Portable Single-Mode PAS PHS TDMA Handset	Freq. Range:	1880.15 - 1909.85 MHz			
2005 Celltech Labs Inc.		This document is not to be reproduced in whole or in part without the written permission of Celltech Labs Inc.				36 of 49

HEAD SAR TEST SETUP PHOTOGRAPHS
Left Head Section / Cheek-Touch Position

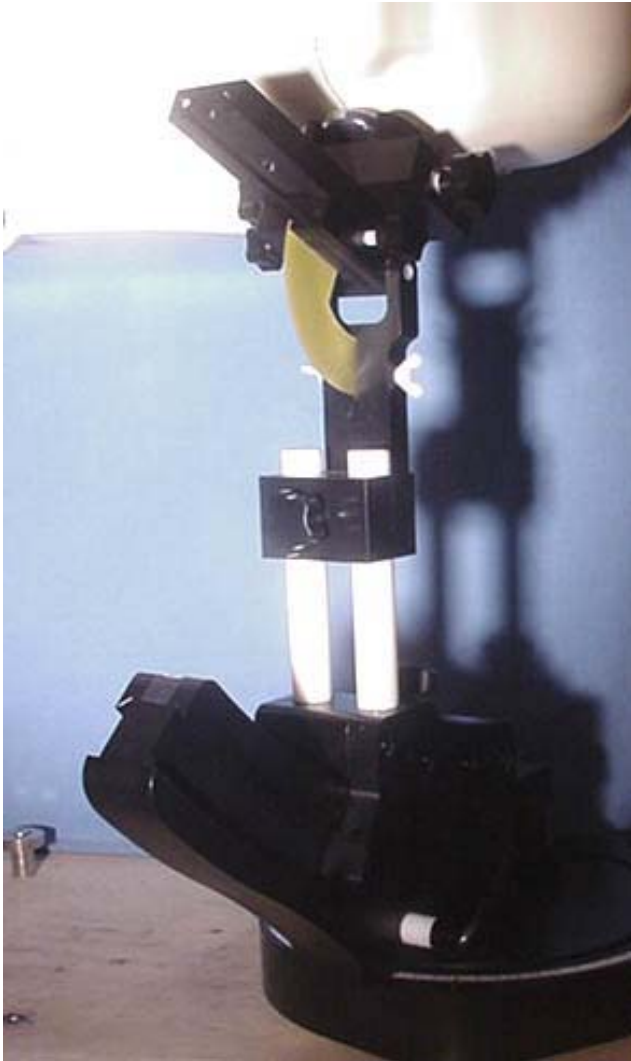

HEAD SAR TEST SETUP PHOTOGRAPHS
Left Head Section / Ear-Tilt Position (15°)



HEAD SAR TEST SETUP PHOTOGRAPHS
Right Head Section / Cheek-Touch Position



HEAD SAR TEST SETUP PHOTOGRAPHS
Right Head Section / Ear-Tilt Position (15 °)

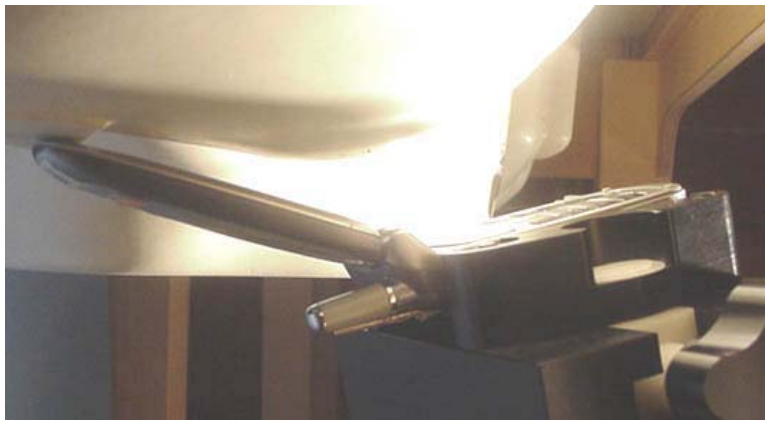

BODY-WORN SAR TEST SETUP PHOTOGRAPHS
 0.0 cm Air-Gap Spacing from Front Side of DUT (LCD Closed) to Planar Phantom
 with Ear-Microphone Audio Accessory

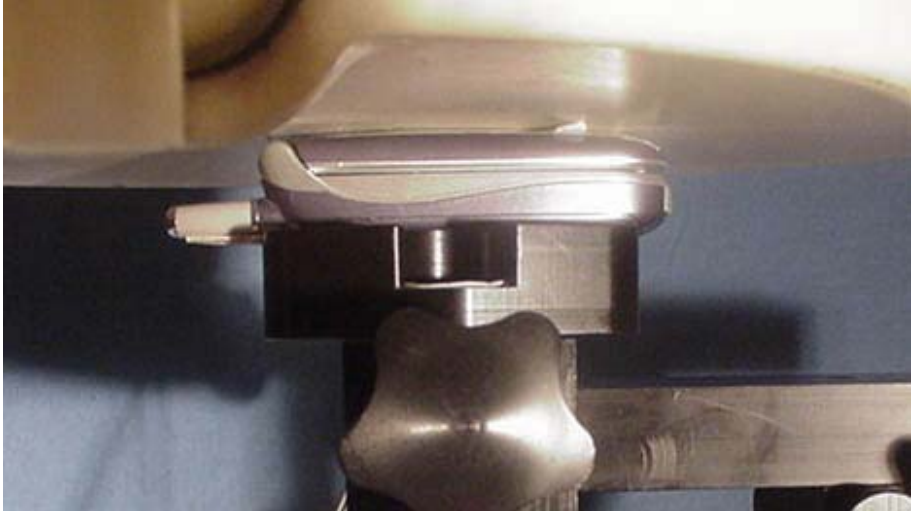

BODY-WORN SAR TEST SETUP PHOTOGRAPHS
0.0 cm Air-Gap Spacing from Back Side of DUT (LCD Closed) to Planar Phantom
with Ear-Microphone Audio Accessory

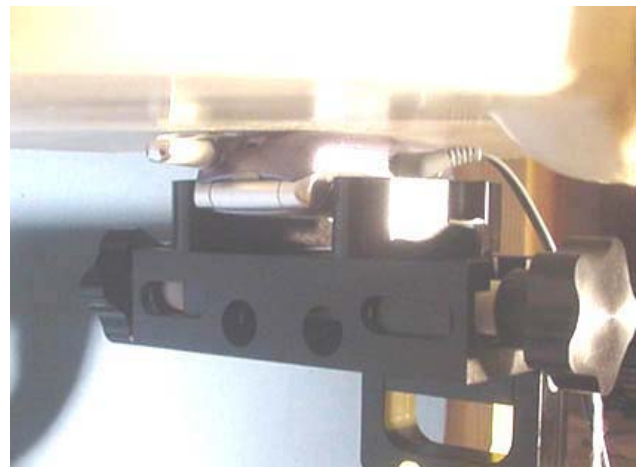
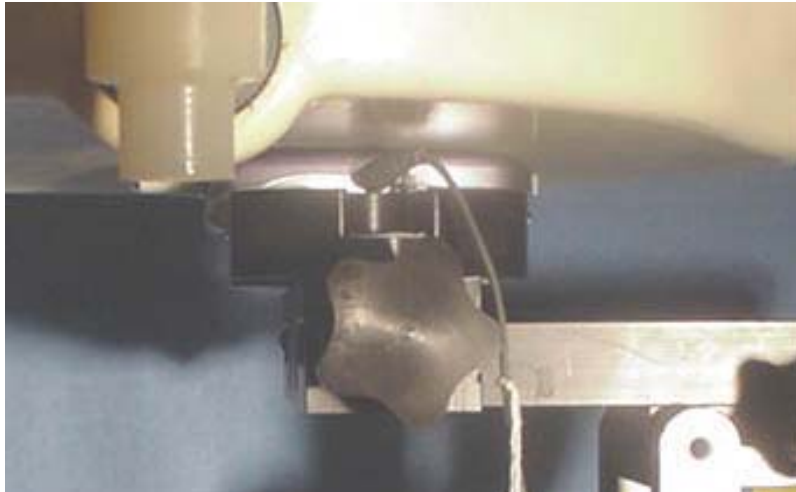

DUT PHOTOGRAPHS



Front of DUT



Back of DUT

DUT PHOTOGRAPHS



Top end of DUT



Bottom end of DUT



Left Side of DUT



Right Side of DUT

Applicant:	UTStarcom Inc.	Model:	UT611	FCC ID:	O6Y-UT611	
DUT Type:	Portable Single-Mode PAS PHS TDMA Handset	Freq. Range:	1880.15 - 1909.85 MHz			
2005 Celltech Labs Inc.		This document is not to be reproduced in whole or in part without the written permission of Celltech Labs Inc.				44 of 49

DUT PHOTOGRAPHS



DUT Battery Compartment



Lithium-Polymer Battery Pack

DUT PHOTOGRAPHS



DUT with Ear-Microphone (P/N: EE-610-41) audio accessory

Test Report Serial No.:	050905O6Y-T637-S24T
Test Date(s):	May 11, 2005
Test Type:	FCC SAR Evaluation

APPENDIX E - SYSTEM VALIDATION

Applicant:	UTStarcom Inc.	Model:	UT611	FCC ID:	O6Y-UT611	
DUT Type:	Portable Single-Mode PAS PHS TDMA Handset	Freq. Range:	1880.15 - 1909.85 MHz			
2005 Celltech Labs Inc.		This document is not to be reproduced in whole or in part without the written permission of Celltech Labs Inc.				47 of 49

1900 MHz SYSTEM VALIDATION DIPOLE

Type:

1900 MHz Validation Dipole

Serial Number:

151

Place of Calibration:

Celltech Labs Inc.

Date of Calibration:

June 18, 2004

Celltech Labs Inc. hereby certifies that this device has been calibrated on the date indicated above.

Calibrated by:

Spencer Watson

Approved by:

Russell W. Pipe

1. Dipole Construction & Electrical Characteristics

The validation dipole was constructed in accordance with the IEEE Standard “Annex G (informative) Reference dipoles for use in system validation”. The electrical properties were measured using an HP 8753E Network Analyzer. The network analyzer was calibrated to the validation dipole N-type connector feed point using an HP85032E Type N calibration kit. The dipole was placed parallel to a planar phantom at a separation distance of 10.0mm from the simulating fluid using a loss-less dielectric spacer. The measured input impedance is:

Feed point impedance at 1900MHz $\text{Re}\{Z\} = 50.115\Omega$

$\text{Im}\{Z\} = 6.2070\Omega$

Return Loss at 1900MHz

-24.205dB

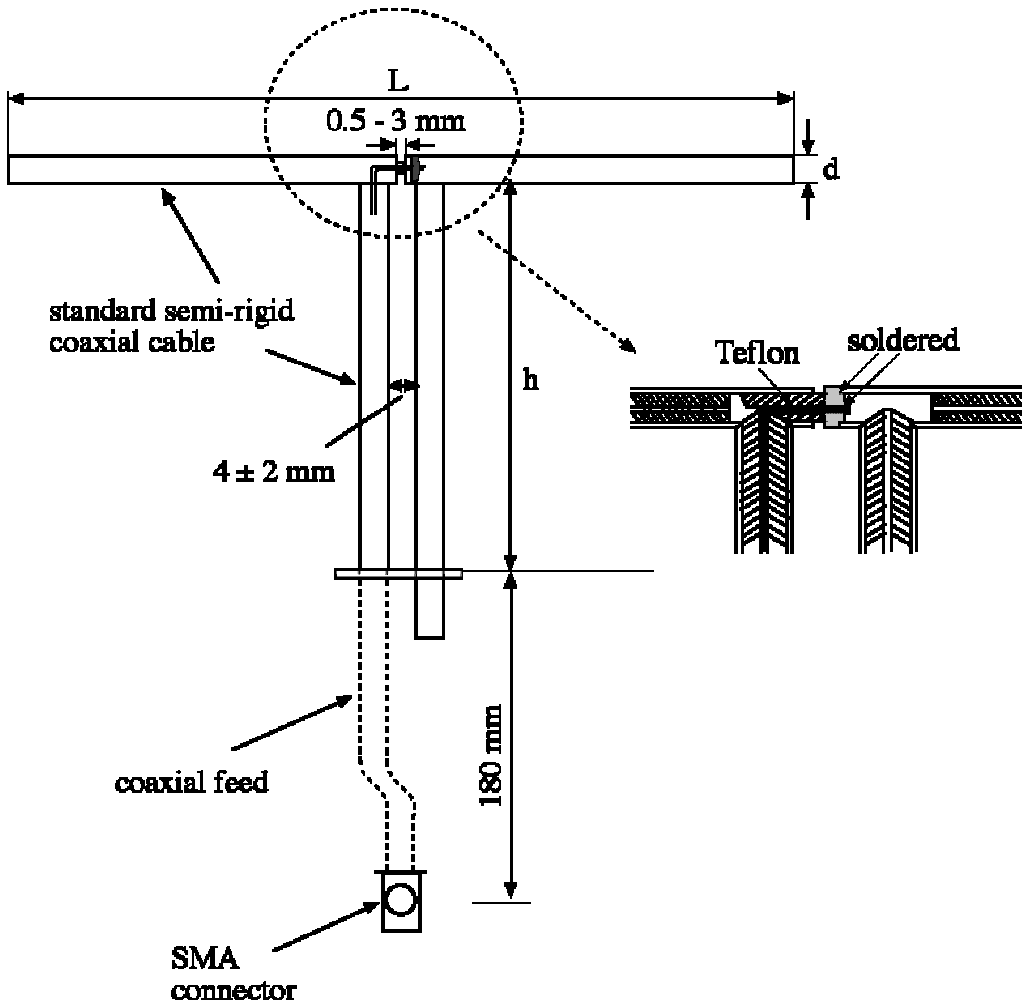

18 Jun 2004 09:26:48

CH1 S11 1 U FS 1: 50.115 Ω 6.2070 Ω 519.94 pH 1 900.000 000 MHz

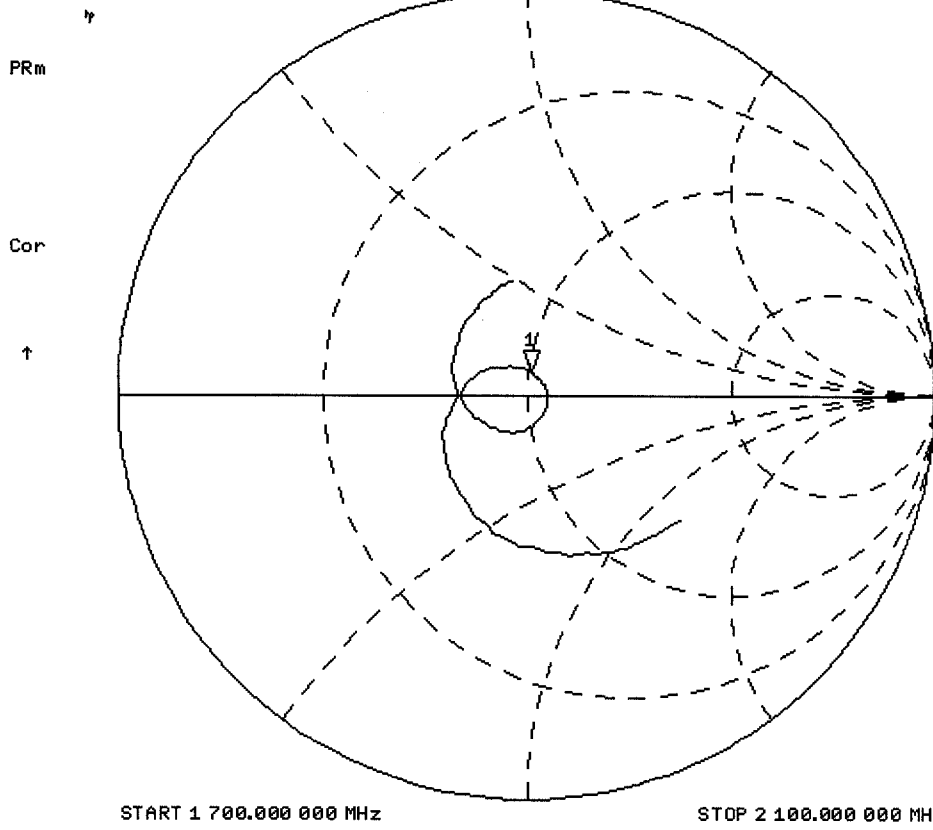

18 Jun 2004 09:25:56

CH1 S11 LOG 10 dB/REF 0 dB 13-24.205 dB 1 900.000 000 MHz

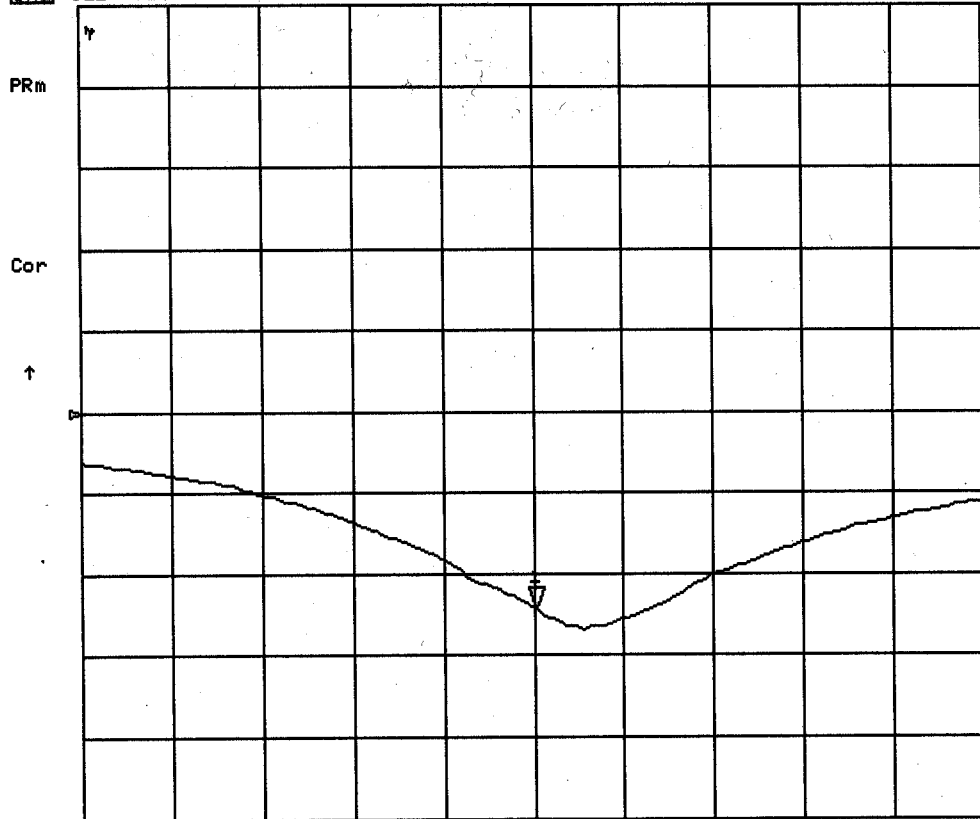

START 1 700.000 000 MHz

STOP 2 100.000 000 MHz

Validation Dipole Dimensions

Frequency (MHz)	L (mm)	h (mm)	d (mm)
300	420.0	250.0	6.2
450	288.0	167.0	6.2
835	161.0	89.8	3.6
900	149.0	83.3	3.6
1450	89.1	51.7	3.6
1800	72.0	41.7	3.6
1900	68.0	39.5	3.6
2000	64.5	37.5	3.6
2450	51.8	30.6	3.6
3000	41.5	25.0	3.6

2. Validation Phantom

The validation phantom is the SAM (Specific Anthropomorphic Mannequin) phantom manufactured by Schmid & Partner Engineering AG. The SAM phantom is a Fiberglass shell integrated in a wooden table. The shape of the shell corresponds to the phantom defined by SCC34-SC2. It enables the dosimetric evaluation of left and right hand phone usage as well as body mounted usage at the flat phantom region. A cover prevents evaporation of the liquid. Reference markings on the phantom allow the complete setup of all predefined phantom positions and measurement grids by manually teaching three points in the robot.

Shell Thickness: 2.0 ± 0.1 mm
Filling Volume: Approx. 20 liters
Dimensions: 50 cm (W) x 100 cm (L)

1900 MHz System Validation Setup



1900 MHz System Validation Setup



3. Measurement Conditions

The SAM phantom was filled with 1900 MHz brain simulating tissue.

Relative Permittivity: 38.3
Conductivity: 1.43 mho/m
Ambient Temperature: 24.0 °C
Fluid Temperature: 22.6 °C
Fluid Depth: ≥ 15.0 cm
Barometric Pressure: 103.0 kPa
Humidity: 37%

The 1900 MHz tissue simulant consists of the following ingredients:

Ingredient	Percentage by weight
Water	55.85%
Glycol	44.00%
Salt	0.15%
Target Dielectric Parameters at 22 °C	$\epsilon_r = 40.0$ $\sigma = 1.40$ S/m

4. SAR Measurement

The SAR measurement was performed with the E-field probe in mechanical detection mode only. The setup and determination of the forward power into the dipole was performed using the following procedures.

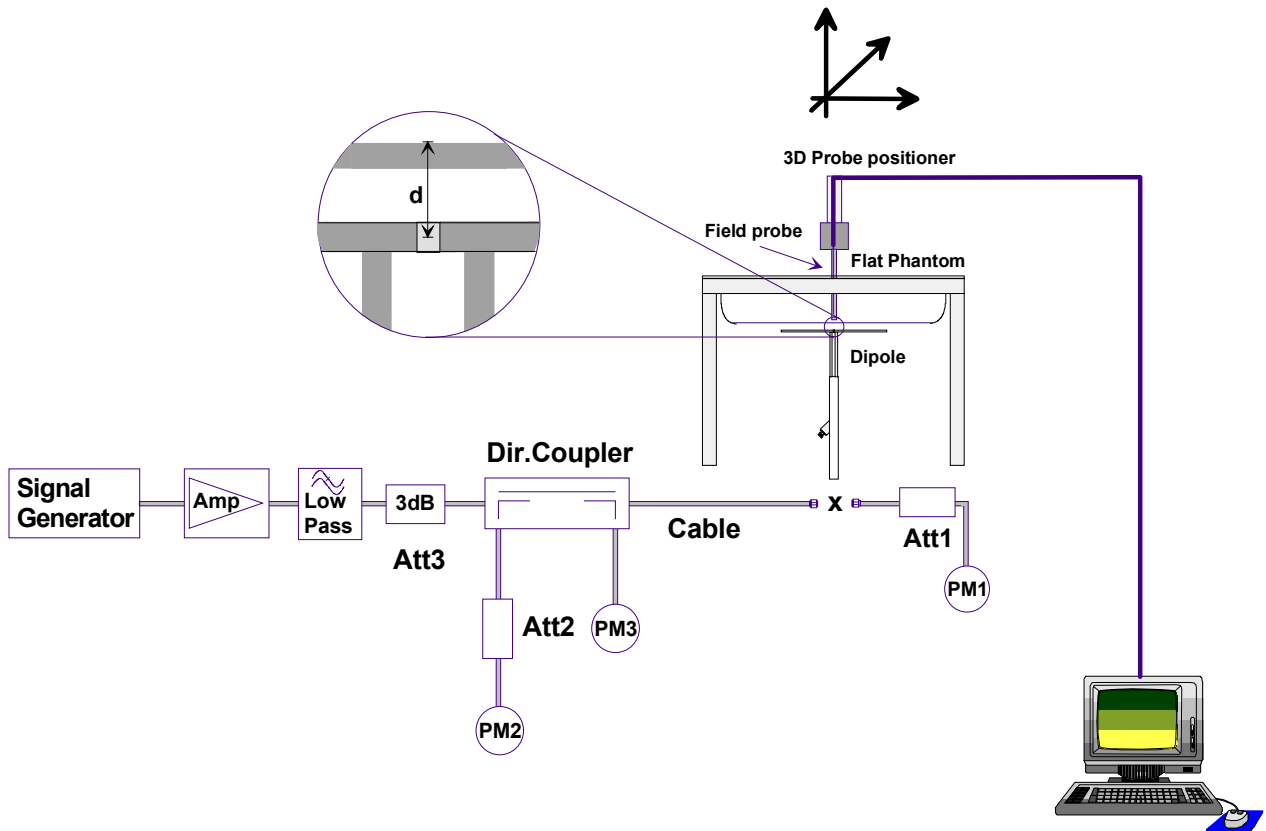

First the power meter PM1 (including attenuator Att1) is connected to the cable to measure the forward power at the location of the dipole connector (X). The signal generator is adjusted for the desired forward power at the dipole connector (taking into account the attenuation of Att1) as read by power meter PM2. After connecting the cable to the dipole, the signal generator is readjusted for the same reading at power meter PM2. If the signal generator does not allow adjustment in 0.01dB steps, the remaining difference at PM2 must be taken into consideration. PM3 records the reflected power from the dipole to ensure that the value is not changed from the previous value. The reflected power should be 50dB below the forward power.

Ten SAR measurements were performed in order to achieve repeatability and to establish an average target value.

Validation Dipole SAR Test Results

Validation Measurement	SAR @ 0.25W Input averaged over 1g	SAR @ 1W Input averaged over 1g	SAR @ 0.25W Input averaged over 10g	SAR @ 1W Input averaged over 10g	Peak SAR @ 0.25W Input
Test 1	10.1	40.40	5.30	21.20	17.4
Test 2	9.93	39.72	5.21	20.84	17.2
Test 3	9.98	39.92	5.23	20.92	17.3
Test 4	9.99	39.96	5.21	20.84	17.4
Test 5	9.97	39.88	5.22	20.88	17.4
Test 6	9.90	39.60	5.20	20.80	17.1
Test 7	9.93	39.72	5.21	20.84	17.2
Test 8	9.96	39.84	5.20	20.80	17.3
Test 9	9.94	39.76	5.20	20.80	17.2
Test 10	9.96	39.84	5.21	20.84	17.2
Average	9.966	39.864	5.219	20.876	17.27

The results have been normalized to 1W (forward power) into the dipole.

1g/10g Averaged	Average Measured SAR @ 1W Input	IEEE Target SAR @ 1W Input	Deviation (%)
1 gram	39.864	39.7	+ 0.413
10 gram	20.876	20.5	+ 1.835

1900 MHz System Validation - June 18, 2004

DUT: Dipole 1900 MHz; Type: D1900V2; Serial: 151

Ambient Temp: 24.0°C; Fluid Temp: 22.6°C; Barometric Pressure: 103.0 kPa; Humidity: 37%

Communication System: CW

Frequency: 1900 MHz; Duty Cycle: 1:1

Medium: HSL1900 ($\sigma = 1.43$ mho/m; $\epsilon_r = 38.3$; $\rho = 1000$ kg/m³)

- Probe: ET3DV6 - SN1387; ConvF(5.25, 5.25, 5.25); Calibrated: 18/03/2004

- Sensor-Surface: 4mm (Mechanical And Optical Surface Detection)

- Electronics: DAE3 Sn370; Calibrated: 14/05/2004

- Phantom: SAM 4.0; Type: Fiberglass; Serial: 1033

- Measurement SW: DASY4, V4.2 Build 44; Postprocessing SW: SEMCAD, V1.8 Build 112

1900 MHz System Validation/Area Scan (5x8x1): Measurement grid: dx=15mm, dy=15mm

Reference Value = 96.9 V/m; Power Drift = 0.1 dB

1900 MHz System Validation/Zoom Scan (7x7x7)/Cube 0: Measurement grid: dx=5mm, dy=5mm, dz=5mm

Reference Value = 96.9 V/m; Power Drift = 0.1 dB

Peak SAR (extrapolated) = 17.4 W/kg

SAR(1 g) = 10.1 mW/g; SAR(10 g) = 5.3 mW/g

1900 MHz System Validation/Zoom Scan 2 (7x7x7)/Cube 0:

Measurement grid: dx=5mm, dy=5mm, dz=5mm

Reference Value = 94.8 V/m; Power Drift = 0.0 dB

Peak SAR (extrapolated) = 17.2 W/kg

SAR(1 g) = 9.93 mW/g; SAR(10 g) = 5.21 mW/g

1900 MHz System Validation/Zoom Scan 3 (7x7x7)/Cube 0:

Measurement grid: dx=5mm, dy=5mm, dz=5mm

Reference Value = 94.2 V/m; Power Drift = 0.009 dB

Peak SAR (extrapolated) = 17.3 W/kg

SAR(1 g) = 9.98 mW/g; SAR(10 g) = 5.23 mW/g

1900 MHz System Validation/Zoom Scan 4 (7x7x7)/Cube 0:

Measurement grid: dx=5mm, dy=5mm, dz=5mm

Reference Value = 94.9 V/m; Power Drift = 0.001 dB

Peak SAR (extrapolated) = 17.4 W/kg

SAR(1 g) = 9.99 mW/g; SAR(10 g) = 5.21 mW/g

1900 MHz System Validation/Zoom Scan 5 (7x7x7)/Cube 0:

Measurement grid: dx=5mm, dy=5mm, dz=5mm

Reference Value = 95.2 V/m; Power Drift = -0.003 dB

Peak SAR (extrapolated) = 17.4 W/kg

SAR(1 g) = 9.97 mW/g; SAR(10 g) = 5.22 mW/g

1900 MHz System Validation/Zoom Scan 6 (7x7x7)/Cube 0:

Measurement grid: dx=5mm, dy=5mm, dz=5mm

Reference Value = 94.8 V/m; Power Drift = -0.0 dB

Peak SAR (extrapolated) = 17.1 W/kg

SAR(1 g) = 9.9 mW/g; SAR(10 g) = 5.2 mW/g

1900 MHz System Validation/Zoom Scan 7 (7x7x7)/Cube 0:

Measurement grid: dx=5mm, dy=5mm, dz=5mm

Reference Value = 94.8 V/m; Power Drift = -0.01 dB

Peak SAR (extrapolated) = 17.2 W/kg

SAR(1 g) = 9.93 mW/g; SAR(10 g) = 5.21 mW/g

1900 MHz System Validation/Zoom Scan 8 (7x7x7)/Cube 0:

Measurement grid: dx=5mm, dy=5mm, dz=5mm

Reference Value = 95.1 V/m; Power Drift = -0.007 dB

Peak SAR (extrapolated) = 17.3 W/kg

SAR(1 g) = 9.96 mW/g; SAR(10 g) = 5.2 mW/g

1900 MHz System Validation/Zoom Scan 9 (7x7x7)/Cube 0:

Measurement grid: dx=5mm, dy=5mm, dz=5mm

Reference Value = 94.7 V/m; Power Drift = -0.0 dB

Peak SAR (extrapolated) = 17.2 W/kg

SAR(1 g) = 9.94 mW/g; SAR(10 g) = 5.2 mW/g

1900 MHz System Validation/Zoom Scan 10 (7x7x7)/Cube 0:

Measurement grid: dx=5mm, dy=5mm, dz=5mm

Reference Value = 95.1 V/m; Power Drift = -0.0 dB

Peak SAR (extrapolated) = 17.2 W/kg

SAR(1 g) = 9.96 mW/g; SAR(10 g) = 5.21 mW/g

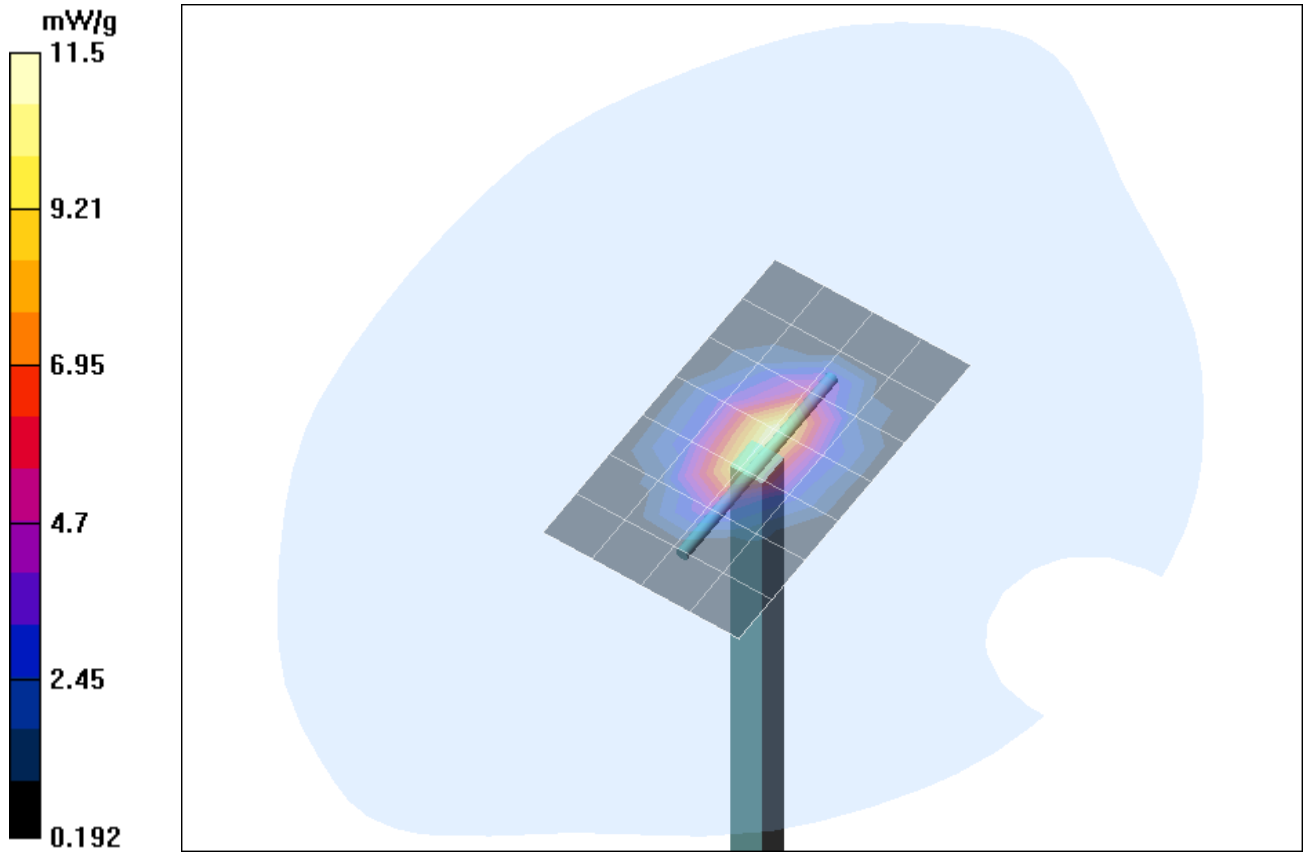

1 g average of 10 measurements: 9.966 mW/g
 10 g average of 10 measurements: 5.219 mW/g

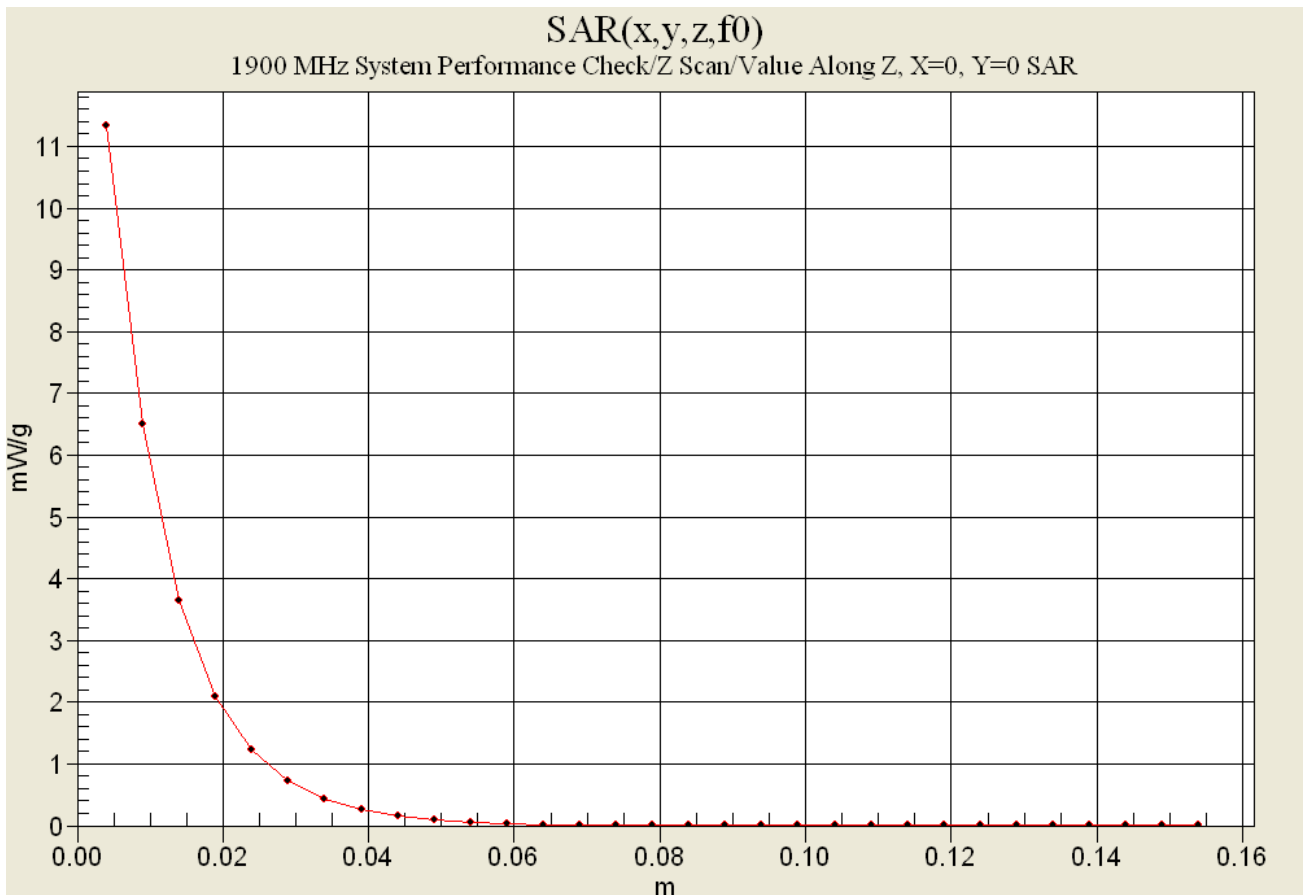

1900 MHz System Validation

Measured Fluid Dielectric Parameters (Brain)

June 18, 2004

Frequency	ϵ'	ϵ''
1.800000000 GHz	38.7685	13.2945
1.810000000 GHz	38.7232	13.3253
1.820000000 GHz	38.6647	13.3519
1.830000000 GHz	38.6047	13.3737
1.840000000 GHz	38.5593	13.4078
1.850000000 GHz	38.5136	13.4244
1.860000000 GHz	38.4736	13.4289
1.870000000 GHz	38.4328	13.4399
1.880000000 GHz	38.3934	13.4856
1.890000000 GHz	38.3637	13.4872
1.900000000 GHz	38.3205	13.5178
1.910000000 GHz	38.2981	13.5327
1.920000000 GHz	38.2590	13.5755
1.930000000 GHz	38.2344	13.5976
1.940000000 GHz	38.2172	13.6297
1.950000000 GHz	38.1838	13.6574
1.960000000 GHz	38.1575	13.6807
1.970000000 GHz	38.1070	13.6962
1.980000000 GHz	38.0516	13.7296
1.990000000 GHz	38.0093	13.7634
2.000000000 GHz	37.9485	13.7978

Test Report Serial No.:	05090506Y-T637-S24T
Test Date(s):	May 11, 2005
Test Type:	FCC SAR Evaluation

APPENDIX F - PROBE CALIBRATION

Applicant:	UTStarcom Inc.	Model:	UT611	FCC ID:	O6Y-UT611	
DUT Type:	Portable Single-Mode PAS PHS TDMA Handset	Freq. Range:	1880.15 - 1909.85 MHz			
2005 Celltech Labs Inc.		This document is not to be reproduced in whole or in part without the written permission of Celltech Labs Inc.				48 of 49



Accredited by the Swiss Federal Office of Metrology and Accreditation
The Swiss Accreditation Service is one of the signatories to the EA
Multilateral Agreement for the recognition of calibration certificates

Accreditation No.: **SCS 108**

Client **Celltech Labs**

Certificate No: **ET3-1387_Mar05**

CALIBRATION CERTIFICATE

Object **ET3DV6 - SN:1387**

Calibration procedure(s) **QA CAL-01.v5
Calibration procedure for dosimetric E-field probes**

Calibration date: **March 18, 2005**

Condition of the calibrated item **In Tolerance**

This calibration certificate documents the traceability to national standards, which realize the physical units of measurements (SI).
The measurements and the uncertainties with confidence probability are given on the following pages and are part of the certificate.

All calibrations have been conducted in the closed laboratory facility: environment temperature (22 ± 3)°C and humidity < 70%.

Calibration Equipment used (M&TE critical for calibration)

Primary Standards	ID #	Cal Date (Calibrated by, Certificate No.)	Scheduled Calibration
Power meter E4419B	GB41293874	5-May-04 (METAS, No. 251-00388)	May-05
Power sensor E4412A	MY41495277	5-May-04 (METAS, No. 251-00388)	May-05
Reference 3 dB Attenuator	SN: S5054 (3c)	10-Aug-04 (METAS, No. 251-00403)	Aug-05
Reference 20 dB Attenuator	SN: S5086 (20b)	3-May-04 (METAS, No. 251-00389)	May-05
Reference 30 dB Attenuator	SN: S5129 (30b)	10-Aug-04 (METAS, No. 251-00404)	Aug-05
Reference Probe ES3DV2	SN: 3013	7-Jan-05 (SPEAG, No. ES3-3013_Jan05)	Jan-06
DAE4	SN: 617	19-Jan-05 (SPEAG, No. DAE4-617_Jan05)	Jan-06
Secondary Standards	ID #	Check Date (in house)	Scheduled Check
Power sensor HP 8481A	MY41092180	18-Sep-02 (SPEAG, in house check Oct-03)	In house check: Oct 05
RF generator HP 8648C	US3642U01700	4-Aug-99 (SPEAG, in house check Dec-03)	In house check: Dec-05
Network Analyzer HP 8753E	US37390585	18-Oct-01 (SPEAG, in house check Nov-04)	In house check: Nov 05

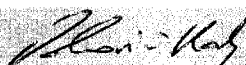
Calibrated by:	Name Nico Vetterli	Function Laboratory Technician	Signature 
Approved by:	Name Katja Pokovic	Function Technical Manager	Signature 

Issued: March 18, 2005

This calibration certificate shall not be reproduced except in full without written approval of the laboratory.



Accredited by the Swiss Federal Office of Metrology and Accreditation
The Swiss Accreditation Service is one of the signatories to the EA
Multilateral Agreement for the recognition of calibration certificates

Accreditation No.: **SCS 108**

Glossary:

TSL	tissue simulating liquid
NORM _{x,y,z}	sensitivity in free space
ConF	sensitivity in TSL / NORM _{x,y,z}
DCP	diode compression point
Polarization φ	φ rotation around probe axis
Polarization ϑ	ϑ rotation around an axis that is in the plane normal to probe axis (at measurement center), i.e., $\vartheta = 0$ is normal to probe axis

Calibration is Performed According to the Following Standards:

- IEEE Std 1528-2003, "IEEE Recommended Practice for Determining the Peak Spatial-Averaged Specific Absorption Rate (SAR) in the Human Head from Wireless Communications Devices: Measurement Techniques", December 2003
- CENELEC EN 50361, "Basic standard for the measurement of Specific Absorption Rate related to human exposure to electromagnetic fields from mobile phones (300 MHz - 3 GHz), July 2001

Methods Applied and Interpretation of Parameters:

- NORM_{x,y,z}**: Assessed for E-field polarization $\vartheta = 0$ ($f \leq 900$ MHz in TEM-cell; $f > 1800$ MHz: R22 waveguide). NORM_{x,y,z} are only intermediate values, i.e., the uncertainties of NORM_{x,y,z} does not effect the E²-field uncertainty inside TSL (see below *ConvF*).
- NORM(f)_{x,y,z} = NORM_{x,y,z} * frequency_response** (see Frequency Response Chart). This linearization is implemented in DASY4 software versions later than 4.2. The uncertainty of the frequency response is included in the stated uncertainty of *ConvF*.
- DCP_{x,y,z}**: DCP are numerical linearization parameters assessed based on the data of power sweep (no uncertainty required). DCP does not depend on frequency nor media.
- ConvF and Boundary Effect Parameters**: Assessed in flat phantom using E-field (or Temperature Transfer Standard for $f \leq 800$ MHz) and inside waveguide using analytical field distributions based on power measurements for $f > 800$ MHz. The same setups are used for assessment of the parameters applied for boundary compensation (alpha, depth) of which typical uncertainty values are given. These parameters are used in DASY4 software to improve probe accuracy close to the boundary. The sensitivity in TSL corresponds to NORM_{x,y,z} * *ConvF* whereby the uncertainty corresponds to that given for *ConvF*. A frequency dependent *ConvF* is used in DASY version 4.4 and higher which allows extending the validity from ± 50 MHz to ± 100 MHz.
- Spherical isotropy (3D deviation from isotropy)**: in a field of low gradients realized using a flat phantom exposed by a patch antenna.
- Sensor Offset**: The sensor offset corresponds to the offset of virtual measurement center from the probe tip (on probe axis). No tolerance required.

Probe ET3DV6

SN:1387

Manufactured:	September 21, 1999
Last calibrated:	March 18, 2004
Recalibrated:	March 18, 2005

Calibrated for DASY Systems

(Note: non-compatible with DASY2 system!)

DASY - Parameters of Probe: ET3DV6 SN:1387**Sensitivity in Free Space^A****Diode Compression^B**

NormX	1.61 ± 10.1%	$\mu\text{V}/(\text{V}/\text{m})^2$	DCP X	92 mV
NormY	1.70 ± 10.1%	$\mu\text{V}/(\text{V}/\text{m})^2$	DCP Y	92 mV
NormZ	1.70 ± 10.1%	$\mu\text{V}/(\text{V}/\text{m})^2$	DCP Z	92 mV

Sensitivity in Tissue Simulating Liquid (Conversion Factors)

Please see Page 8.

Boundary Effect

TSL **900 MHz** **Typical SAR gradient: 5 % per mm**

Sensor Center to Phantom Surface Distance		3.7 mm	4.7 mm
SAR _{be} [%]	Without Correction Algorithm	9.4	4.9
SAR _{be} [%]	With Correction Algorithm	0.1	0.3

TSL **1810 MHz** **Typical SAR gradient: 10 % per mm**

Sensor Center to Phantom Surface Distance		3.7 mm	4.7 mm
SAR _{be} [%]	Without Correction Algorithm	14.3	9.6
SAR _{be} [%]	With Correction Algorithm	0.6	0.1

Sensor Offset

Probe Tip to Sensor Center **2.7 mm**

The reported uncertainty of measurement is stated as the standard uncertainty of measurement multiplied by the coverage factor k=2, which for a normal distribution corresponds to a coverage probability of approximately 95%.

^A The uncertainties of NormX,Y,Z do not affect the E²-field uncertainty inside TSL (see Page 8).

^B Numerical linearization parameter: uncertainty not required.

Frequency Response of E-Field

(TEM-Cell:ifi110 EXX, Waveguide: R22)

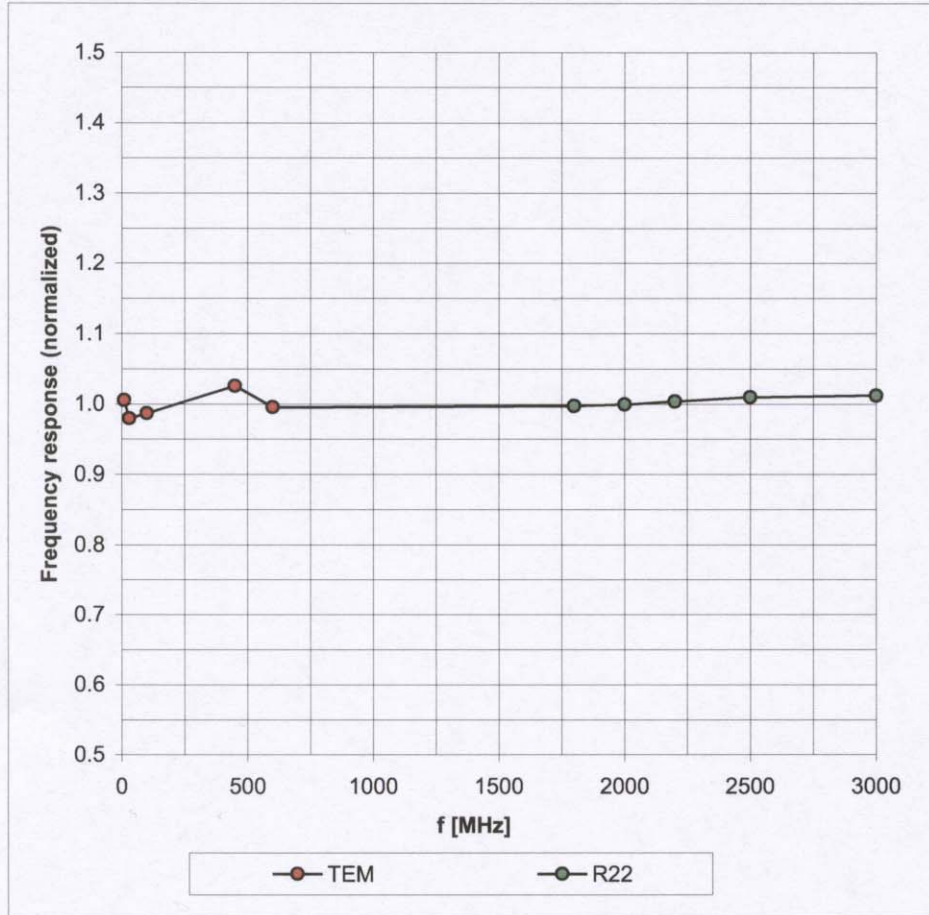

Uncertainty of Frequency Response of E-field: $\pm 6.3\%$ ($k=2$)

Receiving Pattern (ϕ), $\vartheta = 0^\circ$

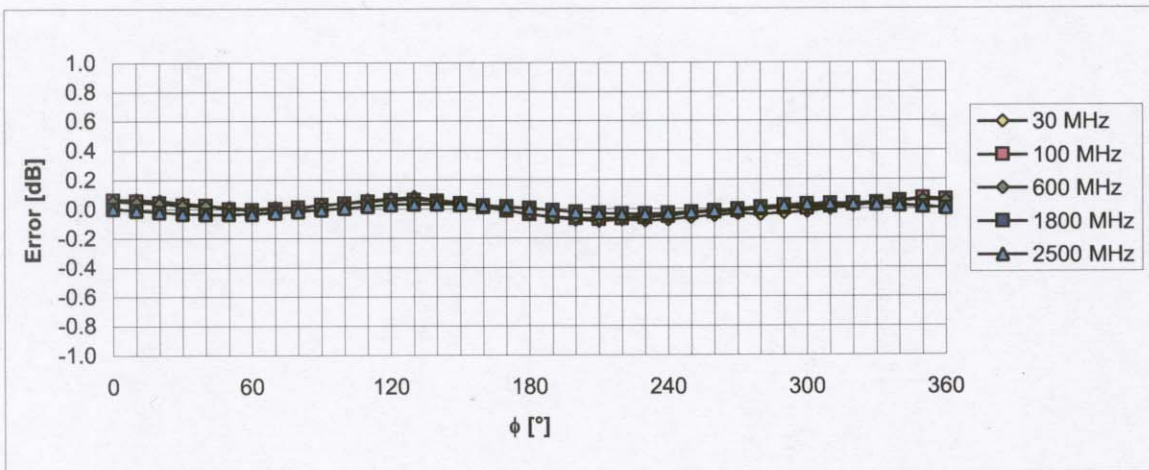
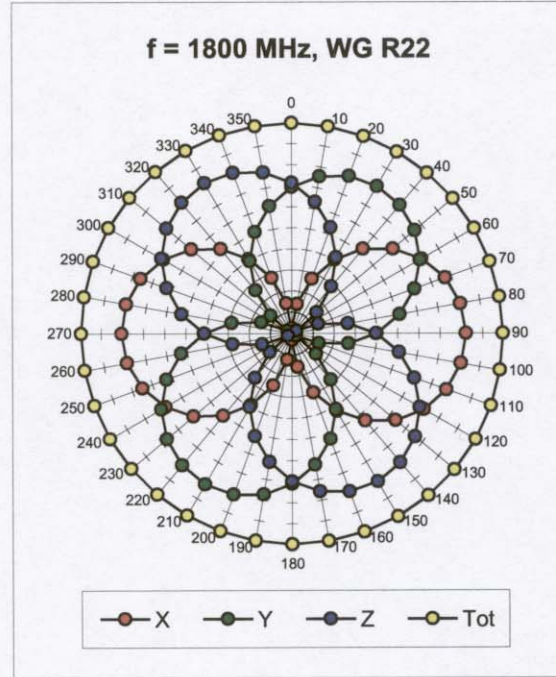
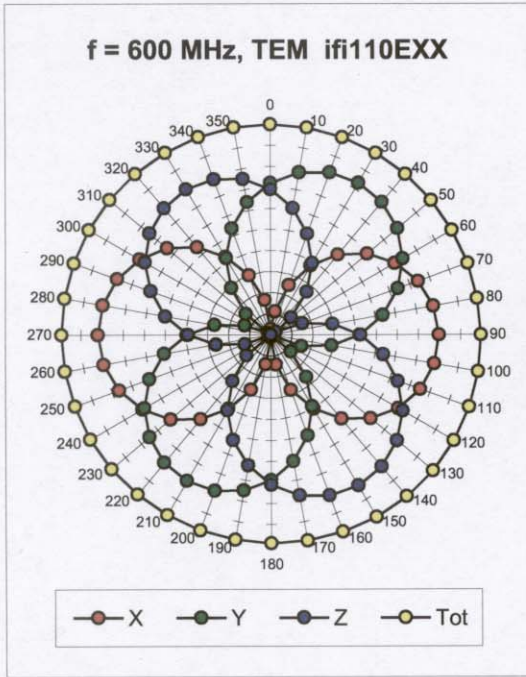

Uncertainty of Axial Isotropy Assessment: $\pm 0.5\%$ ($k=2$)

Dynamic Range $f(\text{SAR}_{\text{head}})$ (Waveguide R22, $f = 1800 \text{ MHz}$)

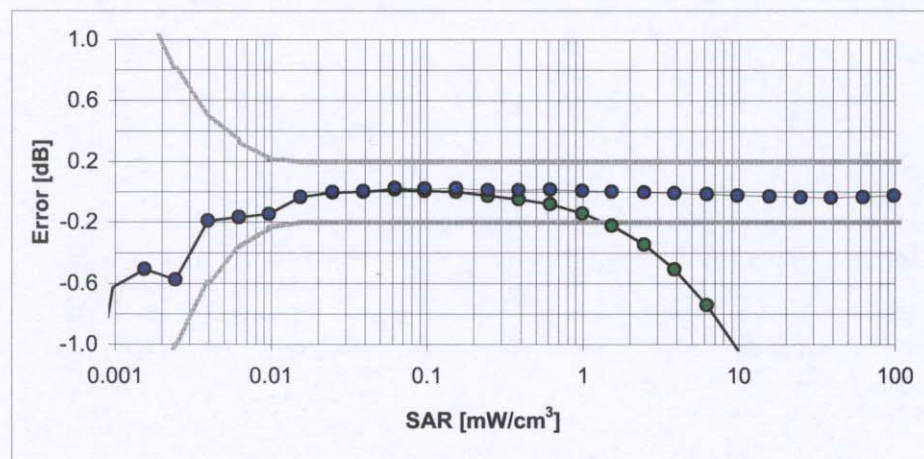
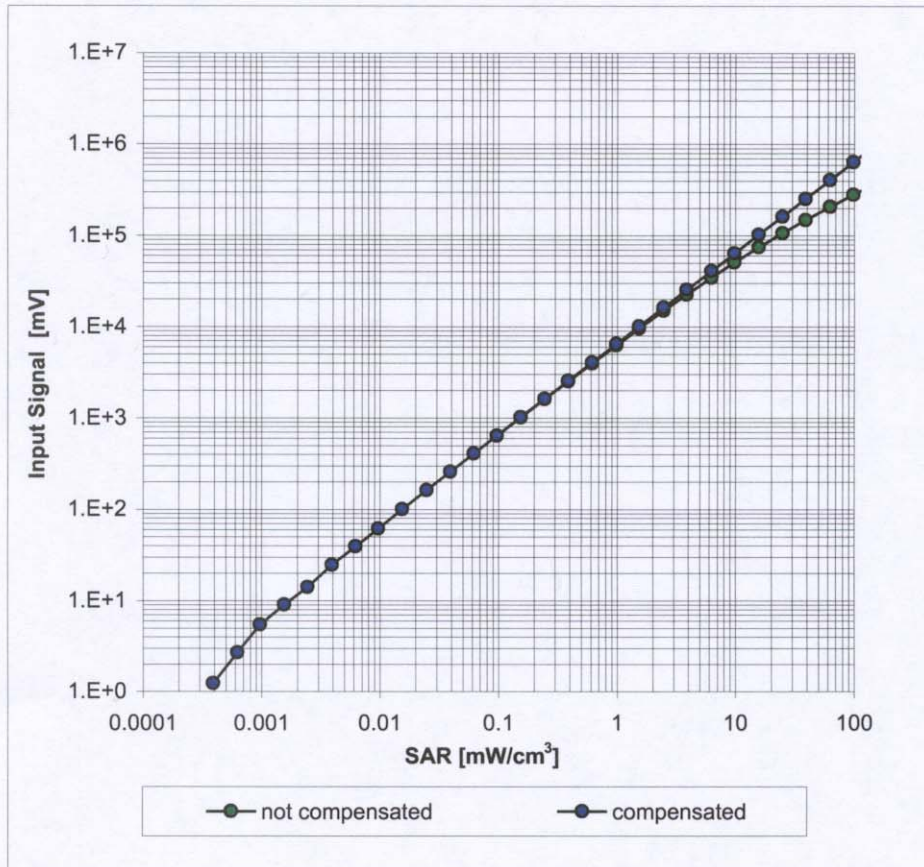

Uncertainty of Linearity Assessment: $\pm 0.6\%$ ($k=2$)

Conversion Factor Assessment

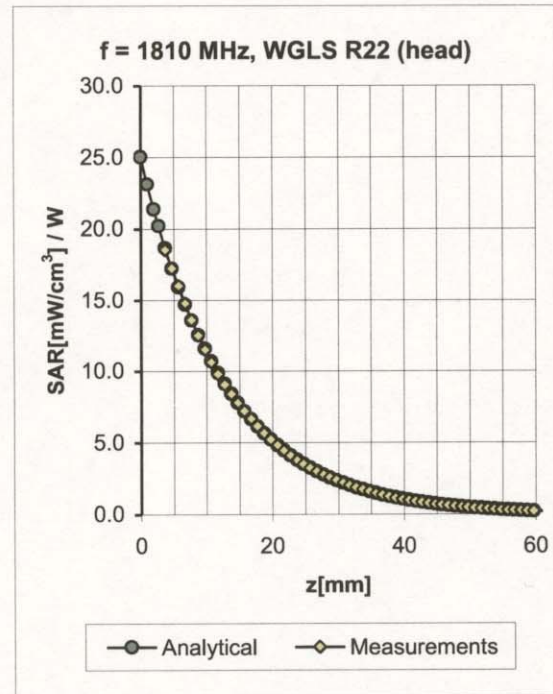
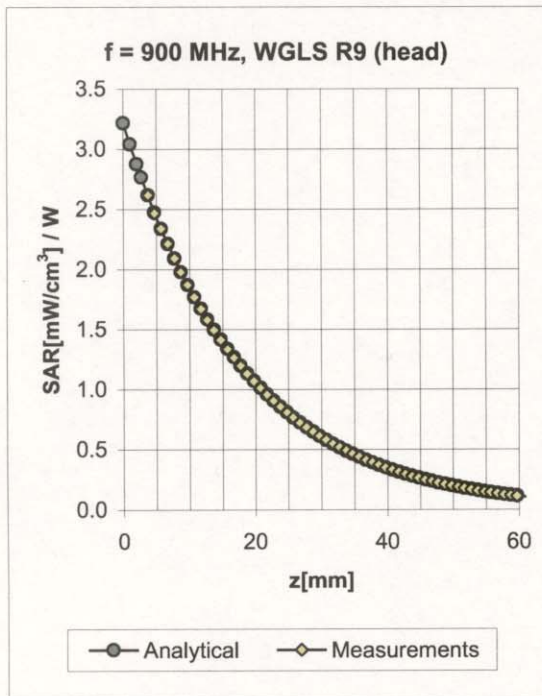

f [MHz]	Validity [MHz] ^c	TSL	Permittivity	Conductivity	Alpha	Depth	ConvF Uncertainty
900	± 50 / ± 100	Head	41.5 ± 5%	0.97 ± 5%	0.65	1.81	6.47 ± 11.0% (k=2)
1810	± 50 / ± 100	Head	40.0 ± 5%	1.40 ± 5%	0.62	2.39	5.18 ± 11.0% (k=2)
2450	± 50 / ± 100	Head	39.2 ± 5%	1.80 ± 5%	0.76	2.09	4.56 ± 11.8% (k=2)
900	± 50 / ± 100	Body	55.0 ± 5%	1.05 ± 5%	0.60	2.01	6.10 ± 11.0% (k=2)
1810	± 50 / ± 100	Body	53.3 ± 5%	1.52 ± 5%	0.60	2.67	4.75 ± 11.0% (k=2)
2450	± 50 / ± 100	Body	52.7 ± 5%	1.95 ± 5%	0.82	1.82	4.30 ± 11.8% (k=2)

^c The validity of ± 100 MHz only applies for DASY v4.4 and higher (see Page 2). The uncertainty is the RSS of the ConvF uncertainty at calibration frequency and the uncertainty for the indicated frequency band.

Deviation from Isotropy in HSL

Error (ϕ , ϑ), $f = 900$ MHz

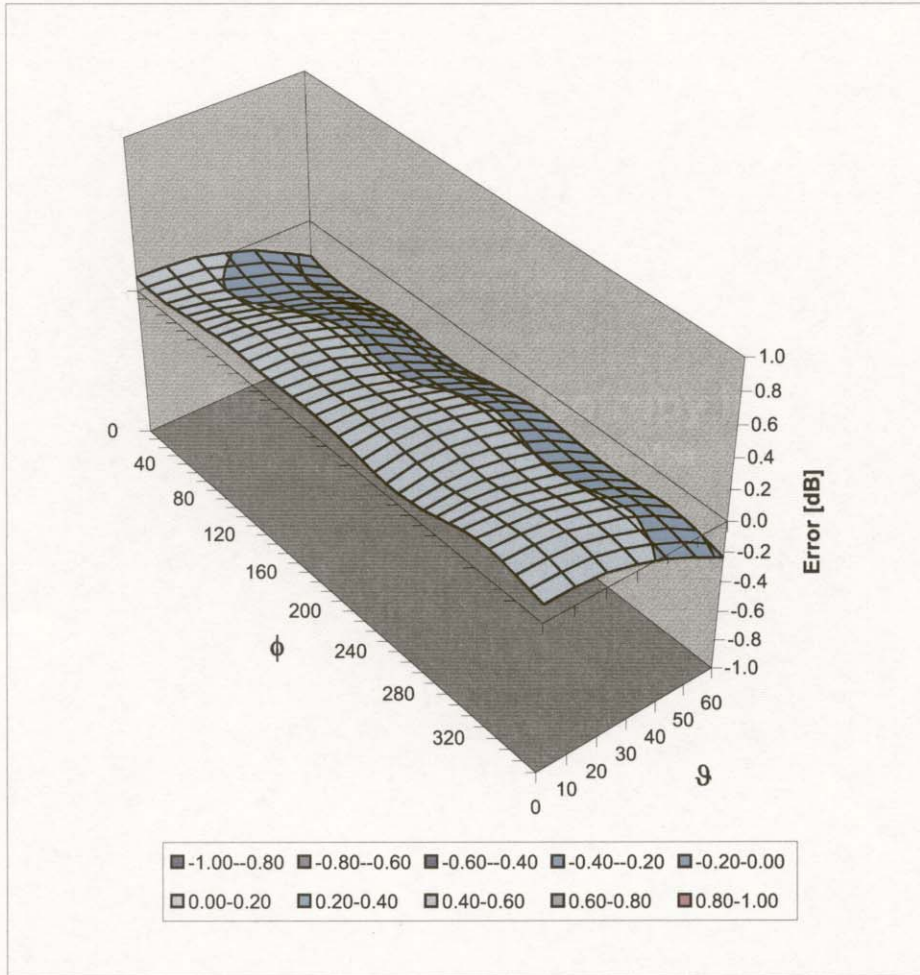

Uncertainty of Spherical Isotropy Assessment: $\pm 2.6\%$ ($k=2$)

Additional Conversion Factors

for Dosimetric E-Field Probe

Type:	ET3DV6
Serial Number:	1387
Place of Assessment:	Zurich
Date of Assessment:	March 21, 2005
Probe Calibration Date:	March 18, 2005

Schmid & Partner Engineering AG hereby certifies that conversion factor(s) of this probe have been evaluated on the date indicated above. The assessment was performed using the FDTD numerical code SEMCAD of Schmid & Partner Engineering AG. Since the evaluation is coupled with measured conversion factors, it has to be recalculated yearly, i.e., following the re-calibration schedule of the probe. The uncertainty of the numerical assessment is based on the extrapolation from measured value at 900 MHz or at 1800 MHz.

Assessed by:

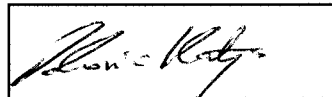

Dosimetric E-Field Probe ET3DV6 SN:1387Conversion factor (\pm standard deviation)

f = 150 MHz	ConvF	8.8 \pm 10%	$\epsilon_r = 52.3 \pm 5\%$ $\sigma = 0.76 \pm 5\%$ mho/m (head tissue)
f = 300 MHz	ConvF	7.9 \pm 9%	$\epsilon_r = 45.3 \pm 5\%$ $\sigma = 0.87 \pm 5\%$ mho/m (head tissue)
f = 450 MHz	ConvF	7.5 \pm 8%	$\epsilon_r = 43.5 \pm 5\%$ $\sigma = 0.87 \pm 5\%$ mho/m (head tissue)
f = 150 MHz	ConvF	8.4 \pm 10%	$\epsilon_r = 61.9 \pm 5\%$ $\sigma = 0.80 \pm 5\%$ mho/m (body tissue)
f = 450 MHz	ConvF	7.5 \pm 8%	$\epsilon_r = 56.7 \pm 5\%$ $\sigma = 0.94 \pm 5\%$ mho/m (body tissue)

Important Note:

For numerically assessed probe conversion factors, parameters Alpha and Delta in the DASY software must have the following entries: Alpha = 0 and Delta = 1.

Please see also Section 4.7 of the DASY4 Manual.

Test Report Serial No.:	050905O6Y-T637-S24T
Test Date(s):	May 11, 2005
Test Type:	FCC SAR Evaluation

APPENDIX G - SAM PHANTOM CERTIFICATE OF CONFORMITY

Applicant:	UTStarcom Inc.	Model:	UT611	FCC ID:	O6Y-UT611	
DUT Type:	Portable Single-Mode PAS PHS TDMA Handset	Freq. Range:	1880.15 - 1909.85 MHz			
2005 Celltech Labs Inc. This document is not to be reproduced in whole or in part without the written permission of Celltech Labs Inc. 49 of 49						

Schmid & Partner Engineering AG

Zeughausstrasse 43, 8004 Zurich, Switzerland, Phone +41 1 245 97 00, Fax +41 1 245 97 79

Certificate of conformity / First Article Inspection

Item	SAM Twin Phantom V4.0
Type No	QD 000 P40 BA
Series No	TP-1002 and higher
Manufacturer / Origin	Untersee Composites Hauptstr. 69 CH-8559 Fruthwilen Switzerland

Tests

The series production process used allows the limitation to test of first articles. Complete tests were made on the pre-series Type No. QD 000 P40 AA, Serial No. TP-1001 and on the series first article Type No. QD 000 P40 BA, Serial No. TP-1006. Certain parameters have been retested using further series units (called samples).

Test	Requirement	Details	Units tested
Shape	Compliance with the geometry according to the CAD model.	IT'IS CAD File (*)	First article, Samples
Material thickness	Compliant with the requirements according to the standards	2mm +/- 0.2mm in specific areas	First article, Samples
Material parameters	Dielectric parameters for required frequencies	200 MHz – 3 GHz Relative permittivity < 5 Loss tangent < 0.05.	Material sample TP 104-5
Material resistivity	The material has been tested to be compatible with the liquids defined in the standards	Liquid type HSL 1800 and others according to the standard.	Pre-series, First article

Standards

- [1] CENELEC EN 50361
- [2] IEEE P1528-200x draft 6.5
- [3] IEC PT 62209 draft 0.9

(*) The IT'IS CAD file is derived from [2] and is also within the tolerance requirements of the shapes of [1] and [3].

Conformity

Based on the sample tests above, we certify that this item is in compliance with the uncertainty requirements of SAR measurements specified in standard [1] and draft standards [2] and [3].

Date 18.11.2001

Signature / Stamp



**Schmid & Partner
Engineering AG**



Zeughausstrasse 43, CH-8004 Zurich
Tel. +41 1 245 97 00, Fax +41 1 245 97 79