

Lenovo Smart Tab M8 (3rd Gen) with Google Assistant

Safety, Warranty & Quick Start Guide

Lenovo TB-8506FS

Lenovo TB-8506XS

③ <https://support.lenovo.com>

④ <https://forums.lenovo.com>

- Read this guide carefully before using your device.
All information labeled with * in this guide only refers to the
WLAN + LTE model.

Lenovo

Reading before using your device

Reading first - regulatory information

Device models equipped with wireless communications comply with the radio frequency and safety standards of any country or region in which it has been approved for wireless use. In addition, if your product contains a telecom modem, it complies with the requirements for connection to the telephone network in your country.

Be sure to read the *Regulatory Notice* for your country or region before using the wireless devices contained in your device. To obtain a PDF version of the *Regulatory Notice*, go to <https://support.lenovo.com>.

Getting support

To get support on network services and billing, contact your wireless network operator. To learn how to use your device and view its technical specifications, go to <https://support.lenovo.com>.

Accessing your *User Guide*

Your *User Guide* contains detailed information about your device. To download the publications for your device, go to <https://support.lenovo.com> and follow the instructions on the screen.

Legal notices

Lenovo and the Lenovo logo are trademarks of Lenovo in the United States, other countries, or both.

Other company, product, or service names may be trademarks or service marks of others.

Manufactured under license from Dolby Laboratories. Dolby, Dolby Atmos, and the double-D symbol are registered trademarks of Dolby Laboratories Licensing Corporation.

LIMITED AND RESTRICTED RIGHTS NOTICE: If data or software is delivered pursuant a General Services Administration "GSA" contract, use, reproduction, or disclosure is subject to restrictions set forth in Contract No. GS-35F-05925.

Device overview

Model	Version
Lenovo TB-8506FS	WLAN
Lenovo TB-8506XS	WLAN + LTE

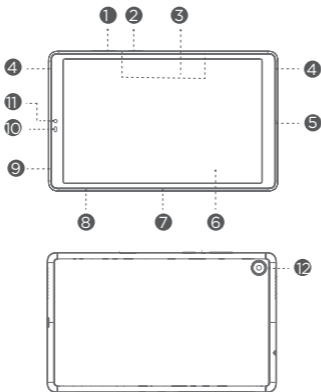

- | | | |
|---------------------------|-------------------|---------------------|
| 1 Volume buttons | 2 Power button | 3 Microphone |
| 4 Speakers | 5 USB-C connector | 6 Touch screen |
| 7 Smart connector | 8 Card tray | 9 Headset connector |
| 10 Light/Proximity sensor | 11 Front camera | 12 Rear camera |

- The WLAN version does not have a Nano-SIM card slot.
- All pictures and illustrations in this document are for your reference only and may differ from the final product.

Model	Version
Smart Charging Station	Lenovo CD-100



Smart connector

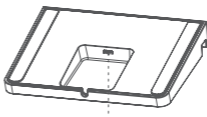

Micro USB connector

Preparing your device

Installing cards

Install the cards as shown in the figure.

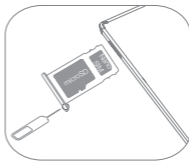
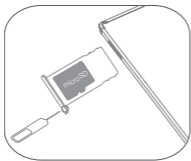

- Power off the device before inserting or removing a card.
- Note that the WLAN version does not have a Nano-SIM card slot.

Charging your device

Connect your device to a power outlet using the USB cable and power adapter provided.

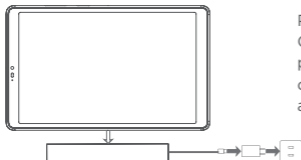
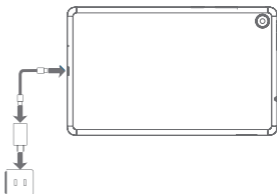

Place your tablet in the dock. Connect your smart dock to a power outlet using the charging only USB cable and power adapter provided.

Turning on

Press and hold the Power button until the Lenovo logo appears.

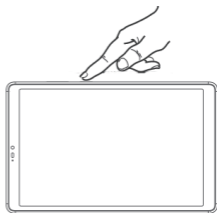

Google Assistant on Your Tablet

Lenovo Smart Tab M8 includes Google Assistant integration for supported languages.

Setting up Google Assistant

To open the Google Assistant, touch and hold the Home button, tap “GET STARTED”, and follow the on-screen prompts to set up the Google Assistant. Say “OK Google” and “Hey Google” when prompted to teach the Google Assistant to recognize your voice and complete the setup process.

Using Google Assistant

Lenovo Smart Tab M8 supports Google Voice Assistant recognition when the screen is on, allowing you access it from across the room. You can touch and hold the Home button or say “OK Google” or “Hey Google” to interact with the Google Assistant. Ask “What can you do?” to see what the Google Assistant can help you with.

Google Assistant's Ambient Mode

Google Assistant's Ambient Mode will turn your tablet into a digital photo frame. You can also easily control music and smart home devices by touch and voice command, and quickly access your most important updates while your tablet is charging via the charging cable or the smart charging station. Google will release more features for Ambient Mode in the future.

How to use Google Assistant's Ambient Mode

You can enable/turn off Google Assistant's Ambient Mode by going to Settings > Google > Search, Assistant & Voice > Google Assistant > Assistant > Assistant Devices (Tablet) > Personalization (Ambient Mode).

 The Google Assistant requires an internet connection and may not be available in all countries and languages.

- For more information about the Google Assistant including supported languages and changing or adding languages, go to <http://support.google.com/assistant/answer/7394513>
- You also can go to <https://support.lenovo.com> for the current list of languages that Ambient Mode supports.

Important safety and handling information

Plastic bag notice

Danger: Plastic bags can be dangerous. Keep plastic bags away from babies and children to avoid danger of suffocation.

Caution about high volume usage

Warning: Exposure to loud noise from any source for extended periods of time may affect your hearing. The louder the sound, the less time is required before your hearing could be affected. To protect your hearing:

- Limit the amount of time you use headsets or headphones at high volume.
- Avoid turning up the volume to block out noisy surroundings.
- Turn the volume down if you can't hear people speaking near you.

If you experience hearing discomfort, including the sensation of pressure or fullness in your ears, ringing in your ears or muffled speech, you should stop listening to the device through your headset or headphones and have your hearing checked.



To prevent possible hearing damage, do not listen at high volume levels for long periods.

Safety instructions for parents and adult supervisors

Your mobile device is not a toy. As with all electrical products, precautions should be observed during handling and using of electrical products to reduce the risk of electric shock. If parents choose to allow children to use the device, they should caution his or her child about the potential hazard while using and handling the mobile device.

Parents should inspect the mobile device (including the ac power adapter and the small part, as applicable) periodically for damage. Routinely check this mobile device to ensure that the device is working properly and is safe for children to use.

Internal rechargeable battery warning

Danger: Do not attempt to replace the internal rechargeable lithium ion battery. Replacing the original battery with an incompatible type may result in an increased risk of personal injury or property damage due to explosion, excessive heat, or other risks. Do not attempt to disassemble or modify the battery pack. Attempting to do so can cause a harmful explosion or battery fluid leakage.

When disposing of the battery, comply with all relevant local ordinances or regulations. Do not dispose the battery pack in municipal waste. Dispose used batteries according to the instructions.

The battery pack contains a small amount of harmful substances.

To avoid injury:

- Keep the battery pack away from open flames or other heat sources.
- Do not expose the battery pack to water, rain, or other corrosive liquids.
- Do not leave the battery in an environment with extremely high temperature.
- Avoid short-circuiting the battery pack.
- Keep the battery pack out of reach of small children and pets.
- Do not leave the battery in an environment with extremely low air pressure. It may result in an explosion or the leakage of flammable liquid or gas from the battery.

To extend battery life, we recommend charging the battery to at least 30% to 50% capacity each time, and recharging it every three months to prevent over discharge

Eye Protection and Safety Information

While concentrating on the performance capabilities of its screens, Lenovo also places importance on user's eye health. This product has received TÜV Rheinland's "Low Blue Light" certification and can be used with confidence.

For further information, please visit <https://support.lenovo.com>.

EurAsia compliance mark



Product Safety Information

Driving precautions. Responsible and safe driving is your primary responsibility when driving a vehicle. Always obey local laws and regulations.

Seizures, blackouts, eye strain and discomfort. This device may display flashing images or loud sounds.

Medical devices. This device may interfere with pacemakers and other medical devices. If you use an implantable pacemaker, defibrillator, or other medical device, please consult your healthcare provider and device manufacturer before using this mobile device. If you use a pacemaker or defibrillator, the FCC recommends that you pay attention to the following precautions:

Always keep this mobile device at least 20 cm (8 inches) away from the pacemaker or defibrillator. Please use the mobile device on the side away from the pacemaker or defibrillator to minimize the possibility of interference.

When you suspect that interference is being caused, the mobile device should be turned off immediately.

Extreme heat or cold. Don't use your device in temperatures below 0°C or above 40°C. Don't store/transport your device in temperatures below -20°C or above 60°C.

Operational warnings. Obey all posted signs when using devices in public areas.

- Potentially explosive areas: potentially explosive areas are often, but not always, posted and can include blasting areas, fueling stations, fueling areas (such as below decks on boats), fuel or chemical transfer or storage facilities or areas where the air contains chemicals or particles, such as grain dust or metal powders.

Turn off your device before entering such an area and do not charge batteries. In such areas, sparks can occur and cause an explosion or fire.

Hospitals. Switch off your wireless device when requested to do so in hospitals, clinics or health care facilities. These requests are designed to prevent possible interference with sensitive medical equipment.

Aircraft. Switch off your wireless device whenever you are instructed to do so by airport or airline staff.

Consult the airline staff about the use of wireless devices on board the aircraft, if your device offers a 'flight mode' this must be enabled prior to boarding an aircraft.

Service and support information

Lenovo Limited Warranty notice

This product is covered by the terms of the Lenovo Limited Warranty (LLW), version L5050010-02 08/2011. Read the LLW at https://www.lenovo.com/warranty/llw_02. You can view the LLW in a number of languages from this website.

Warranty information

Lenovo provides a warranty period for your device. To check the warranty status of your device purchase upgrades, go to <https://support.lenovo.com/warrantylookup>, and then select the product and follow the on-screen instructions.

Get support

To download Lenovo service tool - LMSA:

<https://support.lenovo.com/downloads/ds101291>

🔗 Visit the website above for information on devices compatible with LMSA.

Visit Lenovo's support website (<https://support.lenovo.com>) with the device serial number to get more Lenovo support options, or scan the QR code, and then follow the on-screen instructions.



Environmental, recycling, and disposal information

General recycling statement

Lenovo encourages owners of information technology (IT) equipment to responsibly recycle their equipment when it is no longer needed. Lenovo offers a variety of programs and services to assist equipment owners in recycling their IT products. For information on recycling Lenovo products, go to <http://www.lenovo.com/recycling>.

Important battery and WEEE information



Batteries and electrical and electronic equipment marked with the symbol of a crossed-out wheeled bin may not be disposed as unsorted municipal waste. Batteries and waste of electrical and electronic equipment (WEEE) shall be treated separately using the collection framework available to customers for the return, recycling, and treatment of batteries and WEEE. When possible, remove and isolate batteries from WEEE prior to placing WEEE in the waste collection stream. Batteries are to be collected separately using the framework available for the return, recycling, and treatment of batteries and accumulators.

Country-specific information is available at:
<http://www.lenovo.com/recycling>

Recycling information for Japan

Recycling and disposal information for Japan is available at:
<http://www.lenovo.com/recycling/japan>

Additional recycling statements

Additional information about recycling device components and batteries is in your *User Guide*. See “**Accessing your User Guide**” for details.

Battery recycling marks

Battery recycling information for Taiwan



Battery recycling information for the United States and Canada



Battery recycling information for the European Union



Restriction of Hazardous Substances Directive (RoHS)

Turkey

Lenovo products sold in Turkey, on or after June 1, 2009, meet the requirements of the former Republic of Turkey Restriction of Hazardous Substances legislation from 30th of May 2008 and the Control of Waste Electrical and Electronic Equipment Regulations from 22nd of May 2012 (“Turkey RoHS”).

Ukraine

Lenovo products sold in Ukraine, on or after January 1, 2011, meet the requirements of the Technical Directive on Restriction of Hazardous Substances in Electric and Electronic Equipment enforced by the Government, Decision No 1057 dated 2008/12/03 (“Ukraine TR on RoHS”).

India

Lenovo products sold in India, on or after May 1, 2012, meet the requirements of the India E-waste (Management) Rules (“India RoHS”).

Vietnam

Lenovo products sold in Vietnam, on or after September 23, 2011, meet the requirements of the Vietnam Circular 30/2011/TT-BCT (“Vietnam RoHS”).

Singapore

Lenovo products sold in Singapore, on or after June 1, 2017, meet the requirements of Government Gazette order No. S 263/2016 Restriction of Hazardous Substances in Electrical and Electronic Equipment in Singapore (“SG-RoHS”).

European Union

Lenovo Products meet the requirement of Directive 2011/65/EC on the restriction of the use of the certain hazardous substances in electrical and electronic equipment (“RoHS 2”). Lenovo products sold in the European Union, from the 21st July 2019, meet the requirement of Commission Delegated Directive (EU 2015/863) amending Directive 2011/65/EU.

For more information about Lenovo progress on RoHS, go to:

https://www.lenovo.com/us/en/social_responsibility/RoHS-Communication.pdf

European Union compliance statement

European Union conformity



Compliance with the RE Directive

Lenovo PC HK Limited declares that the radio equipment type Lenovo TB-8506FS, Lenovo TB-8506XS is in compliance with Directive 2014/53/EU.

The full text of the EU declaration of conformity is available at the following internet address:

<https://www.lenovo.com/us/en/compliance/eu-doc>

This radio equipment operates with the following frequency bands and maximum radio-frequency power:

Model Name	Frequency Bands	Maximum Power (dBm)
Lenovo TB-8506FS	WLAN2400-2483.5	<20
	WLAN5150-5250	<20
	WLAN5250-5350	<20
	WLAN5470-5725	<20
	WLAN 5725-5850	<14
	Bluetooth 2400-2483.5	<10
Lenovo TB-8506XS	GSM900	33
	DCS1800	31
	UMTS B1/B5/B8	24
	LTE B1/B3/B5/B7/B8/B20/ B28/B38/B40/B41	24
	WLAN2400-2483.5	<20
	WLAN5150-5250	<20
	WLAN5250-5350	<20
	WLAN5470-5725	<20
	WLAN 5725-5850	<14
	Bluetooth 2400-2483.5	< 10

	AT	BE	BG	CH	CY	CZ	DE	DK	EE	EL	ES	FI
	FR	HR	HU	IE	IS	IT	LI	LT	LU	LV	MT	NL
	NO	PL	PT	RO	SE	SI	SK	TR	UK (NI)			

Restrictions of use:

Usage of this device is limited to indoor in the band 5150 to 5350MHz.

- ⓘ The above information is for EU countries only. Please refer to the actual product for supported frequency bands in other countries.

Specific Absorption Rate information

YOUR MOBILE DEVICE MEETS INTERNATIONAL GUIDELINES FOR EXPOSURE TO RADIO WAVES.

Your mobile device is a radio transmitter and receiver. It is designed not to exceed the limits for exposure to radio waves (radio frequency electromagnetic fields) recommended by international guidelines. The guidelines were developed by an independent scientific organization (ICNIRP) and include a substantial safety margin designed to assure the safety of all persons, regardless of age and health. The radio wave exposure guidelines use a unit of measurement known as the Specific Absorption Rate, or SAR.

Tests for SAR are conducted using standard operating positions with the device transmitting at its highest certified power level in all tested frequency bands. The highest SAR values under the ICNIRP guidelines for your device model are listed below:

Maximum SAR for this model and conditions under which it was recorded.				
Europe 10g SAR Limit (2.0 W/kg)	Lenovo TB-8506FS	Body	WLAN, Bluetooth	0.923W/Kg
Europe 10g SAR Limit (4.0 W/kg)		Limb	WLAN, Bluetooth	0.923W/Kg
Europe 10g SAR Limit (2.0 W/kg)	Lenovo TB-8506XS	Body	LTE B40, WLAN, Bluetooth	1.477 W/kg
EuropeK 10g SAR Limit (4.0 W/kg)		Limb	WLAN, Bluetooth	1.477 W/kg

During use, the actual SAR values for your device are usually well below the values stated. This is because, for purposes of system efficiency and to minimize interference on the network, the operating power of your mobile device is automatically decreased when full power is not needed for the data connection. The lower the power output of the device, the lower its SAR value. If you are interested in further reducing your RF exposure then you can easily do so by limiting your usage or simply using a hands-free kit to keep the device away from the head and body.

© Copyright Lenovo 2021.

Reduce | Reuse | Recycle



V1.0_20210305



7011AA002035

MC

Printed in China