

DIGITAL STATIONARY TRANSMITTER

Model: DST-CON



Conferencing
Interpretation
Assistive Listening

[User Manual]

Manufacturer's Declaration

■ This product meets the following standards:

◆ Federal Communications Commission Interference Statement

Notice: The changes or modifications not expressly approved by the party responsible for compliance could void the user's authority to operate the equipment.

FCC INFORMATION

The Federal Communication Commission Radio Frequency Interference Statement includes the following paragraph: The equipment has been tested and found to comply with the limits for a Class B Digital Device, pursuant to part 15 of the FCC Rules. These limits are designed to provide reasonable protection against harmful interference in a residential installation.

This equipment generates, uses and can radiate radio frequency energy and, if not installed and used in accordance with the instruction, may cause harmful interference to radio communication.

However, there is no grantee that interference will not occur in a particular installation. If this equipment does cause harmful interference to radio or television reception, which can be determined by turning the equipment off and on, the user is encouraged to try to correct the interference by one or more of the following measures:

- Reorient or relocate the receiving antenna.
- Increase the separation between the equipment and receiver.
- Connect the equipment into an outlet on a circuit different from that to which the receiver is connected.
- Consult the dealer or an experienced radio/TV technician for help.

This device complies with part 15 of the FCC Rules.

Operation is subject to the following two conditions: (1) This device may not cause harmful interference, and (2) this device must accept any interference received, including interference that may cause undesired operation.

IMPORTANT NOTE: To comply with the FCC RF exposure compliance requirements, no change to the antenna or the device is permitted. Any change to the antenna or the device could result in the device exceeding the RF exposure requirements and void user's authority to operate the device.

◆ Europe – EU Declaration of Conformity

This device complies with Directive 2014/53/EU issued by the Commission of the European Community.

◆ WEEE Statement

Electrical and electronic equipment must be disposed of at the end of their lifespan separately from household waste.

Please dispose of this equipment at your local waste collection or recycling center. Please help to protect our environment.



◆ Safety and Electromagnetic Emissions Certificates

Standard Compliance

- RoHs compliant
- European Directive 2011/65/EU

Certificates

- CE
- FCC
- NCC

FCC Caution: To assure continued compliance, any changes or modifications not expressly approved by the party responsible for compliance could void the user's authority to operate this equipment. (Example - use only shielded interface cables when connecting to computer or peripheral devices).

FCC Radiation Exposure Statement

This equipment complies with FCC RF radiation exposure limits set forth for an uncontrolled environment. This equipment should be installed and operated with a minimum distance of 20 centimeters between the radiator and your body.

This transmitter must not be co-located or operating in conjunction with any other antenna or transmitter.

The antennas used for this transmitter must be installed to provide a separation distance of at least 20 cm from all persons and must not be co-located or operating in conjunction with any other antenna or transmitter.

Table of Contents

■ Product overview	1
◆ Front panel	
◆ Rear panel	
■ Display overview	2
◆ Standby screen	
◆ Setting screen	
■ Connecting instruction	3
■ Operating instruction	3
◆ Turn the transmitter on	
◆ Unlock the channel	
◆ Check channel frequency	
◆ Monitor audio via headphone	
◆ Activate mic / aux function	
◆ Turn the transmitter off	
■ Advanced operation	4
◆ Interpreter O (automatically)	
◆ Interpreter I (manually)	
■ Compatible receiver CON-9R	4
◆ Interface	
■ Application	5-6
◆ Conferencing / Assistive Listening (Mode: Transmitter)	
◆ Interpretation for multi-languages (Mode: Interpreter O)	
◆ Interpretation for 1~3 languages (Mode: Interpreter I)	
■ Troubleshooting	7
■ Specifications	7

■ Product overview

◆ Front panel

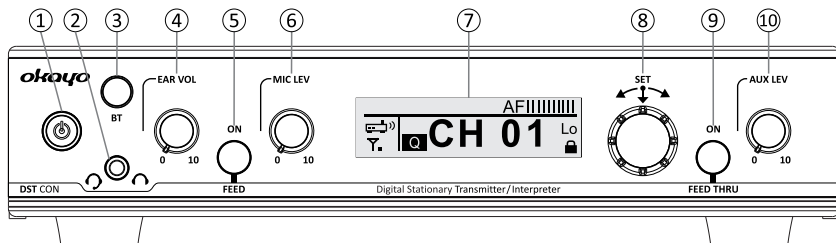

- ① Power button
- ② 3.5 mm headphone / headset-mic socket
- ③ Backlit Bluetooth button
- ④ Headphone volume control
- ⑤ Backlit Mic (Transmitter) / Feed (Interpreter O/I) button
- ⑥ Mic level control
- ⑦ OLED Display
- ⑧ Menu / Set jog dial
- ⑨ Backlit Aux (Transmitter) / Feed Thru (Interpreter O/I) button
- ⑩ Aux-in level (volume) control

◆ Rear panel

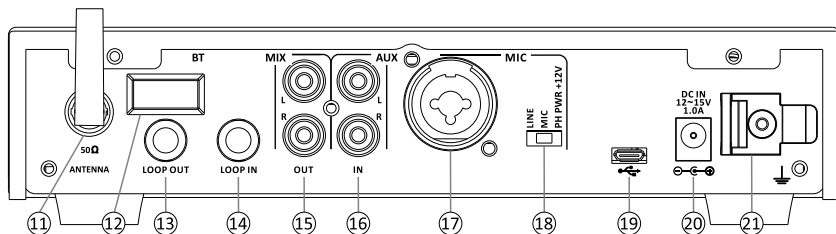

- ⑪ Rod antenna (TNC connector)
- ⑫ Bluetooth sensor
- ⑬ 6.3 mm loop output
- ⑭ 6.3 mm loop input
- ⑮ RCA mix output
- ⑯ RCA aux input
- ⑰ Combo input
- ⑱ Line / Mic / Phantom switch
- ⑲ Uploading port (*available for limited models*)
- ⑳ DC jack
- ㉑ Cable grip

■ Display overview

◆ Standby screen

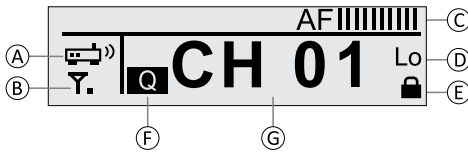

(A) Mode

- Transmitter (default)
- Interpreter O (to work with okayo's 10-way Language Router LR-10)
- Interpreter I

(B) RF power

- Hi
- Mid
- Low (default)

(C) Audio level

- This fluctuates upon audio signals.

(D) Aux-in level

- Lo (default): this setting is recommended if the transmitter will be connected with audio source, such as mp3, whose level is lower.
- Hi: this setting is recommended if the transmitter will be connected with professional mixer or other audio source whose level is higher.

(E) Channel lock

- Channel will be locked automatically when the transmitter is on.

(F) Sound quality

- HQ
- Q (default)

(G) Channel number

- Total channel quantity varies upon product and default channel number is 01.

◆ Setting screen

- To enter the setting menu, press and keep pressing the jog dial (8) when turning the transmitter on (1).
- Turn the jog dial (8) clockwise to select preferred setting and then press the jog dial (8) again to confirm new selection and return to setting menu.
- To exit the setting menu, select "Save and Exit" and press the jog dial (8) again.

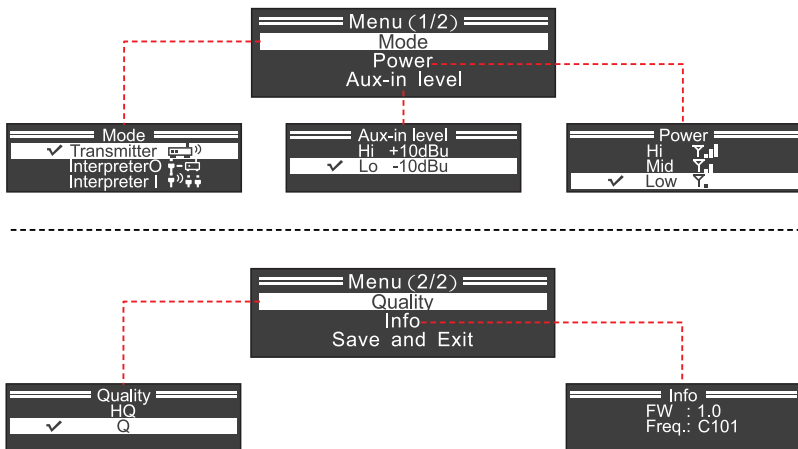

■ Connecting instruction

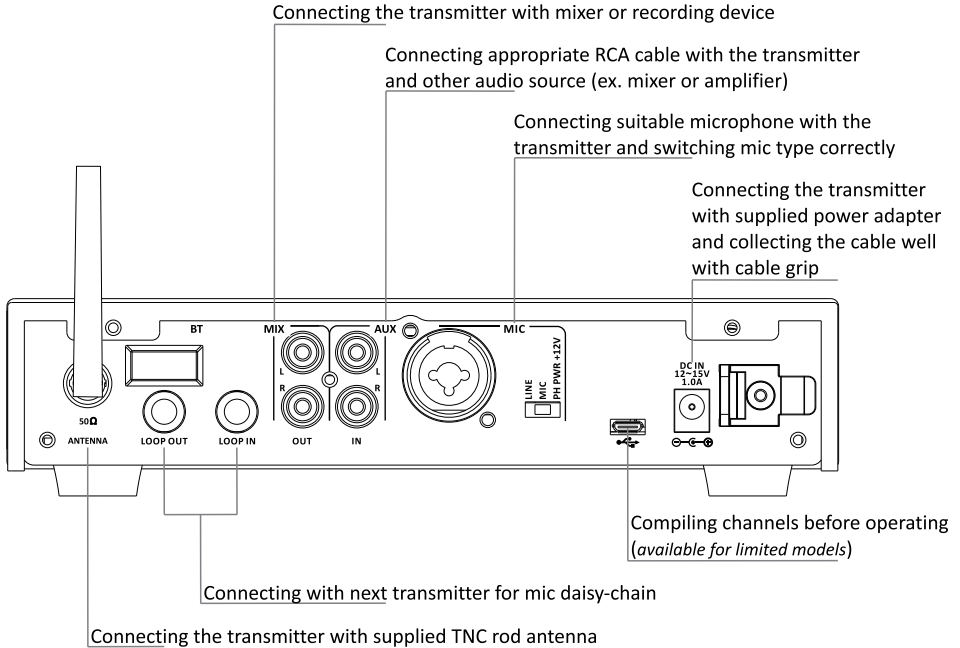

■ Operating instruction (Mode: Transmitter)

- ◆ Turn the transmitter on
Press the power button ① for 1 second to turn the transmitter on.
- ◆ Unlock the channel
Channel will automatically be locked when the transmitter is on. Press and keep pressing the jog dial ⑧ until symbol “” disappears. Then, turn the jog dial clockwise to select preferred channel number which will be locked when the jog dial is pressed again.
- ◆ Check channel frequency
Short press the jog dial ⑧ when the transmitter is at standby screen to check the frequency of selected channel.
- ◆ Monitor audio via headphone
Connect 3.5mm headphone or headset mic and tune the volume control ④ at appropriate position to monitor audio on the transmitter. *Note all audio signals except mic-in ②⑰ can be monitored.*

 Listening at high volume for long periods may damage your hearing.

- ◆ Activate mic / aux function
Press the mic / aux button ⑤⑨ to activate or deactivate the function. Tune the mic / aux level via the control ⑥⑩ at appropriate position. *Note when headset mic is in use, make sure mic volume ⑥ is appropriately adjusted in addition to aux volume ⑩.*
- ◆ Turn the transmitter off
Press the power button ① for 2 seconds to turn the transmitter off.

Digital Stationary Transmitter **DST-CON**

■ **Advanced operation** (Mode: Interpreter O/I)

In addition to standard mode (Transmitter), two additional modes (Interpreter O and Interpreter I) are also available for interpretation market.

◆ Interpreter O (automatically)

Connect it with okayo's 10-way language router LR-10 (see LR-10 manual separately) when this mode is selected. Both Feed and Feed Thru button will automatically be activated upon the operation on language router LR-10.

◆ Interpreter I (manually)

If only 1- or 2- language interpretation is required, Feed and Feed Thru button can manually be adjusted at this mode.

■ **Compatible receiver *CON-9R***

◆ Interface

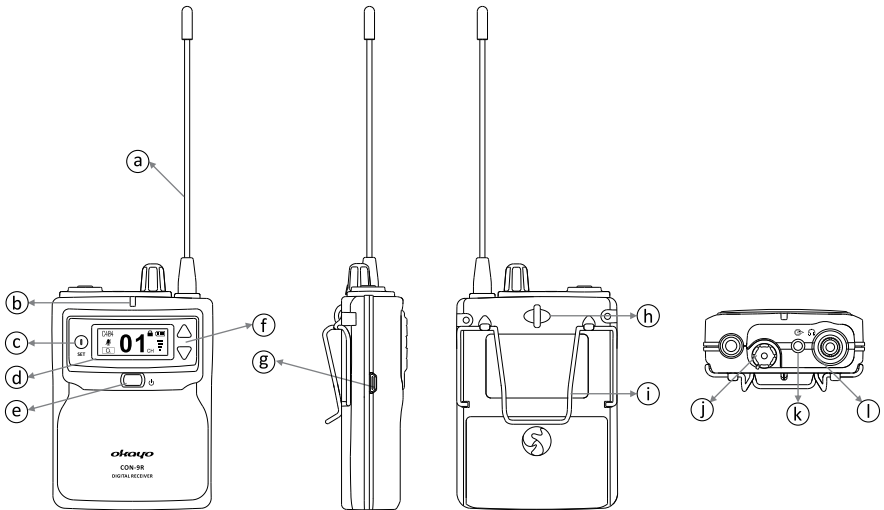

- | | | | |
|--------------------|--------------------|--|------------------|
| Ⓐ Whip antenna | Ⓓ Backlit screen | Ⓔ Charging port
(when NiMH battery applied) | ⓲ Belt clip |
| Ⓑ Rx LED indicator | Ⓔ Power button | ⓳ Lanyard hole | ⓴ Volume knob |
| Ⓒ Set button | Ⓛ Up / Down button | ⓴ Lanyard hole | ⓵ Line-out jack |
| | | | ⓶ Headphone jack |

◆ **Screen**

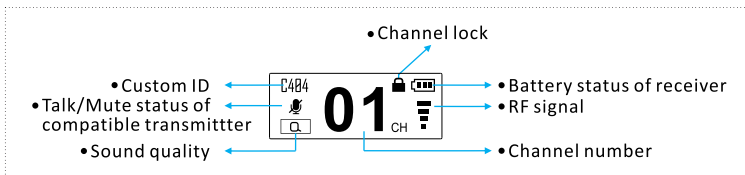

■ Applications

- ◆ Conferencing / Assistive listening (Mode: Transmitter)

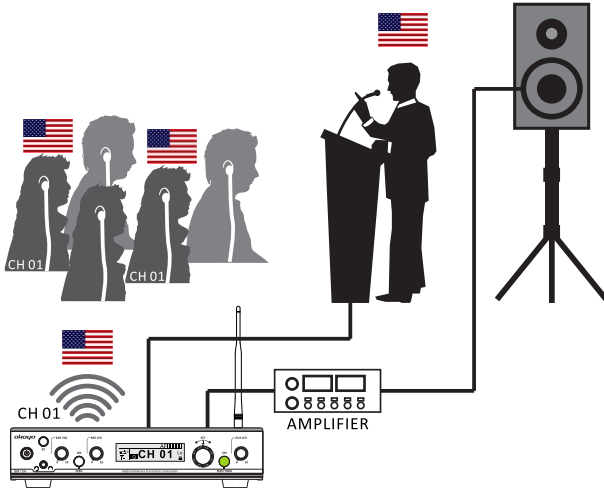

- ◆ Interpretation for multi-languages (Mode: Interpreter O)

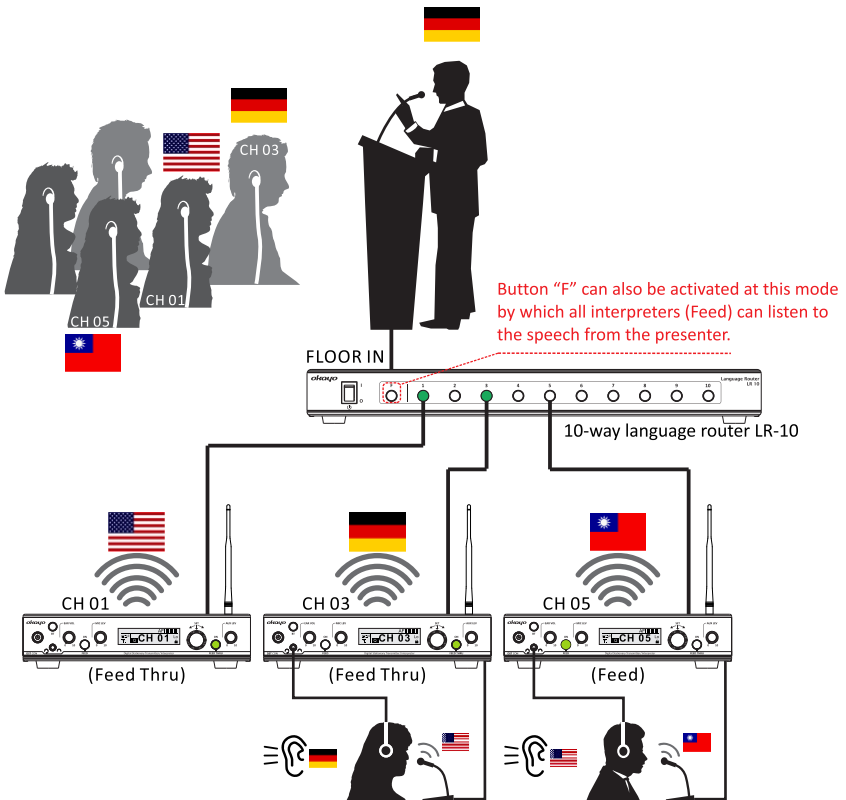

Digital Stationary Transmitter DST-CON

◆ Interpretation for 1~3 languages (Mode: Interpreter I)

