

Customer Information

Declaration of Conformity

Model Name: 2W CLUSTER_ML
Type of product: Digital Cluster with BTLE
Brand: Visteon
Manufacturer: Visteon Corporation
One Village center drive, Van Buren Township
48111-5711 Michigan
United States of America

CE MARK:



Simplified EU DoC:

Hereby, Visteon Corporation declares that the radio equipment type 2W CLUSTER_ML is in compliance with Directive 2014/53/EU. The full text of the EU declaration of conformity is available at the following internet address: <http://www.visteondocs.com/>

български [Bulgarian]	С това фирмата Visteon Corporation декларира, че частта 2W CLUSTER_ML е в съответствие със съществените изисквания и други приложими разпоредби на директивата 2014/53/EC.
Česky [Czech]	Visteon Corporation tímto prohlašuje, že tento 2W CLUSTER_ML je ve shodě se základními požadavky a dalšími příslušnými ustanoveními směrnice 2014/53/EU.
Dansk [Danish]	Undertegnede Visteon Corporation erklærer herved, at følgende udstyr 2W CLUSTER_ML overholder de væsentlige krav og øvrige relevante krav i direktiv 2014/53/EU.
Deutsch [German]	Hiermit erkläre Visteon Corporation , dass sich das Gerät 2W CLUSTER_ML in Übereinstimmung mit den grundlegenden Anforderungen und den übrigen einschlägigen Bestimmungen der Richtlinie 2014/53/EU befindet.
Eesti [Estonian]	Käesolevaga kinnitab Visteon Corporation seadme 2W CLUSTER_ML vastavust direktiivi 2014/53/EL põhinõuetele ja nimetatud direktiivist tulenevatele teistele asjakohastele sätetele.
English	Hereby, Visteon Corporation , declares that this 2W CLUSTER_ML is in compliance with the essential requirements and other relevant provisions of Directive 2014/53/EU.
Español [Spanish]	Por medio de la presente Visteon Corporation declara que el 2W CLUSTER_ML cumple con los requisitos esenciales y cualesquiera otras disposiciones aplicables o exigibles de la Directiva 2014/53/UE.

Ελληνική [Greek]	ΜΕ ΤΗΝ ΠΑΡΟΥΣΑ Visteon Corporation ΔΗΛΩΝΕΙ ΟΤΙ 2W CLUSTER_ML ΣΥΜΜΟΡΦΩΝΕΤΑΙ ΠΡΟΣ ΤΙΣ ΟΥΣΙΩΔΕΙΣ ΑΠΑΙΤΗΣΕΙΣ ΚΑΙ ΤΙΣ ΛΟΙΠΕΣ ΣΧΕΤΙΚΕΣ ΔΙΑΤΑΞΕΙΣ ΤΗΣ ΟΔΗΓΙΑΣ 2014/53/EK.
Français [French]	Par la présente Visteon Corporation déclare que l'appareil 2W CLUSTER_ML est conforme aux exigences essentielles et aux autres dispositions pertinentes de la directive 2014/53/UE.
Italiano [Italian]	Con la presente Visteon Corporation dichiara che questo 2W CLUSTER_ML è conforme ai requisiti essenziali ed alle altre disposizioni pertinenti stabilite dalla direttiva 2014/53/UE.
Latviski [Latvian]	Ar šo Visteon Corporation deklarē, ka 2W CLUSTER_ML atbilst Direktīvas 2014/53/EK būtiskajām prasībām un citiem ar to saistītajiem noteikumiem.
Lietuvių [Lithuanian]	Šiuo Visteon Corporation deklaruoja, kad šis 2W CLUSTER_ML atitinka esminius reikalavimus ir kitas 2014/53/EB Direktyvos nuostatas.
Nederlands [Dutch]	Hierbij verklaart Visteon Corporation dat het toestel 2W CLUSTER_ML in overeenstemming is met de essentiële eisen en de andere relevante bepalingen van richtlijn 2014/53/EG.
Malti [Maltese]	Hawnhekk, Visteon Corporation , jiddikjara li dan 2W CLUSTER_ML jikkonforma mal-ħtiġijiet essenzjali u ma provvedimenti oħrajn relevanti li hemm fid-Dirrettiva 2014/53/UE.
Magyar [Hungarian]	Alulírott, Visteon Corporation nyilatkozik, hogy a 2W CLUSTER_ML megfelel a vonatkozó alapvető követelményeknek és az 2014/53/EU irányelv egyéb előírásainak.
Polski [Polish]	Niniejszym Visteon Corporation oświadcza, że 2W CLUSTER_ML jest zgodny z zasadniczymi wymogami oraz pozostałymi stosownymi postanowieniami Dyrektywy 2014/53/UE.
Português [Portuguese]	Visteon Corporation declara que este 2W CLUSTER_ML está conforme com os requisitos essenciais e outras disposições da Directiva 2014/53/UE.
Slovensko [Slovenian]	Visteon Corporation izjavlja, da je ta 2W CLUSTER_ML v skladu z bistvenimi zahtevami in ostalimi relevantnimi določili direktive 2014/53/ES.
Slovensky [Slovak]	Visteon Corporation týmto vyhlasuje, že 2W CLUSTER_ML spĺňa základné požiadavky a všetky príslušné ustanovenia Smernice 2014/53/EÚ.
Suomi [Finnish]	Visteon Corporation vakuuttaa täten että 2W CLUSTER_ML tyyppinen laite on direktiivin 2014/53/EU oleellisten vaatimusten ja sitä koskevien direktiivin muiden ehtojen mukainen.
Svenska [Swedish]	Härmed intygar Visteon Corporation att denna 2W CLUSTER_ML står i överensstämmelse med de väsentliga egenskapskrav och övriga relevanta bestämmelser som framgår av direktiv 2014/53/EU.
Íslenska [Icelandic]	Hér með lýsir Visteon Corporation yfir því að 2W CLUSTER_ML er í samræmi við grunnkröfur og aðrar kröfur, sem gerðar eru í tilskipun 2014/53/EU.

Norsk [Norwegian]	Visteon Corporation erklærer herved at utstyret 2W CLUSTER_ML er i samsvar med de grunnleggende krav og øvrige relevante krav i direktiv 2014/53/EF.
Crnogorski jezik, Црногорски језик [Montenegrin]	Ovim, Visteon Corporation , izjavljuje da ovaj 2W CLUSTER_ML je usklađen sa bitnim zahtjevima i drugim relevantnim odredbama Direktive 2014/53/UE.
Română [Romanian]	Prin prezenta, Visteon Corporation , declară că acest 2W CLUSTER_ML respectă cerințele esențiale și alte dispoziții relevante din Directiva 2014/53 / UE.
Türkiye [Turkey]	Visteon Corporation , işbu 2W CLUSTER_ML 'in 2014/53 / EU Direktifinin esas şartları ve diğer ilgili hükümlerine uygun olduğunu beyan eder.
Hrvatska [Croatian]	Ovime Visteon Corporation izjavljuje da je ovaj 2W CLUSTER_ML u skladu s osnovnim zahtjevima i ostalim relevantnim odredbama Direktive 2014/53 / EU.

The following information shall also be included in the case of radio equipment intentionally emitting radio waves:

- a. Frequency band : **2.4 GHz**
- b. Maximum radio-frequency power transmitted in the frequency band(s) in which the radio equipment operates. **Max output power = 3.5 dBm**

(U.S.A. and Canada)

FCC

FCC ID: NT8-H2WCLUSTERML

This device complies with Part 15 of the FCC Rules. Operation is subject to the following two conditions:

- (1) This device may not cause harmful interference, and
- (2) The device must accept any interference received, including interference that may cause undesired operation.

Changes or modifications not expressly approved by the party responsible for compliance could void the user's authority to operate the equipment.

Class B device notice

Note: This equipment has been tested and found to comply with the limits for a Class B digital device, pursuant to part 15 of the FCC Rules. These limits are designed to provide reasonable protection against harmful interference in a residential installation. This equipment generates, uses and can radiate radio frequency energy and, if not installed and used in accordance with the instructions, may cause harmful interference to radio communications. However, there is no guarantee that interference will not occur in a particular installation. If this equipment does cause harmful interference to radio or television reception, which can be determined by turning the equipment off and on, the user is encouraged to try to correct the interference by one or more of the following measures:

—Reorient or relocate the receiving antenna.

- Increase the separation between the equipment and receiver.
- Connect the equipment into an outlet on a circuit different from that to which the receiver is connected.
- Consult the dealer or an experienced radio/TV technician for help.

RF exposure safety

This device complies with the FCC RF exposure limits and has been evaluated in compliance with mobile exposure conditions.

The equipment must be installed and operated with minimum distance of 20 cm of the human body.

ISED CANADA

IC: 3043A-H2WCML

This device complies with Industry Canada License-exempt RSS standard(s). Operation is subject to the following two conditions:

- (1) This device may not cause harmful interference, and
- (2) The device must accept any interference received, including interference that may cause undesired operation.

Le présent appareil est conforme aux CNR d'Industrie Canada applicables aux appareils radio exempts de licence. L'exploitation est autorisée aux deux conditions suivantes:

- (1) l'appareil ne doit pas produire de brouillage, et,
- (2) l'utilisateur de l'appareil doit accepter tout brouillage radioélectrique subi, même si le brouillage est susceptible d'en compromettre le fonctionnement.

Changes or modifications not expressly approved by the party responsible for compliance could void the user's authority to operate the equipment.

RF exposure safety

This device complies with ISED RF exposure limits and has been evaluated in compliance with mobile exposure conditions.

The equipment must be installed and operated with minimum distance of 20 cm of the human body.

CAN ICES-003

This Class B digital apparatus complies with Canadian ICES-003.

Les changements ou modifications non expressément approuvés par la partie responsable de la conformité peuvent annuler le droit de l'utilisateur à utiliser l'équipement.

Sécurité d'exposition aux RF

Cet appareil est conforme aux limites d'exposition RF d'ISDE et a été évalué conformément aux conditions d'exposition mobile.

L'équipement doit être installé et utilisé à une distance minimale de 20 cm du corps humain.

CAN NMB-003

Cet appareil numérique de classe B est conforme à la norme canadienne NMB-003.

Argentina



South Korea



인증번호:

인증 받은 자의 상호: Visteon Corporation

기자재의 명칭/ 모델명: 2W CLUSTER_ML

제조연월일: 별도표기

제조자/제조국가: Visteon/USA

Serbia



Singapore

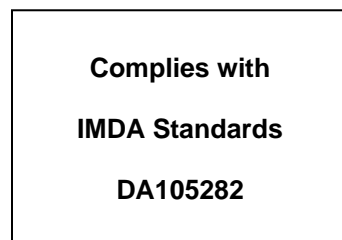

Australia



Thailand



License-exempt radio equipment

United Arab Emirates

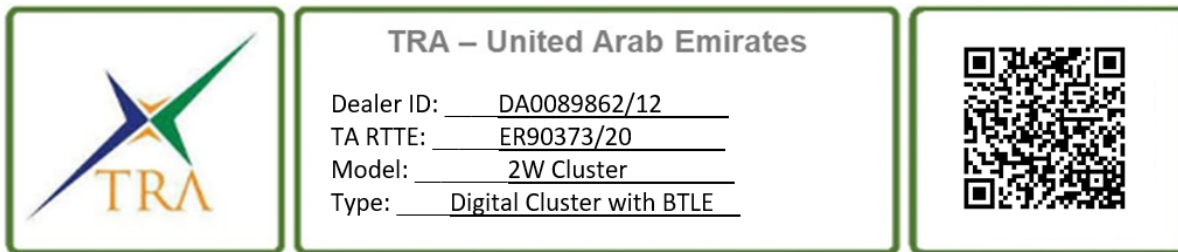

Ukraine

Кінцевий посібник користувача



Модель:

Діапазон частот: 2400 – 2483.5 МГц

Максимальна потужність вихідної потужності (Bluetooth): 3.5 дБм

Дана Visteon Corporation заявляє, що тип радіобладнання (позначення типу радіобладнання) відповідає Технічному регламенту радіобладнання;

Повний текст декларації про відповідність можна знайти на сайті за адресою:

<https://www.visteondocs.com/>.

México

Homologation by **IFETEL ID:**

Certification By : NYCE



'La operación de este equipo está sujeta a las siguientes dos condiciones:

(1) es posible que este equipo o dispositivo no cause interferencia perjudicial y (2) este equipo o dispositivo debe aceptar cualquier interferencia, incluyendo la que pueda causar su operación no deseada'.

a) Lea el Manual antes de operar o usar el Equipo.

b) Name, address and contact telephone of the importer (Honda information)

c) Marca: Visteon Corporation / Nombre del Modelo: 2W CLUSTER_ML

d) Any warnings applicable to the installation and operation of the product and needed to protect the safety and health of the users. ?? (Honda will need to provide this info)

e) Clear instructions about the installation and operation of the equipment (Honda will need to provide this info)

f) Especificaciones Electricas:

Supply voltage: 13,2V (Vcc)

Supply current: 200 mA

Frequency: 2.4 GHz

Taiwan



CCAH20LPA080T

1. Product name: Digital Cluster with BTLE
2. Model name: 2W CLUSTER_ML
3. Manufacturer: Visteon Corporation
4. NCC caution statement:

'Any changes or modifications are not allowed. The product is subject to not cause harmful interference to radio communications and air flight safety. If this equipment does cause interference, which can be determined stop shipping till the product is improved.

This device may not cause harmful interference, and this device must accept any interference received, including interference that may cause undesired operation.'

In Chinese language, the warning would be:

警語

低功率電波輻射性電機管理辦法

第十二條經型式認證合格之低功率射頻電機,非經許可,公司,商號或使用者均不得擅自變更頻率,加大功率或變更原設計之特性及功能。

第十四條低功率射頻電機之使用不得影響飛航影響安全及干擾合法通信,經發現有干擾現象時,應立即停用,並改善至無干擾時方得繼續使用。

前項合法通信,指一電信法規定作業之無線電通信低功率射頻電機需忍受合法通信或工業,科學及醫療用電波輻射性電機設備之干擾。

HONDA 2W CLUSTER_ML

2W CLUSTER_ML Operation Guide

Instruments (Continued)

Setting flow

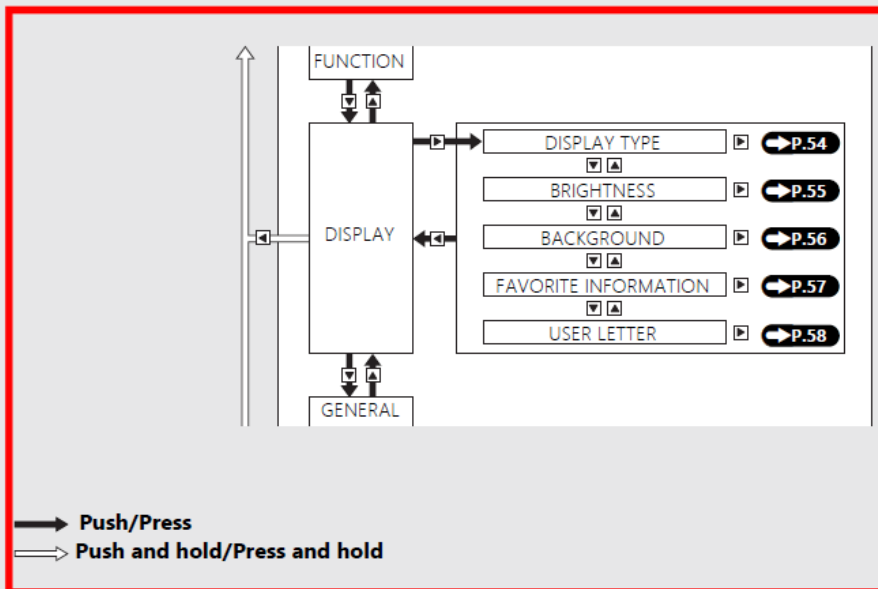
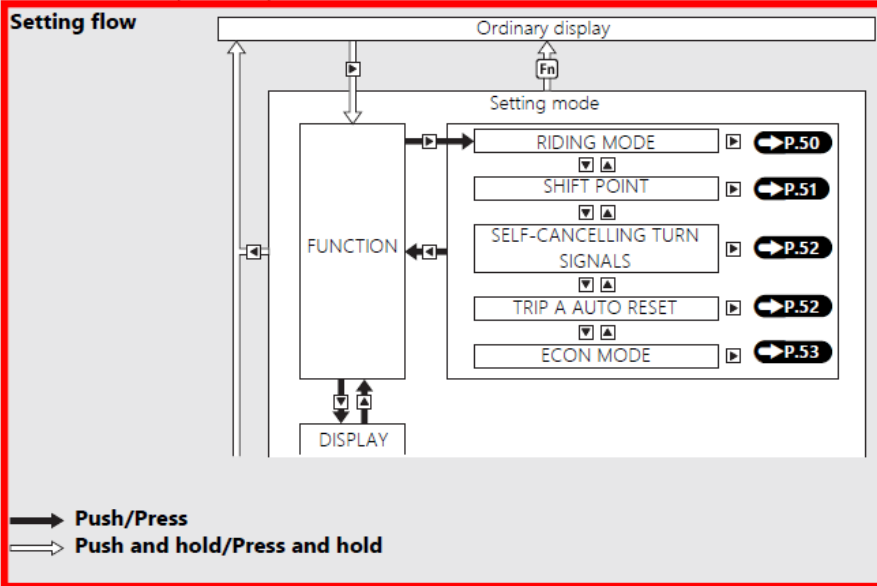

Instruments (Continued)

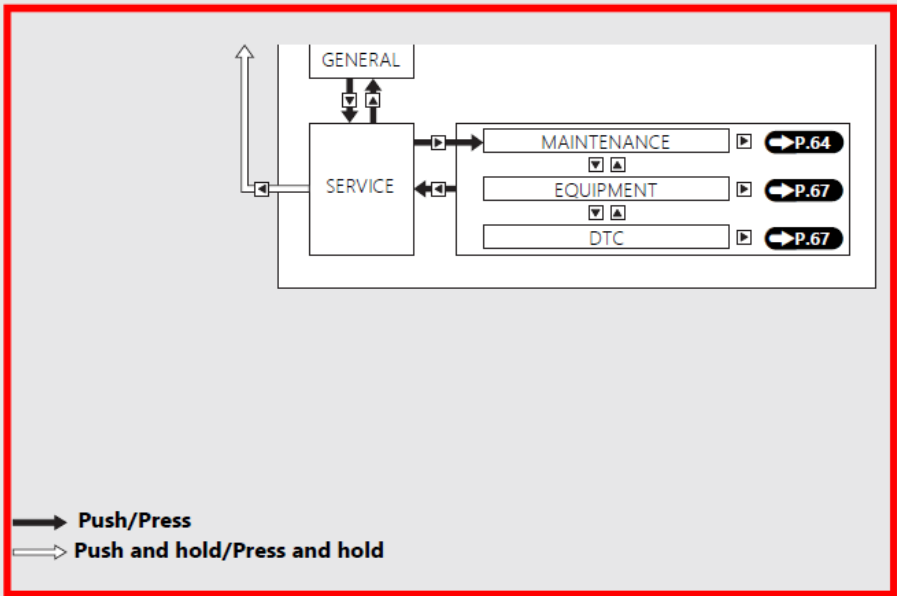
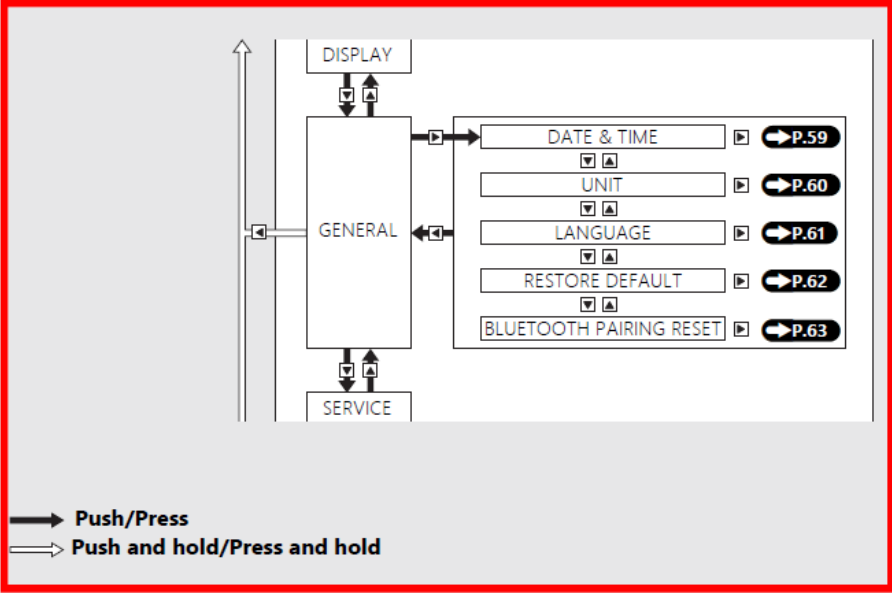

EQUIPMENT

"EQUIPMENT" is displayed but not selectable.

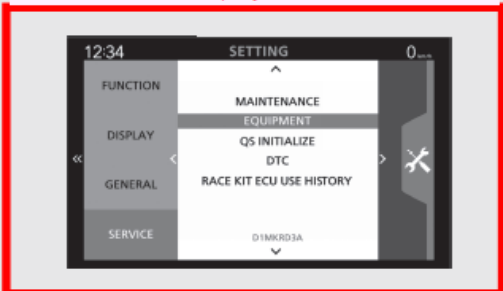

DTC

Displays a current problem with the vehicle. If your vehicle has problem, DTC index is displayed. Reduce speed and have your vehicle inspected by your dealer as soon as possible.

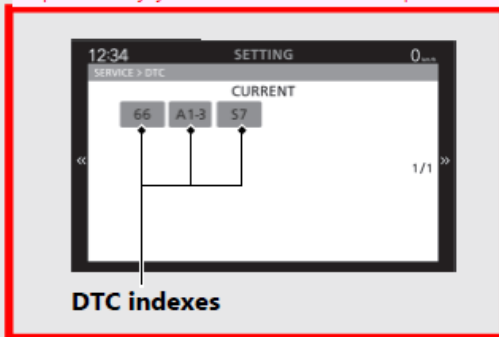

Instructions to access to the electronic labeling

- 1) IGN ON
- 2) Opening animation begins and completes after 3sec.
- 3) Main screen appears like below.



- 4) Long press Right S/W then enters Setting mode
- 5) Setting screen appears like below and FUNCTION is selected at the beginning.

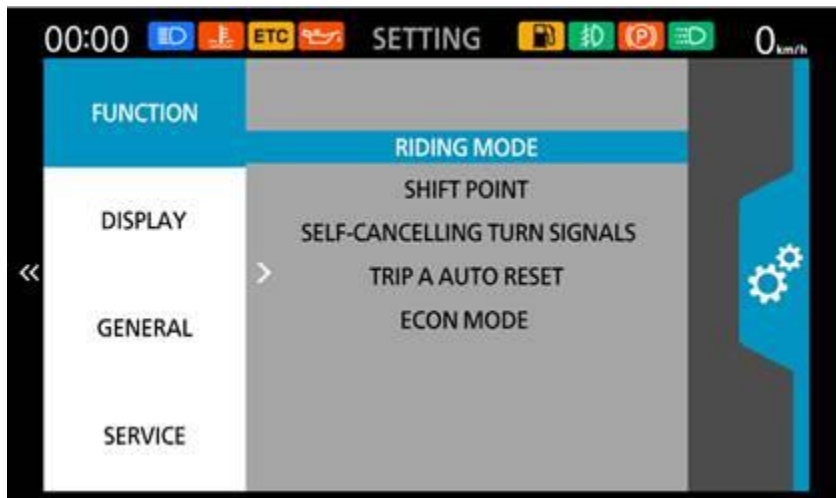

- 6) Short press Down S/W at three times then SERVICE is selected
- 7) Short press Right S/W then MAINTENANCE is selected at center of the screen.

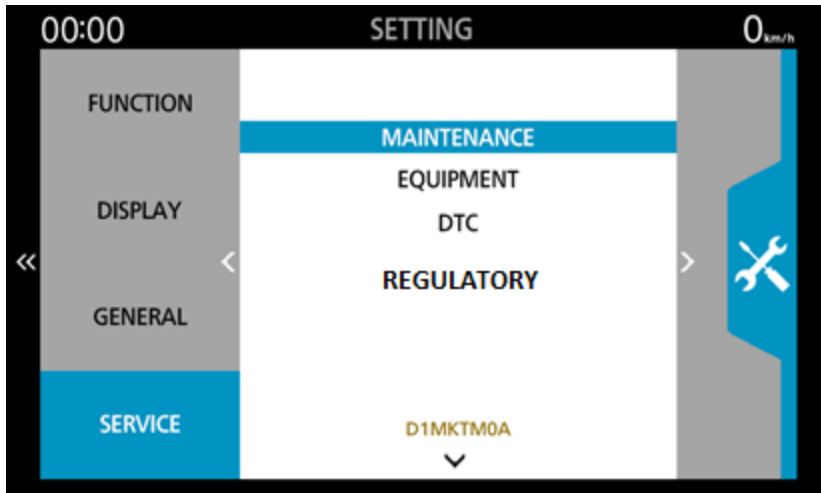

- 8) Short press Down S/W at three times then REGULATORY is selected.
- 9) Short press Right S/W then the REGULATORY screen shows up.

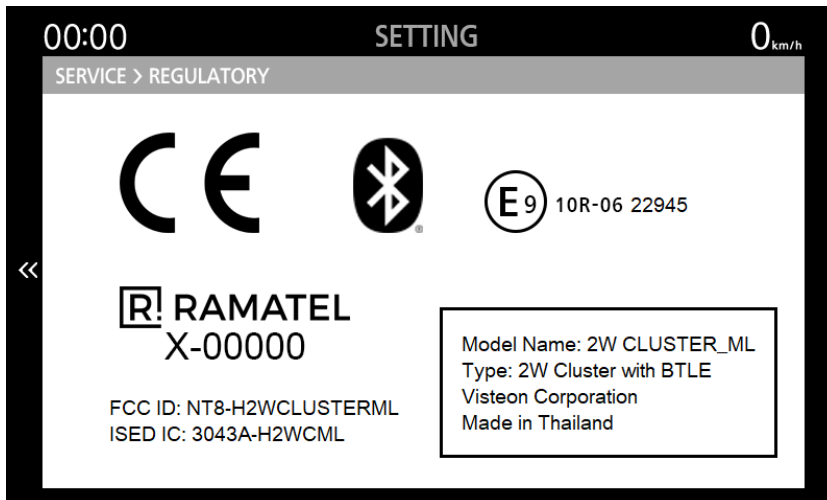

Instrucciones para acceder al etiquetado electrónico.

- 1) ENCENDIDO
- 2) La animación de apertura comienza y se completa después de 3 segundos.
- 3) La pantalla principal aparece como se muestra a continuación.



- 4) Mantenga pulsado el Switch hacia la derecha hasta que ingrese al modo de SETTING
- 5) La pantalla de configuración aparecerá como se muestra a continuación y se selecciona FUNCTION al principio.

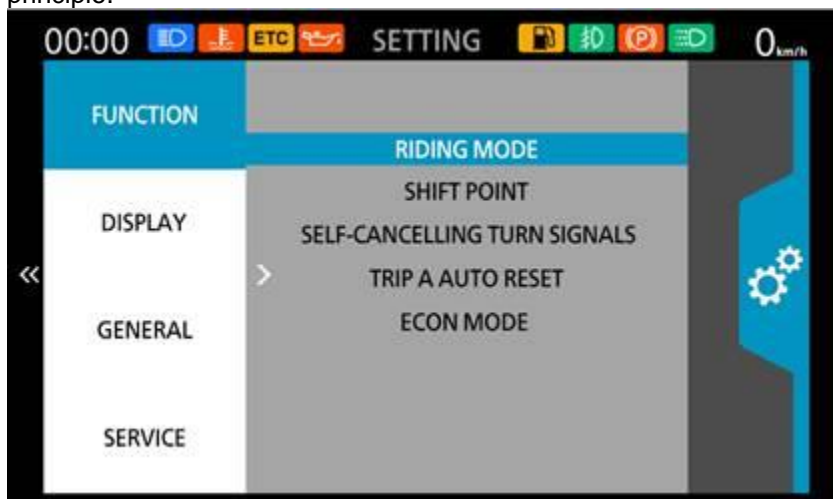

- 6) Presione brevemente el Switch hacia abajo tres veces y luego se selecciona SERVICIO
- 7) Presione brevemente el Switch a la derecha, luego se selecciona MAINTENANCE en el centro de la pantalla.

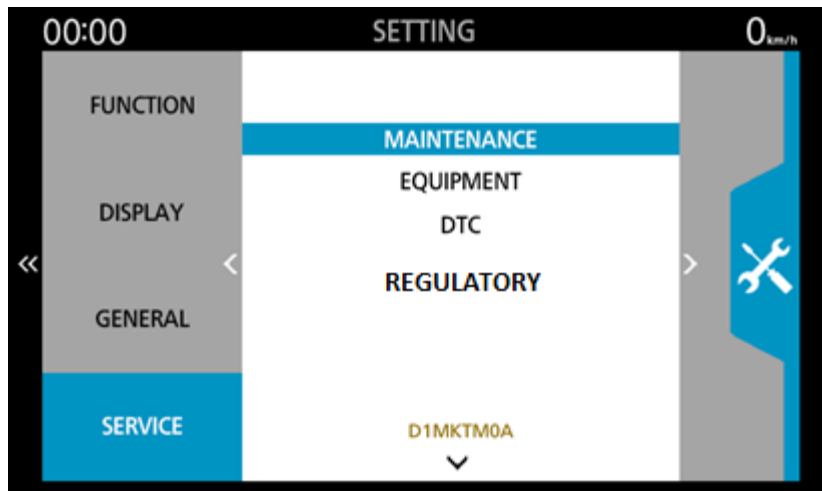

8) Presione brevemente el Switch hacia abajo tres veces y luego se selecciona REGULATORY.

9) Presione brevemente el Switch hacia la derecha y luego aparecerá la pantalla con las etiquetas electrónicas.

