

FCC Test Report (Part 22)

Report No.: RF180504E08

FCC ID: NKR-IMG2

Model: IMG2

Received Date: May 16, 2018

Test Date: Aug. 05 ~ Aug. 06, 2018

Issued Date: Aug. 10, 2018

Applicant: Wistron NeWeb Corporation

Address: 20 Park Avenue II, Hsinchu Science Park, Hsinchu 308, Taiwan, R.O.C.

Issued By: Bureau Veritas Consumer Products Services (H.K.) Ltd., Taoyuan Branch

Lab Address: No. 47-2, 14th Ling, Chia Pau Vil., Lin Kou Dist., New Taipei City, Taiwan (R.O.C.)

Test Location: No. 19, Hwa Ya 2nd Rd., Wen Hwa Vil., Kwei Shan Dist., Taoyuan City 33383, TAIWAN (R.O.C.)

**FCC Registration /
Designation Number:** 788550 / TW0003



This report is for your exclusive use. Any copying or replication of this report to or for any other person or entity, or use of our name or trademark, is permitted only with our prior written permission. This report sets forth our findings solely with respect to the test samples identified herein. The results set forth in this report are not indicative or representative of the quality or characteristics of the lot from which a test sample was taken or any similar or identical product specifically and expressly noted. Our report includes all of the tests requested by you and the results thereof based upon the information that you provided to us. You have 60 days from date of issuance of this report to notify us of any material error or omission caused by our negligence, provided, however, that such notice shall be in writing and shall specifically address the issue you wish to raise. A failure to raise such issue within the prescribed time shall constitute your unqualified acceptance of the completeness of this report, the tests conducted and the correctness of the report contents. Unless specific mention, the uncertainty of measurement has been explicitly taken into account to declare the compliance or non-compliance to the specification. The report must not be used by the client to claim product certification, approval, or endorsement by TAF or any government agencies

Table of Contents

Release Control Record	4
1 Certificate of Conformity	5
2 Summary of Test Results	6
2.1 Measurement Uncertainty.....	6
2.2 Test Site and Instruments.....	7
3 General Information	8
3.1 General Description of EUT.....	8
3.2 Configuration of System under Test.....	9
3.2.1 Description of Support Units.....	9
3.3 Test Mode Applicability and Tested Channel Detail.....	10
3.4 EUT Operating Conditions.....	12
3.5 General Description of Applied Standards.....	12
4 Test Types and Results	13
4.1 Output Power Measurement.....	13
4.1.1 Limits of Output Power Measurement.....	13
4.1.2 Test Procedures.....	13
4.1.3 Test Setup.....	14
4.1.4 Test Results.....	15
4.2 Modulation Characteristics Measurement.....	19
4.2.1 Limits of Modulation Characteristics.....	19
4.2.2 Test Procedure.....	19
4.2.3 Test Setup.....	19
4.2.4 Test Results.....	20
4.3 Frequency Stability Measurement.....	21
4.3.1 Limits of Frequency Stability Measurement.....	21
4.3.2 Test Procedure.....	21
4.3.3 Test Setup.....	21
4.3.4 Test Results.....	22
4.4 Occupied Bandwidth Measurement.....	23
4.4.1 Test Procedure.....	23
4.4.2 Test Setup.....	23
4.4.3 Test Result.....	24
4.5 Band Edge Measurement.....	28
4.5.1 Limits of Band Edge Measurement.....	28
4.5.2 Test Setup.....	28
4.5.3 Test Procedures.....	28
4.5.4 Test Results.....	29
4.6 Peak to Average Ratio.....	33
4.6.1 Limits of Peak to Average Ratio Measurement.....	33
4.6.2 Test Setup.....	33
4.6.3 Test Procedures.....	33
4.6.4 Test Results.....	34
4.7 Conducted Spurious Emissions.....	36
4.7.1 Limits of Conducted Spurious Emissions Measurement.....	36
4.7.2 Test Setup.....	36
4.7.3 Test Procedure.....	36
4.7.4 Test Results.....	37
4.8 Radiated Emission Measurement.....	41
4.8.1 Limits of Radiated Emission Measurement.....	41
4.8.2 Test Procedure.....	41
4.8.3 Deviation from Test Standard.....	41
4.8.4 Test Setup.....	42
4.8.5 Test Results.....	43

5	Pictures of Test Arrangements.....	67
	Appendix – Information on the Testing Laboratories	68

Release Control Record

Issue No.	Description	Date Issued
RF180504E08	Original release	Aug. 10, 2018

1 Certificate of Conformity

Product: IMG2 LTE module

Brand: Wistron Neweb Corporation

Model: IMG2

Sample Status: Engineering sample

Applicant: Wistron NeWeb Corporation

Test Date: Aug. 05 ~ Aug. 06, 2018

Standards: FCC Part 22, Subpart H

The above equipment has been tested by **Bureau Veritas Consumer Products Services (H.K.) Ltd., Taoyuan Branch**, and found compliance with the requirement of the above standards. The test record, data evaluation & Equipment Under Test (EUT) configurations represented herein are true and accurate accounts of the measurements of the sample's RF characteristics under the conditions specified in this report.

Prepared by : Pettie Chen , **Date:** Aug. 10, 2018
Pettie Chen / Senior Specialist

Approved by : Bruce Chen , **Date:** Aug. 10, 2018
Bruce Chen / Project Engineer

2 Summary of Test Results

Applied Standard: FCC Part 22 & Part 2			
FCC Clause	Test Item	Result	Remarks
2.1046 22.913 (a)	Effective radiated power	Pass	Meet the requirement of limit.
2.1047	Modulation characteristics	Pass	Meet the requirement
---	Peak To Average Ratio	Pass	Meet the requirement of limit.
2.1055 22.355	Frequency Stability	Pass	Meet the requirement of limit.
2.1049	Occupied Bandwidth	Pass	Meet the requirement of limit.
22.917	Band Edge Measurements	Pass	Meet the requirement of limit.
2.1051 22.917	Conducted Spurious Emissions	Pass	Meet the requirement of limit.
2.1053 22.917	Radiated Spurious Emissions	Pass	Meet the requirement of limit. Minimum passing margin is -21.77dB at 1658.00 & 1673.00MHz.

2.1 Measurement Uncertainty

Where relevant, the following measurement uncertainty levels have been estimated for tests performed on the EUT as specified in CISPR 16-4-2:

Measurement	Frequency	Expanded Uncertainty (k=2) (±)
Radiated Emissions up to 1 GHz	30MHz ~ 200MHz	2.93 dB
	200MHz ~1000MHz	2.95 dB
Radiated Emissions above 1 GHz	1GHz ~ 18GHz	2.26 dB
	18GHz ~ 40GHz	1.94 dB

2.2 Test Site and Instruments

Description & Manufacturer	Model No.	Serial No.	Cal. Date	Cal. Due
Test Receiver Agilent	N9038A	MY51210203	Mar. 16, 2018	Mar. 15, 2019
Spectrum Analyzer Agilent	N9010A	MY52220314	Nov. 24, 2017	Nov. 23, 2018
Spectrum Analyzer ROHDE & SCHWARZ	FSU43	101261	Jan. 11, 2018	Jan. 10, 2019
HORN Antenna SCHWARZBECK	BBHA 9170	148	Dec. 13, 2017	Dec. 12, 2018
HORN Antenna SCHWARZBECK	BBHA 9120D	9120D-969	Nov. 12, 2017	Nov. 11, 2018
Preamplifier EMCI	EMC 012645	980115	Oct. 20, 2017	Oct. 19, 2018
MXG Vector signal generator Agilent	N5182B	MY53050430	Oct. 24, 2017	Oct. 23, 2018
BILOG Antenna SCHWARZBECK	VULB9168	9168-472	Dec. 06, 2017	Dec. 05, 2018
Radio Communication Analyzer Anritsu	MT8820C	6201300640	Aug. 16, 2017	Aug. 15, 2019
Preamplifier EMCI	EMC 330H	980112	Oct. 13, 2017	Oct. 12, 2018
Power Meter Anritsu	ML2495A	1012010	Aug. 15, 2017	Aug. 14, 2018
Power Sensor Anritsu	MA2411B	1315050	Aug. 15, 2017	Aug. 14, 2018
RF Coaxial Cable HUBER+SUHNNER	EMC104-SM-SM-8000 &3000	140811+170717	Oct. 20, 2017	Oct. 19, 2018
RF Coaxial Cable HUBER+SUHNNER	SUCOFLEX 104	EMC104-SM-SM-1000(1 40807)	Oct. 20, 2017	Oct. 19, 2018
RF Coaxial Cable Worken	8D-FB	Cable-Ch10-01	Oct. 20, 2017	Oct. 19, 2018
Boresight Antenna Fixture	FBA-01	FBA-SIP01	NA	NA
Software BV ADT	E3 6.120103	NA	NA	NA
Antenna Tower MF	MFA-440H	NA	NA	NA
Turn Table MF	MFT-201SS	NA	NA	NA
Antenna Tower & Turn Table Controller MF	MF-7802	NA	NA	NA

- Note: 1. The calibration interval of the above test instruments is 12/24 months and the calibrations are traceable to NML/ROC and NIST/USA.
2. The test was performed in HwaYa Chamber 10.
3. The FCC Designation Number is TW0003. The number will be varied with the Lab location and scope as attached.
4. The IC Site Registration No. is IC 7450F-10.

3 General Information

3.1 General Description of EUT

Product	IMG2 LTE module		
Brand	Wistron Neweb Corporation		
Model	IMG2		
Sample Status	Engineering sample		
Power Supply Rating	3.8Vdc (host)		
Modulation Type	LTE: QPSK, 16QAM		
Operating Frequency	LTE Band 5 (Channel Bandwidth 1.4MHz)	824.7MHz ~ 848.3MHz	
	LTE Band 5 (Channel Bandwidth 3MHz)	825.5MHz ~ 847.5MHz	
	LTE Band 5 (Channel Bandwidth 5MHz)	826.5MHz ~ 846.5MHz	
	LTE Band 5 (Channel Bandwidth 10MHz)	829.0MHz ~ 844.0MHz	
Max. ERP Power		QPSK	16QAM
	LTE Band 5 (Channel Bandwidth 1.4MHz)	271.02mW (24.33dBm)	221.82mW (23.46dBm)
	LTE Band 5 (Channel Bandwidth 3MHz)	286.42mW (24.57dBm)	228.03mW (23.58dBm)
	LTE Band 5 (Channel Bandwidth 5MHz)	300.61mW (24.78dBm)	238.23mW (23.77dBm)
	LTE Band 5 (Channel Bandwidth 10MHz)	318.42mW (25.03dBm)	254.68mW (24.06dBm)
Emission Designator		QPSK	16QAM
	LTE Band 5 (Channel Bandwidth 1.4MHz)	1M12G7D	1M12W7D
	LTE Band 5 (Channel Bandwidth 3MHz)	2M70G7D	2M70W7D
	LTE Band 5 (Channel Bandwidth 5MHz)	4M46G7D	4M48W7D
	LTE Band 5 (Channel Bandwidth 10MHz)	8M96G7D	8M96W7D
Antenna Type	Dipole antenna with 3.2dBi gain		
Antenna Connector	NA		
Accessory Device	NA		
Data Cable Supplied	NA		

3.2 Configuration of System under Test

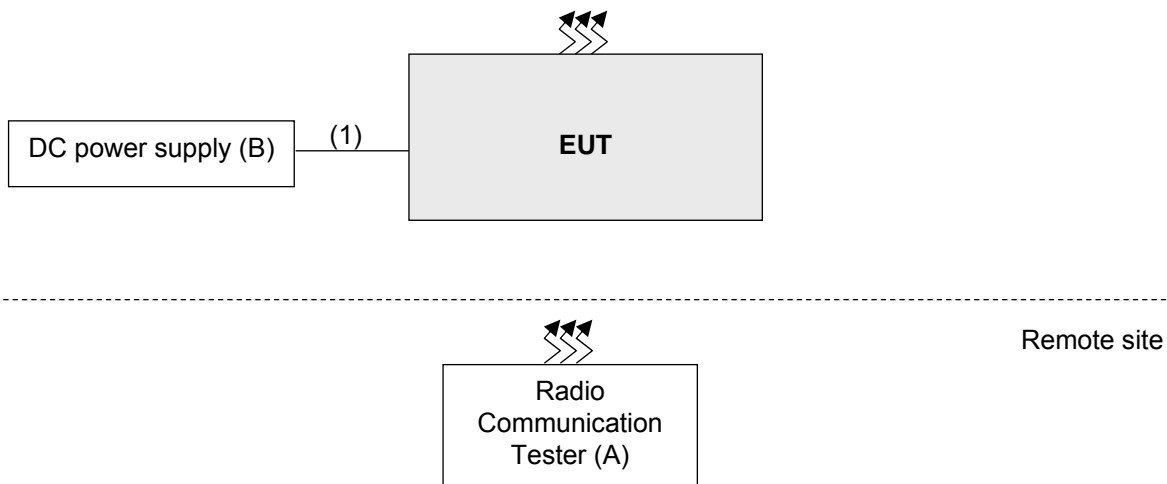

3.2.1 Description of Support Units

The EUT has been tested as an independent unit together with other necessary accessories or support units. The following support units or accessories were used to form a representative test configuration during the tests.

ID	Product	Brand	Model No.	Serial No.	FCC ID	Remarks
A.	Radio Communication Tester	Anritsu	MT8820C	6201300640	NA	-
B.	DC power supply	Topward	3303D	NA	NA	-

Note:

1. All power cords of the above support units are non-shielded (1.8m).
2. Item A acted as a communication partner to transfer data.

ID	Descriptions	Qty.	Length (m)	Shielding (Yes/No)	Cores (Qty.)	Remarks
1.	DC cable	1	1.0	N	0	-

3.3 Test Mode Applicability and Tested Channel Detail

Pre-Scan has been conducted to determine the worst-case mode from all possible combinations between available modulations, data rates, XYZ axis and antenna ports. The worst case was found when positioned on X-plane. Following channel(s) was (were) selected for the final test as listed below:

LTE Band 5

EUT Configure Mode	Test item	Available channel	Tested channel	Channel Bandwidth	Modulation	Mode
-	ERP	20407 to 20643	20407(824.7MHz), 20525(836.5MHz), 20643(848.3MHz)	1.4MHz	QPSK	1 RB / 5 RB Offset
		20415 to 20635	20415(825.5MHz), 20525(836.5MHz), 20635(847.5MHz)	3MHz	QPSK	1 RB / 14 RB Offset
		20425 to 20625	20425(826.5MHz), 20525(836.5MHz), 20625(846.5MHz)	5MHz	QPSK	1 RB / 24 RB Offset
		20450 to 20600	20450(829.0MHz), 20525(836.5MHz), 20600(844.0MHz)	10MHz	QPSK	1 RB / 49 RB Offset
-	Modulation characteristics	20450 to 20600	20525(836.5MHz)	10MHz	QPSK / 16QAM	50 RB / 0 RB Offset
-	Frequency Stability	20407 to 20643	20525(836.5MHz)	1.4MHz	QPSK	1 RB / 5 RB Offset
-	Occupied Bandwidth	20407 to 20643	20407(824.7MHz), 20525(836.5MHz), 20643(848.3MHz)	1.4MHz	QPSK / 16QAM	6 RB / 0RB Offset
		20415 to 20635	20415(825.5MHz), 20525(836.5MHz), 20635(847.5MHz)	3MHz	QPSK / 16QAM	15 RB / 0RB Offset
		20425 to 20625	20425(826.5MHz), 20525(836.5MHz), 20625(846.5MHz)	5MHz	QPSK / 16QAM	25RB / 0RB Offset
		20450 to 20600	20450(829.0MHz), 20525(836.5MHz), 20600(844.0MHz)	10MHz	QPSK / 16QAM	50RB / 0RB Offset
-	Band Edge	20407 to 20643	20407(824.7MHz), 20643(848.3MHz)	1.4MHz	QPSK	1 RB / 0 RB Offset 1 RB / 5 RB Offset 6 RB / 0 RB Offset
		20415 to 20635	20415(825.5MHz), 20635(847.5MHz)	3MHz	QPSK	1 RB / 0 RB Offset 1 RB / 14 RB Offset 15 RB / 0 RB Offset
		20425 to 20625	20425(826.5MHz), 20625(846.5MHz)	5MHz	QPSK	1 RB / 0 RB Offset 1 RB / 24 RB Offset 25 RB / 0 RB Offset
		20450 to 20600	20450(829.0MHz), 20600(844.0MHz)	10MHz	QPSK	1 RB / 0 RB Offset 1 RB / 49 RB Offset 50 RB / 0 RB Offset

EUT Configure Mode	Test item	Available channel	Tested channel	Channel Bandwidth	Modulation	Mode
-	Peak to Average Ratio	20407 to 20643	20407(824.7MHz), 20525(836.5MHz), 20643(848.3MHz)	1.4MHz	QPSK / 16QAM	1 RB / 0 RB Offset
		20415 to 20635	20415(825.5MHz), 20525(836.5MHz), 20635(847.5MHz)	3MHz	QPSK / 16QAM	1 RB / 0 RB Offset
		20425 to 20625	20425(826.5MHz), 20525(836.5MHz), 20625(846.5MHz)	5MHz	QPSK / 16QAM	1 RB / 0 RB Offset
		20450 to 20600	20450(829.0MHz), 20525(836.5MHz), 20600(844.0MHz)	10MHz	QPSK / 16QAM	1 RB / 0 RB Offset
-	Conducted Emission	20407 to 20643	20407(824.7MHz), 20525(836.5MHz), 20643(848.3MHz)	1.4MHz	QPSK	1 RB / 0 RB Offset
		20415 to 20635	20415(825.5MHz), 20525(836.5MHz), 20635(847.5MHz)	3MHz	QPSK	1 RB / 0 RB Offset
		20425 to 20625	20425(826.5MHz), 20525(836.5MHz), 20625(846.5MHz)	5MHz	QPSK	1 RB / 0 RB Offset
		20450 to 20600	20450(829.0MHz), 20525(836.5MHz), 20600(844.0MHz)	10MHz	QPSK	1 RB / 0 RB Offset
-	Radiated Emission Below 1GHz	20450 to 20600	20525(836.5MHz)	10MHz	QPSK	1 RB / 49 RB Offset
-	Radiated Emission	20407 to 20643	20407(824.7MHz), 20525(836.5MHz), 20643(848.3MHz)	1.4MHz	QPSK	1 RB / 5 RB Offset
		20415 to 20635	20415(825.5MHz), 20525(836.5MHz), 20635(847.5MHz)	3MHz	QPSK	1 RB / 14 RB Offset
		20425 to 20625	20425(826.5MHz), 20525(836.5MHz), 20625(846.5MHz)	5MHz	QPSK	1 RB / 24 RB Offset
		20450 to 20600	20450(829.0MHz), 20525(836.5MHz), 20600(844.0MHz)	10MHz	QPSK	1 RB / 49 RB Offset

Note:

1. The conducted output power for QPSK, 16QAM, and measured value of QPSK is higher than 16QAM mode. Therefore, only occupied bandwidth and Peak to average ratio items had been tested under QPSK, 16QAM modes, the other test items were performed under QPSK mode only.

Test Condition:

Test Item	Environmental Conditions	Input Power	Tested By
ERP	22deg. C, 66%RH	120Vac, 60Hz	Han Wu
Modulation characteristics	24deg. C, 64%RH	120Vac, 60Hz	James Yang
Frequency Stability	24deg. C, 64%RH	120Vac, 60Hz	James Yang
Occupied Bandwidth	24deg. C, 64%RH	120Vac, 60Hz	James Yang
Band Edge	24deg. C, 64%RH	120Vac, 60Hz	James Yang
Peak To Average Ratio	24deg. C, 64%RH	120Vac, 60Hz	James Yang
Conducted Emission	24deg. C, 64%RH	120Vac, 60Hz	James Yang
Radiated Emission	22deg. C, 66%RH	120Vac, 60Hz	Jisyong Wang

3.4 EUT Operating Conditions

The EUT makes a call to the communication simulator. The communication simulator station system controlled a EUT to export maximum output power under transmission mode and specific channel frequency

3.5 General Description of Applied Standards

The EUT is a RF Product. According to the specifications of the manufacturer, it must comply with the requirements of the following standards:

FCC 47 CFR Part 2

FCC 47 CFR Part 22

KDB 971168 D01 Power Meas License Digital Systems v03r01

ANSI/TIA/EIA-603-E 2016

ANSI 63.26-2015

All test items have been performed and recorded as per the above standards.

4 Test Types and Results

4.1 Output Power Measurement

4.1.1 Limits of Output Power Measurement

Mobile / Portable station are limited to 7 watts e.r.p.

4.1.2 Test Procedures

EIRP / ERP Measurement:

- a. All measurements were done at low, middle and high operational frequency range. RBW and VBW is 10MHz for LTE mode.
- b. Substitution method is used for E.I.R.P measurement. In the semi-anechoic chamber, EUT placed on the 0.8m(below or equal 1GHz) and/or 1.5m(above 1GHz) height of Turn Table, rotated the table around 360 degrees to search the maximum radiation power and receiver antenna shall be rotated vertical and horizontal polarization and moved height from 1m to 4m to find the maximum polar radiated power. The "Read Value" is the spectrum reading the maximum power value.
- c. The substitution horn antenna is substituted for EUT at the same position and signals generator export the CW signal to the substitution antenna via a TX cable. Rotated the Turn Table and moved receiving antenna to find the maximum radiation power. Adjust output power level of S.G to get a Value of spectrum reading equal to "Read Value" of step b. Record the power level of S.G
- d. EIRP = Output power level of S.G – TX cable loss + Antenna gain of substitution horn. E.R.P power can be calculated form E.I.R.P power by subtracting the gain of dipole, E.R.P power = E.I.R.P power - 2.15dB.

Where:

$$ERP/EIRP = P_{Meas} + G_T - L_C$$

P_{Meas} : Measure transmitter output power.

G_T : Gain of the transmitting antenna.

L_C : signal attenuation in the connecting cable between the transmitter and antenna.

Conducted Power Measurement:

The EUT was set up for the maximum power with LTE link data modulation and link up with simulator. Set the EUT to transmit under low, middle and high channel and record the power level shown on simulator.

4.1.3 Test Setup

EIRP / ERP Measurement:

For Radiated Emission below or equal 1GHz

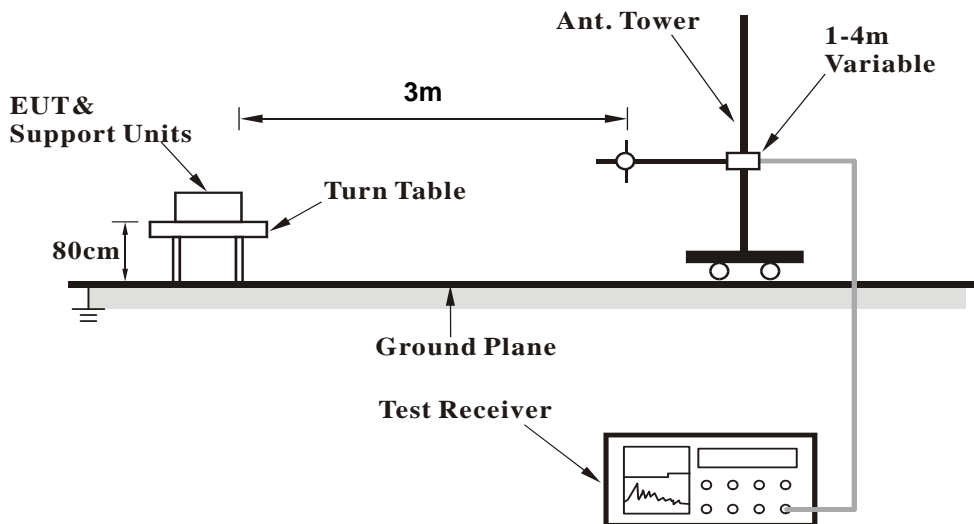

For Radiated Emission above 1GHz

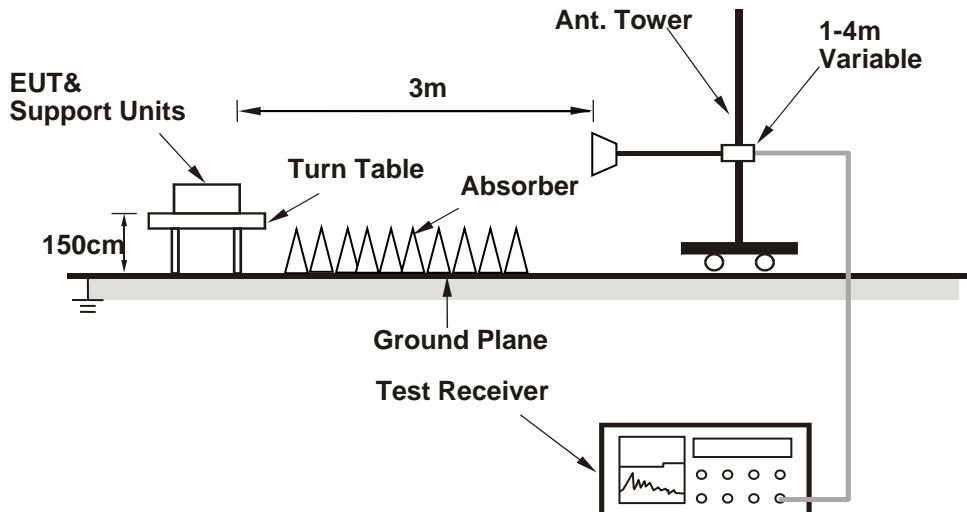

For the actual test configuration, please refer to the attached file (Test Setup Photo).

Conducted Power Measurement:



For the actual test configuration, please refer to the attached file (Test Setup Photo).

4.1.4 Test Results

Conducted Output Power (dBm)

Band / BW	RB Size	RB Offset	QPSK			16QAM		
			Low CH	Mid CH	High CH	Low CH	Mid CH	High CH
			20407	20525	20643	20407	20525	20643
			824.7 MHz	836.5 MHz	848.3 MHz	824.7 MHz	836.5 MHz	848.3 MHz
5 / 1.4M	1	0	23.86	24.13	24.01	22.59	23.25	23.01
	1	2	23.81	24.08	23.96	22.67	23.16	23.06
	1	5	23.83	24.12	23.98	22.61	23.13	22.92
	3	0	23.79	24.08	23.86	22.54	23.21	22.91
	3	1	23.81	24.01	23.81	22.58	23.06	22.87
	3	3	23.76	24.03	23.82	22.54	23.01	22.76
	6	0	23.18	23.36	23.24	22.46	22.96	22.71

Band / BW	RB Size	RB Offset	QPSK			16QAM		
			Low CH	Mid CH	High CH	Low CH	Mid CH	High CH
			20415	20525	20635	20415	20525	20635
			825.5 MHz	836.5 MHz	847.5 MHz	825.5 MHz	836.5 MHz	847.5 MHz
5 / 3M	1	0	23.86	24.07	23.92	22.96	23.38	23.17
	1	7	23.82	24.01	23.87	22.85	23.29	23.11
	1	14	23.81	24.05	23.75	22.87	23.26	23.12
	8	0	23.06	23.35	23.18	22.79	23.30	23.09
	8	3	23.04	23.29	23.09	22.81	23.16	23.02
	8	7	23.01	23.27	23.01	22.77	23.12	22.98
	15	0	22.95	23.32	23.19	22.54	22.98	22.62

Band / BW	RB Size	RB Offset	QPSK			16QAM		
			Low CH	Mid CH	High CH	Low CH	Mid CH	High CH
			20425	20525	20625	20425	20525	20625
			826.5 MHz	836.5 MHz	846.5 MHz	826.5 MHz	836.5 MHz	846.5 MHz
5 / 5M	1	0	24.02	24.35	24.27	23.25	23.48	23.39
	1	12	23.96	24.29	24.15	23.16	23.44	23.21
	1	24	24.01	24.27	24.19	23.11	23.38	23.30
	12	0	24.03	24.21	24.18	23.07	23.36	23.18
	12	6	23.92	24.18	24.07	23.11	23.35	23.29
	12	13	23.96	24.19	24.11	23.14	23.32	23.16
	25	0	22.81	23.07	22.96	22.01	22.16	22.09

Band / BW	RB Size	RB Offset	QPSK			16QAM		
			Low CH 20450	Mid CH 20525	High CH 20600	Low CH 20450	Mid CH 20525	High CH 20600
			829 MHz	836.5 MHz	844 MHz	829 MHz	836.5 MHz	844 MHz
5 / 10M	1	0	23.46	23.77	23.56	22.38	22.57	22.49
	1	24	23.41	23.65	23.54	22.31	22.47	22.46
	1	49	23.28	23.67	23.62	22.27	22.39	22.26
	25	0	22.65	22.87	22.71	21.59	21.68	21.48
	25	12	22.69	22.87	22.74	21.52	21.72	21.57
	25	25	22.70	22.81	22.69	21.60	21.72	21.64
	50	0	22.84	23.14	23.01	21.79	22.18	21.83

ERP Power

LTE Band 5							
Channel Bandwidth: 1.4MHz / QPSK							
Plane	Channel	Frequency (MHz)	Reading (dBm)	Correction Factor (dB)	ERP(dBm)	ERP(mW)	Polarization (H/V)
X	20407	824.7	-6.14	32.62	24.33	271.02	H
	20525	836.5	-6.30	32.52	24.07	255.27	
	20643	848.3	-6.64	32.65	23.86	243.22	
	20407	824.7	-11.29	32.76	19.32	85.51	V
	20525	836.5	-11.25	32.39	18.99	79.25	
	20643	848.3	-11.70	32.54	18.69	73.96	
Channel Bandwidth: 3MHz / QPSK							
Plane	Channel	Frequency (MHz)	Reading (dBm)	Correction Factor (dB)	ERP(dBm)	ERP(mW)	Polarization (H/V)
X	20415	825.5	-5.90	32.62	24.57	286.42	H
	20525	836.5	-6.06	32.52	24.31	269.77	
	20635	847.5	-6.40	32.65	24.10	257.04	
	20415	825.5	-11.05	32.76	19.56	90.36	V
	20525	836.5	-11.01	32.39	19.23	83.75	
	20635	847.5	-11.46	32.54	18.93	78.16	
Channel Bandwidth: 5MHz / QPSK							
Plane	Channel	Frequency (MHz)	Reading (dBm)	Correction Factor (dB)	ERP(dBm)	ERP(mW)	Polarization (H/V)
X	20425	826.5	-5.69	32.62	24.78	300.61	H
	20525	836.5	-5.85	32.52	24.52	283.14	
	20625	846.5	-6.19	32.65	24.31	269.77	
	20425	826.5	-10.84	32.76	19.77	94.84	V
	20525	836.5	-10.80	32.39	19.44	87.90	
	20625	846.5	-11.25	32.54	19.14	82.04	
Channel Bandwidth: 10MHz / QPSK							
Plane	Channel	Frequency (MHz)	Reading (dBm)	Correction Factor (dB)	ERP(dBm)	ERP(mW)	Polarization (H/V)
X	20450	829	-5.44	32.62	25.03	318.42	H
	20525	836.5	-5.60	32.52	24.77	299.92	
	20600	844	-5.94	32.65	24.56	285.76	
	20450	829	-10.59	32.76	20.02	100.46	V
	20525	836.5	-10.55	32.39	19.69	93.11	
	20600	844	-11.00	32.54	19.39	86.90	

Note: ERP (dBm) = Reading (dBm) + Correction Factor (dB) – 2.15

LTE Band 5							
Channel Bandwidth: 1.4MHz / 16QAM							
Plane	Channel	Frequency (MHz)	Reading (dBm)	Correction Factor (dB)	ERP(dBm)	ERP(mW)	Polarization (H/V)
X	20407	824.7	-7.01	32.62	23.46	221.82	H
	20525	836.5	-7.17	32.52	23.20	208.93	
	20643	848.3	-7.51	32.65	22.99	199.07	
	20407	824.7	-12.16	32.76	18.45	69.98	V
	20525	836.5	-12.12	32.39	18.12	64.86	
	20643	848.3	-12.57	32.54	17.82	60.53	
Channel Bandwidth: 3MHz / 16QAM							
Plane	Channel	Frequency (MHz)	Reading (dBm)	Correction Factor (dB)	ERP(dBm)	ERP(mW)	Polarization (H/V)
X	20415	825.5	-6.89	32.62	23.58	228.03	H
	20525	836.5	-7.05	32.52	23.32	214.78	
	20635	847.5	-7.39	32.65	23.11	204.64	
	20415	825.5	-12.04	32.76	18.57	71.94	V
	20525	836.5	-12.00	32.39	18.24	66.68	
	20635	847.5	-12.45	32.54	17.94	62.23	
Channel Bandwidth: 5MHz / 16QAM							
Plane	Channel	Frequency (MHz)	Reading (dBm)	Correction Factor (dB)	ERP(dBm)	ERP(mW)	Polarization (H/V)
X	20425	826.5	-6.70	32.62	23.77	238.23	H
	20525	836.5	-6.86	32.52	23.51	224.39	
	20625	846.5	-7.20	32.65	23.30	213.80	
	20425	826.5	-11.85	32.76	18.76	75.16	V
	20525	836.5	-11.81	32.39	18.43	69.66	
	20625	846.5	-12.26	32.54	18.13	65.01	
Channel Bandwidth: 10MHz / 16QAM							
Plane	Channel	Frequency (MHz)	Reading (dBm)	Correction Factor (dB)	ERP(dBm)	ERP(mW)	Polarization (H/V)
X	20450	829	-6.41	32.62	24.06	254.68	H
	20525	836.5	-6.57	32.52	23.80	239.88	
	20600	844	-6.91	32.65	23.59	228.56	
	20450	829	-11.56	32.76	19.05	80.35	V
	20525	836.5	-11.52	32.39	18.72	74.47	
	20600	844	-11.97	32.54	18.42	69.50	

Note: ERP (dBm) = Reading (dBm) + Correction Factor (dB) – 2.15

4.2 Modulation Characteristics Measurement

4.2.1 Limits of Modulation Characteristics

N/A

4.2.2 Test Procedure

Connect the EUT to Communication Simulator via the antenna connector, The frequency band is set as EUT supported Modulation and Channels, the EUT output is matched with 50 ohm load, the waveform quality and constellation of the EUT was tested.

4.2.3 Test Setup



4.2.4 Test Results

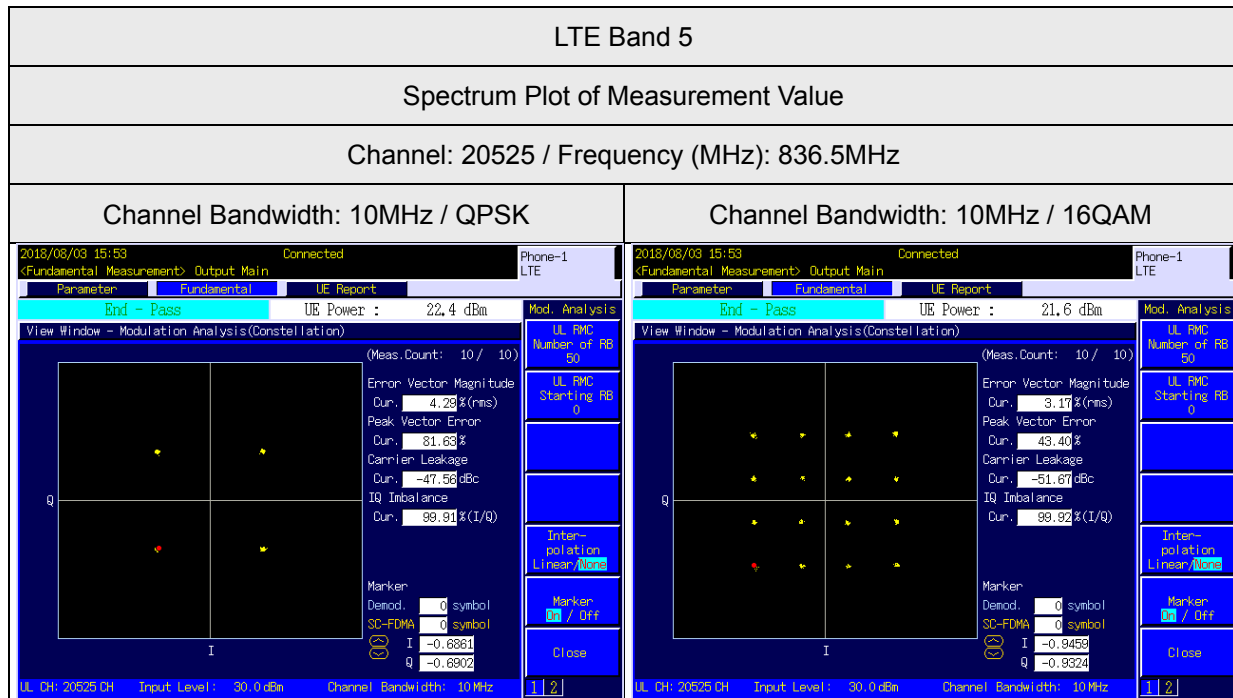

4.3 Frequency Stability Measurement

4.3.1 Limits of Frequency Stability Measurement

1.5 ppm is for base and fixed station. 2.5 ppm is for mobile station.

4.3.2 Test Procedure

- a. Device is placed at the oven room. The oven room could control the temperatures and humidity. Power warm up is at least 15 min and power applied should perform before recording frequency error.
- b. EUT is connected the external power supply to control the DC input power. The test voltage range is from minimum to maximum working voltage. Each step shall be record the frequency error rate.
- c. The temperature range step is 10 degrees in this test items. All temperature levels shall be hold the ± 0.5 °C during the measurement testing. The each temperature step shall be at least 0.5 hours, consider the EUT could be test under the stability condition.

NOTE: The frequency error was recorded frequency error from the communication simulator.

4.3.3 Test Setup

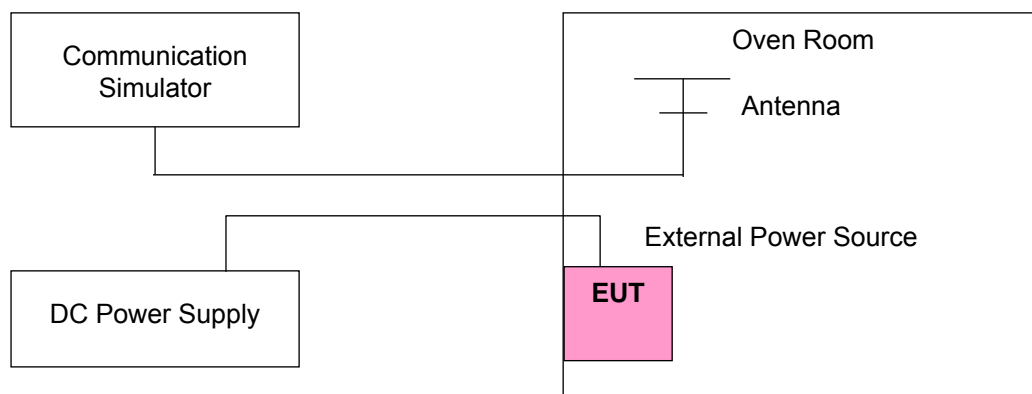

4.3.4 Test Results

Frequency Error vs. Voltage

Voltage (Volts)	Frequency Error (ppm)	Limit (ppm)
	LTE Band 5	
4.4	0.06124	2.5
3.8	0.01334	2.5
3.2	0.05252	2.5

Note: The applicant defined the normal working voltage is from 3.2Vdc to 4.4Vdc.

Frequency Error vs. Temperature.

Temp. (°C)	Frequency Error (ppm)	Limit (ppm)
	LTE Band 5	
50	0.07333	2.5
40	0.04046	2.5
30	0.00576	2.5
20	0.01334	2.5
10	0.07380	2.5
0	0.07343	2.5
-10	0.05270	2.5
-20	0.02970	2.5
-30	0.05373	2.5

4.4 Occupied Bandwidth Measurement

4.4.1 Test Procedure

The EUT makes a call to the communication simulator. All measurements were done at low, middle and high operational frequency range. The communication simulator station system controlled a EUT to export maximum output power under transmission mode and specific channel frequency. Use OBW measurement function of Spectrum analyzer to measure 99 % occupied bandwidth.

4.4.2 Test Setup

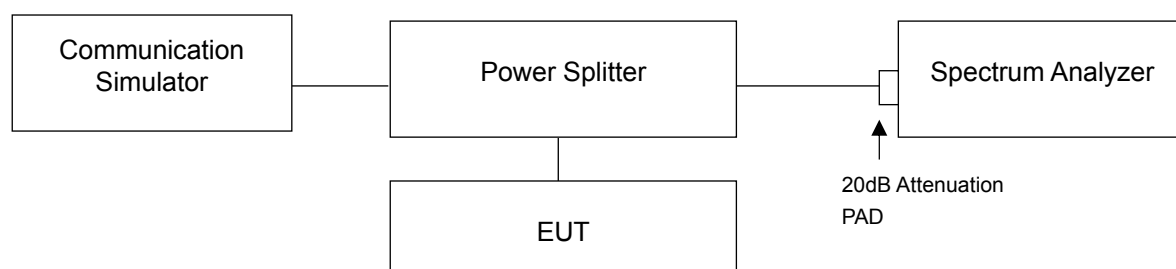

4.4.3 Test Result

LTE Band 5, Channel Bandwidth 1.4MHz			
Channel	Frequency (MHz)	26dB Bandwidth (MHz)	
		QPSK	16QAM
20407	824.7	1.610	1.585
20525	836.5	1.620	1.647
20643	848.3	1.529	1.589

LTE Band 5, Channel Bandwidth 3MHz			
Channel	Frequency (MHz)	26dB Bandwidth (MHz)	
		QPSK	16QAM
20415	825.5	3.252	3.299
20525	836.5	3.216	3.214
20635	847.5	3.232	3.299

LTE Band 5, Channel Bandwidth 5MHz			
Channel	Frequency (MHz)	26dB Bandwidth (MHz)	
		QPSK	16QAM
20425	826.5	5.150	5.140
20525	836.5	5.090	5.061
20625	846.5	5.123	5.126

LTE Band 5, Channel Bandwidth 10MHz			
Channel	Frequency (MHz)	26dB Bandwidth (MHz)	
		QPSK	16QAM
20450	829.0	9.727	9.697
20525	836.5	9.532	9.637
20600	844.0	9.792	9.713

Spectrum Plot of Worst Value

1.4MHz / 16QAM

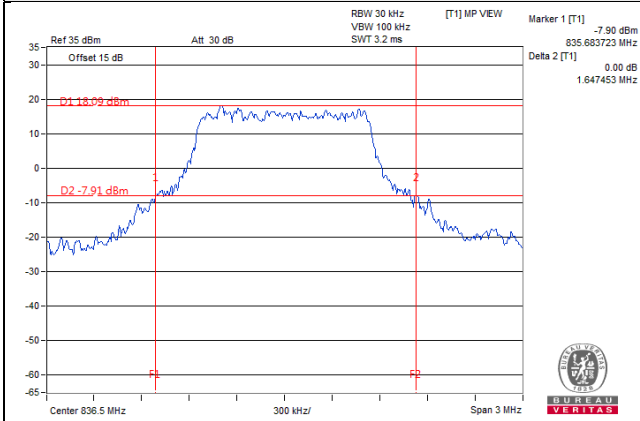

3MHz / 16QAM

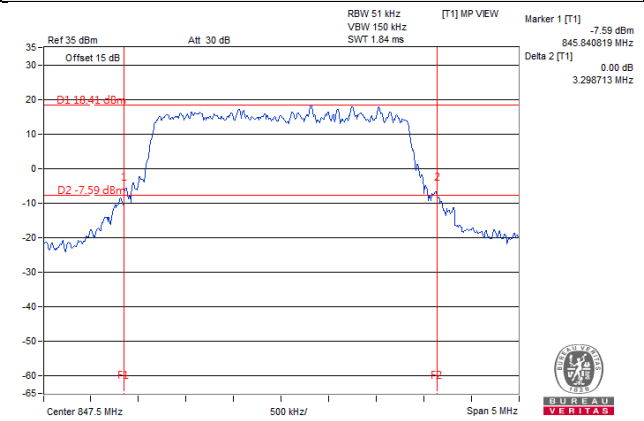

5MHz / QPSK

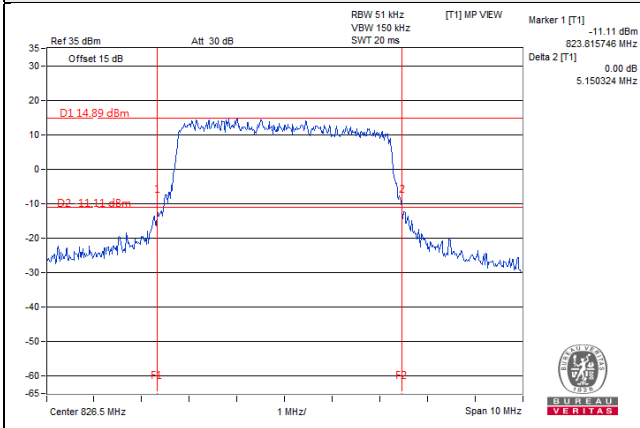

10MHz / QPSK

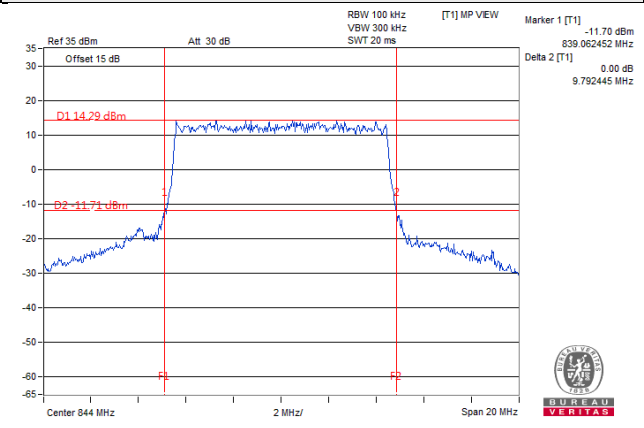

Occupied Bandwidth

LTE Band 5, Channel Bandwidth 1.4MHz			
Channel	Frequency (MHz)	99% Occupied Bandwidth (MHz)	
		QPSK	16QAM
20407	824.7	1.12	1.12
20525	836.5	1.12	1.12
20643	848.3	1.12	1.12

LTE Band 5, Channel Bandwidth 3MHz			
Channel	Frequency (MHz)	99% Occupied Bandwidth (MHz)	
		QPSK	16QAM
20415	825.5	2.70	2.69
20525	836.5	2.70	2.70
20635	847.5	2.70	2.70

LTE Band 5, Channel Bandwidth 5MHz			
Channel	Frequency (MHz)	99% Occupied Bandwidth (MHz)	
		QPSK	16QAM
20425	826.5	4.46	4.46
20525	836.5	4.46	4.48
20625	846.5	4.46	4.48

LTE Band 5, Channel Bandwidth 10MHz			
Channel	Frequency (MHz)	99% Occupied Bandwidth (MHz)	
		QPSK	16QAM
20450	829.0	8.96	8.96
20525	836.5	8.90	8.90
20600	844.0	8.93	8.96

Spectrum Plot of Worst Value

1.4MHz / QPSK

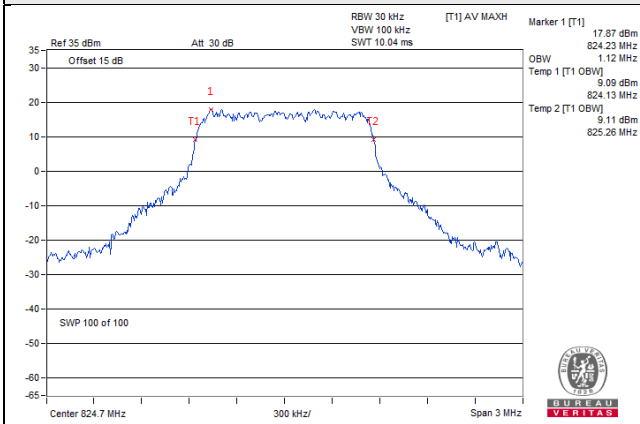

3MHz / 16QAM

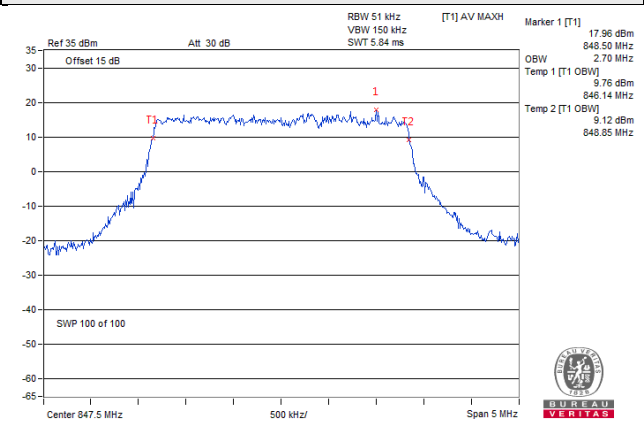

5MHz / 16QAM

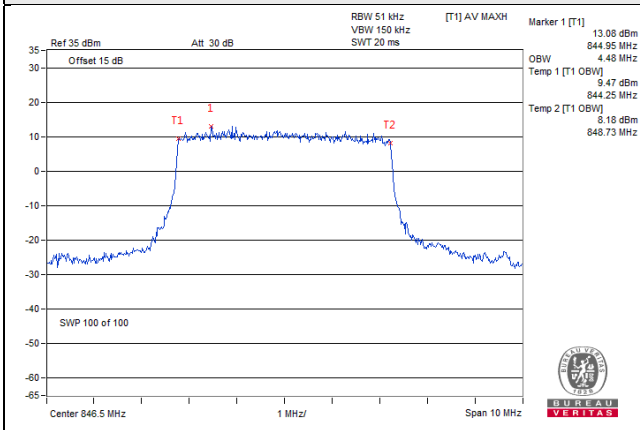

10MHz / QPSK

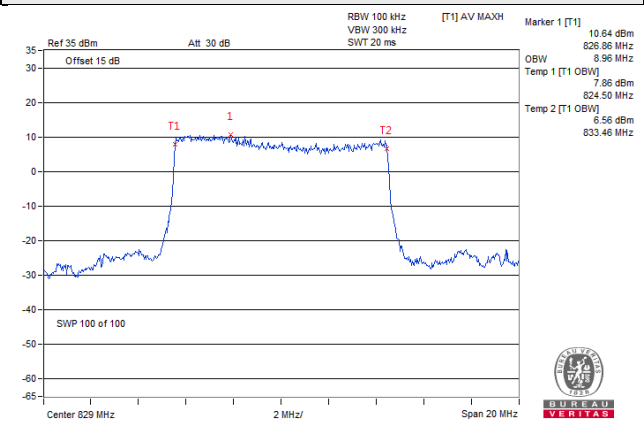

4.5 Band Edge Measurement

4.5.1 Limits of Band Edge Measurement

Power of any emission outside of the authorized operating frequency ranges must be attenuated below the transmitting power (P) by a factor of at least $43 + 10 \log(P)$ dB. In the 1 MHz bands immediately outside and adjacent to the frequency block a resolution bandwidth of at least one percent of the emission bandwidth of the fundamental emission of the transmitter may be employed.

4.5.2 Test Setup

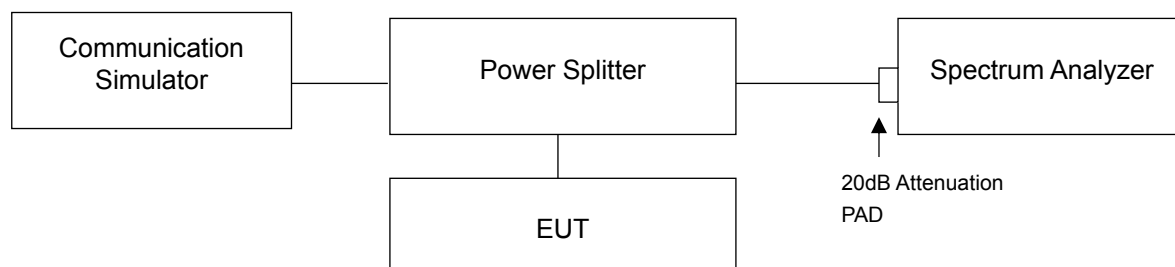

4.5.3 Test Procedures

- All measurements were done at low and high operational frequency range.
- The center frequency of spectrum is the band edge frequency and span is 1.5MHz. RB of the spectrum is 15kHz and VB of the spectrum is 51kHz (LTE Channel Bandwidth 1.4MHz).
- The center frequency of spectrum is the band edge frequency and span is 1.5MHz. RB of the spectrum is 30kHz and VB of the spectrum is 100kHz (LTE Channel Bandwidth 3MHz/1RB)
- The center frequency of spectrum is the band edge frequency and span is 1.5MHz. RB of the spectrum is 51kHz and VB of the spectrum is 150kHz (LTE Channel Bandwidth 3MHz/Full RB, LTE Channel Bandwidth 5MHz).
- The center frequency of spectrum is the band edge frequency and span is 1.5MHz. RB of the spectrum is 100kHz and VB of the spectrum is 300kHz (LTE Channel Bandwidth 10MHz).
- Record the max trace plot into the test report.

4.5.4 Test Results

LTE Band 5, Channel Bandwidth 1.4MHz

Channel 20407 (824.7MHz)	QPSK	1 RB / 0 RB Offset	Channel 20643 (848.3MHz)	QPSK	1 RB / 5 RB Offset
-----------------------------	------	--------------------	-----------------------------	------	--------------------

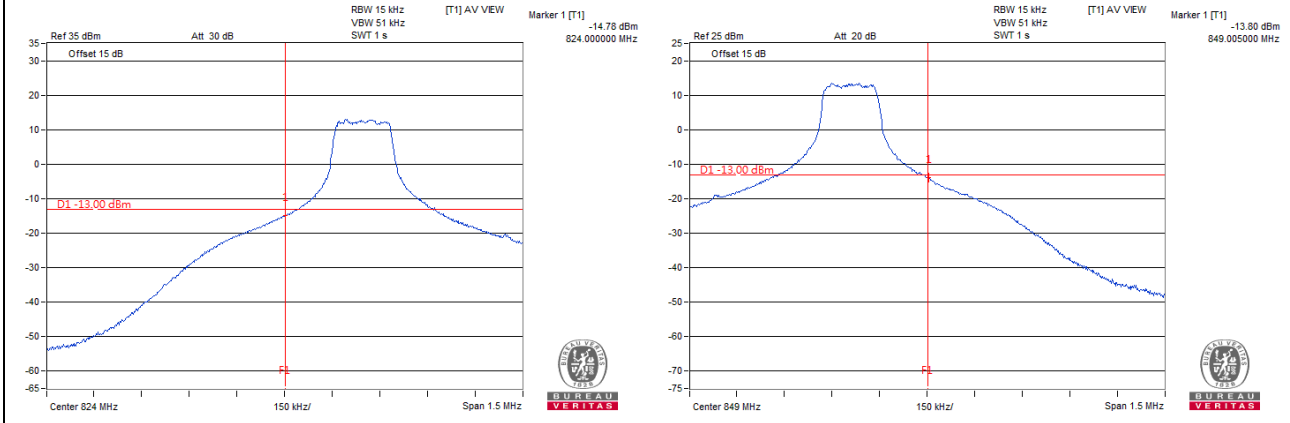

Channel 20407 (824.7MHz)	QPSK	6 RB / 0 RB Offset	Channel 20643 (848.3MHz)	QPSK	6 RB / 0 RB Offset
-----------------------------	------	--------------------	-----------------------------	------	--------------------

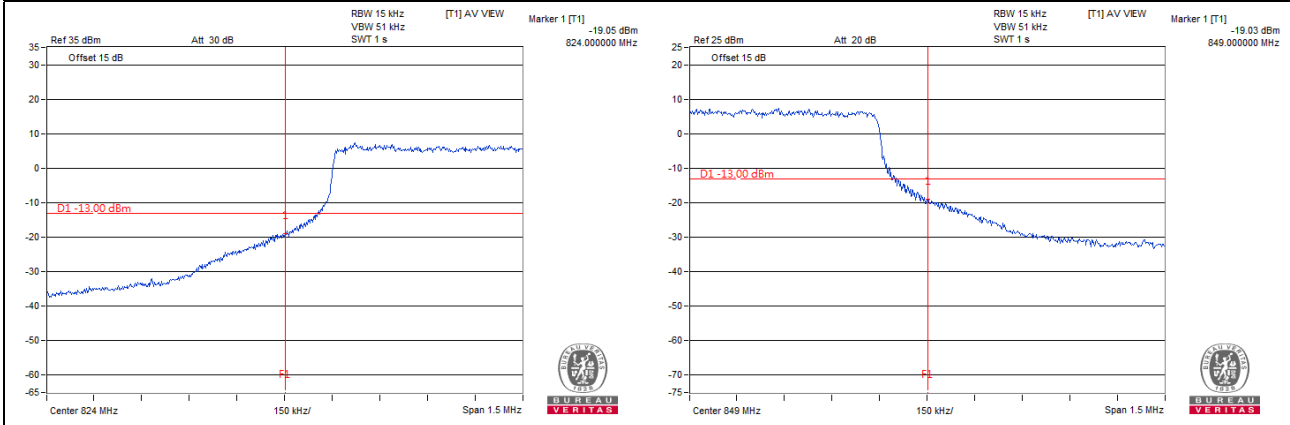

LTE Band 5, Channel Bandwidth 3MHz

Channel 20415 (825.5MHz)	QPSK	1 RB / 0 RB Offset	Channel 20635 (847.5MHz)	QPSK	1 RB / 14 RB Offset
-------------------------------------	-------------	---------------------------	-------------------------------------	-------------	----------------------------

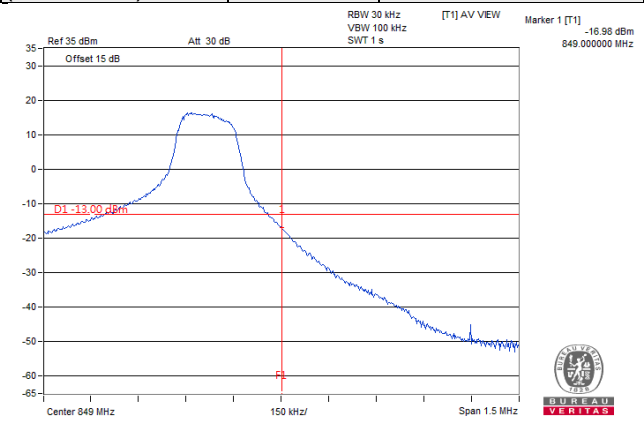
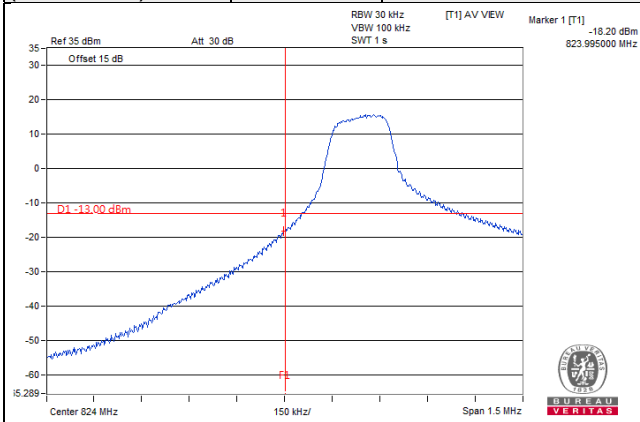

Channel 20415 (825.5MHz)	QPSK	15 RB / 0 RB Offset	Channel 20635 (847.5MHz)	QPSK	15 RB / 0 RB Offset
-------------------------------------	-------------	----------------------------	-------------------------------------	-------------	----------------------------

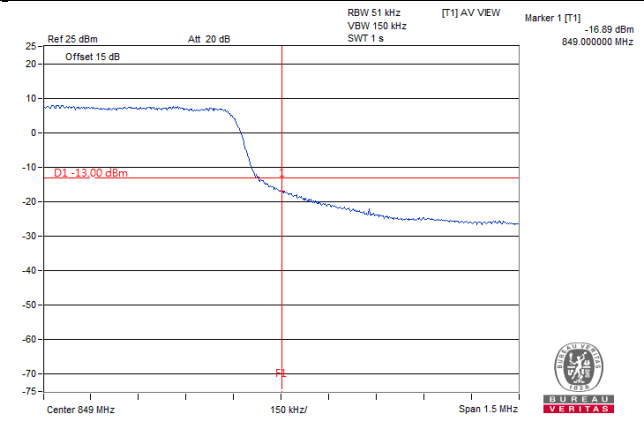
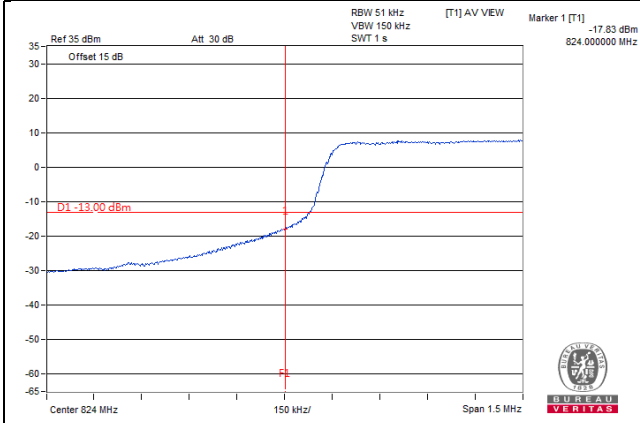

LTE Band 5, Channel Bandwidth 5MHz

Channel 20425 (826.5MHz)	QPSK	1 RB / 0 RB Offset	Channel 20625 (846.5MHz)	QPSK	1 RB / 24 RB Offset
-------------------------------------	-------------	---------------------------	-------------------------------------	-------------	----------------------------

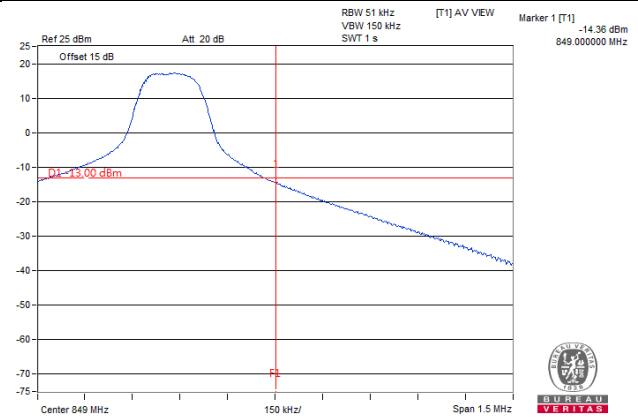
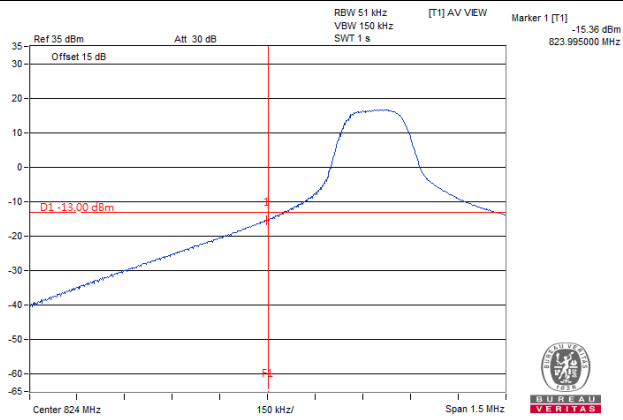

Channel 20425 (826.5MHz)	QPSK	25 RB / 0 RB Offset	Channel 20625 (846.5MHz)	QPSK	25 RB / 0 RB Offset
-------------------------------------	-------------	----------------------------	-------------------------------------	-------------	----------------------------

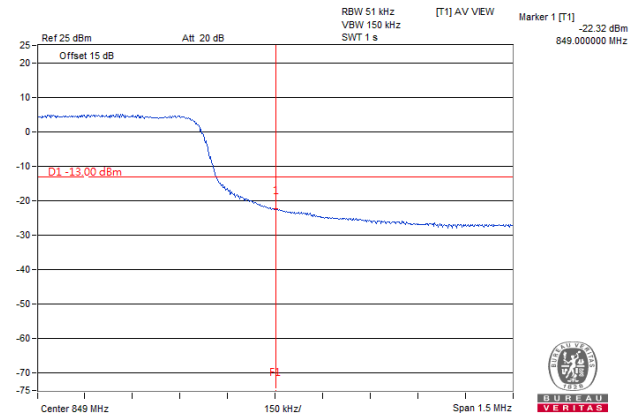
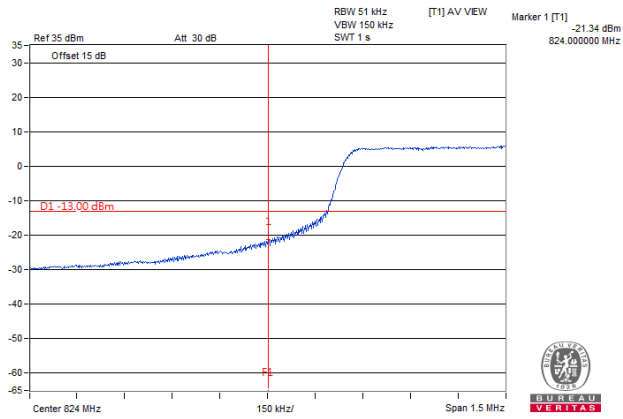

LTE Band 5, Channel Bandwidth 10MHz

Channel 20450 (829.0MHz)	QPSK	1 RB / 0 RB Offset	Channel 20600 (844.0MHz)	QPSK	1 RB / 49 RB Offset
-------------------------------------	-------------	---------------------------	-------------------------------------	-------------	----------------------------

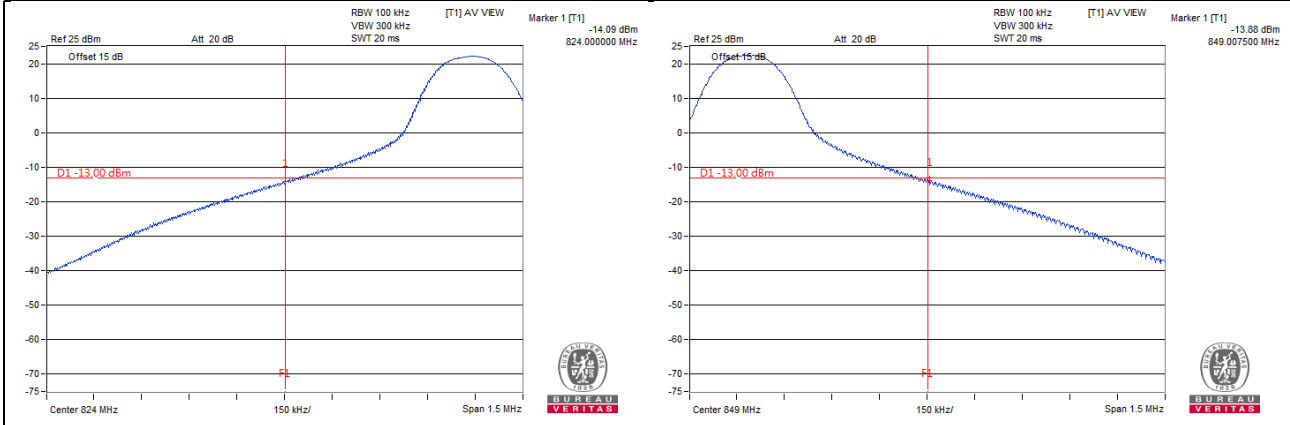

Channel 20450 (829.0MHz)	QPSK	50 RB / 0 RB Offset	Channel 20600 (844.0MHz)	QPSK	50 RB / 0 RB Offset
-------------------------------------	-------------	----------------------------	-------------------------------------	-------------	----------------------------

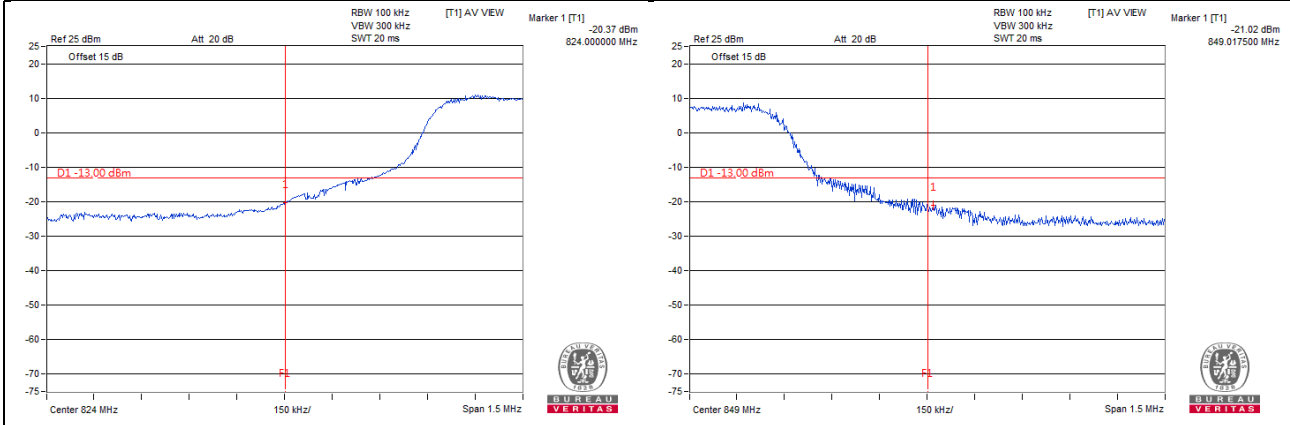

4.6 Peak to Average Ratio

4.6.1 Limits of Peak to Average Ratio Measurement

In measuring transmissions in this band using an average power technique, the peak to-average ratio (PAR) of the transmission may not exceed 13 dB

4.6.2 Test Setup

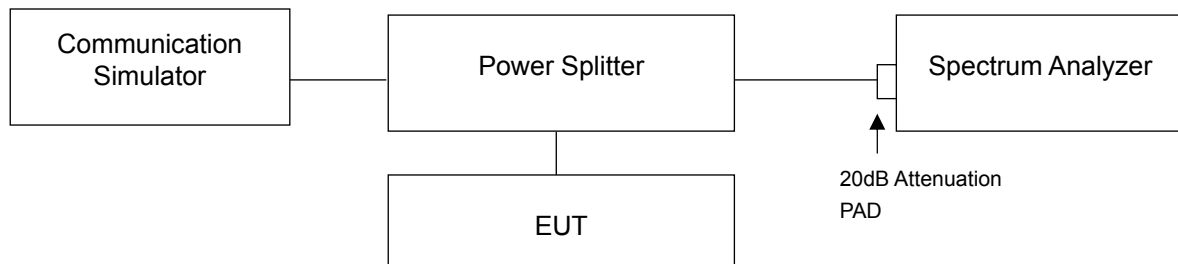

4.6.3 Test Procedures

- Set resolution/measurement bandwidth \geq signal's occupied bandwidth;
- Set the number of counts to a value that stabilizes the measured CCDF curve;
- Record the maximum PAPR level associated with a probability of 0.1%.

4.6.4 Test Results

LTE Band 5, Channel Bandwidth 1.4MHz			
Channel	Frequency (MHz)	Peak To Average Ratio (dB)	
		QPSK	16QAM
20407	824.7	5.34	5.38
20525	836.5	5.61	5.36
20643	848.3	4.97	4.91

LTE Band 5, Channel Bandwidth 3MHz			
Channel	Frequency (MHz)	Peak To Average Ratio (dB)	
		QPSK	16QAM
20415	825.5	5.49	5.48
20525	836.5	5.46	5.42
20635	847.5	5.06	5.06

LTE Band 5, Channel Bandwidth 5MHz			
Channel	Frequency (MHz)	Peak To Average Ratio (dB)	
		QPSK	16QAM
20425	826.5	5.48	5.50
20525	836.5	5.41	5.42
20625	846.5	5.17	5.18

LTE Band 5, Channel Bandwidth 10MHz			
Channel	Frequency (MHz)	Peak To Average Ratio (dB)	
		QPSK	16QAM
20450	829.0	5.53	5.48
20525	836.5	5.58	5.44
20600	844.0	5.27	5.24

Spectrum Plot of Worst Value

1.4MHz / QPSK

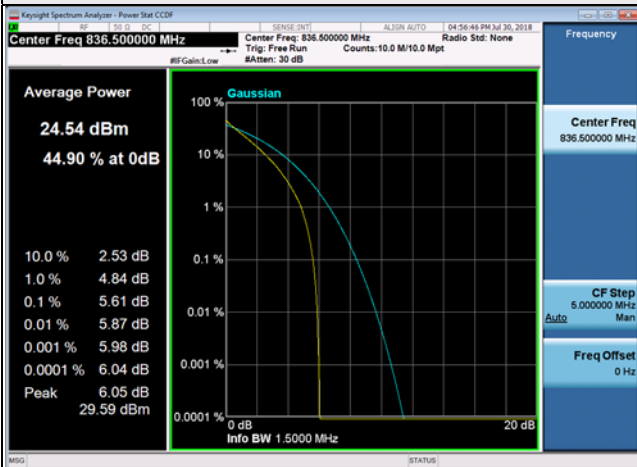

3MHz / QPSK

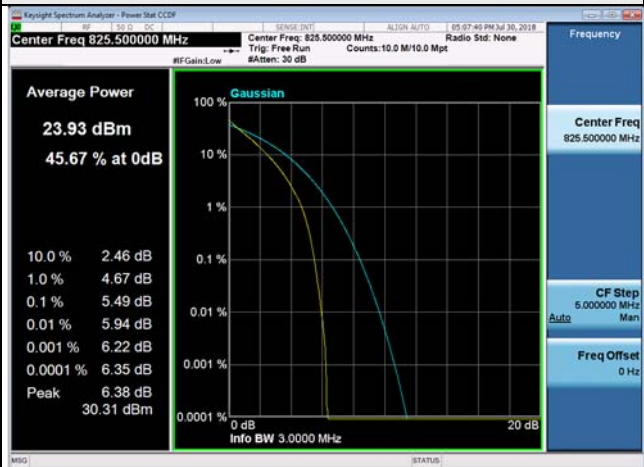

5MHz / 16QAM

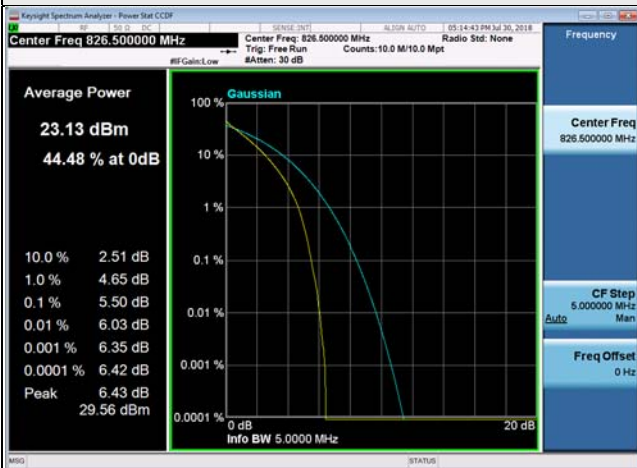

10MHz / QPSK

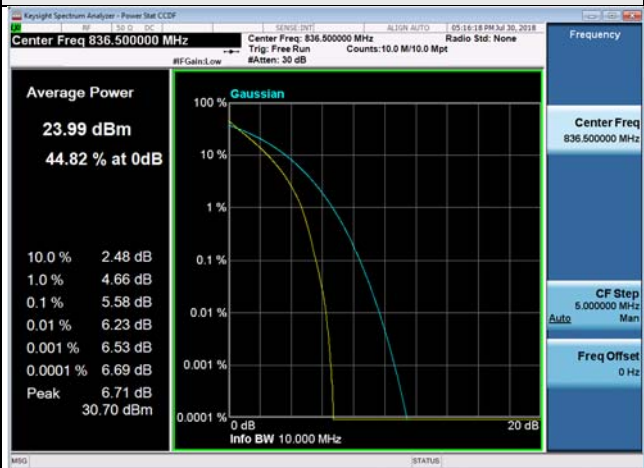

4.7 Conducted Spurious Emissions

4.7.1 Limits of Conducted Spurious Emissions Measurement

The power of any emission outside of the authorized operating frequency ranges must be attenuated below the transmitting power (P) by a factor of at least $43 + 10 \log(P)$ dB. The emission limit equal to -13dBm .

4.7.2 Test Setup

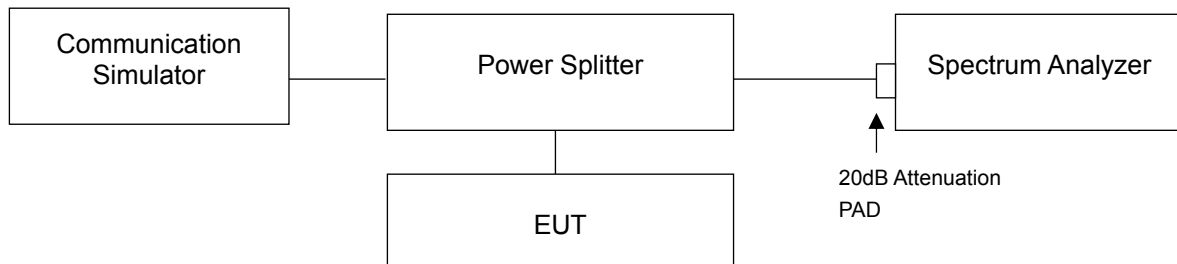

4.7.3 Test Procedure

- The EUT makes a phone call to the communication simulator. All measurements were done at low, middle and high operational frequency range.
- Measuring frequency range is from 9 kHz to 1GHz. 20dB attenuation pad is connected with spectrum. RBW=100kHz and VBW=300kHz is used for conducted emission measurement.
- Measuring frequency range is from 1GHz to 10GHz. 20dB attenuation pad is connected with spectrum. RBW=1MHz and VBW=3MHz is used for conducted emission measurement.

4.7.4 Test Results

LTE Band 5, Channel Bandwidth 1.4MHz

Channel 20407 (824.7MHz)

Frequency Range : 9kHz~1GHz

Frequency Range : 1GHz~10GHz

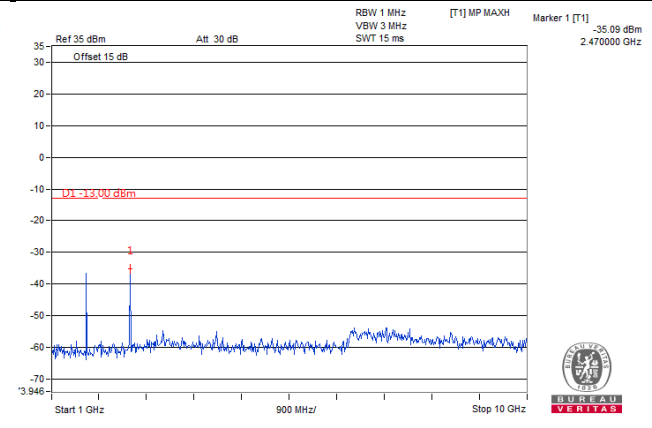
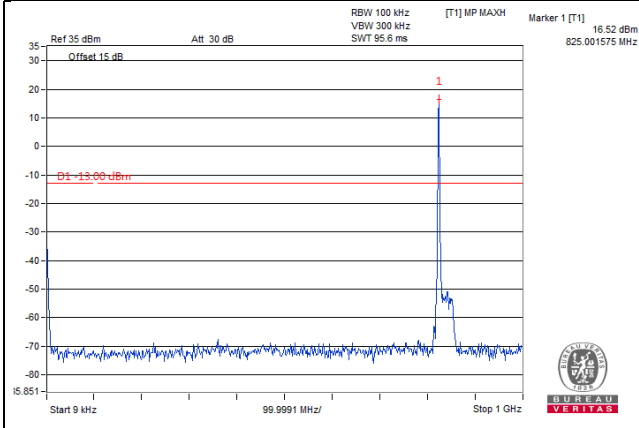

LTE Band 5, Channel Bandwidth 1.4MHz

Channel 20525 (836.5MHz)

Frequency Range : 9kHz~1GHz

Frequency Range : 1GHz~10GHz

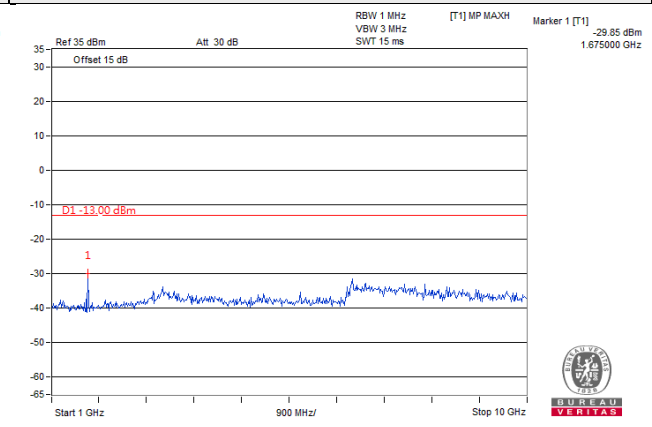
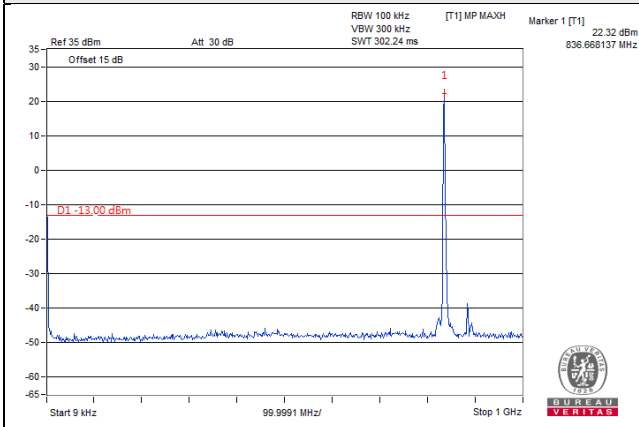

LTE Band 5, Channel Bandwidth 1.4MHz

Channel 20643 (848.3MHz)

Frequency Range : 9kHz~1GHz

Frequency Range : 1GHz~10GHz

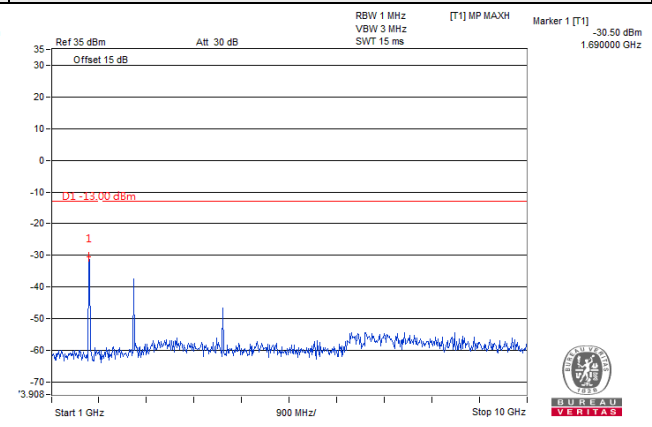
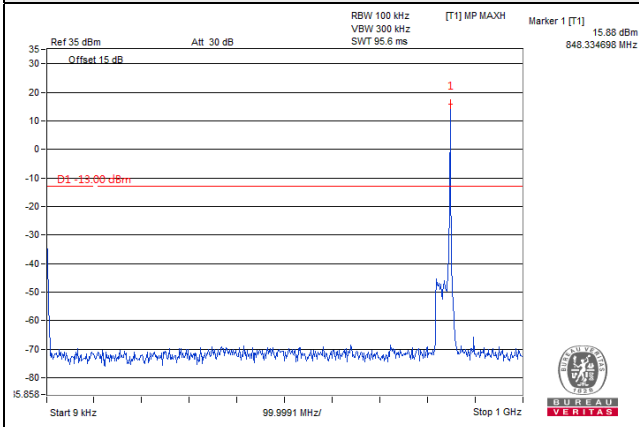

LTE Band 5, Channel Bandwidth 3MHz

Channel 20415 (825.5MHz)

Frequency Range : 9kHz~1GHz

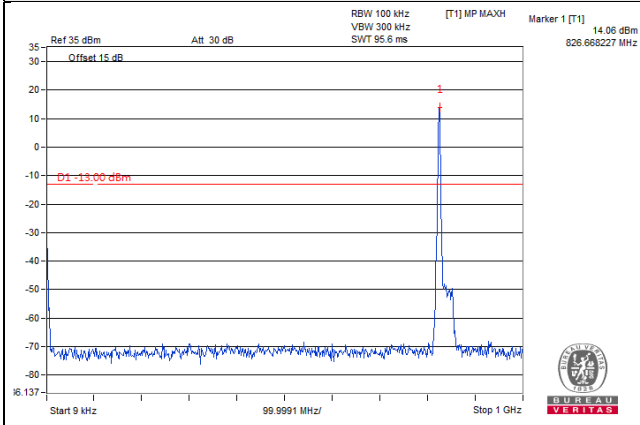

Frequency Range : 1GHz~10GHz

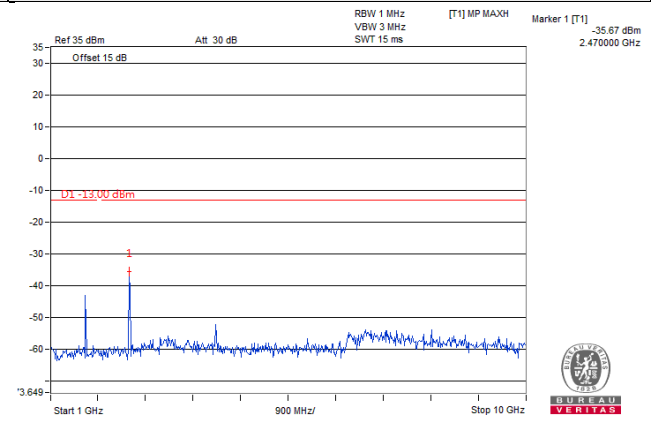

LTE Band 5, Channel Bandwidth 3MHz

Channel 20525 (836.5MHz)

Frequency Range : 9kHz~1GHz

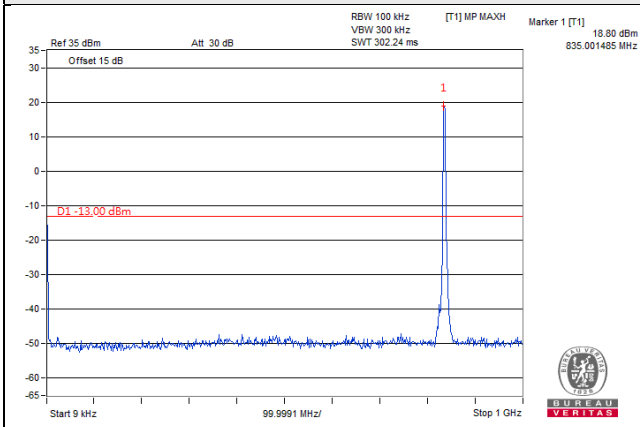

Frequency Range : 1GHz~10GHz

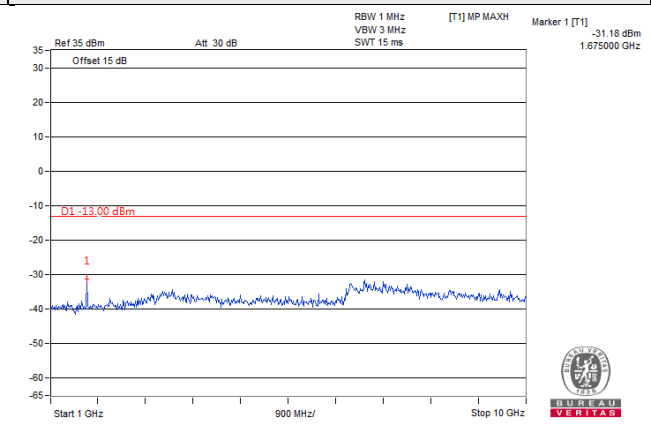

LTE Band 5, Channel Bandwidth 3MHz

Channel 20635 (847.5MHz)

Frequency Range : 9kHz~1GHz

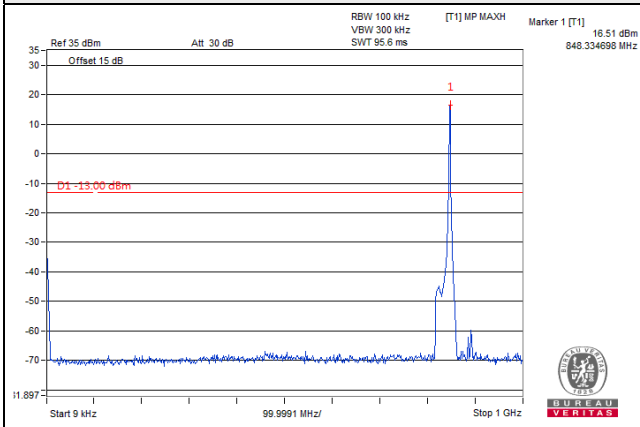

Frequency Range : 1GHz~10GHz

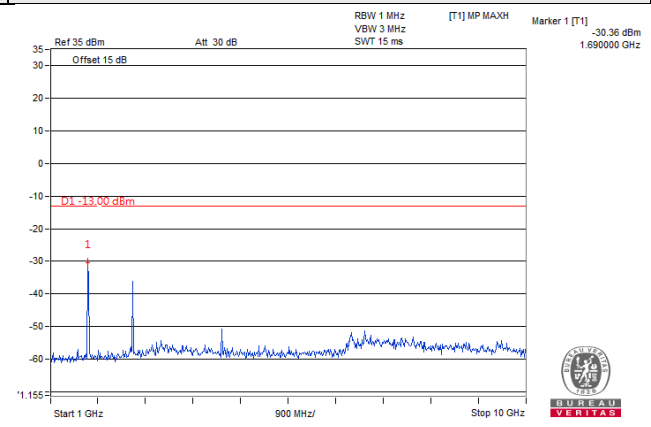

LTE Band 5, Channel Bandwidth 5MHz

Channel 20425 (826.5MHz)

Frequency Range : 9kHz~1GHz

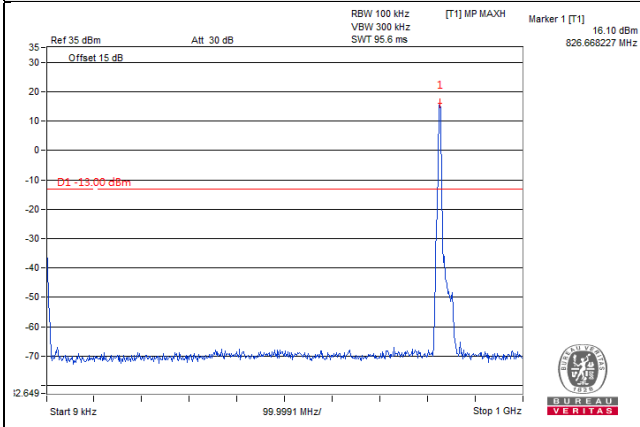

Frequency Range : 1GHz~10GHz

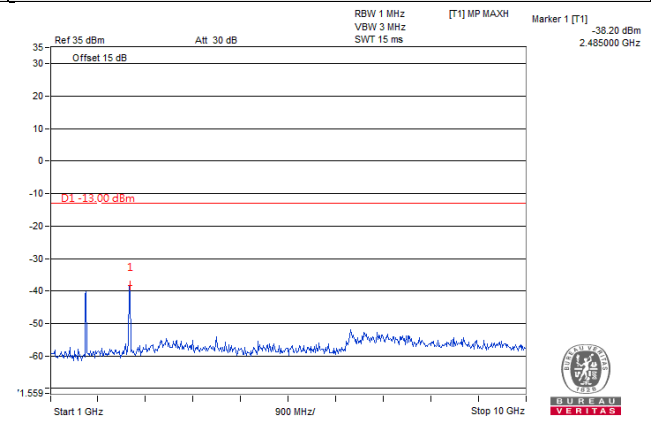

LTE Band 5, Channel Bandwidth 5MHz

Channel 20525 (836.5MHz)

Frequency Range : 9kHz~1GHz

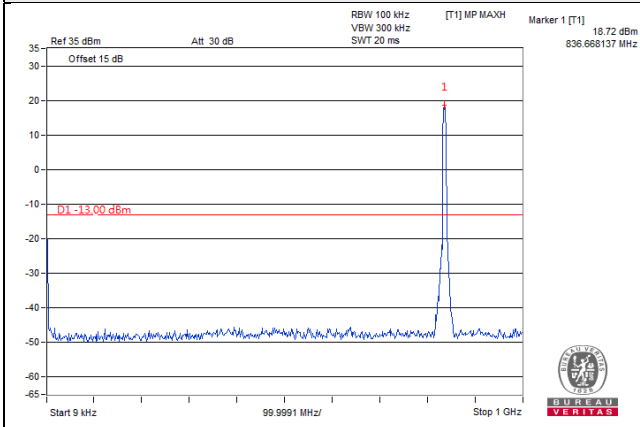

Frequency Range : 1GHz~10GHz

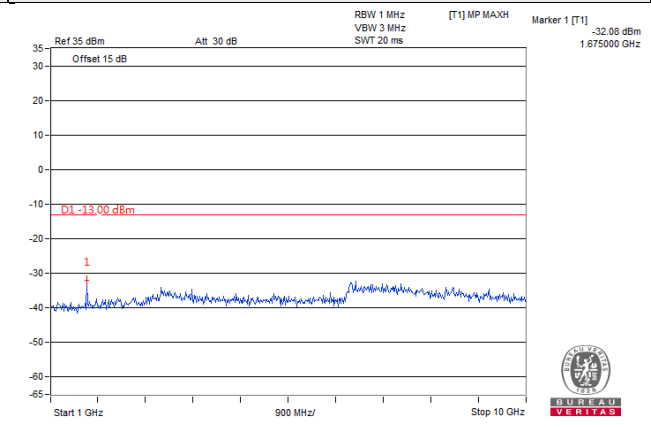

LTE Band 5, Channel Bandwidth 5MHz

Channel 20625 (846.5MHz)

Frequency Range : 9kHz~1GHz

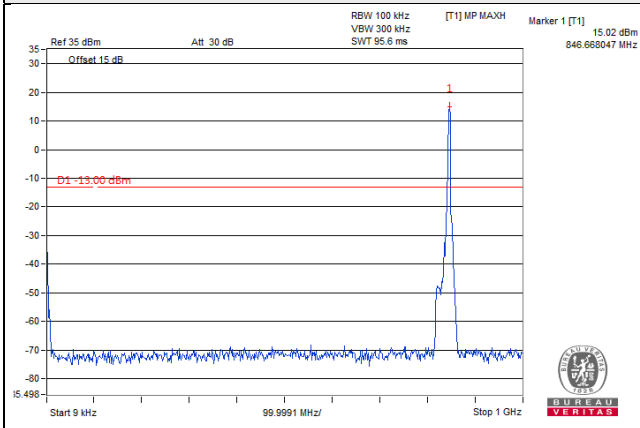

Frequency Range : 1GHz~10GHz

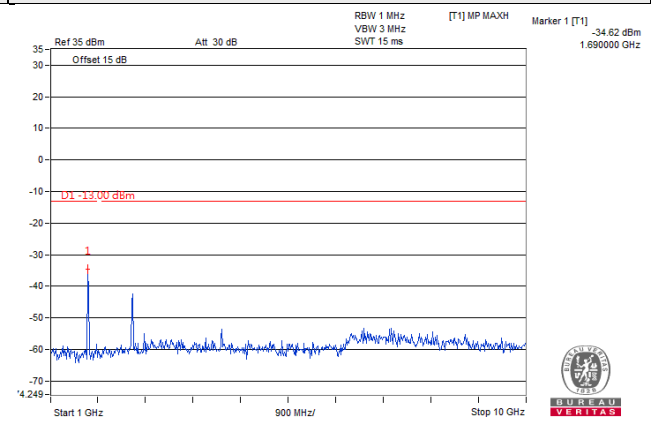

LTE Band 5, Channel Bandwidth 10MHz

Channel 20450 (829.0MHz)

Frequency Range : 9kHz~1GHz

Frequency Range : 1GHz~10GHz

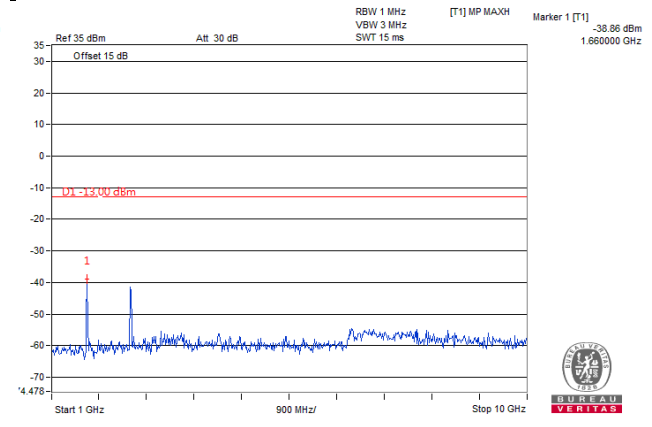
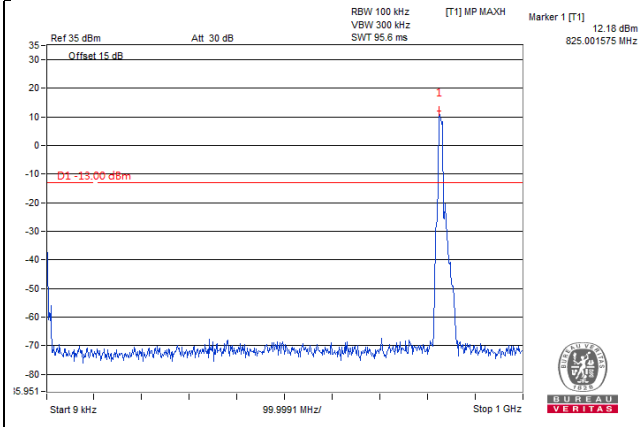

LTE Band 5, Channel Bandwidth 10MHz

Channel 20525 (836.5MHz)

Frequency Range : 9kHz~1GHz

Frequency Range : 1GHz~10GHz

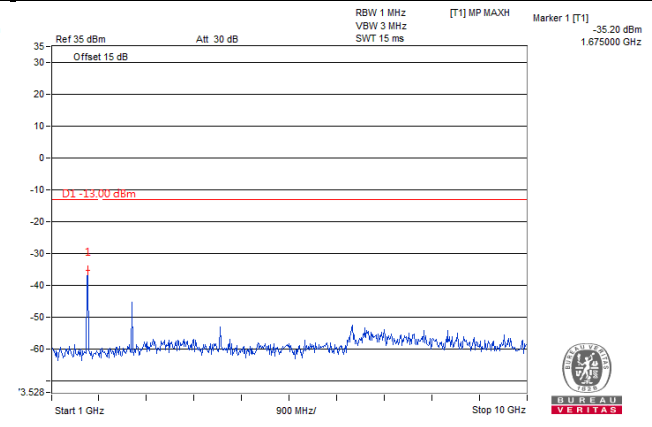
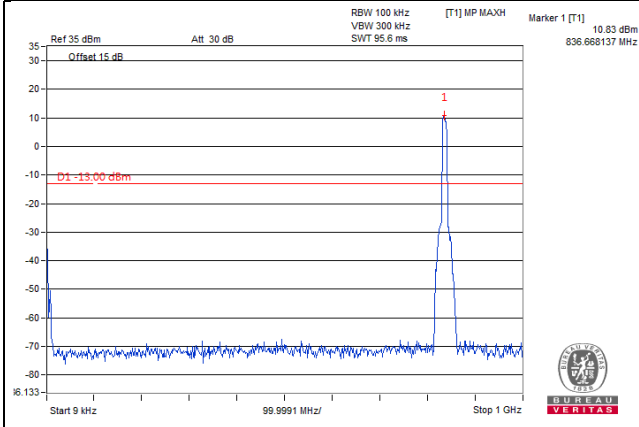

LTE Band 5, Channel Bandwidth 10MHz

Channel 20600 (844.0MHz)

Frequency Range : 9kHz~1GHz

Frequency Range : 1GHz~10GHz

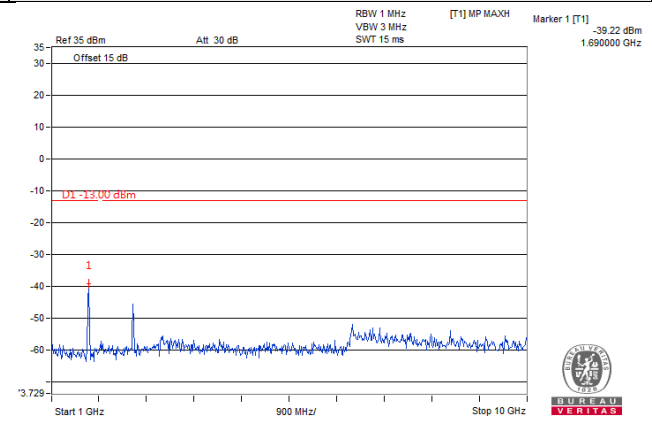
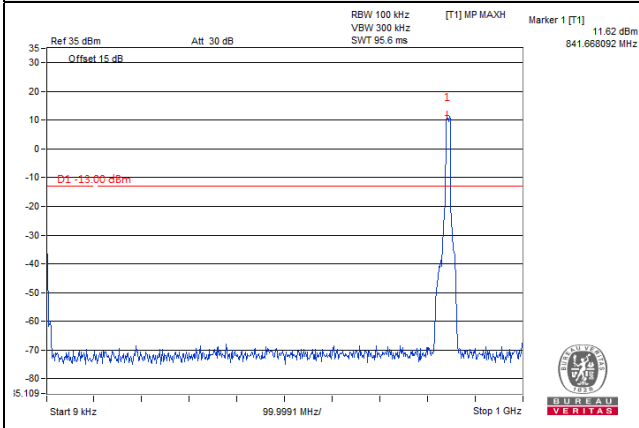

4.8 Radiated Emission Measurement

4.8.1 Limits of Radiated Emission Measurement

The power of any emission outside of the authorized operating frequency ranges must be attenuated below the transmitting power (P) by a factor of at least $43 + 10 \log(P)$ dB. The emission limit equal to -13dBm .

4.8.2 Test Procedure

- a. Substitution method is used for E.I.R.P measurement. In the semi-anechoic chamber, EUT placed on the 0.8 m (below or equal 1 GHz) and/or 1.5 m (above 1 GHz) height of Turn Table, rotated the table around 360 degrees to search the maximum radiation power and receiver antenna shall be rotated vertical and horizontal polarization and moved height from 1 m to 4 m to find the maximum polar radiated power. The "Read Value" is the spectrum reading the maximum power value.
- b. The substitution horn antenna is substituted for EUT at the same position and signals generator export the CW signal to the substitution antenna via a TX cable. Rotated the Turn Table and moved receiving antenna to find the maximum radiation power. Adjust output power level of S.G to get a Value of spectrum reading equal to "Read Value " of step a. Record the power level of S.G
- c. $\text{EIRP} = \text{Output power level of S.G} - \text{TX cable loss} + \text{Antenna gain of substitution horn}$.
- d. E.R.P power can be calculated form E.I.R.P power by subtracting the gain of dipole, $\text{E.R.P power} = \text{E.I.R.P power} - 2.15\text{dBi}$.

NOTE: The resolution bandwidth and video bandwidth of test receiver/spectrum analyzer is 1MHz/3MHz.

4.8.3 Deviation from Test Standard

No deviation.

4.8.4 Test Setup

<Radiated Emission below or equal 1 GHz>

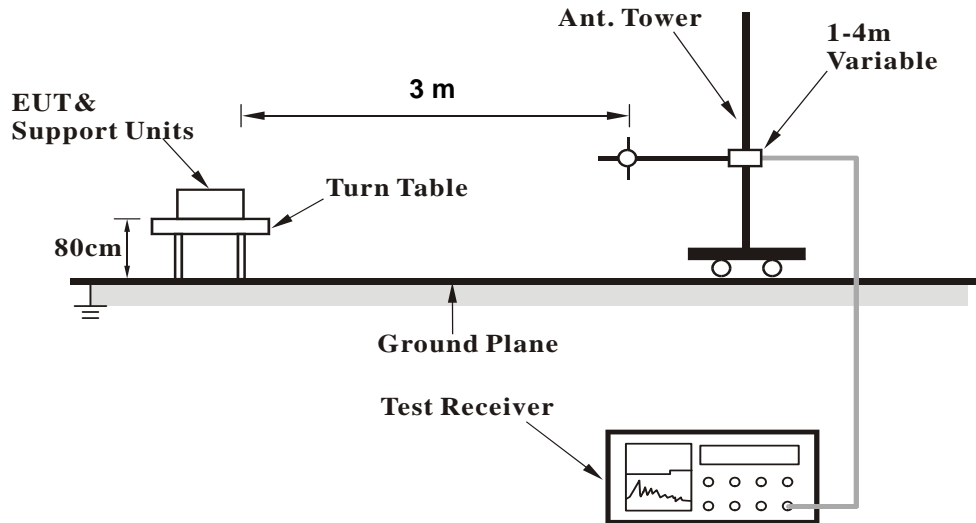

<Radiated Emission above 1 GHz>

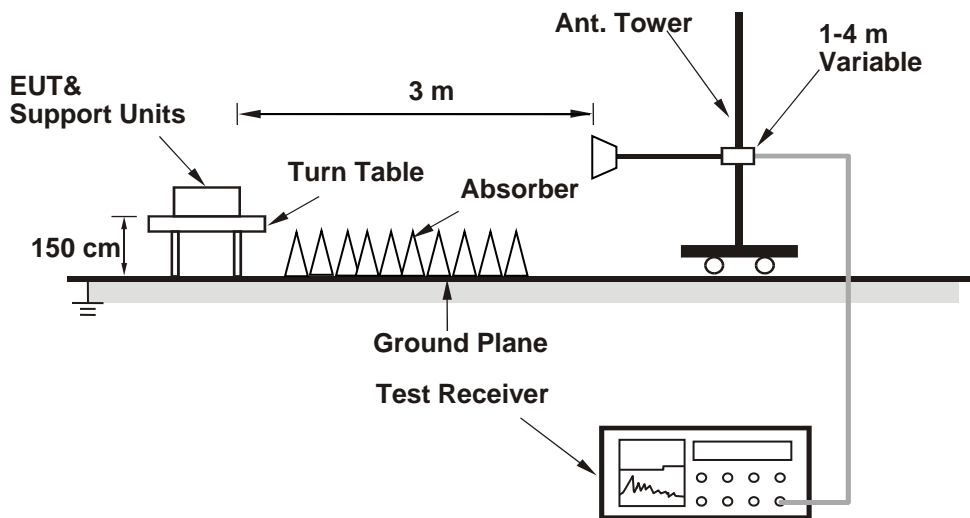

For the actual test configuration, please refer to the attached file (Test Setup Photo).

4.8.5 Test Results

Mode	LTE Band 5 Channel Bandwidth: 1.4MHz	Channel	TX channel 20407 (824.7MHz)
------	--	---------	--------------------------------



Bureau Veritas Consumer Products Services Ltd., Taoyuan Branch

A D T

Data: 3

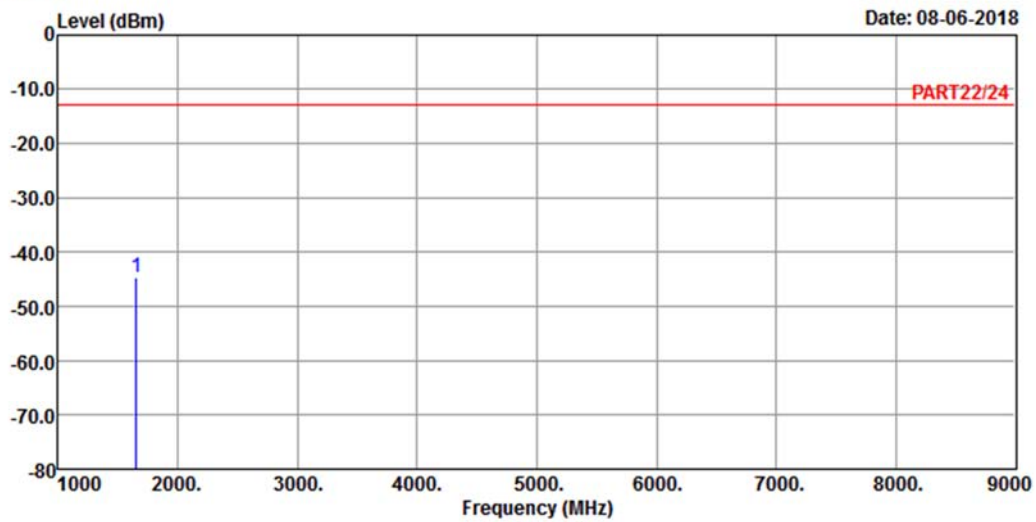

Site : 966 Chamber 5
 Condition: PART22/24 HORIZONTAL
 Remak : LTE Band 5 QPSK_1.4M Link_L-CH
 Tested by: Jisyong Wang

Read	Limit	Over				
Freq	Level	Level	Line	Limit	Factor	Remark
MHz	dBm	dBm	dBm	dB	dB	

1 pp 1649.40 -44.52 -30.78 -13.00 -31.52 -13.74 Peak

Mode	LTE Band 5 Channel Bandwidth: 1.4MHz	Channel	TX channel 20407 (824.7MHz)
------	--	---------	--------------------------------



Bureau Veritas Consumer Products Services Ltd., Taoyuan Branch

A D T

Data: 4

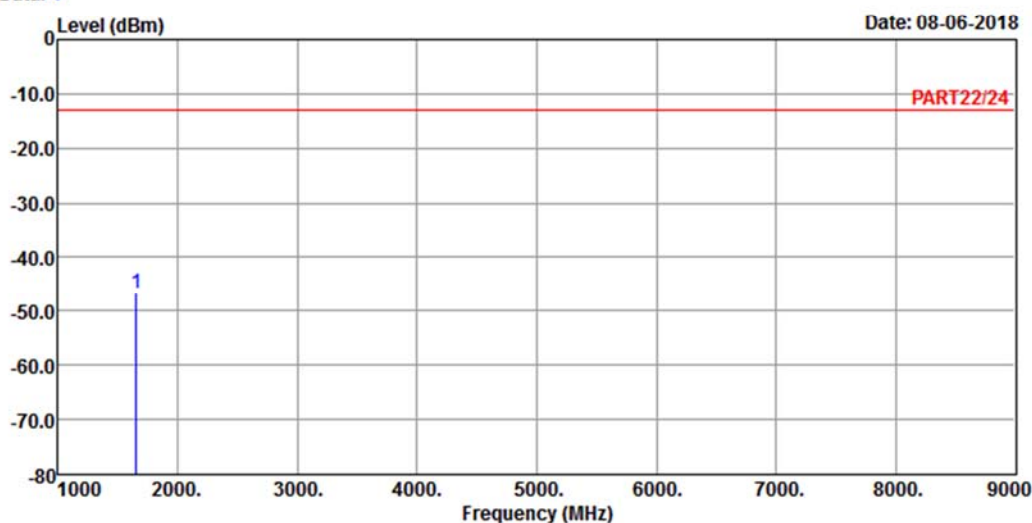

Site : 966 Chamber 5
 Condition: PART22/24 VERTICAL
 Remak : LTE Band 5 QPSK_1.4M Link_L-CH
 Tested by: Jisyong Wang

Read	Limit	Over				
Freq	Level	Level	Line	Limit	Factor	Remark
MHz	dBm	dBm	dBm	dB	dB	

1 pp 1649.40 -46.52 -32.78 -13.00 -33.52 -13.74 Peak

Mode	LTE Band 5 Channel Bandwidth: 1.4MHz	Channel	TX channel 20525 (836.5MHz)
------	--	---------	--------------------------------



Bureau Veritas Consumer Products Services Ltd., Taoyuan Branch

A D T

Data: 3

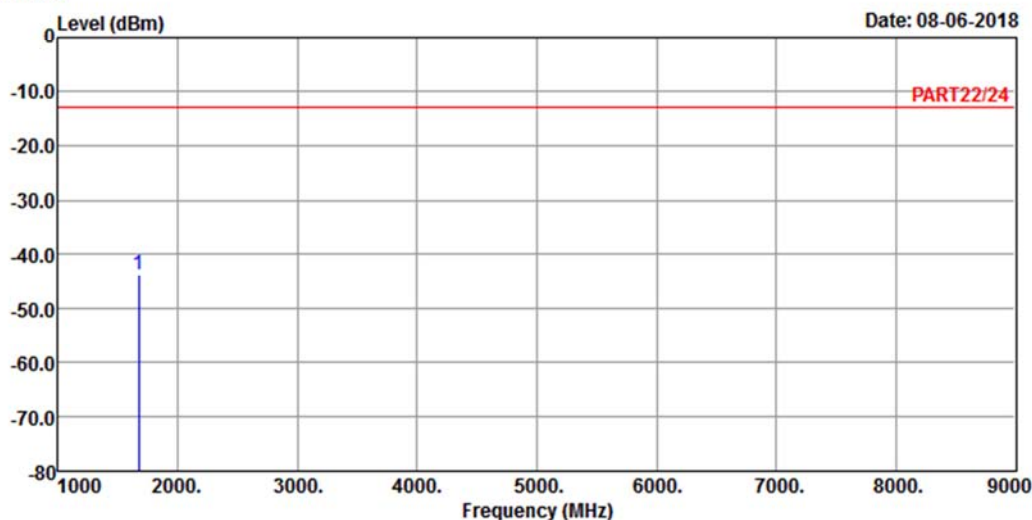

Site : 966 Chamber 5
 Condition: PART22/24 HORIZONTAL
 Remak : LTE Band 5 QPSK_1.4M Link_M-CH
 Tested by: Jisyong Wang

Read	Limit	Over				
Freq	Level	Level	Line	Limit	Factor	Remark
MHz	dBm	dBm	dBm	dB	dB	

1 pp 1673.00 -43.59 -29.69 -13.00 -30.59 -13.90 Peak

Mode	LTE Band 5 Channel Bandwidth: 1.4MHz	Channel	TX channel 20525 (836.5MHz)
------	--	---------	--------------------------------



Bureau Veritas Consumer Products Services Ltd., Taoyuan Branch

A D T

Data: 4

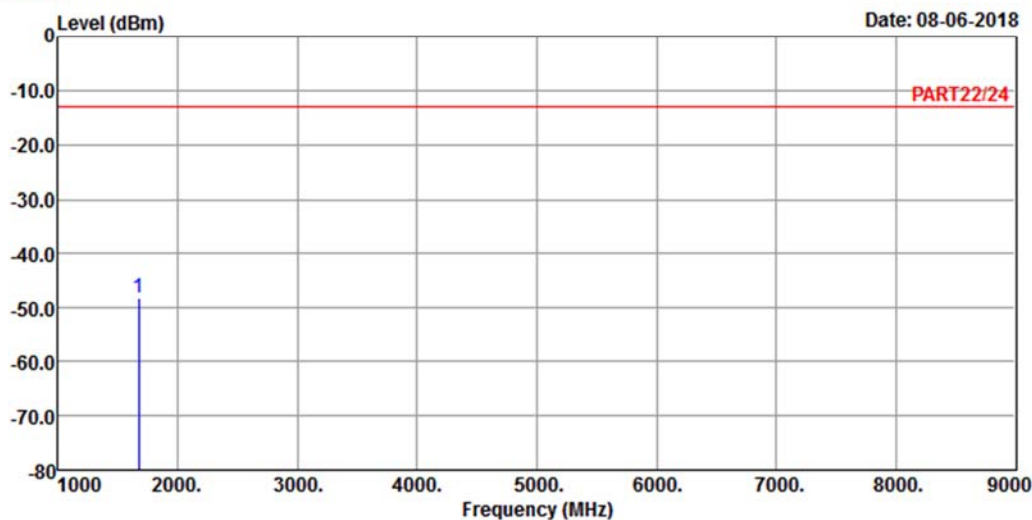

Site : 966 Chamber 5
 Condition: PART22/24 VERTICAL
 Remak : LTE Band 5 QPSK_1.4M Link_M-CH
 Tested by: Jisyong Wang

Freq	Level	Read Level	Limit Line	Over Limit	Factor	Remark
MHz	dBm	dBm	dBm	dB	dB	

1 pp 1673.00 -48.00 -34.10 -13.00 -35.00 -13.90 Peak

Mode	LTE Band 5 Channel Bandwidth: 1.4MHz	Channel	TX channel 20643 (848.3MHz)
------	--	---------	--------------------------------



Bureau Veritas Consumer Products Services Ltd., Taoyuan Branch

A D T

Data: 3

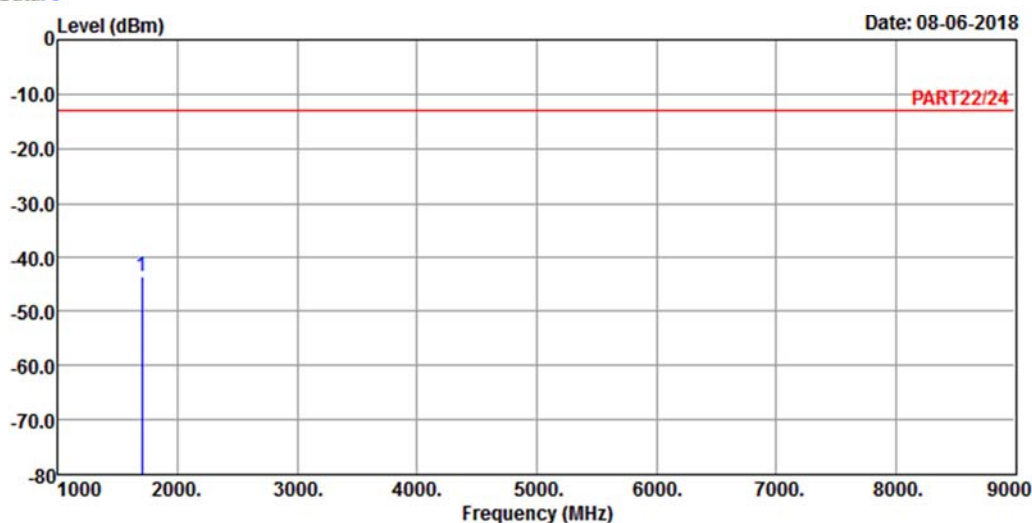

Site : 966 Chamber 5
 Condition: PART22/24 HORIZONTAL
 Remak : LTE Band 5 QPSK_1.4M Link_H-CH
 Tested by: Jisyong Wang

Read	Limit	Over				
Freq	Level	Level	Line	Limit	Factor	Remark
MHz	dBm	dBm	dBm	dB	dB	

1 pp 1696.60 -43.52 -29.50 -13.00 -30.52 -14.02 Peak

Mode	LTE Band 5 Channel Bandwidth: 1.4MHz	Channel	TX channel 20643 (848.3MHz)
------	--	---------	--------------------------------



Bureau Veritas Consumer Products Services Ltd., Taoyuan Branch

A D T

Data: 4

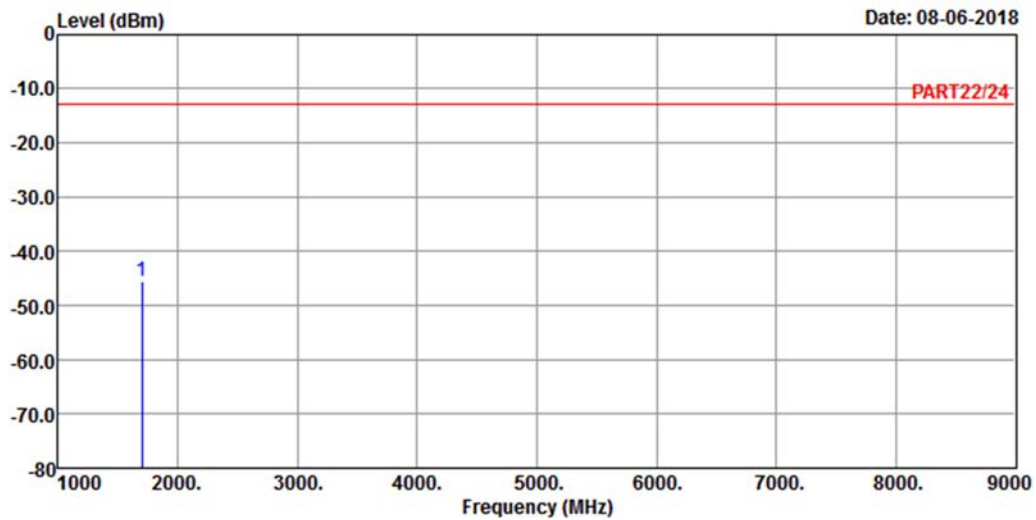

Site : 966 Chamber 5
 Condition: PART22/24 VERTICAL
 Remak : LTE Band 5 QPSK_1.4M Link_H-CH
 Tested by: Jisyong Wang

Read	Limit	Over				
Freq	Level	Level	Line	Limit	Factor	Remark
MHz	dBm	dBm	dBm	dB	dB	

1 pp 1696.60 -45.58 -31.56 -13.00 -32.58 -14.02 Peak

Mode	LTE Band 5 Channel Bandwidth: 3MHz	Channel	TX channel 20415(825.5MHz)
------	--	---------	-------------------------------



Bureau Veritas Consumer Products Services Ltd., Taoyuan Branch

A D T

Data: 3

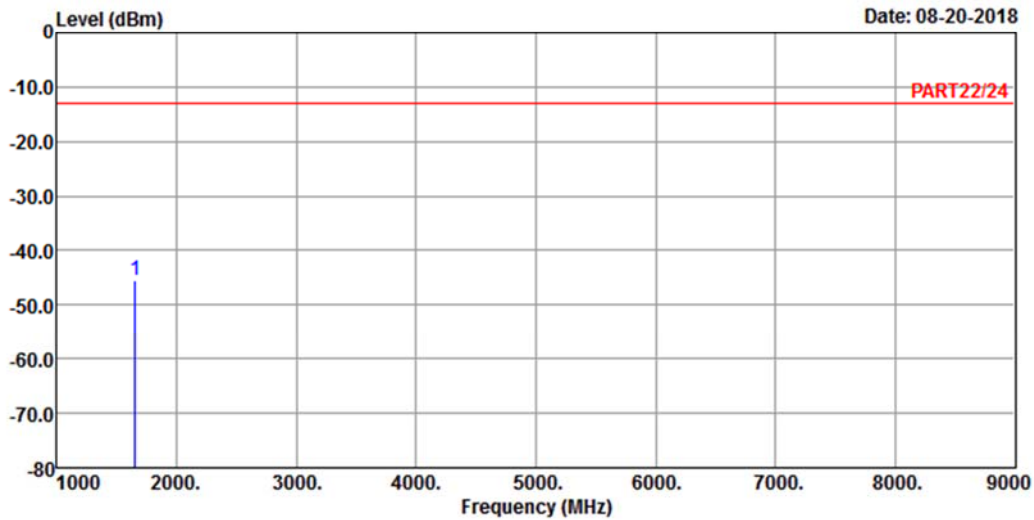

Site : 966 Chamber 5
 Condition: PART22/24 HORIZONTAL
 Remak : LTE Band 5 QPSK_3M Link_L-CH
 Tested by: Jisyong Wang

Freq	Level	Read Level	Limit Line	Over Limit	Factor	Remark
MHz	dBm	dBm	dBm	dB	dB	

1 pp 1651.00 -45.52 -31.78 -13.00 -32.52 -13.74 Peak

Mode	LTE Band 5 Channel Bandwidth: 3MHz	Channel	TX channel 20415(825.5MHz)
------	--	---------	-------------------------------



Bureau Veritas Consumer Products Services Ltd., Taoyuan Branch

A D T

Data: 4

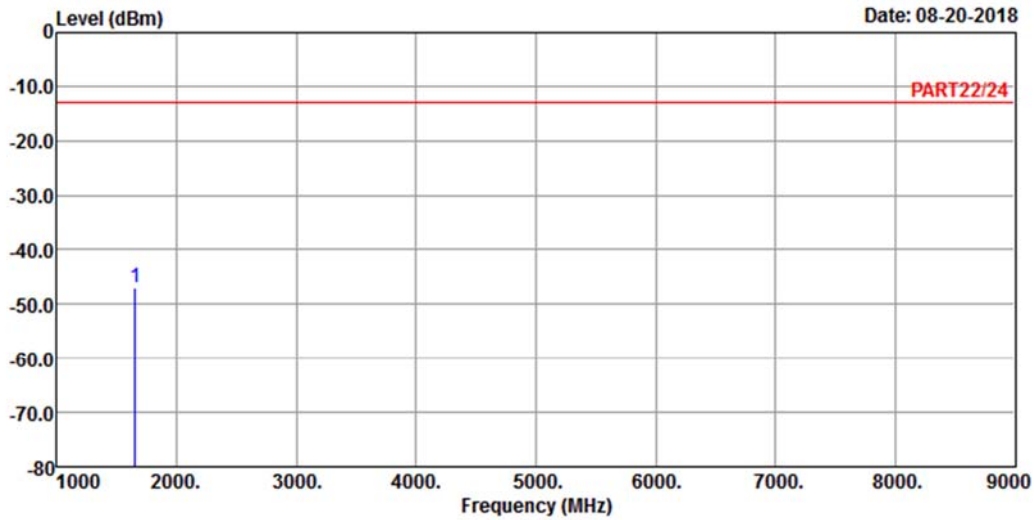

Site : 966 Chamber 5
 Condition: PART22/24 VERTICAL
 Remak : LTE Band 5 QPSK_3M Link_L-CH
 Tested by: Jisyong Wang

Freq	Level	Read Level	Limit Line	Over Limit	Factor	Remark
MHz	dBm	dBm	dBm	dB	dB	

1 pp 1651.00 -46.85 -33.11 -13.00 -33.85 -13.74 Peak

Mode	LTE Band 5 Channel Bandwidth: 3MHz	Channel	TX channel 20525(836.5MHz)
------	--	---------	-------------------------------



Bureau Veritas Consumer Products Services Ltd., Taoyuan Branch

A D T

Data: 3

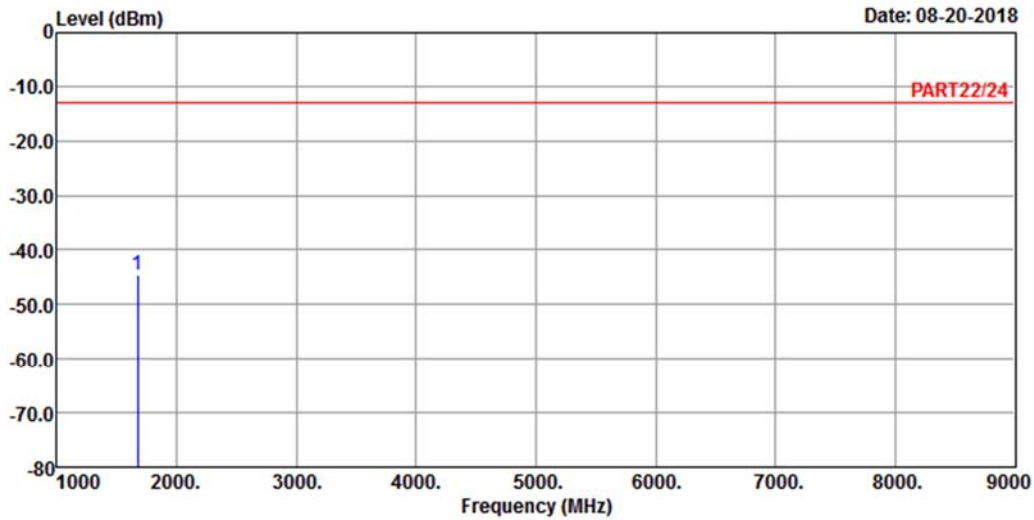

Site : 966 Chamber 5
 Condition: PART22/24 HORIZONTAL
 Remak : LTE Band 5 QPSK_3M Link_M-CH
 Tested by: Jisyong Wang

Freq	Level	Read Level	Limit Line	Over Limit	Factor	Remark
MHz	dBm	dBm	dBm	dB	dB	

1 pp 1673.00 -44.52 -30.62 -13.00 -31.52 -13.90 Peak

Mode	LTE Band 5 Channel Bandwidth: 3MHz	Channel	TX channel 20525(836.5MHz)
------	--	---------	-------------------------------



Bureau Veritas Consumer Products Services Ltd., Taoyuan Branch

A D T

Data: 4

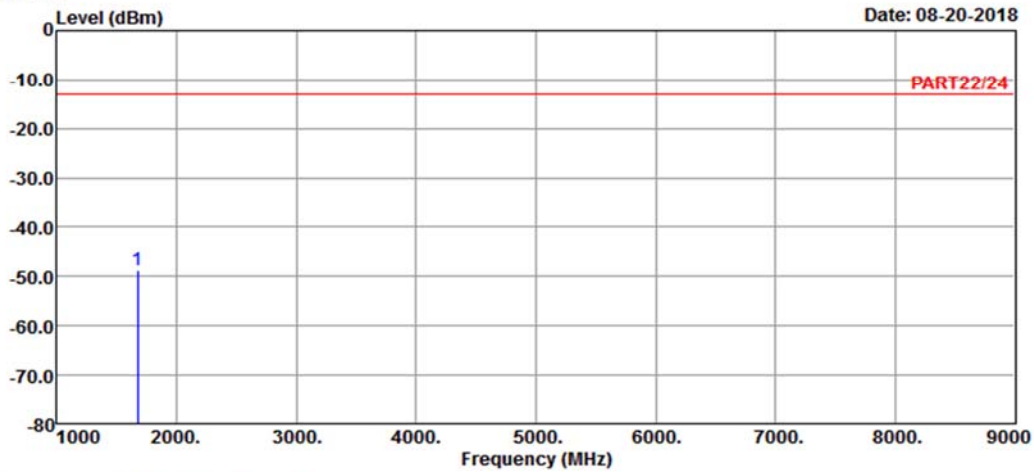

Site : 966 Chamber 5
 Condition: PART22/24 VERTICAL
 Remak : LTE Band 5 QPSK_3M Link_M-CH
 Tested by: Jisyong Wang

Freq	Level	Read Limit Over			Factor	Remark
		Level	Line	Limit		
MHz	dBm	dBm	dBm	dB	dB	
1 pp 1673.00	-48.65	-34.75	-13.00	-35.65	-13.90	Peak

Mode	LTE Band 5 Channel Bandwidth: 3MHz	Channel	TX channel 20635(847.5MHz)
------	--	---------	-------------------------------



Bureau Veritas Consumer Products Services Ltd., Taoyuan Branch

A D T

Data: 3

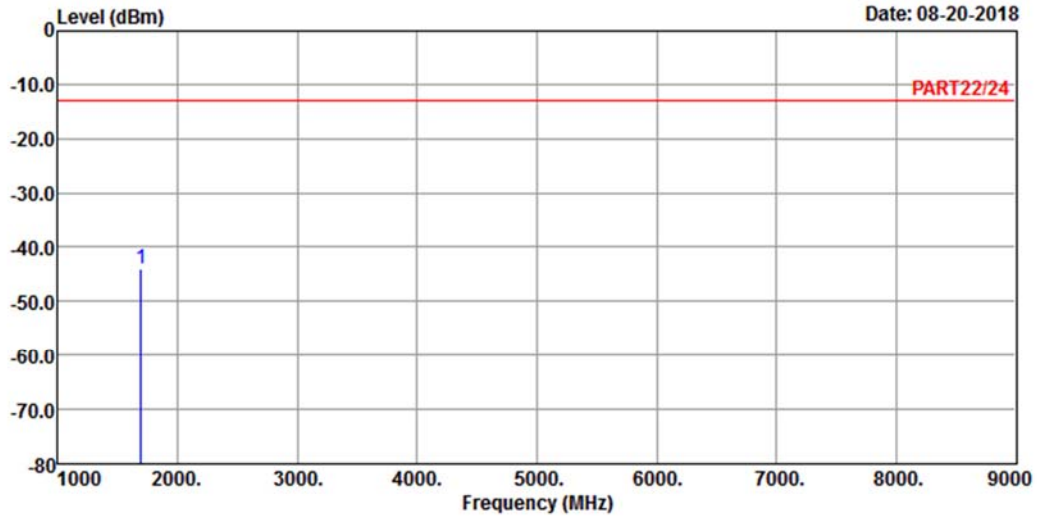

Site : 966 Chamber 5
 Condition: PART22/24 HORIZONTAL
 Remak : LTE Band 5 QPSK_3M Link_H-CH
 Tested by: Jisyong Wang

Freq	Level	Read Level	Limit Line	Over Limit	Factor	Remark
MHz	dBm	dBm	dBm	dB	dB	
1 pp 1695.00	-43.96	-29.94	-13.00	-30.96	-14.02	Peak

Mode	LTE Band 5 Channel Bandwidth: 3MHz	Channel	TX channel 20635(847.5MHz)
------	--	---------	-------------------------------



Bureau Veritas Consumer Products Services Ltd., Taoyuan Branch

A D T

Data: 4

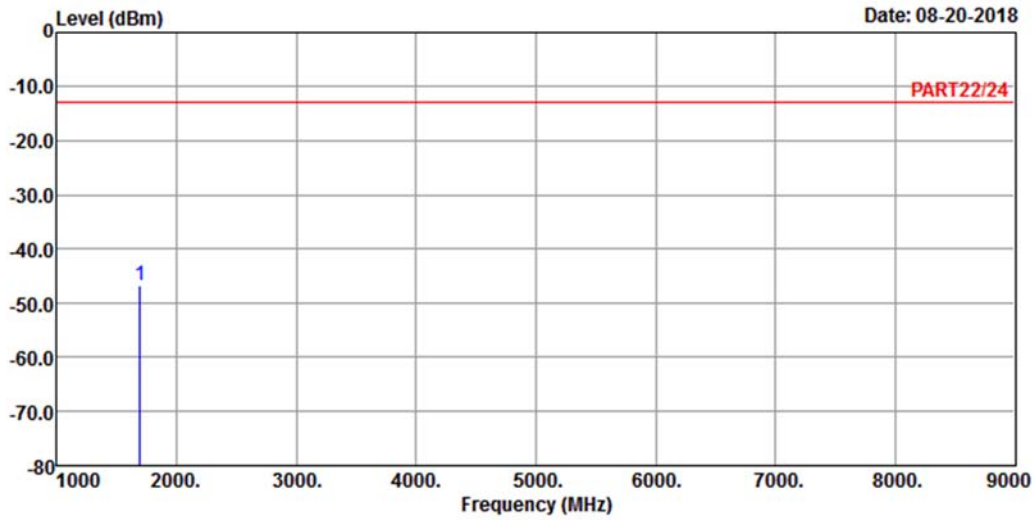

Site : 966 Chamber 5
 Condition: PART22/24 VERTICAL
 Remak : LTE Band 5 QPSK_3M Link_H-CH
 Tested by: Jisyong Wang

Freq	Level	Read Level	Limit	Over	Factor	Remark
MHz	dBm	dBm	dBm	dB	dB	

1 pp 1695.00 -46.52 -32.50 -13.00 -33.52 -14.02 Peak

Mode	LTE Band 5 Channel Bandwidth: 5MHz	Channel	TX channel 20425 (826.5MHz)
------	--	---------	--------------------------------



Bureau Veritas Consumer Products Services Ltd., Taoyuan Branch

A D T

Data: 3

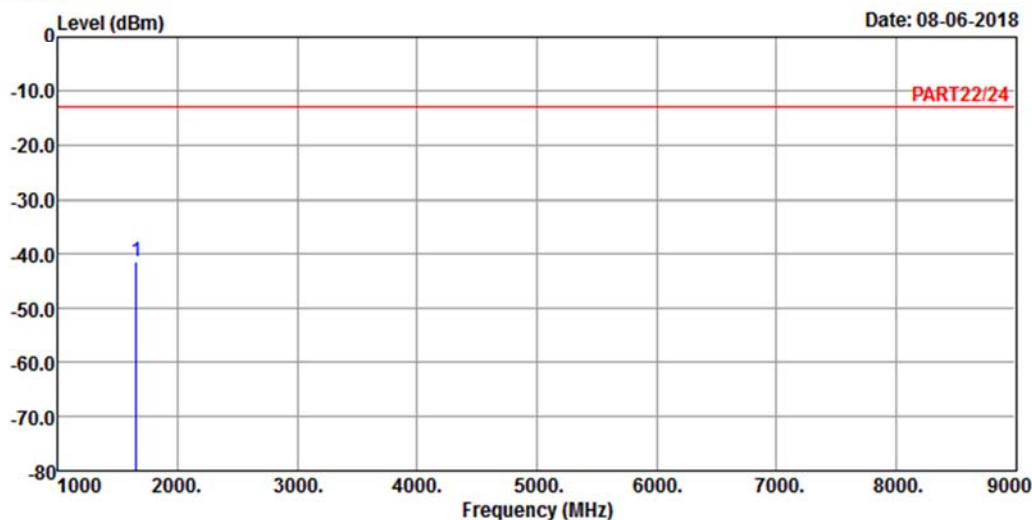

Site : 966 Chamber 5
 Condition: PART22/24 HORIZONTAL
 Remak : LTE Band 5 QPSK_5M Link_L-CH
 Tested by: Jisyong Wang

Freq	Level	Read Level	Limit Line	Over Limit	Factor	Remark
MHz	dBm	dBm	dBm	dB	dB	

1 pp 1653.00 -41.26 -27.49 -13.00 -28.26 -13.77 Peak

Mode	LTE Band 5 Channel Bandwidth: 5MHz	Channel	TX channel 20425 (826.5MHz)
------	--	---------	--------------------------------



Bureau Veritas Consumer Products Services Ltd., Taoyuan Branch

A D T

Data: 4

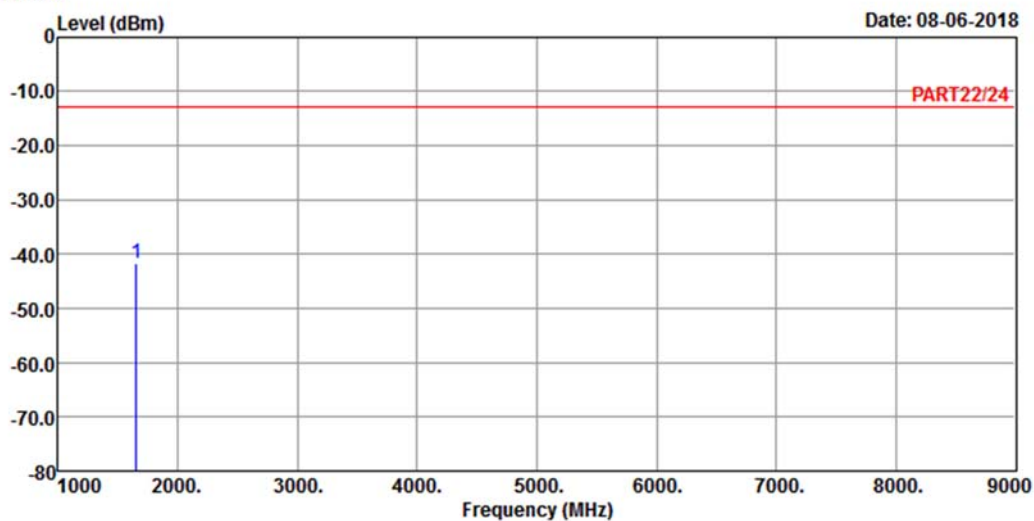

Site : 966 Chamber 5
 Condition: PART22/24 VERTICAL
 Remak : LTE Band 5 QPSK_5M Link_L-CH
 Tested by: Jisyong Wang

Freq	Level	Read Level	Limit Line	Over Limit	Factor	Remark
MHz	dBm	dBm	dBm	dB	dB	

1 pp 1653.00 -41.52 -27.75 -13.00 -28.52 -13.77 Peak

Mode	LTE Band 5 Channel Bandwidth: 5MHz	Channel	TX channel 20525 (836.5MHz)
------	--	---------	--------------------------------



Bureau Veritas Consumer Products Services Ltd., Taoyuan Branch

A D T

Data: 3

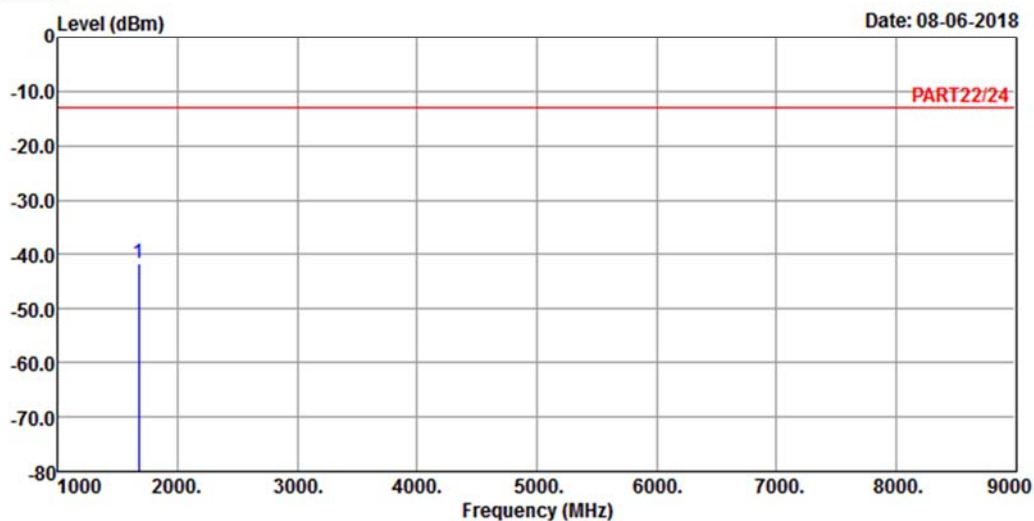

Site : 966 Chamber 5
 Condition: PART22/24 HORIZONTAL
 Remak : LTE Band 5 QPSK_5M Link_M-CH
 Tested by: Jisyong Wang

Freq	Level	Read Level	Limit Line	Over Limit	Factor	Remark
MHz	dBm	dBm	dBm	dB	dB	

1 pp 1673.00 -41.52 -27.62 -13.00 -28.52 -13.90 Peak

Mode	LTE Band 5 Channel Bandwidth: 5MHz	Channel	TX channel 20525 (836.5MHz)
------	--	---------	--------------------------------



Bureau Veritas Consumer Products Services Ltd., Taoyuan Branch

A D T

Data: 4

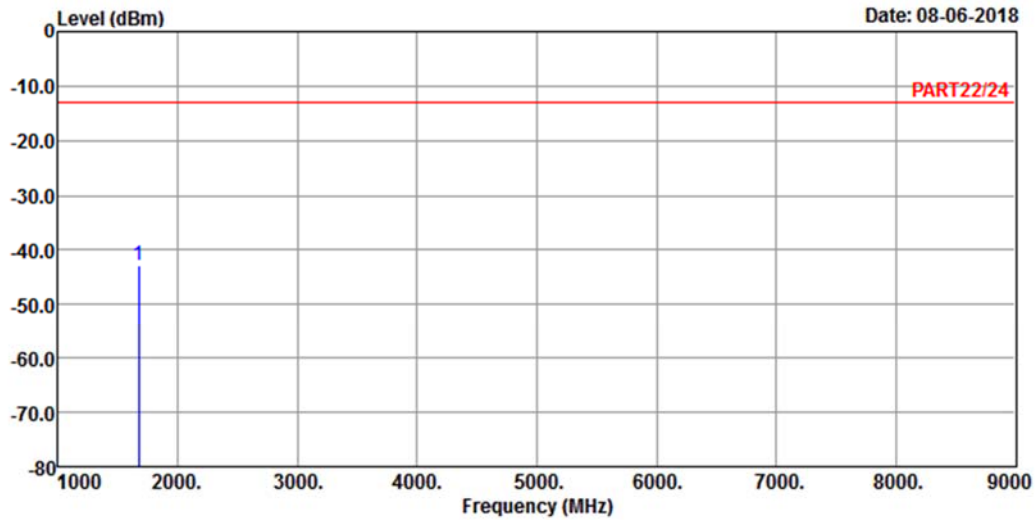

Site : 966 Chamber 5
 Condition: PART22/24 VERTICAL
 Remak : LTE Band 5 QPSK_5M Link_M-CH
 Tested by: Jisyong Wang

Read	Limit	Over				
Freq	Level	Level	Line	Limit	Factor	Remark
MHz	dBm	dBm	dBm	dB	dB	

1 pp 1673.00 -42.69 -28.79 -13.00 -29.69 -13.90 Peak

Mode	LTE Band 5 Channel Bandwidth: 5MHz	Channel	TX channel 20625 (846.5MHz)
------	--	---------	--------------------------------



Bureau Veritas Consumer Products Services Ltd., Taoyuan Branch

A D T

Data: 3

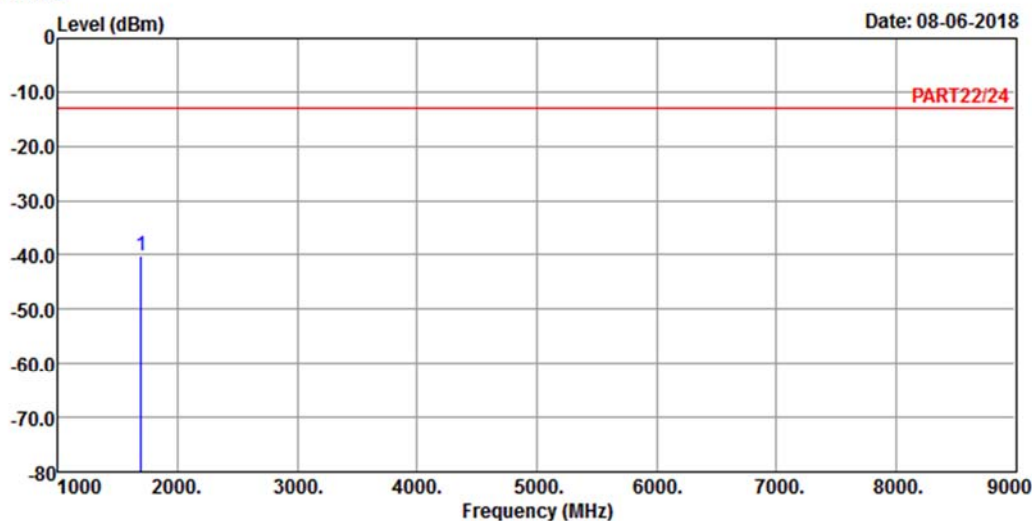

Site : 966 Chamber 5
 Condition: PART22/24 HORIZONTAL
 Remak : LTE Band 5 QPSK_5M Link_H-CH
 Tested by: Jisyong Wang

Freq	Level	Read Level	Limit Line	Over Limit	Factor	Remark
MHz	dBm	dBm	dBm	dB	dB	

1 pp 1693.00 -40.01 -25.99 -13.00 -27.01 -14.02 Peak

Mode	LTE Band 5 Channel Bandwidth: 5MHz	Channel	TX channel 20625 (846.5MHz)
------	--	---------	--------------------------------



Bureau Veritas Consumer Products Services Ltd., Taoyuan Branch

A D T

Data: 4

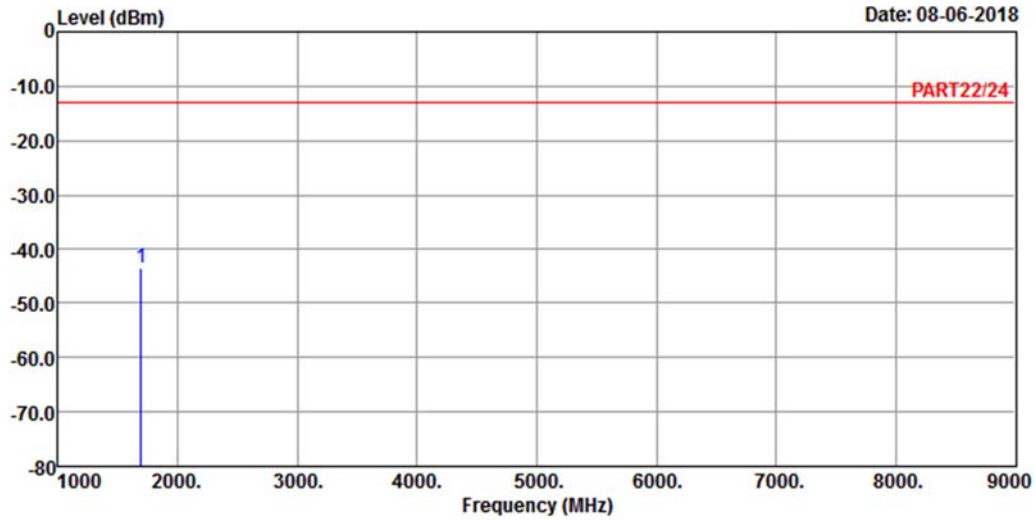

Site : 966 Chamber 5
 Condition: PART22/24 VERTICAL
 Remak : LTE Band 5 QPSK_5M Link_H-CH
 Tested by: Jisyong Wang

Freq	Level	Read Level	Limit Line	Over Limit	Factor	Remark
MHz	dBm	dBm	dBm	dB	dB	

1 pp 1693.00 -43.52 -29.50 -13.00 -30.52 -14.02 Peak

Mode	LTE Band 5 Channel Bandwidth: 10MHz	Channel	TX channel 20450 (829.0MHz)
------	---	---------	--------------------------------



Bureau Veritas Consumer Products Services Ltd., Taoyuan Branch

A D T

Data: 3

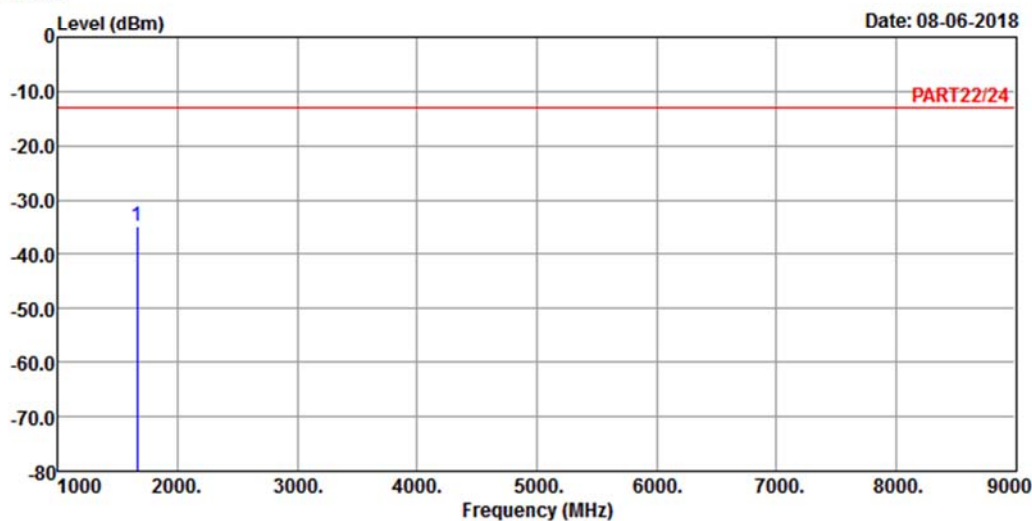

Site : 966 Chamber 5
 Condition: PART22/24 HORIZONTAL
 Remak : LTE Band 5 QPSK_10M Link_L-CH
 Tested by: Jisyong Wang

Freq	Level	Read Level	Limit Line	Over Limit	Factor	Remark
MHz	dBm	dBm	dBm	dB	dB	

1 pp 1658.00 -34.77 -20.97 -13.00 -21.77 -13.80 Peak

Mode	LTE Band 5 Channel Bandwidth: 10MHz	Channel	TX channel 20450 (829.0MHz)
------	---	---------	--------------------------------



Bureau Veritas Consumer Products Services Ltd., Taoyuan Branch

A D T

Data: 4

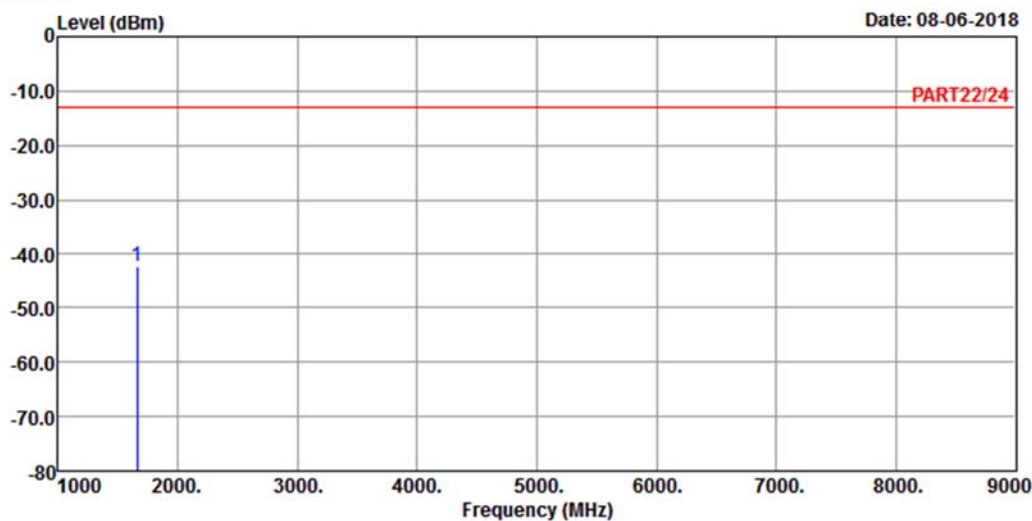

Site : 966 Chamber 5
 Condition: PART22/24 VERTICAL
 Remak : LTE Band 5 QPSK_10M Link_L-CH
 Tested by: Jisyong Wang

Freq	Level	Read Level	Limit Line	Over Limit	Factor	Remark
MHz	dBm	dBm	dBm	dB	dB	

1 pp 1658.00 -42.34 -28.54 -13.00 -29.34 -13.80 Peak

Mode	LTE Band 5 Channel Bandwidth: 10MHz	Channel	TX channel 20525 (836.5MHz)
------	---	---------	--------------------------------



Bureau Veritas Consumer Products Services Ltd., Taoyuan Branch

A D T

Data: 7

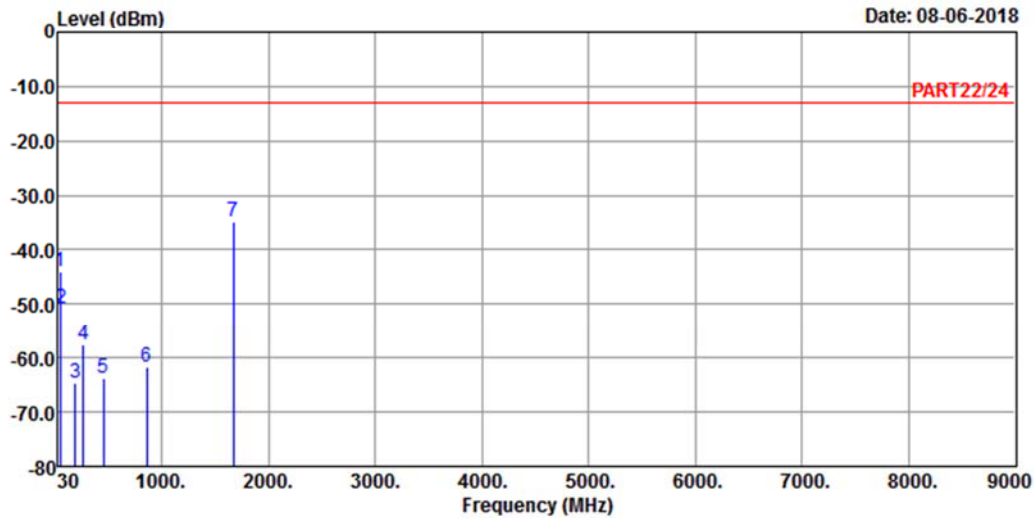

Site : 966 Chamber 5
 Condition: PART22/24 HORIZONTAL
 Remak : LTE Band 5 QPSK_10M Link_M-CH
 Tested by: Jisyong Wang

	Freq	Level	Read Level	Limit Line	Over Limit	Factor	Remark
	MHz	dBm	dBm	dBm	dB	dB	
1	44.85	-44.01	-42.02	-13.00	-31.01	-1.99	Peak
2	52.68	-50.66	-45.12	-13.00	-37.66	-5.54	Peak
3	189.57	-64.65	-57.56	-13.00	-51.65	-7.09	Peak
4	268.14	-57.63	-51.26	-13.00	-44.63	-6.37	Peak
5	456.10	-63.67	-58.23	-13.00	-50.67	-5.44	Peak
6	860.70	-61.68	-62.03	-13.00	-48.68	0.35	Peak
7 pp	1673.00	-34.77	-20.87	-13.00	-21.77	-13.90	Peak

Mode	LTE Band 5 Channel Bandwidth: 10MHz	Channel	TX channel 20525 (836.5MHz)
------	---	---------	--------------------------------



Bureau Veritas Consumer Products Services Ltd., Taoyuan Branch

A D T

Data: 8

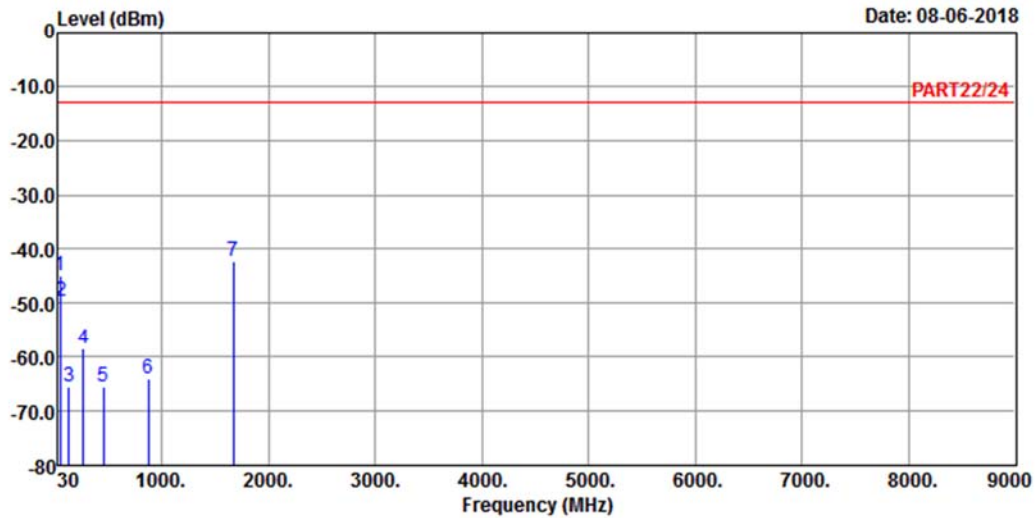

Site : 966 Chamber 5
 Condition: PART22/24 VERTICAL
 Remak : LTE Band 5 QPSK_10M Link_M-CH
 Tested by: Jisyong Wang

	Freq	Level	Read Level	Limit Line	Over Limit	Factor	Remark
	MHz	dBm	dBm	dBm	dB	dB	
1	44.31	-44.88	-42.89	-13.00	-31.88	-1.99	Peak
2	52.95	-49.63	-43.82	-13.00	-36.63	-5.81	Peak
3	128.82	-65.54	-56.73	-13.00	-52.54	-8.81	Peak
4	268.41	-58.49	-52.12	-13.00	-45.49	-6.37	Peak
5	456.10	-65.39	-59.95	-13.00	-52.39	-5.44	Peak
6	871.90	-64.01	-64.43	-13.00	-51.01	0.42	Peak
7 pp	1673.00	-42.34	-28.44	-13.00	-29.34	-13.90	Peak

Mode	LTE Band 5 Channel Bandwidth: 10MHz	Channel	TX channel 20600 (844.0MHz)
------	---	---------	--------------------------------



Bureau Veritas Consumer Products Services Ltd., Taoyuan Branch

A D T

Data: 3

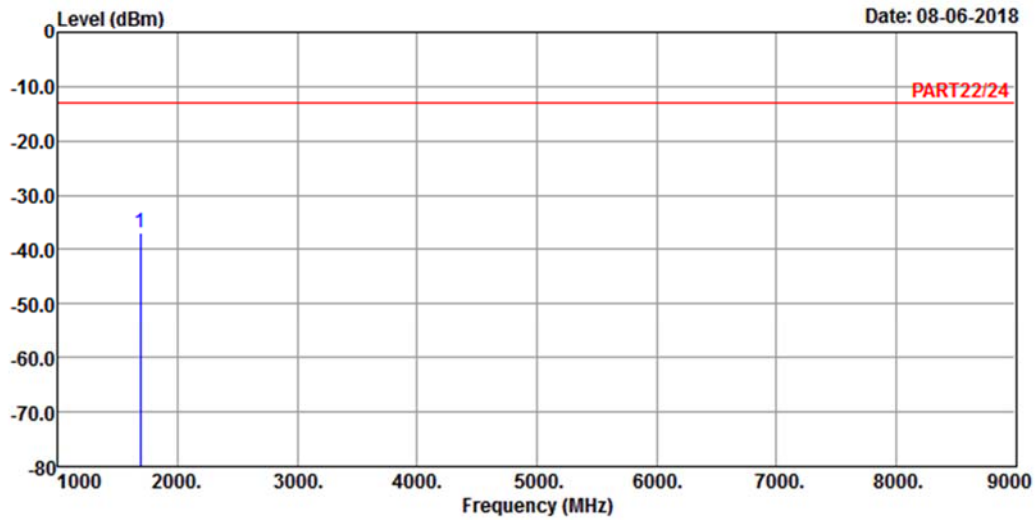

Site : 966 Chamber 5
 Condition: PART22/24 HORIZONTAL
 Remak : LTE Band 5 QPSK_10M Link_H-CH
 Tested by: Jisyong Wang

Read	Limit	Over				
Freq	Level	Level	Line	Limit	Factor	Remark
MHz	dBm	dBm	dBm	dB	dB	
1 pp 1688.00	-36.85	-22.86	-13.00	-23.85	-13.99	Peak

Mode	LTE Band 5 Channel Bandwidth: 10MHz	Channel	TX channel 20600 (844.0MHz)
------	---	---------	--------------------------------



Bureau Veritas Consumer Products Services Ltd., Taoyuan Branch

A D T

Data: 4

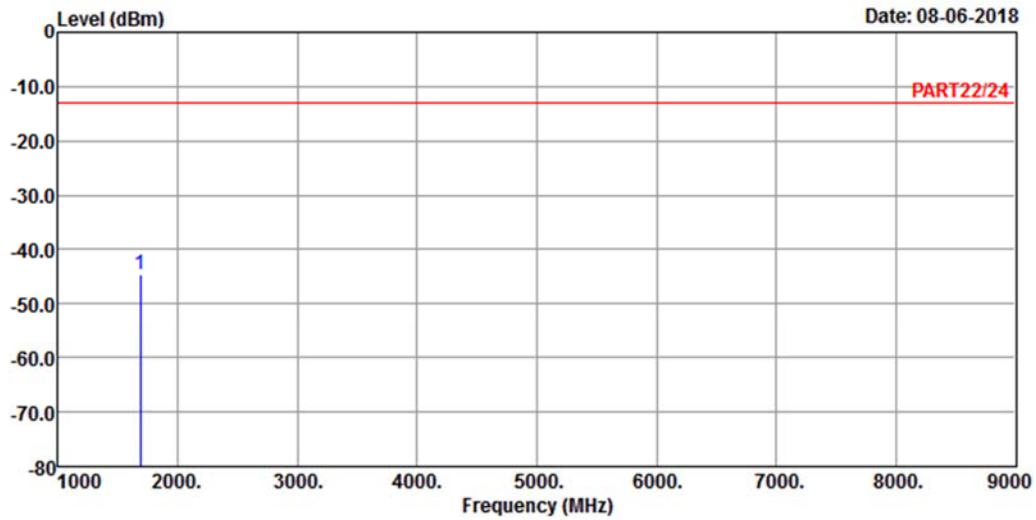

Site : 966 Chamber 5
 Condition: PART22/24 VERTICAL
 Remak : LTE Band 5 QPSK_10M Link_H-CH
 Tested by: Jisyong Wang

Read	Limit	Over				
Freq	Level	Level	Line	Limit	Factor	Remark
MHz	dBm	dBm	dBm	dB	dB	
1 pp 1688.00	-44.52	-30.53	-13.00	-31.52	-13.99	Peak

5 Pictures of Test Arrangements

Please refer to the attached file (Test Setup Photo).

Appendix – Information on the Testing Laboratories

We, Bureau Veritas Consumer Products Services (H.K.) Ltd., Taoyuan Branch, were founded in 1988 to provide our best service in EMC, Radio, Telecom and Safety consultation. Our laboratories are FCC recognized accredited test firms and accredited and approved according to ISO/IEC 17025.

If you have any comments, please feel free to contact us at the following:

Linko EMC/RF Lab

Tel: 886-2-26052180

Fax: 886-2-26051924

Hsin Chu EMC/RF/Telecom Lab

Tel: 886-3-6668565

Fax: 886-3-6668323

Hwa Ya EMC/RF/Safety Lab

Tel: 886-3-3183232

Fax: 886-3-3270892

Email: service.adt@tw.bureauveritas.com

Web Site: www.bureauveritas-adt.com

The address and road map of all our labs can be found in our web site also.

--- END ---