

## FCC Test Report

**Report No.:** RF160122E01A-1

**FCC ID:** NKR-DNSA144

**Test Model:** DNSA-144

**Received Date:** Jan. 22, 2016

**Test Date:** Feb. 01 to 16, 2016 ; Mar. 14, 2017

**Issued Date:** Mar. 29, 2017

**Applicant:** Wistron NeWeb Corp.

**Address:** 20 Park Avenue II, Hsinchu Science Park, Hsinchu 30076, Taiwan, R.O.C.

**Issued By:** Bureau Veritas Consumer Products Services (H.K.) Ltd., Taoyuan Branch  
Hsin Chu Laboratory

**Lab Address:** E-2, No.1, Li Hsin 1st Road, Hsinchu Science Park, Hsinchu City 300,  
Taiwan R.O.C.

**Test Location (1):** E-2, No.1, Li Hsin 1st Road, Hsinchu Science Park, Hsinchu City 300,  
Taiwan R.O.C.

**Test Location (2):** No. 49, Ln. 206, Wende Rd., Shangshan Tsuen, Chiung Lin Hsiang, Hsin  
Chu Hsien 307, Taiwan R.O.C.



This report is for your exclusive use. Any copying or replication of this report to or for any other person or entity, or use of our name or trademark, is permitted only with our prior written permission. This report sets forth our findings solely with respect to the test samples identified herein. The results set forth in this report are not indicative or representative of the quality or characteristics of the lot from which a test sample was taken or any similar or identical product unless specifically and expressly noted. Our report includes all of the tests requested by you and the results thereof based upon the information that you provided to us. You have 60 days from date of issuance of this report to notify us of any material error or omission caused by our negligence, provided, however, that such notice shall be in writing and shall specifically address the issue you wish to raise. A failure to raise such issue within the prescribed time shall constitute your unqualified acceptance of the completeness of this report, the tests conducted and the correctness of the report contents. Unless specific mention, the uncertainty of measurement has been explicitly taken into account to declare the compliance or non-compliance to the specification. The report must not be used by the client to claim product certification, approval, or endorsement by TAF or any government agencies.

## Table of Contents

<b>Release Control Record</b> .....	<b>4</b>
<b>1 Certificate of Conformity</b> .....	<b>5</b>
<b>2 Summary of Test Results</b> .....	<b>6</b>
2.1 Measurement Uncertainty .....	6
2.2 Modification Record .....	6
<b>3 General Information</b> .....	<b>7</b>
3.1 General Description of EUT .....	7
3.2 Description of Test Modes .....	9
3.2.1 Test Mode Applicability and Tested Channel Detail .....	10
3.3 Duty Cycle of Test Signal .....	12
3.4 Description of Support Units .....	13
3.4.1 Configuration of System under Test .....	13
3.5 General Description of Applied Standard .....	14
<b>4 Test Types and Results</b> .....	<b>15</b>
4.1 Radiated Emission and Bandedge Measurement .....	15
4.1.1 Limits of Radiated Emission and Bandedge Measurement .....	15
4.1.2 Test Instruments .....	16
4.1.3 Test Procedure .....	19
4.1.4 Deviation from Test Standard .....	20
4.1.5 Test Setup .....	20
4.1.6 EUT Operating Condition .....	21
4.1.7 Test Results .....	22
4.2 Conducted Emission Measurement .....	47
4.2.1 Limits of Conducted Emission Measurement .....	47
4.2.2 Test Instruments .....	47
4.2.3 Test Procedure .....	48
4.2.4 Deviation from Test Standard .....	48
4.2.5 Test Setup .....	48
4.2.6 EUT Operating Condition .....	48
4.2.7 Test Results .....	49
4.3 Transmit Power Measurement .....	51
4.3.1 Limits of Transmit Power Measurement .....	51
4.3.2 Test Setup .....	51
4.3.3 Test Instruments .....	51
4.3.4 Test Procedure .....	52
4.3.5 Deviation from Test Standard .....	52
4.3.6 EUT Operating Condition .....	52
4.3.7 Test Result .....	53
4.4 Occupied Bandwidth Measurement .....	58
4.4.1 Test Setup .....	58
4.4.2 Test Instruments .....	58
4.4.3 Test Procedure .....	58
4.4.4 Test Results .....	59
4.5 Peak Power Spectral Density Measurement .....	61
4.5.1 Limits of Peak Power Spectral Density Measurement .....	61
4.5.2 Test Setup .....	61
4.5.3 Test Instruments .....	61
4.5.4 Test Procedure .....	62
4.5.5 Deviation from Test Standard .....	62
4.5.6 EUT Operating Condition .....	62
4.5.7 Test Results .....	63
4.6 Frequency Stability Measurement .....	66
4.6.1 Limits of Frequency Stability Measurement .....	66



4.6.2	Test Setup.....	66
4.6.3	Test Instruments .....	66
4.6.4	Test Procedure .....	66
4.6.5	Deviation from Test Standard .....	66
4.6.6	EUT Operating Condition .....	66
4.6.7	Test Results .....	67
4.7	6dB Bandwidth Measurement .....	68
4.7.1	Limits of 6dB Bandwidth Measurement.....	68
4.7.2	Test Setup.....	68
4.7.3	Test Instruments .....	68
4.7.4	Test Procedure .....	68
4.7.5	Deviation from Test Standard .....	68
4.7.6	EUT Operating Condition .....	68
4.7.7	Test Results .....	69
<b>5</b>	<b>Pictures of Test Arrangements.....</b>	<b>70</b>
	<b>Appendix – Information on the Testing Laboratories .....</b>	<b>71</b>



### Release Control Record

Issue No.	Description	Date Issued
RF160122E01A-1	Original release.	Mar. 29, 2017

## 1 Certificate of Conformity

**Product:** 11a/b/g/n IoT WiFi module

**Brand:** WNC

**Test Model:** DNSA-144

**Sample Status:** ENGINEERING SAMPLE

**Applicant:** Wistron NeWeb Corp.

**Test Date:** Feb. 01 to 16, 2016 ; Mar. 14, 2017

**Standard:** 47 CFR FCC Part 15, Subpart E (Section 15.407)  
ANSI C63.10: 2013

The above equipment has been tested by **Bureau Veritas Consumer Products Services (H.K.) Ltd., Taoyuan Branch**, and found compliance with the requirement of the above standards. The test record, data evaluation & Equipment Under Test (EUT) configurations represented herein are true and accurate accounts of the measurements of the sample's EMC characteristics under the conditions specified in this report.

**Prepared by :**  , **Date:** Mar. 29, 2017  
Midoli Peng / Specialist

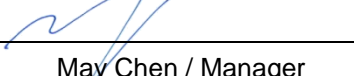
**Approved by :**  , **Date:** Mar. 29, 2017  
May Chen / Manager

## 2 Summary of Test Results

47 CFR FCC Part 15, Subpart E (Section 15.407)			
FCC Clause	Test Item	Result	Remarks
15.407(b)(6)	AC Power Conducted Emissions	PASS	Meet the requirement of limit. Minimum passing margin is -11.82dB at 0.15000MHz.
15.407(b) (1/2/3/4(i/ii)/6)	Radiated Emissions & Band Edge Measurement	PASS	Meet the requirement of limit. Minimum passing margin is -1.0dB at 10360.00MHz & 10400.00MHz & 10640.00MHz
15.407(a)(1/2/3)	Max Average Transmit Power	Pass	Meet the requirement of limit.
---	Occupied Bandwidth Measurement	-	Reference only.
15.407(a)(1/2/3)	Peak Power Spectral Density	Pass	Meet the requirement of limit.
15.407(e)	6dB bandwidth	Pass	Meet the requirement of limit. (U-NII-3 Band only)
15.407(g)	Frequency Stability	Pass	Meet the requirement of limit.
15.203	Antenna Requirement	Pass	No antenna connector is used.

### 2.1 Measurement Uncertainty

Where relevant, the following measurement uncertainty levels have been estimated for tests performed on the EUT as specified in CISPR 16-4-2:

Measurement	Frequency	Expanded Uncertainty (k=2) (±)
Conducted Emissions at mains ports	150kHz ~ 30MHz	2.86 dB
Radiated Emissions up to 1 GHz	30MHz ~ 1GHz	5.19 dB
Radiated Emissions above 1 GHz	1GHz ~ 6GHz	3.43 dB
	6GHz ~ 18GHz	3.49 dB
	18GHz ~ 40GHz	4.11 dB

### 2.2 Modification Record

There were no modifications required for compliance.

### 3 General Information

#### 3.1 General Description of EUT

Product	11a/b/g/n IoT WiFi module
Brand	WNC
Test Model	DNSA-144
Status of EUT	ENGINEERING SAMPLE
Power Supply Rating	DC 3.3V from host equipment
Modulation Type	CCK, DQPSK, DBPSK for DSSS 64QAM, 16QAM, QPSK, BPSK for OFDM
Modulation Technology	DSSS, OFDM
Transfer Rate	802.11b: up to 11Mbps 802.11a/g: up to 54Mbps 802.11n: up to 150Mbps
Operating Frequency	<b>For 15.247:</b> 2.412 ~ 2.462GHz <b>For 15.407:</b> 5.18 ~ 5.24GHz, 5.26 ~ 5.32GHz, 5.5 ~ 5.7GHz, 5.745 ~ 5.825GHz
Number of Channel	<b>For 15.247:</b> 11 for 802.11b, 802.11g, 802.11n (HT20) 7 for 802.11n (HT40) <b>For 15.407:</b> 24 for 802.11a, 802.11n (HT20)
Output Power	<b>For 15.247</b> 802.11b: 62.23mW 802.11g: 233.884mW 802.11n (HT20): 228.034mW 802.11n (HT40): 162.93mW <b>For 15.407</b> <b>5.18 ~ 5.24GHz:</b> 802.11a: 10.864mW 802.11n (HT20): 8.933mW <b>5.26 ~ 5.32GHz:</b> 802.11a: 12.023mW 802.11n (HT20): 9.441mW <b>5.5 ~ 5.7GHz:</b> 802.11a: 32.584mW 802.11n (HT20): 30.13mW <b>5.745 ~ 5.825GHz:</b> 802.11a: 16.634mW 802.11n (HT20): 16.255mW
Antenna Type	Refer to Note
Antenna Connector	Refer to Note
Accessory Device	NA
Data Cable Supplied	NA

Note:

1. 2.4GHz & 5GHz technology cannot transmit at same time.
2. The antenna provided to the EUT, please refer to the following table:

Transmitter Circuit	Brand Name	Model Name	Gain (dBi) (Include cable loss)	Antenna Type	Connector Type	Frequency range (GHz to GHz)
Chain (0)	WNC	DNAS-144-PC BANT	4.9	PCB	NA	2.4~2.5
			3.9			5.15~5.85

3. The EUT incorporates a SISO function.

2.4GHz Band			
MODULATION MODE	DATA RATE (MCS)	TX & RX CONFIGURATION	
802.11b	1 ~ 11Mbps	1TX	1RX
802.11g	6 ~ 54Mbps	1TX	1RX
802.11n (HT20)	MCS 0~7	1TX	1RX
802.11n (HT40)	MCS 0~7	1TX	1RX
5GHz Band			
MODULATION MODE	DATA RATE (MCS)	TX & RX CONFIGURATION	
802.11a	6 ~ 54Mbps	1TX	1RX
802.11n (HT20)	MCS 0~7	1TX	1RX

4. The above EUT information is declared by manufacturer and for more detailed features description, please refer to the manufacturer's specifications or user's manual.



### 3.2 Description of Test Modes

#### FOR 5180 ~ 5240MHz

4 channels are provided for 802.11a, 802.11n (HT20):

Channel	Frequency	Channel	Frequency
36	5180 MHz	44	5220 MHz
40	5200 MHz	48	5240 MHz

#### FOR 5260 ~ 5320MHz

4 channels are provided for 802.11a, 802.11n (HT20):

Channel	Frequency	Channel	Frequency
52	5260 MHz	60	5300 MHz
56	5280 MHz	64	5320 MHz

#### FOR 5500 ~ 5700MHz

11 channels are provided for 802.11a, 802.11n (HT20):

Channel	Frequency	Channel	Frequency
100	5500 MHz	124	5620 MHz
104	5520 MHz	128	5640 MHz
108	5540 MHz	132	5660 MHz
112	5560 MHz	136	5680 MHz
116	5580 MHz	140	5700 MHz
120	5600 MHz		

#### FOR 5745 ~ 5825MHz:

5 channels are provided for 802.11a, 802.11n (HT20):

Channel	Frequency	Channel	Frequency
149	5745MHz	161	5805MHz
153	5765MHz	165	5825MHz
157	5785MHz		

### 3.2.1 Test Mode Applicability and Tested Channel Detail

EUT CONFIGURE MODE	APPLICABLE TO				DESCRIPTION
	RE≥1G	RE<1G	PLC	APCM	
-	√	√	√	√	-

Where **RE≥1G**: Radiated Emission above 1GHz      **RE<1G**: Radiated Emission below 1GHz  
**PLC**: Power Line Conducted Emission      **APCM**: Antenna Port Conducted Measurement

**NOTE**: The EUT had been pre-tested on the positioned of each 3 axis. The worst case was found when positioned on X-plane.  
**NOTE**: “-” means no effect.

#### **Radiated Emission Test (Above 1GHz):**

- Pre-Scan has been conducted to determine the worst-case mode from all possible combinations between available modulations, data rates and antenna ports (if EUT with antenna diversity architecture).
- Following channel(s) was (were) selected for the final test as listed below.

MODE	FREQ. BAND (MHz)	AVAILABLE CHANNEL	TESTED CHANNEL	MODULATION TECHNOLOGY	MODULATION TYPE	DATA RATE (Mbps)
802.11a	5180-5240	36 to 48	36, 40, 48	OFDM	BPSK	6
802.11n (HT20)		36 to 48	36, 40, 48	OFDM	BPSK	6.5
802.11a	5260-5320	52 to 64	52, 60, 64	OFDM	BPSK	6
802.11n (HT20)		52 to 64	52, 60, 64	OFDM	BPSK	6.5
802.11a	5500-5700	100 to 140	100, 116, 140	OFDM	BPSK	6
802.11n (HT20)		100 to 140	100, 116, 140	OFDM	BPSK	6.5
802.11a	5745-5825	149 to 165	149, 157, 165	OFDM	BPSK	6
802.11n (HT20)		149 to 165	149, 157, 165	OFDM	BPSK	6.5

#### **Radiated Emission Test (Below 1GHz):**

- Pre-Scan has been conducted to determine the worst-case mode from all possible combinations between available modulations, data rates and antenna ports (if EUT with antenna diversity architecture).
- Following channel(s) was (were) selected for the final test as listed below.

MODE	FREQ. BAND (MHz)	AVAILABLE CHANNEL	TESTED CHANNEL	MODULATION TECHNOLOGY	MODULATION TYPE	DATA RATE (Mbps)
802.11a	5180-5320 5500-5700 5745-5825	36 to 64 100 to 140 149 to 165	116	OFDM	BPSK	6

**Power Line Conducted Emission Test:**

- Pre-Scan has been conducted to determine the worst-case mode from all possible combinations between available modulations, data rates and antenna ports (if EUT with antenna diversity architecture).
- Following channel(s) was (were) selected for the final test as listed below.

MODE	FREQ. BAND (MHz)	AVAILABLE CHANNEL	TESTED CHANNEL	MODULATION TECHNOLOGY	MODULATION TYPE	DATA RATE (Mbps)
802.11a	5180-5320	36 to 64	116	OFDM	BPSK	6
	5500-5700	100 to 140				
	5745-5825	149 to 165				

**Antenna Port Conducted Measurement:**

- This item includes all test value of each mode, but only includes spectrum plot of worst value of each mode.
- Pre-Scan has been conducted to determine the worst-case mode from all possible combinations between available modulations, data rates and antenna ports (if EUT with antenna diversity architecture).
- Following channel(s) was (were) selected for the final test as listed below.

MODE	FREQ. BAND (MHz)	AVAILABLE CHANNEL	TESTED CHANNEL	MODULATION TECHNOLOGY	MODULATION TYPE	DATA RATE (Mbps)
802.11a	5180-5240	36 to 48	36, 40, 48	OFDM	BPSK	6
802.11n (HT20)		36 to 48	36, 40, 48	OFDM	BPSK	6.5
802.11a	5260-5320	52 to 64	52, 60, 64	OFDM	BPSK	6
802.11n (HT20)		52 to 64	52, 60, 64	OFDM	BPSK	6.5
802.11a	5500-5700	100 to 140	100, 116, 140	OFDM	BPSK	6
802.11n (HT20)		100 to 140	100, 116, 140	OFDM	BPSK	6.5
802.11a	5745-5825	149 to 165	149, 157, 165	OFDM	BPSK	6
802.11n (HT20)		149 to 165	149, 157, 165	OFDM	BPSK	6.5

**Test Condition:**

APPLICABLE TO	ENVIRONMENTAL CONDITIONS	INPUT POWER (SYSTEM)	TESTED BY
RE≥1G	23deg. C, 65%RH	120Vac, 60Hz	Jyunchun Lin
RE<1G	21deg. C, 63%RH	120Vac, 60Hz	Gary Cheng
	25deg. C, 70%RH		Weiwei Lo
PLC	18deg. C, 60%RH	120Vac, 60Hz	Gavin Peng
APCM	19deg. C, 63%RH	120Vac, 60Hz	Robert Cheng

### 3.3 Duty Cycle of Test Signal

If duty cycle of test signal is  $\geq 98\%$ , duty factor is not required.

**802.11a:** Duty cycle =  $2.112 \text{ ms} / 2.148 \text{ ms} = 0.983$

**802.11n (HT20):** Duty cycle =  $1.967 \text{ ms} / 2.004 \text{ ms} = 0.982$

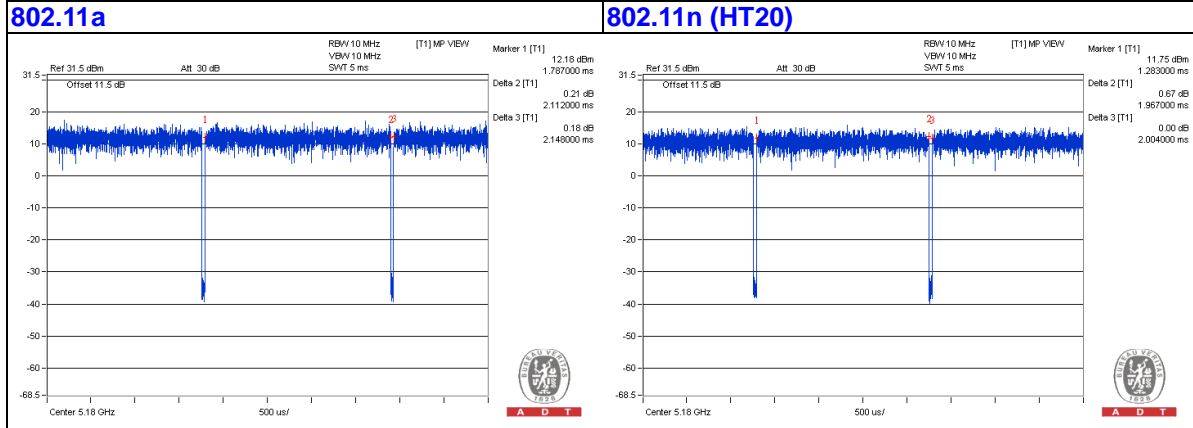

### 3.4 Description of Support Units

The EUT has been tested as an independent unit together with other necessary accessories or support units. The following support units or accessories were used to form a representative test configuration during the tests.

ID	Product	Brand	Model No.	Serial No.	FCC ID	Remarks
A.	NOTEBOOK COMPUTER	Lenovo	R9-DFT3G11/05	NA	NA	Supplied by Client
B.	Test Tool	NA	NA	E187451	NA	Supplied by Client

Note:

1. All power cords of the above support units are non-shielded (1.8m).

ID	Descriptions	Qty.	Length (m)	Shielding (Yes/No)	Cores (Qty.)	Remarks
1.	USB	1	1	No	0	Supplied by Client

#### 3.4.1 Configuration of System under Test

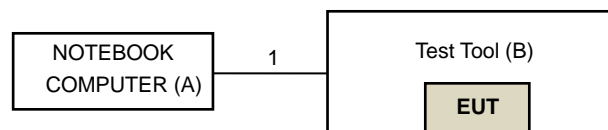



### 3.5 General Description of Applied Standard

The EUT is a RF Product. According to the specifications of the manufacturer, it must comply with the requirements of the following standards:

**FCC Part 15, Subpart E (15.407)**

**KDB 789033 D02 General UNII Test Procedure New Rules v01r03**

ANSI C63.10-2013

All test items have been performed and recorded as per the above standards.

**NOTE:** The EUT has been verified to comply with the requirements of FCC Part 15, Subpart B, Class B (DoC). The test report has been issued separately.

## 4 Test Types and Results

### 4.1 Radiated Emission and Bandedge Measurement

#### 4.1.1 Limits of Radiated Emission and Bandedge Measurement

Radiated emissions which fall in the restricted bands must comply with the radiated emission limits specified as below table.

Frequencies (MHz)	Field Strength (microvolts/meter)	Measurement Distance (meters)
0.009 ~ 0.490	2400/F(kHz)	300
0.490 ~ 1.705	24000/F(kHz)	30
1.705 ~ 30.0	30	30
30 ~ 88	100	3
88 ~ 216	150	3
216 ~ 960	200	3
Above 960	500	3

#### NOTE:

1. The lower limit shall apply at the transition frequencies.
2. Emission level (dBuV/m) = 20 log Emission level (uV/m).
3. For frequencies above 1000MHz, the field strength limits are based on average detector, however, the peak field strength of any emission shall not exceed the maximum permitted average limits, specified above by more than 20dB under any condition of modulation.

Limits of unwanted emission out of the restricted bands

Applicable To		Limit	
789033 D02 General UNII Test Procedure New Rules v01r03		Field Strength at 3m	
		PK:74 (dBµV/m)	AV:54 (dBµV/m)
Frequency Band	Applicable To	EIRP Limit	Equivalent Field Strength at 3m
5150~5250 MHz	15.407(b)(1)	PK:-27 (dBm/MHz)	PK:68.2(dBµV/m)
5250~5350 MHz	15.407(b)(2)		
5470~5725 MHz	15.407(b)(3)		
5725~5850 MHz	<input checked="" type="checkbox"/> 15.407(b)(4)(i)	PK:-27 (dBm/MHz) <sup>*1</sup> PK:10 (dBm/MHz) <sup>*2</sup> PK:15.6 (dBm/MHz) <sup>*3</sup> PK:27 (dBm/MHz) <sup>*4</sup>	PK: 68.2(dBµV/m) <sup>*1</sup> PK:105.2 (dBµV/m) <sup>*2</sup> PK: 110.8(dBµV/m) <sup>*3</sup> PK:122.2 (dBµV/m) <sup>*4</sup>
	<input type="checkbox"/> 15.407(b)(4)(ii)	Emission limits in section 15.247(d)	
<sup>*1</sup> beyond 75 MHz or more above of the band edge.		<sup>*2</sup> below the band edge increasing linearly to 10 dBm/MHz at 25 MHz above.	
<sup>*3</sup> below the band edge increasing linearly to a level of 15.6 dBm/MHz at 5 MHz above.		<sup>*4</sup> from 5 MHz above or below the band edge increasing linearly to a level of 27 dBm/MHz at the band edge.	

#### Note:

The following formula is used to convert the equipment isotropic radiated power (eirp) to field strength:

$$E = \frac{1000000\sqrt{30P}}{3} \mu\text{V/m, where P is the eirp (Watts).}$$

#### 4.1.2 Test Instruments

##### For Radiated (above 1GHz <U-NII-3 band>) test:

DESCRIPTION & MANUFACTURER	MODEL NO.	SERIAL NO.	CALIBRATED DATE	CALIBRATED UNTIL
Test Receiver Keysight	N9038A	MY54450088	July 20, 2016	July 19, 2017
Horn_Antenna SCHWARZBECK	BBHA 9120D	9120D-783	Dec. 27, 2016	Dec. 26, 2017
Pre-Amplifier EMCI	EMC12630SE	980385	Feb. 02, 2017	Feb. 01, 2018
RF Cable	EMC104-SM- SM-2000 EMC104-SM- SM-5000 EMC104-SM- SM-5000	160923 150318 150323	Feb. 02, 2017 Mar. 30, 2016 Mar. 30, 2016	Feb. 01, 2018 Mar. 29, 2017 Mar. 29, 2017
Pre-Amplifier EMCI	EMC184045S E	980387	Feb. 02, 2017	Feb. 01, 2018
Horn_Antenna SCHWARZBECK	BBHA 9170	BBHA9170608	Dec. 15, 2016	Dec. 14, 2017
RF Cable	SUCOFLEX 102	36432/2 36433/2	Jan. 15, 2017	Jan. 14, 2018
Software	ADT_Radiated _V8.7.08	NA	NA	NA
Antenna Tower & Turn Table Max-Full	MF-7802	MF780208410	NA	NA
Boresight Antenna Fixture	FBA-01	FBA-SIP02	NA	NA

##### Note:

1. The calibration interval of the above test instruments is 12 months and the calibrations are traceable to NML/ROC and NIST/USA.
2. The test was performed in 966 Chamber No. 4.
3. The FCC Site Registration No. is 292998
4. The CANADA Site Registration No. is 20331-2
5. Tested Date: Mar. 14, 2017



**For other test items:**

<b>DESCRIPTION &amp; MANUFACTURER</b>	<b>MODEL NO.</b>	<b>SERIAL NO.</b>	<b>CALIBRATED DATE</b>	<b>CALIBRATED UNTIL</b>
Test Receiver Agilent	N9038A	MY54450088	July 24, 2015	July 23, 2016
Pre-Amplifier <sup>(*)</sup> EMCI	EMC001340	980142	Jan. 20, 2016	Jan. 19, 2018
Loop Antenna <sup>(*)</sup> Electro-Metrics	EM-6879	264	Dec. 16, 2014	Dec. 15, 2016
RF Cable	NA	LOOPCAB-001 LOOPCAB-002	Jan. 18, 2016	Jan. 17, 2017
Pre-Amplifier Mini-Circuits	ZFL-1000VH2B	AMP-ZFL-01	Nov. 11, 2015	Nov. 10, 2016
Trilog Broadband Antenna SCHWARZBECK	VULB 9168	9168-406	Jan. 04, 2016	Jan. 03, 2017
RF Cable	8D	966-4-1 966-4-2 966-4-3	Apr. 03, 2015	Apr. 02, 2016
Horn_Antenna SCHWARZBECK	BBHA 9120D	9120D-783	Jan. 19, 2016	Jan. 18, 2017
Pre-Amplifier Agilent	8449B	3008A01922	Sep. 19, 2015	Sep. 18, 2016
RF Cable	EMC104-SM-SM-20 00 EMC104-SM-SM-50 00 EMC104-SM-SM-50 00	150318 150323 150324	Mar. 31, 2015	Mar. 30, 2016
Pre-Amplifier EMCI	EMC184045	980143	Jan. 15, 2016	Jan. 14, 2017
Horn_Antenna SCHWARZBECK	BBHA 9170	BBHA9170608	Jan. 08, 2016	Jan. 07, 2017
RF Cable	SUCOFLEX 102	36432/2 36441/2	Jan. 16, 2016	Jan. 15, 2017
Software	ADT_Radiated_V8. 7.07	NA	NA	NA
Antenna Tower & Turn Table CT	NA	NA	NA	NA
Spectrum analyzer R&S	FSP 40	100060	May 08, 2015	May 07, 2016
Power meter Anritsu	ML2495A	1014008	Apr. 28, 2015	Apr. 27, 2016
Power sensor Anritsu	MA2411B	0917122	Apr. 28, 2015	Apr. 27, 2016
Temperature & Humidity Chamber GIANTFORCE	GTH-150-40-SP-AR	MAA0812-008	Jan. 15, 2016	Jan. 14, 2017



**Note:**

1. The calibration interval of the above test instruments is 12 months and the calibrations are traceable to NML/ROC and NIST/USA.
2. \*The calibration interval of the above test instruments is 24 months and the calibrations are traceable to NML/ROC and NIST/USA.
3. Loop antenna was used for all emissions below 30 MHz.
4. The test was performed in 966 Chamber No. 4.
5. The FCC Site Registration No. is 292998
6. The CANADA Site Registration No. is 20331-2
- 7 Tested Date: Feb. 01 to 03, 2016

#### 4.1.3 Test Procedure

##### **For Radiated emission below 30MHz**

- a. The EUT was placed on the top of a rotating table 0.8 meters above the ground at a 3 meter chamber room. The table was rotated 360 degrees to determine the position of the highest radiation.
- b. The EUT was set 3 meters away from the interference-receiving antenna, which was mounted on the top of a variable-height antenna tower.
- c. Both X and Y axes of the antenna are set to make the measurement.
- d. For each suspected emission, the EUT was arranged to its worst case and the rotatable table was turned from 0 degrees to 360 degrees to find the maximum reading.
- e. The test-receiver system was set to Quasi-Peak Detect Function and Specified Bandwidth with Maximum Hold Mode.

##### **NOTE:**

1. The resolution bandwidth and video bandwidth of test receiver/spectrum analyzer is 9kHz at frequency below 30MHz.

##### **For Radiated emission above 30MHz**

- a. The EUT was placed on the top of a rotating table 0.8 meters (for 30MHz ~ 1GHz) / 1.5 meters (for above 1GHz) above the ground at 3 meter chamber room for test. The table was rotated 360 degrees to determine the position of the highest radiation.
- b. The EUT was set 3 meters away from the interference-receiving antenna, which was mounted on the top of a variable-height antenna tower.
- c. The height of antenna is varied from one meter to four meters above the ground to determine the maximum value of the field strength. Both horizontal and vertical polarizations of the antenna are set to make the measurement.
- d. For each suspected emission, the EUT was arranged to its worst case and then the antenna was tuned to heights from 1 meter to 4 meters and the rotatable table was turned from 0 degrees to 360 degrees to find the maximum reading.
- e. The test-receiver system was set to quasi-peak detect function and specified bandwidth with maximum hold mode when the test frequency is below 1 GHz.
- f. The test-receiver system was set to peak and average detect function and specified bandwidth with maximum hold mode when the test frequency is above 1 GHz. If the peak reading value also meets average limit, measurement with the average detector is unnecessary.

##### **Note:**

1. The resolution bandwidth and video bandwidth of test receiver/spectrum analyzer is 120kHz for Quasi-peak detection (QP) at frequency below 1GHz.
2. The resolution bandwidth of test receiver/spectrum analyzer is 1 MHz and the video bandwidth is 3 MHz for Peak detection (PK) at frequency above 1GHz.
3. The resolution bandwidth of test receiver/spectrum analyzer is 1MHz and the video bandwidth is 3MHz for RMS Average (Duty cycle < 98%) for Average detection (AV) at frequency above 1GHz, then the measurement results was added to a correction factor ( $10 \log(1/\text{duty cycle})$ ).
4. The resolution bandwidth of test receiver/spectrum analyzer is 1MHz and the video bandwidth is 10Hz (Duty cycle  $\geq$  98%) for Average detection (AV) at frequency above 1GHz.
5. All modes of operation were investigated and the worst-case emissions are reported.

#### 4.1.4 Deviation from Test Standard

No deviation.

#### 4.1.5 Test Setup

##### For Radiated emission below 30MHz

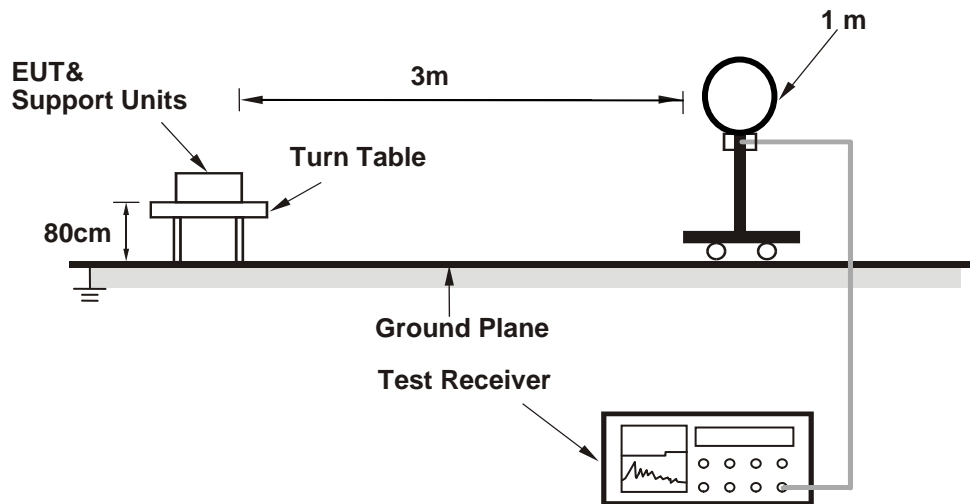

##### For Radiated emission 30MHz to 1GHz

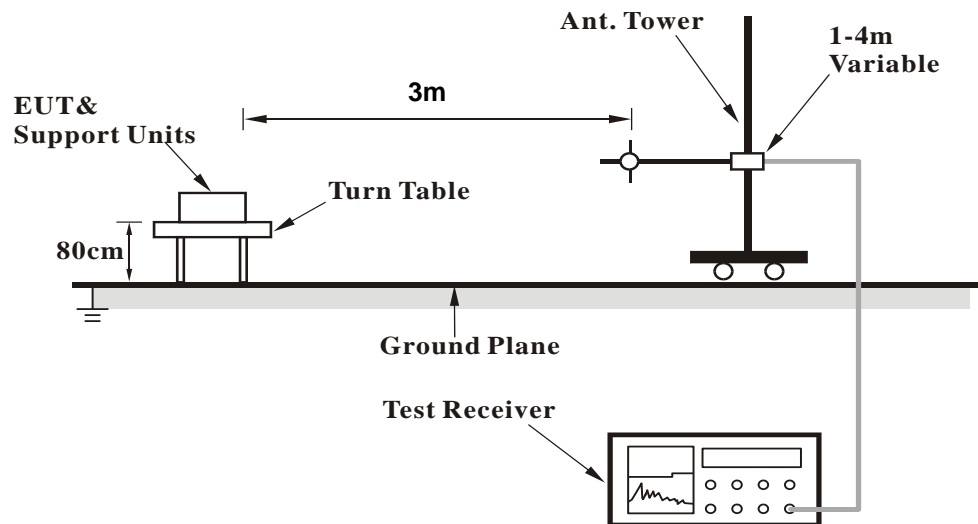

### For Radiated emission above 1GHz

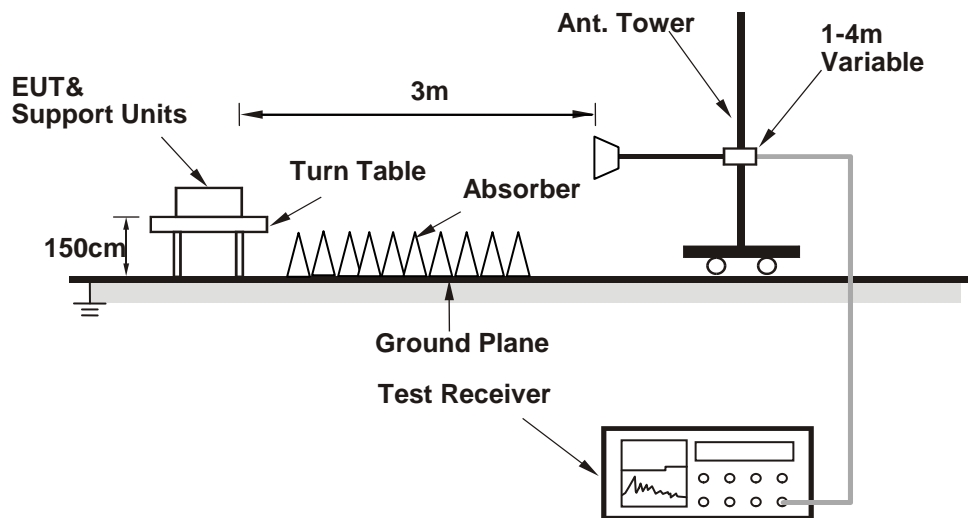

For the actual test configuration, please refer to the attached file (Test Setup Photo).

#### 4.1.6 EUT Operating Condition

1. Connect the EUT with the support unit A (Notebook computer) which is placed on the testing table.
2. The communication partner run test program "artqui.exe [ART2 IO]Ver 2.3" to enable EUT under transmission/receiving condition continuously at specific channel frequency.



4.1.7 Test Results

Above 1GHz Data:

802.11a

<b>CHANNEL</b>	TX Channel 36	<b>DETECTOR FUNCTION</b>	Peak (PK)
<b>FREQUENCY RANGE</b>	1GHz ~ 40GHz		Average (AV)

**ANTENNA POLARITY & TEST DISTANCE: HORIZONTAL AT 3 M**

NO.	FREQ. (MHz)	EMISSION LEVEL (dBuV/m)	LIMIT (dBuV/m)	MARGIN (dB)	ANTENNA HEIGHT (m)	TABLE ANGLE (Degree)	RAW VALUE (dBuV)	CORRECTION FACTOR (dB/m)
1	5150.00	54.2 PK	74.0	-19.8	1.08 H	69	53.56	0.64
2	5150.00	42.7 AV	54.0	-11.3	1.08 H	69	42.06	0.64
3	*5180.00	103.1 PK			1.08 H	69	102.37	0.73
4	*5180.00	92.2 AV			1.08 H	69	91.47	0.73
5	#10360.00	58.6 PK	74.0	-15.4	3.99 H	358	47.85	10.75
6	#10360.00	44.7 AV	54.0	-9.3	3.99 H	358	33.95	10.75
7	15540.00	53.7 PK	74.0	-20.3	3.82 H	17	40.55	13.15
8	15540.00	39.5 AV	54.0	-14.5	3.82 H	17	26.35	13.15

**ANTENNA POLARITY & TEST DISTANCE: VERTICAL AT 3 M**

NO.	FREQ. (MHz)	EMISSION LEVEL (dBuV/m)	LIMIT (dBuV/m)	MARGIN (dB)	ANTENNA HEIGHT (m)	TABLE ANGLE (Degree)	RAW VALUE (dBuV)	CORRECTION FACTOR (dB/m)
1	5150.00	51.9 PK	74.0	-22.1	3.02 V	126	51.26	0.64
2	5150.00	40.2 AV	54.0	-13.8	3.02 V	126	39.56	0.64
3	*5180.00	98.0 PK			3.02 V	126	97.27	0.73
4	*5180.00	87.2 AV			3.02 V	126	86.47	0.73
5	#10360.00	67.3 PK	74.0	-6.7	3.17 V	155	56.55	10.75
<b>6</b>	<b>#10360.00</b>	<b>53.0 AV</b>	<b>54.0</b>	<b>-1.0</b>	<b>3.17 V</b>	<b>155</b>	<b>42.25</b>	<b>10.75</b>
7	15540.00	53.9 PK	74.0	-20.1	1.16 V	28	40.75	13.15
8	15540.00	39.9 AV	54.0	-14.1	1.16 V	28	26.75	13.15

**REMARKS:**

1. Emission Level(dBuV/m) = Raw Value(dBuV) + Correction Factor(dB/m)
2. Correction Factor(dB/m) = Antenna Factor(dB/m) + Cable Factor(dB) – Pre-Amplifier Factor(dB)
3. The other emission levels were very low against the limit.
4. Margin value = Emission Level – Limit value
5. " \* ": Fundamental frequency.
6. " # ": The radiated frequency is out of the restricted band.

<b>CHANNEL</b>	TX Channel 40	<b>DETECTOR FUNCTION</b>	Peak (PK)
<b>FREQUENCY RANGE</b>	1GHz ~ 40GHz		Average (AV)

**ANTENNA POLARITY & TEST DISTANCE: HORIZONTAL AT 3 M**

NO.	FREQ. (MHz)	EMISSION LEVEL (dBuV/m)	LIMIT (dBuV/m)	MARGIN (dB)	ANTENNA HEIGHT (m)	TABLE ANGLE (Degree)	RAW VALUE (dBuV)	CORRECTION FACTOR (dB/m)
1	*5200.00	101.4 PK			1.01 H	69	100.61	0.79
2	*5200.00	91.6 AV			1.01 H	69	90.81	0.79
3	#10400.00	58.9 PK	74.0	-15.1	3.98 H	360	47.80	11.10
4	#10400.00	44.9 AV	54.0	-9.1	3.98 H	360	33.80	11.10
5	15600.00	53.0 PK	74.0	-21.0	3.86 H	28	39.78	13.22
6	15600.00	39.0 AV	54.0	-15.0	3.86 H	28	25.78	13.22

**ANTENNA POLARITY & TEST DISTANCE: VERTICAL AT 3 M**

NO.	FREQ. (MHz)	EMISSION LEVEL (dBuV/m)	LIMIT (dBuV/m)	MARGIN (dB)	ANTENNA HEIGHT (m)	TABLE ANGLE (Degree)	RAW VALUE (dBuV)	CORRECTION FACTOR (dB/m)
1	*5200.00	98.2 PK			3.00 V	120	97.41	0.79
2	*5200.00	87.6 AV			3.00 V	120	86.81	0.79
3	#10400.00	68.1 PK	74.0	-5.9	3.63 V	144	57.00	11.10
<b>4</b>	<b>#10400.00</b>	<b>53.0 AV</b>	<b>54.0</b>	<b>-1.0</b>	<b>3.63 V</b>	<b>144</b>	<b>41.90</b>	<b>11.10</b>
5	15600.00	53.3 PK	74.0	-20.7	1.18 V	43	40.08	13.22
6	15600.00	39.4 AV	54.0	-14.6	1.18 V	43	26.18	13.22

**REMARKS:**

1. Emission Level(dBuV/m) = Raw Value(dBuV) + Correction Factor(dB/m)
2. Correction Factor(dB/m) = Antenna Factor(dB/m) + Cable Factor(dB) – Pre-Amplifier Factor(dB)
3. The other emission levels were very low against the limit.
4. Margin value = Emission Level – Limit value
5. " \* ": Fundamental frequency.
6. " # ": The radiated frequency is out of the restricted band.

<b>CHANNEL</b>	TX Channel 48	<b>DETECTOR FUNCTION</b>	Peak (PK)
<b>FREQUENCY RANGE</b>	1GHz ~ 40GHz		Average (AV)

**ANTENNA POLARITY & TEST DISTANCE: HORIZONTAL AT 3 M**

NO.	FREQ. (MHz)	EMISSION LEVEL (dBuV/m)	LIMIT (dBuV/m)	MARGIN (dB)	ANTENNA HEIGHT (m)	TABLE ANGLE (Degree)	RAW VALUE (dBuV)	CORRECTION FACTOR (dB/m)
1	*5240.00	103.8 PK			1.02 H	68	102.88	0.92
2	*5240.00	92.0 AV			1.02 H	68	91.08	0.92
3	5405.20	52.0 PK	74.0	-22.0	1.02 H	68	50.78	1.22
4	5405.20	40.4 AV	54.0	-13.6	1.02 H	68	39.18	1.22
5	#10480.00	58.7 PK	74.0	-15.3	4.00 H	360	47.76	10.94
6	#10480.00	44.5 AV	54.0	-9.5	4.00 H	360	33.56	10.94
7	15720.00	52.8 PK	74.0	-21.2	3.80 H	20	40.27	12.53
8	15720.00	39.0 AV	54.0	-15.0	3.80 H	20	26.47	12.53

**ANTENNA POLARITY & TEST DISTANCE: VERTICAL AT 3 M**

NO.	FREQ. (MHz)	EMISSION LEVEL (dBuV/m)	LIMIT (dBuV/m)	MARGIN (dB)	ANTENNA HEIGHT (m)	TABLE ANGLE (Degree)	RAW VALUE (dBuV)	CORRECTION FACTOR (dB/m)
1	*5240.00	98.2 PK			3.05 V	128	97.28	0.92
2	*5240.00	87.7 AV			3.05 V	128	86.78	0.92
3	5405.20	51.4 PK	74.0	-22.6	3.05 V	128	50.18	1.22
4	5405.20	40.0 AV	54.0	-14.0	3.05 V	128	38.78	1.22
5	#10480.00	67.3 PK	74.0	-6.7	3.68 V	144	56.36	10.94
6	#10480.00	52.8 AV	54.0	-1.2	3.68 V	144	41.86	10.94
7	15720.00	52.9 PK	74.0	-21.1	1.21 V	57	40.37	12.53
8	15720.00	38.9 AV	54.0	-15.1	1.21 V	57	26.37	12.53

**REMARKS:**

1. Emission Level(dBuV/m) = Raw Value(dBuV) + Correction Factor(dB/m)
2. Correction Factor(dB/m) = Antenna Factor(dB/m) + Cable Factor(dB) – Pre-Amplifier Factor(dB)
3. The other emission levels were very low against the limit.
4. Margin value = Emission Level – Limit value
5. " \* ": Fundamental frequency.
6. " # ": The radiated frequency is out of the restricted band.



<b>CHANNEL</b>	TX Channel 52	<b>DETECTOR FUNCTION</b>	Peak (PK)
<b>FREQUENCY RANGE</b>	1GHz ~ 40GHz		Average (AV)

**ANTENNA POLARITY & TEST DISTANCE: HORIZONTAL AT 3 M**

NO.	FREQ. (MHz)	EMISSION LEVEL (dBuV/m)	LIMIT (dBuV/m)	MARGIN (dB)	ANTENNA HEIGHT (m)	TABLE ANGLE (Degree)	RAW VALUE (dBuV)	CORRECTION FACTOR (dB/m)
1	5150.00	51.5 PK	74.0	-22.5	1.00 H	89	50.86	0.64
2	5150.00	38.6 AV	54.0	-15.4	1.00 H	89	37.96	0.64
3	*5260.00	104.6 PK			1.00 H	89	103.59	1.01
4	*5260.00	92.4 AV			1.00 H	89	91.39	1.01
5	#10520.00	59.1 PK	74.0	-14.9	3.99 H	360	48.11	10.99
6	#10520.00	45.4 AV	54.0	-8.6	3.99 H	360	34.41	10.99
7	15780.00	53.0 PK	74.0	-21.0	3.90 H	25	40.59	12.41
8	15780.00	38.8 AV	54.0	-15.2	3.90 H	25	26.39	12.41

**ANTENNA POLARITY & TEST DISTANCE: VERTICAL AT 3 M**

NO.	FREQ. (MHz)	EMISSION LEVEL (dBuV/m)	LIMIT (dBuV/m)	MARGIN (dB)	ANTENNA HEIGHT (m)	TABLE ANGLE (Degree)	RAW VALUE (dBuV)	CORRECTION FACTOR (dB/m)
1	5150.00	51.0 PK	74.0	-23.0	3.08 V	143	50.36	0.64
2	5150.00	38.0 AV	54.0	-16.0	3.08 V	143	37.36	0.64
3	*5260.00	98.2 PK			3.08 V	143	97.19	1.01
4	*5260.00	87.6 AV			3.08 V	143	86.59	1.01
5	#10520.00	68.2 PK	74.0	-5.8	3.32 V	152	57.21	10.99
6	#10520.00	52.7 AV	54.0	-1.3	3.32 V	152	41.71	10.99
7	15780.00	52.9 PK	74.0	-21.1	1.21 V	38	40.49	12.41
8	15780.00	39.3 AV	54.0	-14.7	1.21 V	38	26.89	12.41

**REMARKS:**

1. Emission Level(dBuV/m) = Raw Value(dBuV) + Correction Factor(dB/m)
2. Correction Factor(dB/m) = Antenna Factor(dB/m) + Cable Factor(dB) – Pre-Amplifier Factor(dB)
3. The other emission levels were very low against the limit.
4. Margin value = Emission Level – Limit value
5. " \* ": Fundamental frequency.
6. " # ": The radiated frequency is out of the restricted band.

<b>CHANNEL</b>	TX Channel 60	<b>DETECTOR FUNCTION</b>	Peak (PK)
<b>FREQUENCY RANGE</b>	1GHz ~ 40GHz		Average (AV)

**ANTENNA POLARITY & TEST DISTANCE: HORIZONTAL AT 3 M**

NO.	FREQ. (MHz)	EMISSION LEVEL (dBuV/m)	LIMIT (dBuV/m)	MARGIN (dB)	ANTENNA HEIGHT (m)	TABLE ANGLE (Degree)	RAW VALUE (dBuV)	CORRECTION FACTOR (dB/m)
1	*5300.00	104.9 PK			1.13 H	77	103.76	1.14
2	*5300.00	93.9 AV			1.13 H	77	92.76	1.14
3	10600.00	59.0 PK	74.0	-15.0	4.00 H	360	47.66	11.34
4	10600.00	45.6 AV	54.0	-8.4	4.00 H	360	34.26	11.34
5	15900.00	52.8 PK	74.0	-21.2	3.91 H	18	40.30	12.50
6	15900.00	38.5 AV	54.0	-15.5	3.91 H	18	26.00	12.50

**ANTENNA POLARITY & TEST DISTANCE: VERTICAL AT 3 M**

NO.	FREQ. (MHz)	EMISSION LEVEL (dBuV/m)	LIMIT (dBuV/m)	MARGIN (dB)	ANTENNA HEIGHT (m)	TABLE ANGLE (Degree)	RAW VALUE (dBuV)	CORRECTION FACTOR (dB/m)
1	*5300.00	98.1 PK			3.10 V	138	96.96	1.14
2	*5300.00	87.2 AV			3.10 V	138	86.06	1.14
3	10600.00	68.0 PK	74.0	-6.0	3.28 V	151	56.66	11.34
4	10600.00	52.7 AV	54.0	-1.3	3.28 V	151	41.36	11.34
5	15900.00	52.7 PK	74.0	-21.3	1.24 V	48	40.20	12.50
6	15900.00	39.2 AV	54.0	-14.8	1.24 V	48	26.70	12.50

**REMARKS:**

1. Emission Level(dBuV/m) = Raw Value(dBuV) + Correction Factor(dB/m)
2. Correction Factor(dB/m) = Antenna Factor(dB/m) + Cable Factor(dB) – Pre-Amplifier Factor(dB)
3. The other emission levels were very low against the limit.
4. Margin value = Emission Level – Limit value
5. " \* ": Fundamental frequency.

<b>CHANNEL</b>	TX Channel 64	<b>DETECTOR FUNCTION</b>	Peak (PK)
<b>FREQUENCY RANGE</b>	1GHz ~ 40GHz		Average (AV)

**ANTENNA POLARITY & TEST DISTANCE: HORIZONTAL AT 3 M**

NO.	FREQ. (MHz)	EMISSION LEVEL (dBuV/m)	LIMIT (dBuV/m)	MARGIN (dB)	ANTENNA HEIGHT (m)	TABLE ANGLE (Degree)	RAW VALUE (dBuV)	CORRECTION FACTOR (dB/m)
1	*5320.00	104.4 PK			1.00 H	77	103.24	1.16
2	*5320.00	93.5 AV			1.00 H	77	92.34	1.16
3	5350.00	56.6 PK	74.0	-17.4	1.00 H	77	55.42	1.18
4	5350.00	44.2 AV	54.0	-9.8	1.00 H	77	43.02	1.18
5	10640.00	59.0 PK	74.0	-15.0	3.99 H	360	47.65	11.35
6	10640.00	45.6 AV	54.0	-8.4	3.99 H	360	34.25	11.35
7	15960.00	53.1 PK	74.0	-20.9	3.88 H	24	40.69	12.41
8	15960.00	38.8 AV	54.0	-15.2	3.88 H	24	26.39	12.41

**ANTENNA POLARITY & TEST DISTANCE: VERTICAL AT 3 M**

NO.	FREQ. (MHz)	EMISSION LEVEL (dBuV/m)	LIMIT (dBuV/m)	MARGIN (dB)	ANTENNA HEIGHT (m)	TABLE ANGLE (Degree)	RAW VALUE (dBuV)	CORRECTION FACTOR (dB/m)
1	*5320.00	98.0 PK			3.14 V	145	96.84	1.16
2	*5320.00	87.3 AV			3.14 V	145	86.14	1.16
3	5350.00	54.6 PK	74.0	-19.4	3.14 V	145	53.42	1.18
4	5350.00	42.6 AV	54.0	-11.4	3.14 V	145	41.42	1.18
5	10640.00	67.9 PK	74.0	-6.1	3.13 V	154	56.55	11.35
<b>6</b>	<b>10640.00</b>	<b>53.0 AV</b>	<b>54.0</b>	<b>-1.0</b>	<b>3.13 V</b>	<b>154</b>	<b>41.65</b>	<b>11.35</b>
7	15960.00	52.9 PK	74.0	-21.1	1.23 V	38	40.49	12.41
8	15960.00	39.3 AV	54.0	-14.7	1.23 V	38	26.89	12.41

**REMARKS:**

1. Emission Level(dBuV/m) = Raw Value(dBuV) + Correction Factor(dB/m)
2. Correction Factor(dB/m) = Antenna Factor(dB/m) + Cable Factor(dB) – Pre-Amplifier Factor(dB)
3. The other emission levels were very low against the limit.
4. Margin value = Emission Level – Limit value
5. " \* ": Fundamental frequency.

<b>CHANNEL</b>	TX Channel 100	<b>DETECTOR FUNCTION</b>	Peak (PK)
<b>FREQUENCY RANGE</b>	1GHz ~ 40GHz		Average (AV)

**ANTENNA POLARITY & TEST DISTANCE: HORIZONTAL AT 3 M**

NO.	FREQ. (MHz)	EMISSION LEVEL (dBuV/m)	LIMIT (dBuV/m)	MARGIN (dB)	ANTENNA HEIGHT (m)	TABLE ANGLE (Degree)	RAW VALUE (dBuV)	CORRECTION FACTOR (dB/m)
1	#5470.00	70.6 PK	74.0	-3.4	1.08 H	70	69.23	1.37
2	#5470.00	52.9 AV	54.0	-1.1	1.08 H	70	51.53	1.37
3	*5500.00	109.8 PK			1.08 H	70	108.36	1.44
4	*5500.00	98.7 AV			1.08 H	70	97.26	1.44
5	11000.00	60.1 PK	74.0	-13.9	1.20 H	68	47.57	12.53
6	11000.00	46.4 AV	54.0	-7.6	1.20 H	68	33.87	12.53
7	#16500.00	66.5 PK	74.0	-7.5	1.26 H	73	51.05	15.45
8	#16500.00	51.5 AV	54.0	-2.5	1.26 H	73	36.05	15.45

**ANTENNA POLARITY & TEST DISTANCE: VERTICAL AT 3 M**

NO.	FREQ. (MHz)	EMISSION LEVEL (dBuV/m)	LIMIT (dBuV/m)	MARGIN (dB)	ANTENNA HEIGHT (m)	TABLE ANGLE (Degree)	RAW VALUE (dBuV)	CORRECTION FACTOR (dB/m)
1	#5470.00	68.3 PK	74.0	-5.7	3.18 V	155	66.93	1.37
2	#5470.00	50.4 AV	54.0	-3.6	3.18 V	155	49.03	1.37
3	*5500.00	103.4 PK			3.18 V	155	101.96	1.44
4	*5500.00	93.4 AV			3.18 V	155	91.96	1.44
5	11000.00	63.3 PK	74.0	-10.7	2.91 V	155	50.77	12.53
6	11000.00	50.1 AV	54.0	-3.9	2.91 V	155	37.57	12.53
7	#16500.00	60.4 PK	74.0	-13.6	1.21 V	50	44.95	15.45
8	#16500.00	46.5 AV	54.0	-7.5	1.21 V	50	31.05	15.45

**REMARKS:**

1. Emission Level(dBuV/m) = Raw Value(dBuV) + Correction Factor(dB/m)
2. Correction Factor(dB/m) = Antenna Factor(dB/m) + Cable Factor(dB) – Pre-Amplifier Factor(dB)
3. The other emission levels were very low against the limit.
4. Margin value = Emission Level – Limit value
5. " \* ": Fundamental frequency.
6. " # ": The radiated frequency is out of the restricted band.

<b>CHANNEL</b>	TX Channel 116	<b>DETECTOR FUNCTION</b>	Peak (PK)
<b>FREQUENCY RANGE</b>	1GHz ~ 40GHz		Average (AV)

**ANTENNA POLARITY & TEST DISTANCE: HORIZONTAL AT 3 M**

NO.	FREQ. (MHz)	EMISSION LEVEL (dBuV/m)	LIMIT (dBuV/m)	MARGIN (dB)	ANTENNA HEIGHT (m)	TABLE ANGLE (Degree)	RAW VALUE (dBuV)	CORRECTION FACTOR (dB/m)
1	*5580.00	110.2 PK			1.20 H	93	108.68	1.52
2	*5580.00	99.2 AV			1.20 H	93	97.68	1.52
3	11160.00	60.0 PK	74.0	-14.0	1.17 H	78	47.61	12.39
4	11160.00	46.6 AV	54.0	-7.4	1.17 H	78	34.21	12.39
5	#16740.00	66.9 PK	74.0	-7.1	1.22 H	62	50.82	16.08
6	#16740.00	51.6 AV	54.0	-2.4	1.22 H	62	35.52	16.08

**ANTENNA POLARITY & TEST DISTANCE: VERTICAL AT 3 M**

NO.	FREQ. (MHz)	EMISSION LEVEL (dBuV/m)	LIMIT (dBuV/m)	MARGIN (dB)	ANTENNA HEIGHT (m)	TABLE ANGLE (Degree)	RAW VALUE (dBuV)	CORRECTION FACTOR (dB/m)
1	*5580.00	104.6 PK			3.20 V	149	103.08	1.52
2	*5580.00	94.4 AV			3.20 V	149	92.88	1.52
3	11160.00	62.8 PK	74.0	-11.2	3.24 V	163	50.41	12.39
4	11160.00	50.7 AV	54.0	-3.3	3.24 V	163	38.31	12.39
5	#16740.00	60.8 PK	74.0	-13.2	1.20 V	62	44.72	16.08
6	#16740.00	46.9 AV	54.0	-7.1	1.20 V	62	30.82	16.08

**REMARKS:**

1. Emission Level(dBuV/m) = Raw Value(dBuV) + Correction Factor(dB/m)
2. Correction Factor(dB/m) = Antenna Factor(dB/m) + Cable Factor(dB) – Pre-Amplifier Factor(dB)
3. The other emission levels were very low against the limit.
4. Margin value = Emission Level – Limit value
5. " \* ": Fundamental frequency.
6. " # ": The radiated frequency is out of the restricted band.

<b>CHANNEL</b>	TX Channel 140	<b>DETECTOR FUNCTION</b>	Peak (PK)
<b>FREQUENCY RANGE</b>	1GHz ~ 40GHz		Average (AV)

**ANTENNA POLARITY & TEST DISTANCE: HORIZONTAL AT 3 M**

NO.	FREQ. (MHz)	EMISSION LEVEL (dBuV/m)	LIMIT (dBuV/m)	MARGIN (dB)	ANTENNA HEIGHT (m)	TABLE ANGLE (Degree)	RAW VALUE (dBuV)	CORRECTION FACTOR (dB/m)
1	*5700.00	108.2 PK			1.21 H	67	106.55	1.65
2	*5700.00	96.8 AV			1.21 H	67	95.15	1.65
3	#5725.00	67.1 PK	74.0	-6.9	1.21 H	67	65.42	1.68
4	#5725.00	52.9 AV	54.0	-1.1	1.21 H	67	51.22	1.68
5	11400.00	60.3 PK	74.0	-13.7	1.17 H	64	47.73	12.57
6	11400.00	46.8 AV	54.0	-7.2	1.17 H	64	34.23	12.57
7	#17100.00	66.2 PK	74.0	-7.8	1.26 H	67	48.90	17.30
8	#17100.00	51.4 AV	54.0	-2.6	1.26 H	67	34.10	17.30

**ANTENNA POLARITY & TEST DISTANCE: VERTICAL AT 3 M**

NO.	FREQ. (MHz)	EMISSION LEVEL (dBuV/m)	LIMIT (dBuV/m)	MARGIN (dB)	ANTENNA HEIGHT (m)	TABLE ANGLE (Degree)	RAW VALUE (dBuV)	CORRECTION FACTOR (dB/m)
1	*5700.00	102.4 PK			3.20 V	156	100.75	1.65
2	*5700.00	90.4 AV			3.20 V	156	88.75	1.65
3	#5725.00	65.4 PK	74.0	-8.6	3.20 V	156	63.72	1.68
4	#5725.00	50.4 AV	54.0	-3.6	3.20 V	156	48.72	1.68
5	11400.00	63.5 PK	74.0	-10.5	3.55 V	149	50.93	12.57
6	11400.00	50.4 AV	54.0	-3.6	3.55 V	149	37.83	12.57
7	#17100.00	60.1 PK	74.0	-13.9	1.25 V	44	42.80	17.30
8	#17100.00	46.3 AV	54.0	-7.7	1.25 V	44	29.00	17.30

**REMARKS:**

1. Emission Level(dBuV/m) = Raw Value(dBuV) + Correction Factor(dB/m)
2. Correction Factor(dB/m) = Antenna Factor(dB/m) + Cable Factor(dB) – Pre-Amplifier Factor(dB)
3. The other emission levels were very low against the limit.
4. Margin value = Emission Level – Limit value
5. " \* ": Fundamental frequency.
6. " # ": The radiated frequency is out of the restricted band.

<b>CHANNEL</b>	TX Channel 149	<b>DETECTOR FUNCTION</b>	Peak (PK)
<b>FREQUENCY RANGE</b>	1GHz ~ 40GHz		Average (AV)

**ANTENNA POLARITY & TEST DISTANCE: HORIZONTAL AT 3 M**

NO.	FREQ. (MHz)	EMISSION LEVEL (dBuV/m)	LIMIT (dBuV/m)	MARGIN (dB)	ANTENNA HEIGHT (m)	TABLE ANGLE (Degree)	RAW VALUE (dBuV)	CORRECTION FACTOR (dB/m)
1	#5715.00	61.6 PK	109.4	-47.8	1.08 H	70	57.7	3.9
2	#5725.00	72.8 PK	122.2	-49.4	1.08 H	70	68.9	3.9
3	*5745.00	107.2 PK			1.08 H	70	103.2	4.0
4	*5745.00	95.6 AV			1.08 H	70	91.6	4.0
5	11490.00	67.1 PK	74.0	-6.9	1.20 H	66	54.3	12.8
6	11490.00	52.7 AV	54.0	-1.3	1.20 H	66	39.9	12.8
7	#17235.00	58.8 PK	74.0	-15.2	1.22 H	60	41.4	17.4
8	#17235.00	46.9 AV	54.0	-7.1	1.22 H	60	29.5	17.4

**ANTENNA POLARITY & TEST DISTANCE: VERTICAL AT 3 M**

NO.	FREQ. (MHz)	EMISSION LEVEL (dBuV/m)	LIMIT (dBuV/m)	MARGIN (dB)	ANTENNA HEIGHT (m)	TABLE ANGLE (Degree)	RAW VALUE (dBuV)	CORRECTION FACTOR (dB/m)
1	#5715.00	59.9 PK	109.4	-49.5	3.19 V	166	56.0	3.9
2	#5725.00	70.4 PK	122.2	-51.8	3.19 V	166	66.5	3.9
3	*5745.00	101.3 PK			3.19 V	166	97.3	4.0
4	*5745.00	90.4 AV			3.19 V	166	86.4	4.0
5	11490.00	64.2 PK	74.0	-9.8	3.90 V	104	51.4	12.8
6	11490.00	50.8 AV	54.0	-3.2	3.90 V	104	38.0	12.8
7	#17235.00	66.5 PK	74.0	-7.5	2.97 V	266	49.1	17.4
8	#17235.00	48.9 AV	54.0	-5.1	2.97 V	266	31.5	17.4

**REMARKS:**

1. Emission Level(dBuV/m) = Raw Value(dBuV) + Correction Factor(dB/m)
2. Correction Factor(dB/m) = Antenna Factor(dB/m) + Cable Factor(dB) – Pre-Amplifier Factor(dB)
3. The other emission levels were very low against the limit.
4. Margin value = Emission Level – Limit value
5. " \* ": Fundamental frequency.
6. " # ": The radiated frequency is out of the restricted band.

<b>CHANNEL</b>	TX Channel 157	<b>DETECTOR FUNCTION</b>	Peak (PK)
<b>FREQUENCY RANGE</b>	1GHz ~ 40GHz		Average (AV)

**ANTENNA POLARITY & TEST DISTANCE: HORIZONTAL AT 3 M**

NO.	FREQ. (MHz)	EMISSION LEVEL (dBuV/m)	LIMIT (dBuV/m)	MARGIN (dB)	ANTENNA HEIGHT (m)	TABLE ANGLE (Degree)	RAW VALUE (dBuV)	CORRECTION FACTOR (dB/m)
1	*5785.00	107.3 PK			1.08 H	68	103.3	4.0
2	*5785.00	95.3 AV			1.08 H	68	91.3	4.0
3	11570.00	67.4 PK	74.0	-6.6	1.23 H	64	54.8	12.6
4	11570.00	52.7 AV	54.0	-1.3	1.23 H	64	40.1	12.6
5	#17355.00	58.9 PK	74.0	-15.1	1.26 H	76	40.8	18.1
6	#17355.00	46.7 AV	54.0	-7.3	1.26 H	76	28.6	18.1

**ANTENNA POLARITY & TEST DISTANCE: VERTICAL AT 3 M**

NO.	FREQ. (MHz)	EMISSION LEVEL (dBuV/m)	LIMIT (dBuV/m)	MARGIN (dB)	ANTENNA HEIGHT (m)	TABLE ANGLE (Degree)	RAW VALUE (dBuV)	CORRECTION FACTOR (dB/m)
1	*5785.00	101.4 PK			3.20 V	151	97.4	4.0
2	*5785.00	90.1 AV			3.20 V	151	86.1	4.0
3	11570.00	64.9 PK	74.0	-9.1	3.95 V	119	52.3	12.6
4	11570.00	51.2 AV	54.0	-2.8	3.95 V	119	38.6	12.6
5	#17355.00	66.5 PK	74.0	-7.5	2.95 V	279	48.4	18.1
6	#17355.00	48.7 AV	54.0	-5.3	2.95 V	279	30.6	18.1

**REMARKS:**

1. Emission Level(dBuV/m) = Raw Value(dBuV) + Correction Factor(dB/m)
2. Correction Factor(dB/m) = Antenna Factor(dB/m) + Cable Factor(dB) – Pre-Amplifier Factor(dB)
3. The other emission levels were very low against the limit.
4. Margin value = Emission Level – Limit value
5. " \* ": Fundamental frequency.
6. " # ": The radiated frequency is out of the restricted band.



<b>CHANNEL</b>	TX Channel 165	<b>DETECTOR FUNCTION</b>	Peak (PK)
<b>FREQUENCY RANGE</b>	1GHz ~ 40GHz		Average (AV)

**ANTENNA POLARITY & TEST DISTANCE: HORIZONTAL AT 3 M**

NO.	FREQ. (MHz)	EMISSION LEVEL (dBuV/m)	LIMIT (dBuV/m)	MARGIN (dB)	ANTENNA HEIGHT (m)	TABLE ANGLE (Degree)	RAW VALUE (dBuV)	CORRECTION FACTOR (dB/m)
1	*5825.00	106.6 PK			1.09 H	67	102.5	4.1
2	*5825.00	94.9 AV			1.09 H	67	90.8	4.1
3	#5850.00	59.2 PK	122.2	-63.0	1.09 H	67	55.1	4.1
4	#5860.00	56.2 PK	109.4	-53.2	1.09 H	67	52.0	4.2
5	11650.00	67.1 PK	74.0	-6.9	1.24 H	64	54.4	12.7
6	11650.00	52.7 AV	54.0	-1.3	1.24 H	64	40.0	12.7
7	#17475.00	58.4 PK	74.0	-15.6	1.18 H	75	39.5	18.9
8	#17475.00	46.6 AV	54.0	-7.4	1.18 H	75	27.7	18.9

**ANTENNA POLARITY & TEST DISTANCE: VERTICAL AT 3 M**

NO.	FREQ. (MHz)	EMISSION LEVEL (dBuV/m)	LIMIT (dBuV/m)	MARGIN (dB)	ANTENNA HEIGHT (m)	TABLE ANGLE (Degree)	RAW VALUE (dBuV)	CORRECTION FACTOR (dB/m)
1	*5825.00	100.5 PK			3.19 V	145	96.4	4.1
2	*5825.00	89.3 AV			3.19 V	145	85.2	4.1
3	#5850.00	58.3 PK	122.2	-63.9	3.19 V	145	54.2	4.1
4	#5860.00	50.2 PK	109.4	-59.2	3.19 V	145	46.0	4.2
5	11650.00	64.3 PK	74.0	-9.7	3.93 V	104	51.6	12.7
6	11650.00	50.8 AV	54.0	-3.2	3.93 V	104	38.1	12.7
7	#17475.00	66.7 PK	74.0	-7.3	2.98 V	278	47.8	18.9
8	#17475.00	49.0 AV	54.0	-5.0	2.98 V	278	30.1	18.9

**REMARKS:**

1. Emission Level(dBuV/m) = Raw Value(dBuV) + Correction Factor(dB/m)
2. Correction Factor(dB/m) = Antenna Factor(dB/m) + Cable Factor(dB) – Pre-Amplifier Factor(dB)
3. The other emission levels were very low against the limit.
4. Margin value = Emission Level – Limit value
5. " \* ": Fundamental frequency.
6. " # ": The radiated frequency is out of the restricted band.

**802.11n (HT20)**

<b>CHANNEL</b>	TX Channel 36	<b>DETECTOR FUNCTION</b>	Peak (PK)
<b>FREQUENCY RANGE</b>	1GHz ~ 40GHz		Average (AV)

**ANTENNA POLARITY & TEST DISTANCE: HORIZONTAL AT 3 M**

NO.	FREQ. (MHz)	EMISSION LEVEL (dBuV/m)	LIMIT (dBuV/m)	MARGIN (dB)	ANTENNA HEIGHT (m)	TABLE ANGLE (Degree)	RAW VALUE (dBuV)	CORRECTION FACTOR (dB/m)
1	5150.00	55.3 PK	74.0	-18.7	1.12 H	90	54.66	0.64
2	5150.00	41.8 AV	54.0	-12.2	1.12 H	90	41.16	0.64
3	*5180.00	102.9 PK			1.12 H	90	102.17	0.73
4	*5180.00	91.4 AV			1.12 H	90	90.67	0.73
5	#10360.00	59.1 PK	74.0	-14.9	1.15 H	104	48.35	10.75
6	#10360.00	45.1 AV	54.0	-8.9	1.15 H	104	34.35	10.75
7	15540.00	52.9 PK	74.0	-21.1	1.31 H	65	39.75	13.15
8	15540.00	39.8 AV	54.0	-14.2	1.31 H	65	26.65	13.15

**ANTENNA POLARITY & TEST DISTANCE: VERTICAL AT 3 M**

NO.	FREQ. (MHz)	EMISSION LEVEL (dBuV/m)	LIMIT (dBuV/m)	MARGIN (dB)	ANTENNA HEIGHT (m)	TABLE ANGLE (Degree)	RAW VALUE (dBuV)	CORRECTION FACTOR (dB/m)
1	5150.00	54.3 PK	74.0	-19.7	3.20 V	150	53.66	0.64
2	5150.00	40.6 AV	54.0	-13.4	3.20 V	150	39.96	0.64
3	*5180.00	98.0 PK			3.20 V	150	97.27	0.73
4	*5180.00	86.9 AV			3.20 V	150	86.17	0.73
5	#10360.00	68.5 PK	74.0	-5.5	3.50 V	147	57.75	10.75
6	#10360.00	52.8 AV	54.0	-1.2	3.50 V	147	42.05	10.75
7	15540.00	52.7 PK	74.0	-21.3	1.30 V	64	39.55	13.15
8	15540.00	39.5 AV	54.0	-14.5	1.30 V	64	26.35	13.15

**REMARKS:**

- Emission Level(dBuV/m) = Raw Value(dBuV) + Correction Factor(dB/m)
- Correction Factor(dB/m) = Antenna Factor(dB/m) + Cable Factor(dB) – Pre-Amplifier Factor(dB)
- The other emission levels were very low against the limit.
- Margin value = Emission Level – Limit value
- " \* ": Fundamental frequency.
- " # ": The radiated frequency is out of the restricted band.



<b>CHANNEL</b>	TX Channel 40	<b>DETECTOR FUNCTION</b>	Peak (PK)
<b>FREQUENCY RANGE</b>	1GHz ~ 40GHz		Average (AV)

**ANTENNA POLARITY & TEST DISTANCE: HORIZONTAL AT 3 M**

NO.	FREQ. (MHz)	EMISSION LEVEL (dBuV/m)	LIMIT (dBuV/m)	MARGIN (dB)	ANTENNA HEIGHT (m)	TABLE ANGLE (Degree)	RAW VALUE (dBuV)	CORRECTION FACTOR (dB/m)
1	*5200.00	103.0 PK			1.12 H	75	102.21	0.79
2	*5200.00	91.7 AV			1.12 H	75	90.91	0.79
3	#10400.00	59.6 PK	74.0	-14.4	1.15 H	101	48.50	11.10
4	#10400.00	45.3 AV	54.0	-8.7	1.15 H	101	34.20	11.10
5	15600.00	53.0 PK	74.0	-21.0	1.32 H	73	39.78	13.22
6	15600.00	39.7 AV	54.0	-14.3	1.32 H	73	26.48	13.22

**ANTENNA POLARITY & TEST DISTANCE: VERTICAL AT 3 M**

NO.	FREQ. (MHz)	EMISSION LEVEL (dBuV/m)	LIMIT (dBuV/m)	MARGIN (dB)	ANTENNA HEIGHT (m)	TABLE ANGLE (Degree)	RAW VALUE (dBuV)	CORRECTION FACTOR (dB/m)
1	*5200.00	98.0 PK			3.16 V	162	97.21	0.79
2	*5200.00	87.0 AV			3.16 V	162	86.21	0.79
3	#10400.00	67.8 PK	74.0	-6.2	3.54 V	145	56.70	11.10
4	#10400.00	52.3 AV	54.0	-1.7	3.54 V	145	41.20	11.10
5	15600.00	51.5 PK	74.0	-22.5	1.36 V	71	38.28	13.22
6	15600.00	39.0 AV	54.0	-15.0	1.36 V	71	25.78	13.22

**REMARKS:**

1. Emission Level(dBuV/m) = Raw Value(dBuV) + Correction Factor(dB/m)
2. Correction Factor(dB/m) = Antenna Factor(dB/m) + Cable Factor(dB) – Pre-Amplifier Factor(dB)
3. The other emission levels were very low against the limit.
4. Margin value = Emission Level – Limit value
5. " \* ": Fundamental frequency.
6. " # ": The radiated frequency is out of the restricted band.

<b>CHANNEL</b>	TX Channel 48	<b>DETECTOR FUNCTION</b>	Peak (PK)
<b>FREQUENCY RANGE</b>	1GHz ~ 40GHz		Average (AV)

**ANTENNA POLARITY & TEST DISTANCE: HORIZONTAL AT 3 M**

NO.	FREQ. (MHz)	EMISSION LEVEL (dBuV/m)	LIMIT (dBuV/m)	MARGIN (dB)	ANTENNA HEIGHT (m)	TABLE ANGLE (Degree)	RAW VALUE (dBuV)	CORRECTION FACTOR (dB/m)
1	*5240.00	102.8 PK			1.11 H	91	101.88	0.92
2	*5240.00	91.5 AV			1.11 H	91	90.58	0.92
3	5396.00	52.2 PK	74.0	-21.8	1.11 H	91	50.99	1.21
4	5396.00	39.0 AV	54.0	-15.0	1.11 H	91	37.79	1.21
5	#10480.00	59.0 PK	74.0	-15.0	1.11 H	112	48.06	10.94
6	#10480.00	45.0 AV	54.0	-9.0	1.11 H	112	34.06	10.94
7	15720.00	53.2 PK	74.0	-20.8	1.33 H	76	40.67	12.53
8	15720.00	40.1 AV	54.0	-13.9	1.33 H	76	27.57	12.53

**ANTENNA POLARITY & TEST DISTANCE: VERTICAL AT 3 M**

NO.	FREQ. (MHz)	EMISSION LEVEL (dBuV/m)	LIMIT (dBuV/m)	MARGIN (dB)	ANTENNA HEIGHT (m)	TABLE ANGLE (Degree)	RAW VALUE (dBuV)	CORRECTION FACTOR (dB/m)
1	*5240.00	98.0 PK			3.16 V	153	97.08	0.92
2	*5240.00	86.6 AV			3.16 V	153	85.68	0.92
3	5396.00	50.3 PK	74.0	-23.7	3.16 V	153	49.09	1.21
4	5396.00	37.4 AV	54.0	-16.6	3.16 V	153	36.19	1.21
5	#10480.00	68.0 PK	74.0	-6.0	3.50 V	149	57.06	10.94
6	#10480.00	52.4 AV	54.0	-1.6	3.50 V	149	41.46	10.94
7	15720.00	52.1 PK	74.0	-21.9	1.32 V	70	39.57	12.53
8	15720.00	39.4 AV	54.0	-14.6	1.32 V	70	26.87	12.53

**REMARKS:**

1. Emission Level(dBuV/m) = Raw Value(dBuV) + Correction Factor(dB/m)
2. Correction Factor(dB/m) = Antenna Factor(dB/m) + Cable Factor(dB) – Pre-Amplifier Factor(dB)
3. The other emission levels were very low against the limit.
4. Margin value = Emission Level – Limit value
5. " \* ": Fundamental frequency.
6. " # ": The radiated frequency is out of the restricted band.



<b>CHANNEL</b>	TX Channel 52	<b>DETECTOR FUNCTION</b>	Peak (PK)
<b>FREQUENCY RANGE</b>	1GHz ~ 40GHz		Average (AV)

**ANTENNA POLARITY & TEST DISTANCE: HORIZONTAL AT 3 M**

NO.	FREQ. (MHz)	EMISSION LEVEL (dBuV/m)	LIMIT (dBuV/m)	MARGIN (dB)	ANTENNA HEIGHT (m)	TABLE ANGLE (Degree)	RAW VALUE (dBuV)	CORRECTION FACTOR (dB/m)
1	5150.00	52.7 PK	74.0	-21.3	1.11 H	89	52.06	0.64
2	5150.00	38.2 AV	54.0	-15.8	1.11 H	89	37.56	0.64
3	*5260.00	103.4 PK			1.11 H	89	102.39	1.01
4	*5260.00	91.4 AV			1.11 H	89	90.39	1.01
5	#10520.00	59.1 PK	74.0	-14.9	1.10 H	105	48.11	10.99
6	#10520.00	45.3 AV	54.0	-8.7	1.10 H	105	34.31	10.99
7	15780.00	53.3 PK	74.0	-20.7	1.36 H	52	40.89	12.41
8	15780.00	40.2 AV	54.0	-13.8	1.36 H	52	27.79	12.41

**ANTENNA POLARITY & TEST DISTANCE: VERTICAL AT 3 M**

NO.	FREQ. (MHz)	EMISSION LEVEL (dBuV/m)	LIMIT (dBuV/m)	MARGIN (dB)	ANTENNA HEIGHT (m)	TABLE ANGLE (Degree)	RAW VALUE (dBuV)	CORRECTION FACTOR (dB/m)
1	5150.00	52.1 PK	74.0	-21.9	3.17 V	164	51.46	0.64
2	5150.00	37.2 AV	54.0	-16.8	3.17 V	164	36.56	0.64
3	*5260.00	98.1 PK			3.17 V	164	97.09	1.01
4	*5260.00	86.8 AV			3.17 V	164	85.79	1.01
5	#10520.00	67.2 PK	74.0	-6.8	3.13 V	146	56.21	10.99
6	#10520.00	52.2 AV	54.0	-1.8	3.13 V	146	41.21	10.99
7	15780.00	52.0 PK	74.0	-22.0	1.30 V	68	39.59	12.41
8	15780.00	39.5 AV	54.0	-14.5	1.30 V	68	27.09	12.41

**REMARKS:**

1. Emission Level(dBuV/m) = Raw Value(dBuV) + Correction Factor(dB/m)
2. Correction Factor(dB/m) = Antenna Factor(dB/m) + Cable Factor(dB) – Pre-Amplifier Factor(dB)
3. The other emission levels were very low against the limit.
4. Margin value = Emission Level – Limit value
5. " \* ": Fundamental frequency.
6. " # ": The radiated frequency is out of the restricted band.



<b>CHANNEL</b>	TX Channel 60	<b>DETECTOR FUNCTION</b>	Peak (PK)
<b>FREQUENCY RANGE</b>	1GHz ~ 40GHz		Average (AV)

**ANTENNA POLARITY & TEST DISTANCE: HORIZONTAL AT 3 M**

NO.	FREQ. (MHz)	EMISSION LEVEL (dBuV/m)	LIMIT (dBuV/m)	MARGIN (dB)	ANTENNA HEIGHT (m)	TABLE ANGLE (Degree)	RAW VALUE (dBuV)	CORRECTION FACTOR (dB/m)
1	*5300.00	103.5 PK			1.13 H	75	102.36	1.14
2	*5300.00	91.9 AV			1.13 H	75	90.76	1.14
3	10600.00	59.6 PK	74.0	-14.4	1.14 H	116	48.26	11.34
4	10600.00	45.6 AV	54.0	-8.4	1.14 H	116	34.26	11.34
5	15900.00	53.5 PK	74.0	-20.5	1.28 H	72	41.00	12.50
6	15900.00	40.2 AV	54.0	-13.8	1.28 H	72	27.70	12.50

**ANTENNA POLARITY & TEST DISTANCE: VERTICAL AT 3 M**

NO.	FREQ. (MHz)	EMISSION LEVEL (dBuV/m)	LIMIT (dBuV/m)	MARGIN (dB)	ANTENNA HEIGHT (m)	TABLE ANGLE (Degree)	RAW VALUE (dBuV)	CORRECTION FACTOR (dB/m)
1	*5300.00	98.4 PK			3.20 V	165	97.26	1.14
2	*5300.00	86.9 AV			3.20 V	165	85.76	1.14
3	10600.00	66.3 PK	74.0	-7.7	3.22 V	154	54.96	11.34
4	10600.00	52.6 AV	54.0	-1.4	3.22 V	154	41.26	11.34
5	15900.00	51.9 PK	74.0	-22.1	1.32 V	72	39.40	12.50
6	15900.00	39.2 AV	54.0	-14.8	1.32 V	72	26.70	12.50

**REMARKS:**

1. Emission Level(dBuV/m) = Raw Value(dBuV) + Correction Factor(dB/m)
2. Correction Factor(dB/m) = Antenna Factor(dB/m) + Cable Factor(dB) – Pre-Amplifier Factor(dB)
3. The other emission levels were very low against the limit.
4. Margin value = Emission Level – Limit value
5. " \* ": Fundamental frequency.



<b>CHANNEL</b>	TX Channel 64	<b>DETECTOR FUNCTION</b>	Peak (PK)
<b>FREQUENCY RANGE</b>	1GHz ~ 40GHz		Average (AV)

**ANTENNA POLARITY & TEST DISTANCE: HORIZONTAL AT 3 M**

NO.	FREQ. (MHz)	EMISSION LEVEL (dBuV/m)	LIMIT (dBuV/m)	MARGIN (dB)	ANTENNA HEIGHT (m)	TABLE ANGLE (Degree)	RAW VALUE (dBuV)	CORRECTION FACTOR (dB/m)
1	*5320.00	103.9 PK			1.13 H	70	102.74	1.16
2	*5320.00	92.3 AV			1.13 H	70	91.14	1.16
3	5350.00	56.8 PK	74.0	-17.2	1.13 H	70	55.62	1.18
4	5350.00	42.8 AV	54.0	-11.2	1.13 H	70	41.62	1.18
5	10640.00	59.1 PK	74.0	-14.9	1.12 H	103	47.75	11.35
6	10640.00	45.4 AV	54.0	-8.6	1.12 H	103	34.05	11.35
7	15960.00	53.7 PK	74.0	-20.3	1.40 H	57	41.29	12.41
8	15960.00	40.4 AV	54.0	-13.6	1.40 H	57	27.99	12.41

**ANTENNA POLARITY & TEST DISTANCE: VERTICAL AT 3 M**

NO.	FREQ. (MHz)	EMISSION LEVEL (dBuV/m)	LIMIT (dBuV/m)	MARGIN (dB)	ANTENNA HEIGHT (m)	TABLE ANGLE (Degree)	RAW VALUE (dBuV)	CORRECTION FACTOR (dB/m)
1	*5320.00	98.8 PK			3.14 V	152	97.64	1.16
2	*5320.00	87.3 AV			3.14 V	152	86.14	1.16
3	5350.00	54.3 PK	74.0	-19.7	3.14 V	152	53.12	1.18
4	5350.00	40.3 AV	54.0	-13.7	3.14 V	152	39.12	1.18
5	10640.00	66.1 PK	74.0	-7.9	3.17 V	154	54.75	11.35
6	10640.00	52.5 AV	54.0	-1.5	3.17 V	154	41.15	11.35
7	15960.00	52.4 PK	74.0	-21.6	1.37 V	69	39.99	12.41
8	15960.00	39.7 AV	54.0	-14.3	1.37 V	69	27.29	12.41

**REMARKS:**

1. Emission Level(dBuV/m) = Raw Value(dBuV) + Correction Factor(dB/m)
2. Correction Factor(dB/m) = Antenna Factor(dB/m) + Cable Factor(dB) – Pre-Amplifier Factor(dB)
3. The other emission levels were very low against the limit.
4. Margin value = Emission Level – Limit value
5. " \* ": Fundamental frequency.

<b>CHANNEL</b>	TX Channel 100	<b>DETECTOR FUNCTION</b>	Peak (PK)
<b>FREQUENCY RANGE</b>	1GHz ~ 40GHz		Average (AV)

**ANTENNA POLARITY & TEST DISTANCE: HORIZONTAL AT 3 M**

NO.	FREQ. (MHz)	EMISSION LEVEL (dBuV/m)	LIMIT (dBuV/m)	MARGIN (dB)	ANTENNA HEIGHT (m)	TABLE ANGLE (Degree)	RAW VALUE (dBuV)	CORRECTION FACTOR (dB/m)
1	#5470.00	70.3 PK	74.0	-3.7	1.13 H	68	68.93	1.37
2	#5470.00	52.9 AV	54.0	-1.1	1.13 H	68	51.53	1.37
3	*5500.00	108.8 PK			1.13 H	68	107.36	1.44
4	*5500.00	97.6 AV			1.13 H	68	96.16	1.44
5	11000.00	59.3 PK	74.0	-14.7	1.24 H	67	46.77	12.53
6	11000.00	45.9 AV	54.0	-8.1	1.24 H	67	33.37	12.53
7	#16500.00	60.1 PK	74.0	-13.9	1.23 H	81	44.65	15.45
8	#16500.00	46.5 AV	54.0	-7.5	1.23 H	81	31.05	15.45

**ANTENNA POLARITY & TEST DISTANCE: VERTICAL AT 3 M**

NO.	FREQ. (MHz)	EMISSION LEVEL (dBuV/m)	LIMIT (dBuV/m)	MARGIN (dB)	ANTENNA HEIGHT (m)	TABLE ANGLE (Degree)	RAW VALUE (dBuV)	CORRECTION FACTOR (dB/m)
1	#5470.00	68.8 PK	74.0	-5.2	3.09 V	0	67.43	1.37
2	#5470.00	50.4 AV	54.0	-3.6	3.09 V	0	49.03	1.37
3	*5500.00	106.6 PK			3.09 V	157	105.16	1.44
4	*5500.00	95.4 AV			3.09 V	157	93.96	1.44
5	11000.00	64.4 PK	74.0	-9.6	3.09 V	149	51.87	12.53
6	11000.00	51.3 AV	54.0	-2.7	3.09 V	149	38.77	12.53
7	#16500.00	61.6 PK	74.0	-12.4	2.70 V	152	46.15	15.45
8	#16500.00	46.4 AV	54.0	-7.6	2.70 V	152	30.95	15.45

**REMARKS:**

1. Emission Level(dBuV/m) = Raw Value(dBuV) + Correction Factor(dB/m)
2. Correction Factor(dB/m) = Antenna Factor(dB/m) + Cable Factor(dB) – Pre-Amplifier Factor(dB)
3. The other emission levels were very low against the limit.
4. Margin value = Emission Level – Limit value
5. " \* ": Fundamental frequency.
6. " # ": The radiated frequency is out of the restricted band.





<b>CHANNEL</b>	TX Channel 116	<b>DETECTOR FUNCTION</b>	Peak (PK)
<b>FREQUENCY RANGE</b>	1GHz ~ 40GHz		Average (AV)

**ANTENNA POLARITY & TEST DISTANCE: HORIZONTAL AT 3 M**

NO.	FREQ. (MHz)	EMISSION LEVEL (dBuV/m)	LIMIT (dBuV/m)	MARGIN (dB)	ANTENNA HEIGHT (m)	TABLE ANGLE (Degree)	RAW VALUE (dBuV)	CORRECTION FACTOR (dB/m)
1	*5580.00	110.9 PK			1.14 H	67	109.38	1.52
2	*5580.00	99.2 AV			1.14 H	67	97.68	1.52
3	11160.00	61.2 PK	74.0	-12.8	1.26 H	78	48.81	12.39
4	11160.00	47.2 AV	54.0	-6.8	1.26 H	78	34.81	12.39
5	#16740.00	58.4 PK	74.0	-15.6	1.18 H	80	42.32	16.08
6	#16740.00	46.1 AV	54.0	-7.9	1.18 H	80	30.02	16.08

**ANTENNA POLARITY & TEST DISTANCE: VERTICAL AT 3 M**

NO.	FREQ. (MHz)	EMISSION LEVEL (dBuV/m)	LIMIT (dBuV/m)	MARGIN (dB)	ANTENNA HEIGHT (m)	TABLE ANGLE (Degree)	RAW VALUE (dBuV)	CORRECTION FACTOR (dB/m)
1	*5580.00	108.4 PK			3.06 V	172	106.88	1.52
2	*5580.00	97.4 AV			3.06 V	172	95.88	1.52
3	11160.00	66.2 PK	74.0	-7.8	3.33 V	149	53.81	12.39
4	11160.00	52.6 AV	54.0	-1.4	3.33 V	149	40.21	12.39
5	#16740.00	58.9 PK	74.0	-15.1	2.70 V	94	42.82	16.08
6	#16740.00	46.0 AV	54.0	-8.0	2.70 V	94	29.92	16.08

**REMARKS:**

1. Emission Level(dBuV/m) = Raw Value(dBuV) + Correction Factor(dB/m)
2. Correction Factor(dB/m) = Antenna Factor(dB/m) + Cable Factor(dB) – Pre-Amplifier Factor(dB)
3. The other emission levels were very low against the limit.
4. Margin value = Emission Level – Limit value
5. " \* ": Fundamental frequency.
6. " # ": The radiated frequency is out of the restricted band.

<b>CHANNEL</b>	TX Channel 140	<b>DETECTOR FUNCTION</b>	Peak (PK)
<b>FREQUENCY RANGE</b>	1GHz ~ 40GHz		Average (AV)

**ANTENNA POLARITY & TEST DISTANCE: HORIZONTAL AT 3 M**

NO.	FREQ. (MHz)	EMISSION LEVEL (dBuV/m)	LIMIT (dBuV/m)	MARGIN (dB)	ANTENNA HEIGHT (m)	TABLE ANGLE (Degree)	RAW VALUE (dBuV)	CORRECTION FACTOR (dB/m)
1	*5700.00	108.4 PK			1.08 H	86	106.75	1.65
2	*5700.00	96.5 AV			1.08 H	86	94.85	1.65
3	#5725.00	65.9 PK	74.0	-8.1	1.08 H	86	64.22	1.68
4	#5725.00	52.8 AV	54.0	-1.2	1.08 H	86	51.12	1.68
5	11400.00	59.3 PK	74.0	-14.7	1.25 H	79	46.73	12.57
6	11400.00	46.3 AV	54.0	-7.7	1.25 H	79	33.73	12.57
7	#17100.00	61.8 PK	74.0	-12.2	1.16 H	72	44.50	17.30
8	#17100.00	47.3 AV	54.0	-6.7	1.16 H	72	30.00	17.30

**ANTENNA POLARITY & TEST DISTANCE: VERTICAL AT 3 M**

NO.	FREQ. (MHz)	EMISSION LEVEL (dBuV/m)	LIMIT (dBuV/m)	MARGIN (dB)	ANTENNA HEIGHT (m)	TABLE ANGLE (Degree)	RAW VALUE (dBuV)	CORRECTION FACTOR (dB/m)
1	*5700.00	106.6 PK			3.10 V	177	104.95	1.65
2	*5700.00	94.3 AV			3.10 V	177	92.65	1.65
3	#5725.00	63.3 PK	74.0	-10.7	3.10 V	177	61.62	1.68
4	#5725.00	50.4 AV	54.0	-3.6	3.10 V	177	48.72	1.68
5	11400.00	64.2 PK	74.0	-9.8	3.33 V	104	51.63	12.57
6	11400.00	51.6 AV	54.0	-2.4	3.33 V	104	39.03	12.57
7	#17100.00	62.3 PK	74.0	-11.7	3.03 V	264	45.00	17.30
8	#17100.00	47.4 AV	54.0	-6.6	3.03 V	264	30.10	17.30

**REMARKS:**

1. Emission Level(dBuV/m) = Raw Value(dBuV) + Correction Factor(dB/m)
2. Correction Factor(dB/m) = Antenna Factor(dB/m) + Cable Factor(dB) – Pre-Amplifier Factor(dB)
3. The other emission levels were very low against the limit.
4. Margin value = Emission Level – Limit value
5. " \* ": Fundamental frequency.
6. " # ": The radiated frequency is out of the restricted band.

<b>CHANNEL</b>	TX Channel 149	<b>DETECTOR FUNCTION</b>	Peak (PK)
<b>FREQUENCY RANGE</b>	1GHz ~ 40GHz		Average (AV)

**ANTENNA POLARITY & TEST DISTANCE: HORIZONTAL AT 3 M**

NO.	FREQ. (MHz)	EMISSION LEVEL (dBuV/m)	LIMIT (dBuV/m)	MARGIN (dB)	ANTENNA HEIGHT (m)	TABLE ANGLE (Degree)	RAW VALUE (dBuV)	CORRECTION FACTOR (dB/m)
1	#5715.00	62.2 PK	109.4	-47.2	1.10 H	85	58.3	3.9
2	#5725.00	73.1 PK	122.2	-49.1	1.10 H	85	69.2	3.9
3	*5745.00	106.3 PK			1.10 H	85	102.3	4.0
4	*5745.00	94.7 AV			1.10 H	85	90.7	4.0
5	11490.00	66.5 PK	74.0	-7.5	3.45 H	105	53.7	12.8
<b>6</b>	<b>11490.00</b>	<b>52.7 AV</b>	<b>54.0</b>	<b>-1.3</b>	<b>3.45 H</b>	<b>105</b>	<b>39.9</b>	<b>12.8</b>
7	#17235.00	58.9 PK	74.0	-15.1	3.20 H	268	41.5	17.4
8	#17235.00	46.7 AV	54.0	-7.3	3.20 H	268	29.3	17.4

**ANTENNA POLARITY & TEST DISTANCE: VERTICAL AT 3 M**

NO.	FREQ. (MHz)	EMISSION LEVEL (dBuV/m)	LIMIT (dBuV/m)	MARGIN (dB)	ANTENNA HEIGHT (m)	TABLE ANGLE (Degree)	RAW VALUE (dBuV)	CORRECTION FACTOR (dB/m)
1	#5715.00	61.1 PK	109.4	-48.3	3.00 V	178	57.2	3.9
2	#5725.00	71.4 PK	122.2	-50.8	3.00 V	178	67.5	3.9
3	*5745.00	104.4 PK			3.00 V	178	100.4	4.0
4	*5745.00	92.2 AV			3.00 V	178	88.2	4.0
5	11490.00	61.6 PK	74.0	-12.4	1.32 V	68	48.8	12.8
6	11490.00	46.0 AV	54.0	-8.0	1.32 V	68	33.2	12.8
7	#17235.00	58.3 PK	74.0	-15.7	1.23 V	89	40.9	17.4
8	#17235.00	46.5 AV	54.0	-7.5	1.23 V	89	29.1	17.4

**REMARKS:**

1. Emission Level(dBuV/m) = Raw Value(dBuV) + Correction Factor(dB/m)
2. Correction Factor(dB/m) = Antenna Factor(dB/m) + Cable Factor(dB) – Pre-Amplifier Factor(dB)
3. The other emission levels were very low against the limit.
4. Margin value = Emission Level – Limit value
5. " \* ": Fundamental frequency.
6. " # ": The radiated frequency is out of the restricted band.

<b>CHANNEL</b>	TX Channel 157	<b>DETECTOR FUNCTION</b>	Peak (PK)
<b>FREQUENCY RANGE</b>	1GHz ~ 40GHz		Average (AV)

**ANTENNA POLARITY & TEST DISTANCE: HORIZONTAL AT 3 M**

NO.	FREQ. (MHz)	EMISSION LEVEL (dBuV/m)	LIMIT (dBuV/m)	MARGIN (dB)	ANTENNA HEIGHT (m)	TABLE ANGLE (Degree)	RAW VALUE (dBuV)	CORRECTION FACTOR (dB/m)
1	*5785.00	105.8 PK			1.11 H	83	101.8	4.0
2	*5785.00	94.2 AV			1.11 H	83	90.2	4.0
3	11570.00	65.2 PK	74.0	-8.8	3.30 H	107	52.6	12.6
4	11570.00	52.6 AV	54.0	-1.4	3.30 H	107	40.0	12.6
5	#17355.00	58.1 PK	74.0	-15.9	3.21 H	266	40.0	18.1
6	#17355.00	45.6 AV	54.0	-8.4	3.21 H	266	27.5	18.1

**ANTENNA POLARITY & TEST DISTANCE: VERTICAL AT 3 M**

NO.	FREQ. (MHz)	EMISSION LEVEL (dBuV/m)	LIMIT (dBuV/m)	MARGIN (dB)	ANTENNA HEIGHT (m)	TABLE ANGLE (Degree)	RAW VALUE (dBuV)	CORRECTION FACTOR (dB/m)
1	*5785.00	104.4 PK			2.98 V	169	100.4	4.0
2	*5785.00	92.0 AV			2.98 V	169	88.0	4.0
3	11570.00	60.4 PK	74.0	-13.6	1.25 V	64	47.8	12.6
4	11570.00	46.9 AV	54.0	-7.1	1.25 V	64	34.3	12.6
5	#17355.00	58.3 PK	74.0	-15.7	1.21 V	83	40.2	18.1
6	#17355.00	45.9 AV	54.0	-8.1	1.21 V	83	27.8	18.1

**REMARKS:**

1. Emission Level(dBuV/m) = Raw Value(dBuV) + Correction Factor(dB/m)
2. Correction Factor(dB/m) = Antenna Factor(dB/m) + Cable Factor(dB) – Pre-Amplifier Factor(dB)
3. The other emission levels were very low against the limit.
4. Margin value = Emission Level – Limit value
5. " \* ": Fundamental frequency.
6. " # ": The radiated frequency is out of the restricted band.

<b>CHANNEL</b>	TX Channel 165	<b>DETECTOR FUNCTION</b>	Peak (PK)
<b>FREQUENCY RANGE</b>	1GHz ~ 40GHz		Average (AV)

**ANTENNA POLARITY & TEST DISTANCE: HORIZONTAL AT 3 M**

NO.	FREQ. (MHz)	EMISSION LEVEL (dBuV/m)	LIMIT (dBuV/m)	MARGIN (dB)	ANTENNA HEIGHT (m)	TABLE ANGLE (Degree)	RAW VALUE (dBuV)	CORRECTION FACTOR (dB/m)
1	*5825.00	104.5 PK			1.10 H	68	100.4	4.1
2	*5825.00	94.2 AV			1.10 H	68	90.1	4.1
3	#5850.00	59.9 PK	122.2	-62.3	1.10 H	68	55.8	4.1
4	#5860.00	56.1 PK	109.4	-53.3	1.10 H	68	51.9	4.2
5	11650.00	65.4 PK	74.0	-8.6	3.32 H	103	52.7	12.7
6	11650.00	52.4 AV	54.0	-1.6	3.32 H	103	39.7	12.7
7	#17475.00	57.8 PK	74.0	-16.2	3.30 H	260	38.9	18.9
8	#17475.00	45.2 AV	54.0	-8.8	3.30 H	260	26.3	18.9

**ANTENNA POLARITY & TEST DISTANCE: VERTICAL AT 3 M**

NO.	FREQ. (MHz)	EMISSION LEVEL (dBuV/m)	LIMIT (dBuV/m)	MARGIN (dB)	ANTENNA HEIGHT (m)	TABLE ANGLE (Degree)	RAW VALUE (dBuV)	CORRECTION FACTOR (dB/m)
1	*5825.00	103.9 PK			3.03 V	171	99.8	4.1
2	*5825.00	91.9 AV			3.03 V	171	87.8	4.1
3	#5850.00	58.8 PK	122.2	-63.4	3.03 V	171	54.7	4.1
4	#5860.00	55.3 PK	109.4	-54.1	3.03 V	171	51.1	4.2
5	11650.00	60.7 PK	74.0	-13.3	1.25 V	56	48.0	12.7
6	11650.00	47.4 AV	54.0	-6.6	1.25 V	56	34.7	12.7
7	#17475.00	58.1 PK	74.0	-15.9	1.16 V	87	39.2	18.9
8	#17475.00	45.5 AV	54.0	-8.5	1.16 V	87	26.6	18.9

**REMARKS:**

1. Emission Level(dBuV/m) = Raw Value(dBuV) + Correction Factor(dB/m)
2. Correction Factor(dB/m) = Antenna Factor(dB/m) + Cable Factor(dB) – Pre-Amplifier Factor(dB)
3. The other emission levels were very low against the limit.
4. Margin value = Emission Level – Limit value
5. " \* ": Fundamental frequency.
6. " # ": The radiated frequency is out of the restricted band.

**Below 1GHz Data:**

**802.11a**

<b>CHANNEL</b>	TX Channel 116	<b>DETECTOR FUNCTION</b>	Quasi-Peak (QP)
<b>FREQUENCY RANGE</b>	9kHz ~ 1GHz		

**ANTENNA POLARITY & TEST DISTANCE: HORIZONTAL AT 3 M**

NO.	FREQ. (MHz)	EMISSION LEVEL (dBuV/m)	LIMIT (dBuV/m)	MARGIN (dB)	ANTENNA HEIGHT (m)	TABLE ANGLE (Degree)	RAW VALUE (dBuV)	CORRECTION FACTOR (dB/m)
1	72.15	31.8 QP	40.0	-8.2	1.90 H	352	43.41	-11.62
2	120.19	29.4 QP	43.5	-14.1	1.30 H	124	40.06	-10.62
3	186.38	27.1 QP	43.5	-16.4	1.40 H	286	38.21	-11.12
4	247.46	33.7 QP	46.0	-12.3	1.20 H	172	43.54	-9.86
5	456.02	30.5 QP	46.0	-15.5	1.40 H	224	34.08	-3.59
6	815.44	32.5 QP	46.0	-13.5	1.20 H	171	29.86	2.63

**ANTENNA POLARITY & TEST DISTANCE: VERTICAL AT 3 M**

NO.	FREQ. (MHz)	EMISSION LEVEL (dBuV/m)	LIMIT (dBuV/m)	MARGIN (dB)	ANTENNA HEIGHT (m)	TABLE ANGLE (Degree)	RAW VALUE (dBuV)	CORRECTION FACTOR (dB/m)
1	72.19	30.7 QP	40.0	-9.3	1.40 V	200	42.34	-11.62
2	120.19	32.4 QP	43.5	-11.1	1.10 V	110	43.06	-10.62
3	144.04	22.7 QP	43.5	-20.8	1.20 V	340	31.41	-8.71
4	432.77	29.3 QP	46.0	-16.7	1.10 V	213	33.47	-4.18
5	456.11	29.8 QP	46.0	-16.2	1.22 V	171	33.37	-3.59
6	618.30	30.1 QP	46.0	-15.9	1.10 V	320	30.42	-0.28

**REMARKS:**

1. Emission Level(dBuV/m) = Raw Value(dBuV) + Correction Factor(dB/m)
2. Correction Factor(dB/m) = Antenna Factor(dB/m) + Cable Factor(dB) – Pre-Amplifier Factor(dB)
3. The other emission levels were very low against the limit.
4. Margin value = Emission Level – Limit value

## 4.2 Conducted Emission Measurement

### 4.2.1 Limits of Conducted Emission Measurement

Frequency (MHz)	Conducted Limit (dBuV)	
	Quasi-peak	Average
0.15 - 0.5	66 - 56	56 - 46
0.50 - 5.0	56	46
5.0 - 30.0	60	50

Note: 1. The lower limit shall apply at the transition frequencies.

2. The limit decreases in line with the logarithm of the frequency in the range of 0.15 to 0.50MHz.

### 4.2.2 Test Instruments

DESCRIPTION & MANUFACTURER	MODEL NO.	SERIAL NO.	CALIBRATED DATE	CALIBRATED UNTIL
Test Receiver R&S	ESCS 30	100375	May 06, 2015	May 05, 2016
Line-Impedance Stabilization Network (for EUT) SCHWARZBECK	NSLK-8127	8127-522	Sep. 01, 2015	Aug. 31, 2016
Line-Impedance Stabilization Network (for Peripheral ) R&S	ENV216	100072	June 11, 2015	June 10, 2016
RF Cable	5D-FB	COCCAB-001	Mar. 09, 2015	Mar. 08, 2016
50 ohms Terminator	N/A	EMC-03	Sep. 23, 2015	Sep. 22, 2016
50 ohms Terminator	N/A	EMC-02	Oct. 01, 2015	Sep. 30, 2016
Software BVADT	BVADT_Cond_ V7.3.7.3	NA	NA	NA

**Note:**

1. The calibration interval of the above test instruments are 12 months and the calibrations are traceable to NML/ROC and NIST/USA.
2. The test was performed in Shielded Room No. C.
3. The VCCI Con C Registration No. is C-3611.
4. Tested Date: Feb. 16, 2016

#### 4.2.3 Test Procedure

- The EUT was placed 0.4 meters from the conducting wall of the shielded room with EUT being connected to the power mains through a line impedance stabilization network (LISN). Other support units were connected to the power mains through another LISN. The two LISNs provide 50 ohm/ 50uH of coupling impedance for the measuring instrument.
- Both lines of the power mains connected to the EUT were checked for maximum conducted interference.
- The frequency range from 150kHz to 30MHz was searched. Emission levels under (Limit - 20dB) was not recorded.

**NOTE:** All modes of operation were investigated and the worst-case emissions are reported.

#### 4.2.4 Deviation from Test Standard

No deviation.

#### 4.2.5 Test Setup

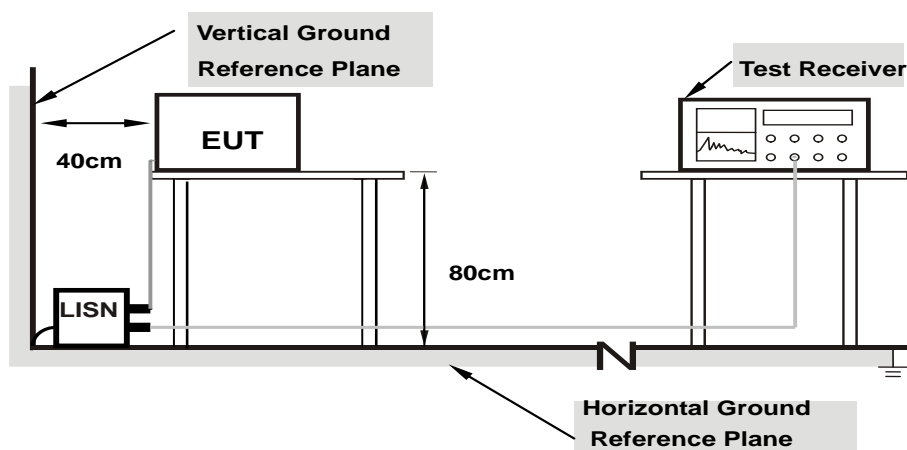

**Note: 1.Support units were connected to second LISN.**

For the actual test configuration, please refer to the attached file (Test Setup Photo).

#### 4.2.6 EUT Operating Condition

Same as 4.1.6.



#### 4.2.7 Test Results

Phase	Line (L)	Detector Function	Quasi-Peak (QP) / Average (AV)
-------	----------	-------------------	--------------------------------

Phase Of Power : Line (L)										
No	Frequency (MHz)	Correction Factor (dB)	Reading Value (dBuV)		Emission Level (dBuV)		Limit (dBuV)		Margin (dB)	
			Q.P.	AV.	Q.P.	AV.	Q.P.	AV.	Q.P.	AV.
1	0.15000	10.26	43.92	27.85	54.18	38.11	66.00	56.00	-11.82	-17.89
2	0.18125	10.24	38.44	24.14	48.68	34.38	64.43	54.43	-15.75	-20.05
3	0.27500	10.23	24.96	12.33	35.19	22.56	60.97	50.97	-25.78	-28.41
4	0.48594	10.23	18.53	11.56	28.76	21.79	56.24	46.24	-27.48	-24.45
5	4.04297	10.38	11.52	7.56	21.90	17.94	56.00	46.00	-34.10	-28.06
6	24.00000	10.97	18.49	16.90	29.46	27.87	60.00	50.00	-30.54	-22.13

#### Remarks:

1. Q.P. and AV. are abbreviations of quasi-peak and average individually.
2. The emission levels of other frequencies were very low against the limit.
3. Margin value = Emission level – Limit value
4. Correction factor = Insertion loss + Cable loss
5. Emission Level = Correction Factor + Reading Value

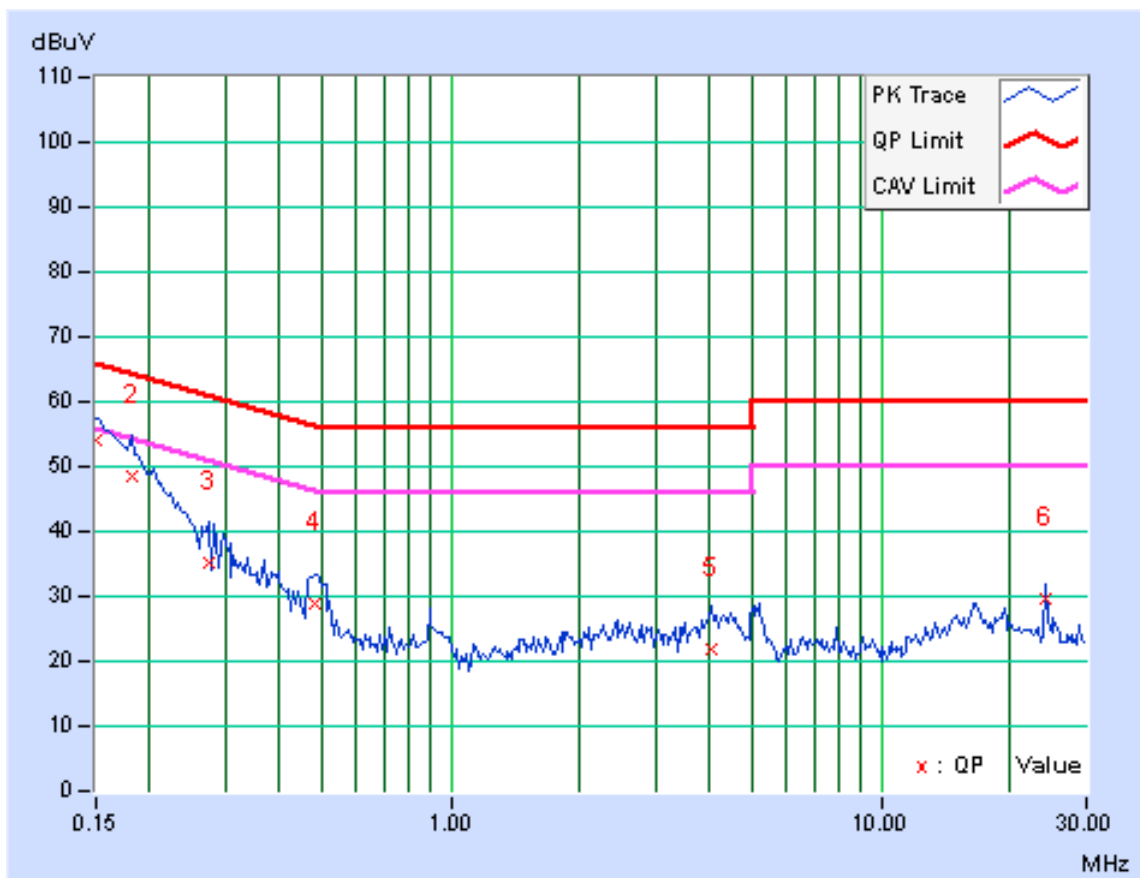

Phase	Neutral (N)	Detector Function	Quasi-Peak (QP) / Average (AV)
-------	-------------	-------------------	--------------------------------

Phase Of Power : Neutral (N)										
No	Frequency (MHz)	Correction Factor (dB)	Reading Value (dBuV)		Emission Level (dBuV)		Limit (dBuV)		Margin (dB)	
			Q.P.	AV.	Q.P.	AV.	Q.P.	AV.	Q.P.	AV.
1	0.15781	10.23	41.65	26.01	51.88	36.24	65.58	55.58	-13.69	-19.33
2	0.18125	10.22	38.17	22.87	48.39	33.09	64.43	54.43	-16.04	-21.34
3	0.24766	10.20	26.99	12.69	37.19	22.89	61.84	51.84	-24.64	-28.94
4	0.49766	10.21	16.36	10.50	26.57	20.71	56.04	46.04	-29.47	-25.33
5	5.05078	10.41	13.22	9.02	23.63	19.43	60.00	50.00	-36.37	-30.57
6	16.62109	10.84	14.30	8.05	25.14	18.89	60.00	50.00	-34.86	-31.11

**Remarks:**

1. Q.P. and AV. are abbreviations of quasi-peak and average individually.
2. The emission levels of other frequencies were very low against the limit.
3. Margin value = Emission level – Limit value
4. Correction factor = Insertion loss + Cable loss
5. Emission Level = Correction Factor + Reading Value

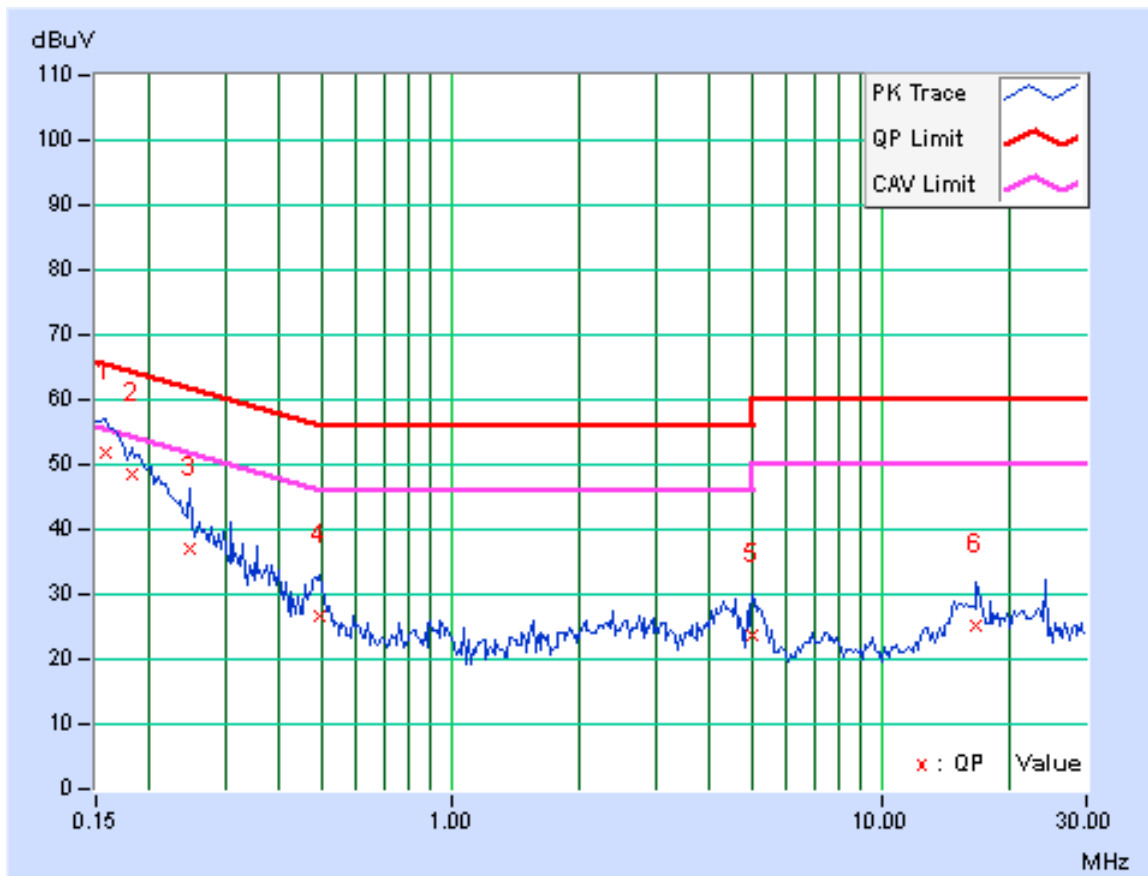

### 4.3 Transmit Power Measurement

#### 4.3.1 Limits of Transmit Power Measurement

Operation Band	EUT Category		LIMIT
U-NII-1		Outdoor Access Point	1 Watt (30 dBm) (Max. e.i.r.p $\leq$ 125mW(21 dBm) at any elevation angle above 30 degrees as measured from the horizon)
		Fixed point-to-point Access Point	1 Watt (30 dBm)
		Indoor Access Point	1 Watt (30 dBm)
	√	Mobile and Portable client device	250mW (24 dBm)
U-NII-2A		√	250mW (24 dBm) or 11 dBm+10 log B*
U-NII-2C		√	250mW (24 dBm) or 11 dBm+10 log B*
U-NII-3		√	1 Watt (30 dBm)

\*B is the 26 dB emission bandwidth in megahertz

#### 4.3.2 Test Setup

##### FOR POWER OUTPUT MEASUREMENT

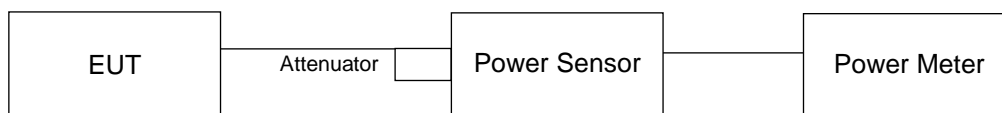

##### FOR 26dB OCCUPIED BANDWIDTH

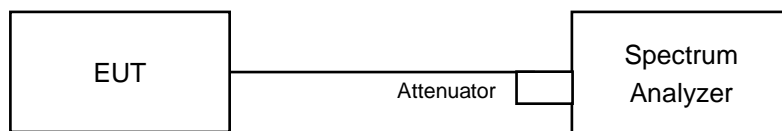

#### 4.3.3 Test Instruments

Refer to section 4.1.2 to get information of above instrument.

#### 4.3.4 Test Procedure

##### **FOR POWER OUTPUT MEASUREMENT**

Method PM is used to perform output power measurement, trigger and gating function of wide band power meter is enabled to measure max output power of TX on burst. Duty factor is not added to measured value.

##### **FOR 26dB OCCUPIED BANDWIDTH**

1. Set RBW = approximately 1% of the emission bandwidth.
2. Set the VBW > RBW.
3. Detector = Peak.
4. Trace mode = max hold.
5. Measure the maximum width of the emission that is 26 dB down from the peak of the emission. Compare this with the RBW setting of the analyzer. Readjust RBW and repeat measurement as needed until the RBW/EBW ratio is approximately 1%.

#### 4.3.5 Deviation from Test Standard

No deviation.

#### 4.3.6 EUT Operating Condition

The software provided by client to enable the EUT under transmission condition continuously at lowest, middle and highest channel frequencies individually.



4.3.7 Test Result

**POWER OUTPUT:**

**802.11a**

Chan.	Chan. Freq. (MHz)	Average Power (mW)	Average Power (dBm)	Limit (dBm)	Pass / Fail
36	5180	10.544	10.23	24	Pass
40	5200	9.506	9.78	24	Pass
48	5240	10.864	10.36	24	Pass
52	5260	12.023	10.80	24	Pass
60	5300	9.954	9.98	24	Pass
64	5320	10.447	10.19	24	Pass
100	5500	23.442	13.70	24	Pass
116	5580	32.584	15.13	24	Pass
140	5700	21.086	13.24	24	Pass
149	5745	16.634	12.21	30	Pass
157	5785	15.56	11.92	30	Pass
165	5825	14.588	11.64	30	Pass

### 26dB OCCUPIED BANDWIDTH

Channel	Frequency (MHz)	26dBc Bandwidth (MHz)
36	5180	20.53
40	5200	20.43
48	5240	20.32
52	5260	20.83
60	5300	20.48
64	5320	20.65
100	5500	20.72
116	5580	27.07
140	5700	21.77

**Note: For U-NII-2A, U-NII-2C Band output power limitation is determined based on 26dBc bandwidth**

Power Limit = 11dBm + 10logB < U-NII-2A, U-NII-2C >			
Channel Number	Freq.(MHz)	Min. B(MHz)	Determined Conducted Limit (dBm)
52	5260	20.83	24.18 > 24
60	5300	20.48	24.11 > 24
64	5320	20.65	24.14 > 24
100	5500	20.72	24.16 > 24
120	5600	27.07	25.32 > 24
140	5700	21.77	24.37 > 24



802.11n (HT20)

Chan.	Chan. Freq. (MHz)	Average Power (mW)	Average Power (dBm)	Limit (dBm)	Pass / Fail
36	5180	8.933	9.51	24	Pass
40	5200	8.035	9.05	24	Pass
48	5240	8.65	9.37	24	Pass
52	5260	9.099	9.59	24	Pass
60	5300	8.511	9.30	24	Pass
64	5320	9.441	9.75	24	Pass
100	5500	23.121	13.64	24	Pass
116	5580	30.13	14.79	24	Pass
140	5700	20.324	13.08	24	Pass
149	5745	16.255	12.11	30	Pass
157	5785	12.677	11.03	30	Pass
165	5825	14.06	11.48	30	Pass

### 26dB OCCUPIED BANDWIDTH

Channel	Frequency (MHz)	26dBc Bandwidth (MHz)
36	5180	21.16
40	5200	21.16
48	5240	21.03
52	5260	21.22
60	5300	21.58
64	5320	21.60
100	5500	21.33
116	5580	25.00
140	5700	21.32

**Note: For U-NII-2A, U-NII-2C Band output power limitation is determined based on 26dBc bandwidth**

Power Limit = 11dBm + 10logB < U-NII-2A, U-NII-2C >			
Channel Number	Freq.(MHz)	Min. B(MHz)	Determined Conducted Limit (dBm)
52	5260	21.22	24.26 > 24
60	5300	21.58	24.34 > 24
64	5320	21.60	24.34 > 24
100	5500	21.33	24.28 > 24
116	5580	25.00	24.97 > 24
140	5700	21.32	24.28 > 24





### Spectrum Plot of Worst Value

#### 802.11a\_CH48

#### 802.11n (HT20)\_CH48

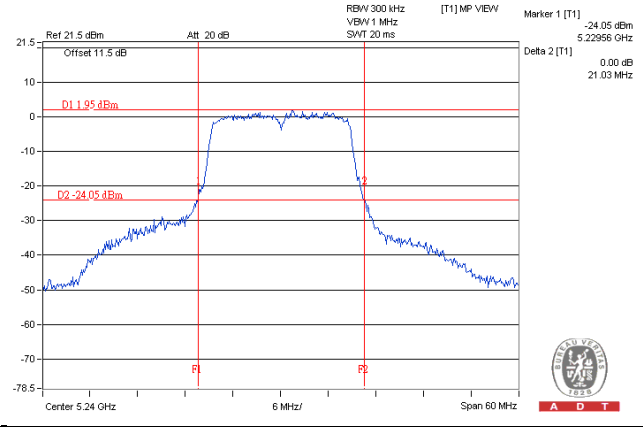
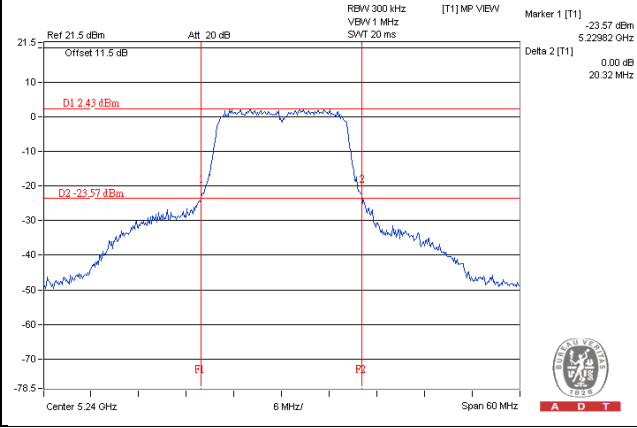

## 4.4 Occupied Bandwidth Measurement

### 4.4.1 Test Setup

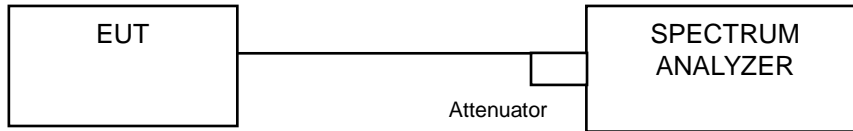

### 4.4.2 Test Instruments

Refer to section 4.1.2 to get information of above instrument.

### 4.4.3 Test Procedure

The transmitter output was connected to the spectrum analyzer through an attenuator. The bandwidth of the fundamental frequency was measured by spectrum analyzer with resolution bandwidth in the range of 1% to 5% of the anticipated emission bandwidth, and a video bandwidth at least 3x the resolution bandwidth and set the detector to SAMPLE. The width of a frequency band such that, below the lower and above the upper frequency limits, the mean powers emitted are each equal to a specified percentage 0.5 %of the total mean power of a given emission.

## 4.4.4 Test Results

**802.11a**

Channel	Channel Frequency (MHz)	Occupied Bandwidth (MHz)
36	5180	16.56
40	5200	16.56
48	5240	16.68
52	5260	16.56
60	5300	16.56
64	5320	16.56
100	5500	16.68
116	5580	16.56
140	5700	16.68
149	5745	16.56
157	5785	16.56
165	5825	16.44

**802.11n (HT20)**

Channel	Channel Frequency (MHz)	Occupied Bandwidth (MHz)
36	5180	17.76
40	5200	17.64
48	5240	17.64
52	5260	17.76
60	5300	17.64
64	5320	17.64
100	5500	17.64
116	5580	17.88
140	5700	17.64
149	5745	17.64
157	5785	17.76
165	5825	17.64

Spectrum Plot of Worst Value

802.11a\_CH48

802.11n (HT20)\_CH116

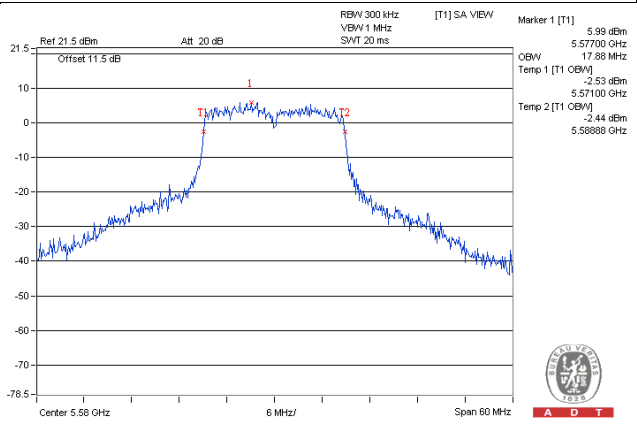
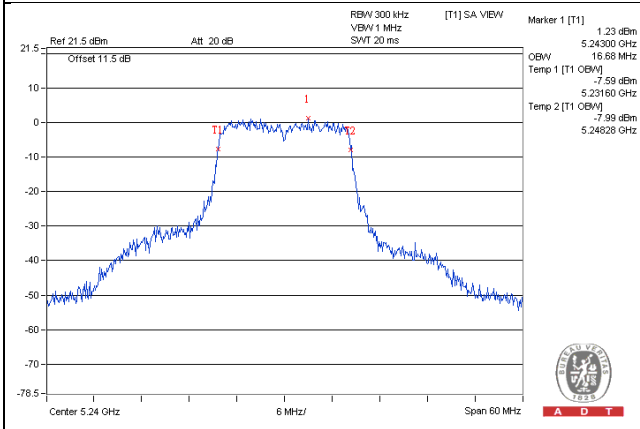

Spectrum Plot for near by DFS band  
(DFS is required, if 99% OCP straddle into U-NII-2A band)

802.11a\_CH48

802.11n (HT20)\_CH48

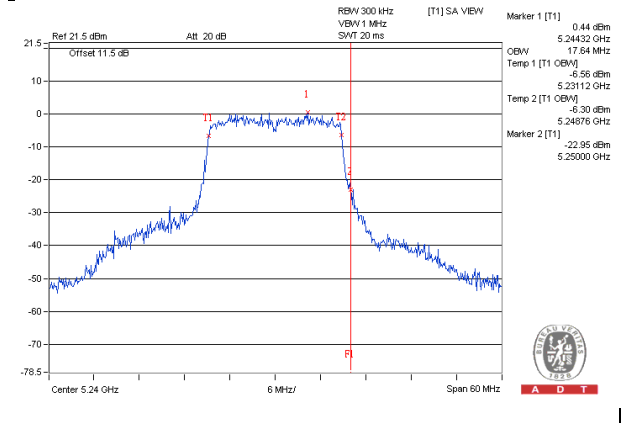
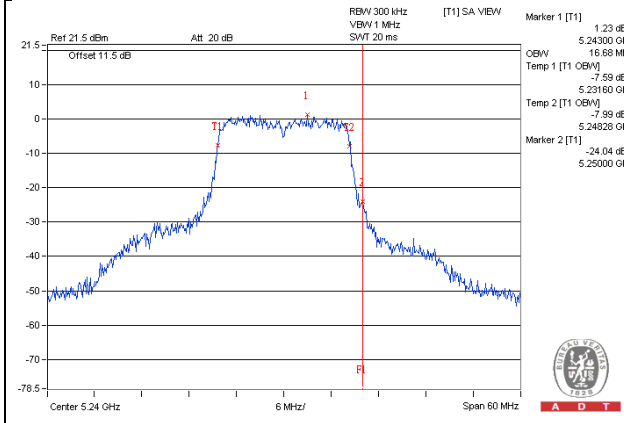

Spectrum Plot for near by DFS band  
(DFS is required, if 99% OCP straddle into U-NII-2C band)

802.11a\_CH149

802.11n (HT20)\_CH149

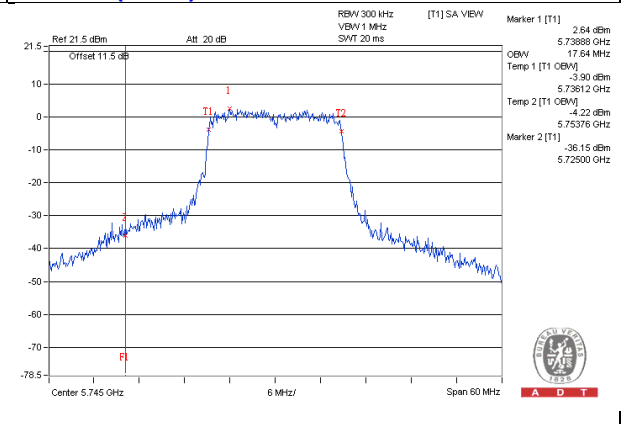
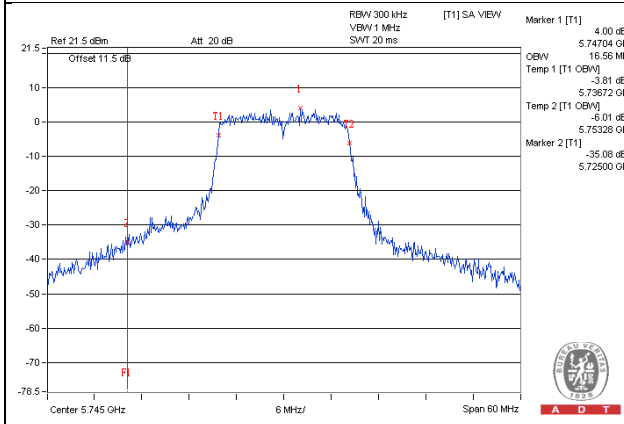

## 4.5 Peak Power Spectral Density Measurement

### 4.5.1 Limits of Peak Power Spectral Density Measurement

Operation Band	EUT Category		LIMIT
U-NII-1		Outdoor Access Point	17dBm/ MHz
		Fixed point-to-point Access Point	
		Indoor Access Point	
	√	Mobile and Portable client device	11dBm/ MHz
U-NII-2A		√	11dBm/ MHz
U-NII-2C		√	11dBm/ MHz
U-NII-3		√	30dBm/ 500kHz

### 4.5.2 Test Setup

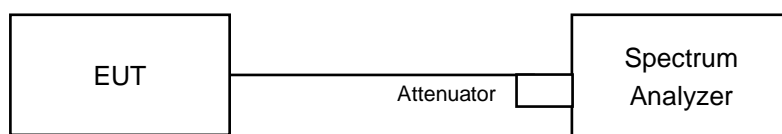

### 4.5.3 Test Instruments

Refer to section 4.1.2 to get information of above instrument.

#### 4.5.4 Test Procedure

**For 802.11a, 802.11n (HT20):**

**For U-NII-1, U-NII-2A, U-NII-2C band:**

Using method SA-1

1. Set span to encompass the entire emission bandwidth (EBW) of the signal.
2. Set RBW = 1 MHz, Set VBW  $\geq$  3 MHz, Detector = RMS
3. Sweep time = auto, trigger set to "free run".
4. Trace average at least 100 traces in power averaging mode.
5. Record the max value

**For U-NII-3:**

1. Set span to encompass the entire emission bandwidth (EBW) of the signal.
2. Set RBW = 300 kHz, Set VBW  $\geq$  1 MHz, Detector = RMS
3. Use the peak marker function to determine the maximum power level in any 300 kHz band segment within the fundamental EBW.
4. Scale the observed power level to an equivalent value in 500 kHz by adjusting (reducing) the measured power by a bandwidth correction factor (BWCF) where  $BWCF = 10\log(500 \text{ kHz}/300\text{kHz})$
5. Sweep time = auto, trigger set to "free run".
6. Trace average at least 100 traces in power averaging mode.
7. Record the max value

#### 4.5.5 Deviation from Test Standard

No deviation.

#### 4.5.6 EUT Operating Condition

Same as Item 4.3.6.



#### 4.5.7 Test Results

For U-NII-1, U-NII-2A, U-NII-2C:

##### 802.11a

Chan.	Chan. Freq. (MHz)	PSD (dBm/MHz)	MAX. Limit (dBm/MHz)	Pass / Fail
36	5180	-2.67	11	Pass
40	5200	-2.99	11	Pass
48	5240	-2.83	11	Pass
52	5260	-2.13	11	Pass
60	5300	-3.24	11	Pass
64	5320	-2.94	11	Pass
100	5500	0.75	11	Pass
116	5580	1.82	11	Pass
140	5700	0.30	11	Pass

##### 802.11n (HT20)

Chan.	Chan. Freq. (MHz)	PSD (dBm/MHz)	MAX. Limit (dBm/MHz)	Pass / Fail
36	5180	-3.72	11	Pass
40	5200	-3.90	11	Pass
48	5240	-3.99	11	Pass
52	5260	-3.54	11	Pass
60	5300	-3.65	11	Pass
64	5320	-3.41	11	Pass
100	5500	0.16	11	Pass
116	5580	1.68	11	Pass
140	5700	-0.50	11	Pass



### Spectrum Plot of Worst Value

802.11a\_CH116

802.11n (HT20)\_CH120

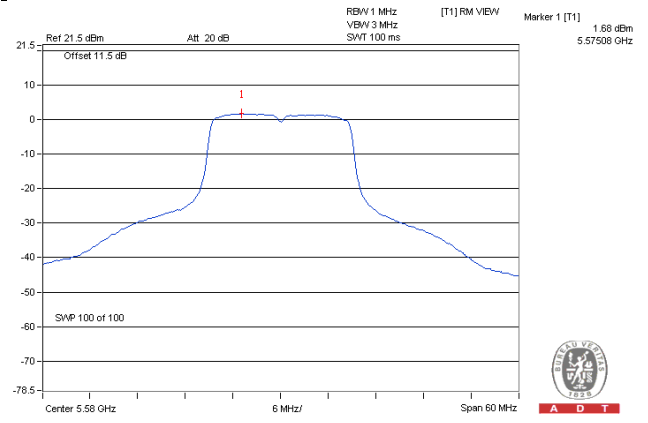
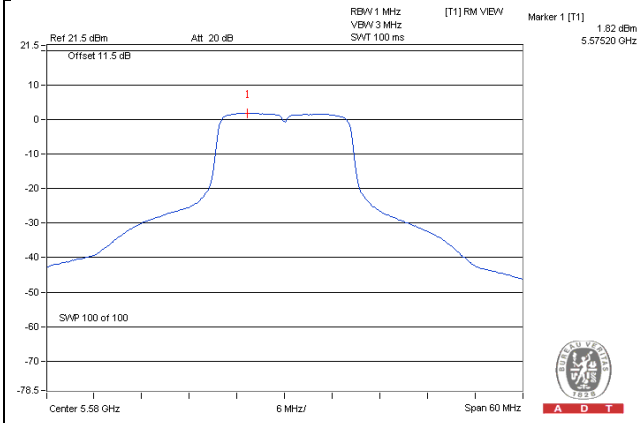



For U-NII-3:

802.11a

Chan.	Chan. Freq. (MHz)	PSD (dBm/300kHz)	PSD (dBm/500kHz)	Limit (dBm/500kHz)	Pass /Fail
149	5745	-8.82	-6.60	30	Pass
157	5785	-9.36	-7.14	30	Pass
165	5825	-9.38	-7.16	30	Pass

802.11n (HT20)

Chan.	Chan. Freq. (MHz)	PSD (dBm/300kHz)	PSD (dBm/500kHz)	Limit (dBm/500kHz)	Pass /Fail
149	5745	-9.43	-7.21	30	Pass
157	5785	-10.14	-7.92	30	Pass
165	5825	-9.83	-7.61	30	Pass

Spectrum Plot of Worst Value

802.11a -CH 149

802.11n (HT20) -CH 149

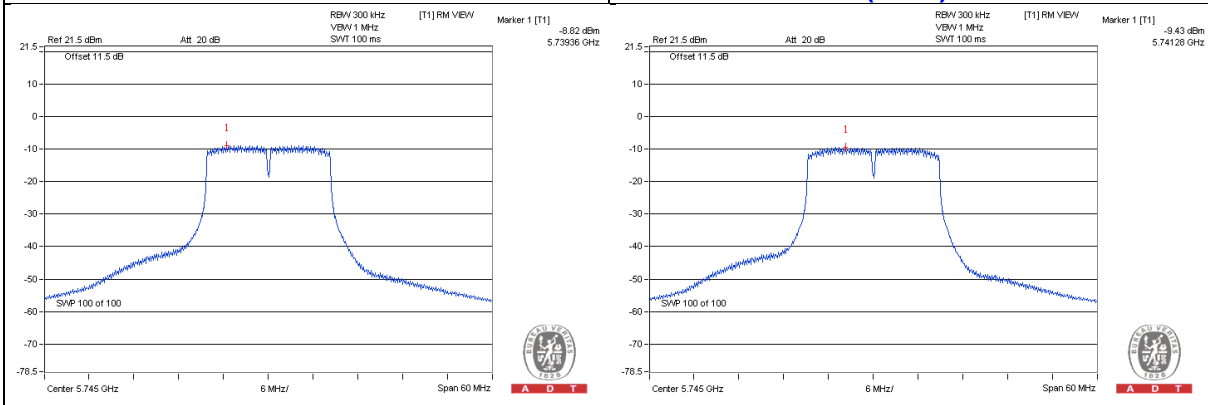

## 4.6 Frequency Stability Measurement

### 4.6.1 Limits of Frequency Stability Measurement

The frequency of the carrier signal shall be maintained within band of operation

### 4.6.2 Test Setup

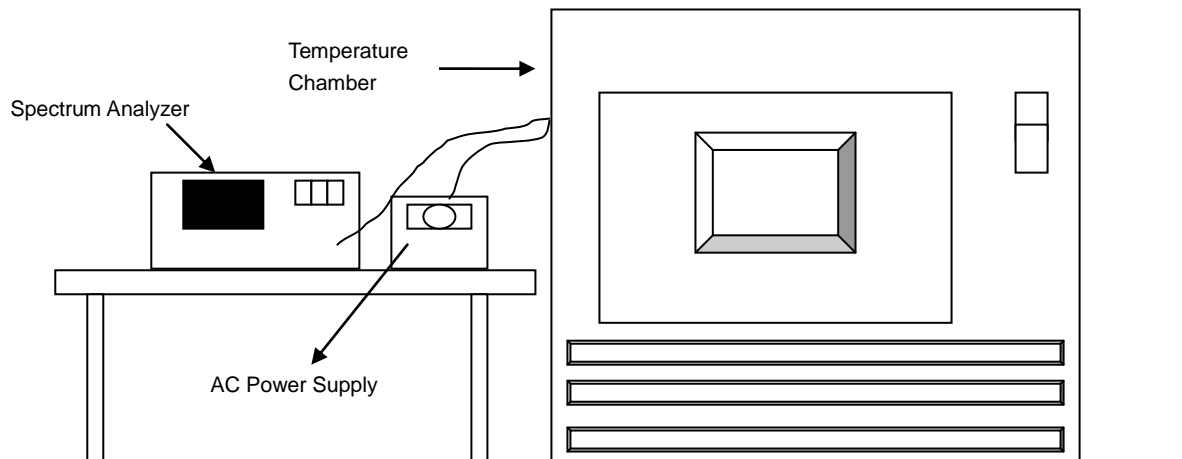

### 4.6.3 Test Instruments

Refer to section 4.1.2 to get information of above instrument.

### 4.6.4 Test Procedure

- The EUT was placed inside the environmental test chamber and powered by nominal AC voltage.
- Turn the EUT on and couple its output to a spectrum analyzer.
- Turn the EUT off and set the chamber to the highest temperature specified.
- Allow sufficient time (approximately 30 min) for the temperature of the chamber to stabilize, turn the EUT on and measure the operating frequency after 2, 5, and 10 minutes.
- Repeat step 2 and 3 with the temperature chamber set to the lowest temperature.
- The test chamber was allowed to stabilize at +20 degree C for a minimum of 30 minutes. The supply voltage was then adjusted on the EUT from 85% to 115% and the frequency record.

### 4.6.5 Deviation from Test Standard

No deviation.

### 4.6.6 EUT Operating Condition

Set the EUT transmit at un-modulation mode to test frequency stability.



4.6.7 Test Results

FREQUENCY STABILITY VERSUS TEMP.									
OPERATING FREQUENCY: 5180MHz									
TEMP. (°C)	POWER SUPPLY (Vac)	0 MINUTE		2 MINUTE		5 MINUTE		10 MINUTE	
		Measured Frequency (MHz)	Frequency Drift (%)	Measured Frequency (MHz)	Frequency Drift (%)	Measured Frequency (MHz)	Frequency Drift (%)	Measured Frequency (MHz)	Frequency Drift (%)
50	120	5179.9753	-0.00048	5179.9738	-0.00051	5179.9723	-0.00053	5179.9724	-0.00053
40	120	5180.0017	0.00003	5179.9987	-0.00003	5179.9987	-0.00003	5179.999	-0.00002
30	120	5179.9869	-0.00025	5179.9834	-0.00032	5179.9848	-0.00029	5179.9826	-0.00034
20	120	5180.0132	0.00025	5180.0118	0.00023	5180.0134	0.00026	5180.0142	0.00027
10	120	5180.0053	0.00010	5180.006	0.00012	5180.0059	0.00011	5180.0037	0.00007
0	120	5180.0251	0.00048	5180.0258	0.00050	5180.0271	0.00052	5180.0225	0.00043
-10	120	5179.992	-0.00015	5179.9938	-0.00012	5179.9921	-0.00015	5179.9926	-0.00014
-20	120	5179.977	-0.00044	5179.9809	-0.00037	5179.9802	-0.00038	5179.9775	-0.00043
-30	120	5179.9853	-0.00028	5179.9839	-0.00031	5179.985	-0.00029	5179.9847	-0.00030

FREQUENCY STABILITY VERSUS VOLTAGE									
OPERATING FREQUENCY: 5180MHz									
TEMP. (°C)	POWER SUPPLY (Vac)	0 MINUTE		2 MINUTE		5 MINUTE		10 MINUTE	
		Measured Frequency (MHz)	Frequency Drift (%)	Measured Frequency (MHz)	Frequency Drift (%)	Measured Frequency (MHz)	Frequency Drift (%)	Measured Frequency (MHz)	Frequency Drift (%)
20	138	5180.0142	0.00027	5180.0123	0.00024	5180.013	0.00025	5180.0149	0.00029
	120	5180.0132	0.00025	5180.0118	0.00023	5180.0134	0.00026	5180.0142	0.00027
	102	5180.0131	0.00025	5180.0119	0.00023	5180.0134	0.00026	5180.0152	0.00029

## 4.7 6dB Bandwidth Measurement

### 4.7.1 Limits of 6dB Bandwidth Measurement

The minimum of 6dB Bandwidth Measurement is 0.5MHz.

### 4.7.2 Test Setup

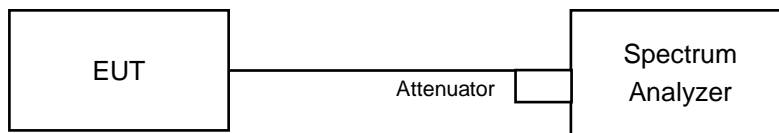

### 4.7.3 Test Instruments

Refer to section 4.1.2 to get information of above instrument.

### 4.7.4 Test Procedure

#### MEASUREMENT PROCEDURE REF

- Set resolution bandwidth (RBW) = 100kHz
- Set the video bandwidth (VBW)  $\geq 3 \times$  RBW, Detector = Peak.
- Trace mode = max hold.
- Sweep = auto couple.
- Measure the maximum width of the emission that is constrained by the frequencies associated with the two amplitude points (upper and lower) that are attenuated by 6 dB relative to the maximum level measured in the fundamental emission

### 4.7.5 Deviation from Test Standard

No deviation.

### 4.7.6 EUT Operating Condition

The software provided by client to enable the EUT under transmission condition continuously at lowest, middle and highest channel frequencies individually.

4.7.7 Test Results

802.11a

Channel	Frequency (MHz)	6dB Bandwidth (MHz)	Minimum Limit (MHz)	Pass / Fail
149	5745	16.31	0.5	PASS
157	5785	16.08	0.5	PASS
165	5825	16.31	0.5	PASS

802.11n (HT20)

Channel	Frequency (MHz)	6dB Bandwidth (MHz)	Minimum Limit (MHz)	Pass / Fail
149	5745	16.57	0.5	PASS
157	5785	16.92	0.5	PASS
165	5825	16.95	0.5	PASS

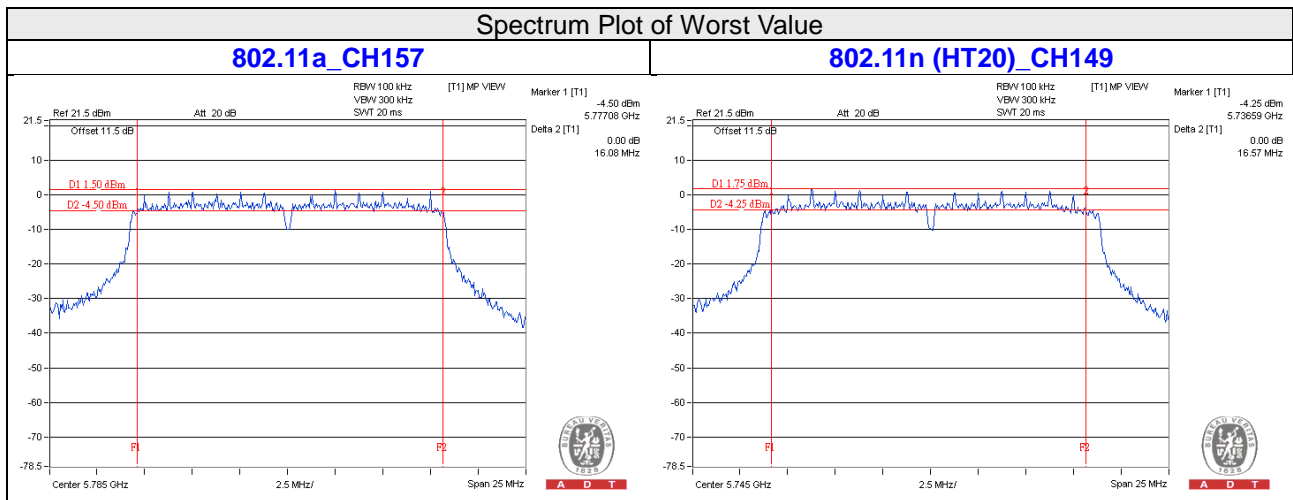



## 5 Pictures of Test Arrangements

Please refer to the attached file (Test Setup Photo).



## Appendix – Information on the Testing Laboratories

We, Bureau Veritas Consumer Products Services (H.K.) Ltd., Taoyuan Branch, were founded in 1988 to provide our best service in EMC, Radio, Telecom and Safety consultation. Our laboratories are accredited and approved according to ISO/IEC 17025.

If you have any comments, please feel free to contact us at the following:

**Linko EMC/RF Lab**

Tel: 886-2-26052180

Fax: 886-2-26051924

**Hsin Chu EMC/RF/Telecom Lab**

Tel: 886-3-6668565

Fax: 886-3-6668323

**Hwa Ya EMC/RF/Safety Lab**

Tel: 886-3-3183232

Fax: 886-3-3270892

**Email:** [service.adt@tw.bureauveritas.com](mailto:service.adt@tw.bureauveritas.com)

**Web Site:** [www.bureauveritas-adt.com](http://www.bureauveritas-adt.com)

The address and road map of all our labs can be found in our web site also.

--- END ---