



## **Specific Absorption Rate (SAR) Test Report**

for

**Wistron NeWeb Corporation**

on the

**WLAN 802.11 a/b/g/n CardBus**

Report No. : FA7D1410-04  
Trade Name : WNC  
Model Name : DNBA-81  
FCC ID : NKR-DNBA81  
Date of Testing : Dec. 25~26, 2007  
Date of Report : Jun. 02, 2008  
Date of Review : Jun. 02, 2008

- The test results refer exclusively to the presented test model / sample only.
- Without written approval of SPORTON International Inc., the test report shall not be reproduced except in full.
- Report Version: Rev. 02

**SPORTON International Inc.**

**6F, No.106, Sec. 1, Hsin Tai Wu Rd., Hsi Chih, Taipei Hsien, Taiwan, R.O.C.**



# Table of Contents

- 1. **Statement of Compliance**-----1
- 2. **Administration Data** -----2
  - 2.1 Testing Laboratory -----2
  - 2.2 Detail of Applicant-----2
  - 2.3 Detail of Manufacturer -----2
  - 2.4 Application Detail -----2
- 3. **General Information** -----3
  - 3.1 Description of Device Under Test (DUT) -----3
  - 3.2 Product Photo-----4
  - 3.3 Applied Standard-----4
  - 3.4 Device Category and SAR Limits -----4
  - 3.5 Test Conditions: -----4
    - 3.5.1 Ambient Condition -----4
    - 3.5.2 Test Configuration -----5
- 4. **Specific Absorption Rate (SAR)** -----6
  - 4.1 Introduction -----6
  - 4.2 SAR Definition -----6
- 5. **SAR Measurement Setup** -----7
  - 5.1 DASY4 E-Field Probe System-----8
    - 5.1.1 ET3DV6 & EX3DV3 E-Field Probe Specification -----9
    - 5.1.2 ET3DV6 & EX3DV3 E-Field Probe Calibration----- 10
  - 5.2 DATA Acquisition Electronics (DAE)----- 12
  - 5.3 Robot----- 12
  - 5.4 Measurement Server----- 12
  - 5.5 SAM Twin Phantom ----- 13
  - 5.6 Device Holder for SAM Twin Phantom ----- 14
  - 5.7 Data Storage and Evaluation ----- 15
    - 5.7.1 Data Storage ----- 15
    - 5.7.2 Data Evaluation ----- 16
  - 5.8 Test Equipment List ----- 18
- 6. **Tissue Simulating Liquids** ----- 19
- 7. **Uncertainty Assessment**----- 21
- 8. **SAR Measurement Evaluation** ----- 24
  - 8.1 Purpose of System Performance check----- 24
  - 8.2 System Setup----- 24
  - 8.3 Validation Results----- 26
- 9. **Description for DUT Testing Position** ----- 27
- 10. **Measurement Procedures** ----- 28
  - 10.1 Spatial Peak SAR Evaluation ----- 28
  - 10.2 Scan Procedures----- 29
  - 10.3 SAR Averaged Methods----- 29
- 11. **SAR Test Results** ----- 30
  - 11.1 Notebook Bottom with 0 cm Gap for 2400~2483.5 MHz----- 30
  - 11.2 Notebook Bottom with 0 cm Gap for 5150~5250 MHz and 5250~5350 MHz ----- 31
  - 11.3 Notebook Bottom with 0 cm Gap for 5470~5725 MHz ----- 32
  - 11.4 Notebook Bottom with 0 cm Gap for 5725~5825 MHz ----- 33
- 12. **Reference** ----- 34

- Appendix A - System Performance Check Data
- Appendix B - SAR Measurement Data
- Appendix C - Calibration Data
- Appendix D - Product Photo
- Appendix E - Setup Photo



**1. Statement of Compliance**

The Specific Absorption Rate (SAR) maximum results found during testing for the Wistron NeWeb Corporation WLAN 802.11 a/b/g/n CardBus WNC DNBA-81 are as follows (with expanded uncertainty 21.9%):

<b>802.11b/g/n 2400~2483.5 MHz (W/Kg)</b>	<b>802.11a/n 5150~5250 MHz 5250~5350 MHz (W/Kg)</b>	<b>802.11a/n 5470~5725 MHz (W/Kg)</b>	<b>802.11a/n 5725~5825 MHz (W/Kg)</b>
<b>0.309</b>	<b>0.877</b>	<b>0.852</b>	<b>0.881</b>

They are in compliance with Specific Absorption Rate (SAR) for general population/uncontrolled exposure limits specified in FCC 47 CFR part 2 (2.1093) and ANSI/IEEE C95.1-1999 and had been tested in accordance with the measurement methods and procedures specified in OET Bulletin 65 Supplement C (Edition 01-01).

Approved by

Roy Wu  
Manager



## **2. Administration Data**

### **2.1 Testing Laboratory**

**Company Name :** Sporton International Inc.  
**Department :** Antenna Design/SAR  
**Address :** No.52, Hwa-Ya 1<sup>st</sup> RD., Hwa Ya Technology Park, Kwei-Shan Hsiang,  
TaoYuan Hsien, Taiwan, R.O.C.  
**Telephone Number :** 886-3-327-3456  
**Fax Number :** 886-3-328-4978

### **2.2 Detail of Applicant**

**Company Name :** Wistron NeWeb Corporation  
**Address :** No.10-1,Li-hsin Road I,Hsinchu Science Park,Hsinchu 300,Taiwan, R.O.C.

### **2.3 Detail of Manufacturer**

**Company Name :** Wistron NeWeb Corporation  
**Address :** No.10-1,Li-hsin Road I,Hsinchu Science Park,Hsinchu 300,Taiwan, R.O.C.

### **2.4 Application Detail**

**Date of reception of application:** Dec. 14, 2007  
**Start of test :** Dec. 25, 2007  
**End of test :** Dec. 26, 2007

### 3. General Information

#### 3.1 Description of Device Under Test (DUT)

<b>DUT Type :</b>	WLAN 802.11 a/b/g/n CardBus
<b>Trade Name :</b>	WNC
<b>Model Name :</b>	DNBA-81
<b>FCC ID :</b>	NKR-DNBA81
<b>Frequency Range:</b>	802.11b/g/n : 2400 ~ 2483.5 MHz 802.11a/n : 5150 ~ 5350 MHz, 5470 ~ 5725 MHz, 5725 ~ 5825 MHz
<b>Antenna Type :</b>	PIFA Antenna
<b>Antenna Gain :</b>	<b>Ant-1</b> 2400~2500 : 1.29 dBi 5150~5825 : 3.03 dBi  <b>Ant-3</b> 2400~2500 : 2.28 dBi 5150~5825 : 4.52 dBi
<b>Maximum Output Power to Antenna :</b>	<b>2400~2483.5MHz</b> 802.11b : 22.07 dBm(Ant-1), 21.48 dBm(Ant-3), 24.80 dBm(Ant1&3) 802.11g : 24.17 dBm(Ant-1), 23.56 dBm(Ant-3), 26.89 dBm(Ant1&3) 802.11n(20M) : 23.14 dBm(Ant-1), 23.68 dBm(Ant-3), 26.43 dBm(Ant1&3) 802.11n(40M) : 19.65 dBm(Ant-1), 20.01 dBm(Ant-3), 22.66 dBm(Ant1&3)  <b>5150~5250MHz</b> 802.11a : 14.08 dBm(Ant-1), 13.59 dBm(Ant-3), 16.80 dBm(Ant1&3) 802.11n(20M) : 13.82 dBm(Ant-1), 13.66 dBm(Ant-3), 16.65 dBm(Ant1&3) 802.11n(40M) : 13.90 dBm(Ant-1), 13.70 dBm(Ant-3), 16.81 dBm(Ant1&3)  <b>5250~5350MHz</b> 802.11a : 19.85 dBm(Ant-1), 19.90 dBm(Ant-3), 22.89 dBm(Ant1&3) 802.11n(20M) : 20.91 dBm(Ant-1), 20.50 dBm(Ant-3), 23.72 dBm(Ant1&3) 802.11n(40M) : 18.66 dBm(Ant-1), 18.76 dBm(Ant-3), 21.72 dBm(Ant1&3)  <b>5470~5725MHz</b> 802.11a : 19.02 dBm(Ant-1), 19.17 dBm(Ant-3), 22.08 dBm(Ant1&3) 802.11n(20M) : 18.12 dBm(Ant-1), 18.01 dBm(Ant-3), 21.08 dBm(Ant1&3) 802.11n(40M) : 18.14 dBm(Ant-1), 18.57 dBm(Ant-3), 21.28 dBm(Ant1&3)  <b>5725~5825MHz</b> 802.11a : 25.47 dBm(Ant-1), 24.95 dBm(Ant-3), 28.23 dBm(Ant1&3) 802.11n(20M) : 23.72 dBm(Ant-1), 23.61 dBm(Ant-3), 26.68 dBm(Ant1&3) 802.11n(40M) : 23.61 dBm(Ant-1), 25.56 dBm(Ant-3), 27.70 dBm(Ant1&3)
<b>Type of Modulation :</b>	DSSS / OFDM
<b>DUT Stage :</b>	Identical Prototype
<b>Application Type :</b>	Certification

Remark : Antenna 1 and Antenna 3 can transmit simultaneously in 802.11n. The function of antenna 2 is only for Rx.



3.2 Product Photo

Please refer to Appendix D

3.3 Applied Standard

The Specific Absorption Rate (SAR) testing specification, method and procedure for this WLAN 802.11 a/b/g/n CardBus is in accordance with the following standards:

- 47 CFR Part 2 ( 2.1093),
- IEEE C95.1-1999,
- IEEE C95.3-2002,
- IEEE P1528-2003, and
- OET Bulletin 65 Supplement C (Edition 01-01)

3.4 Device Category and SAR Limits

This device belongs to portable device category because its radiating structure is allowed to be used within 20 centimeters of the body of the user.

Limit for General Population/Uncontrolled exposure should be applied for this device, it is 1.6 W/kg as averaged over any 1 gram of tissue.

3.5 Test Conditions:

3.5.1 Ambient Condition

Item	2400~2483.5 MHz	5150~5250, 5250~5350 MHz	5470~5725 MHz	5725~5825 MHz
Ambient Temperature (°C)	20-24			
Tissue simulating liquid temperature (°C)	21.5°C	21.6°C	21.6°C	21.6°C
Humidity (%)	<60 %			

**3.5.2 Test Configuration**

Measurements were performed on the lowest, middle, and highest channel for each testing position for head SAR testing. Measurements were performed only on the middle channel if the SAR is below 3 dB of limit for body SAR testing.

The DUT was set from the emulator to radiate maximum output power during all tests.

The data rates for WLAN SAR testing are as Table 3.1.

Frequency	Mode	Data Rate Band
2400~2483.5 MHz	802.11b	1 Mbps
	802.11g	6 Mbps
	802.11n(20M)	13 Mbps
	802.11n(40M)	27 Mbps
5150~5250MHz 5250~5350MHz	802.11a	17 Mbps
	802.11n(20M)	16 Mbps
	802.11n(40M)	16 Mbps
5740~5725 MHz	802.11a	16 Mbps
	802.11n(20M)	13 Mbps
	802.11n(40M)	15 Mbps
5725~5825 MHz	802.11a	6 Mbps
	802.11n(20M)	13 Mbps
	802.11n(40M)	27 Mbps

Table 3.1 The Data Rates for WLAN SAR

Engineering testing software installed on the EUT can provide continuous transmitting RF signal. This RF signal utilized in SAR measurement has almost 100% duty cycle and its crest factor is 1. The measurements were performed on the lowest, middle, and highest channel.

## 4. Specific Absorption Rate (SAR)

### 4.1 Introduction

SAR is related to the rate at which energy is absorbed per unit mass in an object exposed to a radio field. The SAR distribution in a biological body is complicated and is usually carried out by experimental techniques or numerical modeling. The standard recommends limits for two tiers of groups, occupational/controlled and general population/uncontrolled, based on a person's awareness and ability to exercise control over his or her exposure. In general, occupational/controlled exposure limits are higher than the limits for general population/uncontrolled.

### 4.2 SAR Definition

The SAR definition is the time derivative (rate) of the incremental energy (dW) absorbed by (dissipated in) an incremental mass (dm) contained in a volume element (dv) of a given density. ). The equation description is as below:

$$\mathbf{SAR} = \frac{d}{dt} \left( \frac{dW}{dm} \right) = \frac{d}{dt} \left( \frac{dW}{\rho dv} \right)$$

*SAR is expressed in units of Watts per kilogram (W/kg)*

SAR measurement can be either related to the temperature elevation in tissue by

$$\mathbf{SAR} = C \frac{\delta T}{\delta t}$$

, where C is the specific heat capacity,  $\delta T$  is the temperature rise and  $\delta t$  the exposure duration,

or related to the electrical field in the tissue by

$$\mathbf{SAR} = \frac{\sigma |E|^2}{\rho}$$

, where  $\sigma$  is the conductivity of the tissue,  $\rho$  is the mass density of the tissue and  $E$  is the rms electrical field strength.

However for evaluating SAR of low power transmitter, electrical field measurement is typically applied.



### 5. SAR Measurement Setup

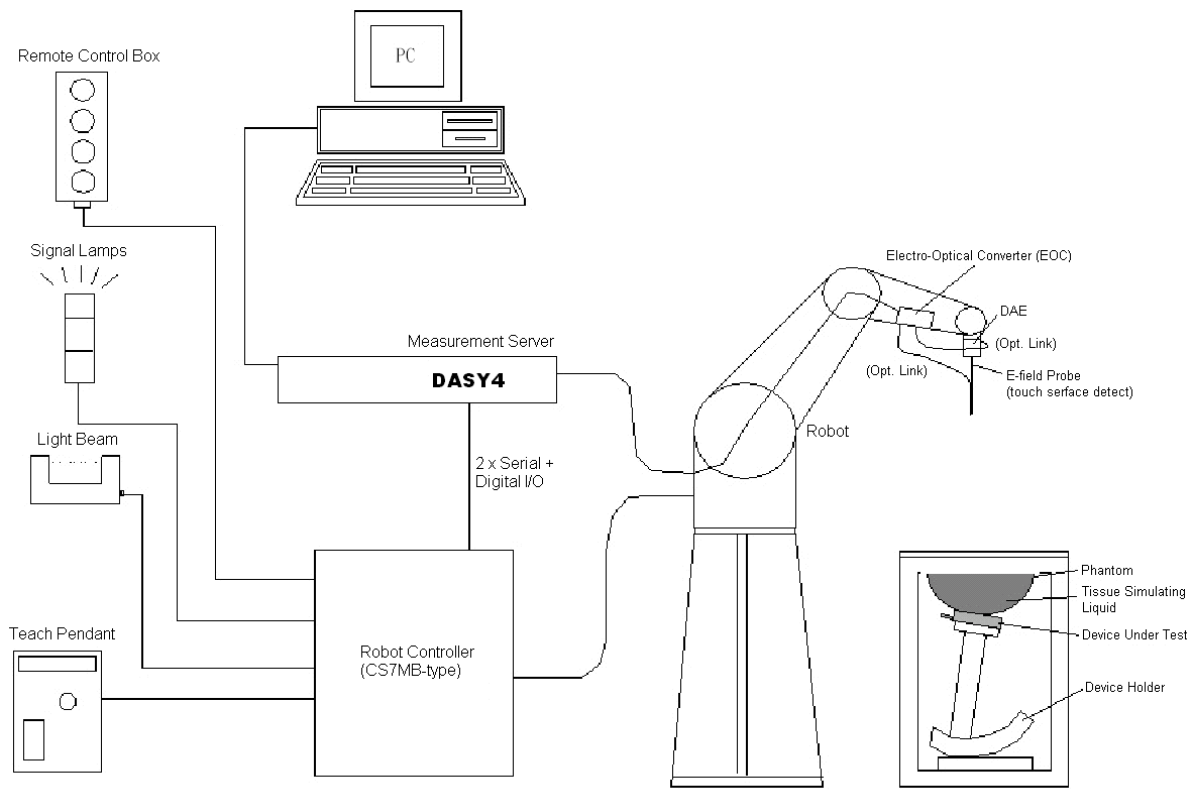

**Fig. 5.1 DASY4 System**

The DASY4 system for performance compliance tests is illustrated above graphically. This system consists of the following items:

- A standard high precision 6-axis robot with controller, a teach pendant and software
- A data acquisition electronic (DAE) attached to the robot arm extension
- A dosimetric probe equipped with an optical surface detector system
- The electro-optical converter (ECO) performs the conversion between optical and electrical signals
- A measurement server performs the time critical tasks such as signal filtering, control of the robot operation and fast movement interrupts.
- A probe alignment unit which improves the accuracy of the probe positioning
- A computer operating Windows XP
- DASY4 software
- Remote control with teach pendant and additional circuitry for robot safety such as warning lamps, etc.
- The SAM twin phantom
- A device holder
- Tissue simulating liquid
- Dipole for evaluating the proper functioning of the system

Some of the components are described in details in the following sub-sections.

### **5.1 DASY4 E-Field Probe System**

The SAR measurement is conducted with the dosimetric probe ET3DV6 and EX3DV3 (manufactured by SPEAG). The probe is specially designed and calibrated for use in liquid with high permittivity. The dosimetric probe has special calibration in liquid at different frequency. This probe has a built in optical surface detection system to prevent from collision with phantom.

**5.1.1 ET3DV6 & EX3DV3 E-Field Probe Specification**

**<ET3DV6 Probe>**

<b>Construction</b>	Symmetrical design with triangular core Built-in optical fiber for surface detection system Built-in shielding against static charges PEEK enclosure material (resistant to organic solvents)
<b>Frequency</b>	10 MHz to 3 GHz
<b>Directivity</b>	± 0.2 dB in brain tissue (rotation around probe axis) ± 0.4 dB in brain tissue (rotation perpendicular to probe axis)
<b>Dynamic Range</b>	5 µ W/g to 100mW/g; Linearity: ±0.2dB
<b>Surface Detection</b>	± 0.2 mm repeatability in air and clear liquids on reflecting surface
<b>Dimensions</b>	Overall length: 330mm Tip length: 16mm Body diameter: 12mm Tip diameter: 6.8mm Distance from probe tip to dipole centers: 2.7mm
<b>Application</b>	General dosimetry up to 3GHz Compliance tests for mobile phones and Wireless LAN Fast automatic scanning in arbitrary phantoms



**Fig. 5.2 Probe setup on robot**

<b>&lt;EX3DV3 Probe&gt;</b>	
<b>Construction</b>	Symmetrical design with triangular core Built-in shielding against static charges PEEK enclosure material (resistant to organic solvents)
<b>Frequency</b>	10 MHz to 6 GHz; Linearity: $\pm 0.2$ dB (30 MHz to 3 GHz)
<b>Directivity</b>	$\pm 0.3$ dB in HSL (rotation around probe axis) $\pm 0.5$ dB in tissue material (rotation normal to probe axis)
<b>Dynamic Range</b>	10 $\mu$ W/g to 100 mW/g; Linearity: $\pm 0.2$ dB (noise: typically $< 1$ $\mu$ W/g)
<b>Dimensions</b>	Overall length: 330 mm (Tip: 20 mm) Tip diameter: 2.5 mm (Body: 12 mm) Typical distance from probe tip to dipole centers: 1 mm
<b>Application</b>	High precision dosimetric measurements in any exposure scenario (e.g., very strong gradient fields). Only probe which enables compliance testing for frequencies up to 6 GHz with precision of better 30%.



**Fig. 5.3 EX3DV3 E-field Probe**

**5.1.2 ET3DV6 & EX3DV3 E-Field Probe Calibration**

Each probe needs to be calibrated according to a dosimetric assessment procedure with accuracy better than  $\pm 10\%$ . The spherical isotropy shall be evaluated and within  $\pm 0.25$ dB. The sensitivity parameters (NormX, NormY, and NormZ), the diode compression parameter (DCP) and the conversion factor (ConvF) of the probe are tested. The calibration data are as below:

➤ ET3DV6 sn1787

<b>Sensitivity</b>	X axis : 1.63 $\mu$ V	Y axis : 1.66 $\mu$ V	Z axis : 2.08 $\mu$ V	
<b>Diode compression point</b>	X axis : 92 mV	Y axis : 96 mV	Z axis : 91 mV	
<b>Conversion factor (Head / Body)</b>	<b>Frequency (MHz)</b>	<b>X axis</b>	<b>Y axis</b>	<b>Z axis</b>
	800~1000	6.58 / 6.10	6.58 / 6.10	6.58 / 6.10
	1710~1910	5.16 / 4.68	5.16 / 4.68	5.16 / 4.68
	2350~2550	4.50 / 4.02	4.50 / 4.02	4.50 / 4.02
<b>Boundary effect (Head / Body)</b>	<b>Frequency (MHz)</b>	<b>Alpha</b>	<b>Depth</b>	
	800~1000	0.32 / 0.36	2.42 / 2.52	
	1710~1910	0.50 / 0.61	2.61 / 2.56	
	2350~2550	0.67 / 0.65	1.81 / 2.15	

➤ EX3DV3 sn3514

<b>Sensitivity</b>	X axis : 0.660 $\mu$ V	Y axis : 0.690 $\mu$ V	Z axis : 0.570 $\mu$ V	
<b>Diode compression point</b>	X axis : 95 mV	Y axis : 93 mV	Z axis : 96 mV	
<b>Conversion factor (Body)</b>	<b>Frequency (MHz)</b>	<b>X axis</b>	<b>Y axis</b>	<b>Z axis</b>
	5100~5300	4.31	4.31	4.31
	5400~5600	4.09	4.09	4.09
	5700~5900	4.16	4.16	4.16
<b>Boundary effect (Body)</b>	<b>Frequency (MHz)</b>	<b>Alpha</b>	<b>Depth</b>	
	5100~5300	0.35	1.70	
	5400~5600	0.35	1.70	
	5700~5900	0.35	1.70	

NOTE: The probe parameters have been calibrated by the SPEAG.

### **5.2 DATA Acquisition Electronics (DAE)**

The data acquisition electronics (DAE4) consists of a highly sensitive electrometer-grade preamplifier with auto-zeroing, a channel and gain-switching multiplexer, a fast 16 bit AD-converter and a command decoder and control logic unit. Transmission to the measurement server is accomplished through an optical downlink for data and status information as well as an optical uplink for commands and the clock.

The mechanical probe mounting device includes two different sensor systems for frontal and sideways probe contacts. They are used for mechanical surface detection and probe collision detection.

The input impedance of the DAE4 is 200M Ohm; the inputs are symmetrical and floating. Common mode rejection is above 80dB.

### **5.3 Robot**

The DASY4 system uses the high precision robots RX90BL type out of the newer series from Stäubli SA (France). For the 6-axis controller DASY4 system, the CS7MB robot controller version from Stäubli is used. The RX robot series have many features that are important for our application:

- High precision (repeatability 0.02 mm)
- High reliability (industrial design)
- Jerk-free straight movements
- Low ELF interference (the closed metallic construction shields against motor control fields)
- 6-axis controller

### **5.4 Measurement Server**

The DASY4 measurement server is based on a PC/104 CPU board with  
166 MHz CPU  
32 MB chipset and  
64 MB RAM.

Communication with  
the DAE4 electronic box  
the 16-bit AD-converter system for optical detection and digital I/O interface.

The measurement server performs all the real-time data evaluation for field measurements and surface detection, controls robot movements and handles safety operations.

### 5.5 SAM Twin Phantom

The SAM twin phantom is a fiberglass shell phantom with 2mm shell thickness (except the ear region where shell thickness increases to 6mm). It has three measurement areas:

- Left head
- Right head
- Flat phantom

The bottom plate contains three pair of bolts for locking the device holder. The device holder positions are adjusted to the standard measurement positions in the three sections.

A white cover is provided to tap the phantom during off-periods to prevent water evaporation and changes in the liquid parameters.

On the phantom top, three reference markers are provided to identify the phantom position with respect to the robot.

The phantom can be used with the following tissue simulating liquids:

- \*Water-sugar based liquid
- \*Glycol based liquids

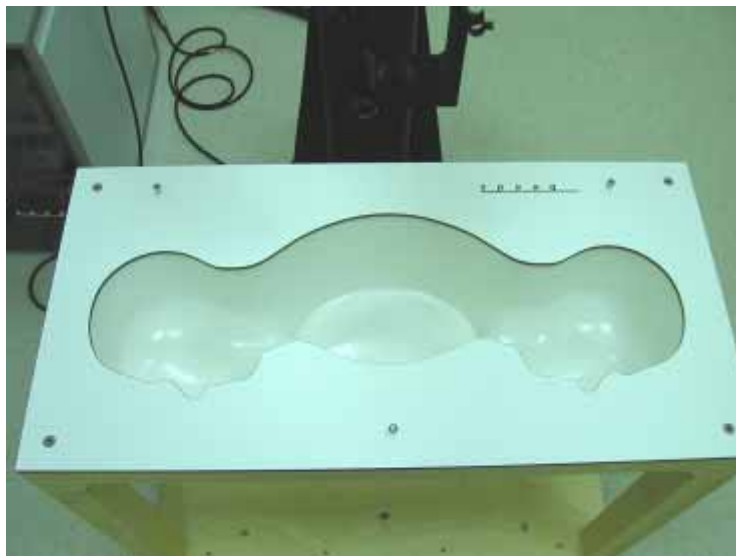

**Fig. 5.4 Top View of Twin Phantom**



**Fig. 5.5 Bottom View of Twin Phantom**

### **5.6 Device Holder for SAM Twin Phantom**

The SAR in the Phantom is approximately inversely proportional to the square of the distance between the source and the liquid surface. For a source in 5 mm distance, a positioning uncertainty of  $\pm 0.5\text{mm}$  would produce a SAR uncertainty of  $\pm 20\%$ . An accurate device position is therefore crucial for accurate and repeatable measurement. The position in which the devices must be measured, are defined by the standards.

The DASY4 device holder is designed to cope with different positions given in the standard. It has two scales for the device rotation (with respect to the body axis) and the device inclination (with respect to the line between the ear reference points). The rotation centers for both scales is the ear reference point (EPR).

Thus the device needs no repositioning when changing the angles.

The DASY4 device holder has been made out of low-loss POM material having the following dielectric parameters: relative permittivity  $\epsilon_r = 3$  and loss tangent  $\delta = 0.02$ . The amount of dielectric material has been reduced in the closest vicinity of the device, since measurements have suggested that the influence of the clamp on the test results could thus be lowered.



**Fig. 5.6 Device Holder**

## **5.7 Data Storage and Evaluation**

### **5.7.1 Data Storage**

The DASY4 software stores the assessed data from the data acquisition electronics as raw data (in microvolt readings from the probe sensors), together with all the necessary software parameters for the data evaluation (probe calibration data, liquid parameters and device frequency and modulation data) in measurement files with the extension .DA4. The post-processing software evaluates the desired unit and format for output each time the data is visualized or exported. This allows verification of the complete software setup even after the measurement and allows correction of erroneous parameter settings. For example, if a measurement has been performed with an incorrect crest factor parameter in the device setup, the parameter can be corrected afterwards and the data can be reevaluated.

The measured data can be visualized or exported in different units or formats, depending on the selected probe type (e.g., [V/m], [A/m], [mW/g]). Some of these units are not available in certain situations or give meaningless results, e.g., a SAR-output in a non-loss media, will always be zero. Raw data can also be exported to perform the evaluation with other software packages.

**5.7.2 Data Evaluation**

The DASY4 post-processing software (SEMCAD) automatically executes the following procedures to calculate the field units from the microvolt readings at the probe connector. The parameters used in the evaluation are stored in the configuration modules of the software :

<b>Probe parameters :</b>	- Sensitivity	Norm <sub>i</sub> , a <sub>i0</sub> , a <sub>i1</sub> , a <sub>i2</sub>
	- Conversion factor	ConvF <sub>i</sub>
	- Diode compression point	dcp <sub>i</sub>
<b>Device parameters :</b>	- Frequency	f
	- Crest factor	cf
<b>Media parameters :</b>	- Conductivity	
	- Density	

These parameters must be set correctly in the software. They can be found in the component documents or they can be imported into the software from the configuration files issued for the DASY components. In the direct measuring mode of the multi-meter option, the parameters of the actual system setup are used. In the scan visualization and export modes, the parameters stored in the corresponding document files are used.

The first step of the evaluation is a linearization of the filtered input signal to account for the compression characteristics of the detector diode. The compensation depends on the input signal, the diode type and the DC-transmission factor from the diode to the evaluation electronics. If the exciting field is pulsed, the crest factor of the signal must be known to correctly compensate for peak power. The formula for each channel can be given as :

$$V_i = U_i + U_i^2 \cdot \frac{cf}{dcp_i}$$

with  $V_i =$  compensated signal of channel  $i$  ( $i = x, y, z$ )  
 $U_i =$  input signal of channel  $i$  ( $i = x, y, z$ )  
 $cf =$  crest factor of exciting field (DASY parameter)  
 $dcp_i =$  diode compression point (DASY parameter)

From the compensated input signals, the primary field data for each channel can be evaluated :

**E-field probes :**  $E_i = \sqrt{\frac{V_i}{Norm_i ConvF}}$

**H-field probes :**  $H_i = \sqrt{V_i \frac{a_{i0} + a_{i1}f + a_{i2}f^2}{f}}$

with  $V_i =$  compensated signal of channel  $i$  ( $i = x, y, z$ )  
 $Norm_i =$  sensor sensitivity of channel  $i$  ( $i = x, y, z$ )  
 $\mu V/(V/m)^2$  for E-field Probes  
 $ConvF =$  sensitivity enhancement in solution

- $a_{ij}$  = sensor sensitivity factors for H-field probes
- $f$  = carrier frequency [GHz]
- $E_i$  = electric field strength of channel  $i$  in V/m
- $H_i$  = magnetic field strength of channel  $i$  in A/m

The RSS value of the field components gives the total field strength (Hermitian magnitude) :

$$E_{tot} = \sqrt{E_x^2 + E_y^2 + E_z^2}$$

The primary field data are used to calculate the derived field units.

$$SAR = E_{tot}^2 \cdot \frac{\sigma}{\rho \cdot 1000}$$

- with **SAR** = local specific absorption rate in mW/g
- $E_{tot}$**  = total field strength in V/m
- = conductivity in [mho/m] or [Siemens/m]
- = equivalent tissue density in g/cm<sup>3</sup>

\* Note that the density is set to 1, to account for actual head tissue density rather than the density of the tissue simulating liquid.

The power flow density is calculated assuming the excitation field to be a free space field.

$$P_{pwe} = \frac{E_{tot}^2}{3770} \quad \text{or} \quad P_{pwe} = H_{tot}^2 \cdot 37.7$$

- with  **$P_{pwe}$**  = equivalent power density of a plane wave in mW/cm<sup>2</sup>
- $E_{tot}$**  = total electric field strength in V/m
- $H_{tot}$**  = total magnetic field strength in A/m

**5.8 Test Equipment List**

Manufacture	Name of Equipment	Type/Model	Serial Number	Calibration	
				Last Cal.	Due Date
SPEAG	Dosimetric E-Filed Probe	ET3DV6	1787	Aug. 28, 2007	Aug. 28, 2008
SPEAG	System Validation Kit	D2450V2	736	Jul. 12, 2007	Jul. 12, 2009
SPEAG	Dosimetric E-Filed Probe	EX3DV3	3514	Feb. 21, 2007	Feb. 21, 2008
SPEAG	System Validation Kit	D5GHzV2	1006	Feb. 10, 2006	Feb. 10, 2008
SPEAG	Data Acquisition Electronics	DAE4	778	Sep. 17, 2007	Sep. 17, 2008
SPEAG	Device Holder	N/A	N/A	NCR	NCR
SPEAG	Phantom	QD 000 P40 C	TP-1303	NCR	NCR
SPEAG	Phantom	QD 000 P40 C	TP-1383	NCR	NCR
SPEAG	Phantom	QDOVA001BA	1029	NCR	NCR
SPEAG	Robot	Staubli RX90BL	F03/5W15A1/A/01	NCR	NCR
SPEAG	Software	DASY4 V4.7 Build 55	N/A	NCR	NCR
SPEAG	Software	SEMCAD V1.8 Build 176	N/A	NCR	NCR
SPEAG	Measurement Server	SE UMS 001 BA	1021	NCR	NCR
Agilent	ENA Series Network Analyzer	E5071C	MY46100746	Feb. 21, 2007	Feb. 21, 2008
Agilent	Wireless Communication Test Set	E5515C	GB46311322	Dec. 22, 2006	Dec. 22, 2008
Agilent	Dielectric Probe Kit	85070D	US01440205	NCR	NCR
Agilent	Dual Directional Coupler	778D	50422	NCR	NCR
Agilent	Power Amplifier	8449B	3008A01917	NCR	NCR
Agilent	Power Meter	E4416A	GB41292344	Feb. 08, 2007	Feb. 08, 2008
Agilent	Power Sensor	E9327A	US40441548	Feb. 08, 2007	Feb. 08, 2008
Agilent	Signal Generator	E8247C	MY43320596	Mar. 01, 2006	Mar. 01, 2008

**Table 5.1 Test Equipment List**

### 6. Tissue Simulating Liquids

For the measurement of the field distribution inside the SAM phantom with DASY4, the phantom must be filled with around 25 liters of homogeneous tissue simulating liquid. The liquid height from the ear reference point (ERP) of the phantom to the liquid top surface (head SAR) or from the flat phantom to the liquid top surface (body SAR) is 15.2cm.

The dielectric parameters of the liquids were verified prior to the SAR evaluation using an Agilent 85070D Dielectric Probe Kit and an Agilent Network Analyzer.

Table 6.1 shows the measuring results for head and muscle simulating liquid.

Bands	Frequency (MHz)	Permittivity ( $\epsilon_r$ )	Conductivity ( $\sigma$ )	Measurement Date
802.11b/g/n (2400 ~ 2483.5 MHz)	2412	53.6	1.92	Dec. 26, 2007
	2437	53.4	1.95	
	2462	53.3	1.98	
802.11a/n (5150~5250 MHz)	5180	48.5	5.19	Dec. 25, 2007
	5200	48.5	5.19	
	5240	48.4	5.25	
802.11a/n (5250~5350 MHz)	5260	48.4	5.31	Dec. 25, 2007
	5270	48.4	5.31	
	5300	48.4	5.31	
802.11a/n (5470~5725 MHz)	5510	48.1	5.54	Dec. 25, 2007
	5590	48.0	5.64	
	5600	48.0	5.65	
	5700	47.8	5.76	
802.11a/n (5725~5825 MHz)	5745	47.7	5.88	Dec. 25, 2007
	5755	47.7	5.88	
	5785	47.7	5.88	
	5795	47.7	5.88	

**Table 6.1 Measuring Results for Simulating Liquid**

The measuring data are consistent with  $\epsilon_r = 52.7 \pm 5\%$ ,  $\sigma = 1.95 \pm 5\%$  for body 2450 band,  $\epsilon_r = 49.0 \pm 5\%$  and  $\sigma = 5.30 \pm 5\%$  for body 5200MHz,  $\epsilon_r = 48.6 \pm 5\%$  and  $\sigma = 5.65 \pm 5\%$  for body 5500MHz and  $\epsilon_r = 48.2 \pm 5\%$ ,  $\sigma = 6.00 \pm 5\%$  for body 5800MHz.



**Fig 6.1** Liquid height from the bottom of the phantom body is 15.2 centimeters

## 7. Uncertainty Assessment

The component of uncertainty may generally be categorized according to the methods used to evaluate them. The evaluation of uncertainty by the statistical analysis of a series of observations is termed a Type A evaluation of uncertainty. The evaluation of uncertainty by means other than the statistical analysis of a series of observation is termed a Type B evaluation of uncertainty. Each component of uncertainty, however evaluated, is represented by an estimated standard deviation, termed standard uncertainty, which is determined by the positive square root of the estimated variance.

A Type A evaluation of standard uncertainty may be based on any valid statistical method for treating data. This includes calculating the standard deviation of the mean of a series of independent observations; using the method of least squares to fit a curve to the data in order to estimate the parameter of the curve and their standard deviations; or carrying out an analysis of variance in order to identify and quantify random effects in certain kinds of measurement.

A type B evaluation of standard uncertainty is typically based on scientific judgment using all of the relevant information available. These may include previous measurement data, experience and knowledge of the behavior and properties of relevant materials and instruments, manufacture’s specification, data provided in calibration reports and uncertainties assigned to reference data taken from handbooks. Broadly speaking, the uncertainty is either obtained from an outdoor source or obtained from an assumed distribution, such as the normal distribution, rectangular or triangular distributions indicated in Table 7.1

Uncertainty Distributions	Normal	Rectangular	Triangular	U-shape
<b>Multiplying factor<sup>(a)</sup></b>	1/k <sup>(b)</sup>	1/ 3	1/ 6	1/ 2

(a) standard uncertainty is determined as the product of the multiplying factor and the estimated range of variations in the measured quantity

(b) is the coverage factor

**Table 7.1 Multiplying Factions for Various Distributions**

The combined standard uncertainty of the measurement result represents the estimated standard deviation of the result. It is obtained by combining the individual standard uncertainties of both Type A and Type B evaluation using the usual “root-sum-squares” (RSS) methods of combining standard deviations by taking the positive square root of the estimated variances.

Expanded uncertainty is a measure of uncertainty that defines an interval about the measurement result within which the measured value is confidently believed to lie. It is obtained by multiplying the combined standard uncertainty by a coverage factor. Typically, the coverage factor ranges from 2 to 3. Using a coverage factor allows the true value of a measured quantity to be specified with a defined probability within the specified uncertainty range. For purpose of this document, a coverage factor two is used, which corresponds to confidence interval of about 95 %. The DASY4 uncertainty Budget is showed in Table 7.2.



Error Description	Uncertainty Value ± %	Probability Distribution	Divisor	Ci (1g)	Standard Unc. (1g)	vi or Veff
<b>Measurement Equipment</b>						
Probe Calibration	±5.9 %	Normal	1	1	±5.9 %	∞
Axial Isotropy	±4.7 %	Rectangular	√3	0.7	±1.9 %	∞
Hemispherical Isotropy	±9.6 %	Rectangular	√3	0.7	±3.9 %	∞
Boundary Effects	±1.0 %	Rectangular	√3	1	±0.6 %	∞
Linearity	±4.7 %	Rectangular	√3	1	±2.7 %	∞
System Detection Limits	±1.0 %	Rectangular	√3	1	±0.6 %	∞
Readout Electronics	±0.3 %	Normal	1	1	±0.3 %	∞
Response Time	±0.8 %	Rectangular	√3	1	±0.5 %	∞
Integration Time	±2.6 %	Rectangular	√3	1	±1.5 %	∞
RF Ambient Noise	±3.0 %	Rectangular	√3	1	±1.7 %	∞
RF Ambient Reflections	±3.0 %	Rectangular	√3	1	±1.7 %	∞
Probe Positioner	±0.4 %	Rectangular	√3	1	±0.2 %	∞
Probe Positioning	±2.9 %	Rectangular	√3	1	±1.7 %	∞
Max. SAR Eval.	±1.0 %	Rectangular	√3	1	±0.6 %	∞
<b>Test Sample Related</b>						
Device Positioning	±2.9 %	Normal	1	1	±2.9 %	145
Device Holder	±3.6 %	Normal	1	1	±3.6 %	5
Power Drift	±5.0 %	Rectangular	√3	1	±2.9 %	∞
<b>Phantom and Setup</b>						
Phantom Uncertainty	±4.0 %	Rectangular	√3	1	±2.3 %	∞
Liquid Conductivity (target)	±5.0 %	Rectangular	√3	0.64	±1.8 %	∞
Liquid Conductivity (meas.)	±2.5 %	Normal	1	0.64	±1.6 %	∞
Liquid Permittivity (target)	±5.0 %	Rectangular	√3	0.6	±1.7 %	∞
Liquid Permittivity (meas.)	±2.5 %	Normal	1	0.6	±1.5 %	∞
<b>Combined Standard Uncertainty</b>					<b>±10.9 %</b>	<b>387</b>
<b>Coverage Factor for 95 %</b>	<b>K=2</b>					
<b>Expanded uncertainty (Coverage factor = 2)</b>					<b>±21.9 %</b>	

Table 7.2 Uncertainty Budget of DASY4 for 2.4GHz band





Error Description	Uncertainty Value	Probability Distribution	Divisor	Ci (1g)	Standard Unc. (1g)	vi or Veff
<b>Measurement System</b>						
Probe Calibration	±6.8 %	Normal	1	1	±6.8 %	∞
Axial Isotropy	±4.7 %	Rectangular	√3	0.7	±1.9 %	∞
Hemispherical Isotropy	±9.6 %	Rectangular	√3	0.7	±3.9 %	∞
Boundary Effect	±2.0 %	Rectangular	√3	1	±1.2 %	∞
Linearity	±4.7 %	Rectangular	√3	1	±2.7 %	∞
System Detection Limit	±1.0 %	Rectangular	√3	1	±0.6 %	∞
Readout Electronics	±0.3 %	Normal	1	1	±0.3 %	∞
Response Time	±0.8 %	Rectangular	√3	1	± 0.5 %	∞
Integration Time	±2.6 %	Rectangular	√3	1	± 1.5 %	∞
RF Ambient Noise	±3.0 %	Rectangular	√3	1	±1.7 %	∞
RF Ambient Reflections	±3.0 %	Rectangular	√3	1	±1.7 %	∞
Probe Positioner	±0.8 %	Rectangular	√3	1	±0.5 %	∞
Probe Positioning	±9.9 %	Rectangular	√3	1	±5.7 %	∞
Max. SAR Eval.	±4.0 %	Rectangular	√3	1	±2.3 %	∞
<b>Test Sample Related</b>						
Device Positioning	±2.9 %	Normal	1	1	±2.9 %	145
Device Holder	±3.6 %	Normal	1	1	±3.6 %	5
Power Drift	±5.0 %	Rectangular	√3	1	±2.9 %	∞
<b>Phantom and Setup</b>						
Phantom Uncertainty	±4.0 %	Rectangular	√3	1	±2.3 %	∞
Liquid Conductivity (target)	±5.0 %	Rectangular	√3	0.64	±1.8 %	∞
Liquid Conductivity (meas.)	±2.5 %	Normal	1	0.64	±1.6 %	∞
Liquid Permittivity (target)	±5.0 %	Rectangular	√3	0.6	±1.7 %	∞
Liquid Permittivity (meas.)	±2.5 %	Normal	1	0.6	±1.5 %	∞
<b>Combined Std. Uncertainty</b>					<b>±12.9 %</b>	<b>330</b>
<b>Coverage Factor for 95%</b>	<b>Kp=2</b>					
<b>Expanded STD Uncertainty</b>					<b>±25.9 %</b>	

Table 7.3 Uncertainty Budget of DASY4 for 5GHz Band

## 8. SAR Measurement Evaluation

Each DASY4 system is equipped with one or more system validation kits. These units, together with the predefined measurement procedures within the DASY4 software, enable the user to conduct the system performance check and system validation. System validation kit includes a dipole, tripod holder to fix it underneath the flat phantom and a corresponding distance holder.

### 8.1 Purpose of System Performance check

The system performance check verifies that the system operates within its specifications. System and operator errors can be detected and corrected. It is recommended that the system performance check be performed prior to any usage of the system in order to guarantee reproducible results. The system performance check uses normal SAR measurements in a simplified setup with a well characterized source. This setup was selected to give a high sensitivity to all parameters that might fail or vary over time. The system check does not intend to replace the calibration of the components, but indicates situations where the system uncertainty is exceeded due to drift or failure.

### 8.2 System Setup

In the simplified setup for system evaluation, the DUT is replaced by a calibrated dipole and the power source is replaced by a continuous wave which comes from a signal generator at frequency 2450, 5200, 5500 and 5800 MHz. The calibrated dipole must be placed beneath the flat phantom section of the SAM twin phantom with the correct distance holder. The distance holder should touch the phantom surface with a light pressure at the reference marking and be oriented parallel to the long side of the phantom. The equipment setup is shown below:

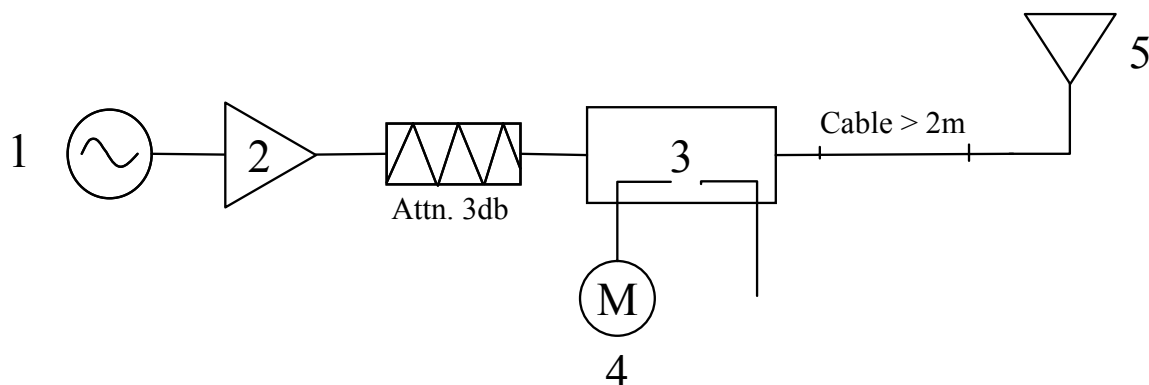

**Fig. 8.1 System Evaluation Setup**

1. Signal Generator
2. Amplifier
3. Directional Coupler
4. Power Meter
5. 2450 MHz, 5200 MHz, 5500 MHz and 5800 MHz Dipole

The output power on dipole port must be calibrated to 20dBm (100mW) before dipole is connected.



**Fig 8.2 Dipole Setup**

**8.3 Validation Results**

Comparing to the original SAR value provided by SPEAG, the validation data should be within its specification of 10 %. Table 8.1 shows the target SAR and measured SAR after normalized to 1W input power.

Band	SAR	Target (W/kg)	Measurement data (W/kg)	Variation	Measurement Date
802.11b/g/n (2400~2450 MHz)	SAR (1g)	52.5	52.6	0.2 %	Dec. 26, 2007
	SAR (10g)	24.4	24.8	1.6 %	
802.11a/n (5150~5250 MHz, 5250~5350 MHz)	SAR (1g)	73.7	76.5	3.8 %	Dec. 25, 2007
	SAR (10g)	20.6	21.6	4.9 %	
802.11a/n (5470~5725 MHz)	SAR (1g)	75	75.9	1.2 %	Dec. 25, 2007
	SAR (10g)	21	21.2	1.0 %	
802.11a/n (5725~5850 MHz)	SAR (1g)	69.8	66	-5.4 %	Dec. 25, 2007
	SAR (10g)	19.7	18.1	-8.1 %	

**Table 8.1 Target and Measurement Data Comparison**

The table above indicates the system performance check can meet the variation criterion.



### **9. Description for DUT Testing Position**

This DUT was tested in one position. It is “Notebook Bottom with 0 cm Gap”

Remark: Please refer to Appendix E for the test setup photo.

## **10. Measurement Procedures**

The measurement procedures are as follows:

- Using engineering software to transmit RF power continuously (continuous Tx)
- Measuring output power through RF cable and power meter
- Placing the DUT in the positions described in the last section
- Setting scan area, grid size and other setting on the DASY4 software
- Taking data for the lowest, middle, and highest channel on each testing position

According to the IEEE P1528 draft standard, the recommended procedure for assessing the peak spatial-average SAR value consists of the following steps:

- Power reference measurement
- Area scan
- Zoom scan
- Power reference measurement

### **10.1 Spatial Peak SAR Evaluation**

The procedure for spatial peak SAR evaluation has been implemented according to the IEEE1528-2003 standard. It can be conducted for 1g and 10g, as well as for user-specific masses. The DASY4 software includes all numerical procedures necessary to evaluate the spatial peak SAR value.

Base on the Draft: SCC-34, SC-2, WG-2-Computational Dosimetry, IEEE P1528/D1.2 (Recommended Practice for Determining the Peak Spatial-Average Specific Absorption Rate (SAR) in the Human Head from Wireless Communications Devices: Measurement Techniques), a new algorithm has been implemented. The spatial-peak SAR can be computed over any required mass.

The base for the evaluation is a "cube" measurement. The measured volume must include the 1g and 10g cubes with the highest averaged SAR values. For that purpose, the center of the measured volume is aligned to the interpolated peak SAR value of a previously performed area scan.

The entire evaluation of the spatial peak values is performed within the post-processing engine (SEMCAD). The system always gives the maximum values for the 1g and 10g cubes. The algorithm to find the cube with highest averaged SAR is divided into the following stages:

- extraction of the measured data (grid and values) from the Zoom Scan
- calculation of the SAR value at every measurement point based on all stored data (A/D values and measurement parameters)
- generation of a high-resolution mesh within the measured volume
  
- interpolation of all measured values from the measurement grid to the high-resolution grid
- extrapolation of the entire 3-D field distribution to the phantom surface over the distance from sensor to surface
- calculation of the averaged SAR within masses of 1g and 10g

### **10.2 Scan Procedures**

First Area Scan is used to locate the approximate location(s) of the local peak SAR value(s). The measurement grid within an Area Scan is defined by the grid extent, grid step size and grid offset. Next, in order to determine the EM field distribution in a three-dimensional spatial extension, Zoom Scan is required. The Zoom Scan measures 5x5x7 points with step size 8, 8 and 5 mm for 2.45GHz Band and 8x8x8 points with step size 4.3, 4.3 and 3 mm for 5GHz Band. The Zoom Scan is performed around the highest E-field value to determine the averaged SAR-distribution over 1 g.

### **10.3 SAR Averaged Methods**

In DASY4, the interpolation and extrapolation are both based on the modified Quadratic Shepard's method. The interpolation scheme combines a least-square fitted function method and a weighted average method which are the two basic types of computational interpolation and approximation.

Extrapolation routines are used to obtain SAR values between the lowest measurement points and the inner phantom surface. The extrapolation distance is determined by the surface detection distance and the probe sensor offset. The uncertainty increases with the extrapolation distance. To keep the uncertainty within 1% for the 1 g and 10 g cubes, the extrapolation distance should not be larger than 5 mm.



**11. SAR Test Results**

**11.1 Notebook Bottom with 0 cm Gap for 2400~2483.5 MHz**

NB	Mode	Ant.	Chan.	Freq (MHz)	Modulation Type	Conducted Power (dBm)	Power Drift (dB)	Measured 1g SAR (W/kg)	Limit (W/kg)	Results
DELL D500	802.11b	1	1	2412(Low)	CCK	22.07	-	-	-	-
			6	2437(Mid)	CCK	21.58	-0.101	0.294	1.6	PASS
			11	2462(High)	CCK	21.26	-	-	-	-
		3	1	2412(Low)	CCK	21.48	-0.178	0.259	1.6	PASS
			6	2437(Mid)	CCK	20.68	-0.098	0.309	1.6	PASS
			11	2462(High)	CCK	19.98	0.09	0.209	1.6	PASS
	802.11g	1	1	2412(Low)	OFDM	23.64	-	-	-	-
			6	2437(Mid)	OFDM	24.17	-0.141	0.177	1.6	PASS
			11	2462(High)	OFDM	23.36	-	-	-	-
		3	1	2412(Low)	OFDM	23.07	-	-	-	-
			6	2437(Mid)	OFDM	23.56	0.051	0.163	1.6	PASS
			11	2462(High)	OFDM	22.96	-	-	-	-
	802.11n (20M)	1	1	2412(Low)	OFDM	22.30	-	-	-	-
			6	2437(Mid)	OFDM	23.14	-0.119	0.155	1.6	PASS
			11	2462(High)	OFDM	22.28	-	-	-	-
		3	1	2412(Low)	OFDM	22.66	-	-	-	-
			6	2437(Mid)	OFDM	23.68	-0.019	0.135	1.6	PASS
			11	2462(High)	OFDM	22.35	-	-	-	-
		2Tx	1	2412(Low)	OFDM	25.49	-	-	-	-
			6	2437(Mid)	OFDM	26.43	-0.007	0.234	1.6	PASS
			11	2462(High)	OFDM	25.33	-	-	-	-
	802.11n (40M)	1	3	2422(Low)	OFDM	18.82	-	-	-	-
			6	2437(Mid)	OFDM	19.25	0.024	0.067	1.6	PASS
			9	2452(High)	OFDM	19.65	-	-	-	-
3		3	2422(Low)	OFDM	19.40	-	-	-	-	
		6	2437(Mid)	OFDM	20.01	0.031	0.061	1.6	PASS	
		9	2452(High)	OFDM	19.41	-	-	-	-	
2Tx		3	2422(Low)	OFDM	22.13	-	-	-	-	
		6	2437(Mid)	OFDM	22.66	-0.055	0.086	1.6	PASS	
		9	2452(High)	OFDM	22.54	-	-	-	-	
DELL M2300	802.11b	3	1	2412(Low)	CCK	21.48	-	-	-	-
			6	2437(Mid)	CCK	20.68	-0.142	0.181	1.6	PASS
			11	2462(High)	CCK	19.98	-	-	-	-
IBM 2653	802.11b	3	1	2412(Low)	CCK	21.48	-	-	-	-
			6	2437(Mid)	CCK	20.68	-0.009	0.118	1.6	PASS
			11	2462(High)	CCK	19.98	-	-	-	-





11.2 Notebook Bottom with 0 cm Gap for 5150~5250 MHz and 5250~5350 MHz

NB	Mode	Ant.	Chan.	Freq (MHz)	Modulation Type	Conducted Power (dBm)	Power Drift (dB)	Measured 1g SAR (W/kg)	Limit (W/kg)	Results	
DELL D500	802.11a	1	36	5180(Low)	OFDM	14.08	-	-	-	-	
			52	5260(Mid)	OFDM	17.97	0.128	0.506	1.6	PASS	
			60	5300(High)	OFDM	18.75	-	-	-	-	
		3	36	5180(Low)	OFDM	13.28	-	-	-	-	
			52	5260(Mid)	OFDM	17.93	0.127	0.777	1.6	PASS	
			60	5300(High)	OFDM	18.27	-	-	-	-	
	802.11n (20M)	1	36	5180(Low)	OFDM	13.82	-	-	-	-	
			52	5260(Mid)	OFDM	18.93	0.078	0.498	1.6	PASS	
			60	5300(High)	OFDM	20.91	-	-	-	-	
		3	36	5180(Low)	OFDM	13.46	-	-	-	-	
			52	5260(Mid)	OFDM	18.87	0.077	0.211	1.6	PASS	
			60	5300(High)	OFDM	20.50	-	-	-	-	
		2Tx	36	5180(Low)	OFDM	16.65	-0.15	0.353	1.6	PASS	
			52	5260(Mid)	OFDM	21.91	-0.037	0.877	1.6	PASS	
			60	5300(High)	OFDM	23.72	-0.028	0.692	1.6	PASS	
		802.11n (40M)	1	38	5190(Low)	OFDM	13.90	-	-	-	-
				54	5270(Mid)	OFDM	18.51	-0.136	0.419	1.6	PASS
				60	5300(High)	OFDM	18.66	-	-	-	-
	3		38	5190(Low)	OFDM	13.70	-	-	-	-	
			54	5270(Mid)	OFDM	18.63	0.056	0.598	1.6	PASS	
			60	5300(High)	OFDM	18.76	-	-	-	-	
	2Tx		38	5190(Low)	OFDM	16.81	-	-	-	-	
			54	5270(Mid)	OFDM	21.58	-0.033	0.774	1.6	PASS	
			60	5300(High)	OFDM	21.72	-	-	-	-	
DELL M2300	802.11n (20M)	2Tx	36	5180(Low)	OFDM	16.65	-	-	-	-	
			52	5260(Mid)	OFDM	21.91	0.083	0.481	1.6	PASS	
			60	5300(High)	OFDM	23.72	-	-	-	-	
IBM 2653	802.11n (20M)	2Tx	36	5180(Low)	OFDM	16.65	-	-	-	-	
			52	5260(Mid)	OFDM	21.91	-0.126	0.486	1.6	PASS	
			60	5300(High)	OFDM	23.72	-	-	-	-	



**11.3 Notebook Bottom with 0 cm Gap for 5470~5725 MHz**

NB	Mode	Ant.	Chan.	Freq (MHz)	Modulation Type	Conducted Power (dBm)	Power Drift (dB)	Measured 1g SAR (W/kg)	Limit (W/kg)	Results	
DELL D500	802.11a	1	100	5500(Low)	OFDM	18.72	-	-	-	-	
			120	5600(Mid)	OFDM	18.96	0.152	0.507	1.6	PASS	
			140	5700(High)	OFDM	19.02	-	-	-	-	
		3	100	5500(Low)	OFDM	18.33	-	-	-	-	
			120	5600(Mid)	OFDM	19.17	0.169	0.71	1.6	PASS	
			140	5700(High)	OFDM	18.82	-	-	-	-	
	802.11n (20M)	1	100	5500(Low)	OFDM	15.91	-	-	-	-	
			120	5600(Mid)	OFDM	18.12	0.195	0.333	1.6	PASS	
			140	5700(High)	OFDM	16.41	-	-	-	-	
		3	100	5500(Low)	OFDM	15.12	-	-	-	-	
			120	5600(Mid)	OFDM	18.01	0.013	0.475	1.6	PASS	
			140	5700(High)	OFDM	16.48	-	-	-	-	
		2Tx	100	5500(Low)	OFDM	18.54	-	-	-	-	
			120	5600(Mid)	OFDM	21.08	-0.135	0.557	1.6	PASS	
			140	5700(High)	OFDM	19.46	-	-	-	-	
		802.11n (40M)	1	102	5510(Low)	OFDM	17.73	-	-	-	-
				118	5590(Mid)	OFDM	17.95	0.165	0.385	1.6	PASS
				140	5700(High)	OFDM	18.14	-	-	-	-
	3		102	5510(Low)	OFDM	17.47	-	-	-	-	
			118	5590(Mid)	OFDM	18.57	0.18	0.64	1.6	PASS	
			140	5700(High)	OFDM	18.09	-	-	-	-	
2Tx	102		5510(Low)	OFDM	20.61	0.07	0.852	1.6	PASS		
	118		5590(Mid)	OFDM	21.28	0.122	0.744	1.6	PASS		
	140		5700(High)	OFDM	21.13	-0.111	0.571	1.6	PASS		
DELL M2300	802.11n (40M)	2Tx	102	5510(Low)	OFDM	20.61	-	-	-	-	
			118	5590(Mid)	OFDM	21.28	0.023	0.503	1.6	PASS	
			140	5700(High)	OFDM	21.13	-	-	-	-	
IBM 2653	802.11n (40M)	2Tx	102	5510(Low)	OFDM	20.61	-	-	-	-	
			118	5590(Mid)	OFDM	21.28	-0.009	0.351	1.6	PASS	
			140	5700(High)	OFDM	21.13	-	-	-	-	

**11.4 Notebook Bottom with 0 cm Gap for 5725~5825 MHz**

NB	Mode	Ant.	Chan.	Freq (MHz)	Modulation Type	Conducted Power (dBm)	Power Drift (dB)	Measured 1g SAR (W/kg)	Limit (W/kg)	Results	
DELL D500	802.11a	1	149	5745(Low)	OFDM	25.47	-	-	-	-	
			157	5785(Mid)	OFDM	24.86	-0.144	0.43	1.6	PASS	
			165	5825(High)	OFDM	24.65	-	-	-	-	
		3	149	5745(Low)	OFDM	24.95	-	-	-	-	
			157	5785(Mid)	OFDM	24.40	-0.152	0.663	1.6	PASS	
			165	5825(High)	OFDM	24.13	-	-	-	-	
	802.11n (20M)	1	149	5745(Low)	OFDM	23.72	-	-	-	-	
			157	5785(Mid)	OFDM	23.39	-0.076	0.312	1.6	PASS	
			165	5825(High)	OFDM	22.90	-	-	-	-	
		3	149	5745(Low)	OFDM	23.61	-	-	-	-	
			157	5785(Mid)	OFDM	23.40	-0.149	0.479	1.6	PASS	
			165	5825(High)	OFDM	22.85	-	-	-	-	
		2Tx	149	5745(Low)	OFDM	26.68	-	-	-	-	
			157	5785(Mid)	OFDM	26.41	0.056	0.52	1.6	PASS	
			165	5825(High)	OFDM	25.89	-	-	-	-	
		802.11n (40M)	1	151	5755(Low)	OFDM	23.61	0.132	0.404	1.6	PASS
				159	5795(High)	OFDM	23.40	-	-	-	-
			3	151	5755(Low)	OFDM	25.56	-0.14	0.823	1.6	PASS
	159			5795(High)	OFDM	25.31	-0.121	0.808	1.6	PASS	
	2Tx		151	5755(Low)	OFDM	27.70	-0.101	0.881	1.6	PASS	
			159	5795(High)	OFDM	27.47	-0.132	0.824	1.6	PASS	
DELL M2300	802.11n (40M)	2Tx	151	5755(Low)	OFDM	27.70	0.176	0.48	1.6	PASS	
			159	5795(High)	OFDM	27.47	-	-	-	-	
IBM 2653	802.11n (40M)	2Tx	151	5755(Low)	OFDM	27.70	0.167	0.363	1.6	PASS	
			159	5795(High)	OFDM	27.47	-	-	-	-	

Remark:

1. Ant. 2Tx means Ant. 1 and Ant 3 transmit simultaneously.
2. Test Engineer : Eric Huang, Jason Wang and Gardon Lin



## **12. Reference**

- [1] FCC 47 CFR Part 2 “Frequency Allocations and Radio Treaty Matters; General Rules and Regulations”
- [2] IEEE Std. P1528-2003, “Recommended Practice for Determining the Peak Spatial-Average Specific Absorption Rate (SAR) in the Human Head from Wireless Communications Devices: Measurement Techniques”, April 21, 2003
- [3] Supplement C (Edition 01-01) to OET Bulletin 65 (Edition 97-01), “Additional Information for Evaluating Compliance of Mobile and Portable Devices with FCC Limits for Human Exposure to RF Emissions”, June 2001
- [4] IEEE Std. C95.3-2002, “IEEE Recommended Practice for the Measurement of Potentially Hazardous Electromagnetic Fields-RF and Microwave”, 2002
- [5] IEEE Std. C95.1-1999, “IEEE Standard for Safety Levels with Respect to Human Exposure to Radio Frequency Electromagnetic Fields, 3 kHz to 300 GHz”, 1999
- [6] Robert J. Renka, “Multivariate Interpolation Of Large Sets Of Scattered Data”, University of North Texas ACM Transactions on Mathematical Software, vol. 14, no. 2, June 1988, pp. 139-148
- [7] DAYS4 System Handbook

## Appendix A - System Performance Check Data

Test Laboratory: Sporton International Inc. SAR/HAC Testing Lab

Date: 2007/12/26

### System Check\_Body\_2450MHz

#### DUT: Dipole 2450 MHz

Communication System: CW; Frequency: 2450 MHz; Duty Cycle: 1:1

Medium: MSL\_2450 Medium parameters used:  $f = 2450$  MHz;  $\sigma = 1.97$  mho/m;  $\epsilon_r = 53.4$ ;  $\rho = 1000$  kg/m<sup>3</sup>

Ambient Temperature : 22.9 °C ; Liquid Temperature : 21.5 °C

#### DASY4 Configuration:

- Probe: ET3DV6 - SN1787; ConvF(4.02, 4.02, 4.02); Calibrated: 2007/8/28
- Sensor-Surface: 4mm (Mechanical And Optical Surface Detection) Sensor-Surface: 4mm (Mechanical Surface Detection)
- Electronics: DAE4 Sn778; Calibrated: 2007/9/17
- Phantom: ELI 4.0; Type: QDOVA001BA; Serial: 1029
- Measurement SW: DASY4, V4.7 Build 55; Postprocessing SW: SEMCAD, V1.8 Build 176

**Pin=100mW/Area Scan (91x91x1):** Measurement grid: dx=10mm, dy=10mm

Maximum value of SAR (interpolated) = 6.15 mW/g

**Pin=100mW/Zoom Scan (7x7x7)/Cube 0:** Measurement grid: dx=5mm, dy=5mm, dz=5mm

Reference Value = 57.5 V/m; Power Drift = 0.010 dB

Peak SAR (extrapolated) = 11.2 W/kg

**SAR(1 g) = 5.26 mW/g; SAR(10 g) = 2.48 mW/g**

Maximum value of SAR (measured) = 5.96 mW/g

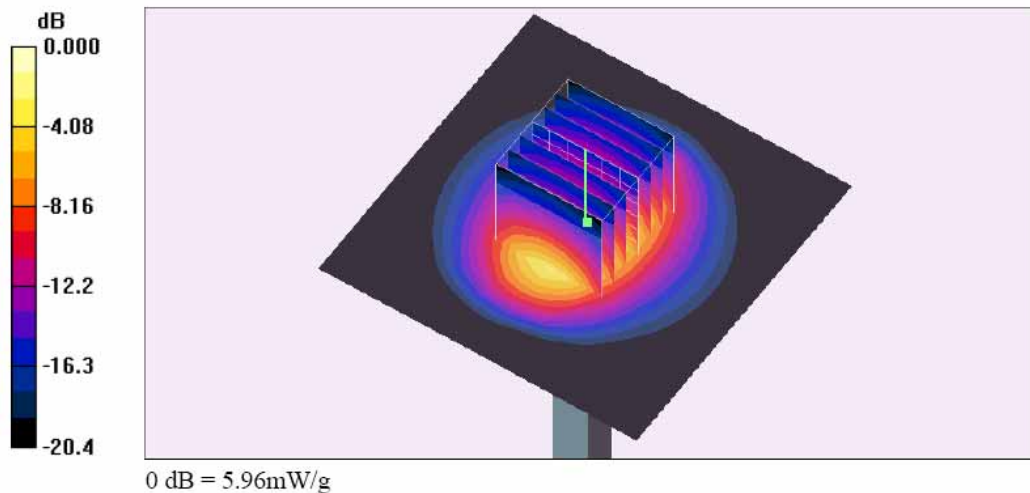

Test Laboratory: Sporton International Inc. SAR/HAC Testing Lab

Date: 2007/12/25

**System Check\_Body\_5200MHz**

**DUT: Dipole 5GHz**

Communication System: CW; Frequency: 5200 MHz; Duty Cycle: 1:1

Medium: MSL\_5G Medium parameters used:  $f = 5200 \text{ MHz}$ ;  $\sigma = 5.19 \text{ mho/m}$ ;  $\epsilon_r = 48.5$ ;  $\rho = 1000 \text{ kg/m}^3$

Ambient Temperature : 22.6 °C; Liquid Temperature : 21.6 °C

**DASY4 Configuration:**

- Probe: EX3DV3 - SN3514; ConvF(4.31, 4.31, 4.31); Calibrated: 2007/2/21
- Sensor-Surface: 2mm (Mechanical Surface Detection)
- Electronics: DAE4 Sn778; Calibrated: 2007/9/17
- Phantom: ELI 4.0; Type: QDOVA001BA; Serial: 1029
- Measurement SW: DASY4, V4.7 Build 55; Postprocessing SW: SEMCAD, V1.8 Build 176

**Pin=100mW/Area Scan (91x91x1):** Measurement grid: dx=10mm, dy=10mm

Maximum value of SAR (interpolated) = 10.5 mW/g

**Pin=100mW/Zoom Scan (8x8x8)/Cube 0:** Measurement grid: dx=4.3mm, dy=4.3mm, dz=3mm

Reference Value = 45.7 V/m; Power Drift = -0.012 dB

Peak SAR (extrapolated) = 30.6 W/kg

**SAR(1 g) = 7.65 mW/g; SAR(10 g) = 2.16 mW/g**

Maximum value of SAR (measured) = 9.56 mW/g

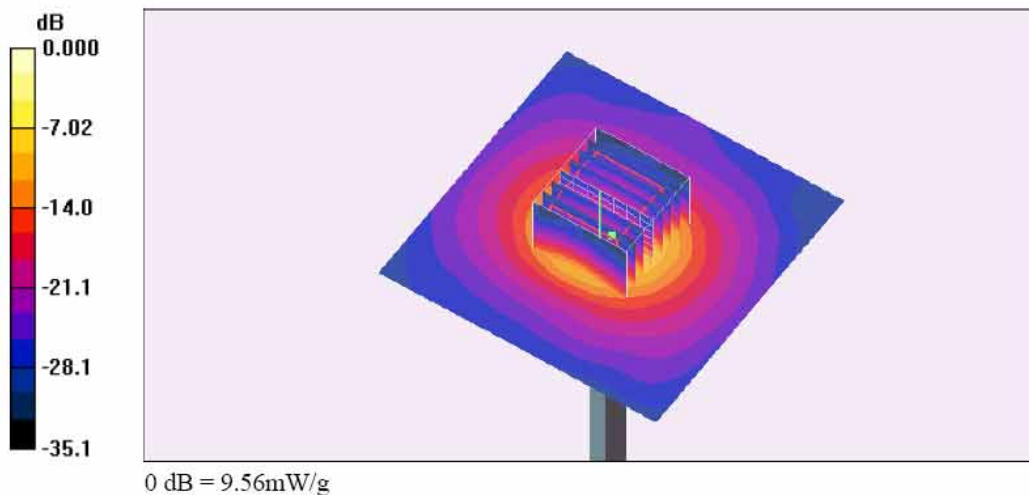

Test Laboratory: Sporton International Inc. SAR/HAC Testing Lab

Date: 2007/12/25

**System Check\_Body\_5500MHz**

**DUT: Dipole 5GHz**

Communication System: CW; Frequency: 5500 MHz; Duty Cycle: 1:1

Medium: MSL\_5G Medium parameters used:  $f = 5500 \text{ MHz}$ ;  $\sigma = 5.54 \text{ mho/m}$ ;  $\epsilon_r = 48.1$ ;  $\rho = 1000 \text{ kg/m}^3$

Ambient Temperature : 22.6 °C; Liquid Temperature : 21.6 °C

**DASY4 Configuration:**

- Probe: EX3DV3 - SN3514; ConvF(4.09, 4.09, 4.09); Calibrated: 2007/2/21
- Sensor-Surface: 2mm (Mechanical Surface Detection)
- Electronics: DAE4 Sn778; Calibrated: 2007/9/17
- Phantom: ELI 4.0; Type: QDOVA001BA; Serial: 1029
- Measurement SW: DASY4, V4.7 Build 55; Postprocessing SW: SEMCAD, V1.8 Build 176

**Pin=100mW/Area Scan (91x91x1):** Measurement grid: dx=10mm, dy=10mm

Maximum value of SAR (interpolated) = 14.6 mW/g

**Pin=100mW/Zoom Scan (8x8x8)/Cube 0:** Measurement grid: dx=4.3mm, dy=4.3mm, dz=3mm

Reference Value = 52.4 V/m; Power Drift = -0.061 dB

Peak SAR (extrapolated) = 30.2 W/kg

**SAR(1 g) = 7.59 mW/g; SAR(10 g) = 2.12 mW/g**

Maximum value of SAR (measured) = 12.6 mW/g

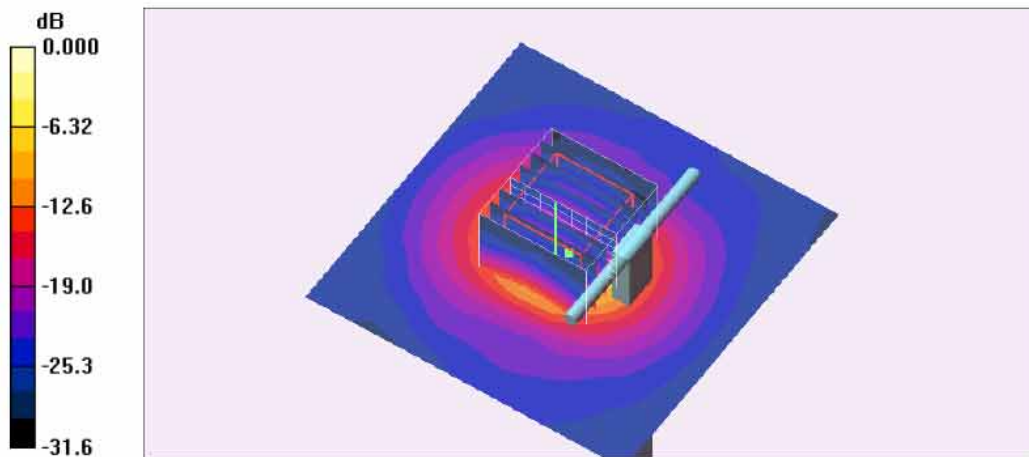

0 dB = 12.6mW/g

Test Laboratory: Sporton International Inc. SAR/HAC Testing Lab

Date: 2007/12/25

**System Check\_Body\_5800MHz**

**DUT: Dipole 5GHz**

Communication System: 802.11a; Frequency: 5800 MHz; Duty Cycle: 1:1

Medium: MSL\_5G Medium parameters used:  $f = 5800 \text{ MHz}$ ;  $\sigma = 5.88 \text{ mho/m}$ ;  $\epsilon_r = 47.7$ ;  $\rho = 1000 \text{ kg/m}^3$

Ambient Temperature : 22.6 °C ; Liquid Temperature : 21.6 °C

**DASY4 Configuration:**

- Probe: EX3DV3 - SN3514; ConvF(4.16, 4.16, 4.16); Calibrated: 2007/2/21
- Sensor-Surface: 2mm (Mechanical Surface Detection)
- Electronics: DAE4 Sn778; Calibrated: 2007/9/17
- Phantom: ELI 4.0; Type: QDOVA001BA; Serial: 1029
- Measurement SW: DASY4, V4.7 Build 55; Postprocessing SW: SEMCAD, V1.8 Build 176

**Pin=100mW/Area Scan (91x91x1):** Measurement grid: dx=10mm, dy=10mm

Maximum value of SAR (interpolated) = 14.1 mW/g

**Pin=100mW/Zoom Scan (8x8x8)/Cube 0:** Measurement grid: dx=4.3mm, dy=4.3mm, dz=3mm

Reference Value = 50.9 V/m; Power Drift = -0.026 dB

Peak SAR (extrapolated) = 30.8 W/kg

**SAR(1 g) = 6.6 mW/g; SAR(10 g) = 1.81 mW/g**

Maximum value of SAR (measured) = 13.4 mW/g

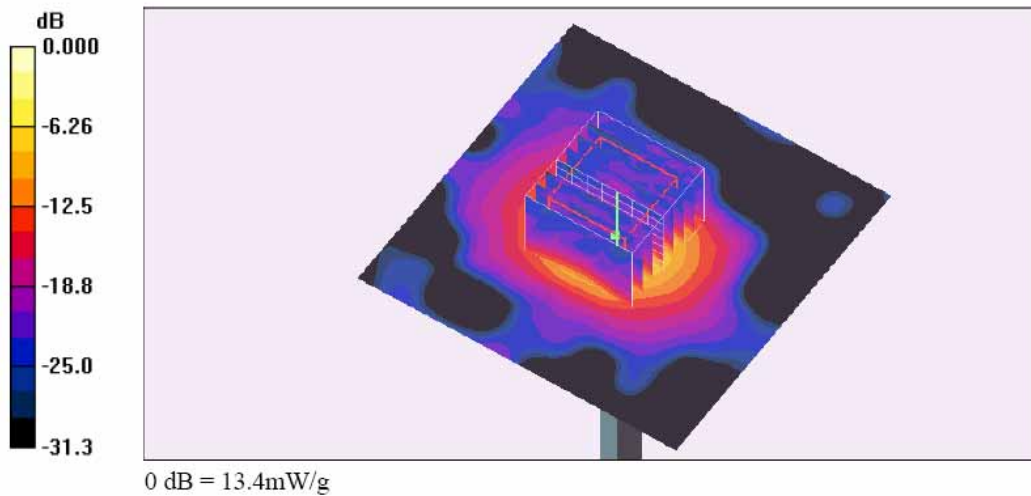



## Appendix B - SAR Measurement Data

Test Laboratory: Sporton International Inc. SAR/HAC Testing Lab

Date : 2007/12/26

### Body\_802.11b Ch6\_NB Bottom with 0cm Gap\_Ant-1\_DELL D500

DUT: 7D1410

Communication System: 802.11b ; Frequency: 2437 MHz;Duty Cycle: 1:1

Medium: MSL\_2450 Medium parameters used:  $f = 2437$  MHz;  $\sigma = 1.95$  mho/m;  $\epsilon_r = 53.4$ ;  $\rho = 1000$  kg/m<sup>3</sup>

Ambient Temperature : 22.9 °C ; Liquid Temperature : 21.5 °C

DASY4 Configuration:

- Probe: ET3DV6 - SN1787; ConvF(4.02, 4.02, 4.02); Calibrated: 2007/8/28
- Sensor-Surface: 4mm (Mechanical Surface Detection)
- Electronics: DAE4 Sn778; Calibrated: 2007/9/17
- Phantom: ELI 4.0; Type: QDOVA001BA; Serial: 1029
- Measurement SW: DASY4, V4.7 Build 55; Postprocessing SW: SEMCAD, V1.8 Build 176

**Ch6/Area Scan (61x51x1):** Measurement grid: dx=15mm, dy=15mm

Maximum value of SAR (interpolated) = 0.382 mW/g

**Ch6/Zoom Scan (5x5x7)/Cube 0:** Measurement grid: dx=8mm, dy=8mm, dz=5mm

Reference Value = 11.2 V/m; Power Drift = -0.101 dB

Peak SAR (extrapolated) = 0.565 W/kg

**SAR(1 g) = 0.294 mW/g; SAR(10 g) = 0.162 mW/g**

Maximum value of SAR (measured) = 0.311 mW/g

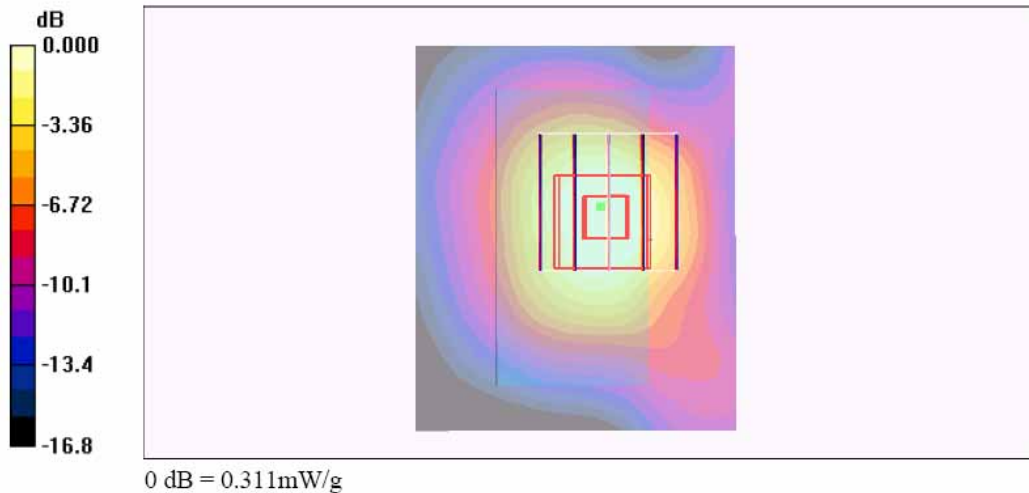

Test Laboratory: Sporton International Inc. SAR/HAC Testing Lab

Date : 2007/12/26

**Body\_802.11b Ch6\_NB Bottom with 0cm Gap\_Ant-3\_DELL D500**

**DUT: 7D1410**

Communication System: 802.11b ; Frequency: 2437 MHz;Duty Cycle: 1:1

Medium: MSL\_2450 Medium parameters used:  $f = 2437$  MHz;  $\sigma = 1.95$  mho/m;  $\epsilon_r = 53.4$ ;  $\rho = 1000$  kg/m<sup>3</sup>

Ambient Temperature : 22.9 °C ; Liquid Temperature : 21.5 °C

DASY4 Configuration:

- Probe: ET3DV6 - SN1787; ConvF(4.02, 4.02, 4.02); Calibrated: 2007/8/28
- Sensor-Surface: 4mm (Mechanical Surface Detection)
- Electronics: DAE4 Sn778; Calibrated: 2007/9/17
- Phantom: ELI 4.0; Type: QDOVA001BA; Serial: 1029
- Measurement SW: DASY4, V4.7 Build 55; Postprocessing SW: SEMCAD, V1.8 Build 176

**Ch6/Area Scan (61x51x1):** Measurement grid: dx=15mm, dy=15mm

Maximum value of SAR (interpolated) = 0.343 mW/g

**Ch6/Zoom Scan (5x5x7)/Cube 0:** Measurement grid: dx=8mm, dy=8mm, dz=5mm

Reference Value = 11.2 V/m; Power Drift = -0.098 dB

Peak SAR (extrapolated) = 0.595 W/kg

**SAR(1 g) = 0.309 mW/g; SAR(10 g) = 0.168 mW/g**

Maximum value of SAR (measured) = 0.331 mW/g

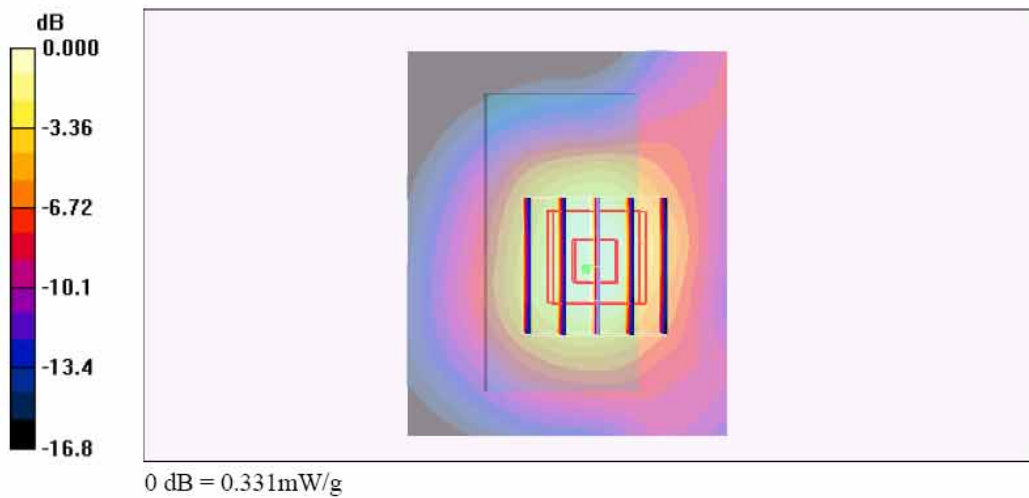

Test Laboratory: Sporton International Inc. SAR/HAC Testing Lab

Date : 2007/12/26

**Body\_802.11g Ch6\_NB Bottom with 0cm Gap\_Ant-1\_DELL D500**

**DUT: 7D1410**

Communication System: 802.11g; Frequency: 2437 MHz; Duty Cycle: 1:1

Medium: MSL\_2450 Medium parameters used:  $f = 2437$  MHz;  $\sigma = 1.95$  mho/m;  $\epsilon_r = 53.4$ ;  $\rho = 1000$  kg/m<sup>3</sup>

Ambient Temperature : 22.9 °C; Liquid Temperature : 21.5 °C

DASY4 Configuration:

- Probe: ET3DV6 - SN1787; ConvF(4.02, 4.02, 4.02); Calibrated: 2007/8/28
- Sensor-Surface: 4mm (Mechanical Surface Detection)
- Electronics: DAE4 Sn778; Calibrated: 2007/9/17
- Phantom: ELI 4.0; Type: QDOVA001BA; Serial: 1029
- Measurement SW: DASY4, V4.7 Build 55; Postprocessing SW: SEMCAD, V1.8 Build 176

**Ch6/Area Scan (61x51x1):** Measurement grid: dx=15mm, dy=15mm

Maximum value of SAR (interpolated) = 0.208 mW/g

**Ch6/Zoom Scan (5x5x7)/Cube 0:** Measurement grid: dx=8mm, dy=8mm, dz=5mm

Reference Value = 7.25 V/m; Power Drift = -0.141 dB

Peak SAR (extrapolated) = 0.343 W/kg

**SAR(1 g) = 0.177 mW/g; SAR(10 g) = 0.096 mW/g**

Maximum value of SAR (measured) = 0.192 mW/g

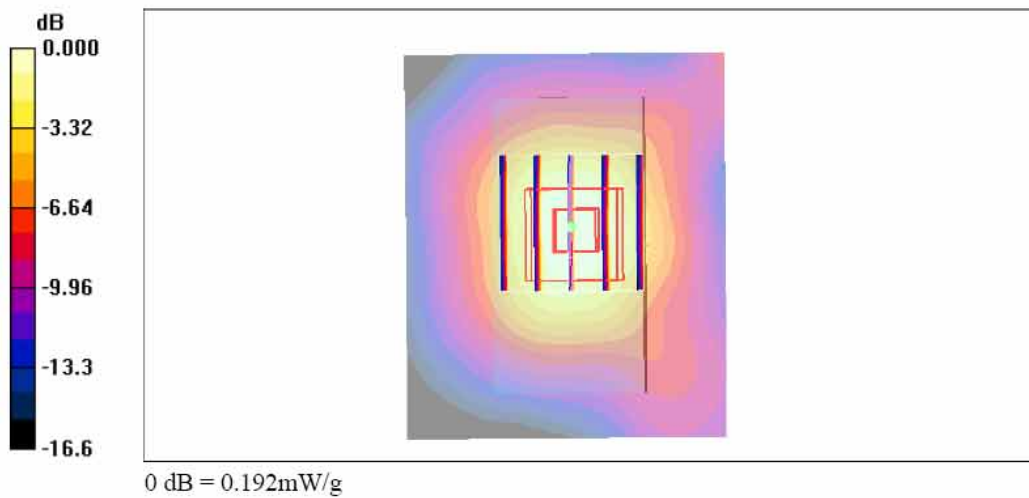

Test Laboratory: Sporton International Inc. SAR/HAC Testing Lab

Date : 2007/12/26

**Body\_802.11g Ch6\_NB Bottom with 0cm Gap\_Ant-3\_DELL D500**

**DUT: 7D1410**

Communication System: 802.11g; Frequency: 2437 MHz; Duty Cycle: 1:1

Medium: MSL\_2450 Medium parameters used:  $f = 2437$  MHz;  $\sigma = 1.95$  mho/m;  $\epsilon_r = 53.4$ ;  $\rho = 1000$  kg/m<sup>3</sup>

Ambient Temperature : 22.9 °C; Liquid Temperature : 21.5 °C

DASY4 Configuration:

- Probe: ET3DV6 - SN1787; ConvF(4.02, 4.02, 4.02); Calibrated: 2007/8/28
- Sensor-Surface: 4mm (Mechanical Surface Detection)
- Electronics: DAE4 Sn778; Calibrated: 2007/9/17
- Phantom: ELI 4.0; Type: QDOVA001BA; Serial: 1029
- Measurement SW: DASY4, V4.7 Build 55; Postprocessing SW: SEMCAD, V1.8 Build 176

**Ch6/Area Scan (61x51x1):** Measurement grid: dx=15mm, dy=15mm

Maximum value of SAR (interpolated) = 0.187 mW/g

**Ch6/Zoom Scan (5x5x7)/Cube 0:** Measurement grid: dx=8mm, dy=8mm, dz=5mm

Reference Value = 7.47 V/m; Power Drift = 0.051 dB

Peak SAR (extrapolated) = 0.321 W/kg

**SAR(1 g) = 0.163 mW/g; SAR(10 g) = 0.089 mW/g**

Maximum value of SAR (measured) = 0.173 mW/g

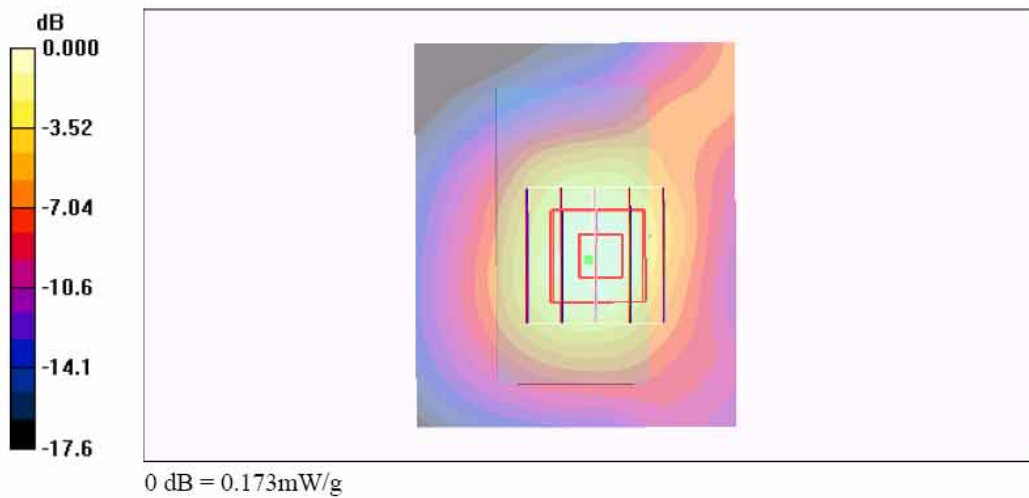

Test Laboratory: Sporton International Inc. SAR/HAC Testing Lab

Date : 2007/12/26

**Body\_802.11n\_Ch6\_NB Bottom with 0cm Gap\_Ant-1\_BW 20M\_DELL D500****DUT: 7D1410**

Communication System: 802.11n; Frequency: 2437 MHz; Duty Cycle: 1:1

Medium: MSL\_2450 Medium parameters used:  $f = 2437$  MHz;  $\sigma = 1.95$  mho/m;  $\epsilon_r = 53.4$ ;  $\rho = 1000$  kg/m<sup>3</sup>

Ambient Temperature : 22.9 °C; Liquid Temperature : 21.5 °C

DASY4 Configuration:

- Probe: ET3DV6 - SN1787; ConvF(4.02, 4.02, 4.02); Calibrated: 2007/8/28
- Sensor-Surface: 4mm (Mechanical Surface Detection)
- Electronics: DAE4 Sn778; Calibrated: 2007/9/17
- Phantom: ELI 4.0; Type: QDOVA001BA; Serial: 1029
- Measurement SW: DASY4, V4.7 Build 55; Postprocessing SW: SEMCAD, V1.8 Build 176

**Ch6/Area Scan (61x51x1):** Measurement grid: dx=15mm, dy=15mm

Maximum value of SAR (interpolated) = 0.190 mW/g

**Ch6/Zoom Scan (5x5x7)/Cube 0:** Measurement grid: dx=8mm, dy=8mm, dz=5mm

Reference Value = 7.48 V/m; Power Drift = -0.119 dB

Peak SAR (extrapolated) = 0.306 W/kg

**SAR(1 g) = 0.155 mW/g; SAR(10 g) = 0.084 mW/g**

Maximum value of SAR (measured) = 0.164 mW/g

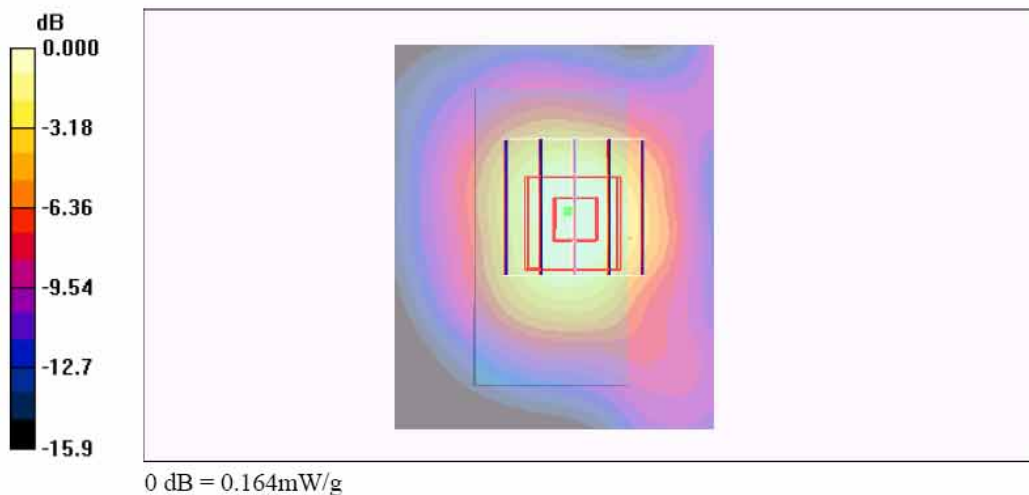

Test Laboratory: Sporton International Inc. SAR/HAC Testing Lab

Date : 2007/12/26

**Body\_802.11n\_Ch6\_NB Bottom with 0cm Gap\_Ant-3\_BW 20M\_DELL D500**

**DUT: 7D1410**

Communication System: 802.11n; Frequency: 2437 MHz; Duty Cycle: 1:1

Medium: MSL\_2450 Medium parameters used:  $f = 2437$  MHz;  $\sigma = 1.95$  mho/m;  $\epsilon_r = 53.4$ ;  $\rho = 1000$  kg/m<sup>3</sup>

Ambient Temperature : 22.9 °C; Liquid Temperature : 21.5 °C

DASY4 Configuration:

- Probe: ET3DV6 - SN1787; ConvF(4.02, 4.02, 4.02); Calibrated: 2007/8/28
- Sensor-Surface: 4mm (Mechanical Surface Detection)
- Electronics: DAE4 Sn778; Calibrated: 2007/9/17
- Phantom: ELI 4.0; Type: QDOVA001BA; Serial: 1029
- Measurement SW: DASY4, V4.7 Build 55; Postprocessing SW: SEMCAD, V1.8 Build 176

**Ch6/Area Scan (61x51x1):** Measurement grid: dx=15mm, dy=15mm

Maximum value of SAR (interpolated) = 0.156 mW/g

**Ch6/Zoom Scan (5x5x7)/Cube 0:** Measurement grid: dx=8mm, dy=8mm, dz=5mm

Reference Value = 7.59 V/m; Power Drift = -0.019 dB

Peak SAR (extrapolated) = 0.261 W/kg

**SAR(1 g) = 0.135 mW/g; SAR(10 g) = 0.074 mW/g**

Maximum value of SAR (measured) = 0.145 mW/g

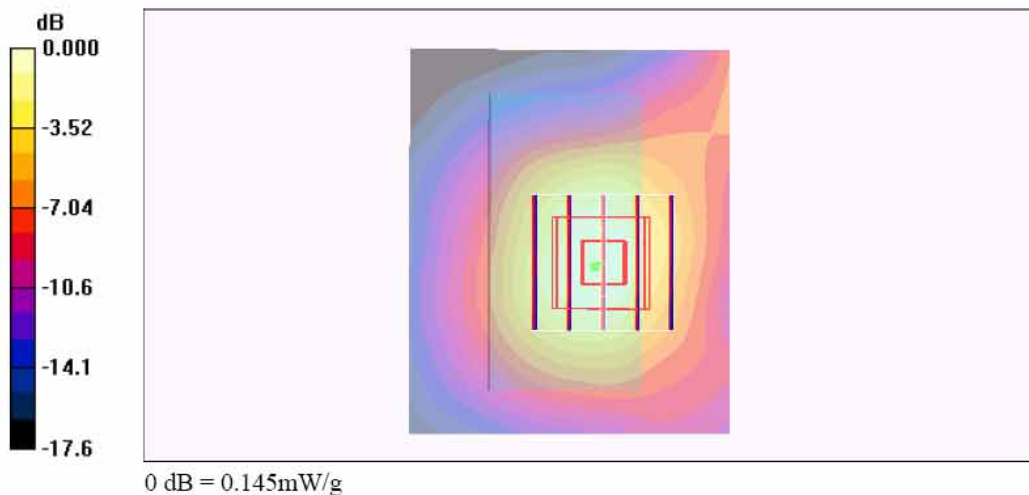

Test Laboratory: Sporton International Inc. SAR/HAC Testing Lab

Date : 2007/12/26

**Body\_802.11n\_Ch6\_NB Bottom with 0cm Gap\_Ant1&3 2Tx\_BW 20M\_DELL D500**

**DUT: 7D1410**

Communication System: 802.11n; Frequency: 2437 MHz; Duty Cycle: 1:1

Medium: MSL\_2450 Medium parameters used:  $f = 2437$  MHz;  $\sigma = 1.95$  mho/m;  $\epsilon_r = 53.4$ ;  $\rho = 1000$  kg/m<sup>3</sup>

Ambient Temperature : 22.9 °C; Liquid Temperature : 21.5 °C

DASY4 Configuration:

- Probe: ET3DV6 - SN1787; ConvF(4.02, 4.02, 4.02); Calibrated: 2007/8/28
- Sensor-Surface: 4mm (Mechanical Surface Detection)
- Electronics: DAE4 Sn778; Calibrated: 2007/9/17
- Phantom: ELI 4.0; Type: QDOVA001BA; Serial: 1029
- Measurement SW: DASY4, V4.7 Build 55; Postprocessing SW: SEMCAD, V1.8 Build 176

**Ch6/Area Scan (61x51x1):** Measurement grid: dx=15mm, dy=15mm

Maximum value of SAR (interpolated) = 0.262 mW/g

**Ch6/Zoom Scan (5x5x7)/Cube 0:** Measurement grid: dx=8mm, dy=8mm, dz=5mm

Reference Value = 10.2 V/m; Power Drift = -0.007 dB

Peak SAR (extrapolated) = 0.455 W/kg

**SAR(1 g) = 0.234 mW/g; SAR(10 g) = 0.128 mW/g**

Maximum value of SAR (measured) = 0.247 mW/g

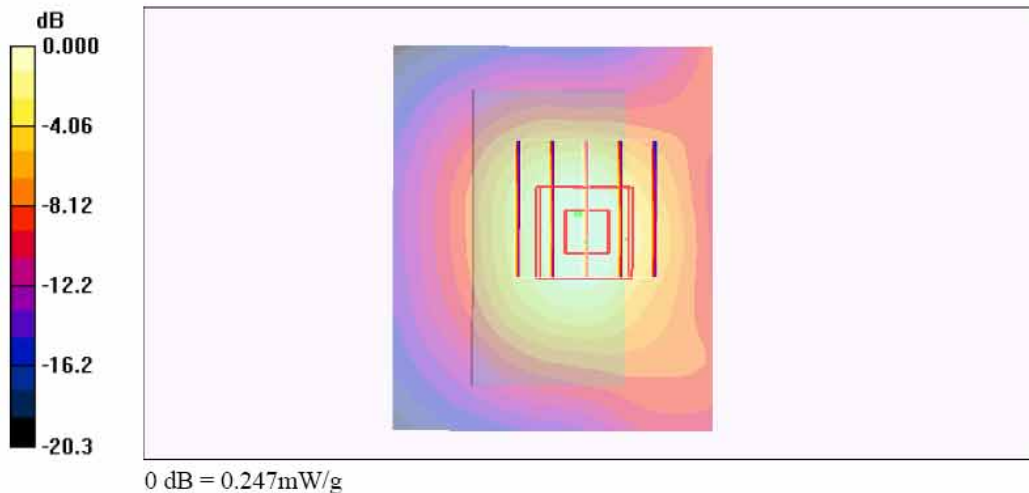

Test Laboratory: Sporton International Inc. SAR/HAC Testing Lab

Date : 2007/12/26

**Body\_802.11n\_Ch6\_NB Bottom with 0cm Gap\_Ant-1\_BW 40M\_DELL D500**

**DUT: 7D1410**

Communication System: 802.11n; Frequency: 2437 MHz; Duty Cycle: 1:1

Medium: MSL\_2450 Medium parameters used:  $f = 2437$  MHz;  $\sigma = 1.95$  mho/m;  $\epsilon_r = 53.4$ ;  $\rho = 1000$  kg/m<sup>3</sup>

Ambient Temperature : 22.9 °C; Liquid Temperature : 21.5 °C

DASY4 Configuration:

- Probe: ET3DV6 - SN1787; ConvF(4.02, 4.02, 4.02); Calibrated: 2007/8/28
- Sensor-Surface: 4mm (Mechanical Surface Detection)
- Electronics: DAE4 Sn778; Calibrated: 2007/9/17
- Phantom: ELI 4.0; Type: QDOVA001BA; Serial: 1029
- Measurement SW: DASY4, V4.7 Build 55; Postprocessing SW: SEMCAD, V1.8 Build 176

**Ch6/Area Scan (61x51x1):** Measurement grid: dx=15mm, dy=15mm

Maximum value of SAR (interpolated) = 0.080 mW/g

**Ch6/Zoom Scan (5x5x7)/Cube 0:** Measurement grid: dx=8mm, dy=8mm, dz=5mm

Reference Value = 5.16 V/m; Power Drift = 0.024 dB

Peak SAR (extrapolated) = 0.135 W/kg

**SAR(1 g) = 0.067 mW/g; SAR(10 g) = 0.037 mW/g**

Maximum value of SAR (measured) = 0.069 mW/g

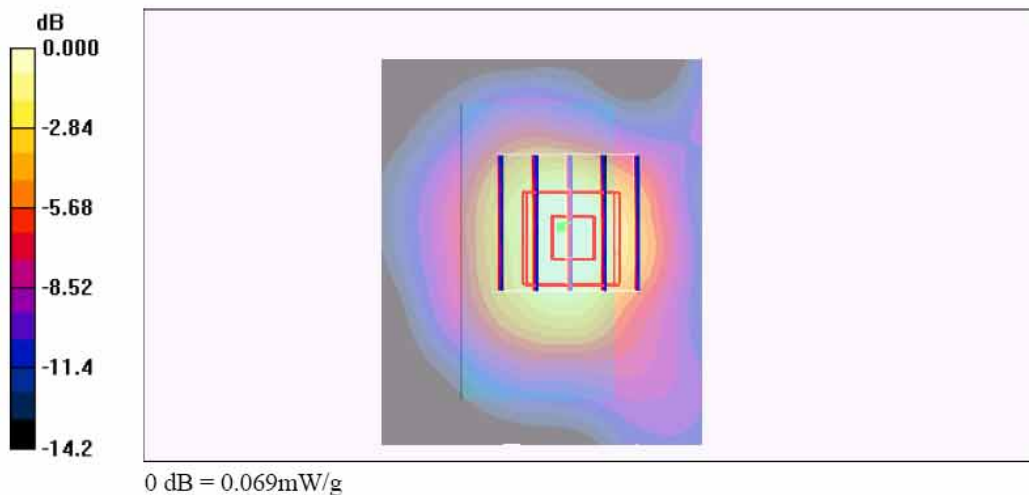



Test Laboratory: Sporton International Inc. SAR/HAC Testing Lab

Date: 2007/12/26

**Body\_802.11n\_Ch6\_NB Bottom with 0cm Gap\_Ant-3\_BW 40M\_DELL D500**

**DUT: 7D1410**

Communication System: 802.11n; Frequency: 2437 MHz; Duty Cycle: 1:1

Medium: MSL\_2450 Medium parameters used:  $f = 2437$  MHz;  $\sigma = 1.95$  mho/m;  $\epsilon_r = 53.4$ ;  $\rho = 1000$  kg/m<sup>3</sup>

Ambient Temperature : 22.9 °C; Liquid Temperature : 21.5 °C

DASY4 Configuration:

- Probe: ET3DV6 - SN1787; ConvF(4.02, 4.02, 4.02); Calibrated: 2007/8/28
- Sensor-Surface: 4mm (Mechanical Surface Detection)
- Electronics: DAE4 Sn778; Calibrated: 2007/9/17
- Phantom: ELI 4.0; Type: QDOVA001BA; Serial: 1029
- Measurement SW: DASY4, V4.7 Build 55; Postprocessing SW: SEMCAD, V1.8 Build 176

**Ch6/Area Scan (61x51x1):** Measurement grid: dx=15mm, dy=15mm

Maximum value of SAR (interpolated) = 0.067 mW/g

**Ch6/Zoom Scan (5x5x7)/Cube 0:** Measurement grid: dx=8mm, dy=8mm, dz=5mm

Reference Value = 4.76 V/m; Power Drift = 0.031 dB

Peak SAR (extrapolated) = 0.128 W/kg

**SAR(1 g) = 0.061 mW/g; SAR(10 g) = 0.034 mW/g**

Maximum value of SAR (measured) = 0.064 mW/g

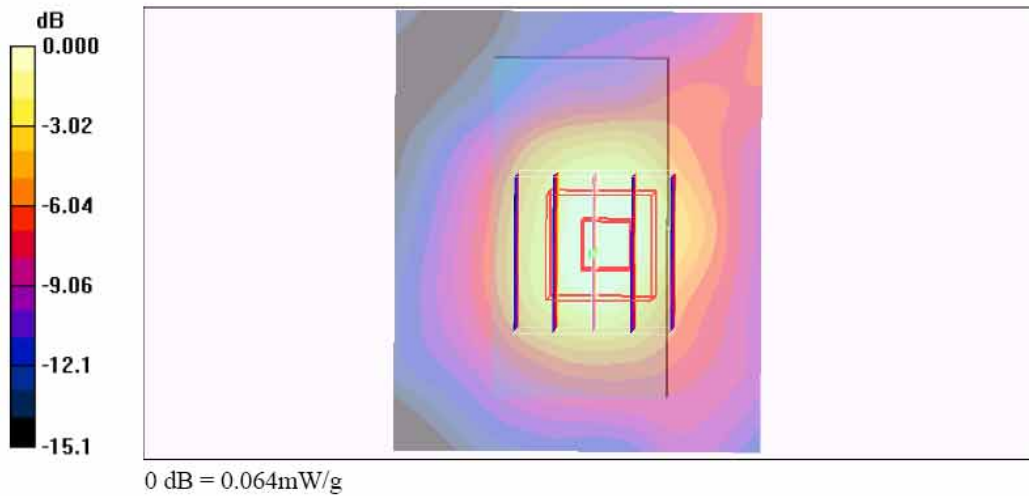

Test Laboratory: Sporton International Inc. SAR/HAC Testing Lab

Date : 2007/12/26

**Body\_802.11n\_Ch6\_NB Bottom with 0cm Gap\_Ant1&3 2Tx\_BW 40M\_DELL D500**

**DUT: 7D1410**

Communication System: 802.11n; Frequency: 2437 MHz; Duty Cycle: 1:1

Medium: MSL\_2450 Medium parameters used:  $f = 2437$  MHz;  $\sigma = 1.95$  mho/m;  $\epsilon_r = 53.4$ ;  $\rho = 1000$  kg/m<sup>3</sup>

Ambient Temperature : 22.9 °C; Liquid Temperature : 21.5 °C

DASY4 Configuration:

- Probe: ET3DV6 - SN1787; ConvF(4.02, 4.02, 4.02); Calibrated: 2007/8/28
- Sensor-Surface: 4mm (Mechanical Surface Detection)
- Electronics: DAE4 Sn778; Calibrated: 2007/9/17
- Phantom: ELI 4.0; Type: QDOVA001BA; Serial: 1029
- Measurement SW: DASY4, V4.7 Build 55; Postprocessing SW: SEMCAD, V1.8 Build 176

**Ch6/Area Scan (61x51x1):** Measurement grid: dx=15mm, dy=15mm

Maximum value of SAR (interpolated) = 0.095 mW/g

**Ch6/Zoom Scan (5x5x7)/Cube 0:** Measurement grid: dx=8mm, dy=8mm, dz=5mm

Reference Value = 6.04 V/m; Power Drift = -0.055 dB

Peak SAR (extrapolated) = 0.161 W/kg

**SAR(1 g) = 0.086 mW/g; SAR(10 g) = 0.048 mW/g**

Maximum value of SAR (measured) = 0.092 mW/g

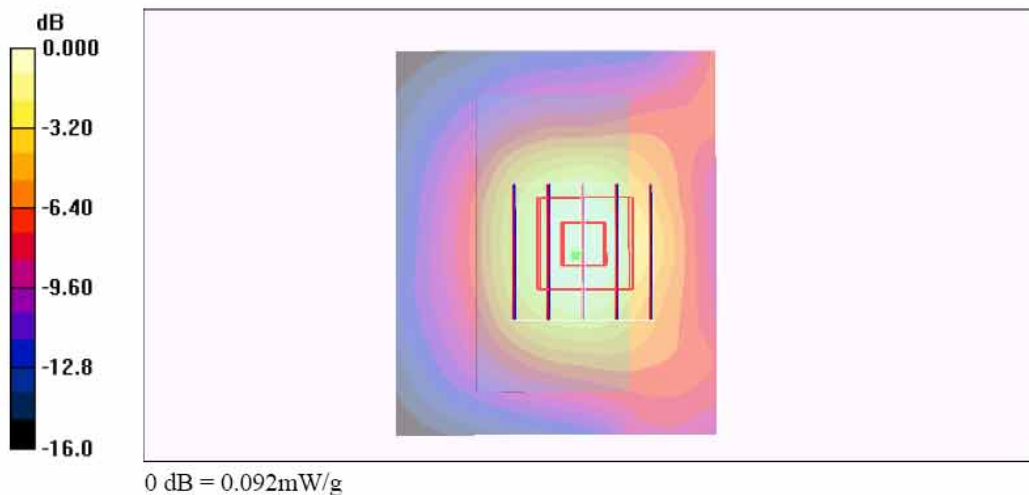

Test Laboratory: Sporton International Inc. SAR/HAC Testing Lab

Date: 2007/12/26

**Body\_802.11b Ch6\_NB Bottom with 0cm Gap\_Ant-3\_DELL M2300**

**DUT: 7D1410**

Communication System: 802.11b ; Frequency: 2437 MHz;Duty Cycle: 1:1

Medium: MSL\_2450 Medium parameters used:  $f = 2437$  MHz;  $\sigma = 1.95$  mho/m;  $\epsilon_r = 53.4$ ;  $\rho = 1000$  kg/m<sup>3</sup>

Ambient Temperature : 23.0 °C ; Liquid Temperature : 21.5 °C

DASY4 Configuration:

- Probe: ET3DV6 - SN1787; ConvF(4.02, 4.02, 4.02); Calibrated: 2007/8/28
- Sensor-Surface: 4mm (Mechanical Surface Detection)
- Electronics: DAE4 Sn778; Calibrated: 2007/9/17
- Phantom: ELI 4.0; Type: QDOVA001BA; Serial: 1029
- Measurement SW: DASY4, V4.7 Build 55; Postprocessing SW: SEMCAD, V1.8 Build 176

**Ch6/Area Scan (61x51x1):** Measurement grid: dx=15mm, dy=15mm

Maximum value of SAR (interpolated) = 0.212 mW/g

**Ch6/Zoom Scan (5x5x7)/Cube 0:** Measurement grid: dx=8mm, dy=8mm, dz=5mm

Reference Value = 6.93 V/m; Power Drift = -0.142 dB

Peak SAR (extrapolated) = 0.354 W/kg

**SAR(1 g) = 0.181 mW/g; SAR(10 g) = 0.099 mW/g**

Maximum value of SAR (measured) = 0.195 mW/g

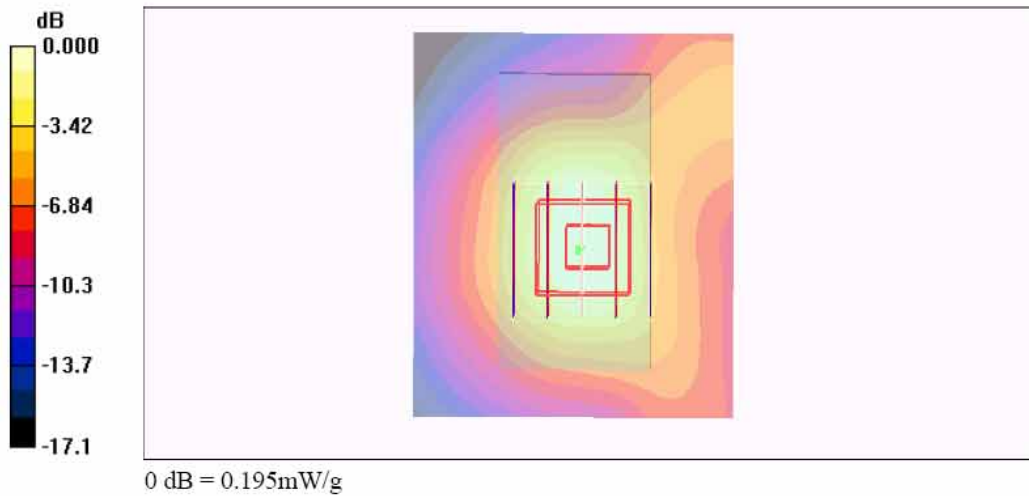

Test Laboratory: Sporton International Inc. SAR/HAC Testing Lab

Date: 2007/12/26

**Body\_802.11b Ch6\_NB Bottom with 0cm Gap\_Ant-3\_IBM 2653**

**DUT: 7D1410**

Communication System: 802.11b ; Frequency: 2437 MHz;Duty Cycle: 1:1

Medium: MSL\_2450 Medium parameters used:  $f = 2437$  MHz;  $\sigma = 1.95$  mho/m;  $\epsilon_r = 53.4$ ;  $\rho = 1000$  kg/m<sup>3</sup>

Ambient Temperature : 23.1 °C ; Liquid Temperature : 21.5 °C

DASY4 Configuration:

- Probe: ET3DV6 - SN1787; ConvF(4.02, 4.02, 4.02); Calibrated: 2007/8/28
- Sensor-Surface: 4mm (Mechanical Surface Detection)
- Electronics: DAE4 Sn778; Calibrated: 2007/9/17
- Phantom: ELI 4.0; Type: QDOVA001BA; Serial: 1029
- Measurement SW: DASY4, V4.7 Build 55; Postprocessing SW: SEMCAD, V1.8 Build 176

**Ch6/Area Scan (61x51x1):** Measurement grid: dx=15mm, dy=15mm

Maximum value of SAR (interpolated) = 0.132 mW/g

**Ch6/Zoom Scan (5x5x7)/Cube 0:** Measurement grid: dx=8mm, dy=8mm, dz=5mm

Reference Value = 6.57 V/m; Power Drift = -0.009 dB

Peak SAR (extrapolated) = 0.231 W/kg

**SAR(1 g) = 0.118 mW/g; SAR(10 g) = 0.068 mW/g**

Maximum value of SAR (measured) = 0.125 mW/g

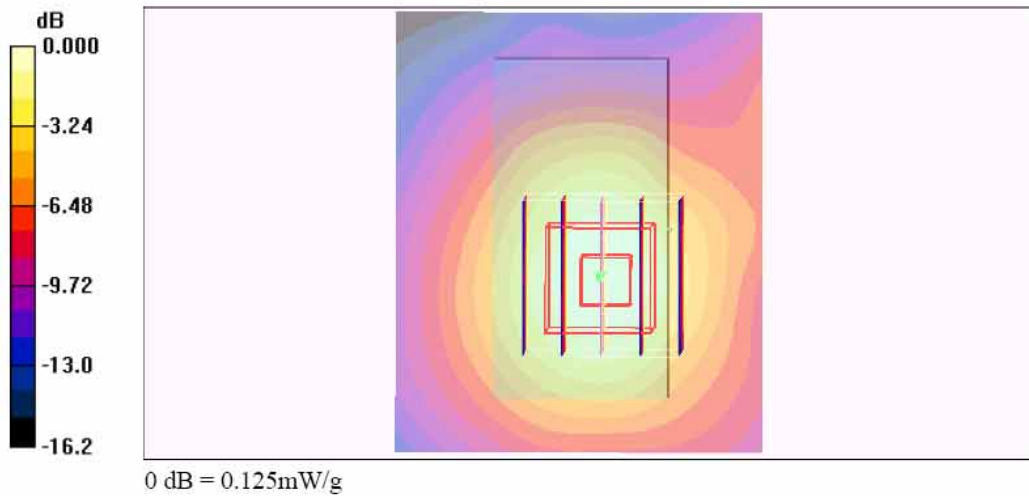

Test Laboratory: Sporton International Inc. SAR/HAC Testing Lab

Date: 2007/12/25

**Body\_802.11a Ch52\_NB Bottom with 0cm Gap\_Ant-1\_DELL D500**

**DUT: 7D1410**

Communication System: 802.11a; Frequency: 5260 MHz; Duty Cycle: 1:1

Medium: MSL\_5G Medium parameters used:  $f = 5300$  MHz;  $\sigma = 5.31$  mho/m;  $\epsilon_r = 48.4$ ;  $\rho = 1000$  kg/m<sup>3</sup>

Ambient Temperature : 22.6 °C; Liquid Temperature : 21.6 °C

DASY4 Configuration:

- Probe: EX3DV3 - SN3514; ConvF(4.31, 4.31, 4.31); Calibrated: 2007/2/21
- Sensor-Surface: 2mm (Mechanical Surface Detection)
- Electronics: DAE4 Sn778; Calibrated: 2007/9/17
- Phantom: ELI 4.0; Type: QDOVA001BA; Serial: 1029
- Measurement SW: DASY4, V4.7 Build 55; Postprocessing SW: SEMCAD, V1.8 Build 176

**Ch52/Area Scan (91x71x1):** Measurement grid: dx=10mm, dy=10mm

Maximum value of SAR (interpolated) = 0.910 mW/g

**Ch52/Zoom Scan (8x8x8)/Cube 0:** Measurement grid: dx=4.3mm, dy=4.3mm, dz=3mm

Reference Value = 6.18 V/m; Power Drift = 0.128 dB

Peak SAR (extrapolated) = 1.63 W/kg

**SAR(1 g) = 0.506 mW/g; SAR(10 g) = 0.222 mW/g**

Maximum value of SAR (measured) = 0.890 mW/g

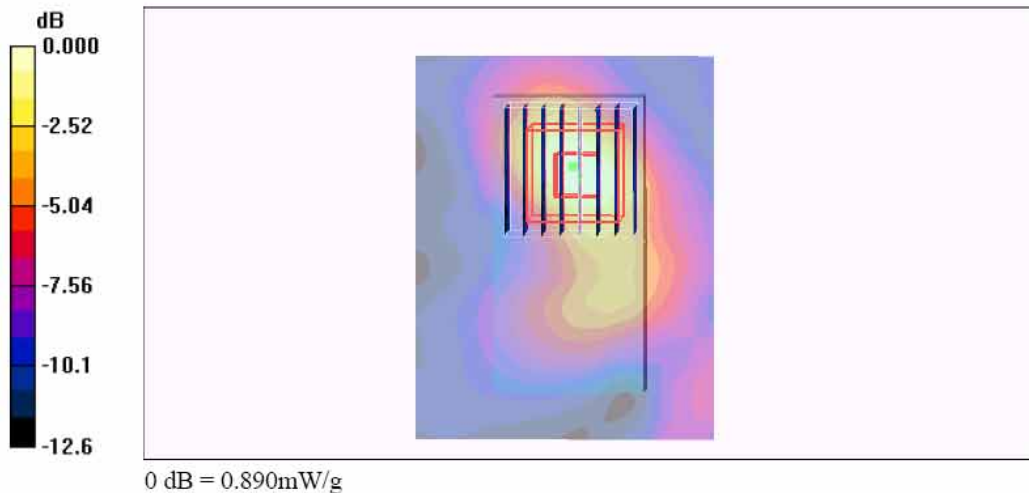

Test Laboratory: Sporton International Inc. SAR/HAC Testing Lab

Date: 2007/12/25

**Body\_802.11a Ch52\_NB Bottom with 0cm Gap\_Ant-3\_DELL D500**

**DUT: 7D1410**

Communication System: 802.11a; Frequency: 5260 MHz; Duty Cycle: 1:1

Medium: MSL\_5G Medium parameters used:  $f = 5300$  MHz;  $\sigma = 5.31$  mho/m;  $\epsilon_r = 48.4$ ;  $\rho = 1000$  kg/m<sup>3</sup>

Ambient Temperature : 22.7 °C; Liquid Temperature : 21.6 °C

DASY4 Configuration:

- Probe: EX3DV3 - SN3514; ConvF(4.31, 4.31, 4.31); Calibrated: 2007/2/21
- Sensor-Surface: 2mm (Mechanical Surface Detection)
- Electronics: DAE4 Sn778; Calibrated: 2007/9/17
- Phantom: ELI 4.0; Type: QDOVA001BA; Serial: 1029
- Measurement SW: DASY4, V4.7 Build 55; Postprocessing SW: SEMCAD, V1.8 Build 176

**Ch52/Area Scan (91x71x1):** Measurement grid: dx=10mm, dy=10mm

Maximum value of SAR (interpolated) = 1.29 mW/g

**Ch52/Zoom Scan (8x8x8)/Cube 0:** Measurement grid: dx=4.3mm, dy=4.3mm, dz=3mm

Reference Value = 7.94 V/m; Power Drift = 0.127 dB

Peak SAR (extrapolated) = 2.57 W/kg

**SAR(1 g) = 0.777 mW/g; SAR(10 g) = 0.349 mW/g**

Maximum value of SAR (measured) = 1.37 mW/g

**Ch52/Zoom Scan (8x8x8)/Cube 1:** Measurement grid: dx=4.3mm, dy=4.3mm, dz=3mm

Reference Value = 7.94 V/m; Power Drift = 0.127 dB

Peak SAR (extrapolated) = 2.56 W/kg

**SAR(1 g) = 0.597 mW/g; SAR(10 g) = 0.276 mW/g**

Maximum value of SAR (measured) = 1.33 mW/g

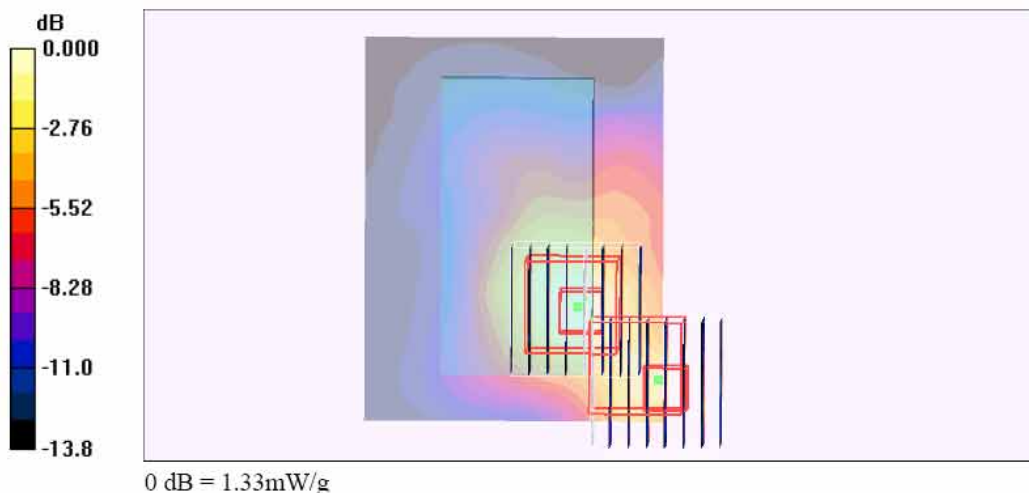

Test Laboratory: Sporton International Inc. SAR/HAC Testing Lab

Date: 2007/12/25

**Body\_802.11n\_Ch52\_NB Bottom with 0cm Gap\_Ant-1\_DELL D500\_BW 20M**

**DUT: 7D1410**

Communication System: 802.11n; Frequency: 5260 MHz; Duty Cycle: 1:1

Medium: MSL\_5G Medium parameters used:  $f = 5300$  MHz;  $\sigma = 5.31$  mho/m;  $\epsilon_r = 48.4$ ;  $\rho = 1000$  kg/m<sup>3</sup>

Ambient Temperature : 22.6 °C; Liquid Temperature : 21.6 °C

DASY4 Configuration:

- Probe: EX3DV3 - SN3514; ConvF(4.31, 4.31, 4.31); Calibrated: 2007/2/21
- Sensor-Surface: 2mm (Mechanical Surface Detection)
- Electronics: DAE4 Sn778; Calibrated: 2007/9/17
- Phantom: ELI 4.0; Type: QDOVA001BA; Serial: 1029
- Measurement SW: DASY4, V4.7 Build 55; Postprocessing SW: SEMCAD, V1.8 Build 176

**Ch52/Area Scan (91x71x1):** Measurement grid: dx=10mm, dy=10mm

Maximum value of SAR (interpolated) = 0.904 mW/g

**Ch52/Zoom Scan (8x8x8)/Cube 0:** Measurement grid: dx=4.3mm, dy=4.3mm, dz=3mm

Reference Value = 6.61 V/m; Power Drift = 0.078 dB

Peak SAR (extrapolated) = 1.54 W/kg

**SAR(1 g) = 0.498 mW/g; SAR(10 g) = 0.219 mW/g**

Maximum value of SAR (measured) = 0.883 mW/g

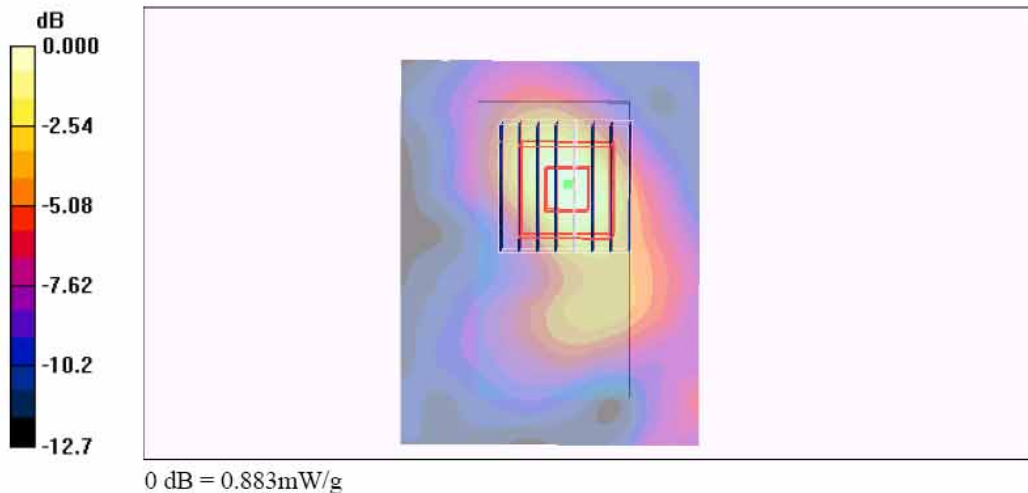

Test Laboratory: Sporton International Inc. SAR/HAC Testing Lab

Date: 2007/12/25

**Body\_802.11n\_Ch52\_NB Bottom with 0cm Gap\_Ant-3\_DELL D500\_BW 20M**

**DUT: 7D1410**

Communication System: 802.11n; Frequency: 5260 MHz; Duty Cycle: 1:1

Medium: MSL\_5G Medium parameters used:  $f = 5300$  MHz;  $\sigma = 5.31$  mho/m;  $\epsilon_r = 48.4$ ;  $\rho = 1000$  kg/m<sup>3</sup>

Ambient Temperature : 22.6 °C; Liquid Temperature : 21.6 °C

DASY4 Configuration:

- Probe: EX3DV3 - SN3514; ConvF(4.31, 4.31, 4.31); Calibrated: 2007/2/21
- Sensor-Surface: 2mm (Mechanical Surface Detection)
- Electronics: DAE4 Sn778; Calibrated: 2007/9/17
- Phantom: ELI 4.0; Type: QDOVA001BA; Serial: 1029
- Measurement SW: DASY4, V4.7 Build 55; Postprocessing SW: SEMCAD, V1.8 Build 176

**Ch52/Area Scan (91x71x1):** Measurement grid: dx=10mm, dy=10mm

Maximum value of SAR (interpolated) = 0.333 mW/g

**Ch52/Zoom Scan (8x8x8)/Cube 0:** Measurement grid: dx=4.3mm, dy=4.3mm, dz=3mm

Reference Value = 4.84 V/m; Power Drift = 0.077 dB

Peak SAR (extrapolated) = 0.637 W/kg

**SAR(1 g) = 0.211 mW/g; SAR(10 g) = 0.117 mW/g**

Maximum value of SAR (measured) = 0.339 mW/g

**Ch52/Zoom Scan (8x8x8)/Cube 1:** Measurement grid: dx=4.3mm, dy=4.3mm, dz=3mm

Reference Value = 4.84 V/m; Power Drift = 0.077 dB

Peak SAR (extrapolated) = 0.570 W/kg

**SAR(1 g) = 0.184 mW/g; SAR(10 g) = 0.106 mW/g**

Maximum value of SAR (measured) = 0.331 mW/g

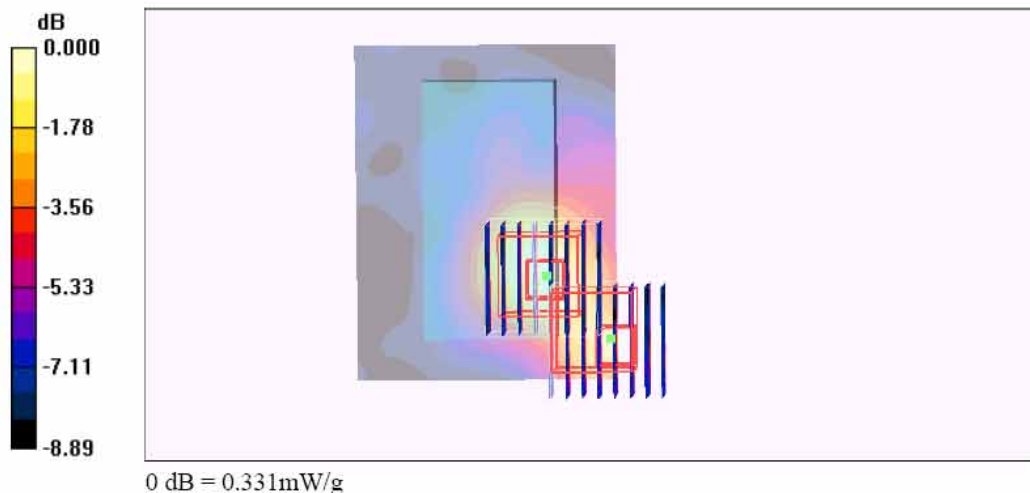



Test Laboratory: Sporton International Inc. SAR/HAC Testing Lab

Date: 2007/12/25

**Body\_802.11n Ch52\_NB Bottom with 0cm Gap\_Ant-1&3 2Tx\_DELL D500\_BW 20M**

**DUT: 7D1410**

Communication System: 802.11n; Frequency: 5260 MHz; Duty Cycle: 1:1

Medium: MSL\_5G Medium parameters used:  $f = 5300$  MHz;  $\sigma = 5.31$  mho/m;  $\epsilon_r = 48.4$ ;  $\rho = 1000$  kg/m<sup>3</sup>

Ambient Temperature : 22.6 °C; Liquid Temperature : 21.6 °C

**DASY4 Configuration:**

- Probe: EX3DV3 - SN3514; ConvF(4.31, 4.31, 4.31); Calibrated: 2007/2/21
- Sensor-Surface: 2mm (Mechanical Surface Detection)
- Electronics: DAE4 Sn778; Calibrated: 2007/9/17
- Phantom: ELI 4.0; Type: QDOVA001BA; Serial: 1029
- Measurement SW: DASY4, V4.7 Build 55; Postprocessing SW: SEMCAD, V1.8 Build 176

**Ch52/Area Scan (91x71x1):** Measurement grid: dx=10mm, dy=10mm

Maximum value of SAR (interpolated) = 1.59 mW/g

**Ch52/Zoom Scan (8x8x8)/Cube 0:** Measurement grid: dx=4.3mm, dy=4.3mm, dz=3mm

Reference Value = 9.52 V/m; Power Drift = -0.037 dB

Peak SAR (extrapolated) = 2.79 W/kg

SAR(1 g) = 0.877 mW/g; SAR(10 g) = 0.392 mW/g

Maximum value of SAR (measured) = 1.51 mW/g

**Ch52/Zoom Scan (8x8x8)/Cube 1:** Measurement grid: dx=4.3mm, dy=4.3mm, dz=3mm

Reference Value = 9.52 V/m; Power Drift = -0.037 dB

Peak SAR (extrapolated) = 2.78 W/kg

SAR(1 g) = 0.653 mW/g; SAR(10 g) = 0.296 mW/g

Maximum value of SAR (measured) = 1.46 mW/g

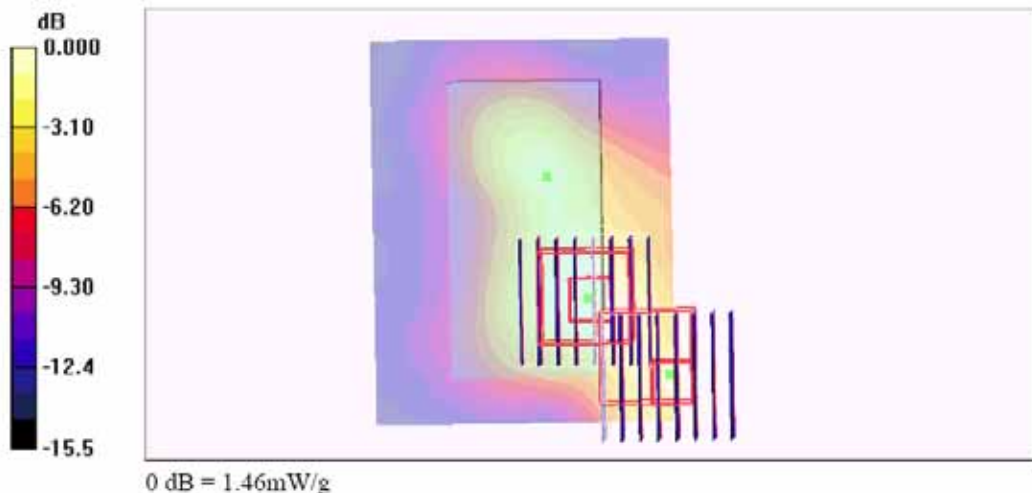

Test Laboratory: Sporton International Inc. SAR/HAC Testing Lab

Date: 2007/12/25

**Body\_802.11n\_Ch54\_NB Bottom with 0cm Gap\_Ant-1\_DELL D500\_BW 40M**

**DUT: 7D1410**

Communication System: 802.11n; Frequency: 5270 MHz; Duty Cycle: 1:1

Medium: MSL\_5G Medium parameters used:  $f = 5300$  MHz;  $\sigma = 5.31$  mho/m;  $\epsilon_r = 48.4$ ;  $\rho = 1000$  kg/m<sup>3</sup>

Ambient Temperature : 22.7 °C; Liquid Temperature : 21.6 °C

DASY4 Configuration:

- Probe: EX3DV3 - SN3514; ConvF(4.31, 4.31, 4.31); Calibrated: 2007/2/21
- Sensor-Surface: 2mm (Mechanical Surface Detection)
- Electronics: DAE4 Sn778; Calibrated: 2007/9/17
- Phantom: ELI 4.0; Type: QDOVA001BA; Serial: 1029
- Measurement SW: DASY4, V4.7 Build 55; Postprocessing SW: SEMCAD, V1.8 Build 176

**Ch54/Area Scan (91x71x1):** Measurement grid: dx=10mm, dy=10mm

Maximum value of SAR (interpolated) = 0.745 mW/g

**Ch54/Zoom Scan (8x8x8)/Cube 0:** Measurement grid: dx=4.3mm, dy=4.3mm, dz=3mm

Reference Value = 6.19 V/m; Power Drift = -0.136 dB

Peak SAR (extrapolated) = 1.34 W/kg

**SAR(1 g) = 0.419 mW/g; SAR(10 g) = 0.187 mW/g**

Maximum value of SAR (measured) = 0.732 mW/g

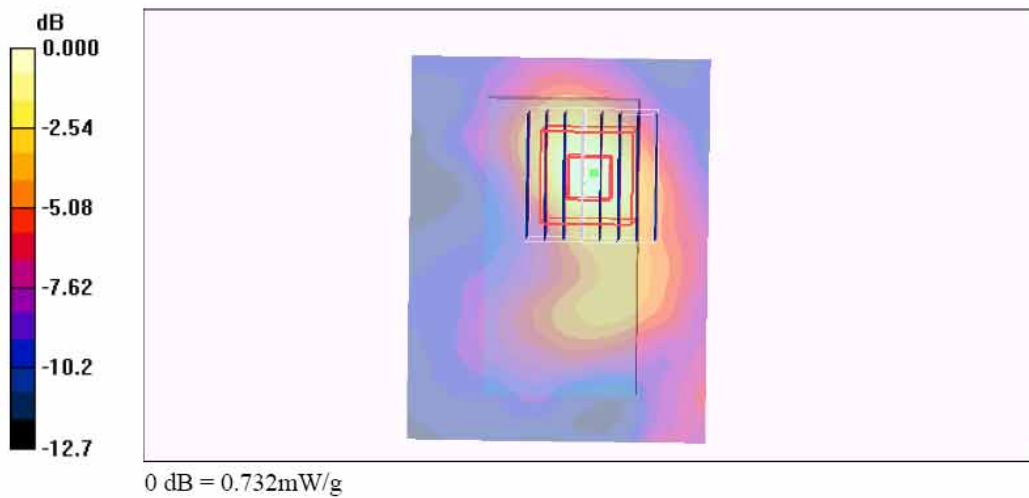

Test Laboratory: Sporton International Inc. SAR/HAC Testing Lab

Date: 2007/12/25

**Body\_802.11n\_Ch54\_NB Bottom with 0cm Gap\_Ant-3\_DELL D500\_BW 40M**

**DUT: 7D1410**

Communication System: 802.11n; Frequency: 5270 MHz; Duty Cycle: 1:1

Medium: MSL\_5G Medium parameters used:  $f = 5300 \text{ MHz}$ ;  $\sigma = 5.31 \text{ mho/m}$ ;  $\epsilon_r = 48.4$ ;  $\rho = 1000 \text{ kg/m}^3$

Ambient Temperature : 22.8 °C; Liquid Temperature : 21.6 °C

DASY4 Configuration:

- Probe: EX3DV3 - SN3514; ConvF(4.31, 4.31, 4.31); Calibrated: 2007/2/21
- Sensor-Surface: 2mm (Mechanical Surface Detection)
- Electronics: DAE4 Sn778; Calibrated: 2007/9/17
- Phantom: ELI 4.0; Type: QDOVA001BA; Serial: 1029
- Measurement SW: DASY4, V4.7 Build 55; Postprocessing SW: SEMCAD, V1.8 Build 176

**Ch54/Area Scan (91x71x1):** Measurement grid: dx=10mm, dy=10mm

Maximum value of SAR (interpolated) = 1.03 mW/g

**Ch54/Zoom Scan (8x8x8)/Cube 0:** Measurement grid: dx=4.3mm, dy=4.3mm, dz=3mm

Reference Value = 7.45 V/m; Power Drift = 0.056 dB

Peak SAR (extrapolated) = 1.95 W/kg

**SAR(1 g) = 0.598 mW/g; SAR(10 g) = 0.272 mW/g**

Maximum value of SAR (measured) = 1.04 mW/g

**Ch54/Zoom Scan (8x8x8)/Cube 1:** Measurement grid: dx=4.3mm, dy=4.3mm, dz=3mm

Reference Value = 7.45 V/m; Power Drift = 0.056 dB

Peak SAR (extrapolated) = 2.06 W/kg

**SAR(1 g) = 0.521 mW/g; SAR(10 g) = 0.233 mW/g**

Maximum value of SAR (measured) = 1.06 mW/g

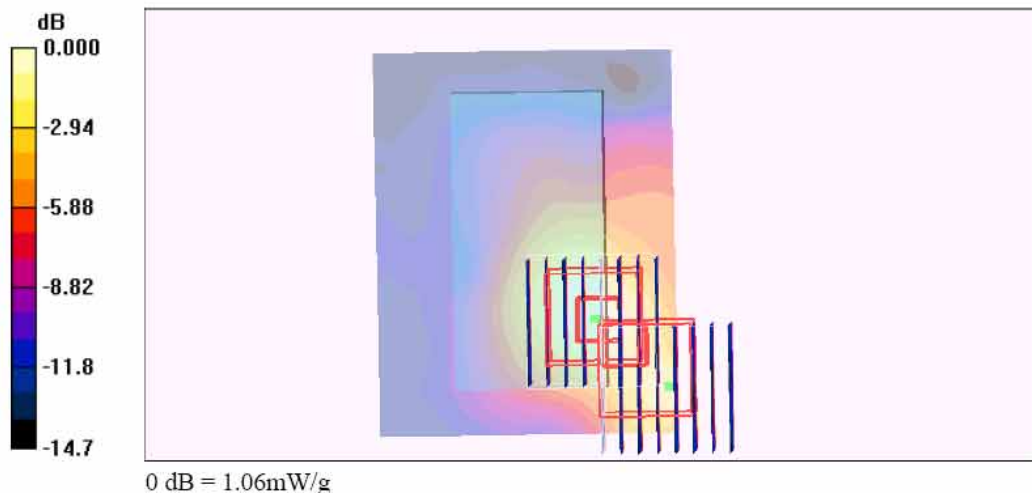

Test Laboratory: Sporton International Inc. SAR/HAC Testing Lab

Date: 2007/12/25

**Body\_802.11n Ch54\_NB Bottom with 0cm Gap\_Ant-1&3 2Tx\_DELL D500\_BW 40M**

**DUT: 7D1410**

Communication System: 802.11n; Frequency: 5270 MHz; Duty Cycle: 1:1

Medium: MSL\_5G Medium parameters used:  $f = 5300 \text{ MHz}$ ;  $\sigma = 5.31 \text{ mho/m}$ ;  $\epsilon_r = 48.4$ ;  $\rho = 1000 \text{ kg/m}^3$

Ambient Temperature : 22.7 °C; Liquid Temperature : 21.6 °C

DASY4 Configuration:

- Probe: EX3DV3 - SN3514; ConvF(4.31, 4.31, 4.31); Calibrated: 2007/2/21
- Sensor-Surface: 2mm (Mechanical Surface Detection)
- Electronics: DAE4 Sn778; Calibrated: 2007/9/17
- Phantom: ELI 4.0; Type: QDOVA001BA; Serial: 1029
- Measurement SW: DASY4, V4.7 Build 55; Postprocessing SW: SEMCAD, V1.8 Build 176

**Ch54/Area Scan (91x71x1):** Measurement grid: dx=10mm, dy=10mm

Maximum value of SAR (interpolated) = 1.37 mW/g

**Ch54/Zoom Scan (8x8x8)/Cube 0:** Measurement grid: dx=4.3mm, dy=4.3mm, dz=3mm

Reference Value = 9.47 V/m; Power Drift = -0.033 dB

Peak SAR (extrapolated) = 2.53 W/kg

**SAR(1 g) = 0.774 mW/g; SAR(10 g) = 0.345 mW/g**

Maximum value of SAR (measured) = 1.34 mW/g

**Ch54/Zoom Scan (8x8x8)/Cube 1:** Measurement grid: dx=4.3mm, dy=4.3mm, dz=3mm

Reference Value = 9.47 V/m; Power Drift = -0.033 dB

Peak SAR (extrapolated) = 2.33 W/kg

**SAR(1 g) = 0.579 mW/g; SAR(10 g) = 0.258 mW/g**

Maximum value of SAR (measured) = 1.26 mW/g

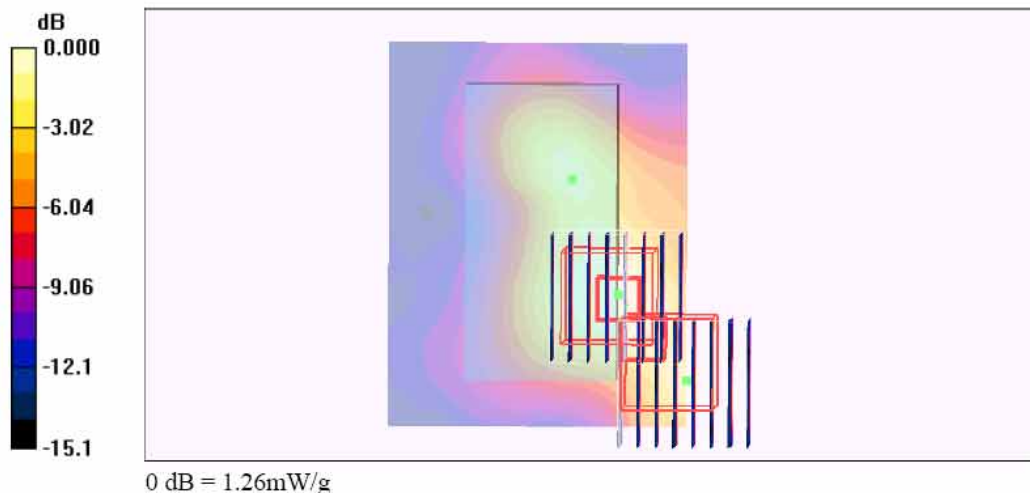

Test Laboratory: Sporton International Inc. SAR/HAC Testing Lab

Date : 2007/12/25

**Body\_802.11n Ch52\_NB Bottom with 0cm Gap\_Ant-1&3 2Tx\_DELL M2300\_BW 20M**

**DUT: 7D1410**

Communication System: 802.11n; Frequency: 5260 MHz; Duty Cycle: 1:1

Medium: MSL\_5G Medium parameters used:  $f = 5300$  MHz;  $\sigma = 5.31$  mho/m;  $\epsilon_r = 48.4$ ;  $\rho = 1000$  kg/m<sup>3</sup>

Ambient Temperature : 22.6 °C; Liquid Temperature : 21.6 °C

DASY4 Configuration:

- Probe: EX3DV3 - SN3514; ConvF(4.31, 4.31, 4.31); Calibrated: 2007/2/21
- Sensor-Surface: 2mm (Mechanical Surface Detection)
- Electronics: DAE4 Sn778; Calibrated: 2007/9/17
- Phantom: ELI 4.0; Type: QDOVA001BA; Serial: 1029
- Measurement SW: DASY4, V4.7 Build 55; Postprocessing SW: SEMCAD, V1.8 Build 176

**Ch52/Area Scan (91x71x1):** Measurement grid: dx=10mm, dy=10mm

Maximum value of SAR (interpolated) = 0.828 mW/g

**Ch52/Zoom Scan (8x8x8)/Cube 0:** Measurement grid: dx=4.3mm, dy=4.3mm, dz=3mm

Reference Value = 7.76 V/m; Power Drift = 0.083 dB

Peak SAR (extrapolated) = 1.46 W/kg

**SAR(1 g) = 0.481 mW/g; SAR(10 g) = 0.235 mW/g**

Maximum value of SAR (measured) = 0.814 mW/g

**Ch52/Zoom Scan (8x8x8)/Cube 1:** Measurement grid: dx=4.3mm, dy=4.3mm, dz=3mm

Reference Value = 7.76 V/m; Power Drift = 0.083 dB

Peak SAR (extrapolated) = 1.35 W/kg

**SAR(1 g) = 0.427 mW/g; SAR(10 g) = 0.197 mW/g**

Maximum value of SAR (measured) = 0.731 mW/g

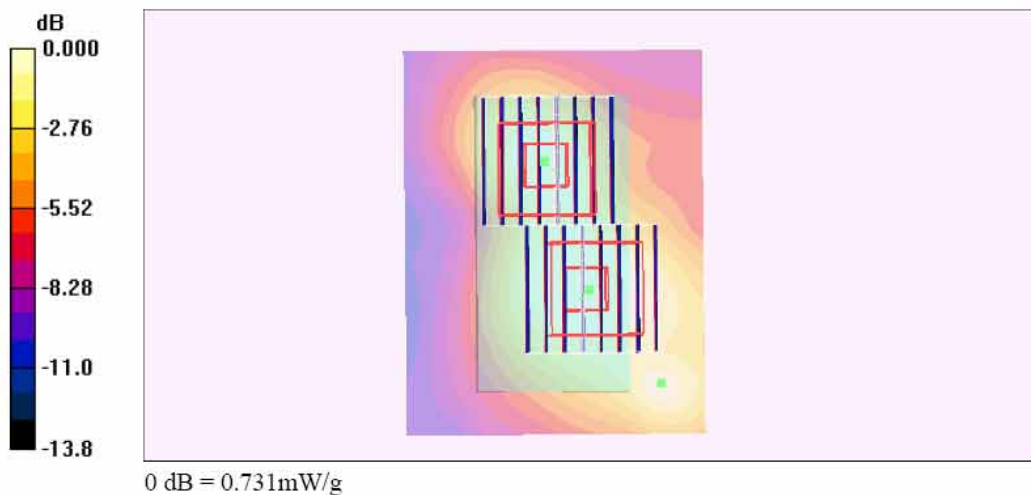

Test Laboratory: Sporton International Inc. SAR/HAC Testing Lab

Date : 2007/12/25

**Body\_802.11n\_Ch52\_NB Bottom with 0cm Gap\_Ant-1&3 2Tx\_IBM 2653\_BW 20M**

**DUT: 7D1410**

Communication System: 802.11n; Frequency: 5260 MHz; Duty Cycle: 1:1

Medium: MSL\_5G Medium parameters used:  $f = 5300$  MHz;  $\sigma = 5.31$  mho/m;  $\epsilon_r = 48.4$ ;  $\rho = 1000$  kg/m<sup>3</sup>

Ambient Temperature : 22.8 °C; Liquid Temperature : 21.6 °C

DASY4 Configuration:

- Probe: EX3DV3 - SN3514; ConvF(4.31, 4.31, 4.31); Calibrated: 2007/2/21
- Sensor-Surface: 2mm (Mechanical Surface Detection)
- Electronics: DAE4 Sn778; Calibrated: 2007/9/17
- Phantom: ELI 4.0; Type: QDOVA001BA; Serial: 1029
- Measurement SW: DASY4, V4.7 Build 55; Postprocessing SW: SEMCAD, V1.8 Build 176

**Ch52/Area Scan (91x71x1):** Measurement grid: dx=10mm, dy=10mm

Maximum value of SAR (interpolated) = 0.830 mW/g

**Ch52/Zoom Scan (8x8x8)/Cube 0:** Measurement grid: dx=4.3mm, dy=4.3mm, dz=3mm

Reference Value = 8.15 V/m; Power Drift = -0.126 dB

Peak SAR (extrapolated) = 1.50 W/kg

**SAR(1 g) = 0.486 mW/g; SAR(10 g) = 0.233 mW/g**

Maximum value of SAR (measured) = 0.855 mW/g

**Ch52/Zoom Scan (8x8x8)/Cube 1:** Measurement grid: dx=4.3mm, dy=4.3mm, dz=3mm

Reference Value = 8.15 V/m; Power Drift = -0.126 dB

Peak SAR (extrapolated) = 1.50 W/kg

**SAR(1 g) = 0.481 mW/g; SAR(10 g) = 0.232 mW/g**

Maximum value of SAR (measured) = 0.834 mW/g



0 dB = 0.834mW/g

Test Laboratory: Sporton International Inc. SAR/HAC Testing Lab

Date : 2007/12/25

**Body\_802.11a\_Ch120\_NB Bottom with 0cm Gap\_Ant-1\_DELL D500**

**DUT: 7D1410**

Communication System: 802.11a; Frequency: 5600 MHz; Duty Cycle: 1:1

Medium: MSL\_5G Medium parameters used:  $f = 5600$  MHz;  $\sigma = 5.65$  mho/m;  $\epsilon_r = 48$ ;  $\rho = 1000$  kg/m<sup>3</sup>

Ambient Temperature : 22.6 °C; Liquid Temperature : 21.6 °C

DASY4 Configuration:

- Probe: EX3DV3 - SN3514; ConvF(4.09, 4.09, 4.09); Calibrated: 2007/2/21
- Sensor-Surface: 2mm (Mechanical Surface Detection)
- Electronics: DAE4 Sn778; Calibrated: 2007/9/17
- Phantom: ELI 4.0; Type: QDOVA001BA; Serial: 1029
- Measurement SW: DASY4, V4.7 Build 55; Postprocessing SW: SEMCAD, V1.8 Build 176

**Ch120/Area Scan (91x71x1):** Measurement grid: dx=10mm, dy=10mm

Maximum value of SAR (interpolated) = 0.981 mW/g

**Ch120/Zoom Scan (8x8x8)/Cube 0:** Measurement grid: dx=4.3mm, dy=4.3mm, dz=3mm

Reference Value = 5.20 V/m; Power Drift = 0.152 dB

Peak SAR (extrapolated) = 1.94 W/kg

**SAR(1 g) = 0.507 mW/g; SAR(10 g) = 0.205 mW/g**

Maximum value of SAR (measured) = 0.933 mW/g

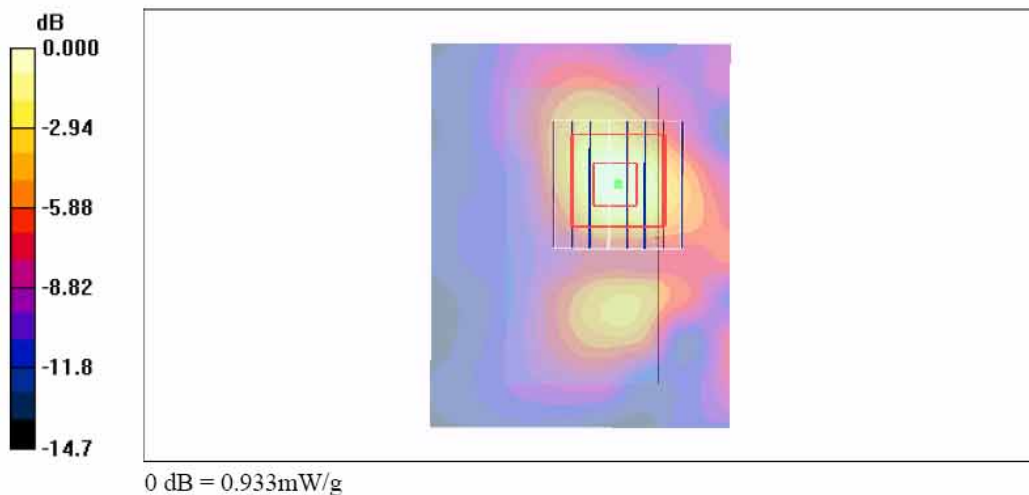

Test Laboratory: Sporton International Inc. SAR/HAC Testing Lab

Date : 2007/12/25

**Body\_802.11a\_Ch120\_NB Bottom with 0cm Gap\_Ant-3\_DELL D500**

**DUT: 7D1410**

Communication System: 802.11a; Frequency: 5600 MHz; Duty Cycle: 1:1

Medium: MSL\_5G Medium parameters used:  $f = 5600 \text{ MHz}$ ;  $\sigma = 5.65 \text{ mho/m}$ ;  $\epsilon_r = 48$ ;  $\rho = 1000 \text{ kg/m}^3$

Ambient Temperature : 22.6 °C; Liquid Temperature : 21.6 °C

DASY4 Configuration:

- Probe: EX3DV3 - SN3514; ConvF(4.09, 4.09, 4.09); Calibrated: 2007/2/21
- Sensor-Surface: 2mm (Mechanical Surface Detection)
- Electronics: DAE4 Sn778; Calibrated: 2007/9/17
- Phantom: ELI 4.0; Type: QDOVA001BA; Serial: 1029
- Measurement SW: DASY4, V4.7 Build 55; Postprocessing SW: SEMCAD, V1.8 Build 176

**Ch120/Area Scan (91x71x1):** Measurement grid: dx=10mm, dy=10mm

Maximum value of SAR (interpolated) = 1.25 mW/g

**Ch120/Zoom Scan (8x8x8)/Cube 0:** Measurement grid: dx=4.3mm, dy=4.3mm, dz=3mm

Reference Value = 6.08 V/m; Power Drift = 0.169 dB

Peak SAR (extrapolated) = 2.53 W/kg

**SAR(1 g) = 0.710 mW/g; SAR(10 g) = 0.304 mW/g**

Maximum value of SAR (measured) = 1.29 mW/g

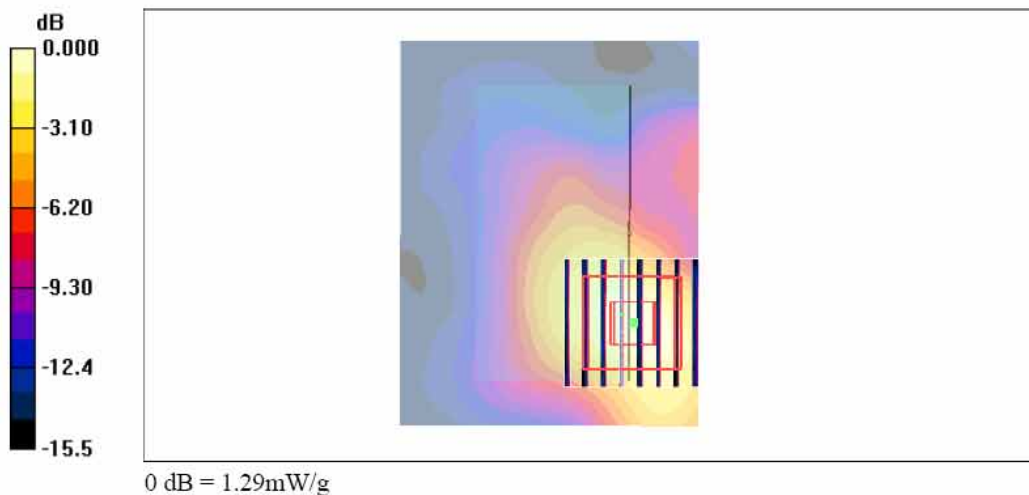



Test Laboratory: Sporton International Inc. SAR/HAC Testing Lab

Date : 2007/12/25

**Body\_802.11n\_Ch120\_NB Bottom with 0cm Gap\_Ant-1\_BW 20M\_DELL D500**

**DUT: 7D1410**

Communication System: 802.11n; Frequency: 5600 MHz; Duty Cycle: 1:1

Medium: MSL\_5G Medium parameters used:  $f = 5600$  MHz;  $\sigma = 5.65$  mho/m;  $\epsilon_r = 48$ ;  $\rho = 1000$  kg/m<sup>3</sup>

Ambient Temperature : 22.6 °C; Liquid Temperature : 21.6 °C

DASY4 Configuration:

- Probe: EX3DV3 - SN3514; ConvF(4.09, 4.09, 4.09); Calibrated: 2007/2/21
- Sensor-Surface: 2mm (Mechanical Surface Detection)
- Electronics: DAE4 Sn778; Calibrated: 2007/9/17
- Phantom: ELI 4.0; Type: QDOVA001BA; Serial: 1029
- Measurement SW: DASY4, V4.7 Build 55; Postprocessing SW: SEMCAD, V1.8 Build 176

**Ch120/Area Scan (91x71x1):** Measurement grid: dx=10mm, dy=10mm

Maximum value of SAR (interpolated) = 0.615 mW/g

**Ch120/Zoom Scan (8x8x8)/Cube 0:** Measurement grid: dx=4.3mm, dy=4.3mm, dz=3mm

Reference Value = 4.84 V/m; Power Drift = 0.195 dB

Peak SAR (extrapolated) = 1.29 W/kg

**SAR(1 g) = 0.333 mW/g; SAR(10 g) = 0.148 mW/g**

Maximum value of SAR (measured) = 0.577 mW/g

