



ADX DAS User Manual



3116 West Vanowen St.
Burbank, CA 91505
Tel: 818-840-8131
Fax: 818-840-8138
www.adrftech.com



Information in this document is subject to change without notice.

*Advanced RF Technologies, Inc. 1996-2013.
All rights reserved.*

- Please send comments to:

E-Mail: info@adrfttech.com

Phone: (818) 840-8131

(800) 313-9345

Fax: (818) 840-8138

- Address:

Advanced RF Technologies, Inc.
Attention: Technical Publications Department
3116 Vanowen St.
Burbank, CA 91505
USA
www.adrfttech.com

Revision History

Version	Author	Descriptions	Date

Change List

Version	Change list	Contents

Table of Contents

1.	Introduction	14
1.1	Highlights	14
1.2	ADX DAS Quick View	15
1.2.1	HE Quick View	15
1.2.2	15	
1.2.3	RU Quick View	16
1.3	Warnings and Hazards	17
2.	Block Diagram	21
2.1	ADX DAS Block Diagram	21
2.2	ADX DAS Topology	22
2.3	SISO Configuration	23
2.4	ADX-DAS Scalability	24
3.	ADX Overview	25
3.1	Head End	25
3.1.1	NMS (Network Management System)	26
3.1.1.1	LEDs	26
3.1.1.2	Ethernet Port	27
3.1.1.3	Host/Remote Switch	27
3.1.1.4	HE View/RU View Switch	27
3.1.2	RFU (ADX-H-RFU-x)	28
3.1.2.1	LEDs	29
3.1.2.2	RF Ports	29
3.1.2.3	Communication Port	29
3.1.3	Channel Combiner (ADX-H-CHC)	29
3.1.3.1	RF ports	30
3.1.3.2	RF ports	30
3.1.4	Optic Distribution Unit (ADX-H-ODU + ADX-RACK-ODU)	30
3.1.4.1	LEDs	31
3.1.4.2	RF Ports	31
3.2	Remote Unit	32
3.2.1	ADX-R-x3xM (Master RU)	33
3.2.1.1	LEDs	33
3.2.1.2	RF Ports	34
3.2.1.3	Optic Port	35
3.2.1.4	Power On/Off Switch & DC IN Port	35
3.2.1.5	PSU Alarm Port	35
3.2.1.6	GUI Port	35

- 3.2.1.7 RS-485 Port35
- 3.2.1.8 ADDR36
- 3.2.2 ADX-R-xxxS/ADX-R-BTxxS/ADX-R-VU25S (Slave RU)37
 - 3.2.2.1 LEDs37
 - 3.2.2.2 RF Ports38
 - 3.2.2.3 Power On/Off Switch & DC IN Port39
 - 3.2.2.4 RS-485 Port39
- 3.2.3 RU Power Supply Options39
 - 3.2.3.1 ADX-R-ADP (RU Power Adapter)39
 - 3.2.3.2 ADX-R-PSU (RU Power Supply Unit)39
- 4. Cable Connection41
 - 4.1 Head End Connection Diagrams42
 - 4.1.1 Front/Rear Head End Connection View with Optional BCU unit42
 - 4.1.2 Rear Head End Connection View with (4) OPT-8 units43
 - 4.2 Remote Unit Connection Diagrams44
 - 4.3 Remote Unit w/ 4-Way Combiner (ADX-R-4WS)45
- 5. Mounting method46
 - 5.1 Head End46
 - 5.1.1 Rack Mount46
 - 5.1.2 Wall Mount47
 - 5.2 Remote Unit48
 - 5.2.1 Rack Mount48
 - 5.2.2 Wall Mount49
 - 5.2.2.1 Remote Unit using RU Chassis (ADX-R-CHA-30)49
 - 5.2.2.2 Individual Remote Module49
- 6. Installation50
 - 6.1 Pre-Installation Inspection50
 - 6.2 ADX DAS Installation Procedure50
 - 6.2.1 HE Installation Procedure50
 - 6.2.1.1 Installing a ADX DAS HE in a rack50
 - 6.2.1.2 Wall mounting the ADX DAS HE52
 - 6.2.2 RU Installation Procedure54
 - 6.2.2.1 Installing a ADX DAS RU in a rack54
 - 6.2.2.2 Wall mounting the ADX DAS RU56
 - 6.2.2.3 Wall mounting an ADX Remote Module58
 - 6.2.3 ADX-H-OEU Installation Procedure59
 - 6.2.3.1 Installing a ADX-H-OEU in a Rack59
 - 6.2.3.2 Wall mounting the ADX-H-OEU61
 - 6.3 Grounding62

6.4	Optic Port Cleaning	63
7.	Warranty and Repair Policy	64
7.1	General Warranty	64
7.2	Limitations of Warranty	64
7.3	Limitation of Damages	64
7.4	No Consequential Damages	64
7.5	Additional Limitation on Warranty	64
7.6	Return Material Authorization (RMA)	64
8.	Web-GUI	65
8.1	Web-GUI Setup	65
8.1.1	DAS system/PC Connection Using Web-GUI	65
8.2	Administrator/User Mode	66
8.2.1	Common	66
8.2.1.1	Navigation tree Lock/Unlock	66
8.2.1.2	Navigation Tree	66
8.2.1.3	Power Status	67
8.2.1.4	Commissioning Status	67
8.2.1.5	Information	67
8.2.2	Status Tab	68
8.2.2.1	Status – NMS	68
8.2.2.2	Status – BCU	71
8.2.2.3	Status – RFU	73
8.2.2.4	Status – ODU	75
8.2.2.5	Status – RU Hub	78
8.2.2.6	Status – Remote module	79
8.2.3	Control Tab	82
8.2.3.1	Control – NMS	82
8.2.3.2	Control – BCU	83
8.2.3.3	Control – RFU	84
8.2.3.4	Control – ODU	88
8.2.3.5	Control – RH Hub	89
8.2.3.6	Control – Remote Module (Master or Slave RU)	90
8.2.4	Install Tab	93
8.2.4.1	Install – NMS	93
8.2.4.2	Install – RFU	96
8.2.4.3	Install – OPT	97
8.2.4.4	Install – RU Hub	98
8.2.4.5	Install – Remote Module (Master or Slave RU)	99
8.2.5	System	101



- 8.2.5.1 System: Account101
- 8.2.5.2 System: Logs102
- 8.2.5.3 System: Update.....103
- 8.2.5.4 System: System Information.....103
- 8.2.5.5 System: Backup/Restore106
- 8.2.5.6 System: SNMP.....107
- 8.2.5.7 System: Closeout Package108
- 8.2.6 Help109
- 8.2.7 Logout.....109
- 8.3 Guest Mode109
- 9. System Specification110
 - 9.1 Specification for PS78, SMR110
 - 9.2 Specification for VU, BT111
 - 9.3 FCC Certification112
- 10. Antenna Specifications112
 - 10.1 Omni Antenna112
- 11. Mechanical Drawing113

Figures

Figure 1-1	ADX DAS HE Quick View	15
Figure 1-2	ADX DAS RU Quick View	16
Figure 2-1	ADX DAS Block Diagram.....	21
Figure 2-2	ADX DAS Topology	22
Figure 2-3	ADX DAS SISO Configuration.....	23
Figure 3-1	Head End Front View	25
Figure 3-2	ADX-H-NMS Front View	26
Figure 3-3	NMS LED	26
Figure 3-4	Ethernet Port	27
Figure 3-5	Host/Remote Switch.....	27
Figure 3-6	HE View/RU View Switch	27
Figure 3-7	RFU Front & Rear View (excluding BT and VU).....	28
Figure 3-8	RFU Front & Rear View for BT	28
Figure 3-9	RFU Front & Rear View for VU.....	28
Figure 3-10	RFU LED	29
Figure 3-11	Communication Port (RFU).....	29
Figure 3-12	ADX-H-CHC Front & Rear View	30
Figure 3-13	ADX-RACK-ODU + ADX-H-ODU-4/1 Front & Rear View	31
Figure 3-14	ADX-H-OPT-8 LED	31
Figure 3-15	ODU RF Ports	31
Figure 3-16	RU Front View.....	32
Figure 3-17	RU Rear View	32
Figure 3-18	Master RU Front & Rear View(excluding BT).....	33
Figure 3-19	Master RU Front & Rear View only for BT	33
Figure 3-20	Master RU LED.....	33
Figure 3-21	RF Ports (Master RU)	34
Figure 3-22	Ports at the back panel (Master RU)	35
Figure 3-23	Correct RS-485 connection between Master RU and Slave RU or between Slave RUs	36
Figure 3-24	Wrong RS-485 connection between Master RU and Slave RU or between Slave RUs	36
Figure 3-25	Do NOT connect RS-485 ports of Remote Module to network equipment port.....	36
Figure 3-26	Slave RU Front & Rear View (excluding BT and VU)	37
Figure 3-27	Slave RU Front & Rear View (BT)	37
Figure 3-28	Slave RU Front & Rear View (excluding VU)	37
Figure 3-29	Slave RU LED	38
Figure 3-30	RF Ports (Slave RU)	38
Figure 3-31	Ports at the rear panel (Slave RU)	38
Figure 3-32	RU PSU Front & Rear View.....	39
Figure 3-33	RU PSU LED	40
Figure 3-34	RU PSU Power Switch View	40
Figure 3-35	Battery Backup Port & Battery Backup Switch	41
Figure 3-36	DC Output Port (RU PSU).....	41
Figure 3-37	PSU Alarm Port (RU PSU).....	41
Figure 4-1	HE Cable connection (1 OPT-8 +1 BCU)	42
Figure 4-2	HE Cable connection (4 OPTs)	43
Figure 4-3	RU Cable connection (4 Remote Module + RU PSU)	44
Figure 4-4	Slave RU Expansion using ADX-R-4WS.....	45
Figure 5-1	HE Rack Mount (Front & Rear view).....	46
Figure 5-2	HE Wall Mount (Top View)	47
Figure 5-3	RU Rack Mount (Front view).....	48
Figure 5-4	19" Shelf type - RU Wall Mount (Top view)	49

Figure 5-5	Remote Module Wall Mount (Top view).....	49
Figure 6-1	ADX HE 19" Rack Mount Instructions	51
Figure 6-2	ADX HE Wall Mount Instructions.....	52
Figure 6-3	Wall Mount Instructions for ADX-HE added 1U Unit.....	53
Figure 6-4	ADX-RU 19" Rack Mount Instructions	55
Figure 6-5	ADX-RU Wall Mount Instructions	56
Figure 6-6	Wall Mount Instructions for ADX-RU added 1.5U Unit	57
Figure 6-7	Remote Module Wall Mount Instructions.....	58
Figure 6-8	ADX-H-OEU Rack Mount Instructions	60
Figure 6-9	ADX-H-OEU Wall Mount Instructions	61
Figure 6-10	Ground Cable Connection (HE rear side).....	62
Figure 6-11	Ground Cable Connection (RU rear side).....	62
Figure 6-12	Optic Connector Cleaning (left) and Optic Port Cleaning (right)	63
Figure 6-13	SC/APC Optic Connector Dust Cap	63
Figure 8-1	Login screen.....	65
Figure 8-2	Navigation tree Lock/Unlock	66
Figure 8-3	Navigation tree	66
Figure 8-4	ADX DAS General Information.....	67
Figure 8-5	Status - NMS	68
Figure 8-6	System Summary	68
Figure 8-7	System scan time, HE view/RU view.....	69
Figure 8-8	HE alarm status.....	69
Figure 8-9	HE Commissioning status	70
Figure 8-10	Status – BCU	71
Figure 8-11	Status – BCU Band	71
Figure 8-12	Status – BCU Power & Atten.....	71
Figure 8-13	Status – BCU Power Ratio.....	72
Figure 8-14	Status – BCU Alarm.....	72
Figure 8-15	Status – RFU.....	73
Figure 8-16	Status – RFU Band.....	73
Figure 8-17	Power & Gain Display (Admin)	73
Figure 8-18	Power & Gain Display (User)	74
Figure 8-19	Status - OPT	75
Figure 8-20	Summary (Status – OPT)	75
Figure 8-21	RF Status (Status – OPT)	76
Figure 8-22	Optic Status (Status – ODU).....	76
Figure 8-23	Optic Attenuation (Status – OPT)	77
Figure 8-24	Optic Path Status (Status – OPT)	77
Figure 8-25	Status - RU Hub.....	78
Figure 8-26	RU Alarm Status (Status - RU Hub)	78
Figure 8-27	RU Commissioning Status (Status - RU Hub)	78
Figure 8-28	Status – Remote Module	79
Figure 8-29	PCS Band Information (Status – Remote Module)	80
Figure 8-30	Power & Gain (Admin).....	80
Figure 8-31	Power & Gain (User).....	80
Figure 8-32	Optic Power (Status – Master RU only)	81
Figure 8-33	Control - NMS	82
Figure 8-34	Heartbeat (Control – NMS).....	82
Figure 8-35	HE System Reboot & Factory Setting (Control – NMS).....	82
Figure 8-36	NMS System Reboot & Factory Setting (Control – NMS)	82
Figure 8-37	Control – BCU	83
Figure 8-38	Control – BCU Manual ATT Control	83
Figure 8-39	Control – BCU Reboot/Factory Setting	84

Figure 8-40	Control – BCU Alarm Setting.....	84
Figure 8-41	Control - RFU	84
Figure 8-42	General Setting (Control – RFU) (Admin).....	85
Figure 8-43	General Setting (Control – RFU) (User).....	85
Figure 8-44	Reboot & Factory Setting (Control – RFU).....	85
Figure 8-45	UL Noise Detection (Control – RFU)	85
Figure 8-46	UL Noise Detection - PCS band	86
Figure 8-47	Manual Attenuator Control Setting (Control – RFU)	86
Figure 8-48	Alarm Threshold Setting (Control – RFU)	87
Figure 8-49	Control – OPT.....	88
Figure 8-50	Optic Attenuation – OPT.....	88
Figure 8-51	Reboot & factory Setting (Control – OPT)	89
Figure 8-52	Control – RU Hub	89
Figure 8-53	Reboot & Factory Setting (Control – RU Hub)	89
Figure 8-54	Control – Remote Module	90
Figure 8-55	General Setting (Control - RU)	90
Figure 8-56	Reboot & factory Setting (Control - RU).....	91
Figure 8-57	Optic Setting (Control - RU)	91
Figure 8-58	Manual Atten Control (Control - RU).....	91
Figure 8-59	Alarm Setting (Control - RU)	92
Figure 8-60	Install - NMS	93
Figure 8-61	HE Commissioning Status (Install – NMS).....	93
Figure 8-62	SNMP (Install – NMS).....	94
Figure 8-63	Location Setting (Install – NMS)	94
Figure 8-64	External Modem Box Setting (Install – NMS)	94
Figure 8-65	Description (Install – NMS).....	95
Figure 8-66	SNMP Agent False Alarm Test (Install – NMS).....	95
Figure 8-67	Location Info / Installer Info (Install – NMS).....	95
Figure 8-68	Date & Time Setting (Install – NMS)	96
Figure 8-69	Install - RFU.....	96
Figure 8-70	RFU Commissioning (Install – RFU).....	97
Figure 8-71	Description (Install – RFU)	97
Figure 8-72	Install – OPT.....	97
Figure 8-73	Optic control (Control – OPT)	98
Figure 8-74	Description (Install – OPT)	98
Figure 8-75	Install-RU Hub.....	99
Figure 8-76	RU Commissioning Status (Install-RU Hub)	99
Figure 8-77	Description (Install-RU Hub)	99
Figure 8-78	Install-Remote Module	100
Figure 8-79	RU Output Commissioning (Install-RU)	100
Figure 8-80	Description (Install-Remote Module)	101
Figure 8-81	Account Management	101
Figure 8-82	New Account	101
Figure 8-83	Change Password.....	102
Figure 8-84	Event Log	102
Figure 8-85	User Log.....	103
Figure 8-86	System update	103
Figure 8-87	System Information	104
Figure 8-88	System Notification	104
Figure 8-89	Bill of material	105
Figure 8-90	Setting Backup (Before).....	106
Figure 8-91	Setting Backup (After).....	106
Figure 8-92	Setting Restore	107



Figure 8-93	SNMP V1/V2	107
Figure 8-94	SNMP V3	108
Figure 8-95	System- Closeout Package	108
Figure 8-96	System- Closeout Package after the file upload	108
Figure 8-97	Help.....	109
Figure 11-1	HE Drawing	113
Figure 11-2	RFU Drawing for SMR/PS.....	114
Figure 11-3	RFU Drawing for VU.....	115
Figure 11-4	RFU Drawing for BT.....	116
Figure 11-5	Master RU Drawing for PS	116
Figure 11-6	Master RU Drawing for BT	117
Figure 11-7	Slave RU Drawing for SMR	118
Figure 11-8	Slave RU Drawing for VU	119
Figure 11-9	RU Rack Shelf Drawing.....	120

Tables

Table 2-1	ADX-DAS Scalability	24
Table 3-1	NMS LED Specifications	26
Table 3-2	RFU LED Specifications	29
Table 3-3	ODU Rack LED Specifications	31
Table 3-4	Master RU LED Specifications	33
Table 3-5	Slave RU LED Specifications	38
Table 3-6	RU PSU LED Specifications	40
Table 8-1	Account Information for Login	65
Table 8-2	Navigation tree	66
Table 8-3	Power Supply Status	67
Table 8-4	Commissioning ICON	67
Table 8-5	System Summary Description	69
Table 8-6	Description for HE Commissioning status	70
Table 8-7	Description for NMS alarm	70
Table 8-8	RFU Alarm Status	74
Table 8-9	Summary Description	76
Table 8-10	Description for optic path status	77
Table 8-11	Description for RU Commissioning status	79
Table 8-12	Alarm Status (Status - RU Hub)	79
Table 8-13	Operating Status (Status – Remote Module)	81
Table 8-14	Description for General Setting	85
Table 8-15	Description for Main Gain Control Setting (Control – RFU)	86
Table 8-16	Description for Alarm Threshold Setting (Control – RFU)	87
Table 8-17	Description for Optic Attenuation (Control – OPT)	89
Table 8-18	Description for General Setting (Control - RU)	90
Table 8-19	Description for Optic Setting (Control - RU)	91
Table 8-20	Description for Manual Atten Control (Control - RU)	92
Table 8-21	Description for HE Commissioning Status (Install – NMS)	93
Table 8-22	Description for Optic control (Control – OPT)	98
Table 8-23	Description for RU Commissioning status	99

Terms and Abbreviations

The following is a list of abbreviations and terms used throughout this document.

Abbreviation/Term	Definition
AGC	Automatic Gain Control
ALC	Automatic Level Control
AROMS	ADRF Repeater Operation and Management System
BCU	Band Combiner Unit
BTS	Base Transceiver Station
CDMA	Code Division Multiple Access
CHC	Channel combiner
CW	Continuous Wave (un-modulated signal)
DAS	Distributed Antenna System
DL	Downlink
Downlink	The path covered from the Base Transceiver Station (BTS) to the subscribers' service area via the repeater
HE	Head End
HPA	High Power Amplifier
HW	Hardware
IF	Intermediate Frequency
LNA	Low Noise Amplifier
LTE	Long Term Evolution
MS	Mobile Station
NMS	Network Management System
ODU	Optic Donor Unit which is located in ODU rack. A ODU rack has two ODUs.
OEU	Optic Expansion Unit
OPT	Optic Unit
PLL	Phased Locked Loop
PSU	Power Supply Unit
RF	Radio Frequency
RFU	RF Channel Unit
RU	Remote Unit which is composed of master RU and multiple slaves RU
SQE	Signal Quality Estimate
Remote Module	generic term for master RU and slave RU
SW	Software
UL	Uplink
Uplink	The path covered from the subscribers' service area to the Base Transceiver Station (BTS) via the repeater
VSWR	Voltage Standing Wave Ratio

1. INTRODUCTION

Up to (8) frequency bands in one body: Currently the ADX supports 700 MHz (Lower A, Lower B, Lower C, and Upper C), 700MHz Public Safety w/ Upper D support, Cellular, PCS, SMR800/SMR900, and AWS bands.

1.1 Highlights

- Modular Structure
 - Supports multi bands service (700MHz, 700MHz PS, Cell, PCS, AWS, SMR800/SMR900 etc.) in one body
 - Supports up to 8 RF units
- Supports optional combining/balancing of multiple carriers' signals via BCU (Band Combiner Unit)
- Supports up to a of maximum of 32 SISO Remote Units
- 30dBm of downlink composite output power
 - 33dBm available for PCS and AWS
- Requires only single strand of fiber per remote unit
- Operates with up to 5dBo optical loss (Single mode)
- Supports SNMP v1, v2, v3 (get, set & traps)
- Web-based GUI Interface; No 3rd party GUI software required
- Web-GUI connectivity via DHCP in host mode
- Versatility and Usability: ADX gives total control to the user. Control parameters such as gain, output power, and alarm threshold can be changed using Web-GUI interface allowing the user to fine tune the system to the given RF environment.
- Uplink noise measurement routine
- Support RU View mode, refer to section 3.1.1.4
- Incremental Automatic Shutdown/Resume Time: ADX gradually increases the time span between automatic shutdown and resume period before it permanently shuts itself down
- Support ALC function to prevent ADX DAS from input overload or output overpower

1.2 ADX DAS Quick View

1.2.1 HE Quick View

1.2.2

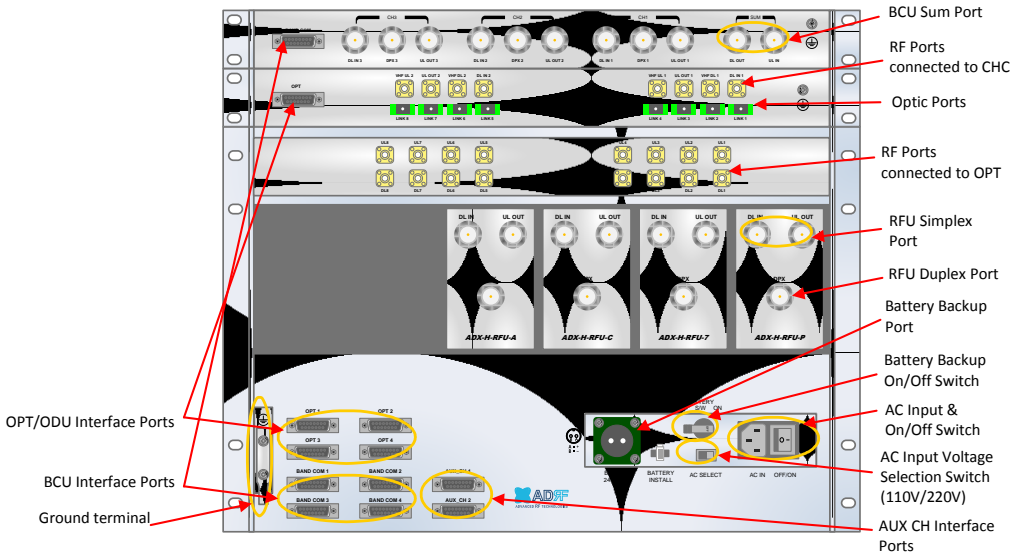
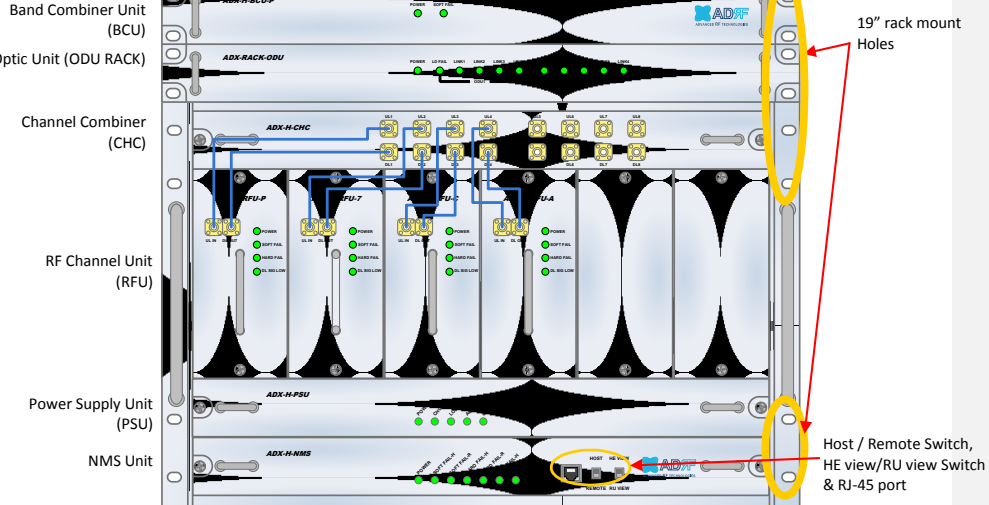

Figure 1-1 ADX DAS HE Quick View

1.2.3 RU Quick View

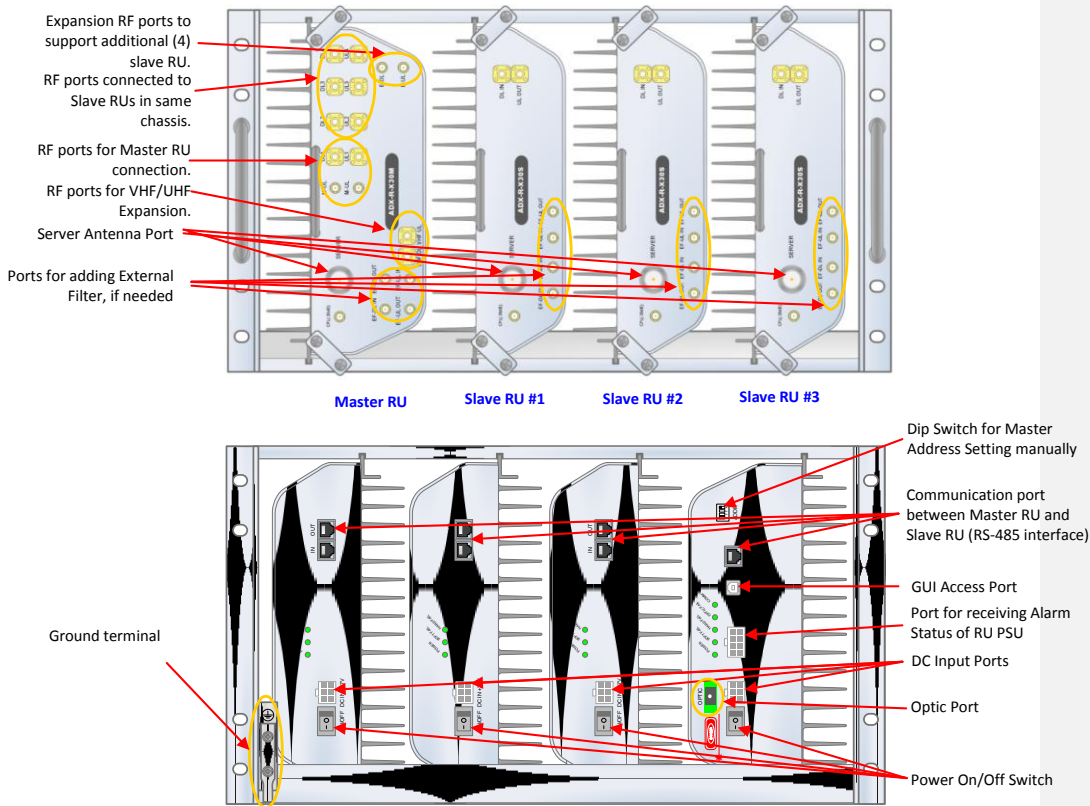

Figure 1-2 ADX DAS RU Quick View

1.3 Warnings and Hazards



WARNING! ELECTRIC SHOCK

Opening the ADX DAS could result in electric shock and may cause severe injury.



WARNING! EXPOSURE TO RF

Working with the ADX DAS while in operation, may expose the technician to RF electromagnetic fields that exceed FCC rules for human exposure. Visit the FCC website at www.fcc.gov/oet/rfsafety to learn more about the effects of exposure to RF electromagnetic fields.

RF EXPOSURE & ANTENNA PLACEMENT Guidelines

Actual separation distance is determined upon gain of antenna used.

Please maintain a minimum safe distance of at least 50 cm while operating near the donor and the server antennas.

메모 [H1]: Donor antenna 설치에 대한 문구 삭제. (HK)

WARRANTY

Opening or tampering the ADX DAS will void all warranties.

Lithium Battery: CAUTION. RISK OF EXPLOSION IF BATTERY IS REPLACED BY INCORRECT TYPE. DISPOSE OF USED BATTERIES ACCORDING TO INSTRUCTIONS.

Ethernet Instructions: This equipment is for indoor use only. All cabling should be limited to inside the building.

FCC Part 15 Class A

NOTE: This equipment has been tested and found to comply with the limits for a Class A digital device, pursuant to part 15 of the FCC Rules. These limits are designed to provide reasonable protection against harmful interference when the equipment is operated in a commercial environment. This equipment generates, uses, and can radiate radio frequency energy and, if not installed and used in accordance with the instruction manual, may cause harmful interference to radio communications. Operation of this equipment in a residential area is likely to cause harmful interference in which case the user will be required to correct the interference at their own expense.

FCC Part 20

WARNING. THIS is NOT a CONSUMER device. It is designed for installation by FCC LICENSEES and QUALIFIED INSTALLERS. You MUST have an FCC LICENSE or express consent of an FCC Licensee to operate this device. Unauthorized use may result in significant forfeiture penalties, including penalties in excess of \$100,000 for each continuing violation.

메모 [Y2]: 추가
15/02/03

FCC Part 90 Class B

WARNING. THIS is NOT a CONSUMER device. It is designed for installation by FCC LICENSEES and QUALIFIED INSTALLERS. You MUST have an FCC LICENSE or express consent of an FCC Licensee to operate this device. You MUST register Class B signal boosters (as defined in 47 CFR 90.219) online at www.fcc.gov/signal-boosters/registration. Unauthorized use may result in significant forfeiture penalties, including penalties in excess of \$100,000 for each continuing violation.

메모 [Y3]: 추가
15/02/03

Laser Safety

Fiber optic ports of the ADX DAS emit invisible laser radiation at the 1310, 1550nm wavelength window.

To avoid eye injury never look directly into the optical ports, patch cords or optical cables. Do not stare into beam or view directly with optical instruments. Always assume optical output is on.

Only technicians familiar with fiber optic safety practices and procedures should perform optical fiber connections and disconnections of the ADX DAS and the associated cables.

The ADX DAS complies with 21 CFR 1040.10 and 1040.11 except for deviations pursuant to laser notice No.50 (July26, 2001)@IEC 60825-1, Amendment2 (Jan. 2001).

Care of Fiber Optic Connectors

Do not remove the protective covers on the fiber optic connectors until a connection is ready to be made. Do not leave connectors uncovered when not connected.

The tip of the fiber optic connectors should not come into contact with any object or dust.

Refer to the cleaning procedure for information on the cleaning of the fiber tip.

RSS-GEN, Sec. 7.1.2 – (transmitters)

Under Industry Canada regulations, this radio transmitter may only operate using an antenna of a type and maximum (or lesser) gain approved for the transmitter by Industry Canada. To reduce potential radio interference to other users, the antenna type and its gain should be so chosen that the equivalent isotropically radiated power (e.i.r.p.) is not more than that necessary for successful communication.

Conformément à la réglementation d'Industrie Canada, le présent émetteur radio peut fonctionner avec une antenne d'un type et d'un gain maximal (ou inférieur) approuvé pour l'émetteur par Industrie Canada. Dans le but de réduire les risques de brouillage radioélectrique à l'intention des autres utilisateurs, il faut choisir le type d'antenne et son gain de sorte que la puissance isotrope rayonnée équivalente (p.i.r.e.) ne dépasse pas l'intensité nécessaire à l'établissement d'une communication satisfaisante.

RSS-GEN, Sec. 7.1.2 – (detachable antennas)

This radio transmitter (identify the device by certification number, or model number if Category II) has been approved by Industry Canada to operate with the antenna types listed below with the maximum permissible gain and required antenna impedance for each antenna type indicated. Antenna types not included in this list, having a gain greater than the maximum gain indicated for that type, are strictly prohibited for use with this device.

Le présent émetteur radio (identifier le dispositif par son numéro de certification ou son numéro de

modèle s'il fait partie du matériel de catégorie I) a été approuvé par Industrie Canada pour fonctionner avec les types d'antenne énumérés ci-dessous et ayant un gain admissible maximal et l'impédance requise pour chaque type d'antenne. Les types d'antenne non inclus dans cette liste, ou dont le gain est supérieur au gain maximal indiqué, sont strictement interdits pour l'exploitation de l'émetteur.

RF Radiation Exposure

This equipment complies with RF radiation exposure limits set forth for an uncontrolled environment. This equipment should be installed and operated with a minimum distance of 50 cm between the radiator and your body. This transmitter must not be co-located or operating in conjunction with any other antenna or transmitter. RF exposure will be addressed at time of installation and the use of higher gain antennas require larger separation distances.

RSS-102 RF Exposure

L'antenne (ou les antennes) doit être installée de façon à maintenir à tout instant une distance minimum de au moins 50 cm entre la source de radiation (l'antenne) et toute personne physique. Cet appareil ne doit pas être installé ou utilisé en conjonction avec une autre antenne ou émetteur.

2. BLOCK DIAGRAM

2.1 ADX DAS Block Diagram

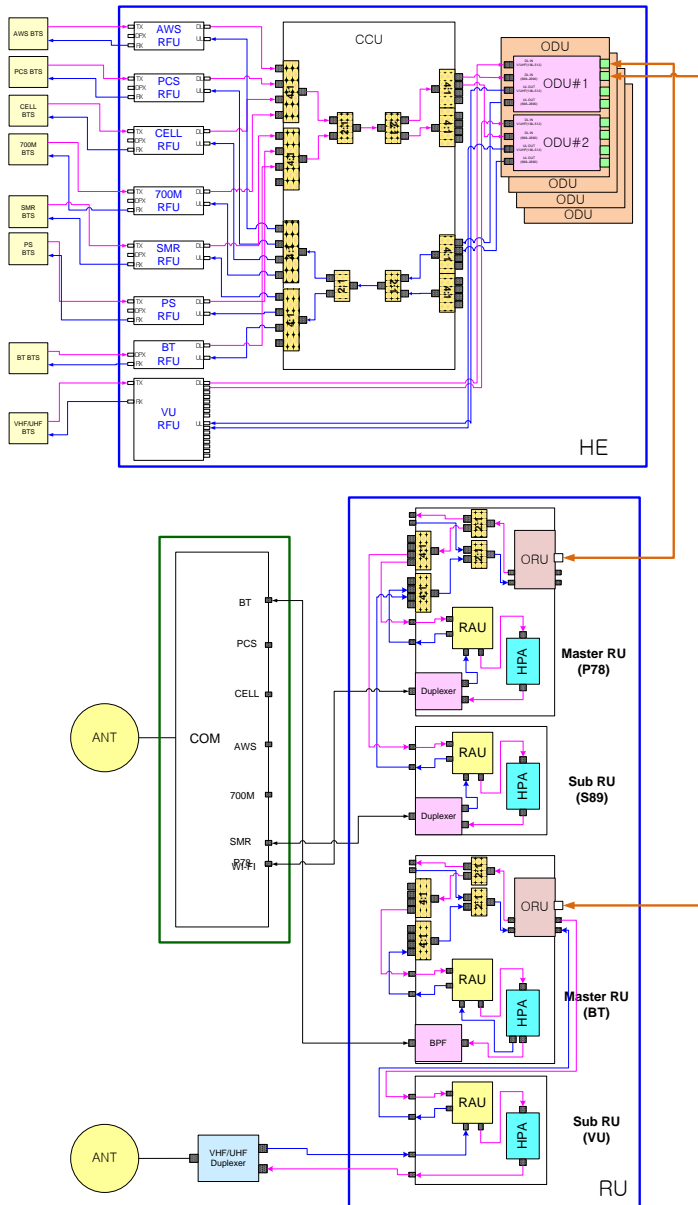

Figure 2-1 ADX DAS Block Diagram

2.2 ADX DAS Topology

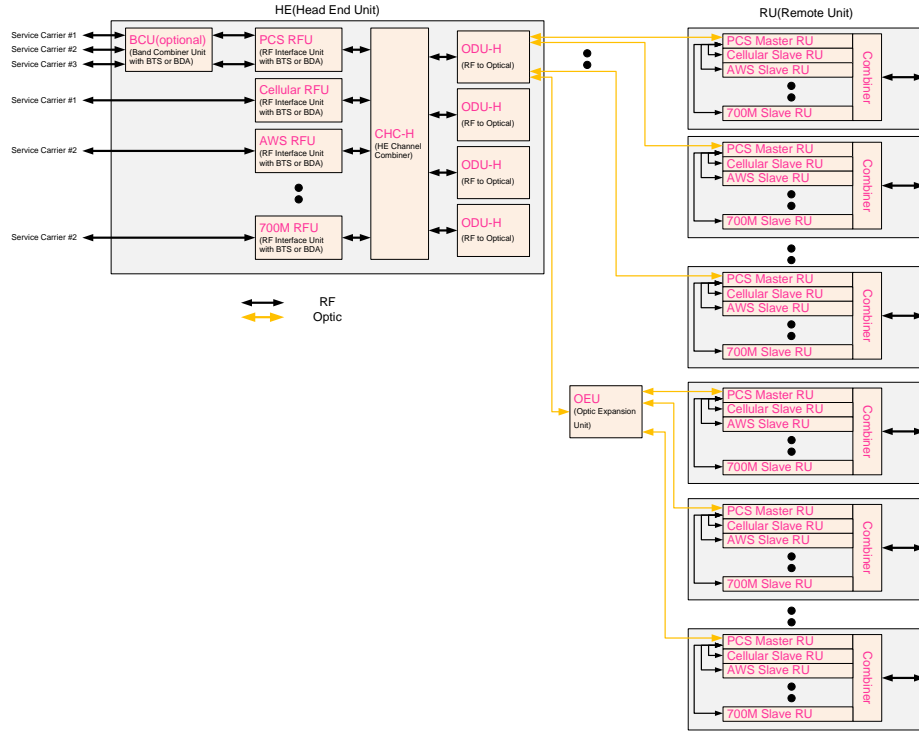

Figure 2-2 ADX DAS Topology

2.3 SISO Configuration

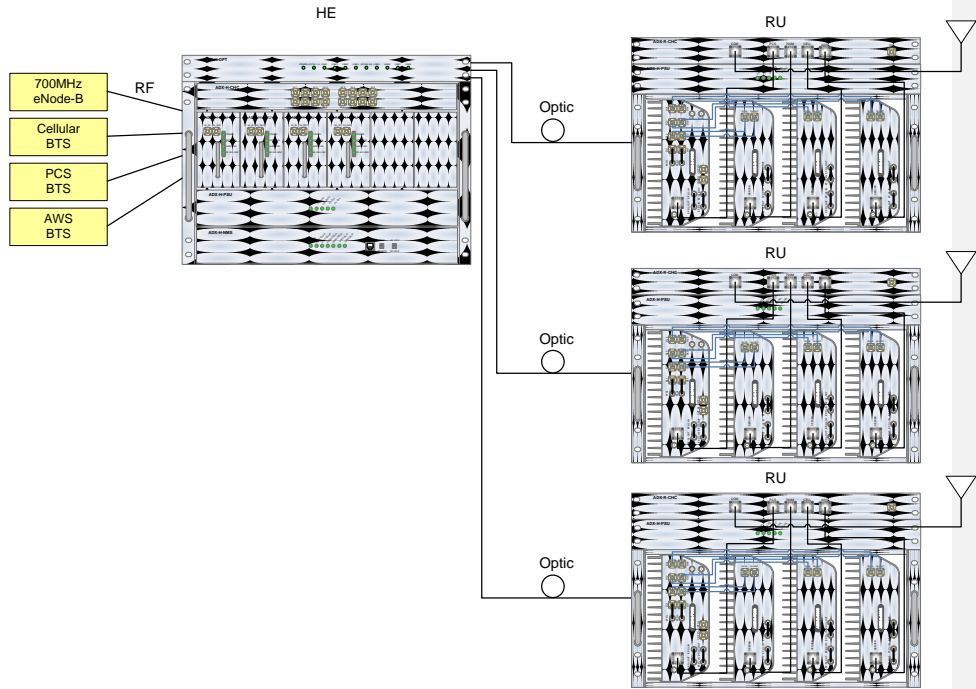

Figure 2-3 ADX DAS SISO Configuration

2.4 ADX-DAS Scalability

Table 2-1 ADX-DAS Scalability

Unit		Scalability	Remarks	
Supported band		700MHz, Cellular, AWS 1W/2W, PCS 1W/2W, SMR800/900, PS700, VHF, UHF, BRS	700MHz includes Lower A, Lower B, Lower C, and Upper C	
HE	RFU	Up to 8	up to 6: card type 7 th & 8 th RFU: 19" rack type	
	NMS	1		
	Channel Combiner	1		
	Optic Unit	Up to 4		
	Band Combiner Unit	Up to 4	To support multiple carriers	
	Power Supply Unit (AC or DC)	1	Capable of supplying power to 8 RFUs, 4 BCUs, 4 OPTs and NMS.	
RU	RU	Up to 60		
	OEU	Up to 4		
	PSU	Adaptor type	1 per remote module	
		19" rack mount (AC or DC)	1	Capable of supplying power to 8 Remote Modules

3. ADX OVERVIEW

3.1 Head End

The head end unit must always be connected to the Base Station using a direct cabled connection. This system has not been approved for use with a wireless connection via server antenna to the base station.

메모 [Y4]: 추가
15/02/03

Head end components include:

- ADX-H-NMS (Network Management System)
- ADX-H-CHC (Head End Channel Combiner)
- ADX-H-PSU (Head End Power Supply)
- Up to [4] ADX-H-BCU (Band Combiner Unit)
- Up to [8] ADX-H-RFU-x (RF Unit)
- Up to [4] ADX-H-RACK-ODU (Optical Unit rack) each ADX-H-RACK-ODU enables to have up to 2 ODU(ADX-H-ODU-4-X)s

- Specifications

- Size: 19.0 x 14.6 x 12.2 inches (482 x 370 x 311 mm)
- Weight: 83.7 lbs (38.0 Kg)@4 RFU, CHC-H, PSU and NMS
- Power Consumption: 52W@4 RFU, 2 ODUs and NMS, 28W@1 RFU, 2 ODUs and NMS
- Power Input: 110VAC or -48VDC(optional)
- Supports the ADRF-BBU for external battery backup solution

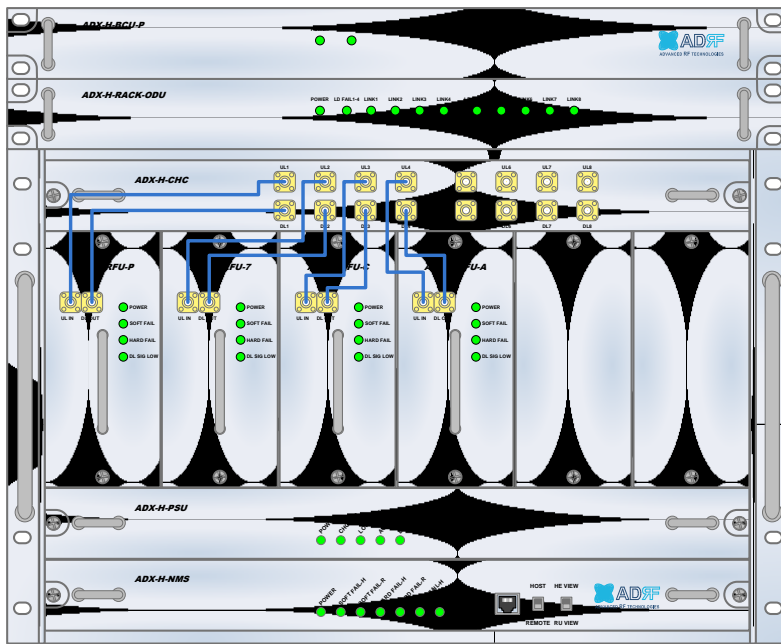

Figure 3-1 Head End Front View

3.1.1 NMS (Network Management System)

- Functions and features
 - Supports SNMP v1, v2, and v3 (get, set & trap) and web-based GUI Interface.
 - Monitors alarms and status
 - Provides control interfaces with all subordinate modules
 - Provides overall DAS structure via the auto tree update function
- Spec
 - Size: 19.0 x 12.1 x 1.7 inches
 - Weight: 5.5 lbs



Figure 3-2 ADX-H-NMS Front View

3.1.1.1 LEDs

NMS has LEDs on the front panel as shown in Figure 3-3.



Figure 3-3 NMS LED

Table 3-1 NMS LED Specifications

ADX DAS-NMS		Specifications
Power	Solid Green	NMS power is ON
	OFF	NMS power is OFF
SOFT FAIL-H	Solid Yellow	HE Soft Fail alarm exists in the system
	Solid Green	No HE Soft Fail alarms are present in the system
SOFT FAIL-R	Solid Yellow	RU Soft Fail alarm exists in the system
	Solid Green	No RU Soft Fail alarms are present in the system
HARD FAIL-H	Solid Red	HE Hard Fail alarm exists in the system
	Solid Green	No HE Hard Fail alarms are present in the system
HARD FAIL-R	Solid Red	RU Hard Fail alarm exists in the system
	Solid Green	No RU Hard Fail alarms are present in the system
LINK FAIL-H	Solid Yellow	HE Link Fail alarm exists in the system
	Solid Green	No HE Link Fail alarms are present in the system
LINK FAIL-R	Solid Yellow	RU Link Fail alarm exists in the system
	Solid Green	No RU Link Fail alarms are present in the system

3.1.1.2 Ethernet Port

The Ethernet port can be used to communicate directly with the ADX DAS using a RJ-45 crossover cable or can also be used to connect the ADX DAS to an external modem box.



Figure 3-4 Ethernet Port

3.1.1.3 Host/Remote Switch

The Host/Remote Switch allows the user to switch the default Repeater IP, Subnet Mask, and Gateway of the repeater to an alternative setup. These settings can be adjusted by logging into the ADX DAS in HOST mode and configuring the settings under the Modem Box Setting section under the Install Page of NMS.

Once the settings are set, flipping the switch to the REMOTE position will reboot NMS module with the new alternate settings. *Please note that when the NMS is set to the REMOTE position, DHCP is disabled and the NMS will not automatically assign an IP address to any device that connects directly to the NMS.*

HOST



REMOTE

Figure 3-5 Host/Remote Switch

- Host IP: 192.168.63.1 (Fixed IP, unable to modify this IP address)
- Remote IP: 192.168.63.5 (Default IP, but can be modified in Host mode)

3.1.1.4 HE View/RU View Switch

The HE View/RU View Switch allows the user to disable the periodic monitoring performed by the NMS. In the HE view mode, the NMS monitors the status of all subordinate units connected to NMS but when switched to RU view the NMS does not monitor the subordinate units. RU View mode will allow the user to go to a RU and monitor/control the HE. If the NMS is set to the HE View mode and tries to connect to a RU to monitor the HE, data collisions between the NMS and RU may prevent the user from properly monitoring or configuring the HE when at the RU.

HE VIEW



RU VIEW

Figure 3-6 HE View/RU View Switch

3.1.2 RFU (ADX-H-RFU-x)

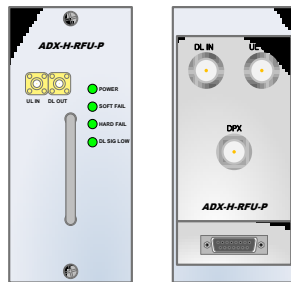

Figure 3-7 RFU Front & Rear View (excluding BT and VU)

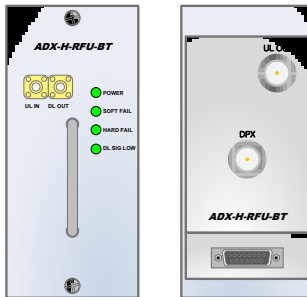

Figure 3-8 RFU Front & Rear View for BT



Figure 3-9 RFU Front & Rear View for VU

- Functions and features
 - Provide RF interface with BTS
 - Each RFU has independent gain control and filtering
 - Modular type and hot swappable
 - Supports duplex port or simplex TX & RX ports
 - Easily support additional frequency bands by adding a single RFU
 - Reduces complexity and overall equipment size
- Specifications
 - Size: 12.8 x 6.2 x 2.8 inches
 - Weight: 7.3 lbs

3.1.2.1 LEDs

RFU has LEDs on the front panel as shown in Figure 3-10.



Figure 3-10 RFU LED

Table 3-2 RFU LED Specifications

ADX DAS-Module		Specifications
Power	Solid Green	Module power is ON.
	OFF	Module power is OFF.
Soft Fail	Solid Yellow	Soft Fail alarm exists in the RFU.
	Solid Green	No Soft Fail alarms are present in the RFU.
Hard Fail	Solid Red	Hard Fail alarm exists in the RFU.
	Solid Green	No Hard Fail alarms are present in the RFU.
DL SIG LOW	Solid Yellow	When DL input signal level is lower than the defined threshold level. (default threshold value: -5dBm)
	Solid Green	When DL input signal level is upper than the defined threshold level.

3.1.2.2 RF Ports

3.1.2.2.1 DL IN/UL OUT & DPX ports

DL IN/UL OUT & DPX Ports (refer to Figure 3-7) are located at the back of RFU and can be connected directly to the BTS. The RFU can support incoming signal strength from 0 to 25dBm(in case of BT and VU, -15~37dBm).

BT RFU does not have DL IN port because of TDD(Time division duplex) system.

VU RFU does not have DPX port because there is externally optional Duplexer customized by user requirement for VHF/UHF system.

3.1.2.2.2 DL OUT/UL IN

DL OUT/UL IN Ports (refer to Figure 3-7) are located at the front of the RFU and connect directly to the HE Channel Combiner (ADX-H-CHC).

3.1.2.3 Communication Port

The ADX-H-NMS monitors and controls the RFU via this port. DC Power is also provided to the RFU via this port.

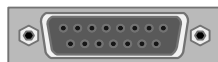

Figure 3-11 Communication Port (RFU)

3.1.3 Channel Combiner (ADX-H-CHC)



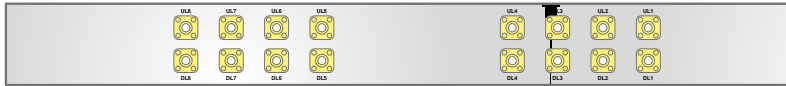

Figure 3-12 ADX-H-CHC Front & Rear View

- Functions & Features
 - Combines DL signals received from each RFU and feeds the combined signals to the ADX-H-OPT
 - Combines UL signals received from each RU and feeds the combined signal to the ADX-H-RFU
 - Supports up to 8 RFUs and (4) ADX-H-OPT-8 or (4)ADX-H-OPT-4
 - Channel Combiner is not connected to VU RFU because VU RFU internally includes 8way combiner for connection to 8 ODUs' VHF ports
- Specifications
 - Size: 16.9 x 12.9 x 1.7 inches
 - Weight: 11.0 lbs

3.1.3.1 RF ports

3.1.3.1.1 RF ports at the front panel (DL 1 to DL 8, UL 1 to UL 8)

DL 1(to DL 8) & UL 1(to UL 8) RF ports are connected to DL OUT/UL IN Ports at the front panel of RFU.

- Receive the downlink signal from each RFU
- Split the uplink signal received from ODU to each RFU

3.1.3.1.2 RF ports at the back panel (DL 1 to DL 8, UL 1 to UL 8)

DL 1(to DL 8) & UL 1(to UL 8) RF ports are connected to DL IN/UL OUT Ports at the back panel of OPT.

- Transfer the combined downlink signals to OPT
- Receive the uplink signal from ODU

3.1.3.2 RF ports

3.1.3.2.1 RF ports at the front panel(DL 1 to DL 8, UL 1 to UL 8)

DL 1(to DL 8) & UL 1(to UL 8) RF ports are connected to DL OUT/UL IN Ports at the front panel of RFU.

- Receive the downlink signal from each RFU
- Split the uplink signal received from ODU to each RFU

3.1.3.2.2 RF ports at the back panel(DL 1 to DL 8, UL 1 to UL 8)

DL 1(to DL 8) & UL 1(to UL 8) RF ports are connected to DL IN/UL OUT Ports at the back panel of OPT.

- Transfer the combined downlink signals to ODU
- Receive the uplink signal from ODU

3.1.4 Optic Distribution Unit (ADX-H-ODU + ADX-RACK-ODU)



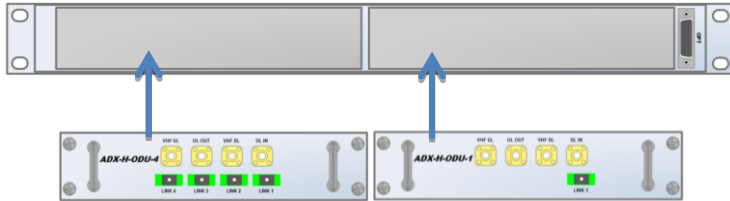

Figure 3-13 ADX-RACK-ODU + ADX-H-ODU-4/1 Front & Rear View

- Functions & Features
 - Converts signal from RF to optic and transports signals to Master RU
 - ADX-RACK-ODU can support up to (2) ADX-H-ODU units
 - ADX-H-ODU-4-X can supports up to (4) Master RUs with up to 5 dBo loss (including optical connection loss)
 - ADX-H-ODU-1-X can supports (1) Master RU with up to 10dBo loss (including optical connection loss)
 - Minimizes the number of optic fiber cable need by transporting multi band signals over a single strand of fiber using WDM technology.
 - VHF DL and VHF UL ports for VHF/UHF band transmission
- Spec
 - ADX-RACK-ODU
 - o Size: 19.0 x 12.9 x 1.7 inches (482 x 327 x 44 mm)
 - o Weight: 4.2 lbs
 - ADX-ODU-1/4
 - o Size: 7.96 x 7.17 x 1.64 inches (202 x 182 x 41.5 mm)
 - o Weight: 3.2 lbs

3.1.4.1 LEDs

The ADX-H-OPT-8 has the following LEDs on the front panel as shown in Figure 3-14. The ADX-H-OPT-4 has the same LEDs except for LD FAIL 5-8, LINK 5, LINK 6, LINK 7, AND LINK 8.



Figure 3-14 ADX-H-OPT-8 LED

Table 3-3 ODU Rack LED Specifications

ADX DAS-Module		Specifications
Power	Solid Green	Module power is ON
	OFF	Module power is OFF
LD FAIL 1-4/ LD FAIL 5-8	OFF	ODU is not installed
	Solid Yellow	LD Fail alarm exists in the ODU
	Solid Green	No LD Fail alarm is present in the ODU
LINK1 to LINK8	Solid Yellow	PD Fail alarm exists
	Solid Green	No PD Fail alarm is present

3.1.4.2 RF Ports

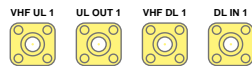

Figure 3-15 ODU RF Ports

3.1.4.2.1 DL IN/UL OUT

The combined downlink signal received from ADX-H-CHC is transferred to the DL IN 1(or 2) at the back of OPT. The UL OUT port connects any of the ports on back of the ADX-H-CHC labeled UL 1 ~8.

3.1.4.2.2 VHF DL/VHF UL

VHF DL/UHF UL ports are used to support Public Safety in the VHF & UHF frequency bands. VHF/UHF signals for Public Safety bypass the ADX-H-CHC and connect directly to the VHF DL/UHF UL ports of the ADX-H-OPT.

3.2 Remote Unit

The remote unit is composed of a (1) Master RU and up to (7) Slave RU's (ADX-R-4WS is required when connecting more than 3 Slave RU's). A power source, either the ADX-R-ADP-30 (supports [1] Master/Slave RU) or the ADX-R-PSU-30 (supports up to [8] Master/Slave RU) is required.

- Specifications
 - Size: 19.0 x 12.9 x 10.5 inches
 - Weight: 61.0 lbs
 - Power Input: 110VAC or -48VDC (optional)

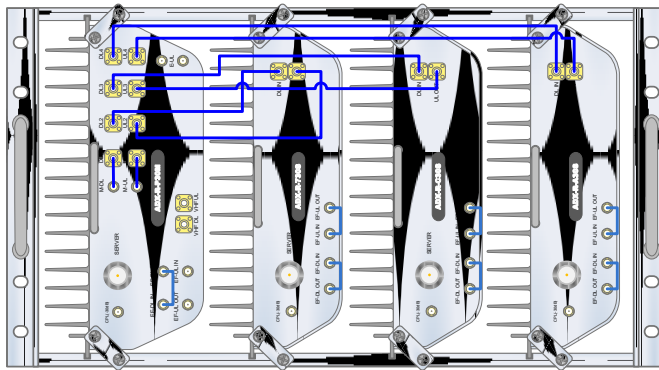

Figure 3-16 RU Front View

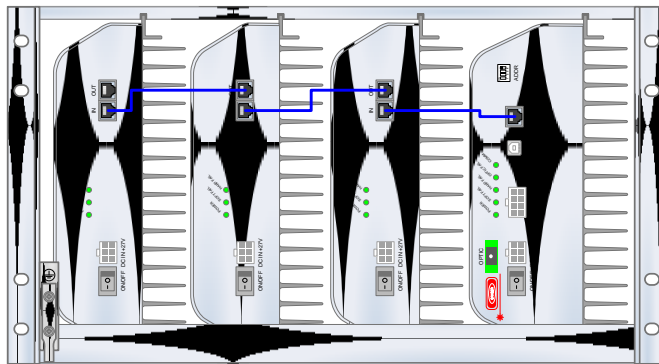

Figure 3-17 RU Rear View

3.2.1 ADX-R-x3xM (Master RU)

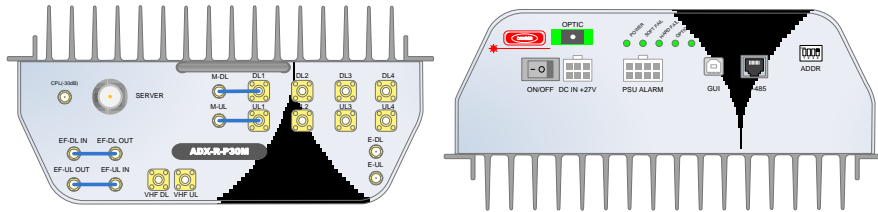

Figure 3-18 Master RU Front & Rear View(excluding BT)

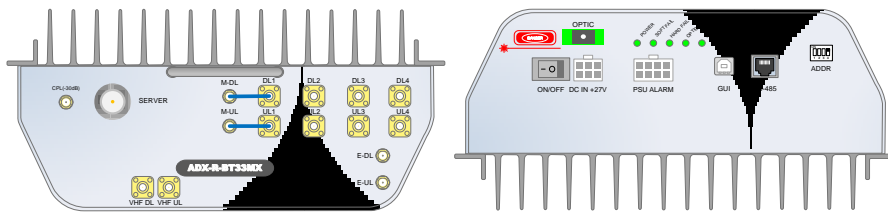

Figure 3-19 Master RU Front & Rear View only for BT

- **Functions & Features**
 - Converts DL optic signal to a RF signal
 - Converts UL RF signal to an optic signal
 - Splits the converted RF signals and which provide RF to Slave RU's
 - Transmits DL signal and receives UL signal through server antenna
 - Supports up to 7 slave RUs
 - Individually wall-mountable or 19" rack-mountable (requires ADX-R-CHA)
 - Supports external filters via DL and UL pass-through ports
- **Specifications**
 - Size: 11.8 x 9.8 x 4.5 inches
 - Weight: 13.2 lbs

3.2.1.1 LEDs

Master RU's have the following LEDs on the front panel as shown in Figure 3-20.



Figure 3-20 Master RU LED

Table 3-4 Master RU LED Specifications

ADX DAS-Module		Specifications
Power	Solid Green	Module power is ON
	OFF	Module power is OFF

Soft Fail	Solid Yellow	Soft Fail alarm exists in the Master RU
	Solid Green	No Soft Fail alarms are present in the Master RU
Hard Fail	Solid Red	Hard Fail alarm exists in the Master RU
	Solid Green	No Hard Fail alarms are present in the Master RU
Optic Fail	Solid Yellow	Optic Fail alarm exists in the Master RU
	Solid Green	No Optic Fail alarm is present in the Master RU
COMM	Solid Yellow	COMM Fail alarm exists in the Master RU
	Solid Green	No COMM Fail alarm is present in the Master RU

3.2.1.2 RF Ports

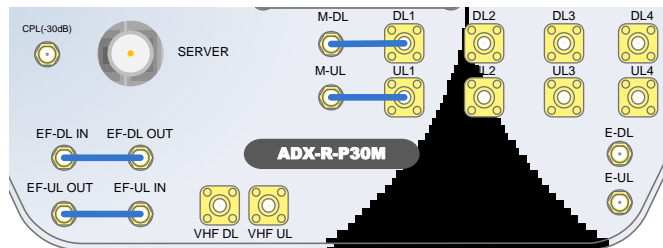

Figure 3-21 RF Ports (Master RU)

3.2.1.2.1 M-DL/M-UL, DL1 to DL4 & UL1 to UL4

- M-DL/M-UL ports
 - Master RU units will come with the M-DL and M-UL ports pre-connected to the DL1 and UL1 ports.
- DL2 to DL4 & UL2 to UL4 ports
 - Slave RU's connect to the DL2 ~DL4 and UL2~UL4 ports.

3.2.1.2.2 E-DL/E-UL

- The E-DL/E-UL ports connect to the ADX-R-4WS (4-way splitter)
- The ADX-R-4WS will provide an additional (4) DL and UL ports to connect up to (4) additional Slave RU's
- ADX-R-4WS divides the output of E-DL port to extended slave RUs and combines/transfers UL signal received from extended slave RUs to E-UL port.

3.2.1.2.3 VHF DL/VHF UL

- Connects to the ADX-R-V25S (VHF Slave RU) for public safety service in the VHF/UHF bands

3.2.1.2.4 SERVER & CPL

- Server Port
 - Connects directly to a server antenna or the ADX-R-CHC (remote channel combiner)
- CPL Port
 - 30dB coupling port off of the server port

3.2.1.2.5 EF-DL IN/EF-DL OUT & EF-UL IN/EF-UL OUT

- Connects to an external DL/UL filter
- DL external filter can be used to reduce DL out-band emissions
- UL external filter can be used to reduce out-band frequencies
- BT RU does not have external filter ports because there are no issues for external filtering

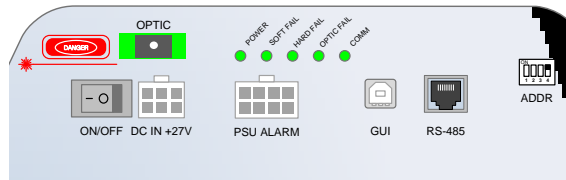

Figure 3-22 Ports at the back panel (Master RU)

3.2.1.3 Optic Port

- Connects to ADX-H-OPT-8, ADX-H-OPT-4, or ADX-R-OEU via optic line

3.2.1.4 Power On/Off Switch & DC IN Port

- Power On/Off switch
 - Master RU Power On/Off switch
- DC IN Port
 - Connects to DC output port of AC/DC adapter (ADX-R-ADP-30) or RU PSU (ADX-R-PSU-30)

3.2.1.5 PSU Alarm Port

- Connects to the ADX-R-PSU-30
- The ADX-H-NMS and the Master RU can monitor the status of the ADX-H-PSU-30 via this port

3.2.1.6 GUI Port

- Connects to a laptop via USB cable
- Monitor/control the RU and the HE connected to the RU using User GUI, which is a Windows based program. ADRF 32-bit or 64-bit drivers will also be required to access the RU using the User GUI.

3.2.1.7 RS-485 Port

- Slave RU should be connected to master RU in a daisy chain structure using RS-485 line to monitor and control slave RUs.
- The RS-485 cable connected to master RU should be connected to RS-485 IN port of slave RU. When a slave RU is connected to another slave RU, then the RS-485 cable should be connected from the RS-485 OUT port to the RS-485 IN of the 2nd Slave RU. (Figure 3-23)
- If RS-485 port connections between Remote Modules are not correct, master RU will not be able to recognize all subordinate slave RUs. (Figure 3-24)
- **WARNING! The RS-485 ports should NEVER be connected to the Ethernet port of laptop or Ethernet Network Equipment. Doing so may cause serious damage to the Remote Modules or network equipments. (Figure 3-25)**

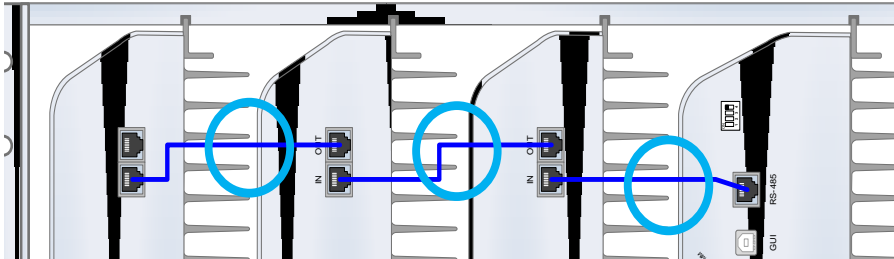

Figure 3-23 Correct RS-485 connection between Master RU and Slave RU or between Slave RUs

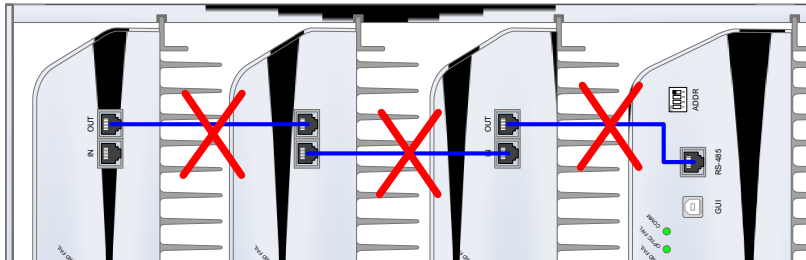
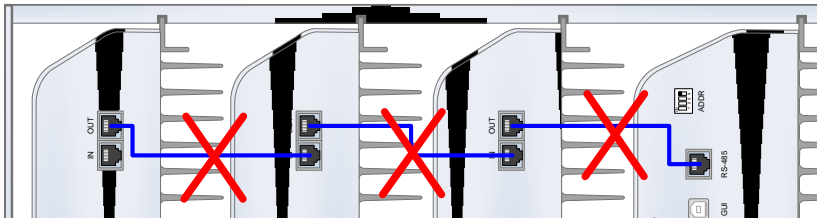

Figure 3-24 Wrong RS-485 connection between Master RU and Slave RU or between Slave RUs

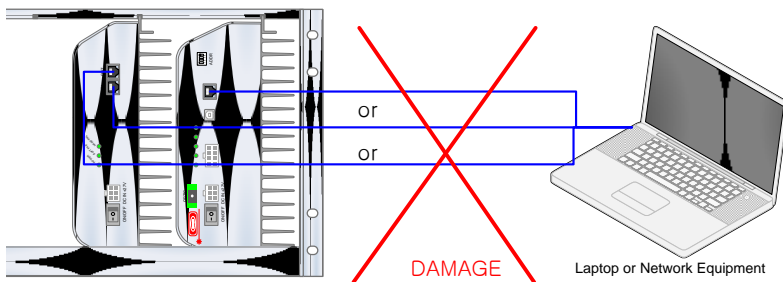

Figure 3-25 Do NOT connect RS-485 ports of Remote Module to network equipment port

3.2.1.8 ADDR

- The ID of master RU can be set manually using ADDR switch. This switch should only be use if instructed by ADRF Technical Support.

3.2.2 ADX-R-xxxS/ADX-R-BTxxS/ADX-R-VU25S (Slave RU)

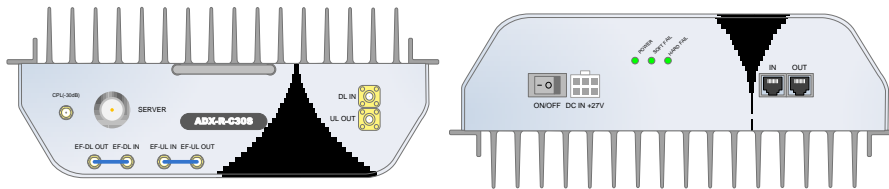

Figure 3-26 Slave RU Front & Rear View (excluding BT and VU)

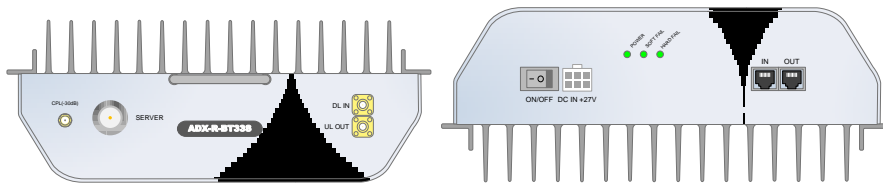

Figure 3-27 Slave RU Front & Rear View (BT)

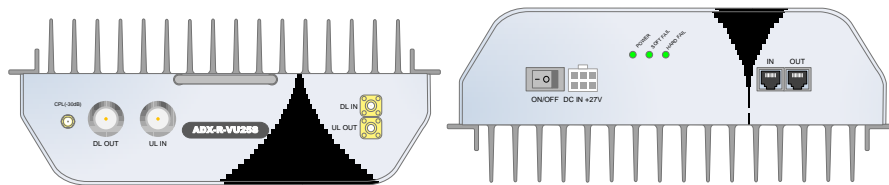

Figure 3-28 Slave RU Front & Rear View (excluding VU)

- Functions & Features
 - Transmits DL signal and receives UL signal through server antenna port
 - Individually wall-mountable or 19" rack-mountable (requires ADX-R-CHA)
 - Supports external filters via DL and UL pass-through ports
- Specification
 - Size: 11.8 x 9.8 x 3.7 inches (300 x 249.6 x 94.5 mm)
 - Weight: 11.7 lbs (5.3 kg)

3.2.2.1 LEDs

ADX-R-x30S has the following LEDs on the front of the Slave RU as shown below in Figure 3-29.



Figure 3-29 Slave RU LED

Table 3-5 Slave RU LED Specifications

ADX DAS-Module		Specifications
Power	Solid Green	Module power is ON
	OFF	Module power is OFF
Soft Fail	Solid Yellow	Soft Fail alarm exists in the Slave RU
	Solid Green	No Soft Fail alarms are present in the Slave RU
Hard Fail	Solid Red	Hard Fail alarm exists in the Slave RU
	Solid Green	No Hard Fail alarms are present in the Slave RU

3.2.2.2 RF Ports



Figure 3-30 RF Ports (Slave RU)

3.2.2.2.1 DL IN & UL OUT

- Connects to one of the available DL 2 to 4/UL 2 to 4 ports of the Master RU
- DL IN port receives the divided DL output from the Master RU
- UL OUT port transfers the UL output of slave RU to the Master RU

3.2.2.2.2 SERVER & CPL

- Server Port
 - Connects directly to a server antenna or the ADX-R-CHC (remote channel combiner)
- CPL Port
 - 30dB coupling port off of the server port

3.2.2.2.3 EF-DL IN/EF-DL OUT & EF-UL IN/EF-UL OUT

- Connect to an external DL/UL filter
- DL external filter can be used to reduce out-band emissions
- UL external filter can be used to reduce uplink out-band signals
- BT and VU RU do not have external filter ports because there are no issues for external filtering



Figure 3-31 Ports at the rear panel (Slave RU)

3.2.2.3 Power On/Off Switch & DC IN Port

- Power On/Off switch
 - Slave RU Power On/Off switch
- DC IN Port
 - Connected to DC output port of AC/DC adaptor (ADX-R-ADP-30) or RU PSU (ADX-R-PSU-30)

3.2.2.4 RS-485 Port

- Slave RU should be connected to master RU in a daisy chain structure using RS-485 line to monitor and control slave RUs.
- The RS-485 cable connected to master RU should be connected to RS-485 IN port of slave RU. When a slave RU is connected to another slave RU, then the RS-485 cable should be connected from the RS-485 OUT port to the RS-485 IN of the 2nd Slave RU. (Figure 3-23)
- If RS-485 port connections between Remote Modules are not correct, master RU will not be able to recognize all subordinate slave RUs. (Figure 3-24)
- **WARNING! The RS-485 ports should NEVER be connected to the Ethernet port of laptop or Ethernet Network Equipment. Doing so may cause serious damage to the Remote Modules or network equipments. (Figure 3-25)**

3.2.3 RU Power Supply Options

3.2.3.1 ADX-R-ADP (RU Power Adapter)

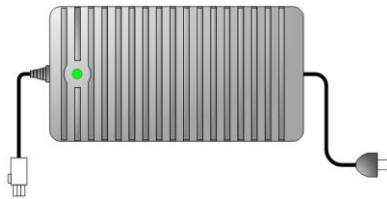

The ADX-R-ADP-30 is capable of powering 1 remote module (Master or Slave RU).

3.2.3.2 ADX-R-PSU (RU Power Supply Unit)

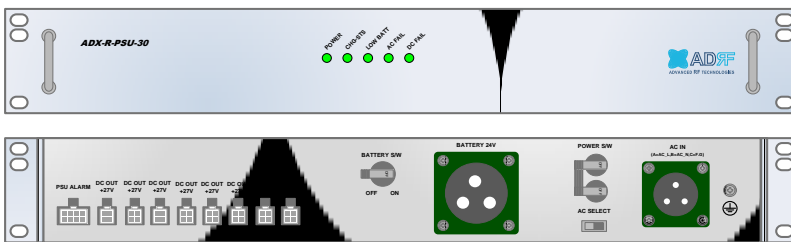

Figure 3-32 RU PSU Front & Rear View

- Functions & Features
 - Provides power to 8 remote modules (Master or Slave RU)
 - Supports ADRF-BBU Battery Backup
- Spec

- Size: 19.0 x 12.0 x 2.6 inches (482 x 304x 66 mm)
- Weight: 9.9lbs (4.5 kg)
- Power Input: 110V or 220VAC, selectable by switch

3.2.3.2.1 LEDs

ADX DAS has the following LEDs on the front of the RU PSU as shown below in Figure 3-33.



Figure 3-33 RU PSU LED

Table 3-6 RU PSU LED Specifications

ADX DAS-Module		Specifications
Power	Solid Green	Module power is ON
	OFF	Module power is OFF
CHG STS	Solid Yellow	No AC power detected and ADRF-BBU is being used
	Blinking Green	ADRF-BBU is being charged
	Solid Green	Completely Charged
	OFF	Battery is not connected
LOW BATT	Solid Yellow	Low Battery alarm exist in the PSU
	Solid Green	No Low Battery alarm is present in the PSU
AC FAIL	Solid Yellow	AC Fail alarm exist in the PSU
	Solid Green	No AC Fail alarm is present in the PSU
DC FAIL	Solid Yellow	DC Fail alarm exist in the RFU
	Solid Green	No DC Fail alarms is present in the PSU

3.2.3.2.2 AC Input On/Off Switch, AC Input Port and AC Input Selection Switch

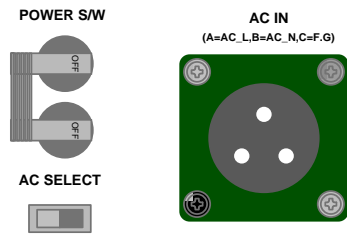

Figure 3-34 RU PSU Power Switch View

The AC Power on/off switch is located at the rear of the ADX-R-PSU-30. The ADX-R-PSU-30 can be operated at the 110V AC or 220V AC. The AC Input Voltage should be properly set by the user.

3.2.3.2.3 Battery Backup Port and Battery Backup Switch

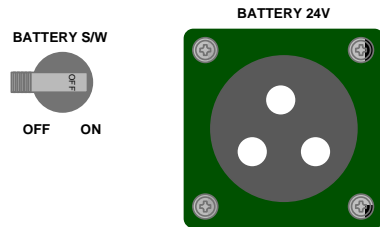

Figure 3-35 Battery Backup Port & Battery Backup Switch

When the Battery S/W is set to the ON position, the power supply charges the optional ADRF-BBU (External Backup Battery) (Figure 3-35).

The RU PSU can be connected to an ADRF-BBU (ADRF Battery Backup Unit) to provide power during a power failure. If an ADRF-BBU is utilized, connect the ADRF-BBU to the RU PSU via the external battery backup port as shown in Figure 3-35.

(WARNING: The circuit switch on the ADRF-BBU must be set to OFF before connecting the ADRF-BBU to the HE PSU to prevent damage to the HE PSU or the ADRF-BBU and personal injury.)

Note: Please contact ADRF Technical Support for assistance if you are unfamiliar with the installation procedure of our battery box.

The procedure for connecting RU PSU to BBU

- BATT S/W OFF
- Connect BBU to RU PSU Battery port using RU battery cable
- BATT S/W ON

3.2.3.2.4 DC Output Port



Figure 3-36 DC Output Port (RU PSU)

- (8) DC output ports are available to connect up to 8 remote modules (Master or Slave RU's)

3.2.3.2.5 PSU Alarm Port



Figure 3-37 PSU Alarm Port (RU PSU)

- Connects to the Master RU to monitor the status of the ADX-R-PSU-30
- The ADX-H-NMS & Master RU monitor the status of the ADX-R-PSU-30 via this port

4. CABLE CONNECTION

4.1 Head End Connection Diagrams

4.1.1 Front/Rear Head End Connection View with Optional BCU unit

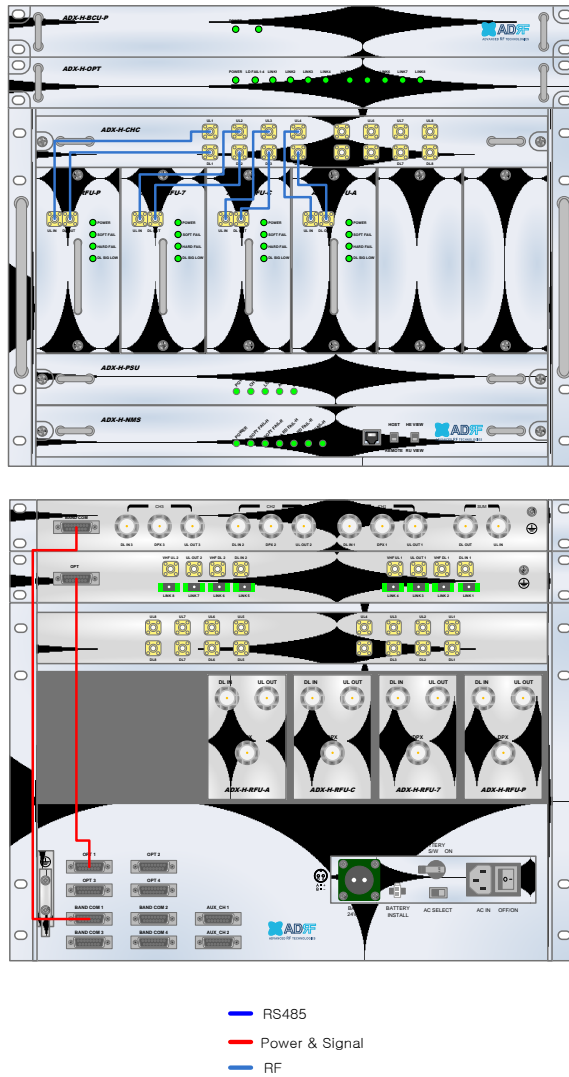
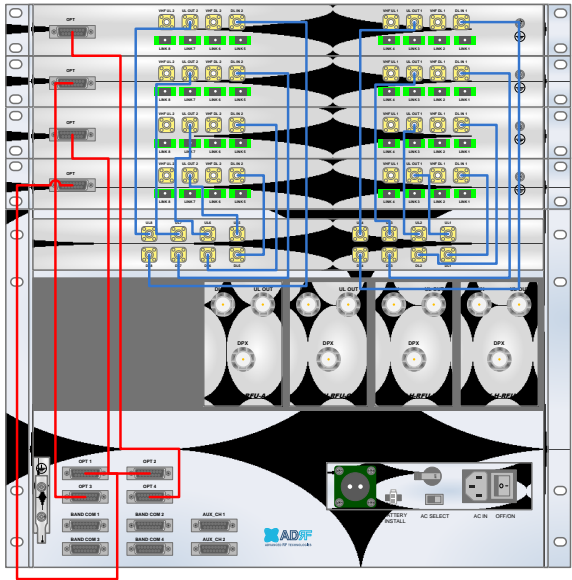

Figure 4-1 HE Cable connection (1 OPT-8 +1 BCU)

4.1.2 Rear Head End Connection View with (4) OPT-8 units



- RS485
- Power & Signal
- RF

Figure 4-2 HE Cable connection (4 OPTs)

4.2 Remote Unit Connection Diagrams

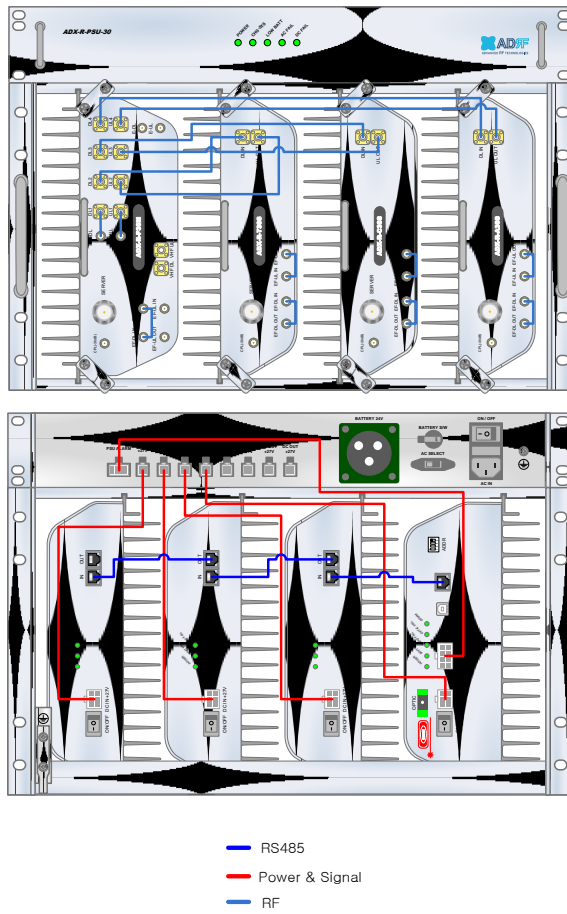

Figure 4-3 RU Cable connection (4 Remote Module + RU PSU)

4.3 Remote Unit w/ 4-Way Combiner (ADX-R-4WS)

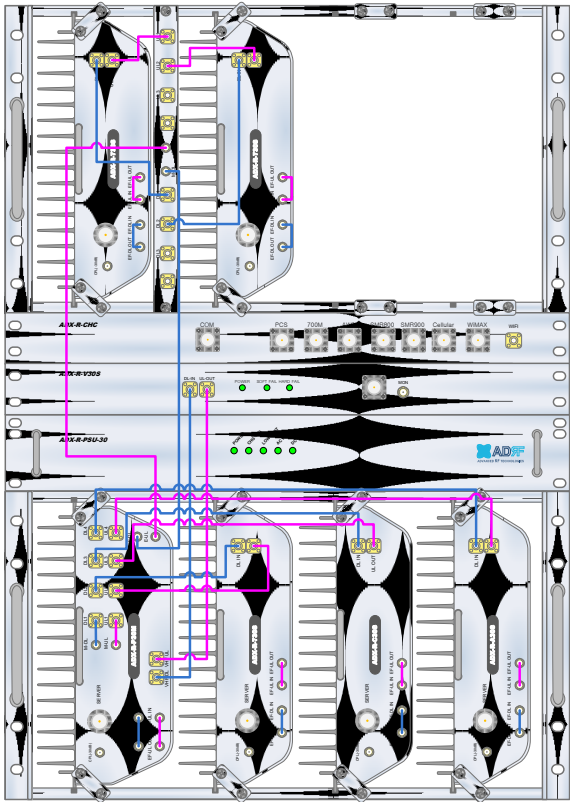

Figure 4-4 Slave RU Expansion using ADX-R-4WS