



# FCC TEST REPORT

**REPORT NO.:** RF930715L19A  
**MODEL NO.:** WRTD-117GW  
**OEM MODEL NO.:** Wilson 2.0, NV20VRAG  
**RECEIVED:** Oct. 14, 2004  
**TESTED:** Oct. 27 ~ Nov. 05, 2004

**APPLICANT:** Gemtek Technology Co., Ltd.

**ADDRESS:** No. 1, Jen Ai Road, Hsinchu Industrial Park,  
Hukou Hsinchu, Taiwan, R.O.C. 303

**ISSUED BY:** Advance Data Technology Corporation

**LAB ADDRESS:** No. 47, 14th Ling, Chia Pau Tsuen, Lin Kou  
Hsiang 244, Taipei Hsien, Taiwan, R.O.C.

**TEST LOCATION:** No. 19, Hwa Ya 2<sup>nd</sup> Rd., Wen Hwa Tsuen, Kwei  
Shan Hsiang, Taoyuan Hsien 333, Taiwan,  
R.O.C.

This test report consists of 66 pages in total. It may be duplicated completely for legal use with the approval of the applicant. It should not be reproduced except in full, without the written approval of our laboratory. The client should not use it to claim product endorsement by CNLA, A2LA or any government agencies. The test results in the report only apply to the tested sample.



No. 2177-01



0528  
ILAC MRA



## Table of Contents

1	CERTIFICATION .....	4
2	SUMMARY OF TEST RESULTS .....	5
2.1	MEASUREMENT UNCERTAINTY .....	5
3	GENERAL INFORMATION .....	6
3.1	GENERAL DESCRIPTION OF EUT .....	6
3.2	DESCRIPTION OF TEST MODES.....	7
3.3	GENERAL DESCRIPTION OF APPLIED STANDARDS.....	7
3.4	DESCRIPTION OF SUPPORT UNITS .....	8
3.5	CONFIGURATION OF SYSTEM UNDER TEST.....	8
4	TEST TYPES AND RESULTS .....	9
4.1	CONDUCTED EMISSION MEASUREMENT .....	9
4.1.1	LIMITS OF CONDUCTED EMISSION MEASUREMENT .....	9
4.1.2	TEST INSTRUMENTS .....	9
4.1.3	TEST PROCEDURES .....	10
4.1.4	DEVIATION FROM TEST STANDARD .....	10
4.1.5	TEST SETUP .....	11
4.1.6	EUT OPERATING CONDITIONS .....	11
4.1.7	TEST RESULTS.....	12
4.2	RADIATED EMISSION MEASUREMENT .....	18
4.2.1	LIMITS OF RADIATED EMISSION MEASUREMENT .....	18
4.2.2	TEST INSTRUMENTS .....	19
4.2.3	TEST PROCEDURES .....	20
4.2.4	DEVIATION FROM TEST STANDARD .....	20
4.2.5	TEST SETUP .....	21
4.2.6	EUT OPERATING CONDITIONS .....	21
4.2.7	TEST RESULTS.....	22
4.2.8	TEST RESULTS (A) .....	24
4.2.9	TEST RESULTS (B).....	27
4.3	6dB BANDWIDTH MEASUREMENT .....	30
4.3.1	LIMITS OF 6dB BANDWIDTH MEASUREMENT .....	30
4.3.2	TEST INSTRUMENTS .....	30
4.3.3	TEST PROCEDURE .....	31
4.3.4	DEVIATION FROM TEST STANDARD .....	31
4.3.5	TEST SETUP .....	31
4.3.6	EUT OPERATING CONDITIONS .....	31



4.3.7	TEST RESULTS (A) .....	32
4.3.8	TEST RESULTS (B).....	36
4.4	MAXIMUM PEAK OUTPUT POWER .....	40
4.4.1	LIMITS OF MAXIMUM PEAK OUTPUT POWER MEASUREMENT .....	40
4.4.2	TEST INSTRUMENTS .....	40
4.4.3	TEST PROCEDURES .....	41
4.4.4	DEVIATION FROM TEST STANDARD .....	41
4.4.5	TEST SETUP .....	41
4.4.6	EUT OPERATING CONDITIONS .....	41
4.4.7	TEST RESULTS (A) .....	42
4.4.8	TEST RESULTS (B).....	42
4.5	POWER SPECTRAL DENSITY MEASUREMENT .....	43
4.5.1	LIMITS OF POWER SPECTRAL DENSITY MEASUREMENT .....	43
4.5.2	TEST INSTRUMENTS .....	43
4.5.3	TEST PROCEDURE.....	44
4.5.4	DEVIATION FROM TEST STANDARD .....	44
4.5.5	TEST SETUP .....	44
4.5.6	EUT OPERATING CONDITIONS .....	44
4.5.7	TEST RESULTS (A) .....	45
4.5.8	TEST RESULTS (B).....	49
4.6	BAND EDGES MEASUREMENT.....	53
4.6.1	LIMITS OF BAND EDGES MEASUREMENT .....	53
4.6.2	TEST INSTRUMENTS .....	53
4.6.3	TEST PROCEDURE.....	53
4.6.4	DEVIATION FROM TEST STANDARD .....	53
4.6.5	EUT OPERATING CONDITION.....	53
4.6.6	TEST RESULTS.....	54
4.6.7	TEST RESULTS(A) .....	54
4.6.8	TEST RESULTS(B).....	54
4.7	ANTENNA REQUIREMENT .....	63
4.7.1	STANDARD APPLICABLE.....	63
4.7.2	ANTENNA CONNECTED CONSTRUCTION.....	63
5	PHOTOGRAPHS OF THE TEST CONFIGURATION .....	64
6	INFORMATION ON THE TESTING LABORATORIES.....	66



## 1 CERTIFICATION

**PRODUCT :** Wireless AP VPN Router  
**BRAND NAME :** Gemtek  
**OEM BRAND NAME:** Flex-P, Neo Vantage  
**MODEL NO. :** WRTD-117GW  
**OEM MODEL NO.:** Wilson 2.0, NV20VRAG  
**APPLICANT :** Gemtek Technology Co., Ltd.  
**TESTED :** Oct. 27 ~ Nov. 05, 2004  
**TEST SAMPLE :** ENGINEERING SAMPLE  
**STANDARDS :** FCC Part 15, Subpart C (Section 15.247),  
ANSI C63.4-2003

The above equipment (model no.: WRTD-117GW) has been tested by **Advance Data Technology Corporation**, and found compliance with the requirement of the above standards. The test record, data evaluation & Equipment Under Test (EUT) configurations represented herein are true and accurate accounts of the measurements of the sample's EMC characteristics under the conditions specified in this report.

**PREPARED BY :** Windy Chou , **DATE:** Nov. 09, 2004  
( Windy Chou )

**TECHNICAL**  
**ACCEPTANCE :** Gary Chang , **DATE:** Nov. 09, 2004  
Responsible for RF ( Gary Chang )

**APPROVED BY :** Cody Chang , **DATE:** Nov. 09, 2004  
( Cody Chang, Deputy Manager )

## 2 SUMMARY OF TEST RESULTS

The EUT has been tested according to the following specifications:

APPLIED STANDARD: FCC Part 15, Subpart C			
Standard Section	Test Type and Limit	Result	REMARK
15.207	AC Power Conducted Emission	PASS	Meet the requirement of limit. Minimum passing margin is -8.41dB at 2.293MHz
15.247(a)(2)	Spectrum Bandwidth of a Direct Sequence Spread Spectrum System Limit: min. 500kHz	PASS	Meet the requirement of limit.
15.247(b)	Maximum Peak Output Power Limit: max. 30dBm	PASS	Meet the requirement of limit.
15.247(d)	Transmitter Radiated Emissions Limit: Table 15.209	PASS	Meet the requirement of limit. Minimum passing margin is -1.73dB at 556.79MHz
15.247(e)	Power Spectral Density Limit: max. 8dBm	PASS	Meet the requirement of limit.
15.247(d)	Band Edge Measurement Limit: 20 dB less than the peak value of fundamental frequency	PASS	Meet the requirement of limit.

### 2.1 MEASUREMENT UNCERTAINTY

Where relevant, the following measurement uncertainty levels have been estimated for tests performed on the EUT as specified in CISPR 16-4:

Measurement	Frequency	Uncertainty
Conducted emissions	9k~30MHz	2.44 dB
Radiated emissions	30MHz ~ 200MHz	3.55 dB
	200MHz ~ 1000MHz	3.58 dB
	1GHz ~ 18GHz	2.20 dB
	18GHz ~ 40GHz	1.88 dB



### 3 GENERAL INFORMATION

#### 3.1 GENERAL DESCRIPTION OF EUT

<b>PRODUCT</b>	Wireless AP VPN Router
<b>MODEL NO.</b>	WRD-117GW
<b>OEM MODEL NO.</b>	Wilson 2.0, NV20VRAG
<b>POWER SUPPLY</b>	5.0Vdc from AC adapter
<b>MODULATION TYPE</b>	BPSK, QPSK, CCK, 16QAM, 64QAM
<b>RADIO TECHNOLOGY</b>	DSSS, OFDM
<b>TRANSFER RATE</b>	802.11b: 11/5.5/2/1Mbps 802.11g: 54/48/36/24/18/12/9/6Mbps
<b>FREQUENCY RANGE</b>	2412MHz ~ 2462MHz
<b>NUMBER OF CHANNEL</b>	11
<b>MAXIMUM OUTPUT POWER</b>	31.842mW
<b>ANTENNA TYPE</b>	Dipole antenna with 5dBi gain
<b>DATA CABLE</b>	NA
<b>I/O PORTS</b>	RJ45
<b>ASSOCIATED DEVICES</b>	NA

**NOTE:**

1. This report is prepared for FCC class II permissive change.
2. This report is issued as a supplementary report due to change debug solution and re-tests conducted and radiated test only, the other test items are same as original test report (RF930715L19).
3. The EUT operates in the 2.4GHz frequency spectrum with throughput of up to 54Mbps.
4. The EUT complies with IEEE 802.11g standards, and backwards compatible with IEEE 802.11b products.
5. The EUT was operated with following adapter.

<b>Brand</b>	LEI
<b>Model No.</b>	MT15-5050250-A1
<b>Input power</b>	100-120Vac, 50/60Hz, 0.5A
<b>Output power</b>	5.0Vdc, 2.5A

6. This EUT has other different models and brand names that listed below due to marketing requirement.

<b>Brand Name</b>	<b>Model Name</b>
Flex-P	Wilson 2.0
Neo Vantage	NV20VRAG

7. The above EUT information was declared by manufacturer and for more detailed features description, please refer to the manufacturer's specifications or User's Manual.



### 3.2 DESCRIPTION OF TEST MODES

Eleven channels are provided to this EUT.

Channel	Frequency	Channel	Frequency
1	2412 MHz	7	2442 MHz
2	2417 MHz	8	2447 MHz
3	2422 MHz	9	2452 MHz
4	2427 MHz	10	2457 MHz
5	2432 MHz	11	2462 MHz
6	2437 MHz		

**NOTE:**

1. Below 1GHz, the channel 1, 6, and 11 were pre-tested in chamber. The channel 11, the worst case, was chosen for final test.
2. Above 1GHz, the channel 1, 6, and 11 were tested individually.
3. From our experience and technical viewpoint, we have chosen data rates 11Mbps for CCK technique and 6Mbps for OFDM technique, as the worst cases for the test among other data rates.
4. Two test results were presented in the following sections. The test result A was for CCK technique and the test result B was for OFDM technique.

### 3.3 GENERAL DESCRIPTION OF APPLIED STANDARDS

The EUT is a Wireless AP VPN Router. According to the specifications of the manufacturer, it must comply with the requirements of the following standards:

**FCC Part 15, Subpart C. (15.247)**  
**ANSI C63.4-2003**

All test items have been performed and recorded as per the above standards.

**NOTE:** The EUT is also considered as a kind of computer peripheral, because the connection to computer is necessary for typical use. It has been verified to comply with the requirements of FCC Part 15, Subpart B, Class B (DoC). The test report has been issued separately.



**3.4 DESCRIPTION OF SUPPORT UNITS**

The EUT has been tested as an independent unit together with other necessary accessories or support units. The following support units or accessories were used to form a representative test configuration during the tests.

NO.	PRODUCT	BRAND	MODEL NO.	SERIAL NO.	FCC ID
1	NOTEBOOK COMPUTER	DELL	PP05L	16484462992	E2K24CLNS
2	NOTEBOOK COMPUTER	DELL	PP05L	12130898320	E2K24CLNS
3	PRINTER	EPSON	LQ-300+	DCGY054146	FCC DoC Approved
4	MODEM	ACEEX	1414V/3	0401008260	IFAXDM1414

NO.	SIGNAL CABLE DESCRIPTION OF THE ABOVE SUPPORT UNITS
1	NA
2	NA
3	1.2m shielded cable without core
4	1.2m shielded cable without core

- NOTE:** 1. All power cords of the above support units are non shielded (1.8m).  
 2. Item 1 act as a communication partner to transfer data.

**3.5 CONFIGURATION OF SYSTEM UNDER TEST**

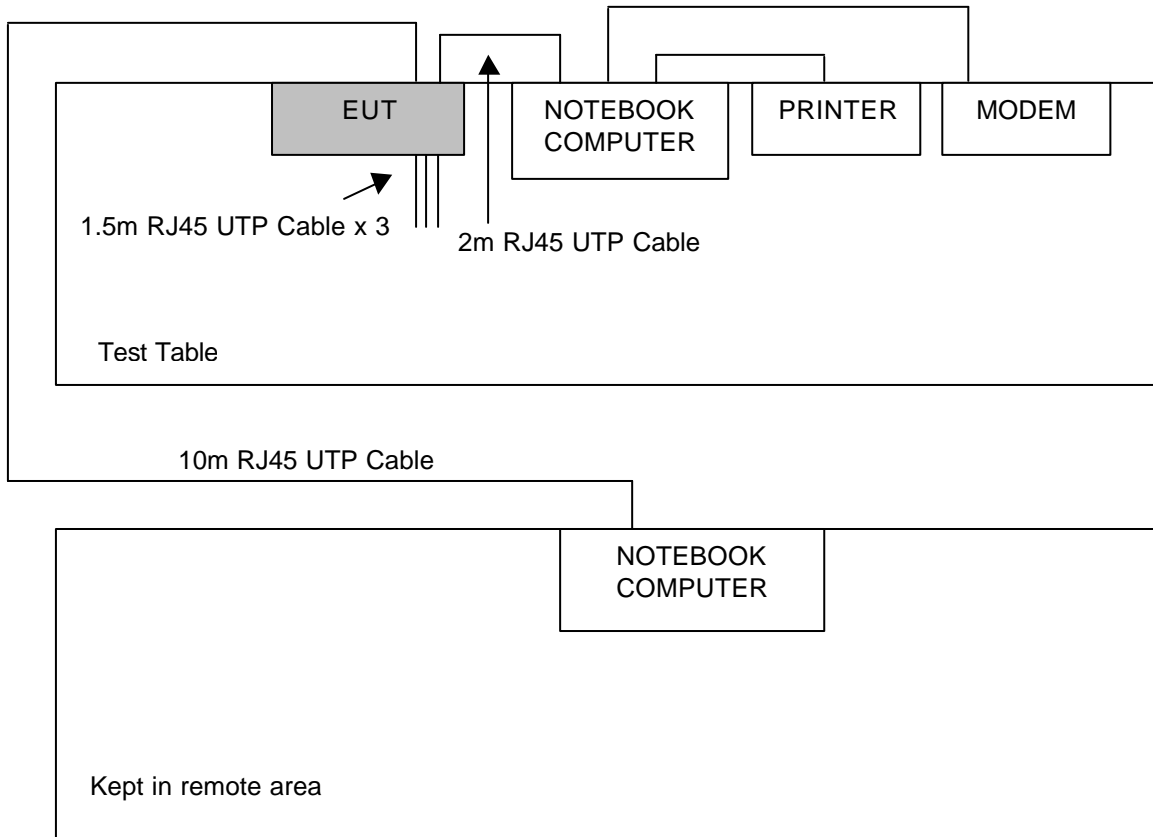





## 4 TEST TYPES AND RESULTS

### 4.1 CONDUCTED EMISSION MEASUREMENT

#### 4.1.1 LIMITS OF CONDUCTED EMISSION MEASUREMENT

FREQUENCY OF EMISSION (MHz)	CONDUCTED LIMIT (dB $\mu$ V)	
	Quasi-peak	Average
0.15-0.5	66 to 56	56 to 46
0.5-5	56	46
5-30	60	50

- NOTE:**
1. The lower limit shall apply at the transition frequencies.
  2. The limit decreases in line with the logarithm of the frequency in the range of 0.15 to 0.50 MHz.
  3. All emanations from a class A/B digital device or system, including any network of conductors and apparatus connected thereto, shall not exceed the level of field strengths specified above.

#### 4.1.2 TEST INSTRUMENTS

DESCRIPTION & MANUFACTURER	MODEL NO.	SERIAL NO.	CALIBRATED UNTIL
Test Receiver ROHDE & SCHWARZ	ESCS30	100291	Dec. 12, 2004
RF signal cable Woken	5D-FB	Cable-HYC01-01	Mar. 02, 2005
LISN ROHDE & SCHWARZ	ESH3-Z5	100312	Mar. 03, 2005
LISN ROHDE & SCHWARZ	ESH2-Z5	100104	Mar. 02, 2005
Software ADT	ADT_Cond_V3	NA	NA

- NOTE:**
1. The calibration interval of the above test instruments is 12 months and the calibrations are traceable to NML/ROC and NIST/USA.
  2. The test was performed in HwaYa Shielded Room 1.
  3. The VCCI Site Registration No. is C-2040.



#### 4.1.3 TEST PROCEDURES

- a. The EUT was placed 0.4 meters from the conducting wall of the shielded room with EUT being connected to the power mains through a line impedance stabilization network (LISN). Other support units were connected to the power mains through another LISN. The two LISNs provide 50 ohm/ 50uH of coupling impedance for the measuring instrument.
- b. Both lines of the power mains connected to the EUT were checked for maximum conducted interference.
- c. The frequency range from 150kHz to 30MHz was searched. Emission levels under Limit - 20dB was not recorded.

#### 4.1.4 DEVIATION FROM TEST STANDARD

No deviation

#### 4.1.5 TEST SETUP

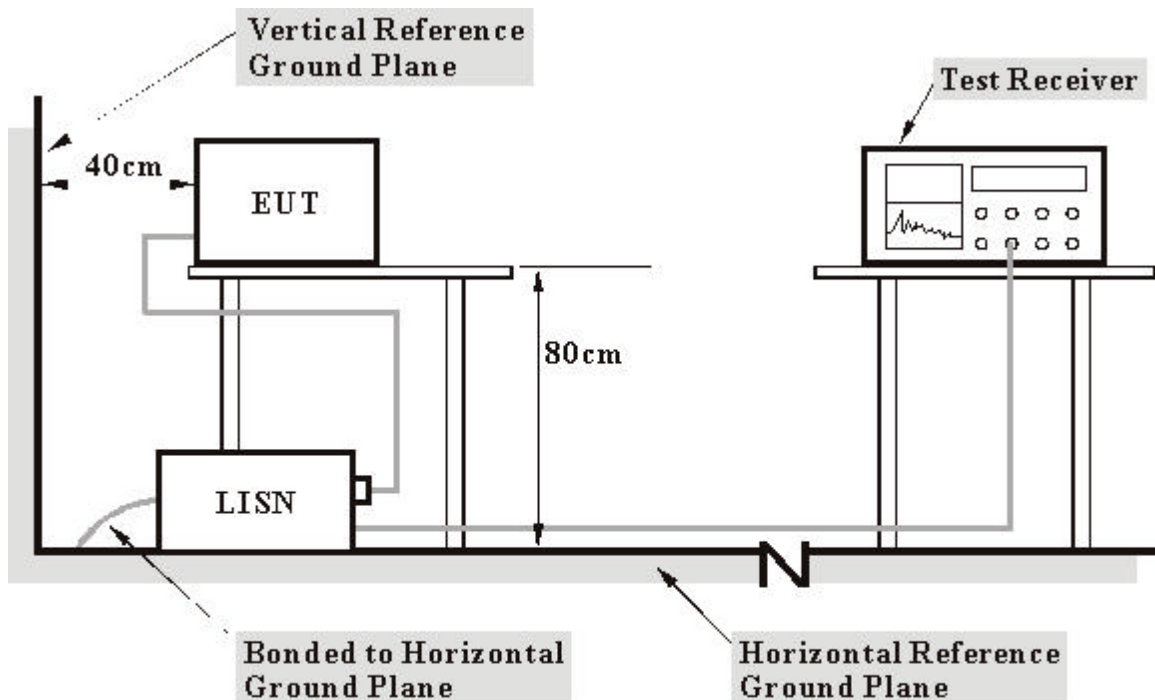

- Note:**
1. Support units were connected to second LISN.
  2. Both of LISNs (AMN) 80 cm from EUT and at the least 80 cm from other units and other metal planes support units.

For the actual test configuration, please refer to the related item – Photographs of the Test Configuration.

#### 4.1.6 EUT OPERATING CONDITIONS

- a. Placed the EUT on the testing table.
- b. Prepared another Notebook system to act as a communication partner and placed it outside of testing area.
- c. The communication partner run a test program (provided by manufacturer) to enable EUT under transmission/receiving condition continuously at specific channel frequency via an RJ45 cable.
- d. The communication partner sent data to EUT by command "PING".



4.1.7 TEST RESULTS

<b>EUT</b>	Wireless AP VPN Router	<b>MODEL</b>	WRTD-117GW
<b>CHANNEL</b>	1	<b>6dB BANDWIDTH</b>	9 kHz
<b>INPUT POWER (SYSTEM)</b>	120 Vac, 60 Hz	<b>PHASE</b>	Line (L)
<b>ENVIRONMENTAL CONDITIONS</b>	24deg. C, 64% RH, 991 hPa	<b>TESTED BY</b>	Leo Hung

No	Freq. [MHz]	Corr. Factor (dB)	Reading Value		Emission Level		Limit		Margin	
			[dB (uV)]		[dB (uV)]		[dB (uV)]		(dB)	
			Q.P.	AV.	Q.P.	AV.	Q.P.	AV.	Q.P.	AV.
1	0.158	0.11	38.41	-	38.52	-	65.58	55.58	-27.06	-
2	0.326	0.12	43.24	-	43.36	-	59.56	49.56	-16.19	-
3	0.662	0.13	41.99	-	42.12	-	56.00	46.00	-13.88	-
4	1.305	0.15	45.25	-	45.40	-	56.00	46.00	-10.60	-
5	2.230	0.17	46.32	34.06	46.49	34.23	56.00	46.00	-9.51	-11.77
6	4.465	0.22	45.96	32.76	46.18	32.98	56.00	46.00	-9.82	-13.02

- REMARKS:**
1. Q.P. and AV. are abbreviations of quasi-peak and average individually.
  2. "-": The Quasi-peak reading value also meets average limit and measurement with the average detector is unnecessary.
  3. The emission levels of other frequencies were very low against the limit.
  4. Margin value = Emission level - Limit value
  5. Correction factor = Insertion loss + Cable loss
  6. Emission Level = Correction Factor + Reading Value.

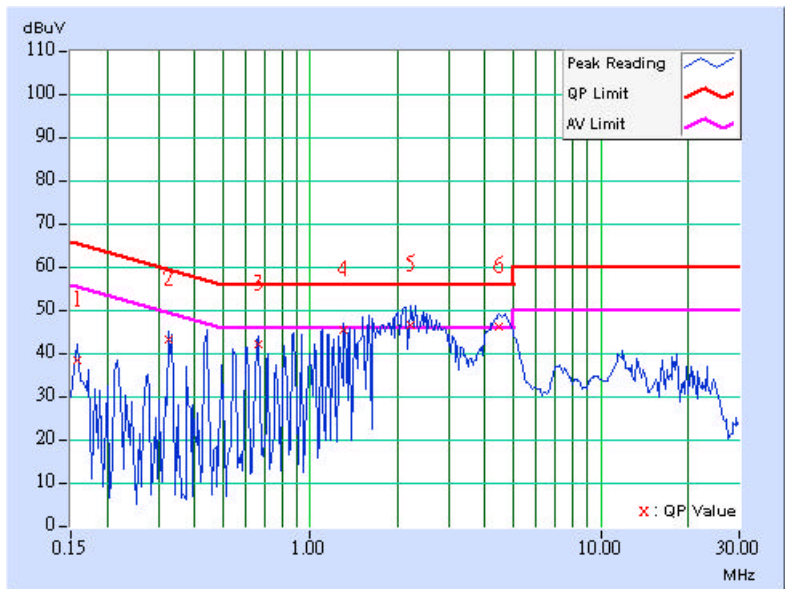



<b>EUT</b>	Wireless AP VPN Router	<b>MODEL</b>	WRTD-117GW
<b>CHANNEL</b>	1	<b>6dB BANDWIDTH</b>	9 kHz
<b>INPUT POWER (SYSTEM)</b>	120 Vac, 60 Hz	<b>PHASE</b>	Neutral (N)
<b>ENVIRONMENTAL CONDITIONS</b>	24deg. C, 64% RH, 991 hPa	<b>TESTED BY</b>	Leo Hung

No	Freq. [MHz]	Corr. Factor (dB)	Reading Value		Emission Level		Limit		Margin	
			[dB (uV)]		[dB (uV)]		[dB (uV)]		(dB)	
			Q.P.	AV.	Q.P.	AV.	Q.P.	AV.	Q.P.	AV.
1	0.166	0.10	41.29	-	41.39	-	65.18	55.18	-23.78	-
2	0.330	0.11	41.09	-	41.20	-	59.46	49.46	-18.25	-
3	0.662	0.12	40.47	-	40.59	-	56.00	46.00	-15.41	-
4	1.094	0.15	43.15	-	43.30	-	56.00	46.00	-12.70	-
<b>5</b>	<b>2.293</b>	<b>0.17</b>	<b>47.42</b>	<b>34.67</b>	<b>47.59</b>	<b>34.84</b>	<b>56.00</b>	<b>46.00</b>	<b>-8.41</b>	<b>-11.16</b>
6	4.531	0.21	43.97	-	44.18	-	56.00	46.00	-11.82	-

- REMARKS:**
1. Q.P. and AV. are abbreviations of quasi-peak and average individually.
  2. "-": The Quasi-peak reading value also meets average limit and measurement with the average detector is unnecessary.
  3. The emission levels of other frequencies were very low against the limit.
  4. Margin value = Emission level - Limit value
  5. Correction factor = Insertion loss + Cable loss
  6. Emission Level = Correction Factor + Reading Value.

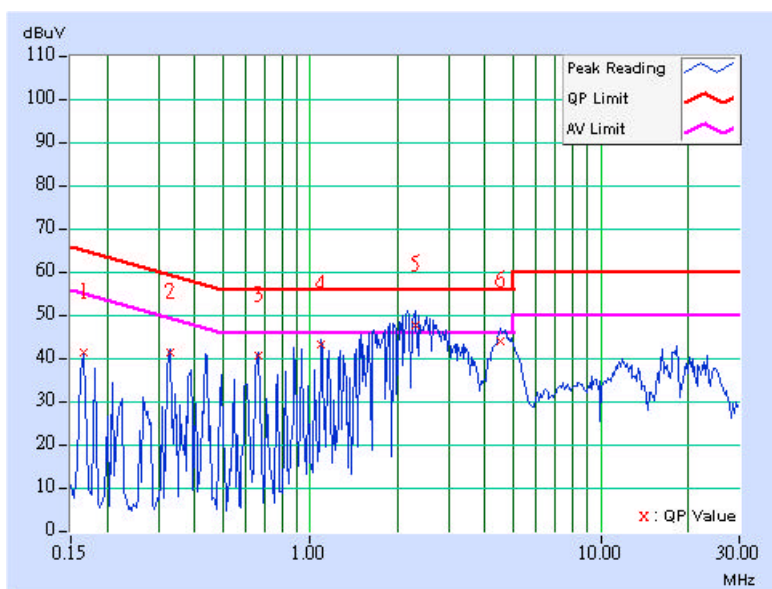



<b>EUT</b>	Wireless AP VPN Router	<b>MODEL</b>	WRTD-117GW
<b>CHANNEL</b>	6	<b>6dB BANDWIDTH</b>	9 kHz
<b>INPUT POWER (SYSTEM)</b>	120 Vac, 60 Hz	<b>PHASE</b>	Line (L)
<b>ENVIRONMENTAL CONDITIONS</b>	24deg. C, 64% RH, 991 hPa	<b>TESTED BY</b>	Leo Hung

No	Freq. [MHz]	Corr. Factor (dB)	Reading Value		Emission Level		Limit		Margin	
			[dB (uV)]		[dB (uV)]		[dB (uV)]		(dB)	
			Q.P.	AV.	Q.P.	AV.	Q.P.	AV.	Q.P.	AV.
1	0.173	0.11	34.89	-	35.00	-	64.79	54.79	-29.79	-
2	0.334	0.12	42.46	-	42.58	-	59.36	49.36	-16.78	-
3	0.443	0.13	43.54	-	43.67	-	57.01	47.01	-13.34	-
4	2.230	0.17	46.50	27.25	46.67	27.42	56.00	46.00	-9.33	-18.58
5	4.676	0.22	45.47	-	45.69	-	56.00	46.00	-10.31	-
6	18.246	0.94	37.84	-	38.78	-	60.00	50.00	-21.22	-

- REMARKS:**
1. Q.P. and AV. are abbreviations of quasi-peak and average individually.
  2. "-": The Quasi-peak reading value also meets average limit and measurement with the average detector is unnecessary.
  3. The emission levels of other frequencies were very low against the limit.
  4. Margin value = Emission level - Limit value
  5. Correction factor = Insertion loss + Cable loss
  6. Emission Level = Correction Factor + Reading Value.

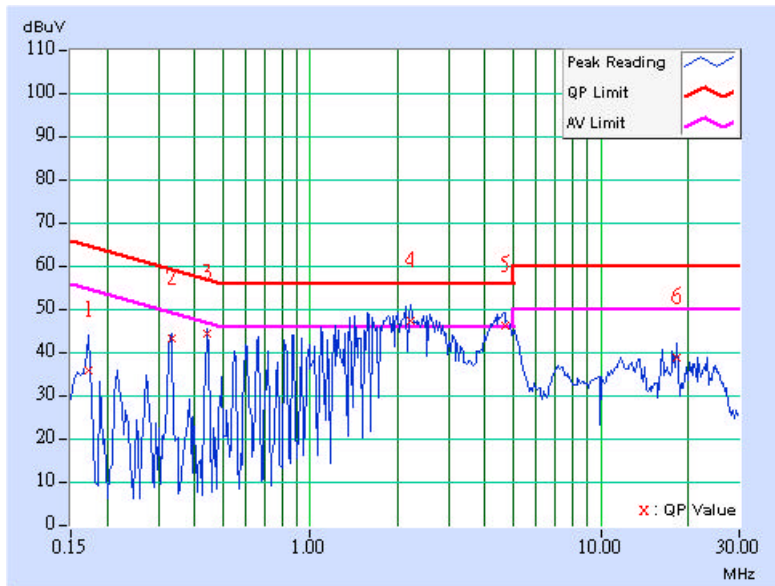



<b>EUT</b>	Wireless AP VPN Router	<b>MODEL</b>	WRTD-117GW
<b>CHANNEL</b>	6	<b>6dB BANDWIDTH</b>	9 kHz
<b>INPUT POWER (SYSTEM)</b>	120 Vac, 60 Hz	<b>PHASE</b>	Neutral (N)
<b>ENVIRONMENTAL CONDITIONS</b>	24deg. C, 64% RH, 991 hPa	<b>TESTED BY</b>	Leo Hung

No	Freq. [MHz]	Corr. Factor (dB)	Reading Value [dB (uV)]		Emission Level [dB (uV)]		Limit [dB (uV)]		Margin (dB)	
			Q.P.	AV.	Q.P.	AV.	Q.P.	AV.	Q.P.	AV.
			1	0.330	0.11	41.09	-	41.20	-	59.46
2	0.662	0.12	40.43	-	40.55	-	56.00	46.00	-15.45	-
3	1.371	0.15	45.34	-	45.49	-	56.00	46.00	-10.51	-
4	2.145	0.16	46.36	34.34	46.52	34.50	56.00	46.00	-9.48	-11.50
5	4.605	0.21	43.08	-	43.29	-	56.00	46.00	-12.71	-
6	18.242	0.69	39.92	-	40.61	-	60.00	50.00	-19.39	-

- REMARKS:**
1. Q.P. and AV. are abbreviations of quasi-peak and average individually.
  2. "-": The Quasi-peak reading value also meets average limit and measurement with the average detector is unnecessary.
  3. The emission levels of other frequencies were very low against the limit.
  4. Margin value = Emission level - Limit value
  5. Correction factor = Insertion loss + Cable loss
  6. Emission Level = Correction Factor + Reading Value.

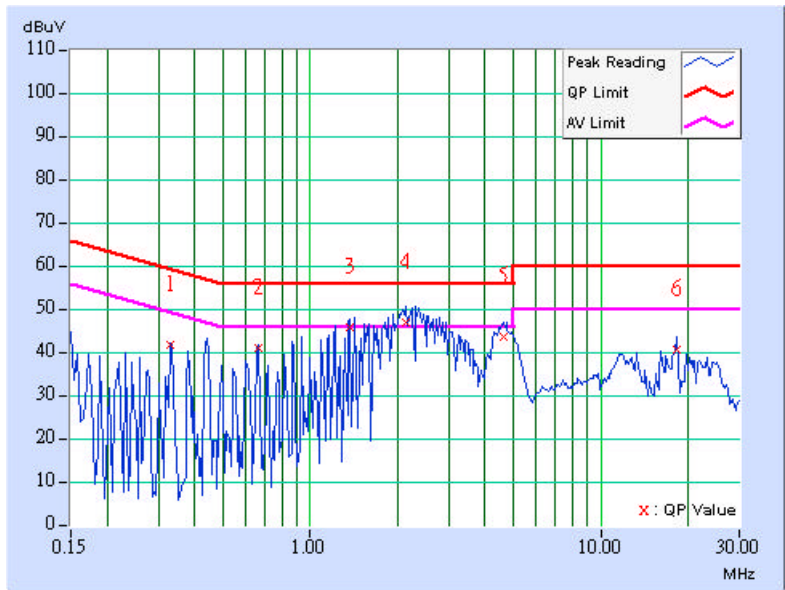



<b>EUT</b>	Wireless AP VPN Router	<b>MODEL</b>	WRTD-117GW
<b>CHANNEL</b>	11	<b>6dB BANDWIDTH</b>	9 kHz
<b>INPUT POWER (SYSTEM)</b>	120 Vac, 60 Hz	<b>PHASE</b>	Line (L)
<b>ENVIRONMENTAL CONDITIONS</b>	24deg. C, 64% RH, 991 hPa	<b>TESTED BY</b>	Leo Hung

No	Freq. [MHz]	Corr. Factor (dB)	Reading Value [dB (uV)]		Emission Level [dB (uV)]		Limit [dB (uV)]		Margin (dB)	
			Q.P.	AV.	Q.P.	AV.	Q.P.	AV.	Q.P.	AV.
			1	0.177	0.11	34.69	-	34.80	-	64.61
2	0.326	0.12	42.68	-	42.80	-	59.56	49.56	-16.75	-
3	1.090	0.15	43.96	-	44.11	-	56.00	46.00	-11.89	-
4	2.285	0.17	46.03	25.46	46.20	25.63	56.00	46.00	-9.80	-20.37
5	4.391	0.22	44.77	-	44.99	-	56.00	46.00	-11.01	-
6	18.242	0.94	38.93	-	39.87	-	60.00	50.00	-20.13	-

- REMARKS:**
1. Q.P. and AV. are abbreviations of quasi-peak and average individually.
  2. "-": The Quasi-peak reading value also meets average limit and measurement with the average detector is unnecessary.
  3. The emission levels of other frequencies were very low against the limit.
  4. Margin value = Emission level - Limit value
  5. Correction factor = Insertion loss + Cable loss
  6. Emission Level = Correction Factor + Reading Value.

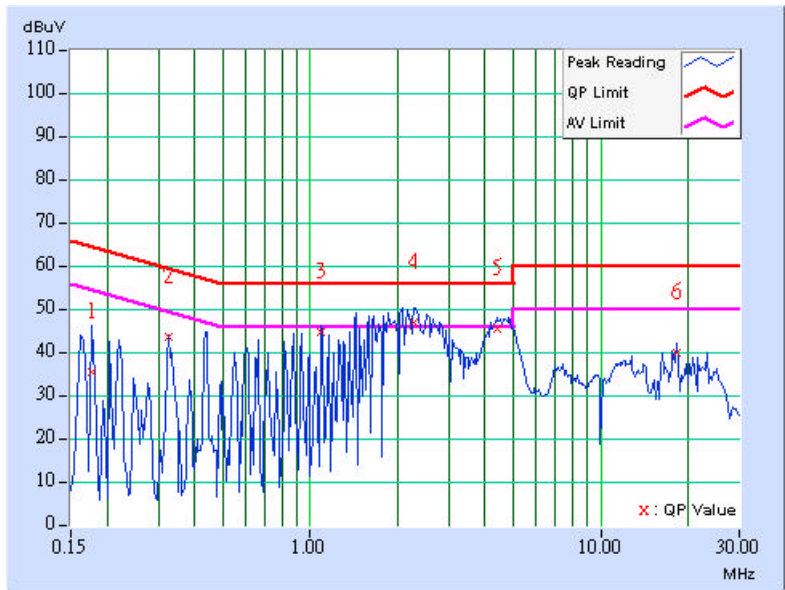





<b>EUT</b>	Wireless AP VPN Router	<b>MODEL</b>	WRTD-117GW
<b>CHANNEL</b>	11	<b>6dB BANDWIDTH</b>	9 kHz
<b>INPUT POWER (SYSTEM)</b>	120 Vac, 60 Hz	<b>PHASE</b>	Netural (N)
<b>ENVIRONMENTAL CONDITIONS</b>	24deg. C, 64% RH, 991 hPa	<b>TESTED BY</b>	Leo Hung

No	Freq. [MHz]	Corr. Factor (dB)	Reading Value [dB (uV)]		Emission Level [dB (uV)]		Limit [dB (uV)]		Margin (dB)	
			Q.P.	AV.	Q.P.	AV.	Q.P.	AV.	Q.P.	AV.
1	0.173	0.10	36.56	-	36.66	-	64.79	54.79	-28.13	-
2	0.330	0.11	40.51	-	40.62	-	59.46	49.46	-18.83	-
3	0.939	0.14	41.58	-	41.72	-	56.00	46.00	-14.28	-
4	2.305	0.17	45.19	-	45.36	-	56.00	46.00	-10.64	-
5	4.523	0.21	42.90	-	43.11	-	56.00	46.00	-12.89	-
6	17.695	0.68	39.12	-	39.80	-	60.00	50.00	-20.20	-

- REMARKS:**
1. Q.P. and AV. are abbreviations of quasi-peak and average individually.
  2. "-": The Quasi-peak reading value also meets average limit and measurement with the average detector is unnecessary.
  3. The emission levels of other frequencies were very low against the limit.
  4. Margin value = Emission level - Limit value
  5. Correction factor = Insertion loss + Cable loss
  6. Emission Level = Correction Factor + Reading Value.

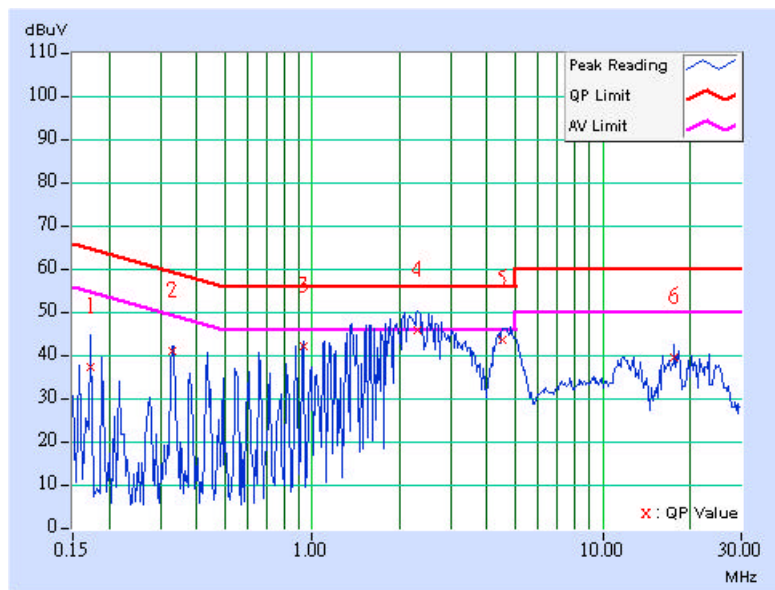



## 4.2 RADIATED EMISSION MEASUREMENT

### 4.2.1 LIMITS OF RADIATED EMISSION MEASUREMENT

Emissions radiated outside of the specified bands, shall be according to the general radiated limits in 15.209 as following:

Frequencies (MHz)	Field strength (microvolts/meter)	Measurement distance (meters)
0.009-0.490	2400/F(kHz)	300
0.490-1.705	24000/F(kHz)	30
1.705-30.0	30	30
30-88	100	3
88-216	150	3
216-960	200	3
Above 960	500	3

#### NOTE:

1. The lower limit shall apply at the transition frequencies.
2. Emission level (dBuV/m) = 20 log Emission level (uV/m).
3. As shown in 15.35(b), for frequencies above 1000MHz, the field strength limits are based on average detector, however, the peak field strength of any emission shall not exceed the maximum permitted average limits, specified above by more than 20dB under any condition of modulation.



## 4.2.2 TEST INSTRUMENTS

DESCRIPTION & MANUFACTURER	MODEL NO.	SERIAL NO.	CALIBRATED UNTIL
Test Receiver ROHDE & SCHWARZ	ESI7	100033	Jun, 08, 2005
Spectrum Analyzer ROHDE & SCHWARZ	FSP40	100040	Jun. 03, 2005
BILOG Antenna SCHWARZBECK	VULB9168	9168-153	Feb. 03, 2005
HORN Antenna SCHWARZBECK	9120D	9120D-408	Feb. 03, 2005
HORN Antenna SCHWARZBECK	BBHA 9170	BBHA 9170243	Feb. 23, 2005
Preamplifier Agilent	8447D	2944A10634	Jan. 14, 2005
Preamplifier Agilent	8449B	3008A01911	Sep. 21, 2005
RF signal cable HUBER+SUHNNER	SUCOFLEX 104	218183/4	Mar. 05, 2005
RF signal cable HUBER+SUHNNER	SUCOFLEX 104	218195/4	Mar. 05, 2005
Software ADT.	ADT_Radiated_V5.14	NA	NA
Antenna Tower inn-co GmbH	MA 4000	013303	NA
Antenna Tower Controller inn-co GmbH	CO2000	017303	NA
Turn Table ADT.	TT100.	TT93021703	NA
Turn Table Controller ADT.	SC100.	SC93021703	NA

- NOTE:**
1. The calibration interval of the above test instruments is 12 months and the calibrations are traceable to NML/ROC and NIST/USA.
  2. The test was performed in HwaYa Chamber 2.
  3. The horn antenna and HP preamplifier (model: 8449B) are used only for the measurement of emission frequency above 1GHz if tested.
  4. The IC Site Registration No. is IC4924-3.



#### 4.2.3 TEST PROCEDURES

- a. The EUT was placed on the top of a rotating table 0.8 meters above the ground at a 3 meter semi-anechoic chamber. The table was rotated 360 degrees to determine the position of the highest radiation.
- b. The EUT was set 3 meters away from the interference-receiving antenna, which was mounted on the top of a variable-height antenna tower.
- c. The antenna is a broadband antenna, and its height is varied from one meter to four meters above the ground to determine the maximum value of the field strength. Both horizontal and vertical polarizations of the antenna are set to make the measurement.
- d. For each suspected emission, the EUT was arranged to its worst case and then the antenna was tuned to heights from 1 meter to 4 meters and the rotatable table was turned from 0 degrees to 360 degrees to find the maximum reading.
- e. The test-receiver system was set to Peak Detect Function and Specified Bandwidth with Maximum Hold Mode.
- f. If the emission level of the EUT in peak mode was 10 dB lower than the limit specified, then testing could be stopped and the peak values of the EUT would be reported. Otherwise the emissions that did not have 10 dB margin would be re-tested one by one using peak, quasi-peak or average method as specified and then reported in a data sheet.

**NOTE:**

1. The resolution bandwidth and video bandwidth of test receiver/spectrum analyzer is 120kHz for Peak detection (PK) and Quasi-peak detection (QP) at frequency below 1GHz.
2. The resolution bandwidth and video bandwidth of test receiver/spectrum analyzer is 1 MHz for Peak detection at frequency above 1GHz.
3. The resolution bandwidth of test receiver/spectrum analyzer is 1 MHz and the video bandwidth is 10 Hz for Average detection (AV) at frequency above 1GHz.

#### 4.2.4 DEVIATION FROM TEST STANDARD

No deviation

#### 4.2.5 TEST SETUP

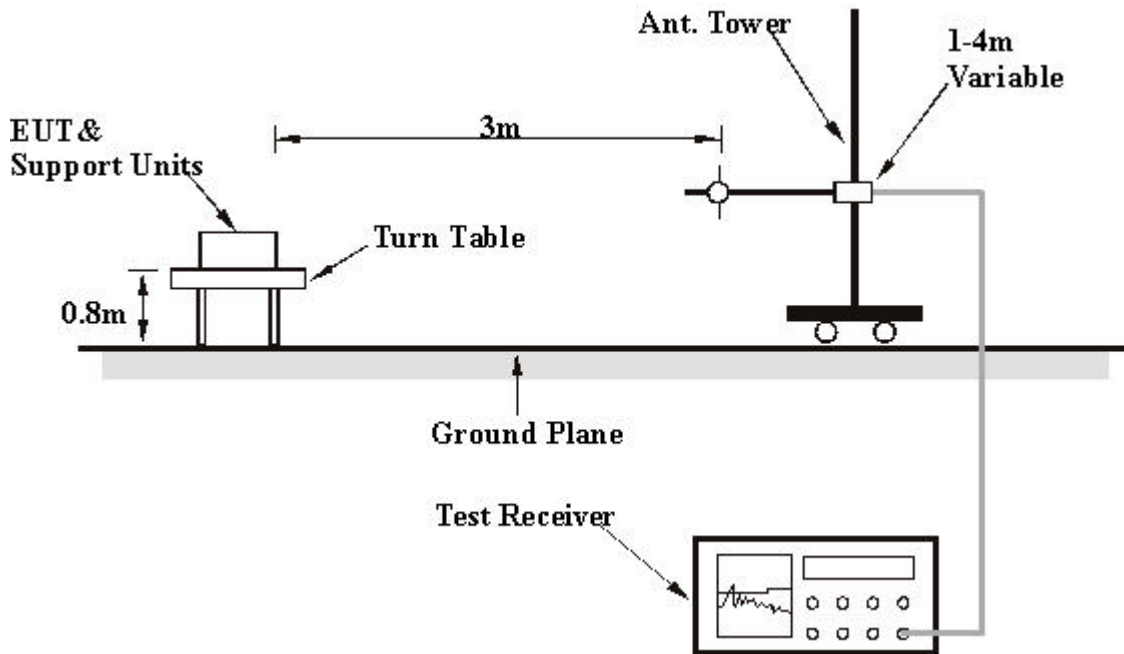

For the actual test configuration, please refer to the related item – Photographs of the Test Configuration.

#### 4.2.6 EUT OPERATING CONDITIONS

Same as 4.1.6

## 4.2.7 TEST RESULTS

<b>EUT</b>	Wireless AP VPN Router	<b>MODEL</b>	WRTD-117GW
<b>CHANNEL</b>	11	<b>FREQUENCY RANGE</b>	Below 1000 MHz
<b>INPUT POWER (SYSTEM)</b>	120 Vac, 60Hz	<b>DETECTOR FUNCTION</b>	Quasi-Peak
<b>ENVIRONMENTAL CONDITIONS</b>	25 deg. C, 65% RH, 991 hPa	<b>TESTED BY</b>	Rush Kao

ANTENNA POLARITY & TEST DISTANCE: HORIZONTAL AT 3 M								
No.	Freq. (MHz)	Emission Level (dBuV/m)	Limit (dBuV/m)	Margin (dB)	Antenna Height (m)	Table Angle (Degree)	Raw Value (dBuV)	Correction Factor (dB/m)
1	173.85	36.82 QP	43.50	-6.68	1.50 H	208	23.29	13.53
2	232.16	37.75 QP	46.00	-8.25	1.50 H	280	25.28	12.48
3	249.66	39.93 QP	46.00	-6.07	1.00 H	37	26.82	13.11
4	374.07	35.94 QP	46.00	-10.06	2.50 H	10	19.83	16.10
5	500.42	42.68 QP	46.00	-3.32	2.00 H	247	24.11	18.58
6	549.02	40.35 QP	46.00	-5.65	1.50 H	10	20.90	19.44
7	574.29	34.83 QP	46.00	-11.17	1.50 H	31	14.71	20.13
8	696.75	34.72 QP	46.00	-11.28	1.00 H	52	12.75	21.97
9	770.62	41.79 QP	46.00	-4.21	1.00 H	274	18.45	23.33

- REMARKS:**
1. Emission level(dBuV/m)=Raw Value(dBuV) + Correction Factor(dB/m)
  2. Correction Factor(dB/m) = Antenna Factor (dB/m) + Cable Factor (dB)
  3. The other emission levels were very low against the limit.
  4. Margin value = Emission level – Limit value.



<b>EUT</b>	Wireless AP VPN Router	<b>MODEL</b>	WRTD-117GW
<b>CHANNEL</b>	11	<b>FREQUENCY RANGE</b>	Below 1000 MHz
<b>INPUT POWER (SYSTEM)</b>	120 Vac, 60Hz	<b>DETECTOR FUNCTION</b>	Quasi-Peak
<b>ENVIRONMENTAL CONDITIONS</b>	25 deg. C, 65% RH, 991 hPa	<b>TESTED BY</b>	Rush Kao

#### ANTENNA POLARITY & TEST DISTANCE: VERTICAL AT 3 M

No.	Freq. (MHz)	Emission Level (dBuV/m)	Limit (dBuV/m)	Margin (dB)	Antenna Height (m)	Table Angle (Degree)	Raw Value (dBuV)	Correction Factor (dB/m)
1	47.80	36.20 QP	40.00	-3.80	1.00 V	56	21.24	14.96
2	103.87	41.28 QP	43.50	-2.22	1.50 V	103	30.00	11.29
3	173.85	41.39 QP	43.50	-2.11	1.00 V	175	27.87	13.53
4	249.66	39.39 QP	46.00	-6.61	1.00 V	259	26.29	13.11
5	374.07	36.79 QP	46.00	-9.21	1.25 V	328	20.69	16.10
6	399.34	37.02 QP	46.00	-8.98	1.25 V	322	20.31	16.71
7	500.42	41.38 QP	46.00	-4.62	1.50 V	247	22.81	18.58
<b>8</b>	<b>556.79</b>	<b>44.27 QP</b>	<b>46.00</b>	<b>-1.73</b>	<b>1.00 V</b>	<b>268</b>	<b>24.62</b>	<b>19.65</b>
9	778.40	40.65 QP	46.00	-5.35	1.25 V	82	17.28	23.36

- REMARKS:**
1. Emission level(dBuV/m)=Raw Value(dBuV) + Correction Factor(dB/m)
  2. Correction Factor(dB/m) = Antenna Factor (dB/m) + Cable Factor (dB)
  3. The other emission levels were very low against the limit.
  4. Margin value = Emission level – Limit value.



## 4.2.8 TEST RESULTS (A)

<b>EUT</b>	Wireless AP VPN Router	<b>MODEL</b>	WRTD-117GW
<b>CHANNEL</b>	1	<b>FREQUENCY RANGE</b>	1~25 GHz
<b>INPUT POWER (SYSTEM)</b>	120 Vac, 60 Hz	<b>DETECTOR FUNCTION</b>	Peak (PK) Average (AV)
<b>ENVIRONMENTAL CONDITIONS</b>	23deg. C, 64% RH, 991 hPa	<b>TESTED BY</b>	Long Chen

**ANTENNA POLARITY & TEST DISTANCE: HORIZONTAL AT 3 M**

No.	Freq. (MHz)	Emission Level (dBuV/m)	Limit (dBuV/m)	Margin (dB)	Antenna Height (m)	Table Angle (Degree)	Raw Value (dBuV)	Correction Factor (dB/m)
1	1500.00	47.80 PK	74.00	-26.20	1.20 H	246	18.60	29.20
2	2374.60	42.94 PK	74.00	-31.06	1.36 H	87	11.37	31.57
3	*2412.00	103.44 PK			1.36 H	87	71.74	31.70
3	*2412.00	95.47 AV			1.36 H	87	63.77	31.70
4	4824.00	49.53 PK	74.00	-24.47	1.03 H	164	11.95	37.58
5	9648.00	56.33 PK	74.00	-17.67	1.16 H	304	7.96	48.37
5	9648.00	45.21 AV	54.00	-8.79	1.16 H	304	-3.16	48.37

**ANTENNA POLARITY & TEST DISTANCE: VERTICAL AT 3 M**

No.	Freq. (MHz)	Emission Level (dBuV/m)	Limit (dBuV/m)	Margin (dB)	Antenna Height (m)	Table Angle (Degree)	Raw Value (dBuV)	Correction Factor (dB/m)
1	1500.00	43.60 PK	74.00	-30.40	1.08 V	31	14.40	29.20
2	2374.60	52.82 PK	74.00	-21.18	1.00 V	333	21.25	31.57
2	2374.60	44.79 AV	54.00	-9.21	1.00 V	333	13.22	31.57
3	*2412.00	113.32 PK			1.00 V	333	81.62	31.70
3	*2412.00	105.29 AV			1.00 V	333	73.59	31.70
4	4824.00	52.57 PK	74.00	-21.43	1.08 V	335	14.99	37.58
4	4824.00	42.47 AV	54.00	-11.53	1.08 V	335	4.89	37.58
5	9648.00	58.79 PK	74.00	-15.21	1.02 V	5	10.42	48.37
5	9648.00	47.80 AV	54.00	-6.20	1.02 V	5	-0.57	48.37

- REMARKS:**
1. Emission level(dBuV/m)=Raw Value(dBuV) + Correction Factor(dB/m)
  2. Correction Factor(dB/m) = Antenna Factor (dB/m) + Cable Factor (dB)
  3. The other emission levels were very low against the limit.
  4. Margin value = Emission level – Limit value.
  5. “ \* ” : Fundamental frequency.





<b>EUT</b>	Wireless AP VPN Router	<b>MODEL</b>	WRTD-117GW
<b>CHANNEL</b>	6	<b>FREQUENCY RANGE</b>	1~25 GHz
<b>INPUT POWER (SYSTEM)</b>	120 Vac, 60 Hz	<b>DETECTOR FUNCTION</b>	Peak(PK) Average (AV)
<b>ENVIRONMENTAL CONDITIONS</b>	23deg. C, 64% RH, 991 hPa	<b>TESTED BY</b>	Long Chen

**ANTENNA POLARITY & TEST DISTANCE: HORIZONTAL AT 3 M**

No.	Freq. (MHz)	Emission Level (dBuV/m)	Limit (dBuV/m)	Margin (dB)	Antenna Height (m)	Table Angle (Degree)	Raw Value (dBuV)	Correction Factor (dB/m)
1	1500.00	47.32 PK	74.00	-26.68	1.03 H	159	18.12	29.20
2	*2437.00	102.36 PK			1.34 H	85	70.51	31.85
2	*2437.00	94.69 AV			1.34 H	85	62.84	31.85
3	4874.00	50.21 PK	74.00	-23.79	1.00 H	317	12.55	37.66
3	4874.00	41.18 AV	54.00	-12.82	1.00 H	317	3.52	37.66
4	9748.00	58.03 PK	74.00	-15.97	1.00 H	298	9.59	48.44
4	9748.00	45.90 AV	54.00	-8.10	1.00 H	298	-2.54	48.44

**ANTENNA POLARITY & TEST DISTANCE: VERTICAL AT 3 M**

No.	Freq. (MHz)	Emission Level (dBuV/m)	Limit (dBuV/m)	Margin (dB)	Antenna Height (m)	Table Angle (Degree)	Raw Value (dBuV)	Correction Factor (dB/m)
1	1500.00	43.58 PK	74.00	-30.42	1.00 V	338	14.38	29.20
2	*2437.00	112.66 PK			1.18 V	2	80.81	31.85
2	*2437.00	104.54 AV			1.18 V	2	72.69	31.85
3	4874.00	53.65 PK	74.00	-20.35	1.10 V	14	15.99	37.66
3	4874.00	44.37 AV	54.00	-9.63	1.10 V	14	6.71	37.66
4	9748.00	59.20 PK	74.00	-14.80	1.13 V	12	10.76	48.44
4	9748.00	49.84 AV	54.00	-4.16	1.13 V	12	1.40	48.44

- REMARKS:**
1. Emission level(dBuV/m)=Raw Value(dBuV) + Correction Factor(dB/m)
  2. Correction Factor(dB/m) = Antenna Factor (dB/m) + Cable Factor (dB)
  3. The other emission levels were very low against the limit.
  4. Margin value = Emission level – Limit value.
  5. “ \* “ : Fundamental frequency.



<b>EUT</b>	Wireless AP VPN Router	<b>MODEL</b>	WRTD-117GW
<b>CHANNEL</b>	11	<b>FREQUENCY RANGE</b>	1~25 GHz
<b>INPUT POWER (SYSTEM)</b>	120 Vac, 60 Hz	<b>DETECTOR FUNCTION</b>	Peak(PK) Average (AV)
<b>ENVIRONMENTAL CONDITIONS</b>	23deg. C, 64% RH, 991 hPa	<b>TESTED BY</b>	Long Chen

#### ANTENNA POLARITY & TEST DISTANCE: HORIZONTAL AT 3 M

No.	Freq. (MHz)	Emission Level (dBuV/m)	Limit (dBuV/m)	Margin (dB)	Antenna Height (m)	Table Angle (Degree)	Raw Value (dBuV)	Correction Factor (dB/m)
1	1500.00	48.01 PK	74.00	-25.99	1.03 H	195	18.81	29.20
2	*2462.00	101.46 PK			1.37 H	100	69.46	32.00
2	*2462.00	93.62 AV			1.37 H	100	61.62	32.00
3	2489.50	41.94 PK	74.00	-32.06	1.37 H	100	9.77	32.17
4	4924.00	48.69 PK	74.00	-25.31	1.36 H	334	10.95	37.74
5	9848.00	56.89 PK	74.00	-17.11	1.14 H	224	8.23	48.66
5	9848.00	42.61 AV	54.00	-11.39	1.14 H	224	-6.05	48.66

#### ANTENNA POLARITY & TEST DISTANCE: VERTICAL AT 3 M

No.	Freq. (MHz)	Emission Level (dBuV/m)	Limit (dBuV/m)	Margin (dB)	Antenna Height (m)	Table Angle (Degree)	Raw Value (dBuV)	Correction Factor (dB/m)
1	1500.00	45.16 PK	74.00	-28.84	1.00 V	306	15.96	29.20
2	*2462.00	114.00 PK			1.00 V	327	82.00	32.00
2	*2462.00	106.00 AV			1.00 V	327	74.00	32.00
3	2489.50	54.48 PK	74.00	-19.52	1.00 V	327	22.31	32.17
3	2489.50	46.48 AV	54.00	-7.52	1.00 V	327	14.31	32.17
4	4924.00	53.62 PK	74.00	-20.38	1.00 V	346	15.88	37.74
4	4924.00	44.87 AV	54.00	-9.13	1.00 V	346	7.13	37.74
5	9848.00	61.20 PK	74.00	-12.80	1.00 V	307	12.54	48.66
5	9848.00	50.98 AV	54.00	-3.02	1.00 V	307	2.32	48.66

- REMARKS:**
1. Emission level(dBuV/m)=Raw Value(dBuV) + Correction Factor(dB/m)
  2. Correction Factor(dB/m) = Antenna Factor (dB/m) + Cable Factor (dB)
  3. The other emission levels were very low against the limit.
  4. Margin value = Emission level – Limit value.
  5. “ \* “ : Fundamental frequency.



## 4.2.9 TEST RESULTS (B)

<b>EUT</b>	Wireless AP VPN Router	<b>MODEL</b>	WRTD-117GW
<b>CHANNEL</b>	1	<b>FREQUENCY RANGE</b>	1~25 GHz
<b>INPUT POWER (SYSTEM)</b>	120 Vac, 60 Hz	<b>DETECTOR FUNCTION</b>	Peak(PK) Average (AV)
<b>ENVIRONMENTAL CONDITIONS</b>	23deg. C, 64% RH, 991 hPa	<b>TESTED BY</b>	Long Chen

**ANTENNA POLARITY & TEST DISTANCE: HORIZONTAL AT 3 M**

No.	Freq. (MHz)	Emission Level (dBuV/m)	Limit (dBuV/m)	Margin (dB)	Antenna Height (m)	Table Angle (Degree)	Raw Value (dBuV)	Correction Factor (dB/m)
1	1500.00	46.39 PK	74.00	-27.61	1.10 H	31	17.19	29.20
2	2390.00	48.11 PK	74.00	-25.89	1.25 H	72	16.50	31.61
3	*2412.00	97.45 PK			1.25 H	72	65.75	31.70
3	*2412.00	88.02 AV			1.25 H	72	56.32	31.70
4	4824.00	51.69 PK	74.00	-22.31	1.05 H	326	14.11	37.58
4	4824.00	37.47 AV	54.00	-16.53	1.05 H	326	-0.11	37.58
5	9648.00	60.33 PK	74.00	-13.67	1.00 H	47	11.96	48.37
5	9648.00	47.68 AV	54.00	-6.32	1.00 H	47	-0.69	48.37

**ANTENNA POLARITY & TEST DISTANCE: VERTICAL AT 3 M**

No.	Freq. (MHz)	Emission Level (dBuV/m)	Limit (dBuV/m)	Margin (dB)	Antenna Height (m)	Table Angle (Degree)	Raw Value (dBuV)	Correction Factor (dB/m)
1	1500.00	44.21 PK	74.00	-29.79	1.13 V	339	15.01	29.20
2	2390.00	60.85 PK	74.00	-13.15	1.00 V	330	29.24	31.61
2	2390.00	51.21 AV	54.00	-2.79	1.00 V	330	19.60	31.61
3	*2412.00	110.19 PK			1.00 V	330	78.49	31.70
3	*2412.00	100.55 AV			1.00 V	330	68.85	31.70
4	4824.00	50.16 PK	74.00	-23.84	1.09 V	338	12.58	37.58
4	4824.00	43.12 AV	54.00	-10.88	1.09 V	338	5.54	37.58
5	9648.00	58.84 PK	74.00	-15.16	1.43 V	8	10.47	48.37
5	9648.00	47.53 AV	54.00	-6.47	1.43 V	8	-0.84	48.37

- REMARKS:**
1. Emission level(dBuV/m)=Raw Value(dBuV) + Correction Factor(dB/m)
  2. Correction Factor(dB/m) = Antenna Factor (dB/m) + Cable Factor (dB)
  3. The other emission levels were very low against the limit.
  4. Margin value = Emission level – Limit value.
  5. “ \* ” : Fundamental frequency.



<b>EUT</b>	Wireless AP VPN Router	<b>MODEL</b>	WRTD-117GW
<b>CHANNEL</b>	6	<b>FREQUENCY RANGE</b>	1~25 GHz
<b>INPUT POWER (SYSTEM)</b>	120 Vac, 60 Hz	<b>DETECTOR FUNCTION</b>	Peak(PK) Average (AV)
<b>ENVIRONMENTAL CONDITIONS</b>	23deg. C, 64% RH, 991 hPa	<b>TESTED BY</b>	Long Chen

**ANTENNA POLARITY & TEST DISTANCE: HORIZONTAL AT 3 M**

No.	Freq. (MHz)	Emission Level (dBuV/m)	Limit (dBuV/m)	Margin (dB)	Antenna Height (m)	Table Angle (Degree)	Raw Value (dBuV)	Correction Factor (dB/m)
1	1500.00	47.33 PK	74.00	-26.67	1.00 H	330	18.13	29.20
2	*2437.00	100.93 PK			1.36 H	85	69.08	31.85
2	*2437.00	91.75 AV			1.36 H	85	59.90	31.85
3	4874.00	48.10 PK	74.00	-25.90	1.09 H	306	10.44	37.66
4	9748.00	57.12 PK	74.00	-16.88	1.62 H	224	8.68	48.44
4	9748.00	48.31 AV	54.00	-5.69	1.62 H	224	-0.13	48.44

**ANTENNA POLARITY & TEST DISTANCE: VERTICAL AT 3 M**

No.	Freq. (MHz)	Emission Level (dBuV/m)	Limit (dBuV/m)	Margin (dB)	Antenna Height (m)	Table Angle (Degree)	Raw Value (dBuV)	Correction Factor (dB/m)
1	1500.00	44.95 PK	74.00	-29.05	1.00 V	12	15.75	29.20
2	*2437.00	111.47 PK			1.00 V	328	79.62	31.85
2	*2437.00	101.36 AV			1.00 V	328	69.51	31.85
3	4874.00	51.92 PK	74.00	-22.08	1.07 V	339	14.26	37.66
3	4874.00	42.82 AV	54.00	-11.18	1.07 V	339	5.16	37.66
4	9748.00	59.85 PK	74.00	-14.15	1.14 V	15	11.41	48.44
4	9748.00	50.16 AV	54.00	-3.84	1.14 V	15	1.72	48.44

- REMARKS:**
1. Emission level(dBuV/m)=Raw Value(dBuV) + Correction Factor(dB/m)
  2. Correction Factor(dB/m) = Antenna Factor (dB/m) + Cable Factor (dB)
  3. The other emission levels were very low against the limit.
  4. Margin value = Emission level – Limit value.
  5. “ \* “ : Fundamental frequency.



<b>EUT</b>	Wireless AP VPN Router	<b>MODEL</b>	WRTD-117GW
<b>CHANNEL</b>	11	<b>FREQUENCY RANGE</b>	1~25 GHz
<b>INPUT POWER (SYSTEM)</b>	120 Vac, 60 Hz	<b>DETECTOR FUNCTION</b>	Peak(PK) Average (AV)
<b>ENVIRONMENTAL CONDITIONS</b>	23deg. C, 64% RH, 991 hPa	<b>TESTED BY</b>	Long Chen

#### ANTENNA POLARITY & TEST DISTANCE: HORIZONTAL AT 3 M

No.	Freq. (MHz)	Emission Level (dBuV/m)	Limit (dBuV/m)	Margin (dB)	Antenna Height (m)	Table Angle (Degree)	Raw Value (dBuV)	Correction Factor (dB/m)
1	1500.00	44.28 PK	74.00	-29.72	1.00 H	36	15.08	29.20
2	*2462.00	95.76 PK			1.17 H	69	63.76	32.00
2	*2462.00	86.41 AV			1.17 H	69	54.41	32.00
3	2483.50	47.34 PK	74.00	-26.66	1.17 H	69	15.21	32.13
4	4924.00	49.07 PK	74.00	-24.93	1.00 H	319	11.33	37.74
5	9848.00	59.30 PK	74.00	-14.70	1.00 H	268	10.64	48.66
5	9848.00	46.11 AV	54.00	-7.89	1.00 H	268	-2.55	48.66

#### ANTENNA POLARITY & TEST DISTANCE: VERTICAL AT 3 M

No.	Freq. (MHz)	Emission Level (dBuV/m)	Limit (dBuV/m)	Margin (dB)	Antenna Height (m)	Table Angle (Degree)	Raw Value (dBuV)	Correction Factor (dB/m)
1	1500.00	43.89 PK	74.00	-30.11	1.00 V	332	14.69	29.20
2	*2462.00	110.35 PK			1.00 V	331	78.35	32.00
2	*2462.00	100.14 AV			1.00 V	331	68.14	32.00
3	2483.50	61.93 PK	74.00	-12.07	1.00 V	331	29.80	32.13
3	2483.50	51.72 AV	54.00	-2.28	1.00 V	331	19.59	32.13
4	4924.00	51.73 PK	74.00	-22.27	1.16 V	335	13.99	37.74
4	4924.00	40.43 AV	54.00	-13.57	1.16 V	335	2.69	37.74
5	9848.00	60.78 PK	74.00	-13.22	1.33 V	15	12.12	48.66
5	9848.00	50.84 AV	54.00	-3.16	1.33 V	15	2.18	48.66

- REMARKS:**
1. Emission level(dBuV/m)=Raw Value(dBuV) + Correction Factor(dB/m)
  2. Correction Factor(dB/m) = Antenna Factor (dB/m) + Cable Factor (dB)
  3. The other emission levels were very low against the limit.
  4. Margin value = Emission level – Limit value.
  5. “ \* “ : Fundamental frequency.



### 4.3 6dB BANDWIDTH MEASUREMENT

#### 4.3.1 LIMITS OF 6dB BANDWIDTH MEASUREMENT

The minimum of 6dB Bandwidth Measurement is 0.5 MHz.

#### 4.3.2 TEST INSTRUMENTS

Description & Manufacturer	Model No.	Serial No.	Calibrated Until
SPECTRUM ANALYZER	FSEK30	100049	Aug. 12, 2005

**NOTE:** The calibration interval of the above test instruments is 12 months and the calibrations are traceable to NML/ROC and NIST/USA.

#### 4.3.3 TEST PROCEDURE

The transmitter output was connected to the spectrum analyzer through an attenuator. The bandwidth of the fundamental frequency was measured by spectrum analyzer with 100 kHz RBW and 100kHz VBW. The 6dB bandwidth is defined as the total spectrum the power of which is higher than peak power minus 6dB.

#### 4.3.4 DEVIATION FROM TEST STANDARD

No deviation

#### 4.3.5 TEST SETUP

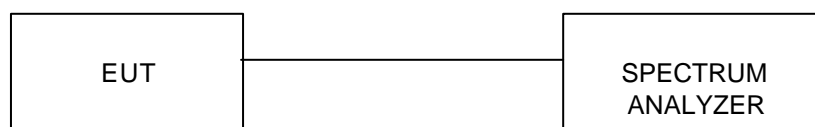

For the actual test configuration, please refer to the related Item – Photographs of the Test Configuration.

#### 4.3.6 EUT OPERATING CONDITIONS

The software provided by client to enable the EUT under transmission condition continuously at lowest, middle and highest channel frequencies individually.



4.3.7 TEST RESULTS (A)

<b>EUT</b>	Wireless AP VPN Router	<b>MODEL</b>	WRTD-117GW
<b>INPUT POWER (SYSTEM)</b>	120 Vac, 60 Hz	<b>ENVIRONMENTAL CONDITIONS</b>	24 deg. C, 65% RH, 991 hPa
<b>TESTED BY</b>	Leo Hung		

<b>CHANNEL</b>	<b>CHANNEL FREQUENCY (MHz)</b>	<b>6dB BANDWIDTH (MHz)</b>	<b>MINIMUM LIMIT (MHz)</b>	<b>PASS/FAIL</b>
1	2412	10.40	0.5	PASS
6	2437	9.92	0.5	PASS
11	2462	10.12	0.5	PASS





CH 1

\*RBW 100 kHz Delta 1 [T1] -0.45 dB  
 \*VBW 100 kHz  
 \*Att 20 dB  
 \*SWT 5 ms  
 Ref 10.4 dBm  
 10.40000000 MHz

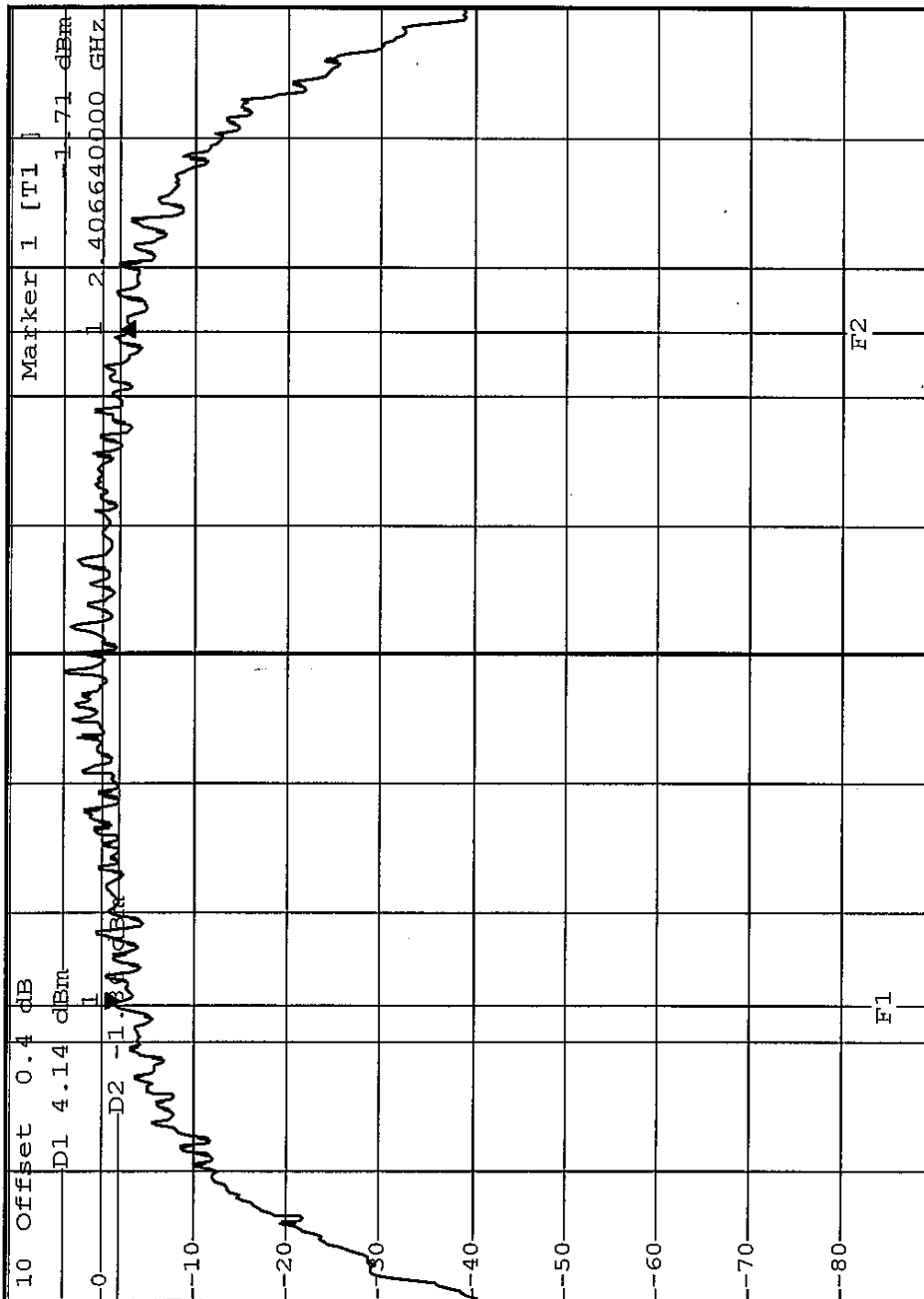

Center 2.412 GHz  
 2 MHz /  
 Span 20 MHz



1 PK  
 VIEW



CH 6

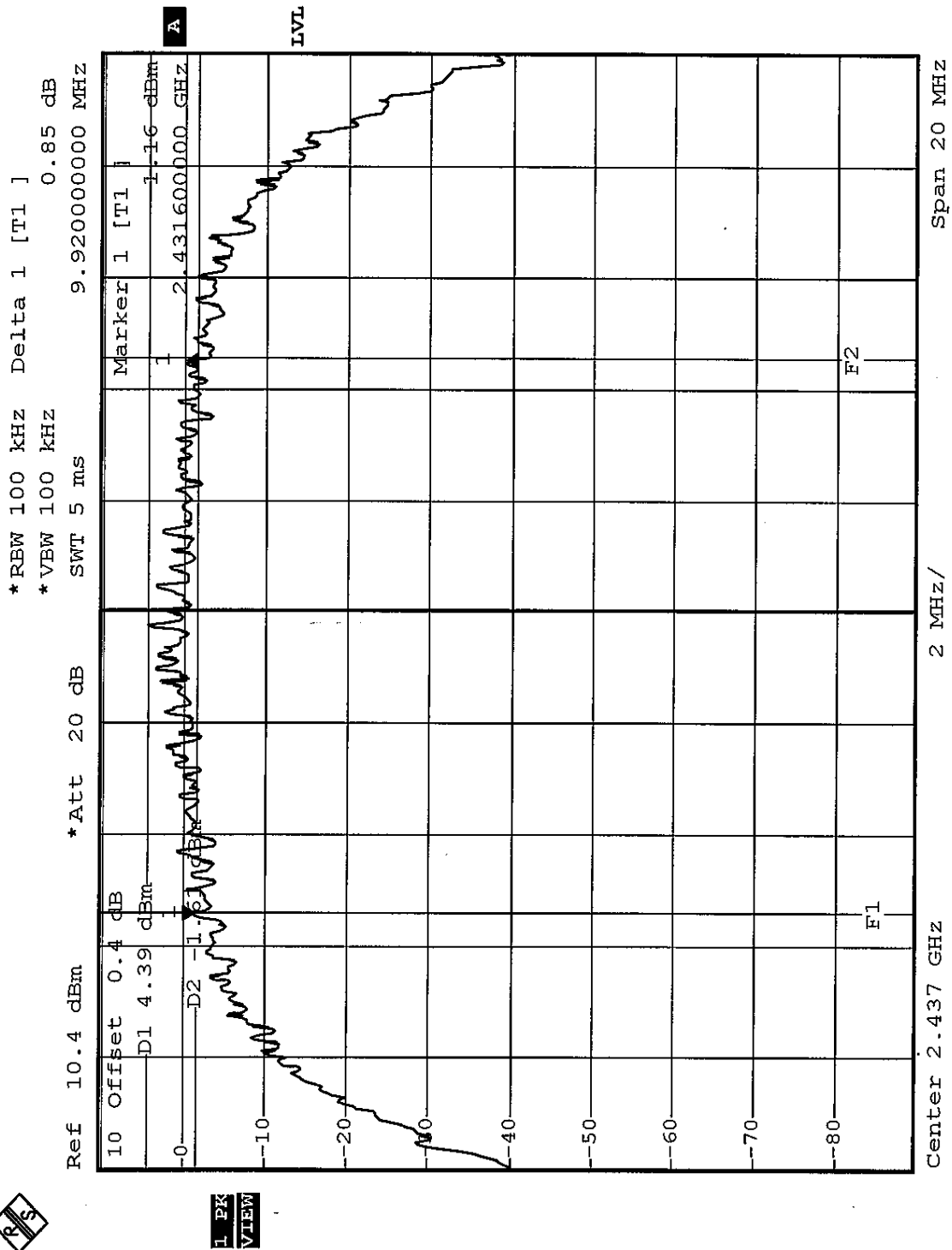

1 PK VIEW



CH 11

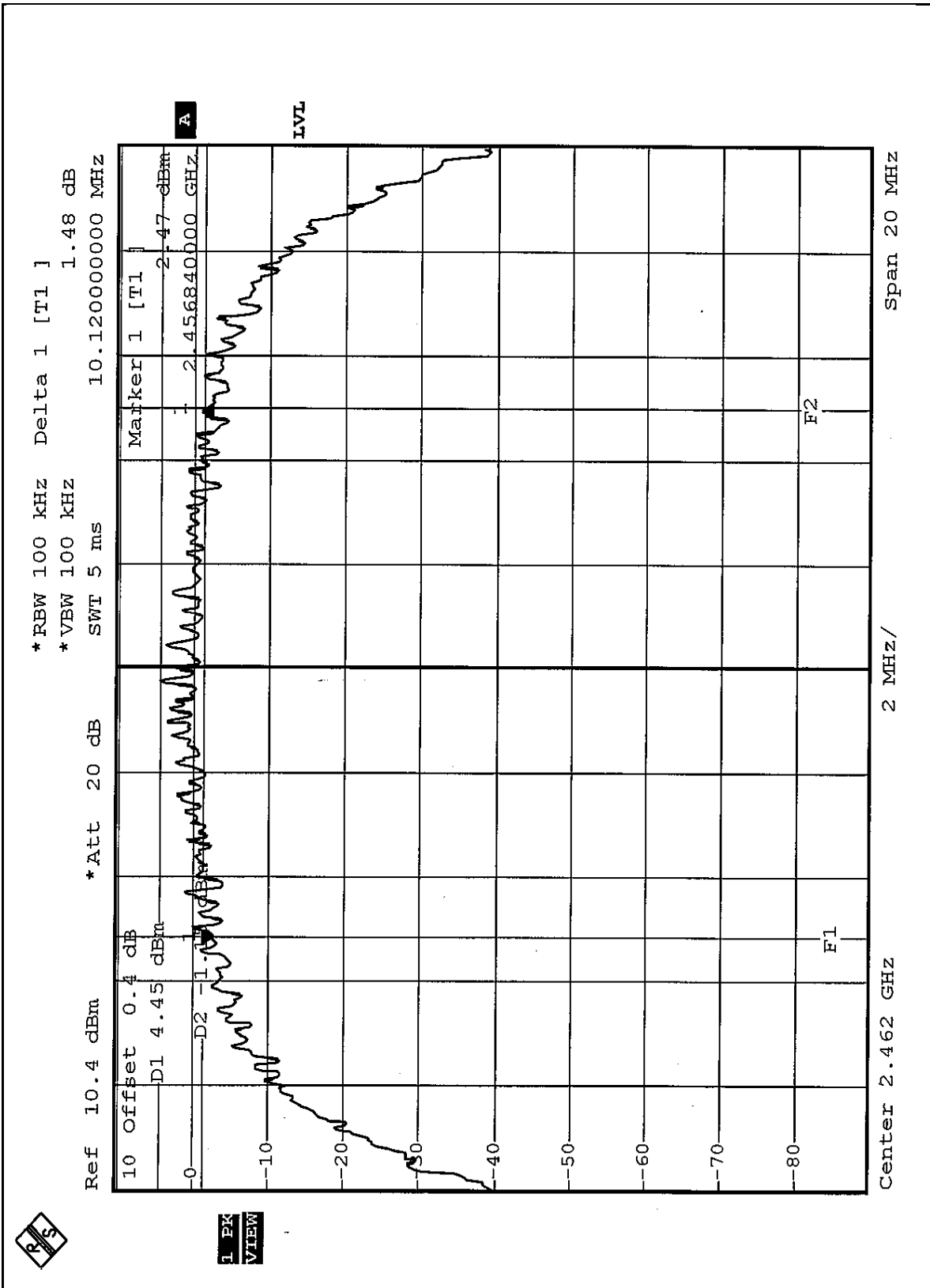



## 4.3.8 TEST RESULTS (B)

<b>EUT</b>	Wireless AP VPN Router	<b>MODEL</b>	WRTD-117GW
<b>INPUT POWER (SYSTEM)</b>	120 Vac, 60 Hz	<b>ENVIRONMENTAL CONDITIONS</b>	24 deg. C, 65% RH, 991 hPa
<b>TESTED BY</b>	Leo Hung		

<b>CHANNEL</b>	<b>CHANNEL FREQUENCY (MHz)</b>	<b>6 dB BANDWIDTH (MHz)</b>	<b>MINIMUM LIMIT (MHz)</b>	<b>PASS/FAIL</b>
1	2412	16.48	0.5	PASS
6	2437	16.44	0.5	PASS
11	2462	16.44	0.5	PASS



CH 1

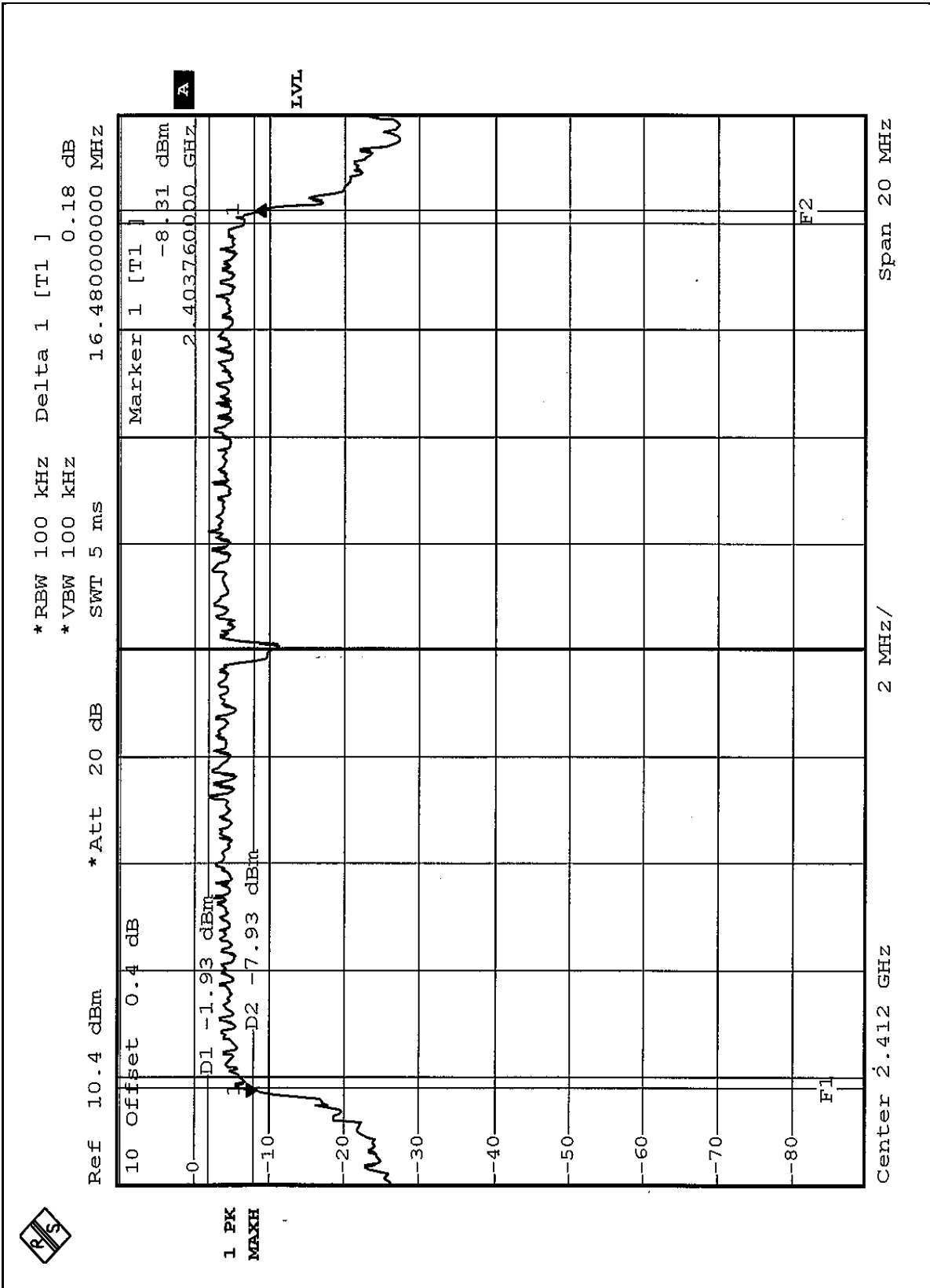



CH 6

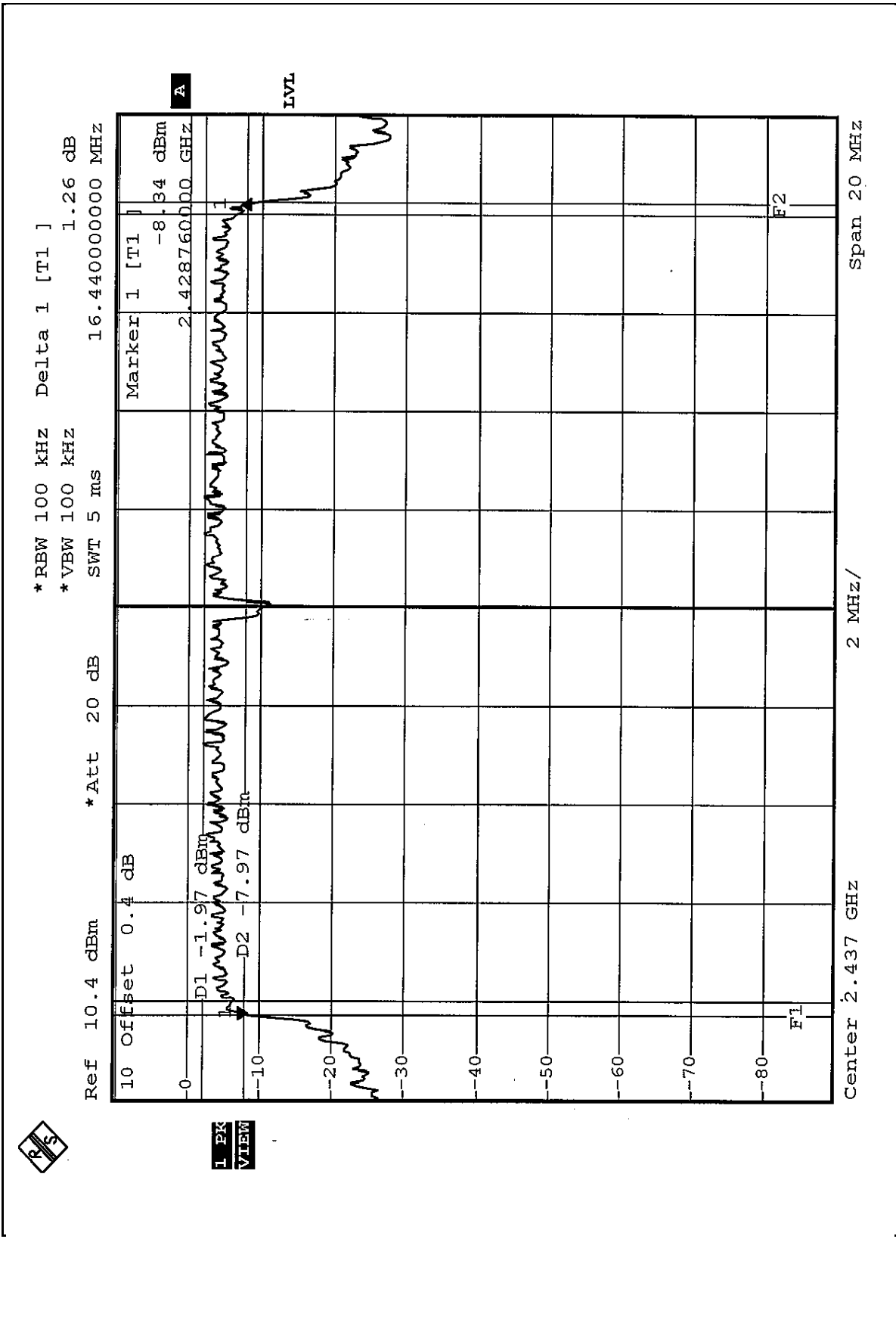



CH 11

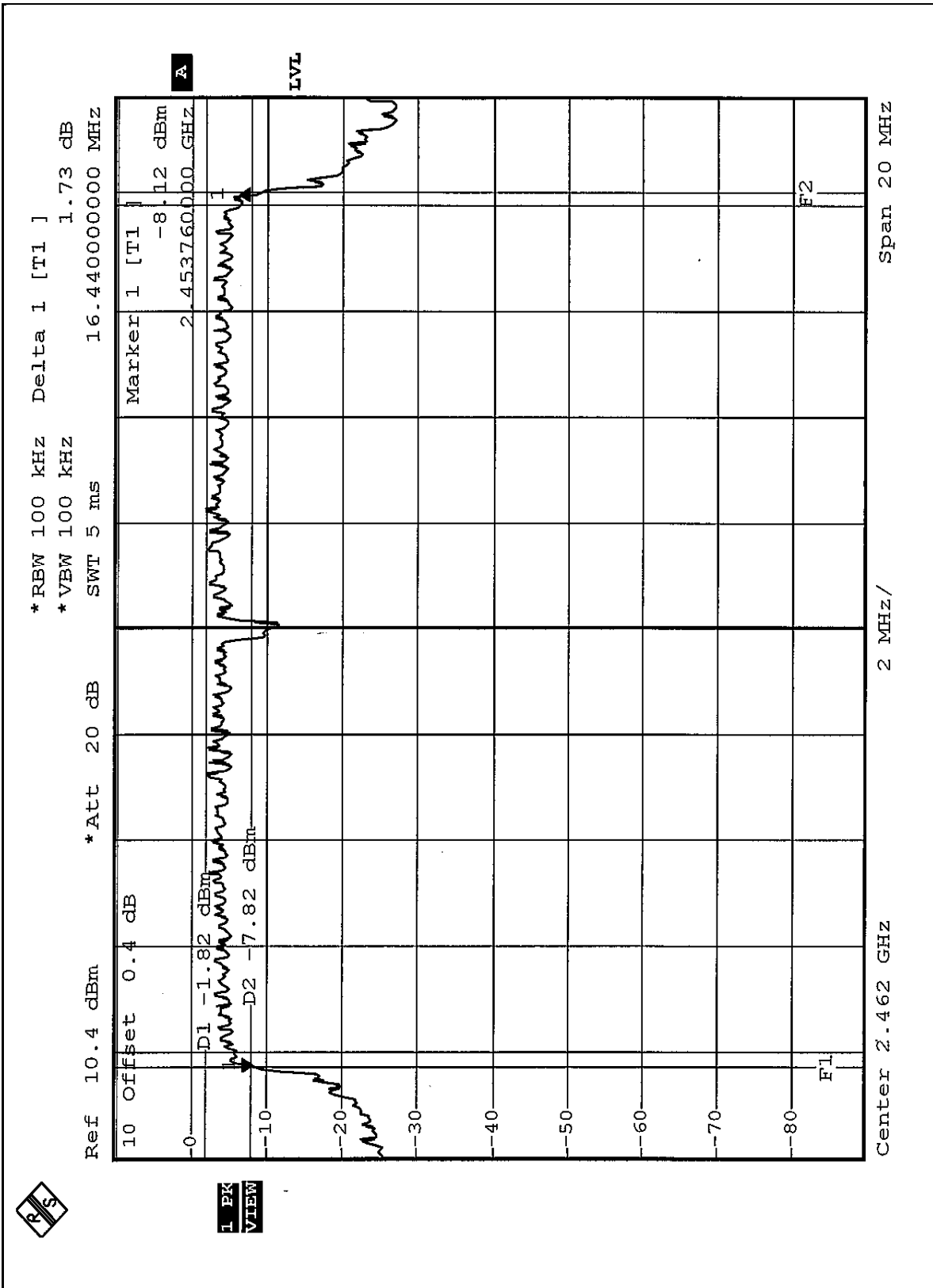

#### 4.4 MAXIMUM PEAK OUTPUT POWER

##### 4.4.1 LIMITS OF MAXIMUM PEAK OUTPUT POWER MEASUREMENT

The Maximum Peak Output Power Measurement is 30dBm.

##### 4.4.2 TEST INSTRUMENTS

Description & Manufacturer	Model No.	Serial No.	Calibrated Until
R&S SPECTRUM ANALYZER	FSEK30	100049	Aug. 12, 2005
AGILENT SIGNAL GENERATOR	E8257C	MY43320668	Dec. 31, 2004
TEKTRONIX OSCILLOSCOPE	TDS 220	C019167	Feb. 1, 2005
NARDA DETECTOR	4503A	FSCM99899	NA

**NOTE:**

The calibration interval of the above test instruments is 12 months and the calibrations are traceable to NML/ROC and NIST/USA.





#### 4.4.3 TEST PROCEDURES

1. A detector was used on the output port of the EUT. An oscilloscope was used to peak the response of the detector.
2. Replaced the EUT by the signal generator. The center frequency of the S.G was adjusted to the center frequency of the measured channel.
3. Adjusted the power to have the same peak reading on oscilloscope. Record the power level.

#### 4.4.4 DEVIATION FROM TEST STANDARD

No deviation

#### 4.4.5 TEST SETUP



#### 4.4.6 EUT OPERATING CONDITIONS

Same as Item 4.3.6



4.4.7 TEST RESULTS (A)

<b>EUT</b>	Wireless AP VPN Router	<b>MODEL</b>	WRTD-117GW
<b>INPUT POWER (SYSTEM)</b>	120 Vac, 60 Hz	<b>ENVIRONMENTAL CONDITIONS</b>	24 deg. C, 65% RH, 991 hPa
<b>TESTED BY</b>	Leo Hung		

CHANNEL	CHANNEL FREQUENCY (MHz)	PEAK POWER OUTPUT (mW)	PEAK POWER OUTPUT (dBm)	PEAK POWER LIMIT (dBm)	PASS/FAIL
1	2412	31.696	15.01	30	PASS
6	2437	31.623	15.00	30	PASS
11	2462	31.769	15.02	30	PASS

4.4.8 TEST RESULTS (B)

<b>EUT</b>	Wireless AP VPN Router	<b>MODEL</b>	WRTD-117GW
<b>INPUT POWER (SYSTEM)</b>	120 Vac, 60 Hz	<b>ENVIRONMENTAL CONDITIONS</b>	24 deg. C, 65% RH, 991 hPa
<b>TESTED BY</b>	Leo Hung		

CHANNEL	CHANNEL FREQUENCY (MHz)	PEAK POWER OUTPUT (mW)	PEAK POWER OUTPUT (dBm)	PEAK POWER LIMIT (dBm)	PASS/FAIL
1	2412	31.842	15.03	30	PASS
6	2437	31.696	15.01	30	PASS
11	2462	31.623	15.00	30	PASS



## 4.5 POWER SPECTRAL DENSITY MEASUREMENT

### 4.5.1 LIMITS OF POWER SPECTRAL DENSITY MEASUREMENT

The Maximum of Power Spectral Density Measurement is 8dBm.

### 4.5.2 TEST INSTRUMENTS

Description & Manufacturer	Model No.	Serial No.	Calibrated Until
SPECTRUM ANALYZER	FSEK30	100049	Aug. 12, 2005

**NOTE:** The calibration interval of the above test instruments is 12 months and the calibrations are traceable to NML/ROC and NIST/USA.

#### 4.5.3 TEST PROCEDURE

The transmitter output was connected to the spectrum analyzer through an attenuator, the bandwidth of the fundamental frequency was measured with the spectrum analyzer using 3kHz RBW and 30kHz VBW, set sweep time=span/3kHz. The power spectral density was measured and recorded. The sweep time is allowed to be longer than span/3kHz for a full response of the mixer in the spectrum analyzer.

#### 4.5.4 DEVIATION FROM TEST STANDARD

No deviation

#### 4.5.5 TEST SETUP

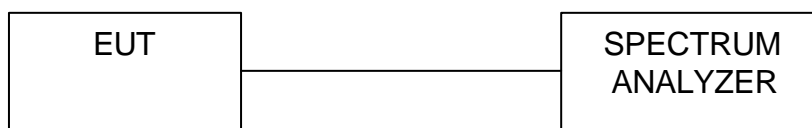

#### 4.5.6 EUT OPERATING CONDITIONS

Same as 4.3.6



4.5.7 TEST RESULTS (A)

<b>EUT</b>	Wireless AP VPN Router	<b>MODEL</b>	WRTD-117GW
<b>INPUT POWER (SYSTEM)</b>	120 Vac, 60 Hz	<b>ENVIRONMENTAL CONDITIONS</b>	24 deg. C, 65% RH, 991 hPa
<b>TESTED BY</b>	Leo Hung		

<b>CHANNEL NUMBER</b>	<b>CHANNEL FREQUENCY (MHz )</b>	<b>RF POWER LEVEL IN 3KHz BW (dBm)</b>	<b>MAXIMUM LIMIT (dBm)</b>	<b>PASS/FAIL</b>
1	2412	-9.77	8	PASS
6	2437	-9.50	8	PASS
11	2462	-9.45	8	PASS



CH 1

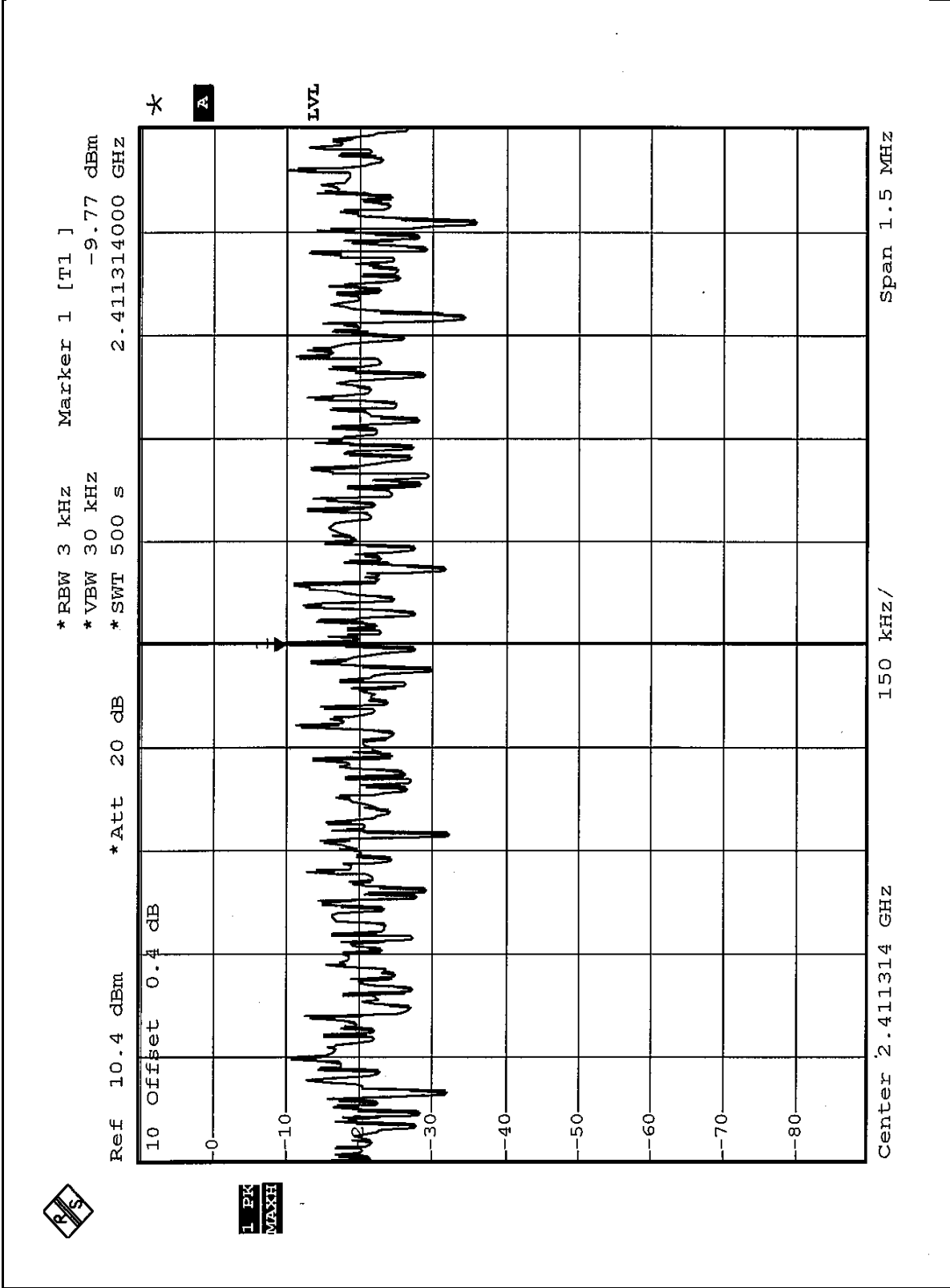



CH 6

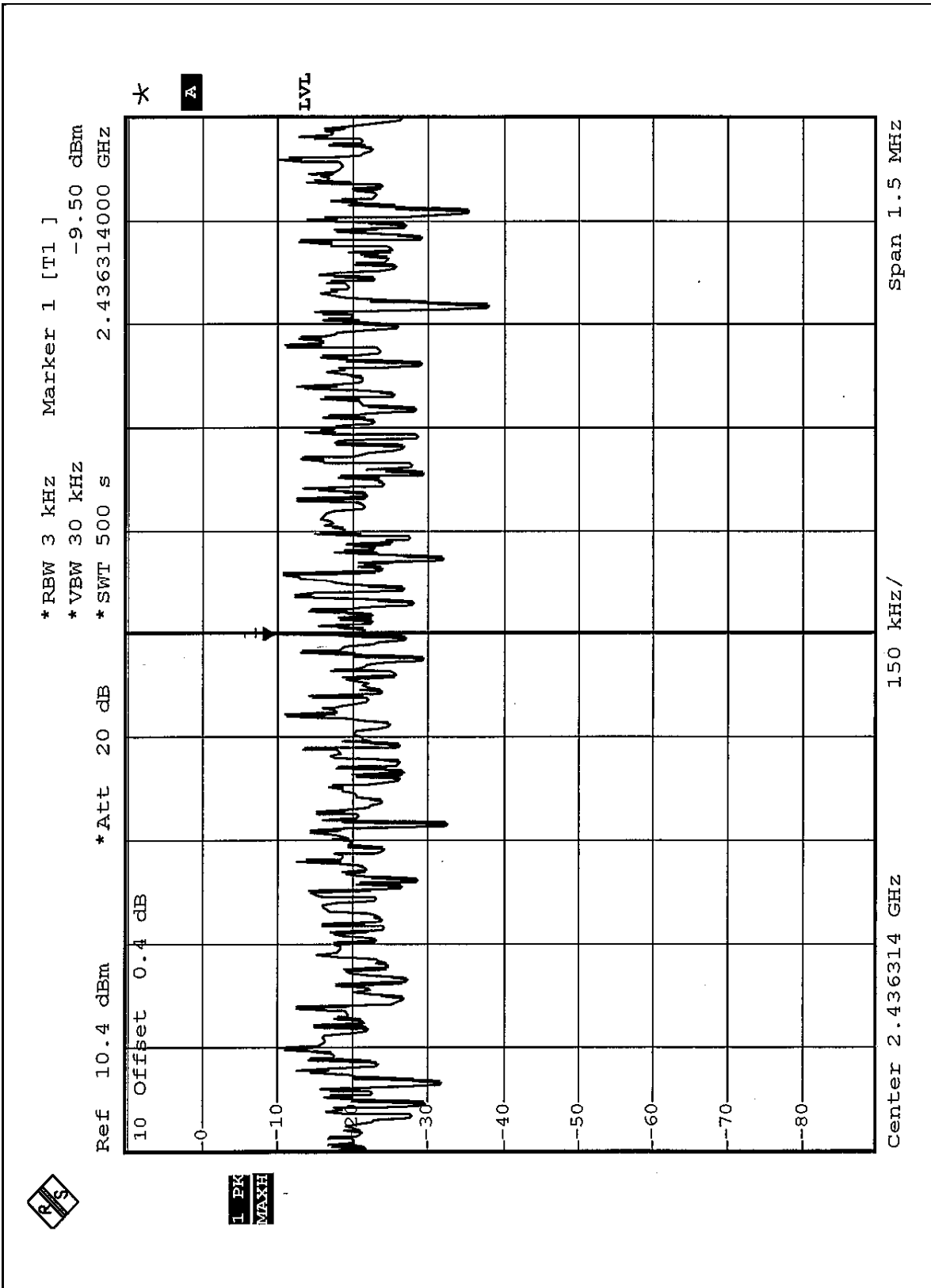



CH 11

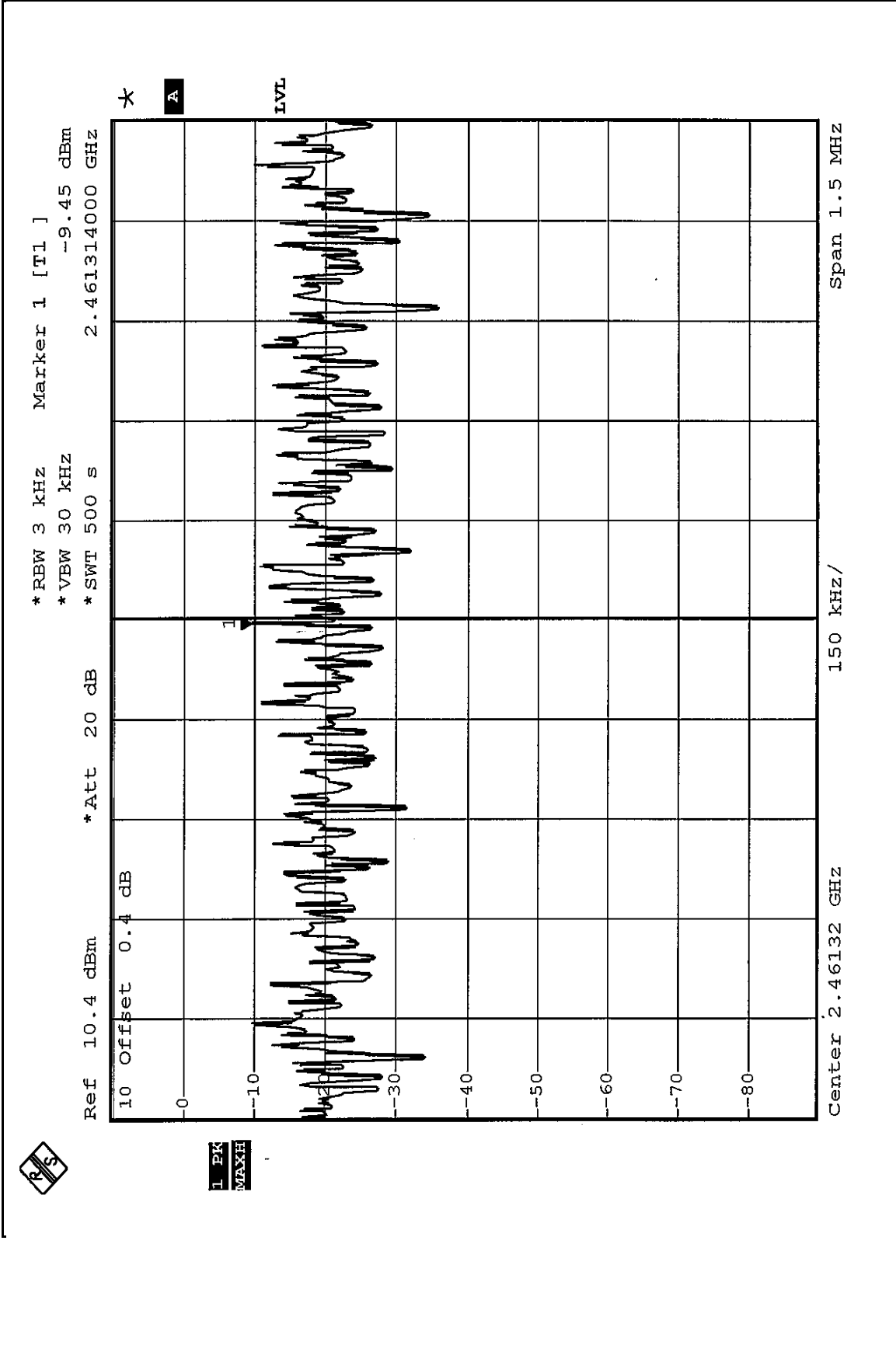





4.5.8 TEST RESULTS (B)

<b>EUT</b>	Wireless AP VPN Router	<b>MODEL</b>	WRTD-117GW
<b>INPUT POWER (SYSTEM)</b>	120 Vac, 60 Hz	<b>ENVIRONMENTAL CONDITIONS</b>	24 deg. C, 65% RH, 991 hPa
<b>TESTED BY</b>	Leo Hung		

<b>CHANNEL NUMBER</b>	<b>CHANNEL FREQUENCY (MHz )</b>	<b>RF POWER LEVEL IN 3KHz BW (dBm)</b>	<b>MAXIMUM LIMIT (dBm)</b>	<b>PASS/FAIL</b>
1	2412	-16.02	8	PASS
6	2437	-16.08	8	PASS
11	2462	-15.97	8	PASS



CH 1

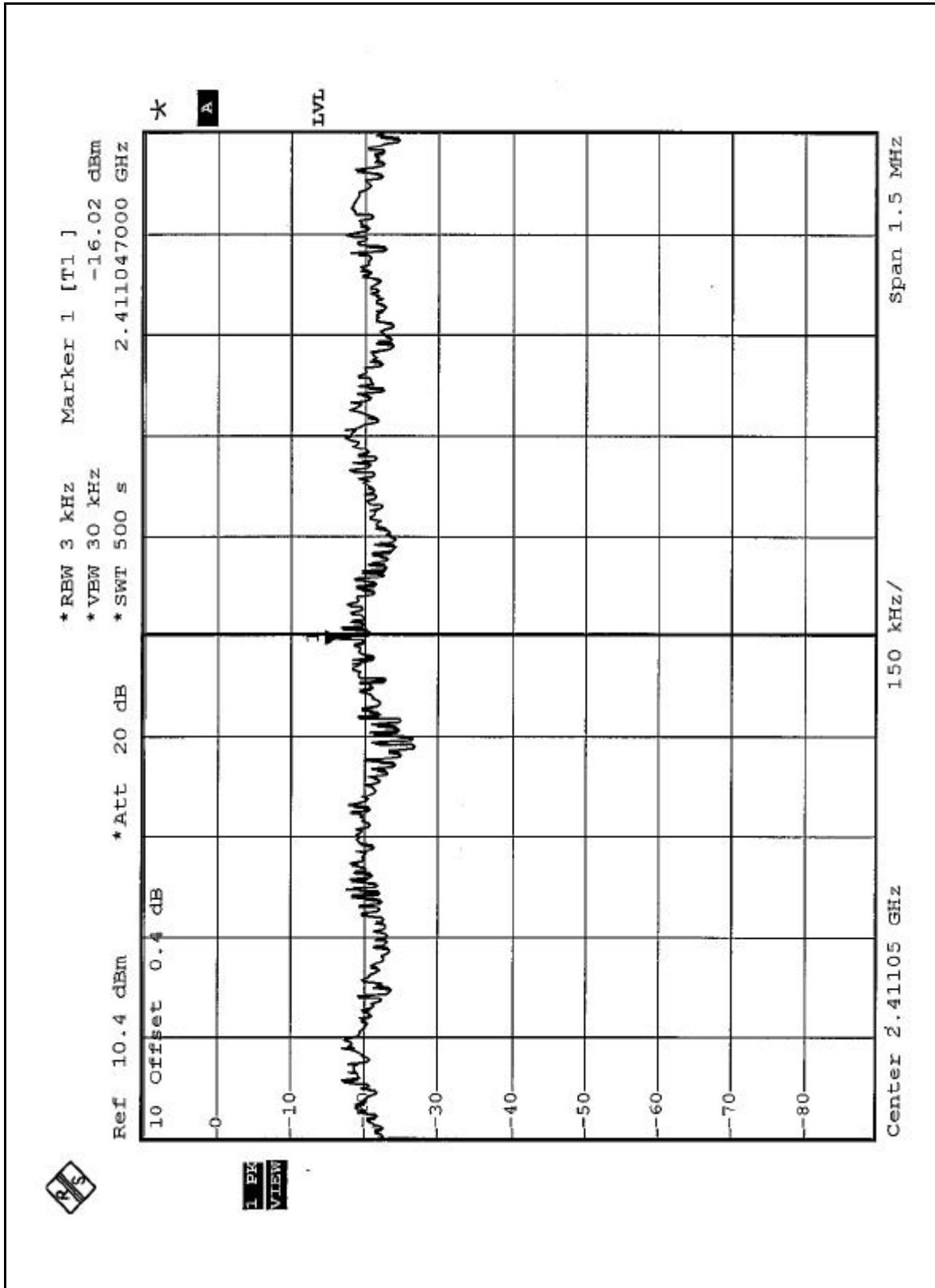



CH 6

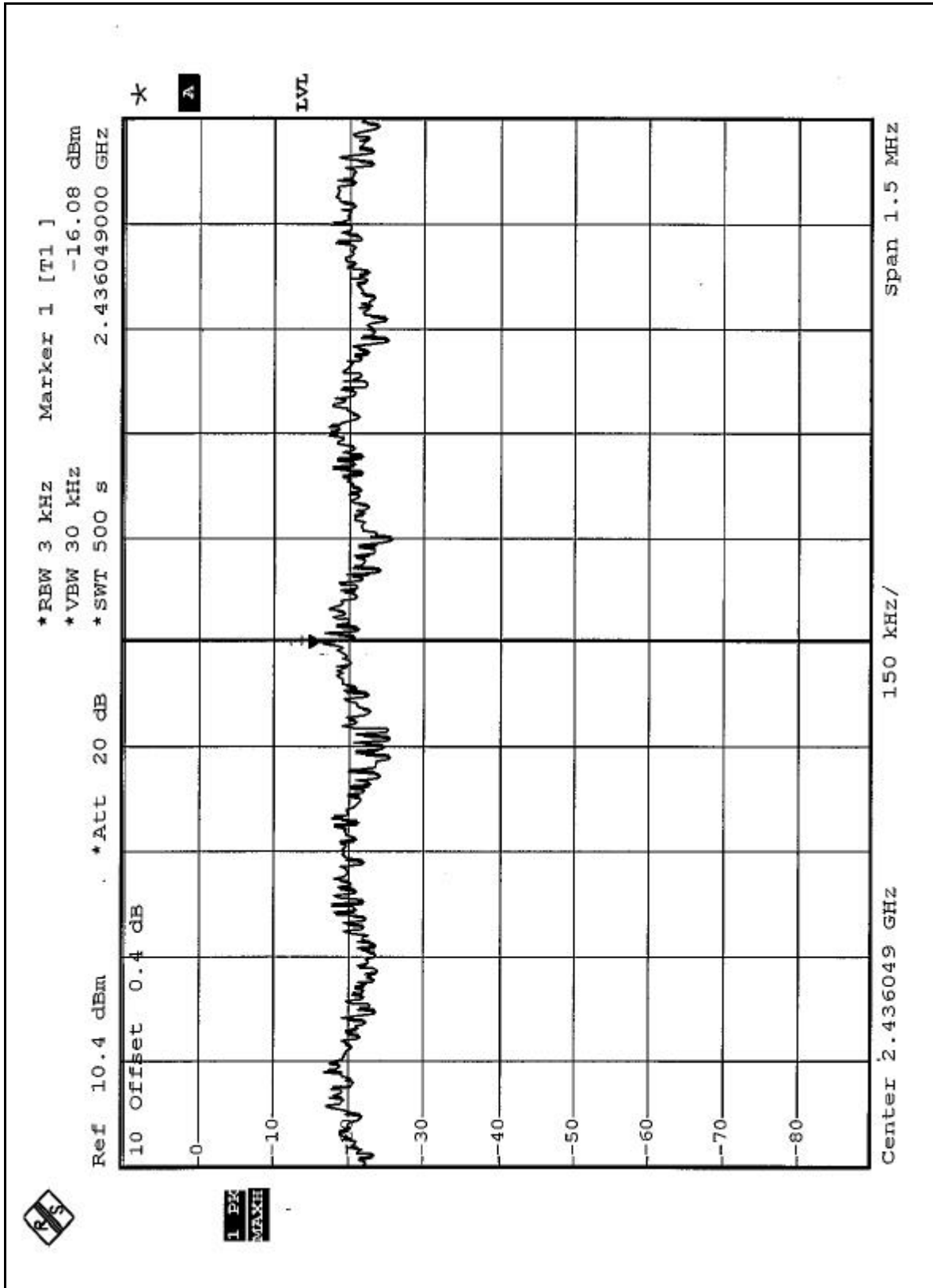



CH 11

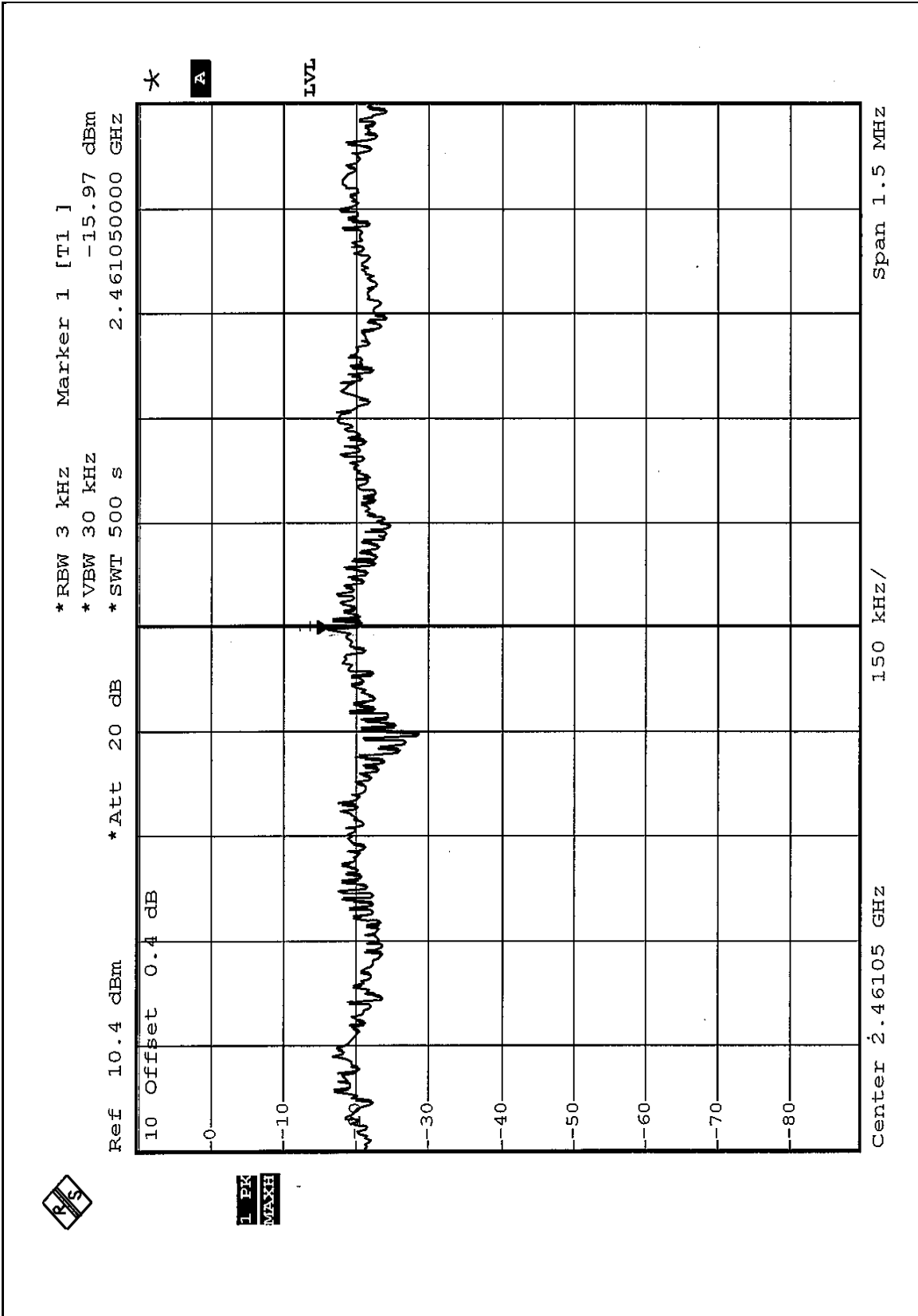



## 4.6 BAND EDGES MEASUREMENT

### 4.6.1 LIMITS OF BAND EDGES MEASUREMENT

Below -20dB of the highest emission level of operating band (in 100kHz Resolution Bandwidth).

### 4.6.2 TEST INSTRUMENTS

Description & Manufacturer	Model No.	Serial No.	Calibrated Until
SPECTRUM ANALYZER	FSEK30	100049	Aug. 12, 2005

**NOTE:** The calibration interval of the above test instruments is 12 months and the calibrations are traceable to NML/ROC and NIST/USA.

### 4.6.3 TEST PROCEDURE

The transmitter output was connected to the spectrum analyzer via a low lose cable. Set both RBW and VBW of spectrum analyzer to 1MHz and 10Hz with suitable frequency span including 100 MHz bandwidth from band edge. The band edges was measured and recorded.

### 4.6.4 DEVIATION FROM TEST STANDARD

No deviation

### 4.6.5 EUT OPERATING CONDITION

Same as Item 4.3.6



#### 4.6.6 TEST RESULTS

The spectrum plots are attached on the following 8 pages. D2 line indicates the highest level, D1 line indicates the 20dB offset below D2. It shows compliance with the requirement in part 15.247(C).

#### 4.6.7 TEST RESULTS(A)

**NOTE:**

The band edge emission plot of CCK technique on the following 1~2 pages show 59.69dB delta between carrier maximum power and local maximum emission in restrict band (2.3744GHz). The emission of carrier strength list in the test result of channel 1 at the item 4.2.8 is 105.29dBuV/m, so the maximum field strength in restrict band is  $105.29-59.69=45.60$ dBuV/m which is under 54dBuV/m limit.

The band edge emission plot of CCK technique on the following 3~4 pages show 59.62dB delta between carrier maximum power and local maximum emission in restrict band (2.4836GHz). The emission of carrier strength list in the test result of channel 11 at the item 4.2.8 is 106.00dBuV/m, so the maximum field strength in restrict band is  $106.00-59.62=46.38$ dBuV/m which is under 54dBuV/m limit.

#### 4.6.8 TEST RESULTS(B)

**NOTE:**

The band edge emission plot of OFDM technique on the following 5~6 pages show 51.45dB delta between carrier maximum power and local maximum emission in restrict band (2.3900GHz). The emission of carrier strength list in the test result of channel 1 at the item 4.2.9 is 100.55dBuV/m, so the maximum field strength in restrict band is  $100.55-51.45=49.10$ dBuV/m which is under 54dBuV/m limit.

The band edge emission plot of OFDM technique on the following 7~8 pages show 49.75dB delta between carrier maximum power and local maximum emission in restrict band (2.4835GHz). The emission of carrier strength list in the test result of channel 11 at the item 4.2.9 is 100.14dBuV/m, so the maximum field strength in restrict band is  $100.14-49.75=50.39$ dBuV/m which is under 54dBuV/m limit.

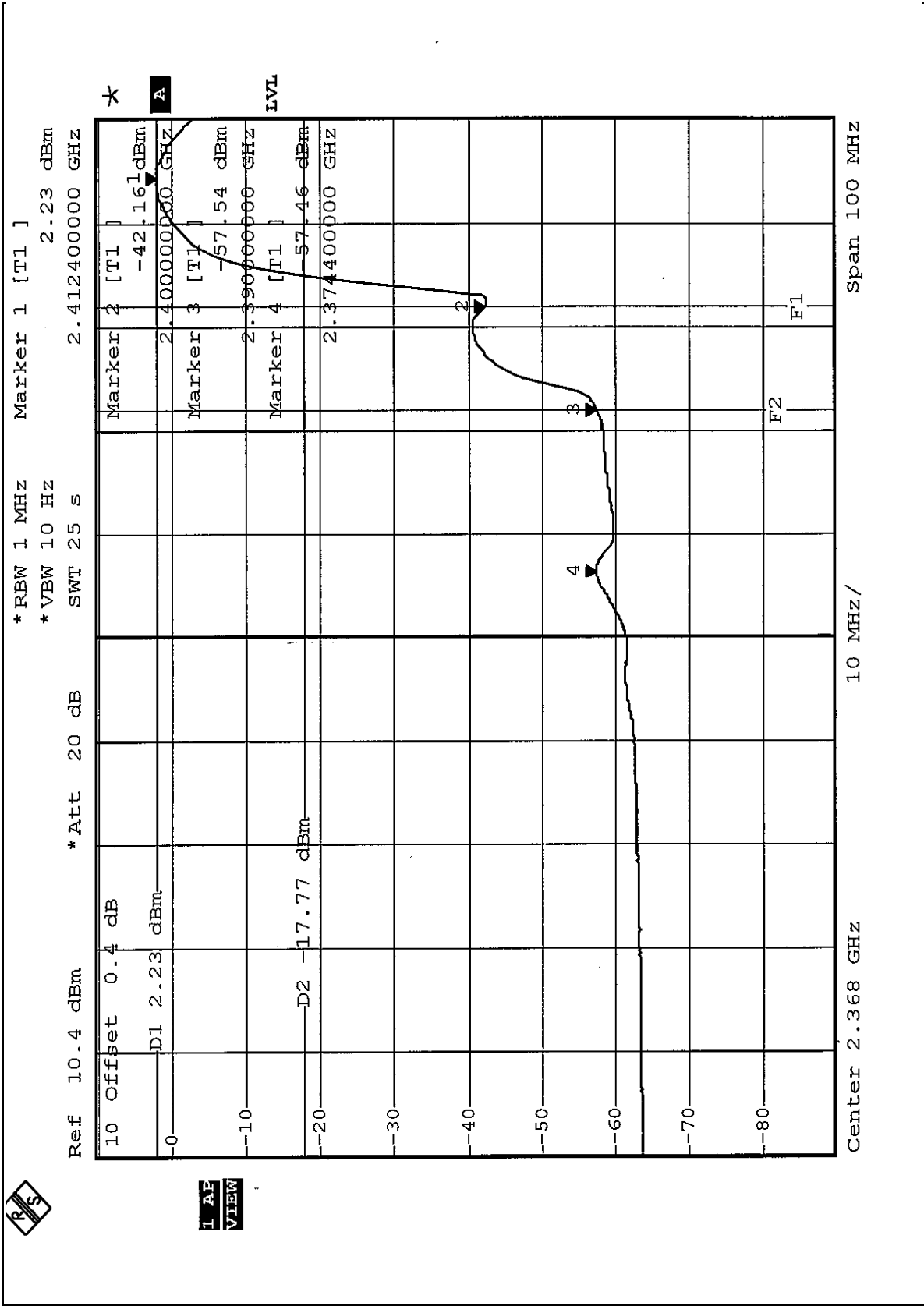

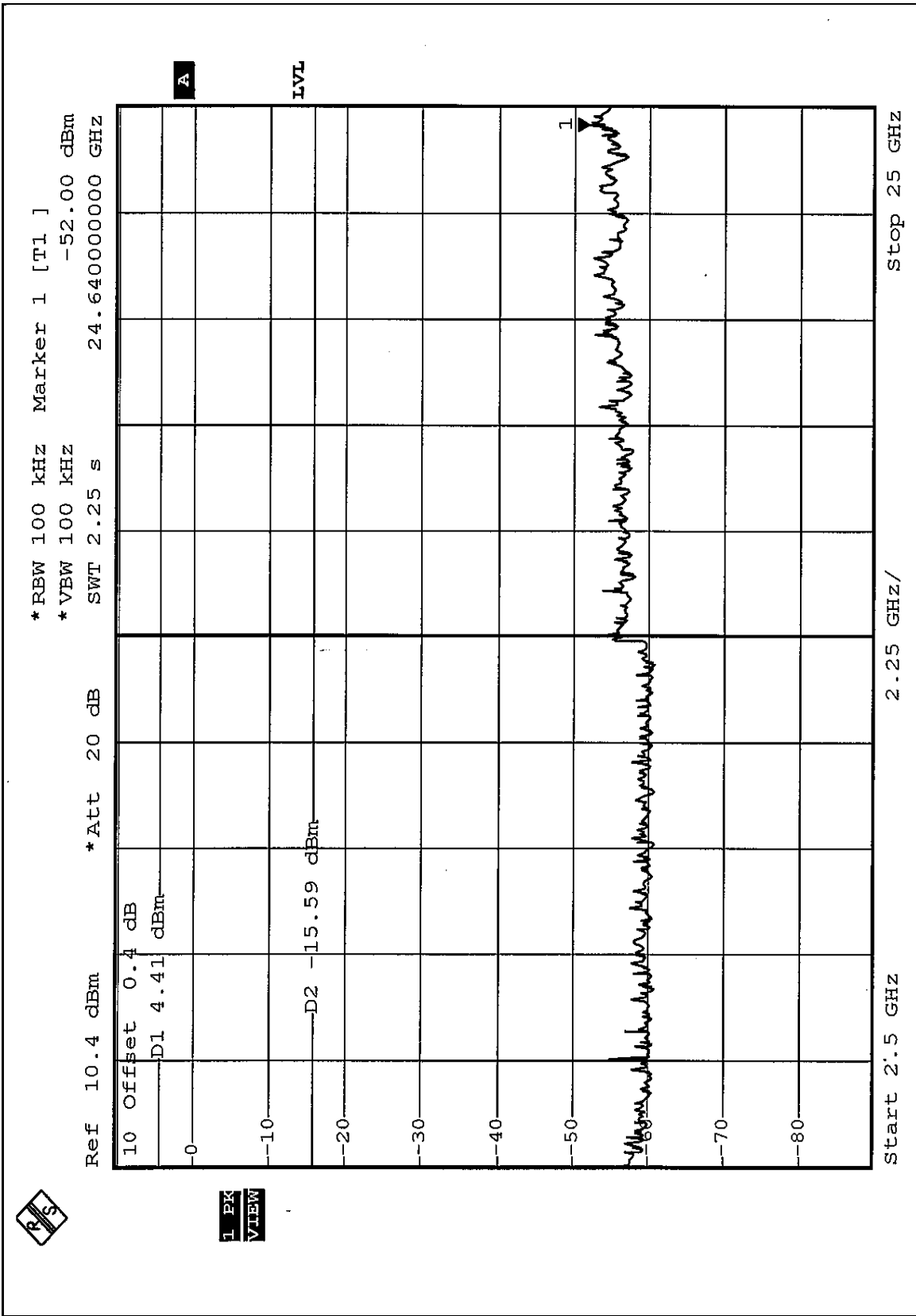



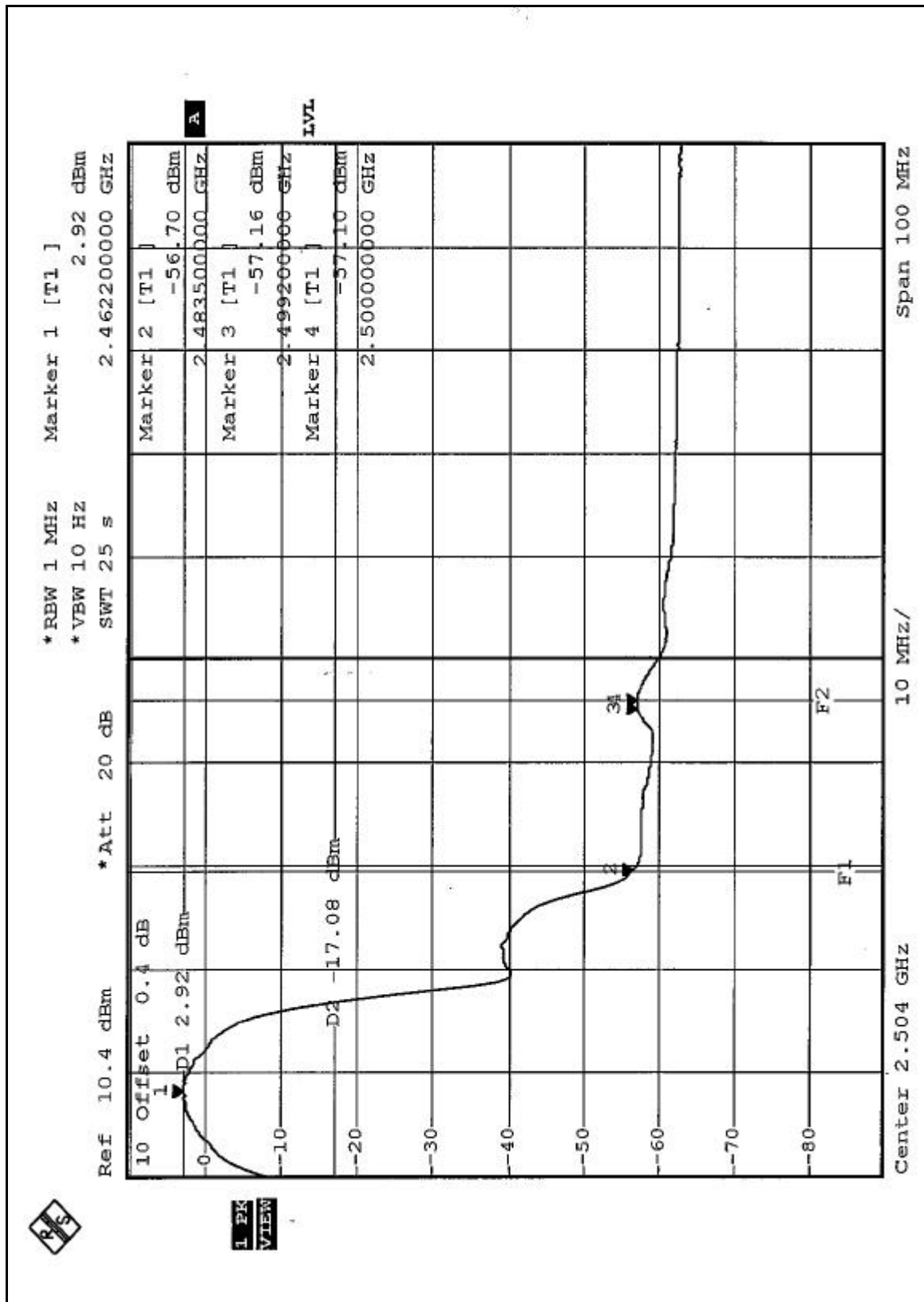

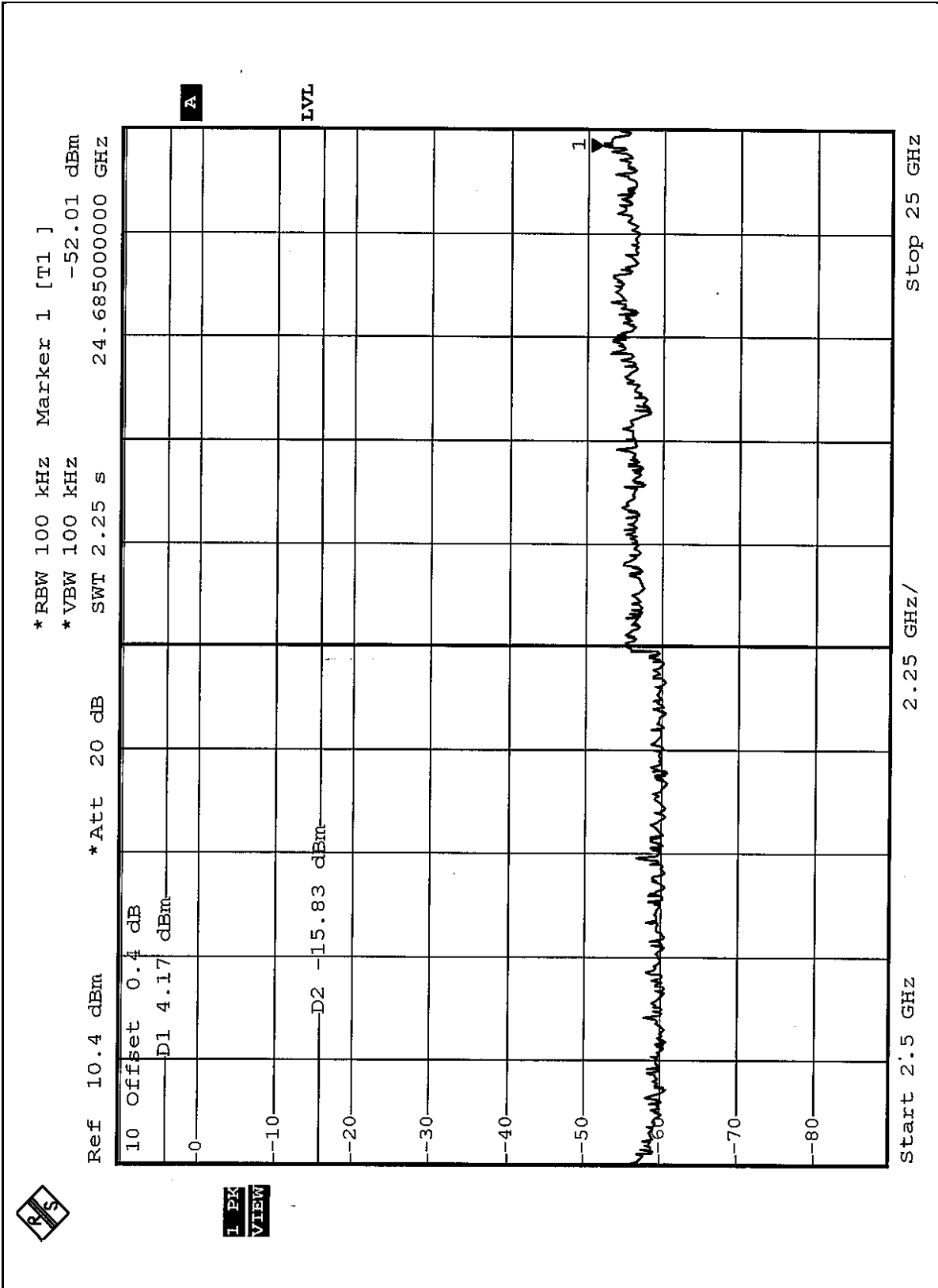

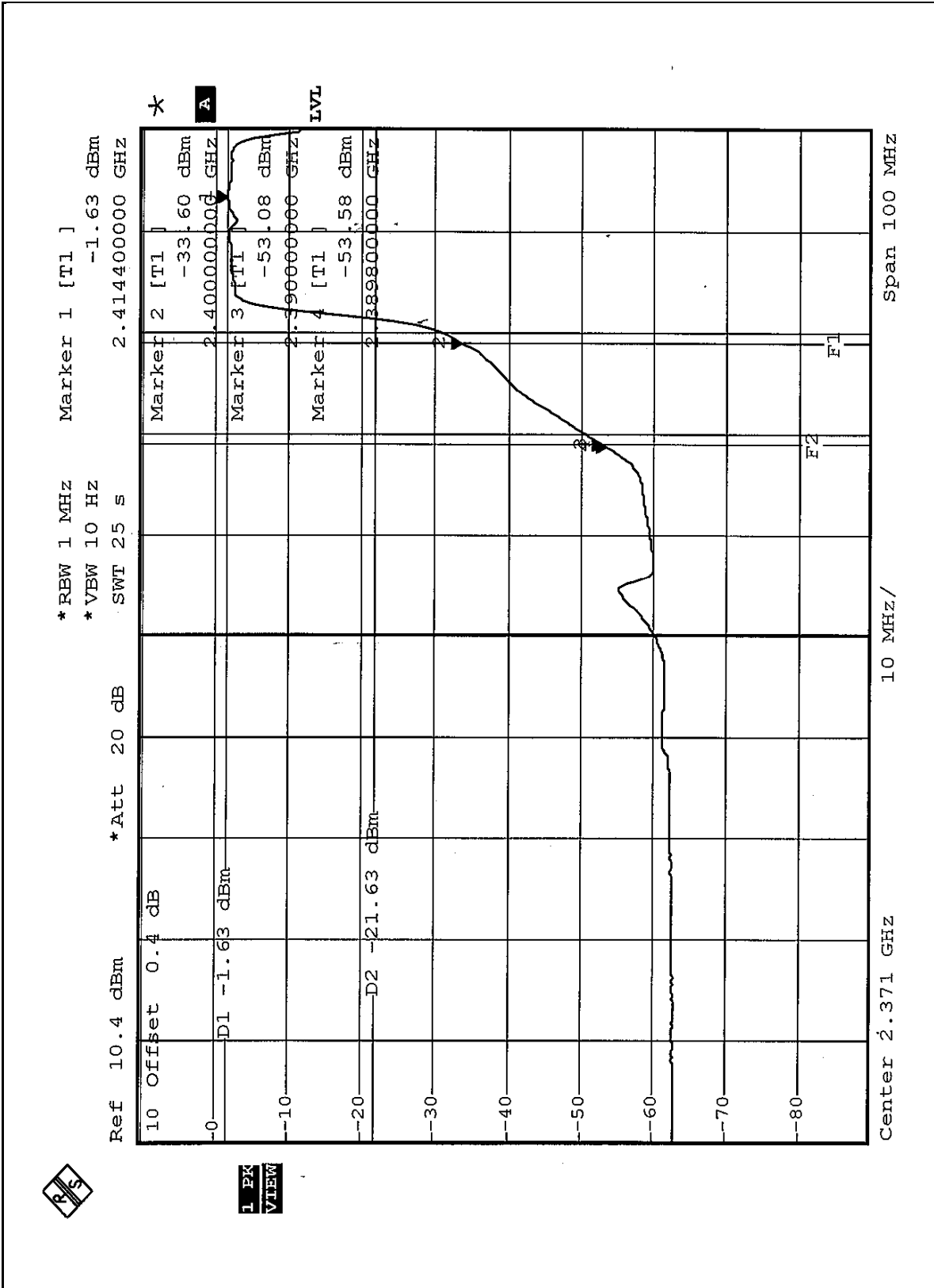

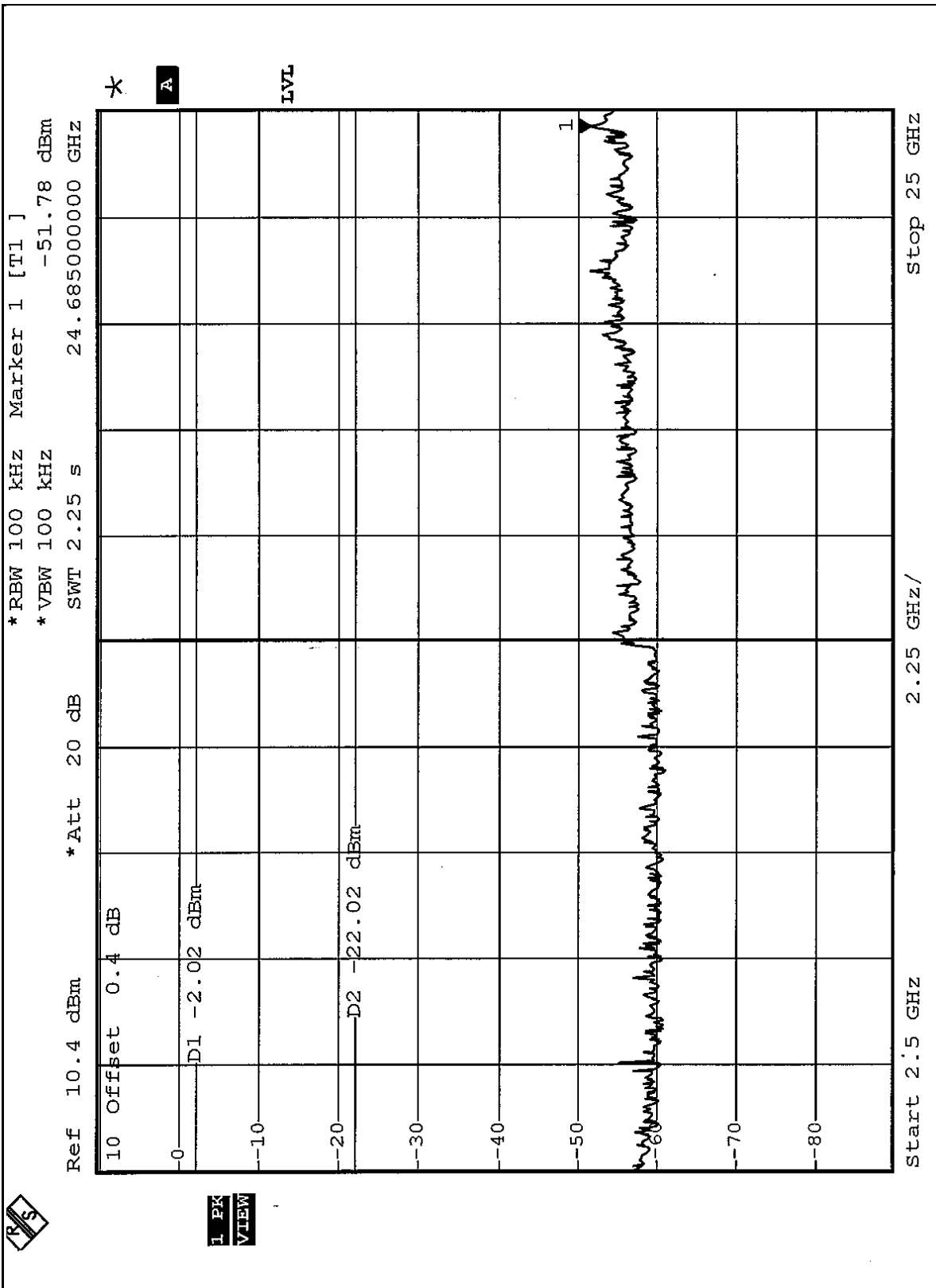

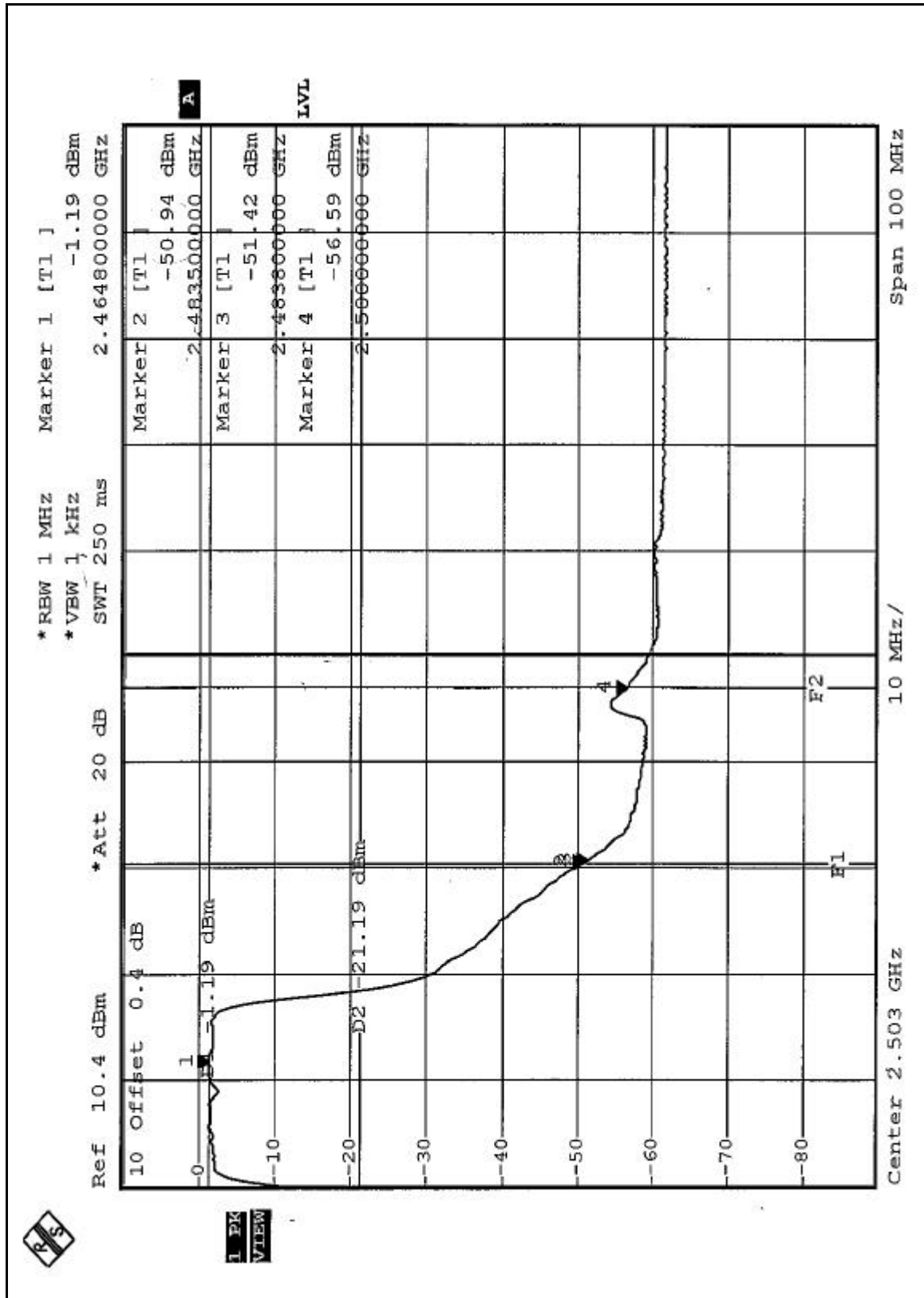

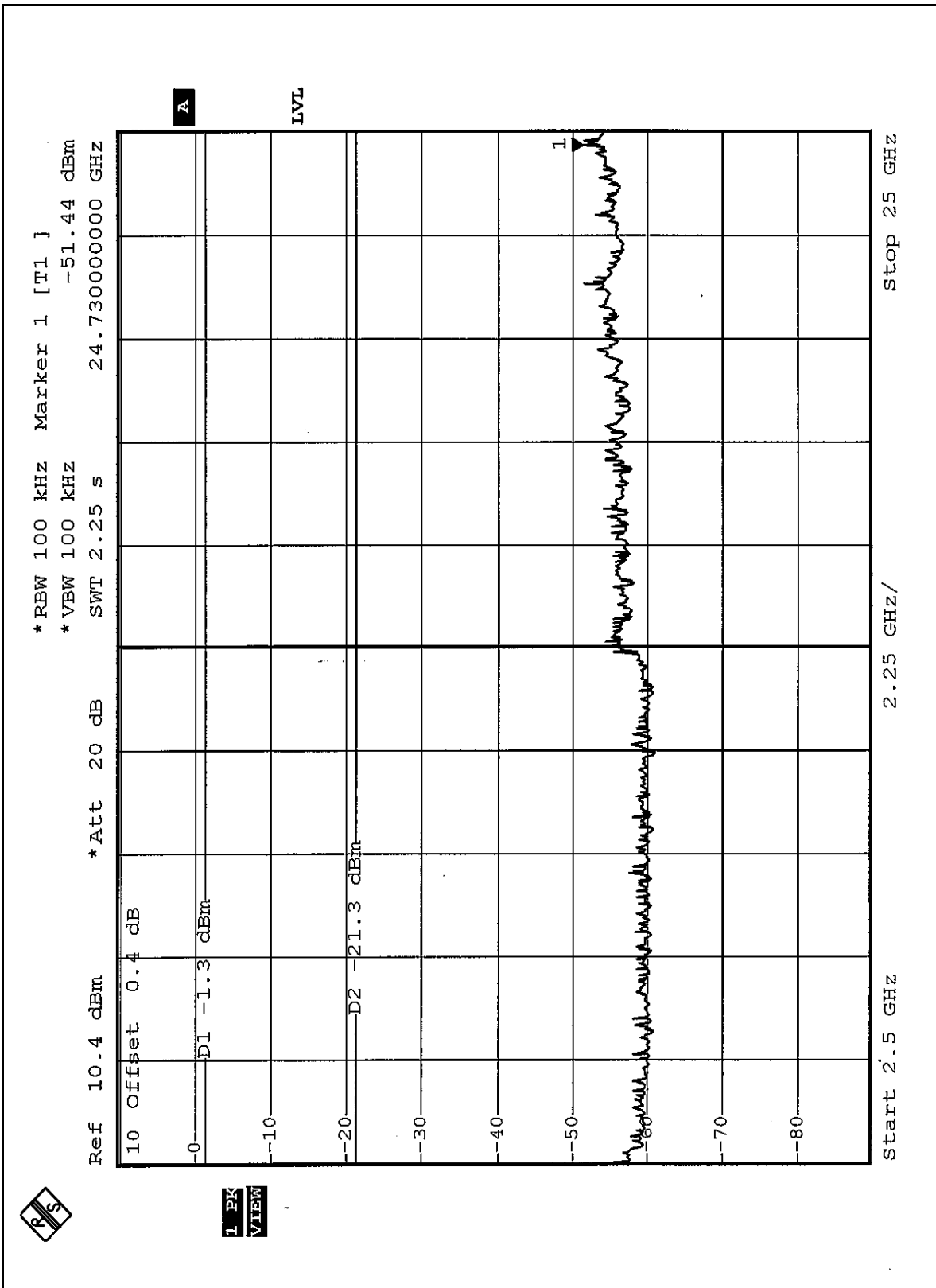



## **4.7 ANTENNA REQUIREMENT**

### **4.7.1 STANDARD APPLICABLE**

For intentional device, according to FCC 47 CFR Section 15.203, an intentional radiator shall be designed to ensure that no antenna other than that furnished by the responsible party shall be used with the device.

And according to FCC 47 CFR Section 15.247 (b), if transmitting antennas of directional gain greater than 6dBi are used, the power shall be reduced by the amount in dB that the directional gain of the antenna exceeds 6dBi.

### **4.7.2 ANTENNA CONNECTED CONSTRUCTION**

The antenna used in this product is Dipole antenna with UFL connector. And the maximum Gain of this antenna is 5dBi.

## 5 PHOTOGRAPHS OF THE TEST CONFIGURATION CONDUCTED EMISSION TEST





### RADIATED EMISSION TEST

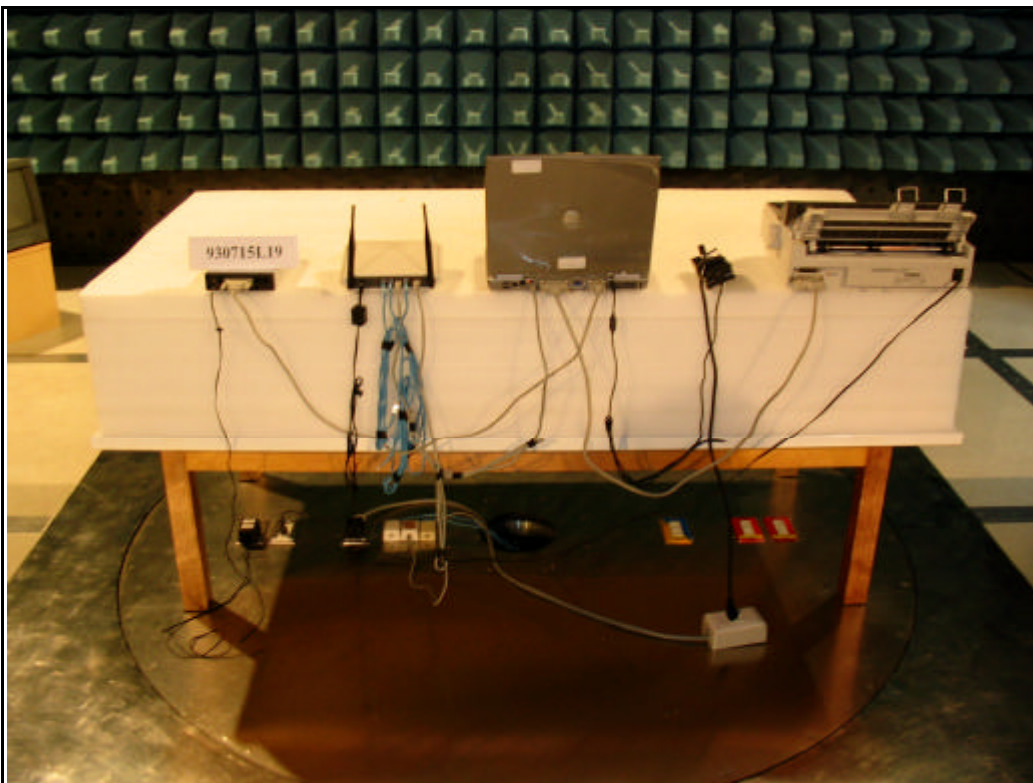
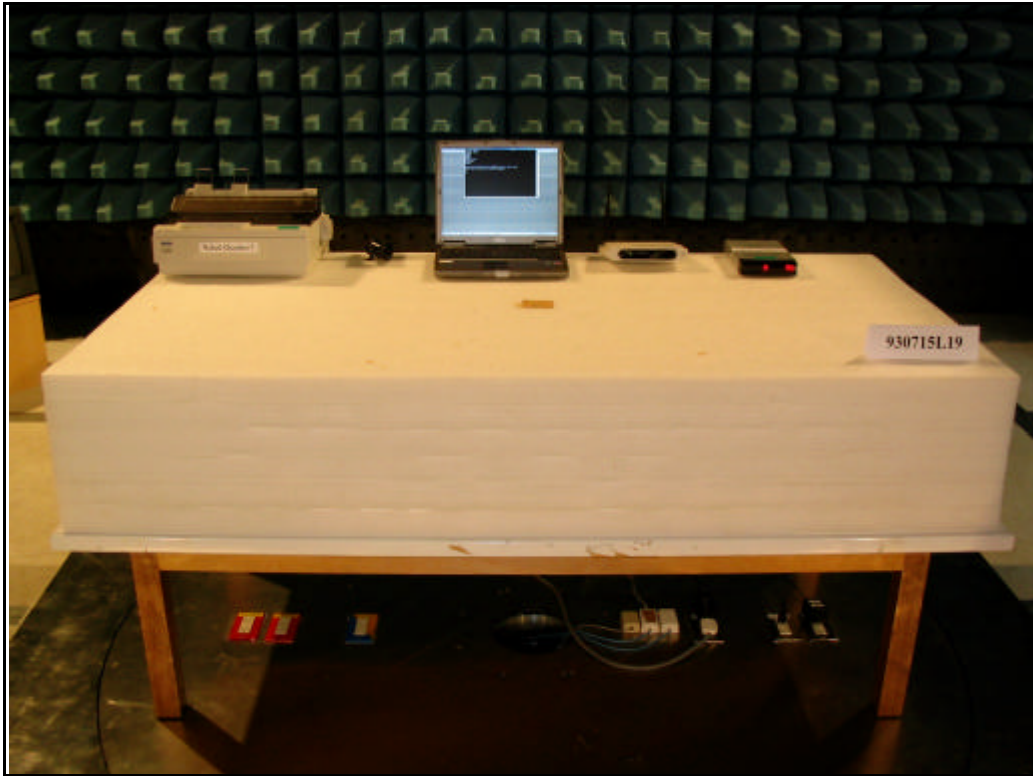



## 6 INFORMATION ON THE TESTING LABORATORIES

We, ADT Corp., were founded in 1988 to provide our best service in EMC, Radio, Telecom and Safety consultation. Our laboratories are accredited and approved by the following approval agencies according to ISO/IEC 17025, Guide 25 or EN 45001:

<b>USA</b>	FCC, NVLAP, UL, A2LA
<b>Germany</b>	TUV Rheinland
<b>Japan</b>	VCCI
<b>Norway</b>	NEMKO
<b>Canada</b>	INDUSTRY CANADA , CSA
<b>R.O.C.</b>	CNLA, BSMI, DGT
<b>Netherlands</b>	Telefication
<b>Singapore</b>	PSB , GOST-ASIA(MOU)
<b>Russia</b>	CERTIS(MOU)

Copies of accreditation certificates of our laboratories obtained from approval agencies can be downloaded from our web site:

[www.adt.com.tw/index.5/phtml](http://www.adt.com.tw/index.5/phtml). If you have any comments, please feel free to contact us at the following:

**Linko EMC/RF Lab:**  
Tel: 886-2-26052180  
Fax: 886-2-26052943

**Hsin Chu EMC/RF Lab:**  
Tel: 886-3-5935343  
Fax: 886-3-5935342

**Hwa Ya EMC/RF/Safety/Telecom Lab:**  
Tel: 886-3-3183232  
Fax: 886-3-3185050

**Linko RF Lab.**  
Tel: 886-3-3270910  
Fax: 886-3-3270892

**Web Site:** [www.adt.com.tw](http://www.adt.com.tw)

The address and road map of all our labs can be found in our web site also.

Report Format Version 1.5