

Venstar, Inc.

REVISED TEST REPORT FOR 104502-11

Data Concentrator with Wifi, Subgig, BLE, Model: DC500
Power Supply, Model: MKA-482400500

Tested to The Following Standards:

FCC Part 15 Subpart C Section(s)

15.207 & 15.247
(DTS 902-928MHz)

Report No.: 104502-11A

Date of issue: March 21, 2022



Test Certificate # 803.01

This test report bears the accreditation symbol indicating that the testing performed herein meets the test and reporting requirements of ISO/IEC 17025 under the applicable scope of testing for CKC Laboratories, Inc.

We strive to create long-term, trust based relationships by providing sound, adaptive, customer first testing services. We embrace each of our customers' unique EMC challenges, not as an interruption to set processes, but rather as the reason we are in business.

This report contains a total of 39 pages and may be reproduced in full only. Partial reproduction may only be done with the written consent of CKC Laboratories, Inc.



TABLE OF CONTENTS

Administrative Information 3

 Test Report Information3

 Revision History3

 Report Authorization3

 Test Facility Information4

 Software Versions4

 Site Registration & Accreditation Information4

 Summary of Results5

 Modifications During Testing.....5

 Conditions During Testing5

 Equipment Under Test.....6

 General Product Information6

FCC Part 15 Subpart C 12

 15.247(a)(2) 6dB Bandwidth.....12

 15.247(b)(3) Output Power14

 15.247(e) Power Spectral Density16

 15.247(d) RF Conducted Emissions & Band Edge18

 15.247(d) Radiated Emissions & Band Edge23

 15.207 AC Conducted Emissions.....30

Appendix A: Modification 37

Supplemental Information..... 38

 Measurement Uncertainty38

 Emissions Test Details.....38

ADMINISTRATIVE INFORMATION

Test Report Information

REPORT PREPARED FOR:

Venstar, Inc.
9250 Owensmouth Avenue
Chatsworth, CA 91311

Representative: Alex Garashin

REPORT PREPARED BY:

Lisa Bevington
CKC Laboratories, Inc.
5046 Sierra Pines Drive
Mariposa, CA 95338

Project Number: 104502

DATE OF EQUIPMENT RECEIPT:

December 11, 2020

DATE(S) OF TESTING:

December 11, 2020
January 6 and 12, 2021

Revision History

Original: Testing of Data Concentrator with Wifi, Subgig, BLE, Model: DC500, Power Supply, Model: MKA-482400500 to FCC Part 15 Subpart C Section(s), 15.207 & 15.247, (DTS 902-928MHz).

Revision A: Updated Firmware / Software used for Test in the General Product Information section.

Report Authorization

The test data contained in this report documents the observed testing parameters pertaining to and are relevant for only the equipment provided by the client, tested in the agreed upon operational mode(s) and configuration(s) as identified herein. Compliance assessment remains the client's responsibility. This report may not be used to claim product endorsement by A2LA or any government agencies. This test report has been authorized for release under quality control from CKC Laboratories, Inc.



Steve Behm
Director of Quality Assurance & Engineering Services
CKC Laboratories, Inc.

Test Facility Information



Our laboratories are configured to effectively test a wide variety of product types. CKC utilizes first class test equipment, anechoic chambers, data acquisition and information services to create accurate, repeatable and affordable test results.

TEST LOCATION(S):
CKC Laboratories, Inc.
110 Olinda Place
Brea, CA 92823

Software Versions

CKC Laboratories Proprietary Software	Version
EMITest Emissions	5.03.19

Site Registration & Accreditation Information

Location	*NIST CB #	FCC	Canada	Japan
Canyon Park, Bothell, WA	US0103	US1024	3082C	A-0136
Brea, CA	US0103	US1024	3082D	A-0136
Fremont, CA	US0103	US1024	3082B	A-0136
Mariposa, CA	US0103	US1024	3082A	A-0136

*CKC's list of NIST designated countries can be found at: <https://standards.gov/cabs/designations.html>

SUMMARY OF RESULTS

Standard / Specification: FCC Part 15 Subpart C - 15.247 (DTS) (DTS 902-928MHz)

Test Procedure	Description	Modifications	Results
15.247(a)(2)	6dB Bandwidth	NA	Pass
15.247(b)(3)	Output Power	NA	Pass
15.247(e)	Power Spectral Density	NA	Pass
15.247(d)	RF Conducted Emissions & Band Edge	NA	Pass
15.247(d)	Radiated Emissions & Band Edge	Mod 1	Pass
15.207	AC Conducted Emissions	NA	Pass

NA = Not Applicable

ISO/IEC 17025 Decision Rule
The declaration of pass or fail herein is based upon assessment to the specification(s) listed above, including where applicable, assessment of measurement uncertainties. For performance related tests, equipment was monitored for specified criteria identified in that section of testing.

Modifications During Testing

This list is a summary of the modifications made to the equipment during testing.

Summary of Conditions
Mod 1: Copper tape added to LCD display cable to suppress radiated emission below 1 GHz.
See Appendix A for the details of the modifications.

Modifications listed above must be incorporated into all production units.

Conditions During Testing

This list is a summary of the conditions noted to the equipment during testing.

Summary of Conditions
None

EQUIPMENT UNDER TEST (EUT)

During testing, numerous configurations may have been utilized. The configurations listed below support compliance to the standard(s) listed in the Summary of Results section.

Configuration 1

Equipment Tested:

Device	Manufacturer	Model #	S/N
Data Concentrator with WiFi, Subgig, and BLE	Venstar, Inc.	DC500	02
Power Supply	NA	MKA-482400500	NA

Support Equipment:

Device	Manufacturer	Model #	S/N
None			

Configuration 2

Equipment Tested:

Device	Manufacturer	Model #	S/N
Data Concentrator with WiFi, Subgig, and BLE	Venstar, Inc.	DC500	07
Power Supply	NA	MKA-482400500	NA

Support Equipment:

Device	Manufacturer	Model #	S/N
None			

General Product Information:

Product Information	Manufacturer-Provided Details
Equipment Type:	Stand-Alone Equipment
Type of Wideband System:	802.15.4g/ Proprietary
Operating Frequency Range:	915MHz
Modulation Type(s):	2-GFSK
Maximum Duty Cycle:	100%
Number of TX Chains:	1
Antenna Type(s) and Gain:	Monopole/2dBi
Beamforming Type:	NA
Antenna Connection Type:	Integral (External connector provided to facilitate testing)
Nominal Input Voltage:	110Vac (output: 24Vac)
Firmware / Software used for Test:	Test mode Firmware 1.0.3 (Conducted), 1.0.4. (Radiated)

EUT and Accessory Photo(s)



Power Supply

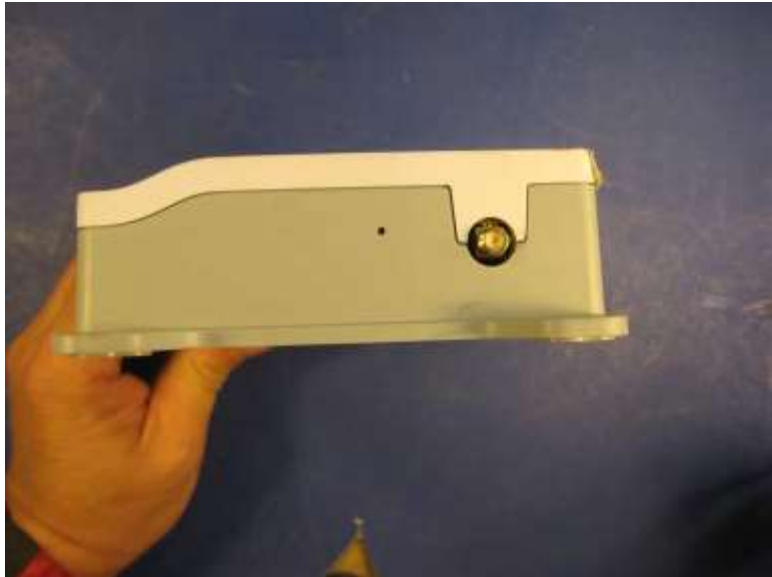

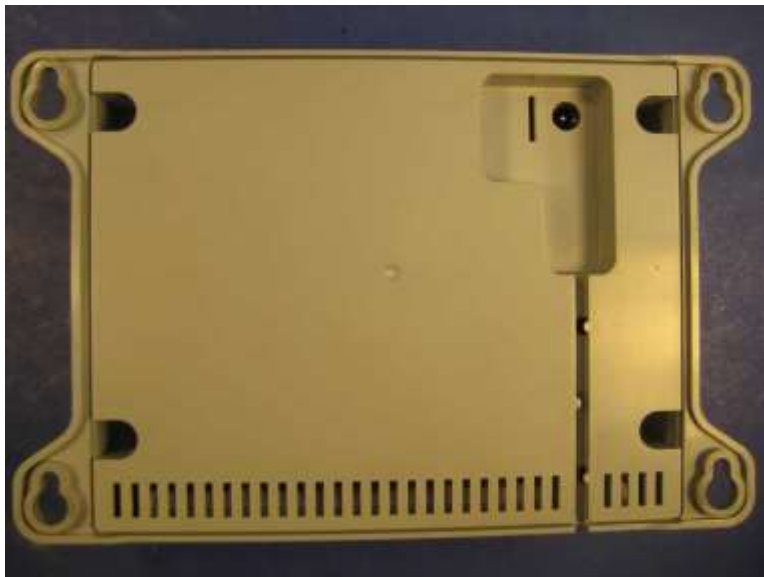

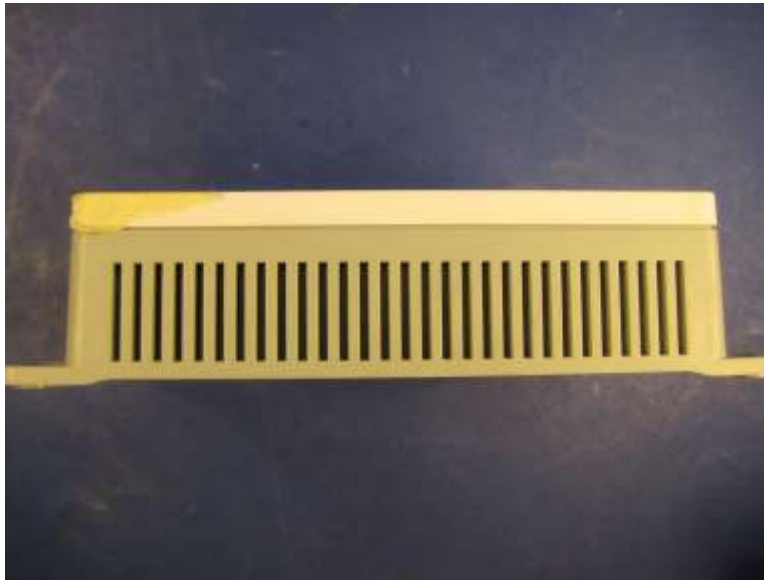

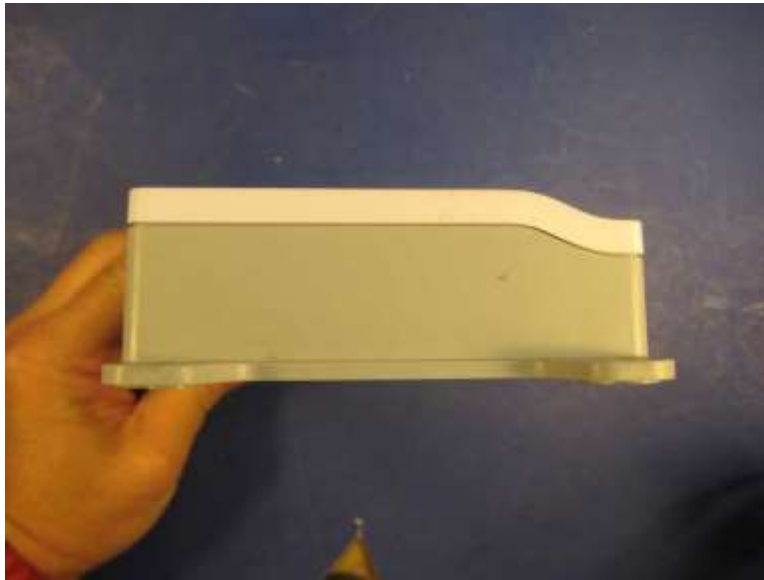

Block Diagram of Test Setup(s)

Test Setup Block Diagram

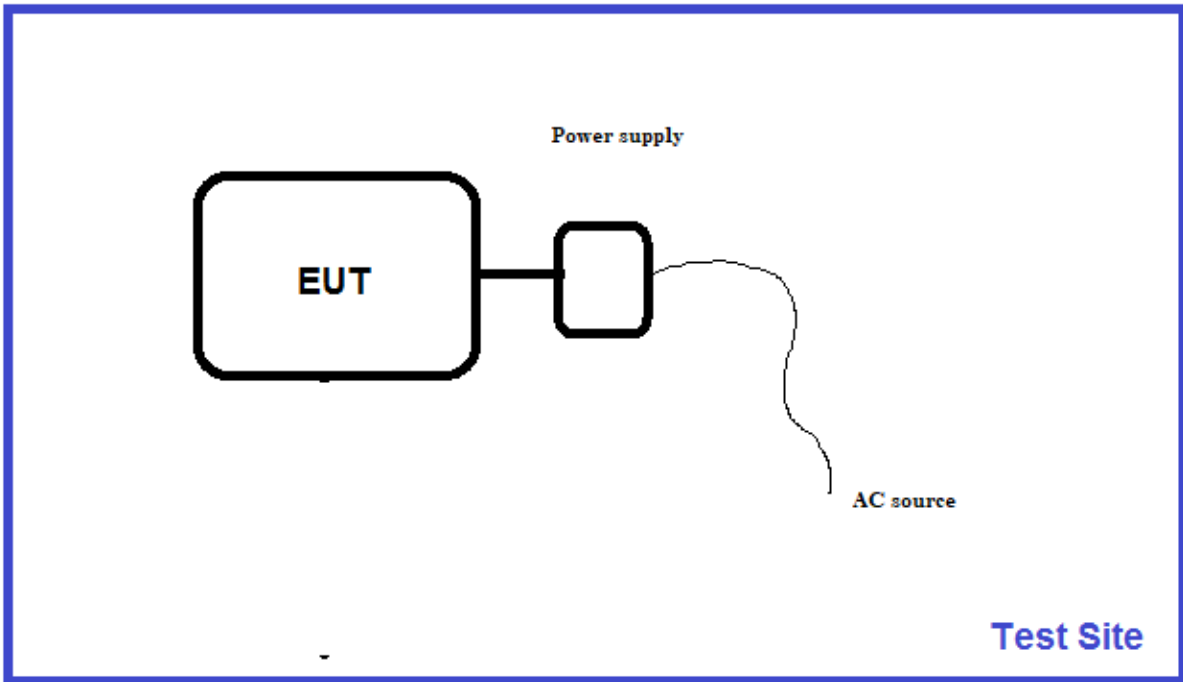

FCC Part 15 Subpart C

15.247(a)(2) 6dB Bandwidth

Test Setup/Conditions			
Test Location:	Brea Lab A	Test Engineer:	Don Nguyen
Test Method:	ANSI C63.10 (2013), KDB 558074 v05r02: 04/02/2019	Test Date(s):	12/11/2020
Configuration:	1		
Test Setup:	EUT is powered from 24Vac AC Adapter. Transmitter is activated to transmit continuously. Operating frequency: 915MHz Frequency of measurement: 915MHz RBW=100kHz, VBW=300kHz		

Environmental Conditions			
Temperature (°C)	20	Relative Humidity (%):	40

Test Equipment					
Asset#	Description	Manufacturer	Model	Cal Date	Cal Due
02869	Spectrum Analyzer	Agilent	E4440	8/3/2020	8/3/2021
03431	Attenuator	Aeroflex/Weinschel	89-20-21	12/20/2019	12/20/2021
P07246	Cable	H&S	32022-29094K- 29094K-24TC	5/29/2020	5/29/2022

Test Data Summary					
Frequency (MHz)	Antenna Port	Modulation	Measured (kHz)	Limit (kHz)	Results
915	1	2-GFSK	568.088	≥500	Pass

Plot(s)

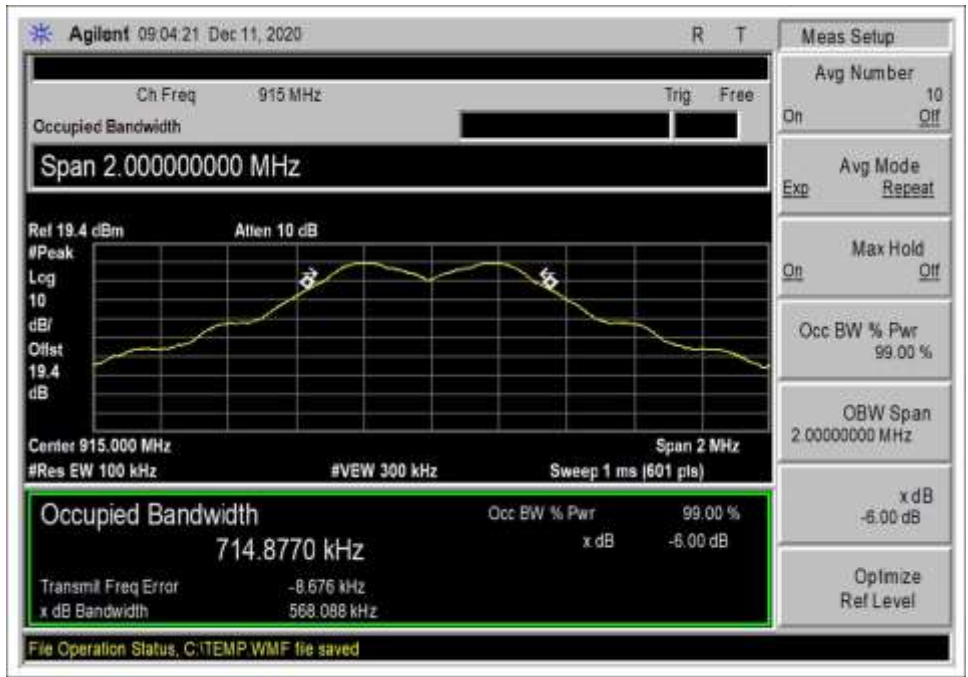

6dB BW 915M

Test Setup Photo(s)

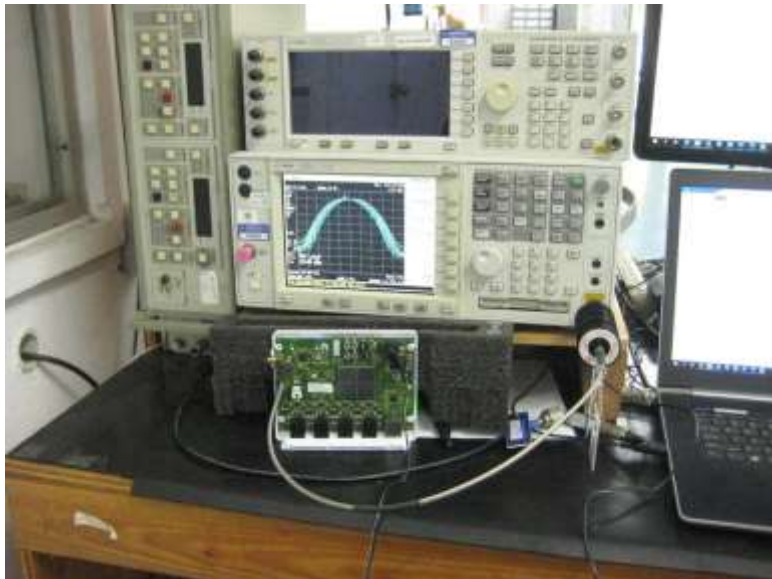

15.247(b)(3) Output Power

Test Setup / Conditions			
Test Location:	Brea Lab A	Test Engineer:	Don Nguyen/Eddie Wong
Test Method:	ANSI C63.10 (2013), KDB 558074 v05r02: 04/02/2019	Test Date(s):	12/11/2020
Configuration:	1		
Test Setup:	EUT is powered from 24Vac AC Adapter. Transmitter is activated to transmit continuously. Operating frequency: 915MHz Frequency of measurement: 915MHz RBW=1MHz, VBW=3MHz		

Environmental Conditions			
Temperature (°C)	20	Relative Humidity (%):	40

Test Equipment					
Asset#	Description	Manufacturer	Model	Cal Date	Cal Due
02869	Spectrum Analyzer	Agilent	E4440	8/3/2020	8/3/2021
03431	Attenuator	Aeroflex/Weinschel	89-20-21	12/20/2019	12/20/2021
P07246	Cable	H&S	32022- 29094K- 29094K-24TC	5/29/2020	5/29/2022

Test Data Summary - Voltage Variations					
Frequency (MHz)	Modulation / Ant Port	V _{Minimum} (dBm)	V _{Nominal} (dBm)	V _{Maximum} (dBm)	Max Deviation from V _{Nominal} (dB)
915	2-GFSK	9.97	9.97	9.97	0

Test performed using operational mode with the highest output power, representing worst case.

Parameter Definitions:

Measurements performed at input voltage V_{Nominal} ± 15%.

Parameter	Value
V _{Minimum} :	93.5
V _{Maximum} :	126.5

Test performed at AC main of the transformer to be sold with the product.

Test Data Summary - RF Conducted Measurement					
Measurement Option: RBW > DTS Bandwidth					
Frequency (MHz)	Modulation	Ant. Type / Gain (dBi)	Measured (dBm)	Limit (dBm)	Results
915	2-GFSK	Monopole/2dBi	9.97	≤30	Pass

Plots

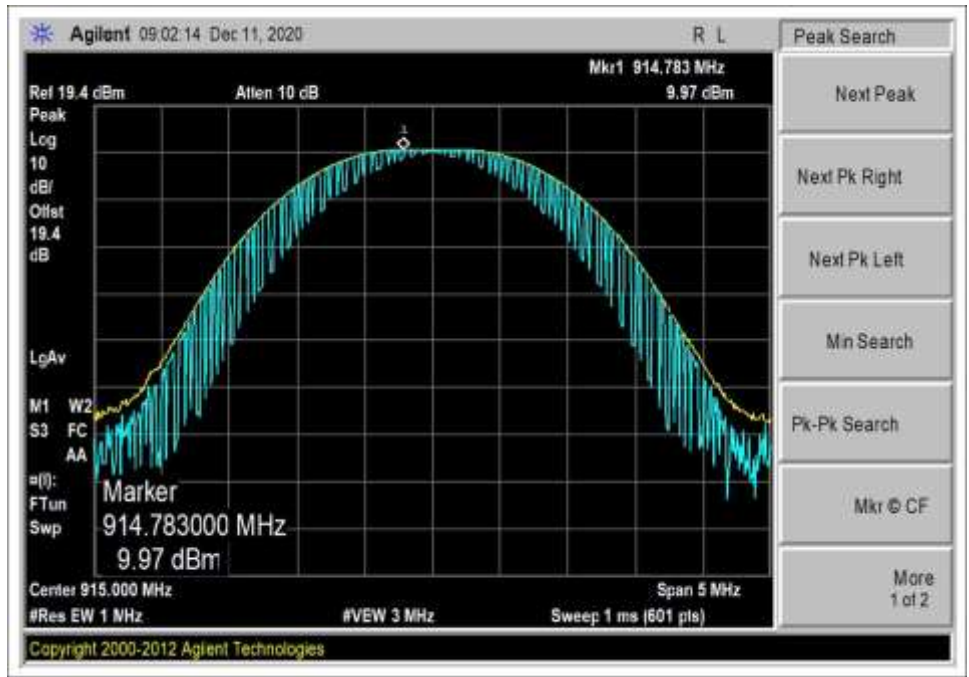

RF PWR 915M

Test Setup / Conditions / Data

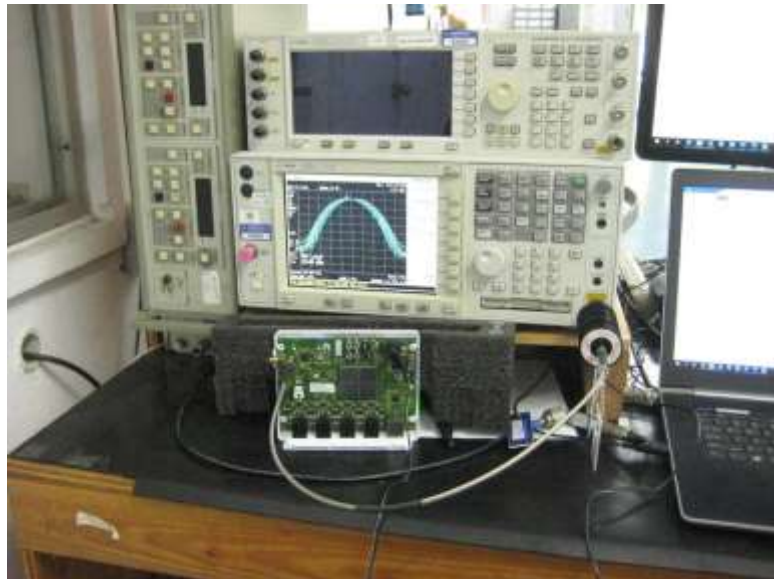

15.247(e) Power Spectral Density

Test Setup / Conditions / Data			
Test Location:	Brea Lab A	Test Engineer:	Don Nguyen
Test Method:	ANSI C63.10 (2013), KDB 558074 v05r02: 04/02/2019	Test Date(s):	12/11/2020
Configuration:	1		
Test Setup:	EUT is powered from 24Vac AC Adapter. Transmitter is activated to transmit continuously. Operating frequency: 915MHz Frequency of measurement: 915MHz RBW=3kHz, VBW=9.1kHz		

Environmental Conditions			
Temperature (°C)	20	Relative Humidity (%):	40

Test Equipment					
Asset#	Description	Manufacturer	Model	Cal Date	Cal Due
02869	Spectrum Analyzer	Agilent	E4440	8/3/2020	8/3/2021
03431	Attenuator	Aeroflex/Weinschel	89-20-21	12/20/2019	12/20/2021
P07246	Cable	H&S	32022-29094K- 29094K-24TC	5/29/2020	5/29/2022

PSD Test Data Summary - RF Conducted Measurement					
Measurement Method: PKPSD					
Frequency (MHz)	Modulation	Ant. Type / Gain (dBi)	Measured (dBm/3kHz)	Limit (dBm/3kHz)	Results
915	GFSK	Monopole/2dBi	1.62	≤8	Pass

Plots

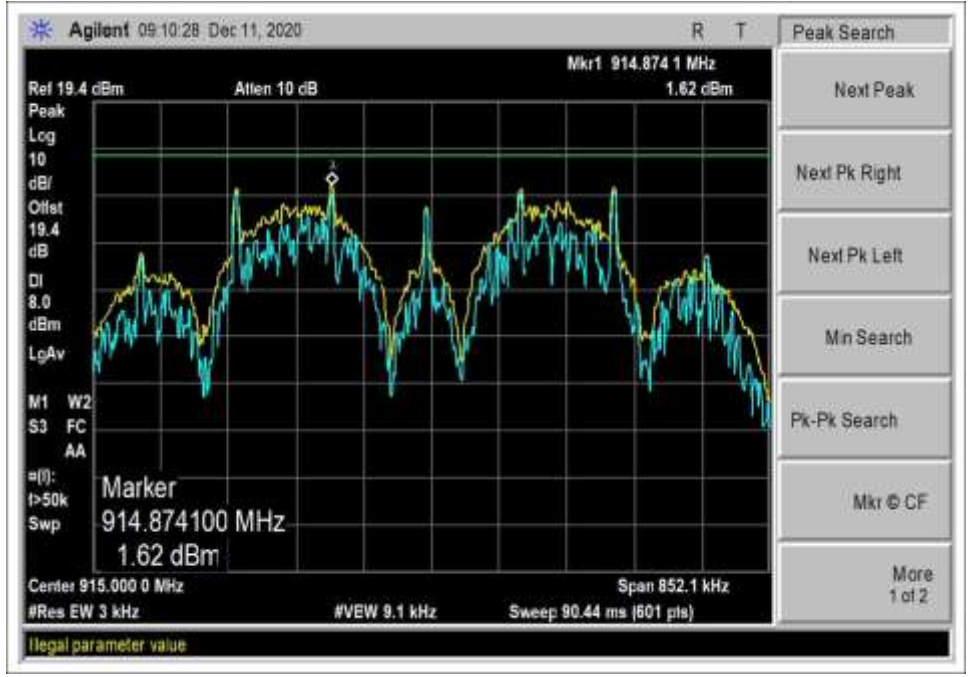

PSD 915M

Test Setup / Conditions / Data

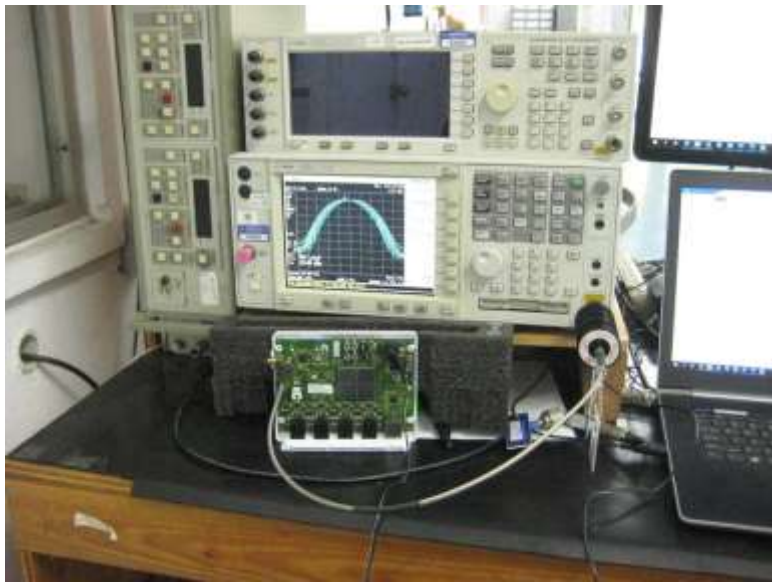

15.247(d) RF Conducted Emissions & Band Edge

Test Setup / Conditions / Data

Test Location: CKC Laboratories Inc. • 110 N. Olinda Pl. • Brea, CA 92823 • 714-993-6112
 Customer: **Venstar, Inc.**
 Specification: **15.247(d) Conducted Spurious Emissions**
 Work Order #: **104502** Date: 12/11/2020
 Test Type: **Conducted Emissions** Time: 09:21:34
 Tested By: Don Nguyen Sequence#: 0
 Software: EMITest 5.03.19 24Vac

Equipment Tested:

Device	Manufacturer	Model #	S/N
Configuration 1			

Support Equipment:

Device	Manufacturer	Model #	S/N
Configuration 1			

Test Conditions / Notes:

EUT is powered from 24Vac AC Adapter.
 Software setting:
 Set PHY: WBDSSS
 Mode: Modulated Signal
 Set TX Power: 11dBm (max)
 Frequency: 915MHz

Frequency of measurement: 9kHz-10GHz
 RBW=100kHz, VBW=300kHz

KDB 558074 v05r02: 04/02/2019

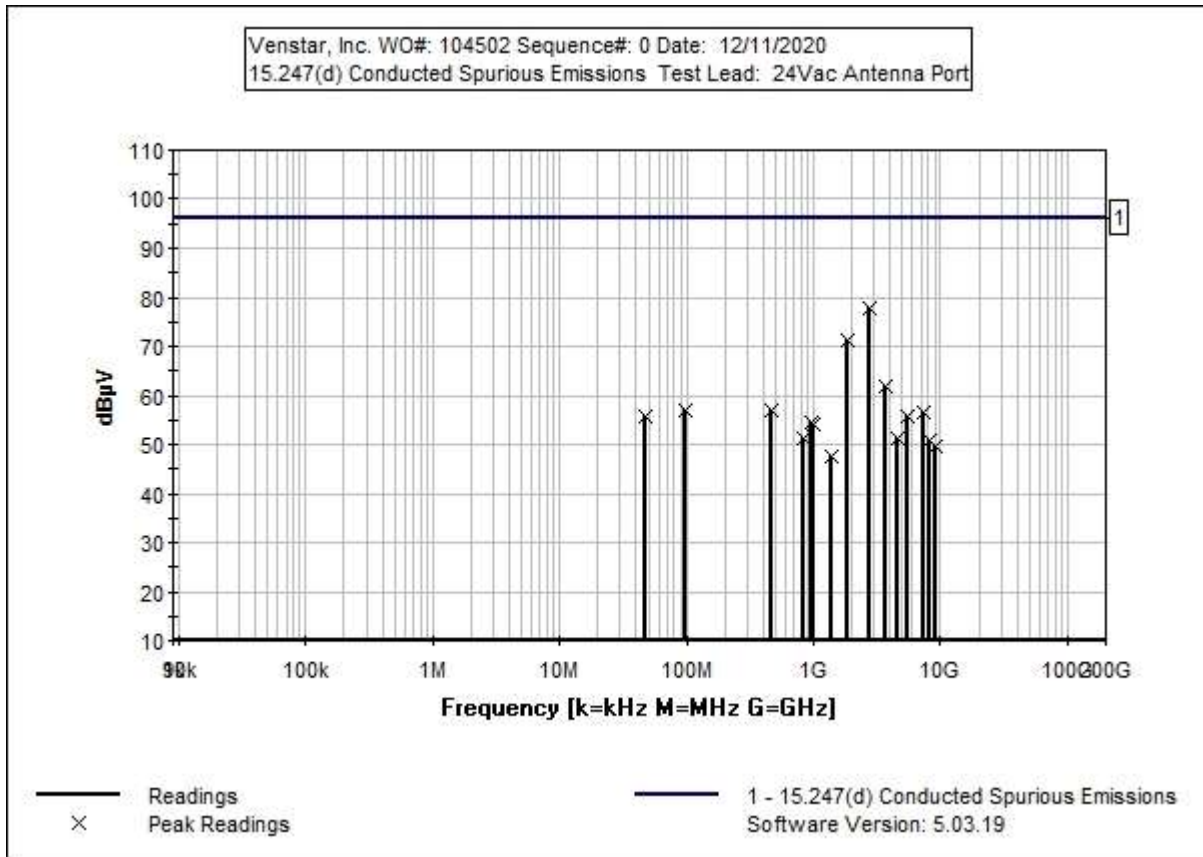

Test Equipment:

ID	Asset #	Description	Model	Calibration Date	Cal Due Date
T1	ANP07246	Cable	32022-29094K-29094K-24TC	5/29/2020	5/29/2022
	AN03643	Spectrum Analyzer	E4440A	5/20/2020	5/20/2022
T2	AN03431	Attenuator	89-20-21	12/20/2019	12/20/2021

Measurement Data:

Reading listed by margin.

Test Lead: Antenna Port

#	Freq MHz	Rdng dB μ V	T1 dB	T2 dB		Dist. Table	Corr dB μ V	Spec dB μ V	Margin dB	Polar Ant
1	2744.400M	58.2	+0.4	+19.2		+0.0	77.8	96.2	-18.4	Anten
2	1829.600M	52.1	+0.4	+18.9		+0.0	71.4	96.2	-24.8	Anten
3	3659.200M	42.0	+0.7	+19.3		+0.0	62.0	96.2	-34.2	Anten
4	457.540M	37.9	+0.1	+19.1		+0.0	57.1	96.2	-39.1	Anten
5	96.040M	37.9	+0.0	+19.0		+0.0	56.9	96.2	-39.3	Anten
6	7321.533M	36.5	+0.8	+19.2		+0.0	56.5	96.2	-39.7	Anten
7	47.960M	36.7	+0.0	+19.0		+0.0	55.7	96.2	-40.5	Anten
8	5488.800M	35.6	+0.7	+19.3		+0.0	55.6	96.2	-40.6	Anten
9	962.880M	35.2	+0.3	+19.1		+0.0	54.6	96.2	-41.6	Anten
10	1011.210M	34.7	+0.3	+19.1		+0.0	54.1	96.2	-42.1	Anten
11	4574.000M	31.1	+0.6	+19.4		+0.0	51.1	96.2	-45.1	Anten
12	819.210M	31.8	+0.2	+19.1		+0.0	51.1	96.2	-45.1	Anten
13	8233.167M	30.5	+0.9	+19.3		+0.0	50.7	96.2	-45.5	Anten
14	9147.933M	29.5	+1.0	+19.2		+0.0	49.7	96.2	-46.5	Anten
15	1372.500M	28.4	+0.3	+19.0		+0.0	47.7	96.2	-48.5	Anten

Band Edge

Band Edge Summary

Limit applied: Max Power/100kHz - 20dB.

Frequency (MHz)	Modulation	Measured (dBm)	Limit (dBm)	Results
902	2-GFSK	-63.52	<-10.8	Pass
928	2-GFSK	-63.69	<-10.8	Pass

Band Edge Plots

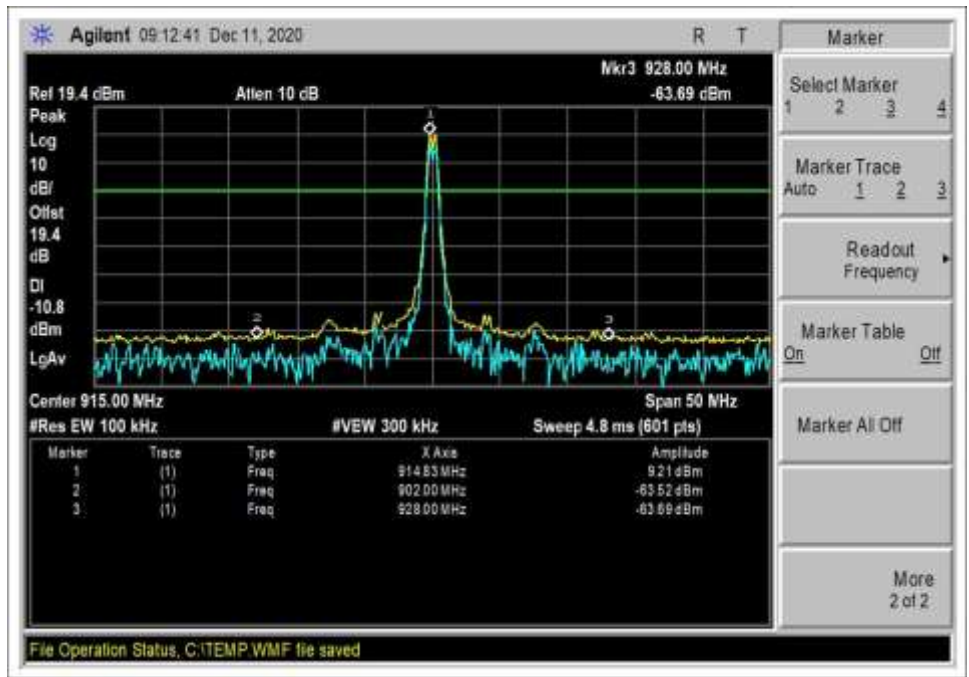

Test Setup Photo(s)

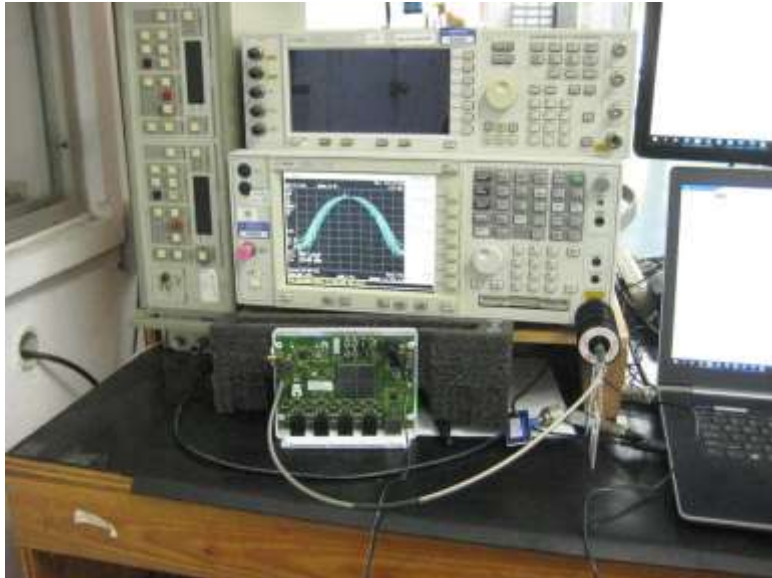

15.247(d) Radiated Emissions & Band Edge

Test Setup / Conditions / Data

Test Location: CKC Laboratories Inc. • 110 N. Olinda Pl. • Brea, CA 92823 • 714-993-6112
 Customer: **Venstar, Inc.**
 Specification: **15.247(d) / 15.209 Radiated Spurious Emissions**
 Work Order #: **104502** Date: 1/12/2021
 Test Type: **Radiated Scan** Time: 10:25:59
 Tested By: E. Wong Sequence#: 5
 Software: EMITest 5.03.19

Equipment Tested:

Device	Manufacturer	Model #	S/N
Configuration 2			

Support Equipment:

Device	Manufacturer	Model #	S/N
Configuration 2			

Test Conditions / Notes:

The EUT is placed on the Styrofoam platform, set in intended orientation. 5 UTP are connected to the Ethernet port.
 Software setting:
 Set Mode: Transmit

 power setting: 11dBm
 Modulation: 2-GFSK

 Frequency: 915MHz

 Frequency range of measurement = 9 kHz- 10GHz.
 9kHz -150 kHz; RBW=200 Hz, VBW=200 Hz; 150 kHz-30 MHz; RBW=9 kHz, VBW=9 kHz; 30 MHz-1000 MHz;
 RBW=120 kHz, VBW=120 kHz, 1000 MHz-10000 MHz; RBW=1 MHz, VBW=1MHz.

 Test environment conditions:
 Temperature: 17°C
 Relative Humidity: 39%
 Atmospheric Pressure: 100kPa

 Upright and lay flat orientation investigation, data represent worst case (up right)
 Site D
 ANSI C63.10-2013, KDB 558074 v05r02: 04/02/2019

Venstar, Inc. WO#: 104502 Sequence#: 5 Date: 1/12/2021
 15.247(d) / 15.209 Radiated Spurious Emissions Test Distance: 3 Meters Vert

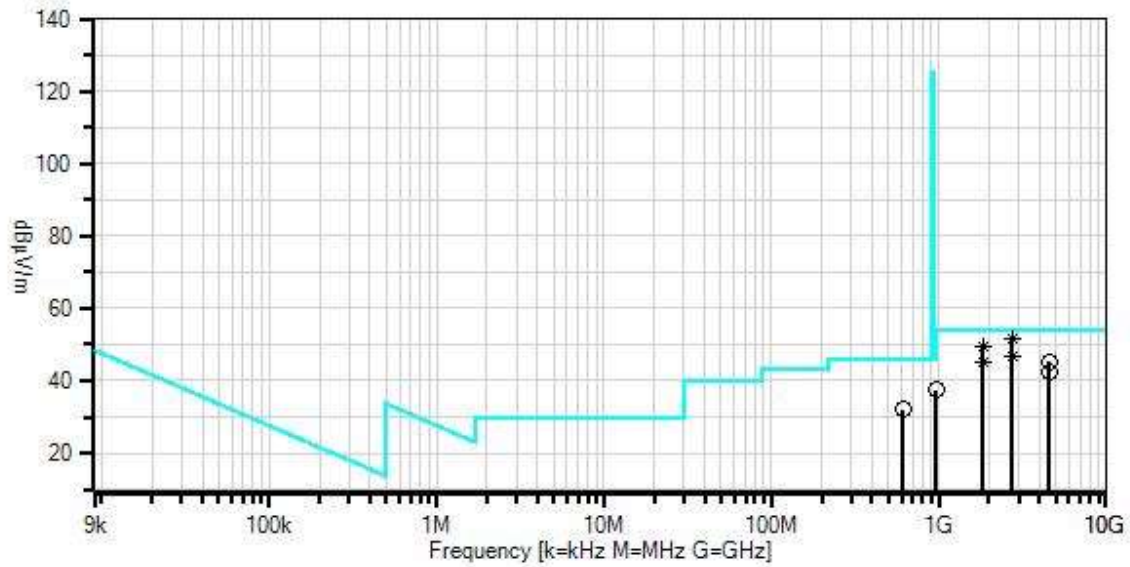

- Readings
 - × QP Readings
 - ▼ Ambient
 - Peak Readings
 - * Average Readings
- 1 - 15.247(d) / 15.209 Radiated Spurious Emissions
- Software Version: 5.03.19

Test Equipment:

ID	Asset #	Description	Model	Calibration Date	Cal Due Date
T1	AN03643	Spectrum Analyzer	E4440A	5/20/2020	5/20/2022
	AN02869	Spectrum Analyzer	E4440A	8/3/2020	8/3/2021
T2	AN01646	Horn Antenna	3115	3/17/2020	3/17/2022
T3	ANP07656	Cable	32022-29094K- 29094K-24TC	7/30/2020	7/30/2022
T4	AN00787	Preamp	83017A	5/31/2019	5/31/2021
T5	ANP07138	Cable	ANDL1- PNMNM-60	3/4/2019	3/4/2021
T6	ANP04382	Cable	LDF-50	5/15/2020	5/15/2022
T7	AN02749	High Pass Filter	95H10- 1000/T10000- O/O	7/15/2019	7/15/2021
T8	AN01994	Biconilog Antenna	CBL6111C	4/14/2020	4/14/2022
T9	ANP05283	Attenuator	ATT-0218-06- NNN-02	3/26/2020	3/26/2022
T10	ANP05569	Cable-Amplitude +15C to +45C (dB)	RG-214/U	12/14/2020	12/14/2022
T11	AN00010	Preamp	8447D	1/2/2020	1/2/2022
T12	ANP06978	Cable	Sucoflex 104A	3/26/2020	3/26/2022
	AN03470	Spectrum Analyzer	E4440A	5/2/2019	5/2/2021
	AN00314	Loop Antenna	6502	4/13/2020	4/13/2022

Measurement Data:

Reading listed by margin.

Test Distance: 3 Meters

#	Freq	Rdng	T1	T2	T3	T4	Dist.	Corr	Spec	Margin	Polar
			T5	T6	T7	T8					
	MHz	dB μ V	T9	T10	T11	T12	Table	dB μ V/m	dB μ V/m	dB	Ant
1	2745.683M	50.2	+0.0	+29.3	+0.5	-40.0	+0.0	51.3	54.0	-2.7	Vert
	Ave		+4.4	+6.0	+0.9	+0.0					
			+0.0	+0.0	+0.0	+0.0					
^	2745.683M	57.6	+0.0	+29.3	+0.5	-40.0	+0.0	58.7	54.0	+4.7	Vert
			+4.4	+6.0	+0.9	+0.0					
			+0.0	+0.0	+0.0	+0.0					
3	1830.333M	53.2	+0.0	+26.8	+0.4	-39.8	+0.0	49.3	54.0	-4.7	Horiz
	Ave		+3.3	+5.0	+0.4	+0.0					
			+0.0	+0.0	+0.0	+0.0					
^	1830.333M	58.9	+0.0	+26.8	+0.4	-39.8	+0.0	55.0	54.0	+1.0	Horiz
			+3.3	+5.0	+0.4	+0.0					
			+0.0	+0.0	+0.0	+0.0					
5	2745.533M	45.7	+0.0	+29.3	+0.5	-40.0	+0.0	46.8	54.0	-7.2	Horiz
	Ave		+4.4	+6.0	+0.9	+0.0					
			+0.0	+0.0	+0.0	+0.0					
^	2745.533M	53.2	+0.0	+29.3	+0.5	-40.0	+0.0	54.3	54.0	+0.3	Horiz
			+4.4	+6.0	+0.9	+0.0					
			+0.0	+0.0	+0.0	+0.0					

7	4576.020M	37.4	+0.0	+32.8	+0.6	-39.8	+0.0	45.2	54.0	-8.8	Vert
			+5.7	+8.2	+0.3	+0.0					
			+0.0	+0.0	+0.0	+0.0					
8	1830.517M	48.8	+0.0	+26.8	+0.4	-39.8	+0.0	44.9	54.0	-9.1	Vert
	Ave		+3.3	+5.0	+0.4	+0.0					
			+0.0	+0.0	+0.0	+0.0					
^	1830.517M	56.2	+0.0	+26.8	+0.4	-39.8	+0.0	52.3	54.0	-1.7	Vert
			+3.3	+5.0	+0.4	+0.0					
			+0.0	+0.0	+0.0	+0.0					
10	4575.870M	34.8	+0.0	+32.8	+0.6	-39.8	+0.0	42.6	54.0	-11.4	Horiz
			+5.7	+8.2	+0.3	+0.0					
			+0.0	+0.0	+0.0	+0.0					
11	614.000M	28.5	+0.0	+0.0	+0.0	+0.0	+0.0	32.0	46.0	-14.0	Vert
			+0.0	+2.8	+0.0	+19.9			bandedge		
			+5.8	+2.8	-28.0	+0.2					
12	960.000M	27.9	+0.0	+0.0	+0.0	+0.0	+0.0	37.5	54.0	-16.5	Vert
			+0.0	+3.5	+0.0	+23.6			bandedge		
			+5.9	+3.7	-27.4	+0.3					

Band Edge

Band Edge Summary

Frequency (MHz)	Modulation	Ant. Type	Field Strength (dBuV/m @3m)	Limit (dBuV/m @3m)	Results
614	2-GFSK	Monopole 2dBi	36.4	<46	Pass
902	2-GFSK	Monopole 2dBi	34.0	< 80.4	Pass
928	2-GFSK	Monopole 2dBi	35.5	< 80.4	Pass
960	2-GFSK	Monopole 2dBi	36.3	<54	Pass

Band Edge Plots

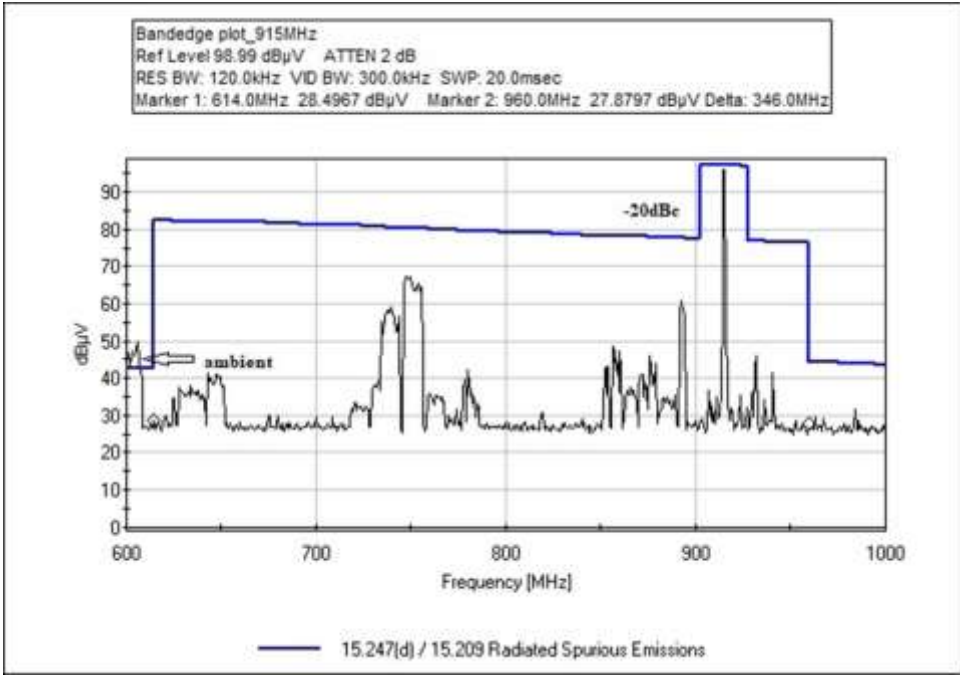

Test Setup Photo(s)



Below 1GHz

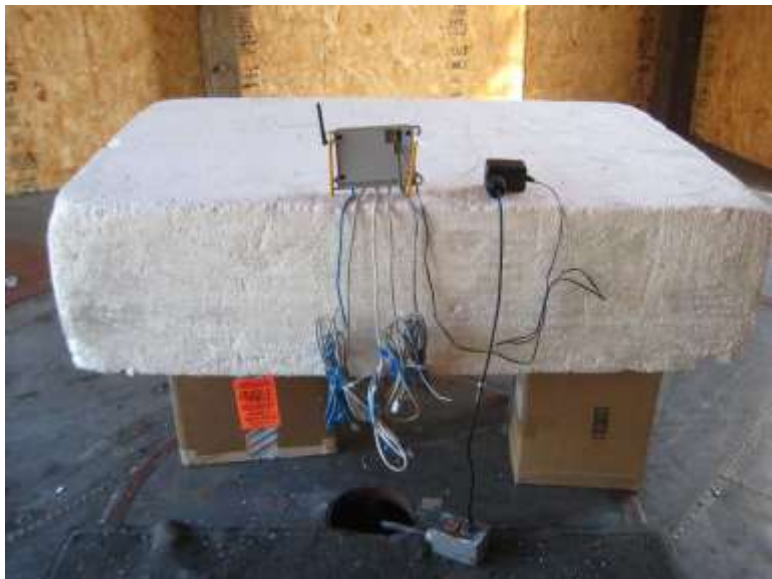

Below 1GHz



Above 1GHz

15.207 AC Conducted Emissions

Test Setup / Conditions / Data

Test Location: CKC Laboratories Inc. • 110 N. Olinda Pl. • Brea, CA 92823 • 714-993-6112
 Customer: **Venstar, Inc.**
 Specification: **15.207 AC Mains - Average**
 Work Order #: **104502** Date: 1/6/2021
 Test Type: **Conducted Emissions** Time: 4:22:19 PM
 Tested By: E. Wong Sequence#: 6
 Software: EMITest 5.03.19 110/60Hz

Equipment Tested:

Device	Manufacturer	Model #	S/N
Configuration 2			

Support Equipment:

Device	Manufacturer	Model #	S/N
Configuration 2			

Test Conditions / Notes:

The EUT is placed on the table, 5 Ethernet cables are connected to the Ethernet ports.
 Software setting:
 Set Mode: Transmit
 Power setting: 11dBm
 Modulation: GFSK (WBDSSS)

 Frequency: 915MHz

 Frequency range of measurement = 150kHz- 30MHz.
 150 kHz-30 MHz; RBW=9 kHz, VBW=30kHz
 Test environment conditions:
 Temperature: 27°C
 Relative Humidity: 29%
 Atmospheric Pressure: 100kPa
 KDB 558074 v05r02: 04/02/2019

Venstar, Inc. WO#: 104502 Sequence#: 6 Date: 1/6/2021
 15.207 AC Mains - Average Test Lead: 110/60Hz L1-Line

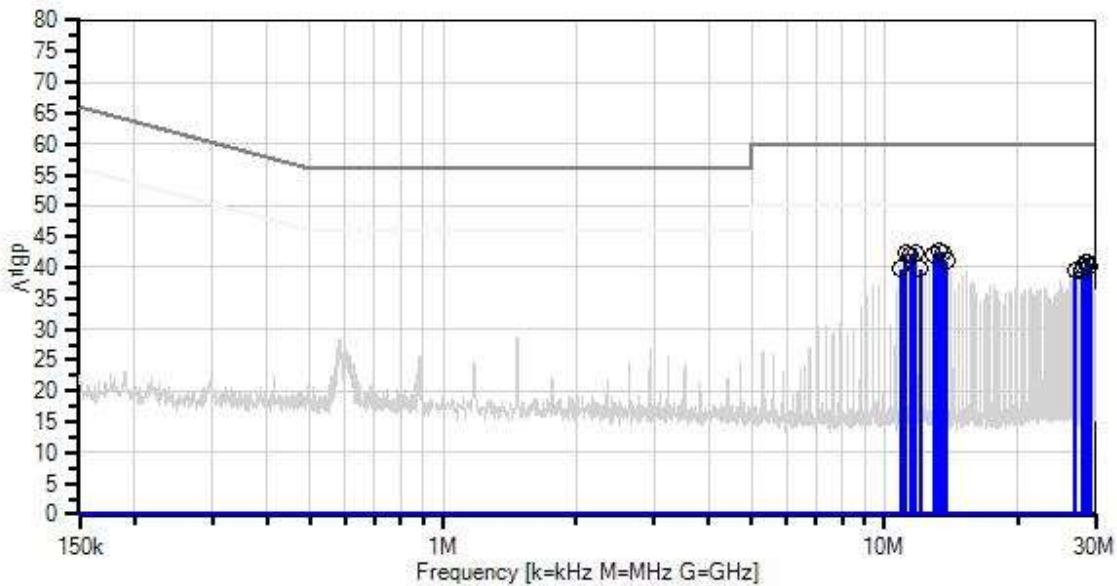

— Sweep Data
 × QP Readings
 Software Version: 5.03.19
 — Readings
 * Average Readings
 ○ Peak Readings
 ▼ Ambient
 — 1 - 15.207 AC Mains - Average
 — 2 - 15.207 AC Mains - Quasi-peak

Test Equipment:

ID	Asset #	Description	Model	Calibration Date	Cal Due Date
	AN02869	Spectrum Analyzer	E4440A	8/3/2020	8/3/2021
T1	ANP07545	Attenuator	SA18N10W-06	1/18/2019	1/18/2021
T2	ANP07338	Cable	2249-Y-240	12/24/2019	12/24/2021
T3	AN02610	High Pass Filter	HE9615-150K-50-720B	10/22/2019	10/22/2021
T4	ANP07738	Cable-Line L1(dB)	90cm-extcord	12/9/2020	12/9/2022
	ANP07738	Cable-Neutral L2(dB)	90cm-extcord	12/9/2020	12/9/2022
T5	AN00847.1	50uH LISN-(L) Line 1	3816/2NM	3/10/2020	3/10/2021
	AN00847.1	50uH LISN-(N) Line 2	3816/2NM	3/10/2020	3/10/2021

Measurement Data:

Reading listed by margin.

Test Lead: L1-Line

#	Freq MHz	Rdng dB μ V	T1 T5 dB	T2 dB	T3 dB	T4 dB	Dist. Table	Corr dB μ V	Spec dB μ V	Margin dB	Polar Ant
1	13.238M	35.6	+5.8 +0.1	+0.3	+0.2	+0.6	+0.0	42.6	50.0	-7.4	L1-Li
2	13.535M	35.5	+5.8 +0.1	+0.3	+0.2	+0.6	+0.0	42.5	50.0	-7.5	L1-Li
3	11.770M	35.5	+5.8 +0.1	+0.3	+0.2	+0.5	+0.0	42.4	50.0	-7.6	L1-Li
4	11.175M	35.4	+5.8 +0.1	+0.3	+0.2	+0.5	+0.0	42.3	50.0	-7.7	L1-Li
5	11.472M	35.2	+5.8 +0.1	+0.3	+0.2	+0.5	+0.0	42.1	50.0	-7.9	L1-Li
6	12.941M	35.1	+5.8 +0.1	+0.3	+0.2	+0.5	+0.0	42.0	50.0	-8.0	L1-Li
7	13.824M	34.0	+5.8 +0.1	+0.3	+0.2	+0.6	+0.0	41.0	50.0	-9.0	L1-Li
8	28.534M	33.3	+5.8 +0.2	+0.5	+0.2	+0.9	+0.0	40.9	50.0	-9.1	L1-Li
9	28.828M	33.2	+5.8 +0.2	+0.5	+0.2	+0.9	+0.0	40.8	50.0	-9.2	L1-Li
10	29.123M	32.4	+5.8 +0.2	+0.5	+0.2	+1.0	+0.0	40.1	50.0	-9.9	L1-Li
11	28.239M	32.4	+5.8 +0.2	+0.5	+0.2	+0.9	+0.0	40.0	50.0	-10.0	L1-Li
12	10.887M	32.9	+5.8 +0.2	+0.3	+0.2	+0.4	+0.0	39.8	50.0	-10.2	L1-Li
13	12.058M	32.8	+5.8 +0.1	+0.3	+0.2	+0.5	+0.0	39.7	50.0	-10.3	L1-Li
14	27.951M	32.0	+5.8 +0.2	+0.5	+0.2	+0.9	+0.0	39.6	50.0	-10.4	L1-Li
15	27.067M	32.0	+5.8 +0.2	+0.4	+0.2	+0.9	+0.0	39.5	50.0	-10.5	L1-Li



Test Location: CKC Laboratories Inc. • 110 N. Olinda Pl. • Brea, CA 92823 • 714-993-6112
 Customer: **Venstar, Inc.**
 Specification: **15.207 AC Mains - Average**
 Work Order #: **104502** Date: 1/6/2021
 Test Type: **Conducted Emissions** Time: 4:17:57 PM
 Tested By: E. Wong Sequence#: 5
 Software: EMITest 5.03.19 110/60Hz

Equipment Tested:

Device	Manufacturer	Model #	S/N
Configuration 2			

Support Equipment:

Device	Manufacturer	Model #	S/N
Configuration 2			

Test Conditions / Notes:

The EUT is placed on the table, 5 Ethernet cables are connected to the Ethernet ports.
 Software setting:
 Set Mode: Transmit
 Power setting: 11dBm
 Modulation: GFSK (WBDSSS)

 Frequency: 915MHz

 Frequency range of measurement = 150kHz- 30MHz.
 150 kHz-30 MHz; RBW=9 kHz, VBW=30kHz
 Test environment conditions:
 Temperature: 27°C
 Relative Humidity: 29%
 Atmospheric Pressure: 100kPa
 KDB 558074 v05r02: 04/02/2019

Venstar, Inc. WO#: 104502 Sequence#: 5 Date: 1/6/2021
 15.207 AC Mains - Average Test Lead: 110/60Hz L2-Neutral

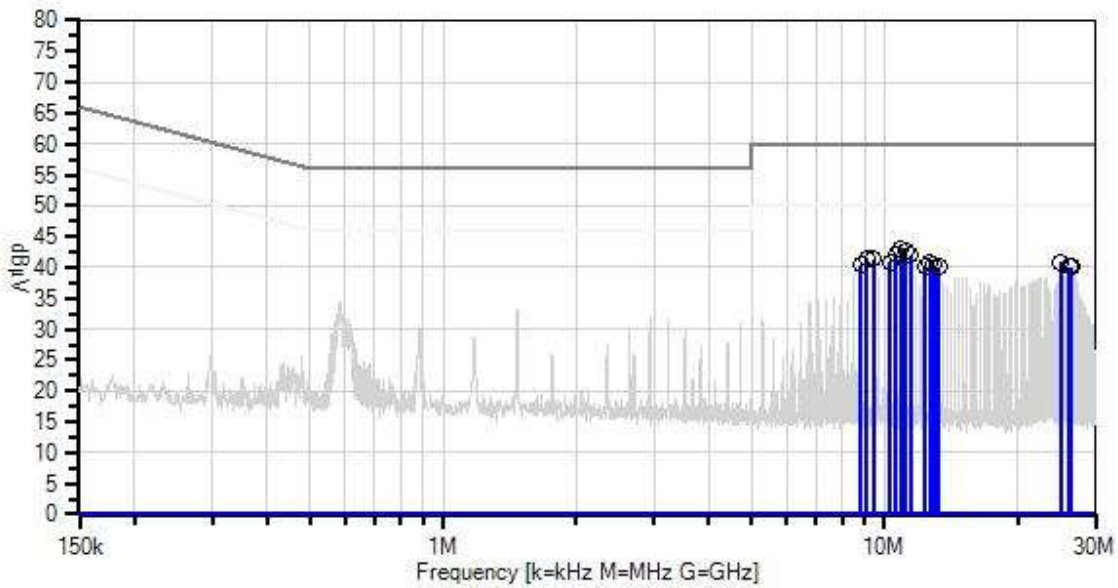

— Sweep Data
 × QP Readings
 Software Version: 5.03.19
 — Readings
 * Average Readings
 — 1 - 15.207 AC Mains - Average
 ○ Peak Readings
 ▼ Ambient
 — 2 - 15.207 AC Mains - Quasi-peak

Test Equipment:

ID	Asset #	Description	Model	Calibration Date	Cal Due Date
	AN02869	Spectrum Analyzer	E4440A	8/3/2020	8/3/2021
T1	ANP07545	Attenuator	SA18N10W-06	1/18/2019	1/18/2021
T2	ANP07338	Cable	2249-Y-240	12/24/2019	12/24/2021
T3	AN02610	High Pass Filter	HE9615-150K-50-720B	10/22/2019	10/22/2021
	ANP07738	Cable-Line L1(dB)	90cm-extcord	12/9/2020	12/9/2022
T4	ANP07738	Cable-Neutral L2(dB)	90cm-extcord	12/9/2020	12/9/2022
	AN00847.1	50uH LISN-(L) Line 1	3816/2NM	3/10/2020	3/10/2021
T5	AN00847.1	50uH LISN-(N) Line 2	3816/2NM	3/10/2020	3/10/2021

Measurement Data:

Reading listed by margin.

Test Lead: L2-Neutral

#	Freq MHz	Rdng dB μ V	T1 T5 dB	T2 dB	T3 dB	T4 dB	Dist. Table	Corr dB μ V	Spec dB μ V	Margin dB	Polar Ant
1	10.887M	36.2	+5.8 +0.2	+0.3	+0.2	+0.4	+0.0	43.1	50.0	-6.9	L2-Ne
2	11.184M	35.9	+5.8 +0.2	+0.3	+0.2	+0.4	+0.0	42.8	50.0	-7.2	L2-Ne
3	10.589M	35.2	+5.8 +0.2	+0.3	+0.2	+0.4	+0.0	42.1	50.0	-7.9	L2-Ne
4	11.472M	35.0	+5.8 +0.2	+0.3	+0.2	+0.4	+0.0	41.9	50.0	-8.1	L2-Ne
5	9.121M	34.4	+5.8 +0.2	+0.3	+0.2	+0.4	+0.0	41.3	50.0	-8.7	L2-Ne
6	9.418M	34.4	+5.8 +0.2	+0.3	+0.2	+0.4	+0.0	41.3	50.0	-8.7	L2-Ne
7	24.998M	33.3	+5.8 +0.3	+0.4	+0.2	+0.9	+0.0	40.9	50.0	-9.1	L2-Ne
8	12.652M	33.9	+5.8 +0.2	+0.3	+0.2	+0.4	+0.0	40.8	50.0	-9.2	L2-Ne
9	10.292M	33.9	+5.8 +0.2	+0.3	+0.2	+0.4	+0.0	40.8	50.0	-9.2	L2-Ne
10	8.824M	33.8	+5.8 +0.1	+0.3	+0.1	+0.3	+0.0	40.4	50.0	-9.6	L2-Ne
11	12.941M	33.5	+5.8 +0.2	+0.3	+0.2	+0.4	+0.0	40.4	50.0	-9.6	L2-Ne
12	13.238M	33.1	+5.8 +0.2	+0.3	+0.2	+0.5	+0.0	40.1	50.0	-9.9	L2-Ne
13	26.471M	32.5	+5.8 +0.3	+0.4	+0.2	+0.9	+0.0	40.1	50.0	-9.9	L2-Ne
14	12.355M	33.1	+5.8 +0.2	+0.3	+0.2	+0.4	+0.0	40.0	50.0	-10.0	L2-Ne
15	26.183M	32.4	+5.8 +0.3	+0.4	+0.2	+0.9	+0.0	40.0	50.0	-10.0	L2-Ne

Test Setup Photo(s)



Appendix A: Modification



Mod 1 = Copper tape added to LCD display ribbon cable to suppress radiated emission below 1 GHz.

SUPPLEMENTAL INFORMATION

Measurement Uncertainty

Uncertainty Value	Parameter
4.73 dB	Radiated Emissions
3.34 dB	Mains Conducted Emissions
3.30 dB	Disturbance Power

Uncertainties reported are worst case for all CKC Laboratories’ sites and represent expanded uncertainties expressed at approximately the 95% confidence level using a coverage factor of k=2. Compliance is deemed to occur provided measurements are below the specified limits.

Emissions Test Details

TESTING PARAMETERS

Unless otherwise indicated, the following configuration parameters are used for equipment setup: The cables were routed consistent with the typical application by varying the configuration of the test sample. Interface cables were connected to the available ports of the test unit. The effect of varying the position of the cables was investigated to find the configuration that produced maximum emissions. Cables were of the type and length specified in the individual requirements. The length of cable that produced maximum emissions was selected.

The equipment under test (EUT) was set up in a manner that represented its normal use, as shown in the setup photographs. Any special conditions required for the EUT to operate normally are identified in the comments that accompany the emissions tables.

The emissions data was taken with a spectrum analyzer or receiver. Incorporating the applicable correction factors for distance, antenna, cable loss and amplifier gain, the data was reduced as shown in the table below. The corrected data was then compared to the applicable emission limits. Preliminary and final measurements were taken in order to ensure that all emissions from the EUT were found and maximized.

CORRECTION FACTORS

The basic spectrum analyzer reading was converted using correction factors as shown in the highest emissions readings in the tables. For radiated emissions in dBµV/m, the spectrum analyzer reading in dBµV was corrected by using the following formula. This reading was then compared to the applicable specification limit. Individual measurements were compared with the displayed limit value in the margin column. The margin was calculated based on subtracting the limit value from the corrected measurement value; a positive margin represents a measurement exceeding the limit, while a negative margin represents a measurement less than the limit.

SAMPLE CALCULATIONS		
	Meter reading	(dBµV)
+	Antenna Factor	(dB/m)
+	Cable Loss	(dB)
-	Distance Correction	(dB)
-	Preamplifier Gain	(dB)
=	Corrected Reading	(dBµV/m)

TEST INSTRUMENTATION AND ANALYZER SETTINGS

The test instrumentation and equipment listed were used to collect the emissions data. A spectrum analyzer or receiver was used for all measurements. Unless otherwise specified, the following table shows the measuring equipment bandwidth settings that were used in designated frequency bands. For testing emissions, an appropriate reference level and a vertical scale size of 10 dB per division were used.

MEASURING EQUIPMENT BANDWIDTH SETTINGS PER FREQUENCY RANGE			
TEST	BEGINNING FREQUENCY	ENDING FREQUENCY	BANDWIDTH SETTING
CONDUCTED EMISSIONS	150 kHz	30 MHz	9 kHz
RADIATED EMISSIONS	9 kHz	150 kHz	200 Hz
RADIATED EMISSIONS	150 kHz	30 MHz	9 kHz
RADIATED EMISSIONS	30 MHz	1000 MHz	120 kHz
RADIATED EMISSIONS	1000 MHz	>1 GHz	1 MHz

SPECTRUM ANALYZER/RECEIVER DETECTOR FUNCTIONS

The notes that accompany the measurements contained in the emissions tables indicate the type of detector function used to obtain the given readings. Unless otherwise noted, all readings were made in the "positive peak" detector mode. Whenever a "quasi-peak" or "average" reading was recorded, the measurement was annotated with a "QP" or an "Ave" on the appropriate rows of the data sheets. In cases where quasi-peak or average limits were employed and data exists for multiple measurement types for the same frequency then the peak measurement was retained in the report for reference, however the numbering for the affected row was removed and an arrow or caret ("^") was placed in the far left-hand column indicating that the row above takes precedence for comparison to the limit. The following paragraphs describe in more detail the detector functions and when they were used to obtain the emissions data.

Peak

In this mode, the spectrum analyzer or receiver recorded all emissions at their peak value as the frequency band selected was scanned. By combining this function with another feature called "peak hold," the measurement device had the ability to measure intermittent or low duty cycle transient emission peak levels. In this mode the measuring device made a slow scan across the frequency band selected and measured the peak emission value found at each frequency across the band.

Quasi-Peak

Quasi-peak measurements were taken using the quasi-peak detector when the true peak values exceeded or were within 2 dB of a quasi-peak specification limit. Additional QP measurements may have been taken at the discretion of the operator.

Average

Average measurements were taken using the average detector when the true peak values exceeded or were within 2 dB of an average specification limit. Additional average measurements may have been taken at the discretion of the operator. If the specification or test procedure requires trace averaging, then the averaging was performed using 100 samples or as required by the specification. All other average measurements are performed using video bandwidth averaging. To make these measurements, the test engineer reduces the video bandwidth on the measuring device until the modulation of the signal is filtered out. At this point, the measuring device is set into the linear mode and the scan time is reduced.