



Appendix A. SAR Plots of System Verification

The plots for system verification with largest deviation for each SAR system combination are shown as follows.

System Check_B2450_131106

DUT: Dipole 2450 MHz; Type: D2450V2; SN: 737

Communication System: CW; Frequency: 2450 MHz; Duty Cycle: 1:1

Medium: B2450_1106 Medium parameters used: $f = 2450$ MHz; $\sigma = 1.972$ S/m; $\epsilon_r = 51.262$; $\rho = 1000$ kg/m³

Ambient Temperature : 21.7 °C; Liquid Temperature : 20.5 °C

DASY5 Configuration:

- Probe: EX3DV4 - SN3820; ConvF(6.84, 6.84, 6.84); Calibrated: 2012/12/10;
- Sensor-Surface: 2mm (Mechanical Surface Detection)
- Electronics: DAE3 Sn579; Calibrated: 2013/04/24
- Phantom: ELI 4.0; Type: QDOVA001BA; Serial: TP:1206
- Measurement SW: DASY52, Version 52.8 (7); SEMCAD X Version 14.6.10 (7164)

Pin=250mW/Area Scan (81x81x1): Interpolated grid: dx=1.200 mm, dy=1.200 mm

Maximum value of SAR (interpolated) = 19.5 W/kg

Pin=250mW/Zoom Scan (7x7x7)/Cube 0: Measurement grid: dx=5mm, dy=5mm, dz=5mm

Reference Value = 99.768 V/m; Power Drift = 0.04 dB

Peak SAR (extrapolated) = 26.0 W/kg

SAR(1 g) = 12.7 W/kg; SAR(10 g) = 5.89 W/kg

Maximum value of SAR (measured) = 19.3 W/kg

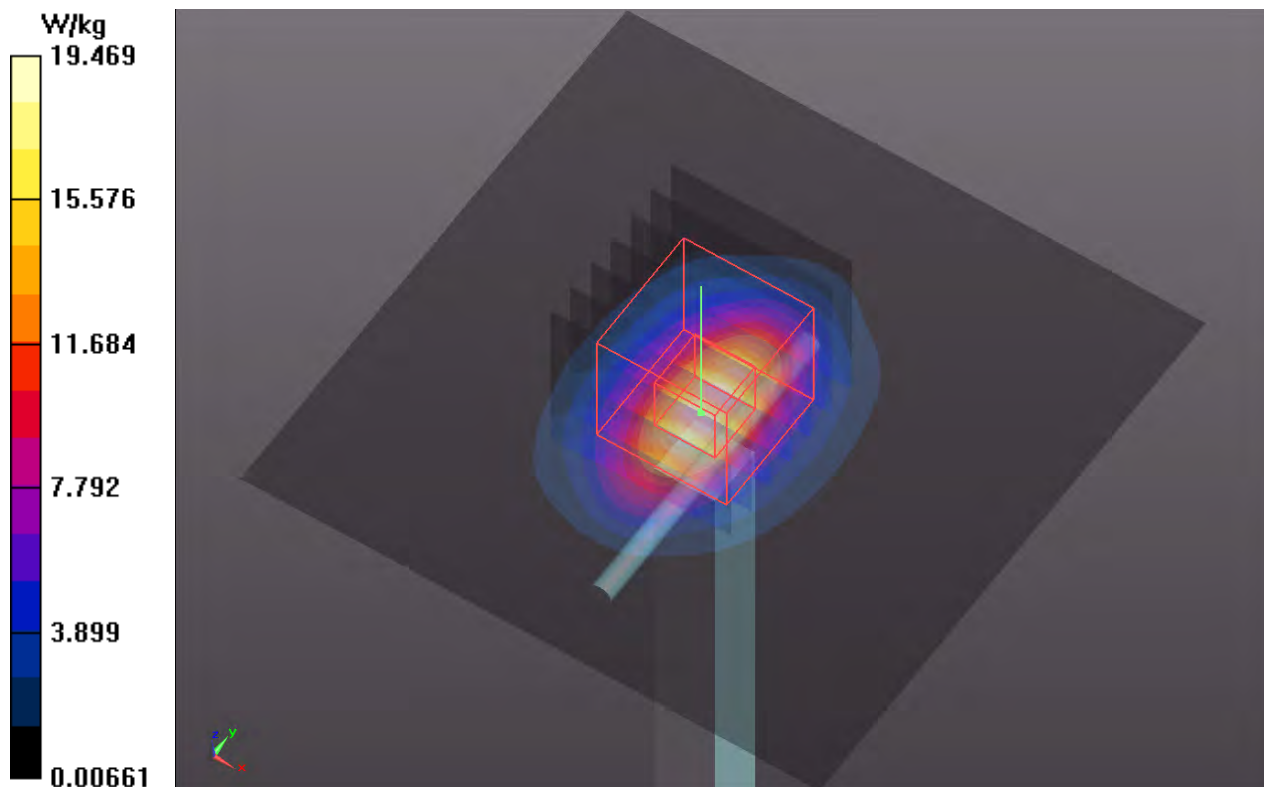

System Check_B5200_131107

DUT: Dipole 5 GHz; Type: D5GHzV2; SN: 1019

Communication System: CW; Frequency: 5200 MHz; Duty Cycle: 1:1

Medium: B5G_1107 Medium parameters used: $f = 5200$ MHz; $\sigma = 5.354$ S/m; $\epsilon_r = 47.668$; $\rho = 1000$ kg/m³

Ambient Temperature : 21.2 °C; Liquid Temperature : 20.5 °C

DASY5 Configuration:

- Probe: EX3DV4 - SN3820; ConvF(4.23, 4.23, 4.23); Calibrated: 2012/12/10;
- Sensor-Surface: 2mm (Mechanical Surface Detection)
- Electronics: DAE3 Sn579; Calibrated: 2013/04/24
- Phantom: ELI 4.0; Type: QDOVA001BA; Serial: TP:1206
- Measurement SW: DASY52, Version 52.8 (7); SEMCAD X Version 14.6.10 (7164)

Pin=100mW/Area Scan (91x91x1): Interpolated grid: dx=1.000 mm, dy=1.000 mm

Maximum value of SAR (interpolated) = 13.5 W/kg

Pin=100mW/Zoom Scan (7x7x12)/Cube 0: Measurement grid: dx=4mm, dy=4mm, dz=2mm

Reference Value = 54.713 V/m; Power Drift = 0.01 dB

Peak SAR (extrapolated) = 27.8 W/kg

SAR(1 g) = 7.03 W/kg; SAR(10 g) = 2 W/kg

Maximum value of SAR (measured) = 14.6 W/kg

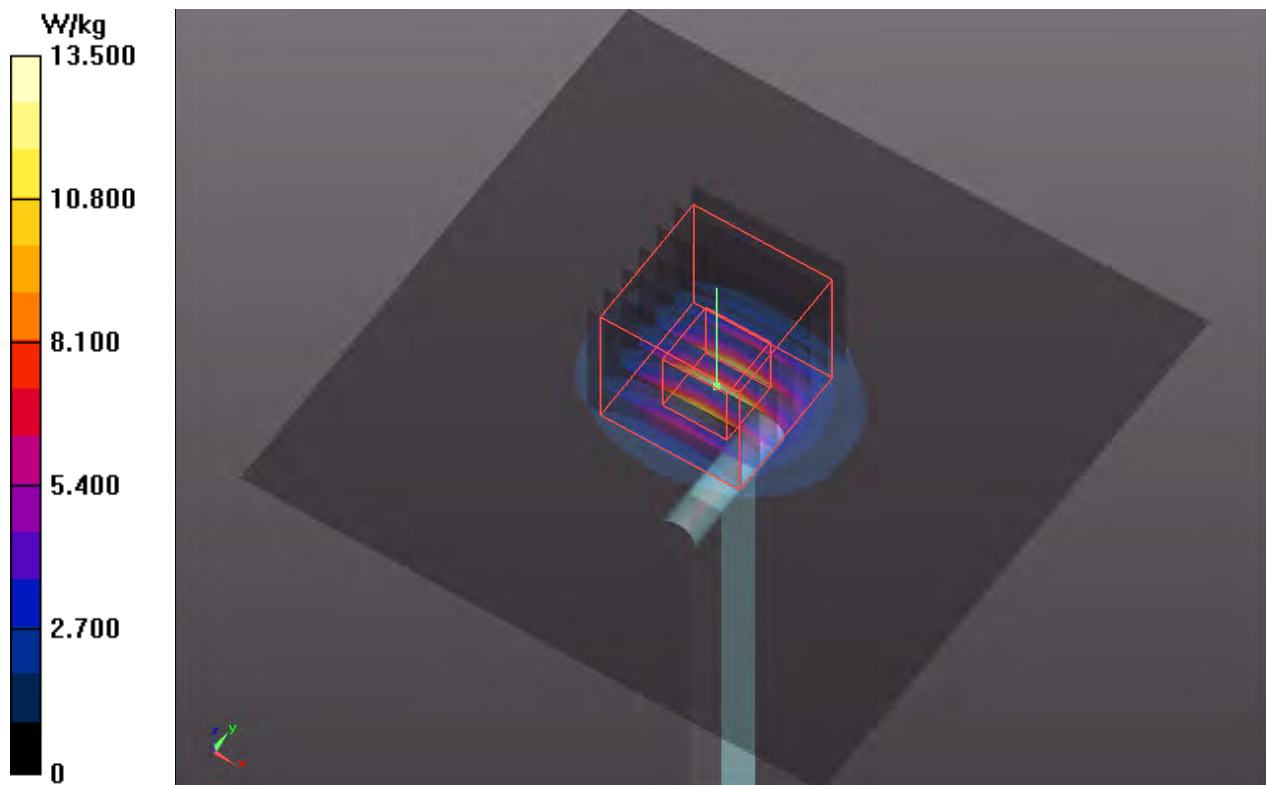

System Check_B5300_131108

DUT: Dipole 5 GHz; Type: D5GHzV2; SN: 1019

Communication System: CW; Frequency: 5300 MHz; Duty Cycle: 1:1

Medium: B5G_1108 Medium parameters used: $f = 5300$ MHz; $\sigma = 5.481$ S/m; $\epsilon_r = 47.297$; $\rho = 1000$ kg/m³

Ambient Temperature : 21.4 °C ; Liquid Temperature : 20.5 °C

DASY5 Configuration:

- Probe: EX3DV4 - SN3650; ConvF(4.31, 4.31, 4.31); Calibrated: 2013/04/30;
- Sensor-Surface: 2mm (Mechanical Surface Detection)
- Electronics: DAE3 Sn360; Calibrated: 2013/01/30
- Phantom: ELI v4.0_Right; Type: QDOVA001BA; Serial: TP:1043
- Measurement SW: DASY52, Version 52.8 (7); SEMCAD X Version 14.6.10 (7164)

Pin=100mW/Area Scan (91x91x1): Interpolated grid: dx=1.000 mm, dy=1.000 mm
Maximum value of SAR (interpolated) = 15.5 W/kg

Pin=100mW/Zoom Scan (7x7x12)/Cube 0: Measurement grid: dx=4mm, dy=4mm, dz=2mm
Reference Value = 57.447 V/m; Power Drift = 0.03 dB
Peak SAR (extrapolated) = 30.7 W/kg
SAR(1 g) = 7.36 W/kg; SAR(10 g) = 2.09 W/kg
Maximum value of SAR (measured) = 15.4 W/kg

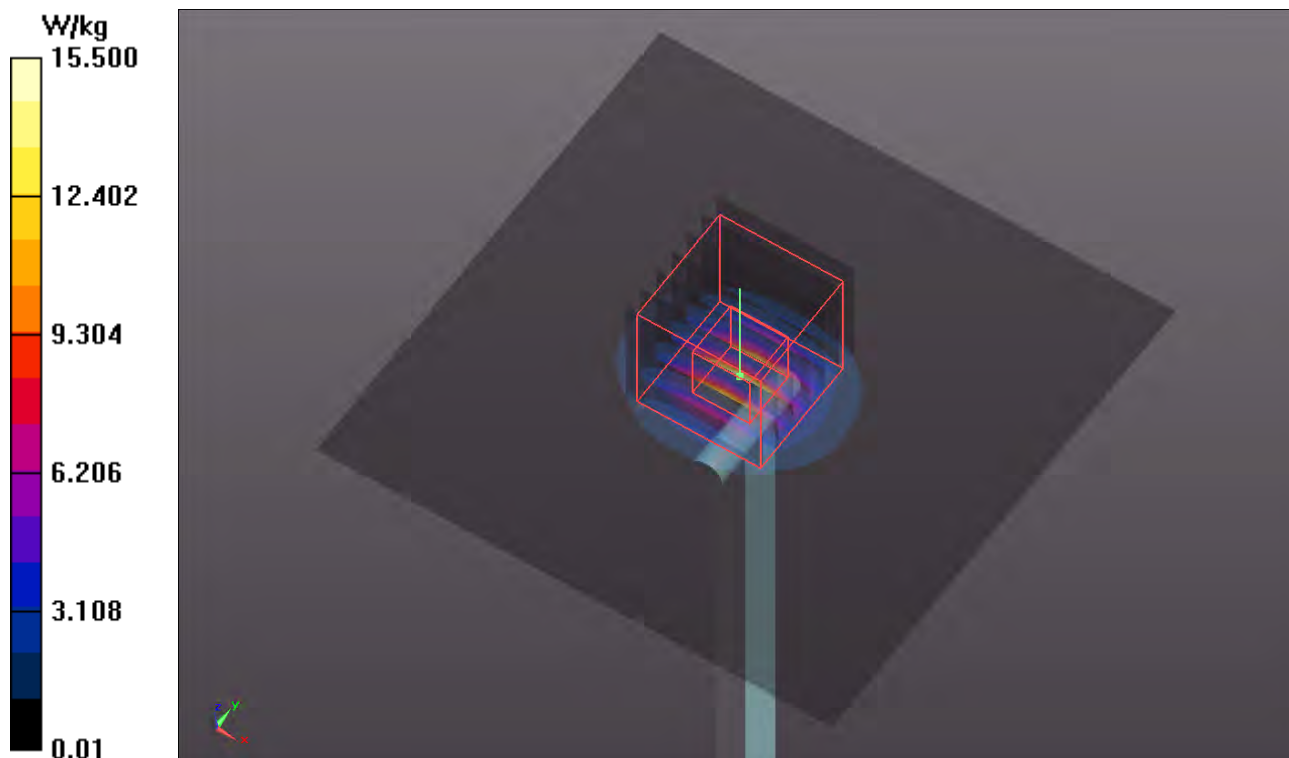

System Check_B5600_131107

DUT: Dipole 5 GHz; Type: D5GHzV2; SN: 1019

Communication System: CW; Frequency: 5600 MHz; Duty Cycle: 1:1

Medium: B5G_1107 Medium parameters used: $f = 5600$ MHz; $\sigma = 5.9$ S/m; $\epsilon_r = 46.819$; $\rho = 1000$ kg/m³

Ambient Temperature : 21.2 °C; Liquid Temperature : 20.5 °C

DASY5 Configuration:

- Probe: EX3DV4 - SN3820; ConvF(3.39, 3.39, 3.39); Calibrated: 2012/12/10;
- Sensor-Surface: 2mm (Mechanical Surface Detection)
- Electronics: DAE3 Sn579; Calibrated: 2013/04/24
- Phantom: ELI 4.0; Type: QDOVA001BA; Serial: TP:1206
- Measurement SW: DASY52, Version 52.8 (7); SEMCAD X Version 14.6.10 (7164)

Pin=100mW/Area Scan (91x91x1): Interpolated grid: dx=1.000 mm, dy=1.000 mm

Maximum value of SAR (interpolated) = 16.0 W/kg

Pin=100mW/Zoom Scan (7x7x12)/Cube 0: Measurement grid: dx=4mm, dy=4mm, dz=2mm

Reference Value = 57.131 V/m; Power Drift = -0.02 dB

Peak SAR (extrapolated) = 34.4 W/kg

SAR(1 g) = 7.64 W/kg; SAR(10 g) = 2.13 W/kg

Maximum value of SAR (measured) = 16.4 W/kg

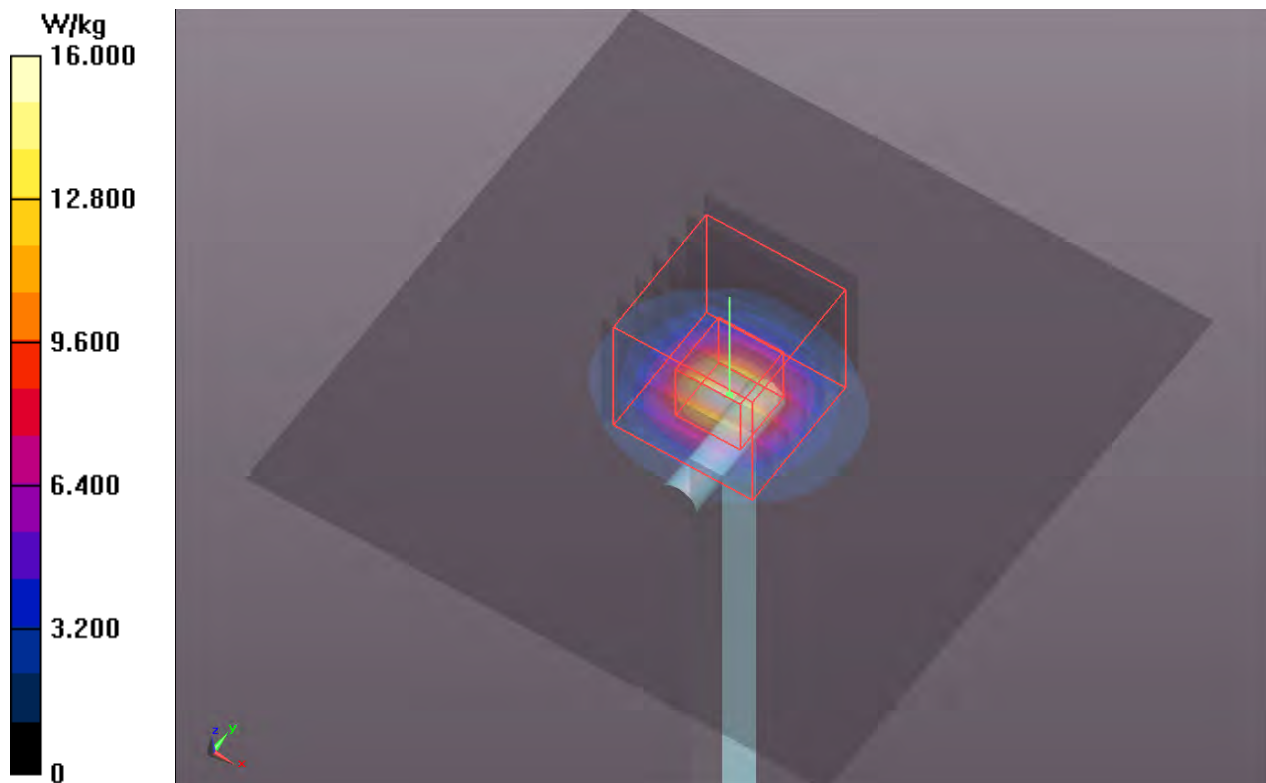

System Check_B5800_131107

DUT: Dipole 5 GHz; Type: D5GHzV2; SN: 1019

Communication System: CW; Frequency: 5800 MHz; Duty Cycle: 1:1

Medium: B5G_1107 Medium parameters used: $f = 5800$ MHz; $\sigma = 6.178$ S/m; $\epsilon_r = 46.487$; $\rho = 1000$ kg/m³

Ambient Temperature : 21.2 °C; Liquid Temperature : 20.5 °C

DASY5 Configuration:

- Probe: EX3DV4 - SN3820; ConvF(3.83, 3.83, 3.83); Calibrated: 2012/12/10;
- Sensor-Surface: 2mm (Mechanical Surface Detection)
- Electronics: DAE3 Sn579; Calibrated: 2013/04/24
- Phantom: ELI 4.0; Type: QDOVA001BA; Serial: TP:1206
- Measurement SW: DASY52, Version 52.8 (7); SEMCAD X Version 14.6.10 (7164)

Pin=100mW/Area Scan (91x91x1): Interpolated grid: dx=1.000 mm, dy=1.000 mm

Maximum value of SAR (interpolated) = 13.6 W/kg

Pin=100mW/Zoom Scan (7x7x12)/Cube 0: Measurement grid: dx=4mm, dy=4mm, dz=2mm

Reference Value = 51.577 V/m; Power Drift = 0.02 dB

Peak SAR (extrapolated) = 29.2 W/kg

SAR(1 g) = 6.79 W/kg; SAR(10 g) = 1.89 W/kg

Maximum value of SAR (measured) = 14.5 W/kg

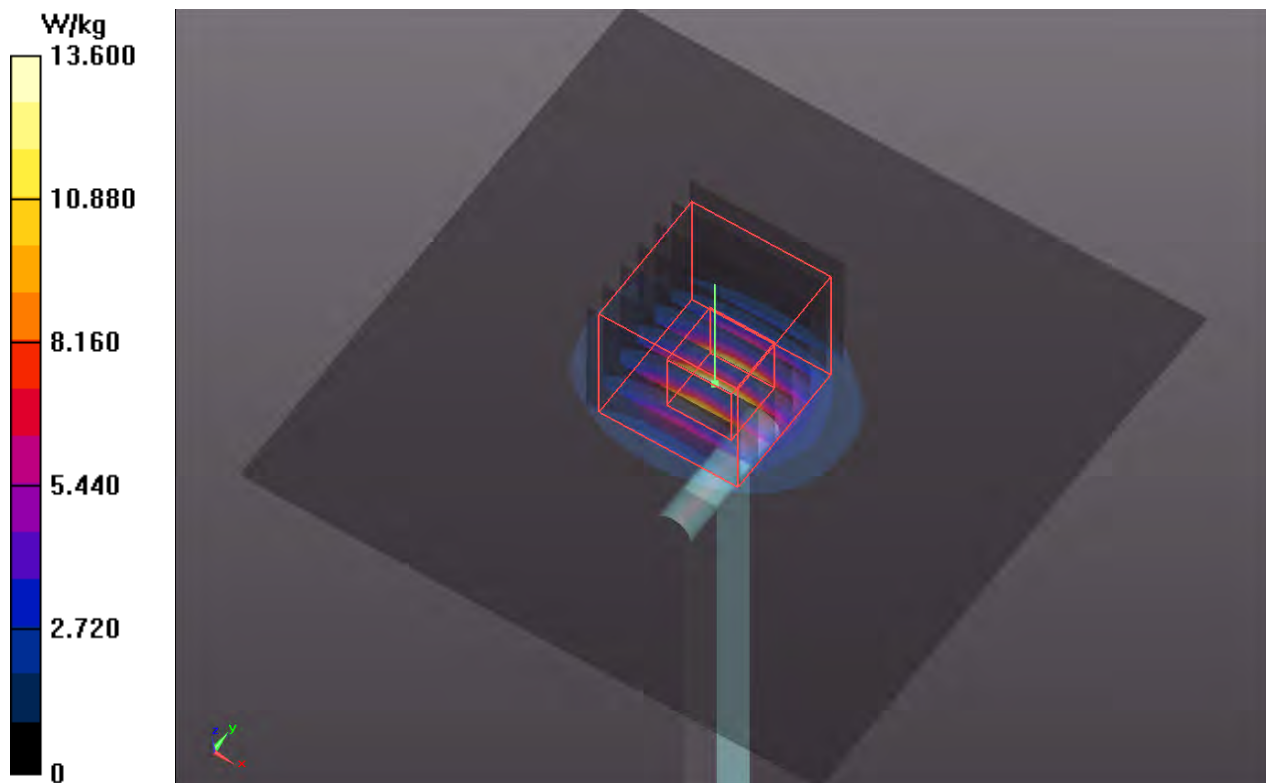



Appendix B. SAR Plots of SAR Measurement

The SAR plots for highest measured SAR in each exposure configuration, wireless mode and frequency band combination, and measured SAR > 1.5 W/kg are shown as follows.

P01 802.11b_Rear Face_0cm_Ch6

DUT: 131014C20

Communication System: WLAN_2.4G; Frequency: 2437 MHz; Duty Cycle: 1:1
Medium: B2450_1106 Medium parameters used: $f = 2437$ MHz; $\sigma = 1.951$ S/m; $\epsilon_r = 51.273$; $\rho = 1000$ kg/m³
Ambient Temperature : 21.7 °C; Liquid Temperature : 20.5 °C

DASY5 Configuration:

- Probe: EX3DV4 - SN3820; ConvF(6.84, 6.84, 6.84); Calibrated: 2012/12/10;
- Sensor-Surface: 2mm (Mechanical Surface Detection)
- Electronics: DAE3 Sn579; Calibrated: 2013/04/24
- Phantom: ELI 4.0; Type: QDOVA001BA; Serial: TP:1206
- Measurement SW: DASY52, Version 52.8 (7); SEMCAD X Version 14.6.10 (7164)

- **Area Scan (121x201x1):** Interpolated grid: dx=1.200 mm, dy=1.200 mm
Maximum value of SAR (interpolated) = 1.00 W/kg

- **Zoom Scan (5x5x7)/Cube 0:** Measurement grid: dx=8mm, dy=8mm, dz=5mm
Reference Value = 0.701 V/m; Power Drift = 0.08 dB
Peak SAR (extrapolated) = 1.69 W/kg
SAR(1 g) = 0.720 W/kg; SAR(10 g) = 0.337 W/kg
Maximum value of SAR (measured) = 1.15 W/kg

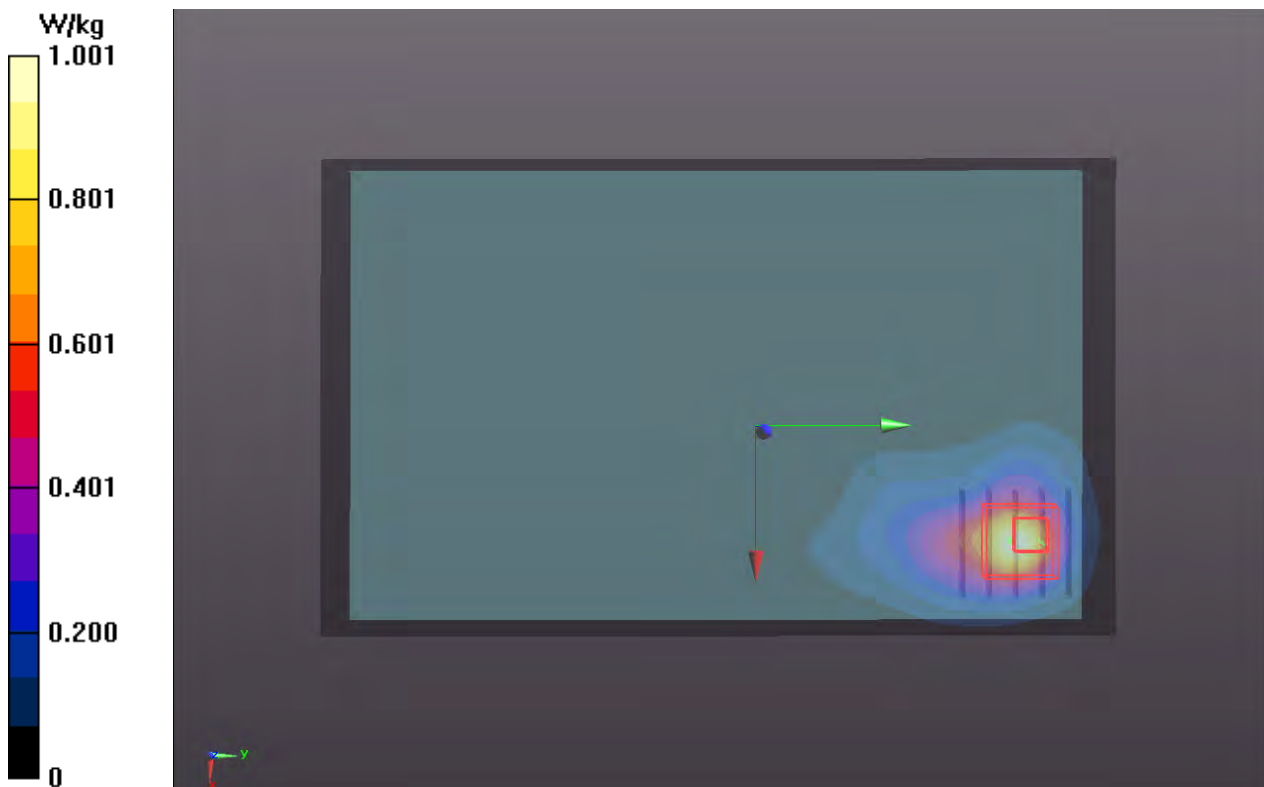

P02 802.11a_Top Side_0cm_Ch44

DUT: 131014C20

Communication System: WLAN_5G; Frequency: 5220 MHz; Duty Cycle: 1:1.06

Medium: B5G_1107 Medium parameters used: $f = 5220$ MHz; $\sigma = 5.376$ S/m; $\epsilon_r = 47.629$; $\rho = 1000$ kg/m³

Ambient Temperature : 21.2 °C; Liquid Temperature : 20.5 °C

DASY5 Configuration:

- Probe: EX3DV4 - SN3820; ConvF(4.23, 4.23, 4.23); Calibrated: 2012/12/10;
- Sensor-Surface: 2mm (Mechanical Surface Detection)
- Electronics: DAE3 Sn579; Calibrated: 2013/04/24
- Phantom: ELI 4.0; Type: QDOVA001BA; Serial: TP:1206
- Measurement SW: DASY52, Version 52.8 (7); SEMCAD X Version 14.6.10 (7164)

- **Area Scan (41x181x1):** Interpolated grid: dx=1.000 mm, dy=1.000 mm

Maximum value of SAR (interpolated) = 1.53 W/kg

- **Zoom Scan (6x6x12)/Cube 0:** Measurement grid: dx=5mm, dy=5mm, dz=2mm

Reference Value = 9.310 V/m; Power Drift = 0.18 dB

Peak SAR (extrapolated) = 4.39 W/kg

SAR(1 g) = 1.07 W/kg; SAR(10 g) = 0.277 W/kg

Maximum value of SAR (measured) = 2.14 W/kg

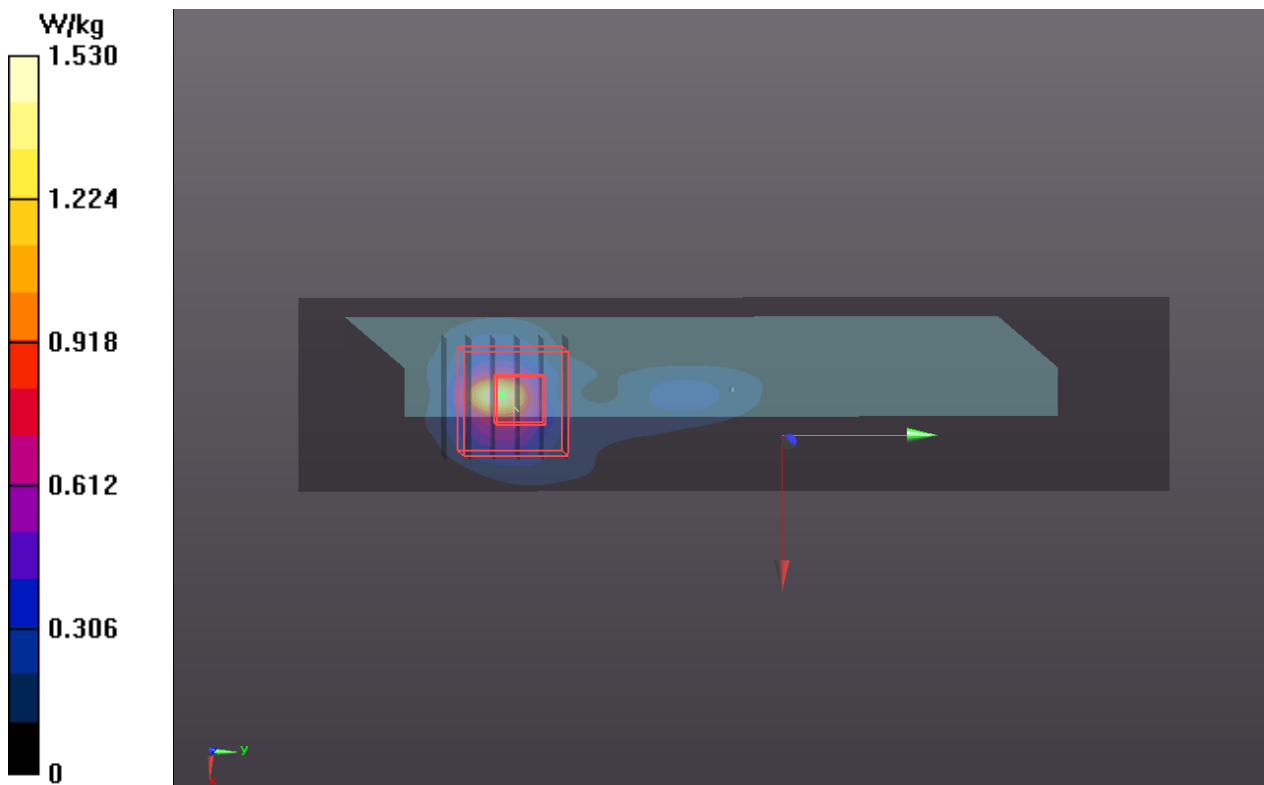

P03 802.11a_Top Side_0cm_Ch60

DUT: 131014C20

Communication System: WLAN_5G; Frequency: 5300 MHz; Duty Cycle: 1:1.06

Medium: B5G_1107 Medium parameters used: $f = 5300$ MHz; $\sigma = 5.495$ S/m; $\epsilon_r = 47.444$; $\rho = 1000$ kg/m³

Ambient Temperature : 21.2 °C; Liquid Temperature : 20.5 °C

DASY5 Configuration:

- Probe: EX3DV4 - SN3820; ConvF(3.95, 3.95, 3.95); Calibrated: 2012/12/10;
- Sensor-Surface: 2mm (Mechanical Surface Detection)
- Electronics: DAE3 Sn579; Calibrated: 2013/04/24
- Phantom: ELI 4.0; Type: QDOVA001BA; Serial: TP:1206
- Measurement SW: DASY52, Version 52.8 (7); SEMCAD X Version 14.6.10 (7164)

- **Area Scan (41x181x1):** Interpolated grid: dx=1.000 mm, dy=1.000 mm

Maximum value of SAR (interpolated) = 1.33 W/kg

- **Zoom Scan (6x6x12)/Cube 0:** Measurement grid: dx=5mm, dy=5mm, dz=2mm

Reference Value = 8.077 V/m; Power Drift = -0.03 dB

Peak SAR (extrapolated) = 4.35 W/kg

SAR(1 g) = 1.06 W/kg; SAR(10 g) = 0.276 W/kg

Maximum value of SAR (measured) = 2.13 W/kg

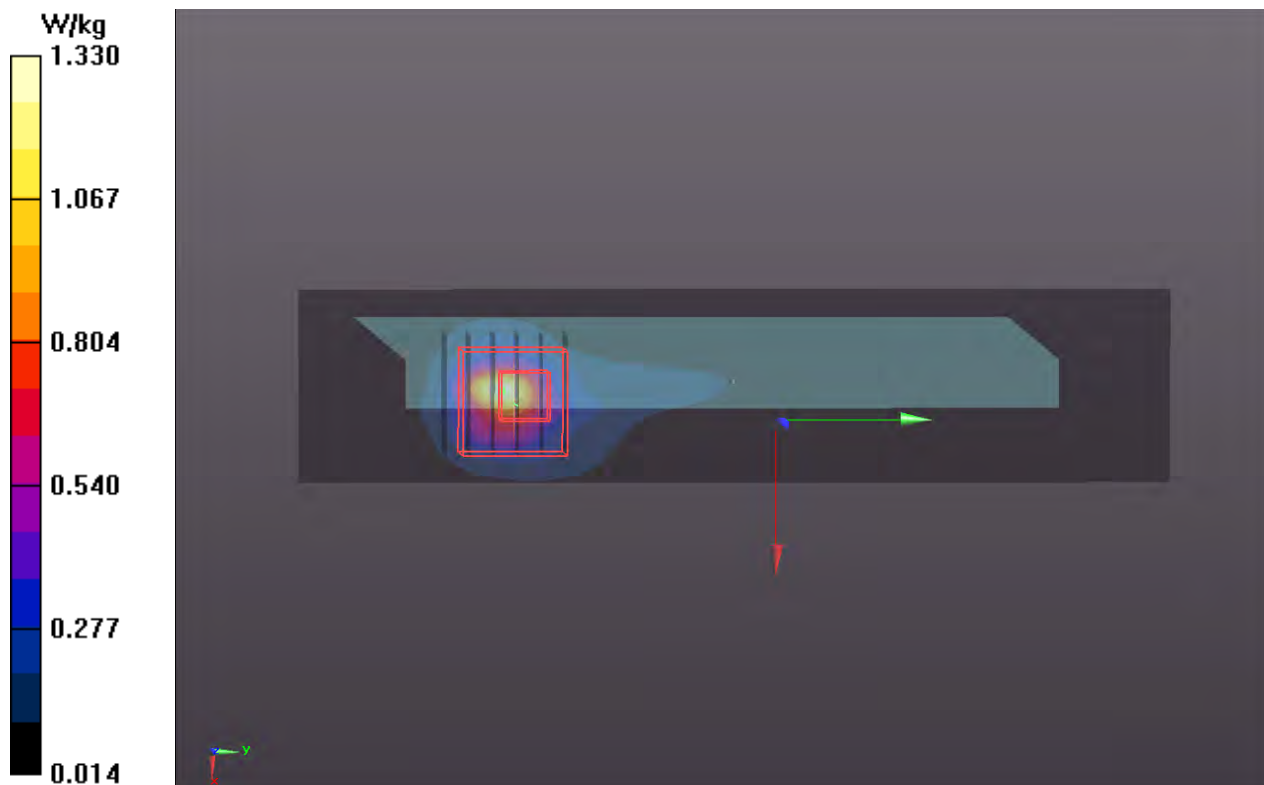

P04 802.11a_Top Side_0cm_Ch100

DUT: 131014C20

Communication System: WLAN_5G; Frequency: 5500 MHz; Duty Cycle: 1:1.06

Medium: B5G_1107 Medium parameters used: $f = 5500$ MHz; $\sigma = 5.768$ S/m; $\epsilon_r = 47.015$; $\rho = 1000$ kg/m³

Ambient Temperature : 21.2 °C; Liquid Temperature : 20.5 °C

DASY5 Configuration:

- Probe: EX3DV4 - SN3820; ConvF(3.63, 3.63, 3.63); Calibrated: 2012/12/10;
- Sensor-Surface: 2mm (Mechanical Surface Detection)
- Electronics: DAE3 Sn579; Calibrated: 2013/04/24
- Phantom: ELI 4.0; Type: QDOVA001BA; Serial: TP:1206
- Measurement SW: DASY52, Version 52.8 (7); SEMCAD X Version 14.6.10 (7164)

- **Area Scan (81x201x1):** Interpolated grid: dx=1.000 mm, dy=1.000 mm

Maximum value of SAR (interpolated) = 2.16 W/kg

- **Zoom Scan (6x6x12)/Cube 0:** Measurement grid: dx=5mm, dy=5mm, dz=2mm

Reference Value = 3.226 V/m; Power Drift = -0.03 dB

Peak SAR (extrapolated) = 4.63 W/kg

SAR(1 g) = 1.14 W/kg; SAR(10 g) = 0.315 W/kg

Maximum value of SAR (measured) = 2.42 W/kg

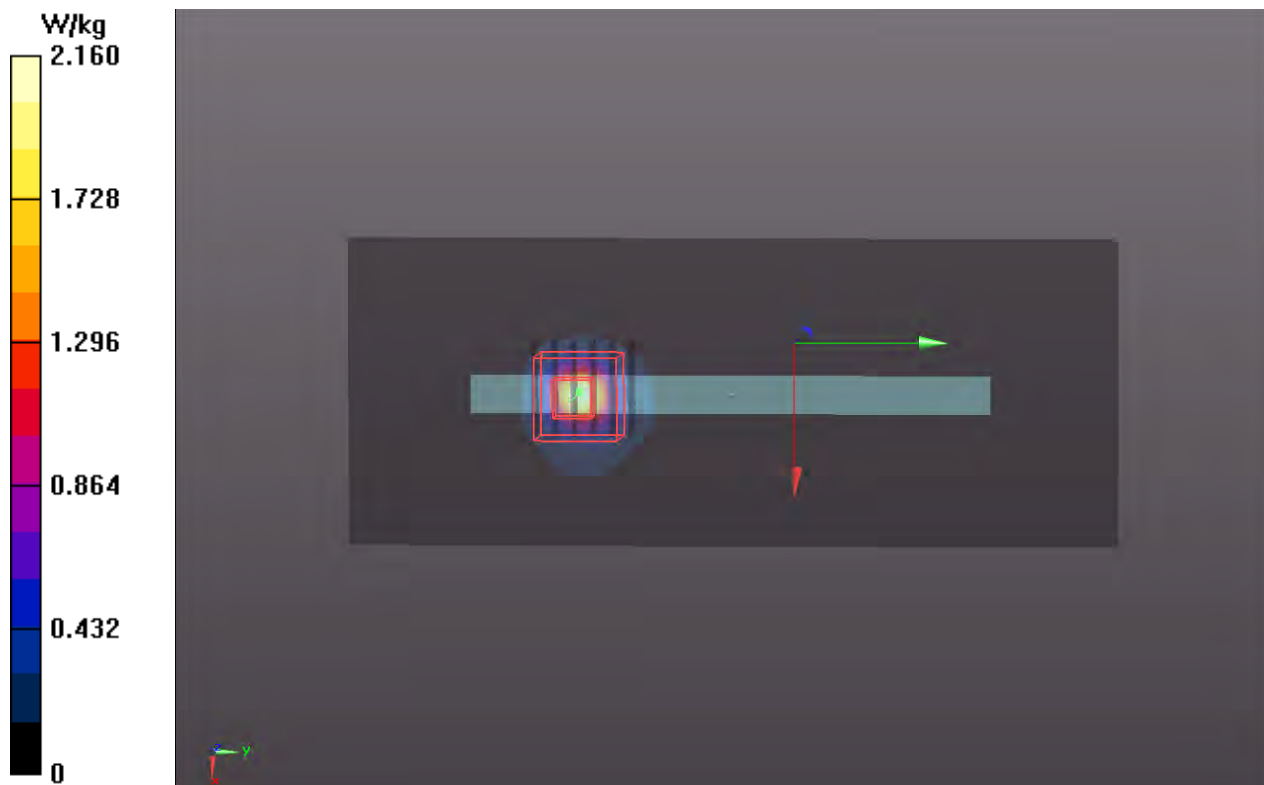

P05 802.11a_Top Side_0cm_Ch161

DUT: 131014C20

Communication System: WLAN_5G; Frequency: 5805 MHz; Duty Cycle: 1:1.06

Medium: B5G_1107 Medium parameters used: $f = 5805$ MHz; $\sigma = 6.184$ S/m; $\epsilon_r = 46.463$; $\rho = 1000$ kg/m³

Ambient Temperature : 21.2 °C; Liquid Temperature : 20.5 °C

DASY5 Configuration:

- Probe: EX3DV4 - SN3820; ConvF(3.83, 3.83, 3.83); Calibrated: 2012/12/10;
- Sensor-Surface: 2mm (Mechanical Surface Detection)
- Electronics: DAE3 Sn579; Calibrated: 2013/04/24
- Phantom: ELI 4.0; Type: QDOVA001BA; Serial: TP:1206
- Measurement SW: DASY52, Version 52.8 (7); SEMCAD X Version 14.6.10 (7164)

- **Area Scan (81x201x1):** Interpolated grid: dx=1.000 mm, dy=1.000 mm

Maximum value of SAR (interpolated) = 1.80 W/kg

- **Zoom Scan (6x6x12)/Cube 0:** Measurement grid: dx=5mm, dy=5mm, dz=2mm

Reference Value = 2.993 V/m; Power Drift = -0.08 dB

Peak SAR (extrapolated) = 3.96 W/kg

SAR(1 g) = 0.922 W/kg; SAR(10 g) = 0.261 W/kg

Maximum value of SAR (measured) = 1.89 W/kg

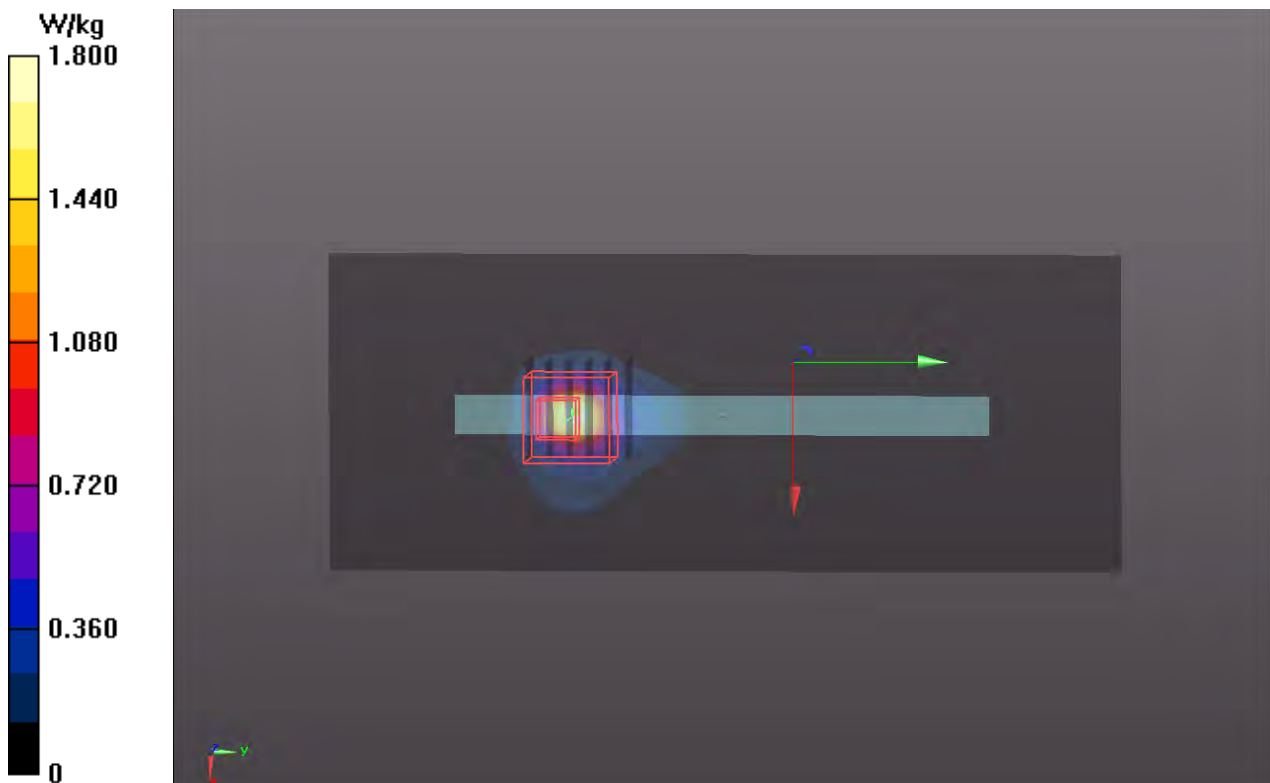

P06 Bluetooth_Left Side_0cm_Ch0

DUT: 131014C20

Communication System: BT; Frequency: 2402 MHz; Duty Cycle: 1:1

Medium: B2450_1108 Medium parameters used: $f = 2402$ MHz; $\sigma = 1.904$ S/m; $\epsilon_r = 51.591$; $\rho = 1000$ kg/m³

Ambient Temperature : 21.4 °C; Liquid Temperature : 20.5 °C

DASY5 Configuration:

- Probe: EX3DV4 - SN3650; ConvF(7.09, 7.09, 7.09); Calibrated: 2013/04/30;
- Sensor-Surface: 2mm (Mechanical Surface Detection)
- Electronics: DAE3 Sn360; Calibrated: 2013/01/30
- Phantom: ELI v4.0_Left; Type: QDOVA001BB; Serial: TP:1039
- Measurement SW: DASY52, Version 52.8 (7); SEMCAD X Version 14.6.10 (7164)

- **Area Scan (41x231x1):** Interpolated grid: dx=1.200 mm, dy=1.200 mm

Maximum value of SAR (interpolated) = 0.0171 W/kg

- **Zoom Scan (5x5x7)/Cube 0:** Measurement grid: dx=8mm, dy=8mm, dz=5mm

Reference Value = 1.335 V/m; Power Drift = -0.01 dB

Peak SAR (extrapolated) = 0.00584 W/kg

SAR(1 g) = 0.00417 W/kg; SAR(10 g) = 0.00317 W/kg

Maximum value of SAR (measured) = 0.00530 W/kg

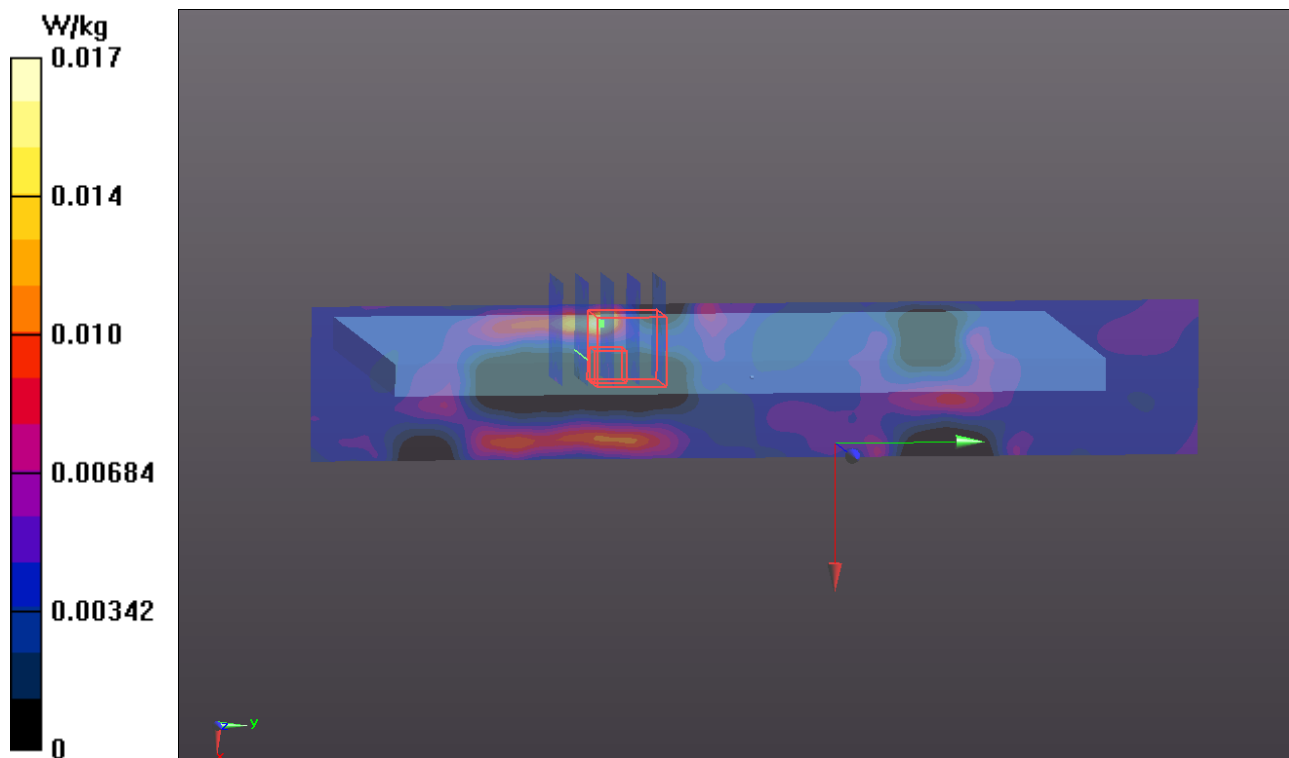



Appendix C. Calibration Certificate for Probe and Dipole

The SPEAG calibration certificates are shown as follows.



Accredited by the Swiss Accreditation Service (SAS)
The Swiss Accreditation Service is one of the signatories to the EA
Multilateral Agreement for the recognition of calibration certificates

Accreditation No.: **SCS 108**

Client **B.V. ADT (Auden)**

Certificate No: **D2450V2-737_Jan13**

CALIBRATION CERTIFICATE

Object **D2450V2 - SN: 737**

Calibration procedure(s) **QA CAL-05.v9
Calibration procedure for dipole validation kits above 700 MHz**

Calibration date: **January 21, 2013**

This calibration certificate documents the traceability to national standards, which realize the physical units of measurements (SI).
The measurements and the uncertainties with confidence probability are given on the following pages and are part of the certificate.

All calibrations have been conducted in the closed laboratory facility: environment temperature (22 ± 3)°C and humidity < 70%.

Calibration Equipment used (M&TE critical for calibration)

Primary Standards	ID #	Cal Date (Certificate No.)	Scheduled Calibration
Power meter EPM-442A	GB37480704	01-Nov-12 (No. 217-01640)	Oct-13
Power sensor HP 8481A	US37292783	01-Nov-12 (No. 217-01640)	Oct-13
Reference 20 dB Attenuator	SN: 5058 (20k)	27-Mar-12 (No. 217-01530)	Apr-13
Type-N mismatch combination	SN: 5047.3 / 06327	27-Mar-12 (No. 217-01533)	Apr-13
Reference Probe ES3DV3	SN: 3205	28-Dec-12 (No. ES3-3205_Dec12)	Dec-13
DAE4	SN: 601	27-Jun-12 (No. DAE4-601_Jun12)	Jun-13
Secondary Standards	ID #	Check Date (in house)	Scheduled Check
Power sensor HP 8481A	MY41092317	18-Oct-02 (in house check Oct-11)	In house check: Oct-13
RF generator R&S SMT-06	100005	04-Aug-99 (in house check Oct-11)	In house check: Oct-13
Network Analyzer HP 8753E	US37390585 S4206	18-Oct-01 (in house check Oct-12)	In house check: Oct-13

Calibrated by: **Leif Klynsner** **Function: Laboratory Technician** **Signature: [Signature]**

Approved by: **Fin Bomholt** **Deputy Technical Manager** **Signature: [Signature]**

Issued: January 21, 2013

This calibration certificate shall not be reproduced except in full without written approval of the laboratory.



Accredited by the Swiss Accreditation Service (SAS)

Accreditation No.: **SCS 108**

The Swiss Accreditation Service is one of the signatories to the EA Multilateral Agreement for the recognition of calibration certificates

Glossary:

TSL	tissue simulating liquid
ConvF	sensitivity in TSL / NORM x,y,z
N/A	not applicable or not measured

Calibration is Performed According to the Following Standards:

- IEEE Std 1528-2003, "IEEE Recommended Practice for Determining the Peak Spatial-Averaged Specific Absorption Rate (SAR) in the Human Head from Wireless Communications Devices: Measurement Techniques", December 2003
- IEC 62209-1, "Procedure to measure the Specific Absorption Rate (SAR) for hand-held devices used in close proximity to the ear (frequency range of 300 MHz to 3 GHz)", February 2005
- Federal Communications Commission Office of Engineering & Technology (FCC OET), "Evaluating Compliance with FCC Guidelines for Human Exposure to Radiofrequency Electromagnetic Fields; Additional Information for Evaluating Compliance of Mobile and Portable Devices with FCC Limits for Human Exposure to Radiofrequency Emissions", Supplement C (Edition 01-01) to Bulletin 65

Additional Documentation:

- DASY4/5 System Handbook

Methods Applied and Interpretation of Parameters:

- Measurement Conditions:** Further details are available from the Validation Report at the end of the certificate. All figures stated in the certificate are valid at the frequency indicated.
- Antenna Parameters with TSL:** The dipole is mounted with the spacer to position its feed point exactly below the center marking of the flat phantom section, with the arms oriented parallel to the body axis.
- Feed Point Impedance and Return Loss:** These parameters are measured with the dipole positioned under the liquid filled phantom. The impedance stated is transformed from the measurement at the SMA connector to the feed point. The Return Loss ensures low reflected power. No uncertainty required.
- Electrical Delay:** One-way delay between the SMA connector and the antenna feed point. No uncertainty required.
- SAR measured:** SAR measured at the stated antenna input power.
- SAR normalized:** SAR as measured, normalized to an input power of 1 W at the antenna connector.
- SAR for nominal TSL parameters:** The measured TSL parameters are used to calculate the nominal SAR result.

The reported uncertainty of measurement is stated as the standard uncertainty of measurement multiplied by the coverage factor $k=2$, which for a normal distribution corresponds to a coverage probability of approximately 95%.

Measurement Conditions

DASY system configuration, as far as not given on page 1.

DASY Version	DASY5	V52.8.5
Extrapolation	Advanced Extrapolation	
Phantom	Modular Flat Phantom	
Distance Dipole Center - TSL	10 mm	with Spacer
Zoom Scan Resolution	dx, dy, dz = 5 mm	
Frequency	2450 MHz \pm 1 MHz	

Head TSL parameters

The following parameters and calculations were applied.

	Temperature	Permittivity	Conductivity
Nominal Head TSL parameters	22.0 °C	39.2	1.80 mho/m
Measured Head TSL parameters	(22.0 \pm 0.2) °C	37.9 \pm 6 %	1.85 mho/m \pm 6 %
Head TSL temperature change during test	< 0.5 °C	----	----

SAR result with Head TSL

SAR averaged over 1 cm³ (1 g) of Head TSL	Condition	
SAR measured	250 mW input power	13.4 W/kg
SAR for nominal Head TSL parameters	normalized to 1W	52.5 W/kg \pm 17.0 % (k=2)

SAR averaged over 10 cm³ (10 g) of Head TSL	condition	
SAR measured	250 mW input power	6.17 W/kg
SAR for nominal Head TSL parameters	normalized to 1W	24.4 W/kg \pm 16.5 % (k=2)

Body TSL parameters

The following parameters and calculations were applied.

	Temperature	Permittivity	Conductivity
Nominal Body TSL parameters	22.0 °C	52.7	1.95 mho/m
Measured Body TSL parameters	(22.0 \pm 0.2) °C	50.5 \pm 6 %	2.01 mho/m \pm 6 %
Body TSL temperature change during test	< 0.5 °C	----	----

SAR result with Body TSL

SAR averaged over 1 cm³ (1 g) of Body TSL	Condition	
SAR measured	250 mW input power	12.7 W/kg
SAR for nominal Body TSL parameters	normalized to 1W	49.6 W/kg \pm 17.0 % (k=2)

SAR averaged over 10 cm³ (10 g) of Body TSL	condition	
SAR measured	250 mW input power	5.86 W/kg
SAR for nominal Body TSL parameters	normalized to 1W	23.1 W/kg \pm 16.5 % (k=2)

Appendix

Antenna Parameters with Head TSL

Impedance, transformed to feed point	$53.4 \Omega + 3.7 j\Omega$
Return Loss	- 26.3 dB

Antenna Parameters with Body TSL

Impedance, transformed to feed point	$50.1 \Omega + 5.3 j\Omega$
Return Loss	- 25.5 dB

General Antenna Parameters and Design

Electrical Delay (one direction)	1.161 ns
----------------------------------	----------

After long term use with 100W radiated power, only a slight warming of the dipole near the feedpoint can be measured.

The dipole is made of standard semirigid coaxial cable. The center conductor of the feeding line is directly connected to the second arm of the dipole. The antenna is therefore short-circuited for DC-signals. On some of the dipoles, small end caps are added to the dipole arms in order to improve matching when loaded according to the position as explained in the "Measurement Conditions" paragraph. The SAR data are not affected by this change. The overall dipole length is still according to the Standard.

No excessive force must be applied to the dipole arms, because they might bend or the soldered connections near the feedpoint may be damaged.

Additional EUT Data

Manufactured by	SPEAG
Manufactured on	August 26, 2003

DASY5 Validation Report for Head TSL

Date: 21.01.2013

Test Laboratory: SPEAG, Zurich, Switzerland

DUT: Dipole 2450 MHz; Type: D2450V2; Serial: D2450V2 - SN: 737

Communication System: CW; Frequency: 2450 MHz

Medium parameters used: $f = 2450$ MHz; $\sigma = 1.85$ S/m; $\epsilon_r = 37.9$; $\rho = 1000$ kg/m³

Phantom section: Flat Section

Measurement Standard: DASY5 (IEEE/IEC/ANSI C63.19-2007)

DASY52 Configuration:

- Probe: ES3DV3 - SN3205; ConvF(4.52, 4.52, 4.52); Calibrated: 28.12.2012;
- Sensor-Surface: 3mm (Mechanical Surface Detection)
- Electronics: DAE4 Sn601; Calibrated: 27.06.2012
- Phantom: Flat Phantom 5.0 (front); Type: QD000P50AA; Serial: 1001
- DASY52 52.8.5(1059); SEMCAD X 14.6.8(7028)

Dipole Calibration for Head Tissue/Pin=250 mW, d=10mm/Zoom Scan (7x7x7)/Cube 0:

Measurement grid: dx=5mm, dy=5mm, dz=5mm

Reference Value = 99.892 V/m; Power Drift = 0.05 dB

Peak SAR (extrapolated) = 28.0 W/kg

SAR(1 g) = 13.4 W/kg; SAR(10 g) = 6.17 W/kg

Maximum value of SAR (measured) = 17.2 W/kg

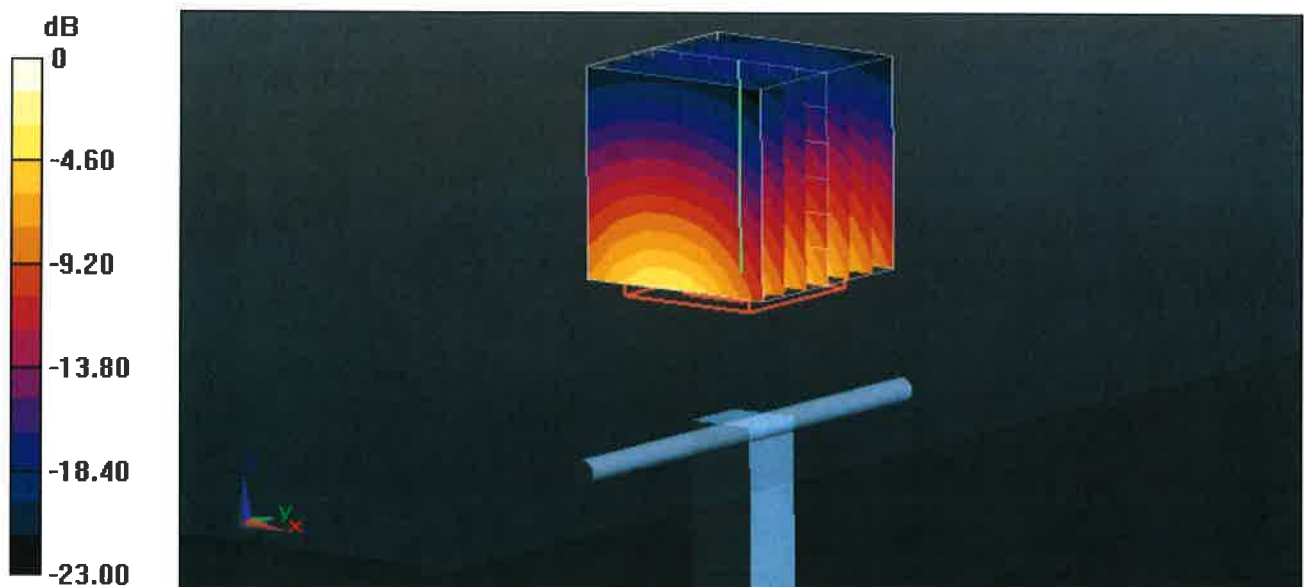

Impedance Measurement Plot for Head TSL

18 Jan 2013 12:34:33
 CH1 S11 1 U FS 3: 53.387 Δ 3.7109 Δ 241.07 pH 2 450.000 000 MHz

*
 De l

CA

Avg
 16

H1d

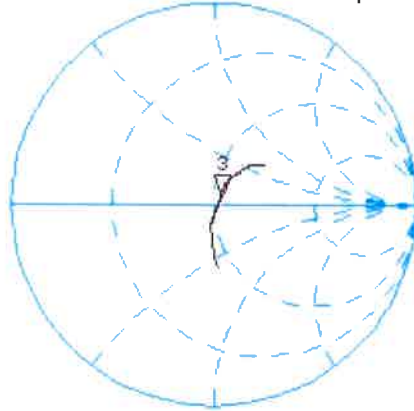

CH2 S11 LOG 5 dB/REF -20 dB 3:-26.268 dB 2 450.000 000 MHz

CA

Avg
 16

H1d

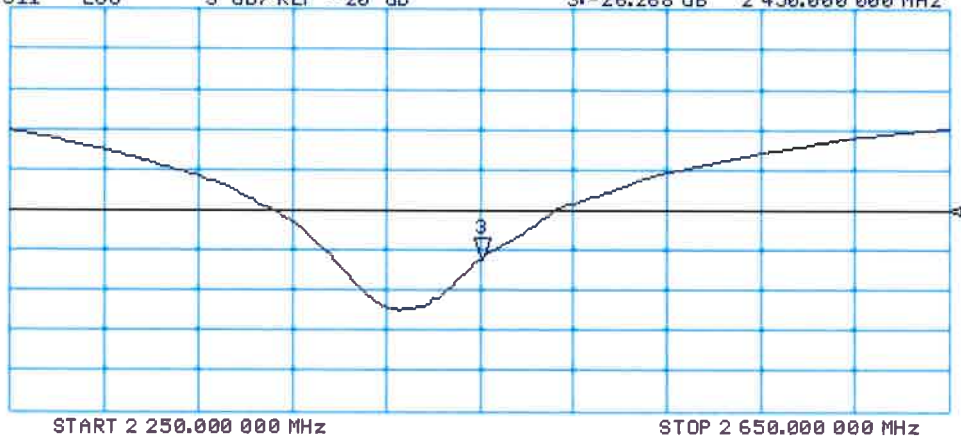

DASY5 Validation Report for Body TSL

Date: 18.01.2013

Test Laboratory: SPEAG, Zurich, Switzerland

DUT: Dipole 2450 MHz; Type: D2450V2; Serial: D2450V2 - SN: 737

Communication System: CW; Frequency: 2450 MHz

Medium parameters used: $f = 2450$ MHz; $\sigma = 2.01$ S/m; $\epsilon_r = 50.5$; $\rho = 1000$ kg/m³

Phantom section: Flat Section

Measurement Standard: DASY5 (IEEE/IEC/ANSI C63.19-2007)

DASY52 Configuration:

- Probe: ES3DV3 - SN3205; ConvF(4.42, 4.42, 4.42); Calibrated: 28.12.2012;
- Sensor-Surface: 3mm (Mechanical Surface Detection)
- Electronics: DAE4 Sn601; Calibrated: 27.06.2012
- Phantom: Flat Phantom 5.0 (back); Type: QD000P50AA; Serial: 1002
- DASY52 52.8.5(1059); SEMCAD X 14.6.8(7028)

Dipole Calibration for Body Tissue/Pin=250 mW, d=10mm/Zoom Scan (7x7x7)/Cube 0:

Measurement grid: dx=5mm, dy=5mm, dz=5mm

Reference Value = 94.076 V/m; Power Drift = 0.01 dB

Peak SAR (extrapolated) = 26.9 W/kg

SAR(1 g) = 12.7 W/kg; SAR(10 g) = 5.86 W/kg

Maximum value of SAR (measured) = 16.8 W/kg

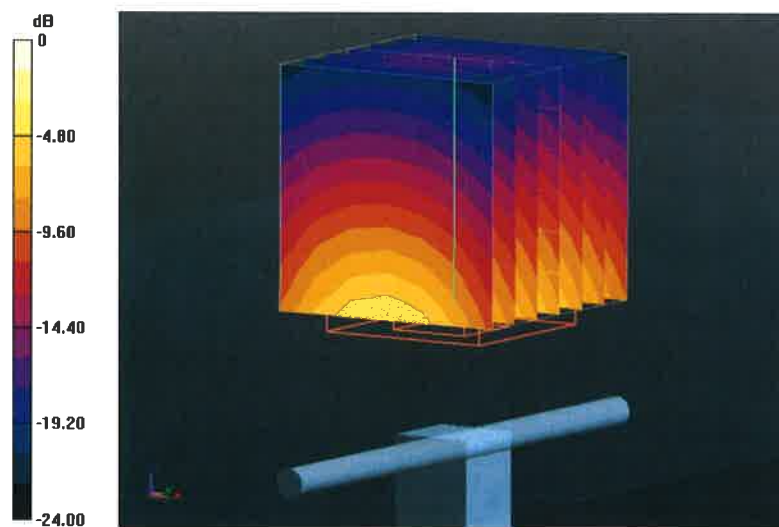

0 dB = 16.8 W/kg = 12.25 dBW/kg

Impedance Measurement Plot for Body TSL

18 Jan 2013 12:34:02
[CH1] S11 1 U FS 3: 50.123 Δ 5.3340 Δ 346.50 pH 2 450.000 000 MHz

*
De1

C Δ

Avg
16

H1d

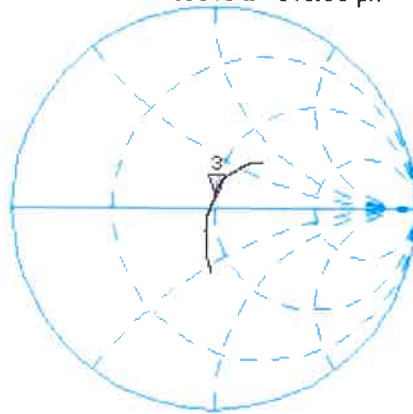

CH2 S11 LOG 5 dB/REF -20 dB 3:-25.479 dB 2 450.000 000 MHz

C Δ

Avg
16

H1d





Accredited by the Swiss Accreditation Service (SAS)
The Swiss Accreditation Service is one of the signatories to the EA
Multilateral Agreement for the recognition of calibration certificates

Accreditation No.: **SCS 108**

Client **B.V. ADT (Auden)**

Certificate No: **D5GHzV2-1019_Nov12**

CALIBRATION CERTIFICATE

Object **D5GHzV2 - SN: 1019**

Calibration procedure(s) **QA CAL-22.v1
Calibration procedure for dipole validation kits between 3-6 GHz**

Calibration date: **November 16, 2012**

This calibration certificate documents the traceability to national standards, which realize the physical units of measurements (SI).
The measurements and the uncertainties with confidence probability are given on the following pages and are part of the certificate.

All calibrations have been conducted in the closed laboratory facility: environment temperature (22 ± 3)°C and humidity < 70%.

Calibration Equipment used (M&TE critical for calibration)

Primary Standards	ID #	Cal Date (Certificate No.)	Scheduled Calibration
Power meter EPM-442A	GB37480704	01-Nov-12 (No. 217-01640)	Oct-13
Power sensor HP 8481A	US37292783	01-Nov-12 (No. 217-01640)	Oct-13
Reference 20 dB Attenuator	SN: 5058 (20k)	27-Mar-12 (No. 217-01530)	Apr-13
Type-N mismatch combination	SN: 5047.2 / 06327	27-Mar-12 (No. 217-01533)	Apr-13
Reference Probe EX3DV4	SN: 3503	30-Dec-11 (No. EX3-3503_Dec11)	Dec-12
DAE4	SN: 601	27-Jun-12 (No. DAE4-601_Jun12)	Jun-13
Secondary Standards	ID #	Check Date (in house)	Scheduled Check
Power sensor HP 8481A	MY41092317	18-Oct-02 (in house check Oct-11)	In house check: Oct-13
RF generator R&S SMT-06	100005	04-Aug-99 (in house check Oct-11)	In house check: Oct-13
Network Analyzer HP 8753E	US37390585 S4206	18-Oct-01 (in house check Oct-12)	In house check: Oct-13

Calibrated by: **Israe El-Naouq** Name: **Israe El-Naouq** Function: **Laboratory Technician**

Approved by: **Katja Pokovic** Name: **Katja Pokovic** Function: **Technical Manager**

Signature
Israe El-Naouq
Katja Pokovic

Issued: November 16, 2012

This calibration certificate shall not be reproduced except in full without written approval of the laboratory.



Accredited by the Swiss Accreditation Service (SAS)

The Swiss Accreditation Service is one of the signatories to the EA
Multilateral Agreement for the recognition of calibration certificates

Accreditation No.: **SCS 108**

Glossary:

TSL	tissue simulating liquid
ConvF	sensitivity in TSL / NORM x,y,z
N/A	not applicable or not measured

Calibration is Performed According to the Following Standards:

- a) IEC 62209-2, "Evaluation of Human Exposure to Radio Frequency Fields from Handheld and Body-Mounted Wireless Communication Devices in the Frequency Range of 30 MHz to 6 GHz: Human models, Instrumentation, and Procedures"; Part 2: "Procedure to determine the Specific Absorption Rate (SAR) for including accessories and multiple transmitters", March 2010
- b) Federal Communications Commission Office of Engineering & Technology (FCC OET), "Evaluating Compliance with FCC Guidelines for Human Exposure to Radiofrequency Electromagnetic Fields; Additional Information for Evaluating Compliance of Mobile and Portable Devices with FCC Limits for Human Exposure to Radiofrequency Emissions", Supplement C (Edition 01-01) to Bulletin 65

Additional Documentation:

- c) DASY4/5 System Handbook

Methods Applied and Interpretation of Parameters:

- *Measurement Conditions:* Further details are available from the Validation Report at the end of the certificate. All figures stated in the certificate are valid at the frequency indicated.
- *Antenna Parameters with TSL:* The dipole is mounted with the spacer to position its feed point exactly below the center marking of the flat phantom section, with the arms oriented parallel to the body axis.
- *Feed Point Impedance and Return Loss:* These parameters are measured with the dipole positioned under the liquid filled phantom. The impedance stated is transformed from the measurement at the SMA connector to the feed point. The Return Loss ensures low reflected power. No uncertainty required.
- *Electrical Delay:* One-way delay between the SMA connector and the antenna feed point. No uncertainty required.
- *SAR measured:* SAR measured at the stated antenna input power.
- *SAR normalized:* SAR as measured, normalized to an input power of 1 W at the antenna connector.
- *SAR for nominal TSL parameters:* The measured TSL parameters are used to calculate the nominal SAR result.

The reported uncertainty of measurement is stated as the standard uncertainty of measurement multiplied by the coverage factor $k=2$, which for a normal distribution corresponds to a coverage probability of approximately 95%.

Measurement Conditions

DASY system configuration, as far as not given on page 1.

DASY Version	DASY5	V52.8.3
Extrapolation	Advanced Extrapolation	
Phantom	Modular Flat Phantom V5.0	
Distance Dipole Center - TSL	10 mm	with Spacer
Zoom Scan Resolution	dx, dy = 4.0 mm, dz = 1.4 mm	Graded Ratio = 1.4 (Z direction)
Frequency	5200 MHz ± 1 MHz 5300 MHz ± 1 MHz 5600 MHz ± 1 MHz 5800 MHz ± 1 MHz	

Head TSL parameters at 5200 MHz

The following parameters and calculations were applied.

	Temperature	Permittivity	Conductivity
Nominal Head TSL parameters	22.0 °C	36.0	4.66 mho/m
Measured Head TSL parameters	(22.0 ± 0.2) °C	34.8 ± 6 %	4.53 mho/m ± 6 %
Head TSL temperature change during test	< 0.5 °C	----	----

SAR result with Head TSL at 5200 MHz

SAR averaged over 1 cm³ (1 g) of Head TSL	Condition	
SAR measured	100 mW input power	7.96 W/kg
SAR for nominal Head TSL parameters	normalized to 1W	79.0 W/kg ± 19.9 % (k=2)

SAR averaged over 10 cm³ (10 g) of Head TSL	condition	
SAR measured	100 mW input power	2.27 W/kg
SAR for nominal Head TSL parameters	normalized to 1W	22.5 W/kg ± 19.5 % (k=2)

Head TSL parameters at 5300 MHz

The following parameters and calculations were applied.

	Temperature	Permittivity	Conductivity
Nominal Head TSL parameters	22.0 °C	35.9	4.76 mho/m
Measured Head TSL parameters	(22.0 ± 0.2) °C	34.7 ± 6 %	4.63 mho/m ± 6 %
Head TSL temperature change during test	< 0.5 °C	----	----

SAR result with Head TSL at 5300 MHz

SAR averaged over 1 cm³ (1 g) of Head TSL	Condition	
SAR measured	100 mW input power	8.28 W/kg
SAR for nominal Head TSL parameters	normalized to 1W	82.2 W / kg ± 19.9 % (k=2)

SAR averaged over 10 cm³ (10 g) of Head TSL	condition	
SAR measured	100 mW input power	2.37 W/kg
SAR for nominal Head TSL parameters	normalized to 1W	23.5 W/kg ± 19.5 % (k=2)

Head TSL parameters at 5600 MHz

The following parameters and calculations were applied.

	Temperature	Permittivity	Conductivity
Nominal Head TSL parameters	22.0 °C	35.5	5.07 mho/m
Measured Head TSL parameters	(22.0 ± 0.2) °C	34.2 ± 6 %	4.93 mho/m ± 6 %
Head TSL temperature change during test	< 0.5 °C	----	----

SAR result with Head TSL at 5600 MHz

SAR averaged over 1 cm ³ (1 g) of Head TSL	Condition	
SAR measured	100 mW input power	8.46 W/kg
SAR for nominal Head TSL parameters	normalized to 1W	83.8 W/kg ± 19.9 % (k=2)

SAR averaged over 10 cm ³ (10 g) of Head TSL	condition	
SAR measured	100 mW input power	2.41 W/kg
SAR for nominal Head TSL parameters	normalized to 1W	23.8 W/kg ± 19.5 % (k=2)

Head TSL parameters at 5800 MHz

The following parameters and calculations were applied.

	Temperature	Permittivity	Conductivity
Nominal Head TSL parameters	22.0 °C	35.3	5.27 mho/m
Measured Head TSL parameters	(22.0 ± 0.2) °C	34.0 ± 6 %	5.15 mho/m ± 6 %
Head TSL temperature change during test	< 0.5 °C	----	----

SAR result with Head TSL at 5800 MHz

SAR averaged over 1 cm ³ (1 g) of Head TSL	Condition	
SAR measured	100 mW input power	7.96 W/kg
SAR for nominal Head TSL parameters	normalized to 1W	78.9 W/kg ± 19.9 % (k=2)

SAR averaged over 10 cm ³ (10 g) of Head TSL	condition	
SAR measured	100 mW input power	2.26 W/kg
SAR for nominal Head TSL parameters	normalized to 1W	22.4 W/kg ± 19.5 % (k=2)

Body TSL parameters at 5200 MHz

The following parameters and calculations were applied.

	Temperature	Permittivity	Conductivity
Nominal Body TSL parameters	22.0 °C	49.0	5.30 mho/m
Measured Body TSL parameters	(22.0 ± 0.2) °C	46.8 ± 6 %	5.35 mho/m ± 6 %
Body TSL temperature change during test	< 0.5 °C	----	----

SAR result with Body TSL at 5200 MHz

SAR averaged over 1 cm ³ (1 g) of Body TSL	Condition	
SAR measured	100 mW input power	7.37 W/kg
SAR for nominal Body TSL parameters	normalized to 1W	73.0 W/kg ± 19.9 % (k=2)

SAR averaged over 10 cm ³ (10 g) of Body TSL	condition	
SAR measured	100 mW input power	2.07 W/kg
SAR for nominal Body TSL parameters	normalized to 1W	20.5 W/kg ± 19.5 % (k=2)

Body TSL parameters at 5300 MHz

The following parameters and calculations were applied.

	Temperature	Permittivity	Conductivity
Nominal Body TSL parameters	22.0 °C	48.9	5.42 mho/m
Measured Body TSL parameters	(22.0 ± 0.2) °C	46.7 ± 6 %	5.47 mho/m ± 6 %
Body TSL temperature change during test	< 0.5 °C	----	----

SAR result with Body TSL at 5300 MHz

SAR averaged over 1 cm ³ (1 g) of Body TSL	Condition	
SAR measured	100 mW input power	7.53 W/kg
SAR for nominal Body TSL parameters	normalized to 1W	74.6 W/kg ± 19.9 % (k=2)

SAR averaged over 10 cm ³ (10 g) of Body TSL	condition	
SAR measured	100 mW input power	2.12 W/kg
SAR for nominal Body TSL parameters	normalized to 1W	21.0 W/kg ± 19.5 % (k=2)

Body TSL parameters at 5600 MHz

The following parameters and calculations were applied.

	Temperature	Permittivity	Conductivity
Nominal Body TSL parameters	22.0 °C	48.5	5.77 mho/m
Measured Body TSL parameters	(22.0 ± 0.2) °C	46.2 ± 6 %	5.86 mho/m ± 6 %
Body TSL temperature change during test	< 0.5 °C	----	----

SAR result with Body TSL at 5600 MHz

SAR averaged over 1 cm ³ (1 g) of Body TSL	Condition	
SAR measured	100 mW input power	8.06 W/kg
SAR for nominal Body TSL parameters	normalized to 1W	79.9 W/kg ± 19.9 % (k=2)

SAR averaged over 10 cm ³ (10 g) of Body TSL	condition	
SAR measured	100 mW input power	2.24 W/kg
SAR for nominal Body TSL parameters	normalized to 1W	22.1 W/kg ± 19.5 % (k=2)

Body TSL parameters at 5800 MHz

The following parameters and calculations were applied.

	Temperature	Permittivity	Conductivity
Nominal Body TSL parameters	22.0 °C	48.2	6.00 mho/m
Measured Body TSL parameters	(22.0 ± 0.2) °C	45.9 ± 6 %	6.13 mho/m ± 6 %
Body TSL temperature change during test	< 0.5 °C	----	----

SAR result with Body TSL at 5800 MHz

SAR averaged over 1 cm ³ (1 g) of Body TSL	Condition	
SAR measured	100 mW input power	7.41 W/kg
SAR for nominal Body TSL parameters	normalized to 1W	73.4 W/kg ± 19.9 % (k=2)

SAR averaged over 10 cm ³ (10 g) of Body TSL	condition	
SAR measured	100 mW input power	2.06 W/kg
SAR for nominal Body TSL parameters	normalized to 1W	20.4 W/kg ± 19.5 % (k=2)

Appendix

Antenna Parameters with Head TSL at 5200 MHz

Impedance, transformed to feed point	52.1 Ω - 7.8 j Ω
Return Loss	- 22.0 dB

Antenna Parameters with Head TSL at 5300 MHz

Impedance, transformed to feed point	52.6 Ω - 1.5 j Ω
Return Loss	- 30.7 dB

Antenna Parameters with Head TSL at 5600 MHz

Impedance, transformed to feed point	56.6 Ω - 2.1 j Ω
Return Loss	- 23.7 dB

Antenna Parameters with Head TSL at 5800 MHz

Impedance, transformed to feed point	56.3 Ω + 1.7 j Ω
Return Loss	- 24.3 dB

Antenna Parameters with Body TSL at 5200 MHz

Impedance, transformed to feed point	52.7 Ω - 7.8 j Ω
Return Loss	- 22.0 dB

Antenna Parameters with Body TSL at 5300 MHz

Impedance, transformed to feed point	53.2 Ω - 0.3 j Ω
Return Loss	- 30.1 dB

Antenna Parameters with Body TSL at 5600 MHz

Impedance, transformed to feed point	57.1 Ω - 1.0 j Ω
Return Loss	- 23.5 dB

Antenna Parameters with Body TSL at 5800 MHz

Impedance, transformed to feed point	57.6 Ω + 2.9 j Ω
Return Loss	- 22.4 dB

General Antenna Parameters and Design

Electrical Delay (one direction)	1.204 ns
----------------------------------	----------

After long term use with 100W radiated power, only a slight warming of the dipole near the feedpoint can be measured.

The dipole is made of standard semirigid coaxial cable. The center conductor of the feeding line is directly connected to the second arm of the dipole. The antenna is therefore short-circuited for DC-signals. On some of the dipoles, small end caps are added to the dipole arms in order to improve matching when loaded according to the position as explained in the "Measurement Conditions" paragraph. The SAR data are not affected by this change. The overall dipole length is still according to the Standard.

No excessive force must be applied to the dipole arms, because they might bend or the soldered connections near the feedpoint may be damaged.

Additional EUT Data

Manufactured by	SPEAG
Manufactured on	February 05, 2004

DASY5 Validation Report for Head TSL

Date: 16.11.2012

Test Laboratory: SPEAG, Zurich, Switzerland

DUT: Dipole 5GHz; Type: D5GHzV2; Serial: D5GHzV2 - SN: 1019

Communication System: CW; Frequency: 5200 MHz, Frequency: 5300 MHz, Frequency: 5600 MHz, Frequency: 5800 MHz

Medium parameters used: $f = 5200$ MHz; $\sigma = 4.53$ mho/m; $\epsilon_r = 34.8$; $\rho = 1000$ kg/m³, Medium parameters used: $f = 5300$ MHz; $\sigma = 4.63$ mho/m; $\epsilon_r = 34.7$; $\rho = 1000$ kg/m³, Medium parameters used: $f = 5600$ MHz; $\sigma = 4.93$ mho/m; $\epsilon_r = 34.2$; $\rho = 1000$ kg/m³, Medium parameters used: $f = 5800$ MHz; $\sigma = 5.15$ mho/m; $\epsilon_r = 34$; $\rho = 1000$ kg/m³

Phantom section: Flat Section

Measurement Standard: DASY5 (IEEE/IEC/ANSI C63.19-2007)

DASY52 Configuration:

- Probe: EX3DV4 - SN3503; ConvF(5.41, 5.41, 5.41); Calibrated: 30.12.2011, ConvF(5.1, 5.1, 5.1); Calibrated: 30.12.2011, ConvF(4.76, 4.76, 4.76); Calibrated: 30.12.2011, ConvF(4.81, 4.81, 4.81); Calibrated: 30.12.2011;
- Sensor-Surface: 1.4mm (Mechanical Surface Detection)
- Electronics: DAE4 Sn601; Calibrated: 27.06.2012
- Phantom: Flat Phantom 5.0 (front); Type: QD000P50AA; Serial: 1001
- DASY52 52.8.3(988); SEMCAD X 14.6.7(6848)

Dipole Calibration for Head Tissue/Pin=100mW, dist=10mm, f=5200 MHz/Zoom Scan, dist=1.4mm (8x8x7)/Cube 0: Measurement grid: dx=4mm, dy=4mm, dz=1.4mm

Reference Value = 64.098 V/m; Power Drift = 0.07 dB

Peak SAR (extrapolated) = 29.6 W/kg

SAR(1 g) = 7.96 W/kg; SAR(10 g) = 2.27 W/kg

Maximum value of SAR (measured) = 18.5 W/kg

Dipole Calibration for Head Tissue/Pin=100mW, dist=10mm, f=5300 MHz/Zoom Scan, dist=1.4mm (8x8x7)/Cube 0: Measurement grid: dx=4mm, dy=4mm, dz=1.4mm

Reference Value = 64.859 V/m; Power Drift = 0.05 dB

Peak SAR (extrapolated) = 31.3 W/kg

SAR(1 g) = 8.28 W/kg; SAR(10 g) = 2.37 W/kg

Maximum value of SAR (measured) = 19.4 W/kg

Dipole Calibration for Head Tissue/Pin=100mW, dist=10mm, f=5600 MHz/Zoom Scan, dist=1.4mm (8x8x7)/Cube 0: Measurement grid: dx=4mm, dy=4mm, dz=1.4mm

Reference Value = 64.163 V/m; Power Drift = 0.05 dB

Peak SAR (extrapolated) = 33.6 W/kg

SAR(1 g) = 8.46 W/kg; SAR(10 g) = 2.41 W/kg

Maximum value of SAR (measured) = 20.3 W/kg

Dipole Calibration for Head Tissue/Pin=100mW, dist=10mm, f=5800 MHz/Zoom Scan, dist=1.4mm (8x8x7)/Cube 0: Measurement grid: dx=4mm, dy=4mm, dz=1.4mm
Reference Value = 60.898 V/m; Power Drift = 0.09 dB
Peak SAR (extrapolated) = 33.1 W/kg
SAR(1 g) = 7.96 W/kg; SAR(10 g) = 2.26 W/kg
Maximum value of SAR (measured) = 19.5 W/kg

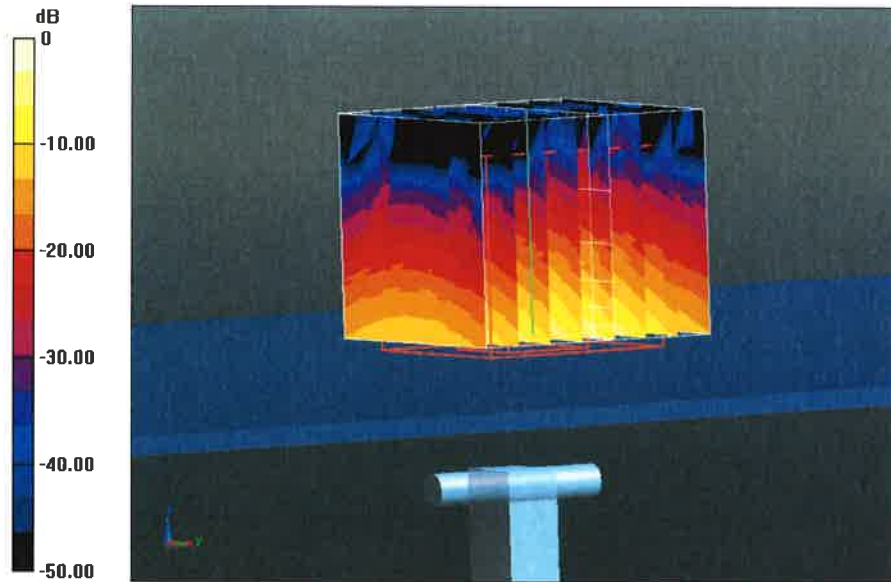

0 dB = 19.5 W/kg = 12.90 dBW/kg

Impedance Measurement Plot for Head TSL

16 Nov 2012 17:30:41

CH1 S11 1 U FS 1: 52.078 Ω -7.8242 Ω 3.9118 pF 5 200.000 000 MHz

*
De1
Cor
Avg
16
H1d

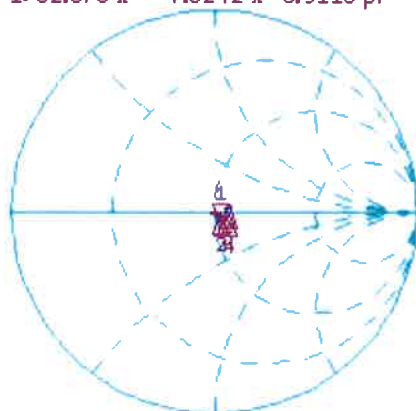

CH1 Markers
2: 52.619 Ω
-1.4551 Ω
5.30000 GHz
4: 56.619 Ω
-2.1328 Ω
5.60000 GHz
5: 56.289 Ω
1.6992 Ω
5.80000 GHz

CH2 S11 LOG 5 dB/REF -20 dB 1: -22.033 dB 5 200.000 000 MHz

Cor
Avg
16
H1d



CH2 Markers
2: -30.687 dB
5.30000 GHz
4: -23.714 dB
5.60000 GHz
5: -24.254 dB
5.80000 GHz

START 5 000.000 000 MHz STOP 6 000.000 000 MHz

DASY5 Validation Report for Body TSL

Date: 14.11.2012

Test Laboratory: SPEAG, Zurich, Switzerland

DUT: Dipole 5GHz; Type: D5GHzV2; Serial: D5GHzV2 - SN: 1019

Communication System: CW; Frequency: 5200 MHz, Frequency: 5300 MHz, Frequency: 5600 MHz, Frequency: 5800 MHz

Medium parameters used: $f = 5200$ MHz; $\sigma = 5.35$ mho/m; $\epsilon_r = 46.8$; $\rho = 1000$ kg/m³, Medium parameters used: $f = 5300$ MHz; $\sigma = 5.47$ mho/m; $\epsilon_r = 46.7$; $\rho = 1000$ kg/m³, Medium parameters used: $f = 5600$ MHz; $\sigma = 5.86$ mho/m; $\epsilon_r = 46.2$; $\rho = 1000$ kg/m³, Medium parameters used: $f = 5800$ MHz; $\sigma = 6.13$ mho/m; $\epsilon_r = 45.9$; $\rho = 1000$ kg/m³

Phantom section: Flat Section

Measurement Standard: DASY5 (IEEE/IEC/ANSI C63.19-2007)

DASY52 Configuration:

- Probe: EX3DV4 - SN3503; ConvF(4.91, 4.91, 4.91); Calibrated: 30.12.2011, ConvF(4.67, 4.67, 4.67); Calibrated: 30.12.2011, ConvF(4.22, 4.22, 4.22); Calibrated: 30.12.2011, ConvF(4.38, 4.38, 4.38); Calibrated: 30.12.2011;
- Sensor-Surface: 1.4mm (Mechanical Surface Detection)
- Electronics: DAE4 Sn601; Calibrated: 27.06.2012
- Phantom: Flat Phantom 5.0 (back); Type: QD000P50AA; Serial: 1002
- DASY52 52.8.3(988); SEMCAD X 14.6.7(6848)

Dipole Calibration for Body Tissue/Pin=100mW, dist=10mm, f=5200 MHz/Zoom Scan, dist=1.4mm (8x8x7)/Cube 0: Measurement grid: dx=4mm, dy=4mm, dz=1.4mm

Reference Value = 58.457 V/m; Power Drift = -0.05 dB

Peak SAR (extrapolated) = 29.3 W/kg

SAR(1 g) = 7.37 W/kg; SAR(10 g) = 2.07 W/kg

Maximum value of SAR (measured) = 17.4 W/kg

Dipole Calibration for Body Tissue/Pin=100mW, dist=10mm, f=5300 MHz/Zoom Scan, dist=1.4mm (8x8x7)/Cube 0: Measurement grid: dx=4mm, dy=4mm, dz=1.4mm

Reference Value = 58.382 V/m; Power Drift = -0.00 dB

Peak SAR (extrapolated) = 30.4 W/kg

SAR(1 g) = 7.53 W/kg; SAR(10 g) = 2.12 W/kg

Maximum value of SAR (measured) = 17.9 W/kg

Dipole Calibration for Body Tissue/Pin=100mW, dist=10mm, f=5600 MHz/Zoom Scan, dist=1.4mm (8x8x7)/Cube 0: Measurement grid: dx=4mm, dy=4mm, dz=1.4mm

Reference Value = 58.712 V/m; Power Drift = -0.02 dB

Peak SAR (extrapolated) = 35.9 W/kg

SAR(1 g) = 8.06 W/kg; SAR(10 g) = 2.24 W/kg

Maximum value of SAR (measured) = 19.9 W/kg

Dipole Calibration for Body Tissue/Pin=100mW, dist=10mm, f=5800 MHz/Zoom Scan, dist=1.4mm (8x8x7)/Cube 0: Measurement grid: dx=4mm, dy=4mm, dz=1.4mm
Reference Value = 54.869 V/m; Power Drift = -0.04 dB
Peak SAR (extrapolated) = 34.7 W/kg
SAR(1 g) = 7.41 W/kg; SAR(10 g) = 2.06 W/kg
Maximum value of SAR (measured) = 18.4 W/kg

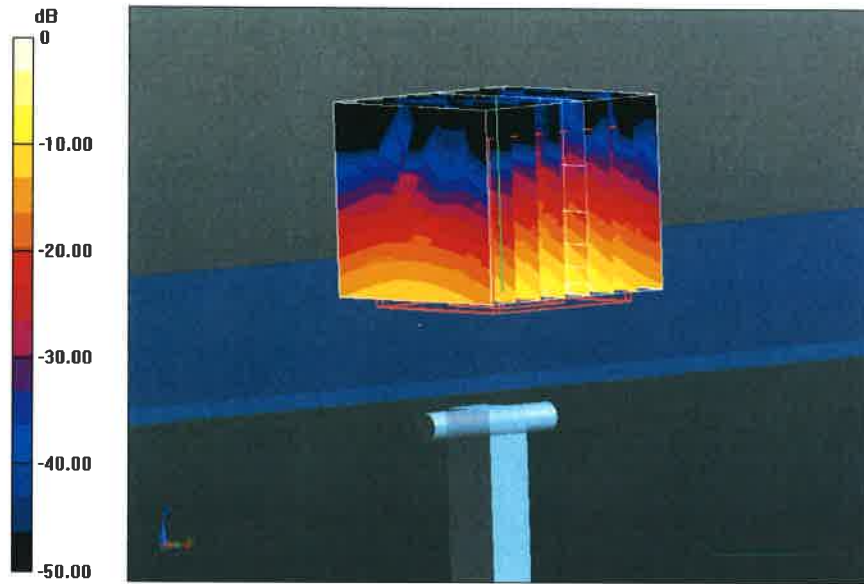

0 dB = 18.4 W/kg = 12.65 dBW/kg

Impedance Measurement Plot for Body TSL

14 Nov 2012 10:21:29

CH1 S11 1 U FS 1: 52.654 Ω -7.7520 Ω 3.9483 pF 5 200.000 000 MHz

*
De1
Cor
Avg
16
H1d

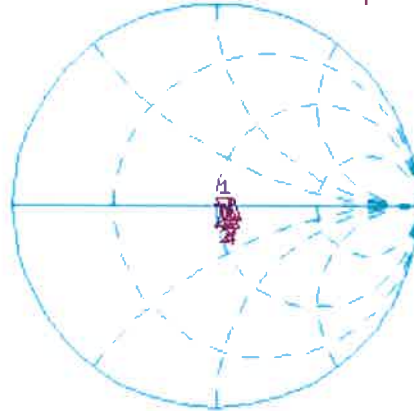

CH1 Markers
2: 53.219 Ω
-275.39 m Ω
5.30000 GHz
4: 57.076 Ω
-1.0098 Ω
5.60000 GHz
5: 57.600 Ω
2.9238 Ω
5.80000 GHz

CH2 S11 LOG 5 dB/REF -20 dB 1: -21.979 dB 5 200.000 000 MHz

Cor
Avg
16
H1d

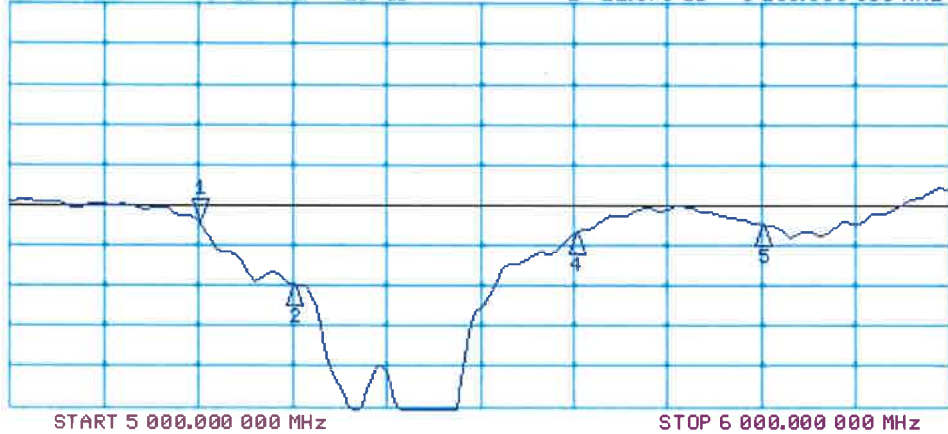

CH2 Markers
2: -30.081 dB
5.30000 GHz
4: -23.508 dB
5.60000 GHz
5: -22.424 dB
5.80000 GHz

START 5 000.000 000 MHz

STOP 6 000.000 000 MHz



Accredited by the Swiss Accreditation Service (SAS)
The Swiss Accreditation Service is one of the signatories to the EA
Multilateral Agreement for the recognition of calibration certificates

Accreditation No.: **SCS 108**

Client **B.V. ADT (Auden)**

Certificate No: **EX3-3650_Apr13**

CALIBRATION CERTIFICATE

Object **EX3DV4 - SN:3650**

Calibration procedure(s) **QA CAL-01.v8, QA CAL-14.v3, QA CAL-23.v4, QA CAL-25.v4
Calibration procedure for dosimetric E-field probes**

Calibration date: **April 30, 2013**

This calibration certificate documents the traceability to national standards, which realize the physical units of measurements (SI).
The measurements and the uncertainties with confidence probability are given on the following pages and are part of the certificate.

All calibrations have been conducted in the closed laboratory facility: environment temperature (22 ± 3)°C and humidity < 70%.

Calibration Equipment used (M&TE critical for calibration)

Primary Standards	ID	Cal Date (Certificate No.)	Scheduled Calibration
Power meter E4419B	GB41293874	04-Apr-13 (No. 217-01733)	Apr-14
Power sensor E4412A	MY41498087	04-Apr-13 (No. 217-01733)	Apr-14
Reference 3 dB Attenuator	SN: S5054 (3c)	04-Apr-13 (No. 217-01737)	Apr-14
Reference 20 dB Attenuator	SN: S5277 (20x)	04-Apr-13 (No. 217-01735)	Apr-14
Reference 30 dB Attenuator	SN: S5129 (30b)	04-Apr-13 (No. 217-01738)	Apr-14
Reference Probe ES3DV2	SN: 3013	28-Dec-12 (No. ES3-3013_Dec12)	Dec-13
DAE4	SN: 660	31-Jan-13 (No. DAE4-660_Jan13)	Jan-14
Secondary Standards	ID	Check Date (in house)	Scheduled Check
RF generator HP 8648C	US3642U01700	4-Aug-99 (in house check Apr-13)	In house check: Apr-15
Network Analyzer HP 8753E	US37390585	18-Oct-01 (in house check Oct-12)	In house check: Oct-13

Calibrated by:	Name Israe El-Naouq	Function Laboratory Technician	Signature
Approved by:	Name Katja Pokovic	Function Technical Manager	

Issued: May 1, 2013

This calibration certificate shall not be reproduced except in full without written approval of the laboratory.



Accredited by the Swiss Accreditation Service (SAS)

Accreditation No.: **SCS 108**

The Swiss Accreditation Service is one of the signatories to the EA
Multilateral Agreement for the recognition of calibration certificates

Glossary:

TSL	tissue simulating liquid
NORM _{x,y,z}	sensitivity in free space
ConvF	sensitivity in TSL / NORM _{x,y,z}
DCP	diode compression point
CF	crest factor (1/duty_cycle) of the RF signal
A, B, C, D	modulation dependent linearization parameters
Polarization φ	φ rotation around probe axis
Polarization ϑ	ϑ rotation around an axis that is in the plane normal to probe axis (at measurement center), i.e., $\vartheta = 0$ is normal to probe axis

Calibration is Performed According to the Following Standards:

- IEEE Std 1528-2003, "IEEE Recommended Practice for Determining the Peak Spatial-Averaged Specific Absorption Rate (SAR) in the Human Head from Wireless Communications Devices: Measurement Techniques", December 2003
- IEC 62209-1, "Procedure to measure the Specific Absorption Rate (SAR) for hand-held devices used in close proximity to the ear (frequency range of 300 MHz to 3 GHz)", February 2005

Methods Applied and Interpretation of Parameters:

- NORM_{x,y,z}**: Assessed for E-field polarization $\vartheta = 0$ ($f \leq 900$ MHz in TEM-cell; $f > 1800$ MHz: R22 waveguide). NORM_{x,y,z} are only intermediate values, i.e., the uncertainties of NORM_{x,y,z} does not affect the E²-field uncertainty inside TSL (see below ConvF).
- NORM(f)_{x,y,z}** = NORM_{x,y,z} * frequency_response (see Frequency Response Chart). This linearization is implemented in DASY4 software versions later than 4.2. The uncertainty of the frequency response is included in the stated uncertainty of ConvF.
- DCP_{x,y,z}**: DCP are numerical linearization parameters assessed based on the data of power sweep with CW signal (no uncertainty required). DCP does not depend on frequency nor media.
- PAR**: PAR is the Peak to Average Ratio that is not calibrated but determined based on the signal characteristics
- A_{x,y,z}; B_{x,y,z}; C_{x,y,z}; D_{x,y,z}; VR_{x,y,z}**: A, B, C, D are numerical linearization parameters assessed based on the data of power sweep for specific modulation signal. The parameters do not depend on frequency nor media. VR is the maximum calibration range expressed in RMS voltage across the diode.
- ConvF and Boundary Effect Parameters**: Assessed in flat phantom using E-field (or Temperature Transfer Standard for $f \leq 800$ MHz) and inside waveguide using analytical field distributions based on power measurements for $f > 800$ MHz. The same setups are used for assessment of the parameters applied for boundary compensation (alpha, depth) of which typical uncertainty values are given. These parameters are used in DASY4 software to improve probe accuracy close to the boundary. The sensitivity in TSL corresponds to NORM_{x,y,z} * ConvF whereby the uncertainty corresponds to that given for ConvF. A frequency dependent ConvF is used in DASY version 4.4 and higher which allows extending the validity from ± 50 MHz to ± 100 MHz.
- Spherical isotropy (3D deviation from isotropy)**: in a field of low gradients realized using a flat phantom exposed by a patch antenna.
- Sensor Offset**: The sensor offset corresponds to the offset of virtual measurement center from the probe tip (on probe axis). No tolerance required.

Probe EX3DV4

SN:3650

Manufactured:	March 18, 2008
Repaired:	April 22, 2013
Calibrated:	April 30, 2013

Calibrated for DASY/EASY Systems
(Note: non-compatible with DASY2 system!)

DASY/EASY - Parameters of Probe: EX3DV4 - SN:3650

Basic Calibration Parameters

	Sensor X	Sensor Y	Sensor Z	Unc (k=2)
Norm ($\mu\text{V}/(\text{V}/\text{m})^2$) ^A	0.39	0.37	0.40	$\pm 10.1 \%$
DCP (mV) ^B	99.0	98.4	98.6	

Modulation Calibration Parameters

UID	Communication System Name		A dB	B dB $\sqrt{\mu\text{V}}$	C	D dB	VR mV	Unc ^E (k=2)
0	CW	X	0.0	0.0	1.0	0.00	103.4	$\pm 3.5 \%$
		Y	0.0	0.0	1.0		132.3	
		Z	0.0	0.0	1.0		108.8	

The reported uncertainty of measurement is stated as the standard uncertainty of measurement multiplied by the coverage factor $k=2$, which for a normal distribution corresponds to a coverage probability of approximately 95%.

^A The uncertainties of NormX,Y,Z do not affect the E^2 -field uncertainty inside TSL (see Pages 5 and 6).

^B Numerical linearization parameter: uncertainty not required.

^E Uncertainty is determined using the max. deviation from linear response applying rectangular distribution and is expressed for the square of the field value.

DASY/EASY - Parameters of Probe: EX3DV4 - SN:3650

Calibration Parameter Determined in Head Tissue Simulating Media

f (MHz) ^C	Relative Permittivity ^F	Conductivity (S/m) ^F	ConvF X	ConvF Y	ConvF Z	Alpha	Depth (mm)	Unct. (k=2)
750	41.9	0.89	9.69	9.69	9.69	0.41	0.87	± 12.0 %
835	41.5	0.90	9.37	9.37	9.37	0.66	0.67	± 12.0 %
900	41.5	0.97	9.22	9.22	9.22	0.46	0.72	± 12.0 %
1450	40.5	1.20	8.04	8.04	8.04	0.31	1.01	± 12.0 %
1640	40.3	1.29	8.07	8.07	8.07	0.40	0.80	± 12.0 %
1750	40.1	1.37	7.91	7.91	7.91	0.80	0.50	± 12.0 %
1900	40.0	1.40	7.73	7.73	7.73	0.35	0.88	± 12.0 %
2000	40.0	1.40	7.59	7.59	7.59	0.80	0.57	± 12.0 %
2300	39.5	1.67	7.34	7.34	7.34	0.67	0.62	± 12.0 %
2450	39.2	1.80	6.99	6.99	6.99	0.47	0.74	± 12.0 %
2600	39.0	1.96	6.85	6.85	6.85	0.48	0.78	± 12.0 %
3500	37.9	2.91	6.96	6.96	6.96	0.85	0.62	± 13.1 %
5200	36.0	4.66	5.20	5.20	5.20	0.35	1.80	± 13.1 %
5300	35.9	4.76	5.07	5.07	5.07	0.30	1.80	± 13.1 %
5600	35.5	5.07	4.57	4.57	4.57	0.40	1.80	± 13.1 %
5800	35.3	5.27	4.56	4.56	4.56	0.45	1.80	± 13.1 %

^C Frequency validity of ± 100 MHz only applies for DASY v4.4 and higher (see Page 2), else it is restricted to ± 50 MHz. The uncertainty is the RSS of the ConvF uncertainty at calibration frequency and the uncertainty for the indicated frequency band.

^F At frequencies below 3 GHz, the validity of tissue parameters (ϵ and σ) can be relaxed to ± 10% if liquid compensation formula is applied to measured SAR values. At frequencies above 3 GHz, the validity of tissue parameters (ϵ and σ) is restricted to ± 5%. The uncertainty is the RSS of the ConvF uncertainty for indicated target tissue parameters.

DASY/EASY - Parameters of Probe: EX3DV4 - SN:3650

Calibration Parameter Determined in Body Tissue Simulating Media

f (MHz) ^C	Relative Permittivity ^F	Conductivity (S/m) ^F	ConvF X	ConvF Y	ConvF Z	Alpha	Depth (mm)	Unct. (k=2)
750	55.5	0.96	9.51	9.51	9.51	0.73	0.64	± 12.0 %
835	55.2	0.97	9.35	9.35	9.35	0.80	0.50	± 12.0 %
900	55.0	1.05	9.23	9.23	9.23	0.78	0.62	± 12.0 %
1450	54.0	1.30	8.40	8.40	8.40	0.80	0.50	± 12.0 %
1640	53.8	1.40	8.36	8.36	8.36	0.80	0.62	± 12.0 %
1750	53.4	1.49	7.57	7.57	7.57	0.74	0.66	± 12.0 %
1900	53.3	1.52	7.39	7.39	7.39	0.40	0.86	± 12.0 %
2000	53.3	1.52	7.57	7.57	7.57	0.51	0.77	± 12.0 %
2300	52.9	1.81	6.73	6.73	6.73	0.51	0.73	± 12.0 %
2450	52.7	1.95	7.09	7.09	7.09	0.80	0.50	± 12.0 %
2600	52.5	2.16	6.91	6.91	6.91	0.80	0.50	± 12.0 %
3500	51.3	3.31	6.58	6.58	6.58	0.38	1.16	± 13.1 %
5200	49.0	5.30	4.51	4.51	4.51	0.45	1.90	± 13.1 %
5300	48.9	5.42	4.31	4.31	4.31	0.45	1.90	± 13.1 %
5600	48.5	5.77	4.00	4.00	4.00	0.45	1.90	± 13.1 %
5800	48.2	6.00	4.21	4.21	4.21	0.55	1.90	± 13.1 %

^C Frequency validity of ± 100 MHz only applies for DASY v4.4 and higher (see Page 2), else it is restricted to ± 50 MHz. The uncertainty is the RSS of the ConvF uncertainty at calibration frequency and the uncertainty for the indicated frequency band.

^F At frequencies below 3 GHz, the validity of tissue parameters (ϵ and σ) can be relaxed to ± 10% if liquid compensation formula is applied to measured SAR values. At frequencies above 3 GHz, the validity of tissue parameters (ϵ and σ) is restricted to ± 5%. The uncertainty is the RSS of the ConvF uncertainty for indicated target tissue parameters.

Frequency Response of E-Field (TEM-Cell:ifi110 EXX, Waveguide: R22)

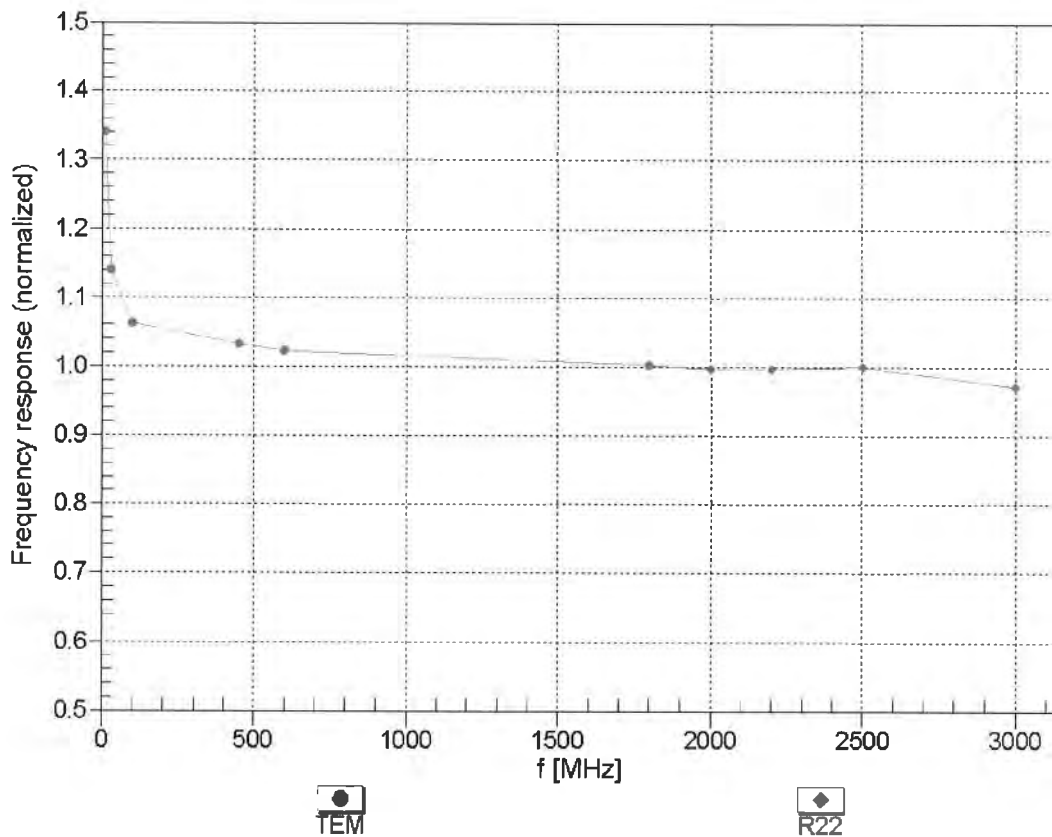

Uncertainty of Frequency Response of E-field: $\pm 6.3\%$ (k=2)

Receiving Pattern (ϕ), $\theta = 0^\circ$

f=600 MHz,TEM

f=1800 MHz,R22

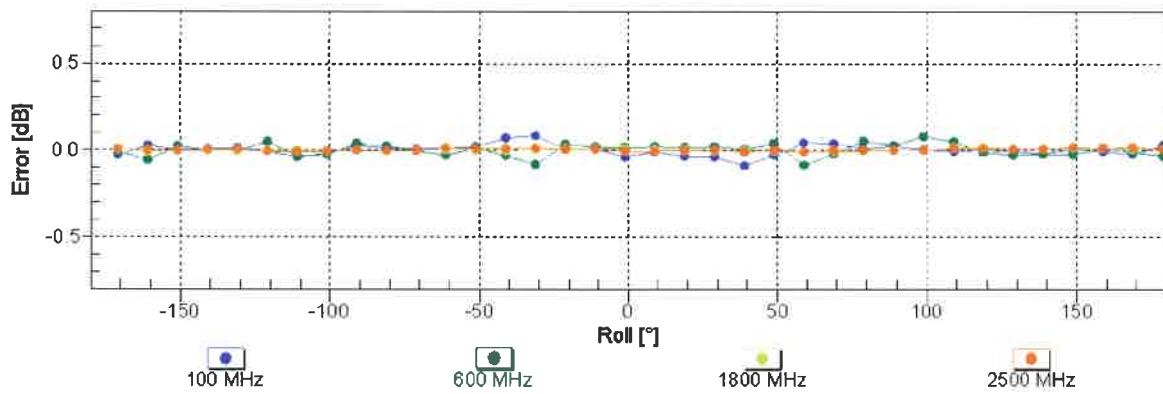
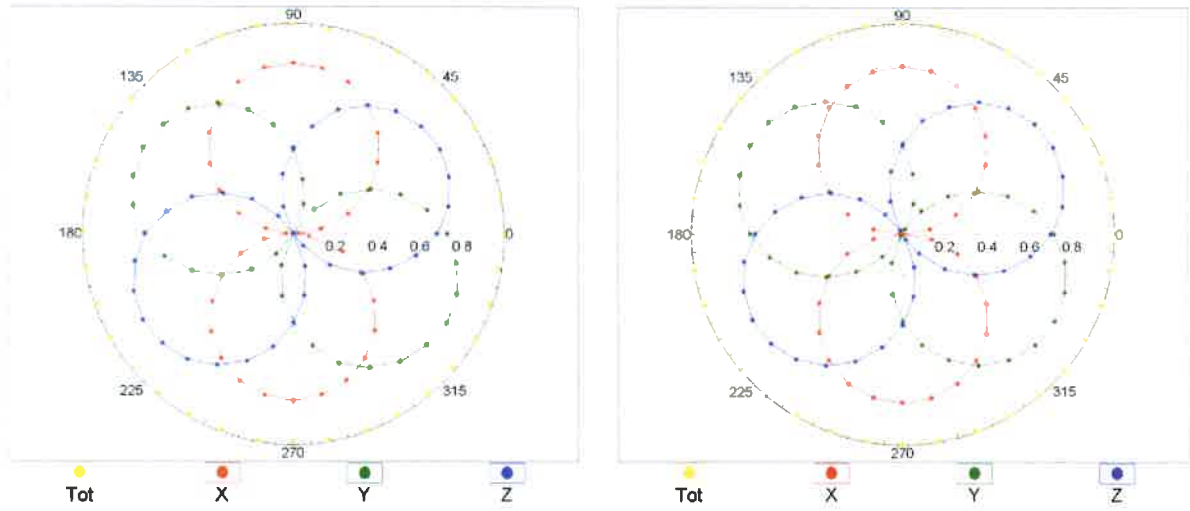

Uncertainty of Axial Isotropy Assessment: $\pm 0.5\%$ (k=2)

Dynamic Range f(SAR_{head}) (TEM cell , f = 900 MHz)

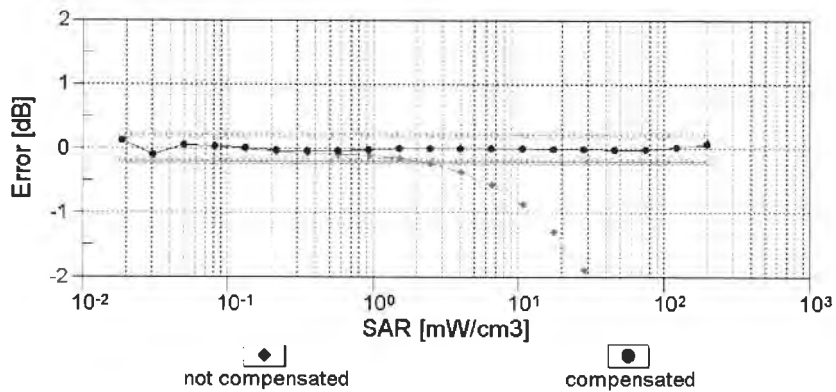
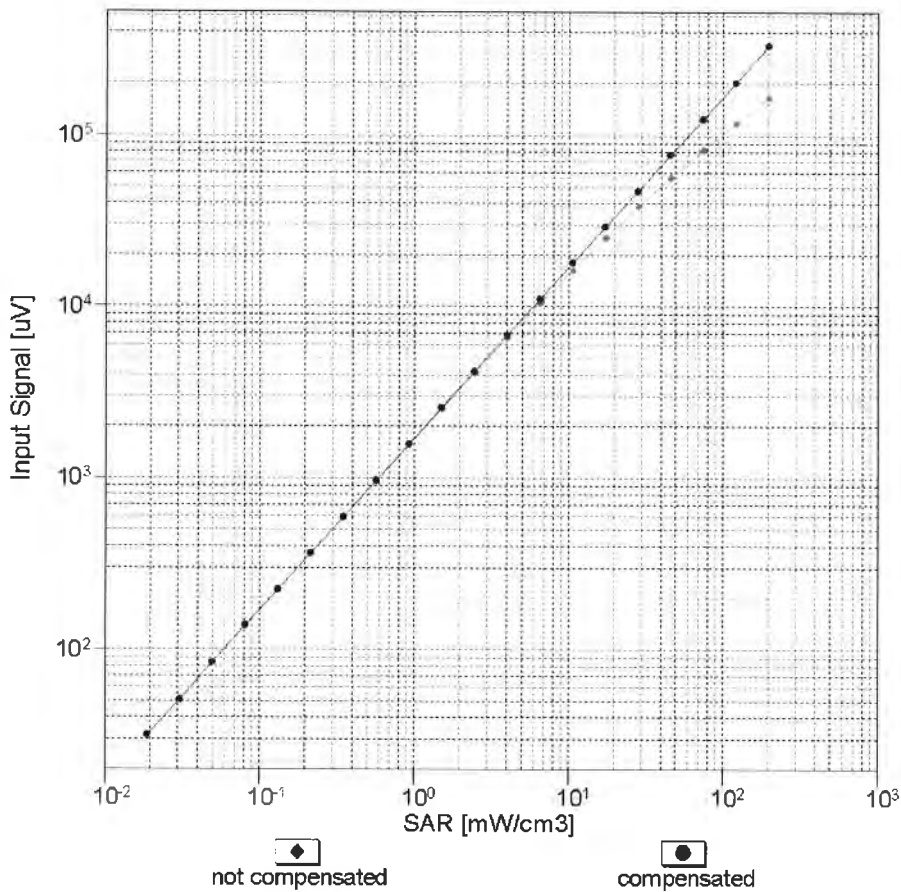

Uncertainty of Linearity Assessment: ± 0.6% (k=2)

Conversion Factor Assessment

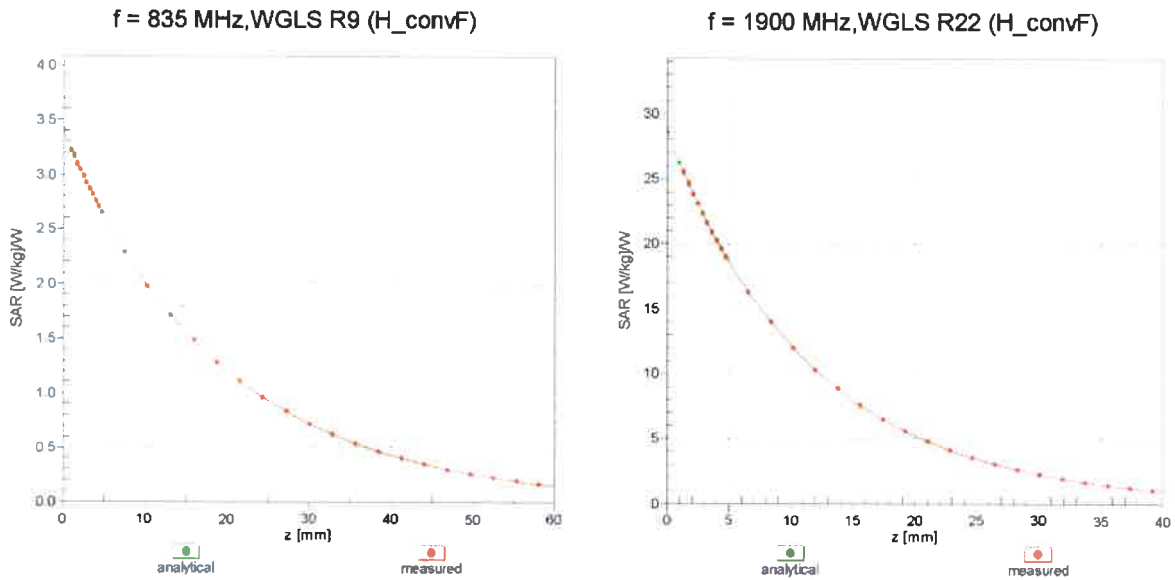

Deviation from Isotropy in Liquid Error (ϕ, ϑ), f = 900 MHz

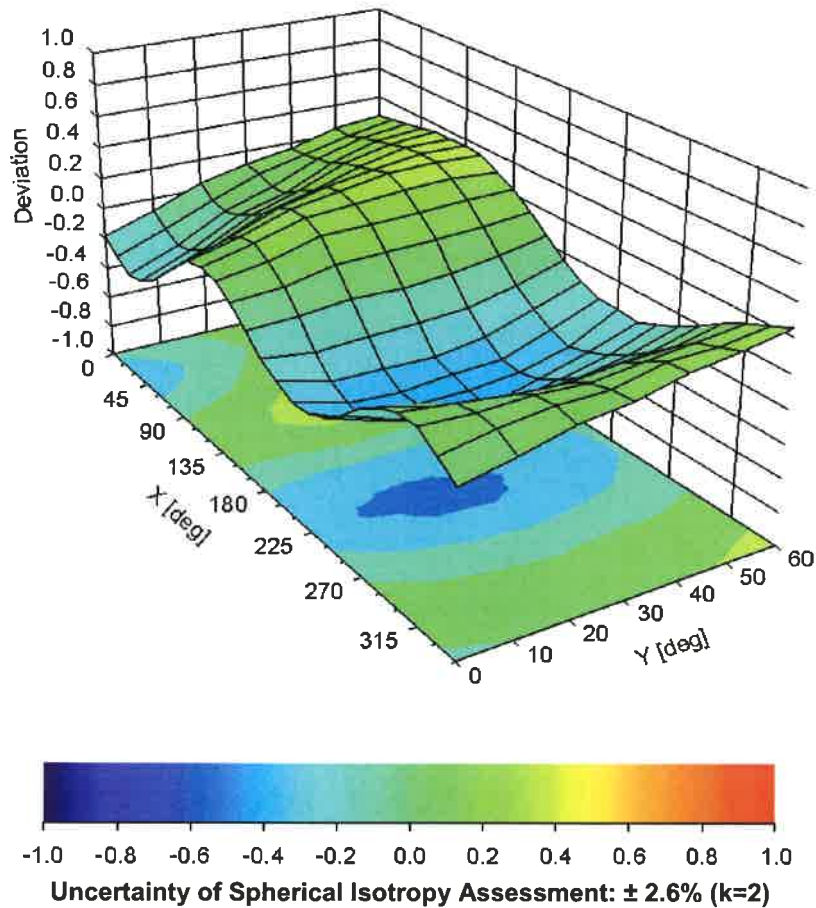

DASY/EASY - Parameters of Probe: EX3DV4 - SN:3650

Other Probe Parameters

Sensor Arrangement	Triangular
Connector Angle (°)	-21.1
Mechanical Surface Detection Mode	enabled
Optical Surface Detection Mode	disabled
Probe Overall Length	337 mm
Probe Body Diameter	10 mm
Tip Length	9 mm
Tip Diameter	2.5 mm
Probe Tip to Sensor X Calibration Point	1 mm
Probe Tip to Sensor Y Calibration Point	1 mm
Probe Tip to Sensor Z Calibration Point	1 mm
Recommended Measurement Distance from Surface	2 mm



Accredited by the Swiss Accreditation Service (SAS)
 The Swiss Accreditation Service is one of the signatories to the EA
 Multilateral Agreement for the recognition of calibration certificates

Accreditation No.: **SCS 108**

Client **Auden**

Certificate No: **EX3-3820_Dec12**

CALIBRATION CERTIFICATE

Object **EX3DV4 - SN:3820**

Calibration procedure(s) **QA CAL-01.v8, QA CAL-14.v3, QA CAL-23.v4, QA CAL-25.v4
 Calibration procedure for dosimetric E-field probes**

Calibration date: **December 10, 2012**

This calibration certificate documents the traceability to national standards, which realize the physical units of measurements (SI).
 The measurements and the uncertainties with confidence probability are given on the following pages and are part of the certificate.

All calibrations have been conducted in the closed laboratory facility: environment temperature (22 ± 3)°C and humidity < 70%.

Calibration Equipment used (M&TE critical for calibration)

Primary Standards	ID	Cal Date (Certificate No.)	Scheduled Calibration
Power meter E4419B	GB41293874	29-Mar-12 (No. 217-01508)	Apr-13
Power sensor E4412A	MY41498087	29-Mar-12 (No. 217-01508)	Apr-13
Reference 3 dB Attenuator	SN: S5054 (3c)	27-Mar-12 (No. 217-01531)	Apr-13
Reference 20 dB Attenuator	SN: S5086 (20b)	27-Mar-12 (No. 217-01529)	Apr-13
Reference 30 dB Attenuator	SN: S5129 (30b)	27-Mar-12 (No. 217-01532)	Apr-13
Reference Probe ES3DV2	SN: 3013	29-Dec-11 (No. ES3-3013_Dec11)	Dec-12
DAE4	SN: 660	20-Jun-12 (No. DAE4-660_Jun12)	Jun-13
Secondary Standards	ID	Check Date (in house)	Scheduled Check
RF generator HP 8648C	US3642U01700	4-Aug-99 (in house check Apr-11)	In house check: Apr-13
Network Analyzer HP 8753E	US37390585	18-Oct-01 (in house check Oct-12)	In house check: Oct-13

	Name	Function	Signature
Calibrated by:	Jeton Kastrati	Laboratory Technician	
Approved by:	Katja Pokovic	Technical Manager	

Issued: December 11, 2012

This calibration certificate shall not be reproduced except in full without written approval of the laboratory.



Accredited by the Swiss Accreditation Service (SAS)

Accreditation No.: **SCS 108**

The Swiss Accreditation Service is one of the signatories to the EA
Multilateral Agreement for the recognition of calibration certificates

Glossary:

TSL	tissue simulating liquid
NORM _{x,y,z}	sensitivity in free space
ConvF	sensitivity in TSL / NORM _{x,y,z}
DCP	diode compression point
CF	crest factor (1/duty_cycle) of the RF signal
A, B, C	modulation dependent linearization parameters
Polarization φ	φ rotation around probe axis
Polarization ϑ	ϑ rotation around an axis that is in the plane normal to probe axis (at measurement center), i.e., $\vartheta = 0$ is normal to probe axis

Calibration is Performed According to the Following Standards:

- IEEE Std 1528-2003, "IEEE Recommended Practice for Determining the Peak Spatial-Averaged Specific Absorption Rate (SAR) in the Human Head from Wireless Communications Devices: Measurement Techniques", December 2003
- IEC 62209-1, "Procedure to measure the Specific Absorption Rate (SAR) for hand-held devices used in close proximity to the ear (frequency range of 300 MHz to 3 GHz)", February 2005

Methods Applied and Interpretation of Parameters:

- NORM_{x,y,z}**: Assessed for E-field polarization $\vartheta = 0$ ($f \leq 900$ MHz in TEM-cell; $f > 1800$ MHz: R22 waveguide). NORM_{x,y,z} are only intermediate values, i.e., the uncertainties of NORM_{x,y,z} does not affect the E²-field uncertainty inside TSL (see below ConvF).
- NORM(f)_{x,y,z} = NORM_{x,y,z} * frequency_response** (see Frequency Response Chart). This linearization is implemented in DASY4 software versions later than 4.2. The uncertainty of the frequency response is included in the stated uncertainty of ConvF.
- DCP_{x,y,z}**: DCP are numerical linearization parameters assessed based on the data of power sweep with CW signal (no uncertainty required). DCP does not depend on frequency nor media.
- PAR**: PAR is the Peak to Average Ratio that is not calibrated but determined based on the signal characteristics
- A_{x,y,z}; B_{x,y,z}; C_{x,y,z}, VR_{x,y,z}**: A, B, C are numerical linearization parameters assessed based on the data of power sweep for specific modulation signal. The parameters do not depend on frequency nor media. VR is the maximum calibration range expressed in RMS voltage across the diode.
- ConvF and Boundary Effect Parameters**: Assessed in flat phantom using E-field (or Temperature Transfer Standard for $f \leq 800$ MHz) and inside waveguide using analytical field distributions based on power measurements for $f > 800$ MHz. The same setups are used for assessment of the parameters applied for boundary compensation (alpha, depth) of which typical uncertainty values are given. These parameters are used in DASY4 software to improve probe accuracy close to the boundary. The sensitivity in TSL corresponds to NORM_{x,y,z} * ConvF whereby the uncertainty corresponds to that given for ConvF. A frequency dependent ConvF is used in DASY version 4.4 and higher which allows extending the validity from ± 50 MHz to ± 100 MHz.
- Spherical isotropy (3D deviation from isotropy)**: in a field of low gradients realized using a flat phantom exposed by a patch antenna.
- Sensor Offset**: The sensor offset corresponds to the offset of virtual measurement center from the probe tip (on probe axis). No tolerance required.

Probe EX3DV4

SN:3820

Manufactured: September 2, 2011
Calibrated: December 10, 2012

Calibrated for DASY/EASY Systems
(Note: non-compatible with DASY2 system!)

DASY/EASY - Parameters of Probe: EX3DV4 - SN:3820

Basic Calibration Parameters

	Sensor X	Sensor Y	Sensor Z	Unc (k=2)
Norm ($\mu\text{V}/(\text{V}/\text{m})^2$) ^A	0.44	0.35	0.44	$\pm 10.1 \%$
DCP (mV) ^B	99.1	100.3	99.4	

Modulation Calibration Parameters

UID	Communication System Name	PAR		A dB	B dB	C dB	VR mV	Unc ^E (k=2)
0	CW	0.00	X	0.0	0.0	1.0	149.3	$\pm 3.0 \%$
			Y	0.0	0.0	1.0	179.2	
			Z	0.0	0.0	1.0	147.4	

The reported uncertainty of measurement is stated as the standard uncertainty of measurement multiplied by the coverage factor $k=2$, which for a normal distribution corresponds to a coverage probability of approximately 95%.

^A The uncertainties of NormX,Y,Z do not affect the E^2 -field uncertainty inside TSL (see Pages 5 and 6).

^B Numerical linearization parameter: uncertainty not required.

^E Uncertainty is determined using the max. deviation from linear response applying rectangular distribution and is expressed for the square of the field value.

DASY/EASY - Parameters of Probe: EX3DV4 - SN:3820

Calibration Parameter Determined in Head Tissue Simulating Media

f (MHz) ^C	Relative Permittivity ^F	Conductivity (S/m) ^F	ConvF X	ConvF Y	ConvF Z	Alpha	Depth (mm)	Unct. (k=2)
835	41.5	0.90	9.19	9.19	9.19	0.80	0.66	± 12.0 %
1750	40.1	1.37	7.81	7.81	7.81	0.49	0.77	± 12.0 %
1900	40.0	1.40	7.51	7.51	7.51	0.46	0.78	± 12.0 %
2100	39.8	1.49	7.64	7.64	7.64	0.42	0.81	± 12.0 %
2450	39.2	1.80	6.74	6.74	6.74	0.37	0.89	± 12.0 %
5200	36.0	4.66	5.01	5.01	5.01	0.45	1.80	± 13.1 %
5300	35.9	4.76	4.76	4.76	4.76	0.45	1.80	± 13.1 %
5500	35.6	4.96	4.58	4.58	4.58	0.45	1.80	± 13.1 %
5600	35.5	5.07	4.31	4.31	4.31	0.50	1.80	± 13.1 %
5800	35.3	5.27	4.52	4.52	4.52	0.45	1.80	± 13.1 %

^C Frequency validity of ± 100 MHz only applies for DASY v4.4 and higher (see Page 2), else it is restricted to ± 50 MHz. The uncertainty is the RSS of the ConvF uncertainty at calibration frequency and the uncertainty for the indicated frequency band.

^F At frequencies below 3 GHz, the validity of tissue parameters (ϵ and σ) can be relaxed to ± 10% if liquid compensation formula is applied to measured SAR values. At frequencies above 3 GHz, the validity of tissue parameters (ϵ and σ) is restricted to ± 5%. The uncertainty is the RSS of the ConvF uncertainty for indicated target tissue parameters.

DASY/EASY - Parameters of Probe: EX3DV4 - SN:3820

Calibration Parameter Determined in Body Tissue Simulating Media

f (MHz) ^C	Relative Permittivity ^F	Conductivity (S/m) ^F	ConvF X	ConvF Y	ConvF Z	Alpha	Depth (mm)	Unct. (k=2)
835	55.2	0.97	9.07	9.07	9.07	0.32	1.10	± 12.0 %
1750	53.4	1.49	7.60	7.60	7.60	0.37	0.91	± 12.0 %
1900	53.3	1.52	7.30	7.30	7.30	0.26	1.19	± 12.0 %
2100	53.2	1.62	7.56	7.56	7.56	0.25	1.17	± 12.0 %
2450	52.7	1.95	6.84	6.84	6.84	0.80	0.61	± 12.0 %
5200	49.0	5.30	4.23	4.23	4.23	0.50	1.90	± 13.1 %
5300	48.9	5.42	3.95	3.95	3.95	0.55	1.90	± 13.1 %
5500	48.6	5.65	3.63	3.63	3.63	0.60	1.90	± 13.1 %
5600	48.5	5.77	3.39	3.39	3.39	0.65	1.90	± 13.1 %
5800	48.2	6.00	3.83	3.83	3.83	0.60	1.90	± 13.1 %

^C Frequency validity of ± 100 MHz only applies for DASY v4.4 and higher (see Page 2), else it is restricted to ± 50 MHz. The uncertainty is the RSS of the ConvF uncertainty at calibration frequency and the uncertainty for the indicated frequency band.

^F At frequencies below 3 GHz, the validity of tissue parameters (ϵ and σ) can be relaxed to ± 10% if liquid compensation formula is applied to measured SAR values. At frequencies above 3 GHz, the validity of tissue parameters (ϵ and σ) is restricted to ± 5%. The uncertainty is the RSS of the ConvF uncertainty for indicated target tissue parameters.

Frequency Response of E-Field (TEM-Cell:ifi110 EXX, Waveguide: R22)

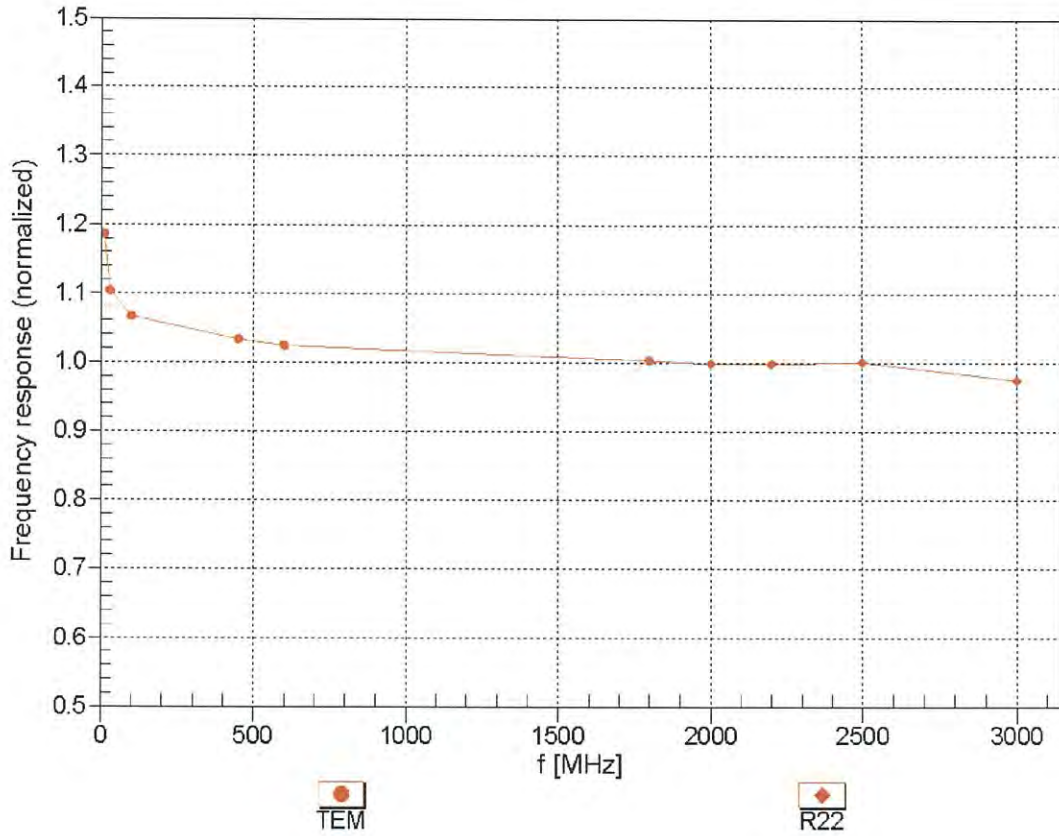

Uncertainty of Frequency Response of E-field: $\pm 6.3\%$ (k=2)

Receiving Pattern (ϕ), $\vartheta = 0^\circ$

f=600 MHz,TEM

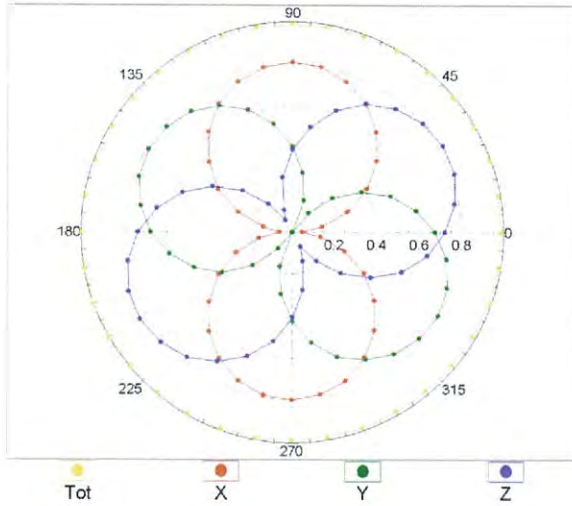

f=1800 MHz,R22

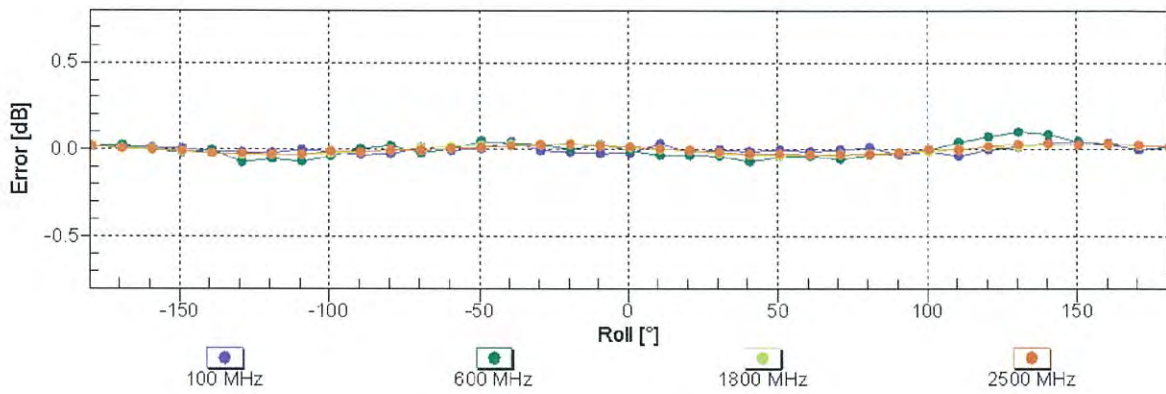
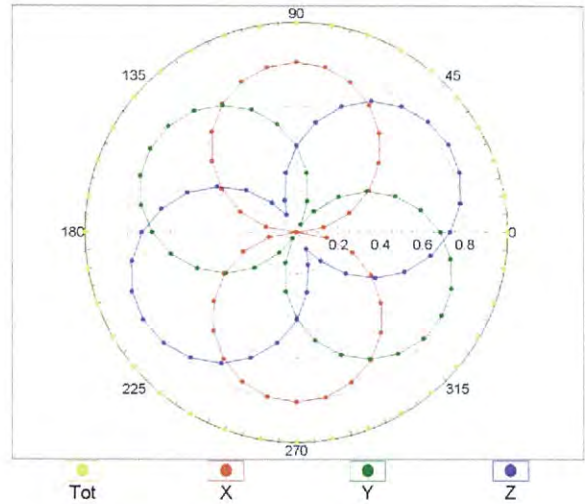

Uncertainty of Axial Isotropy Assessment: $\pm 0.5\%$ (k=2)

Dynamic Range f(SAR_{head}) (TEM cell , f = 900 MHz)

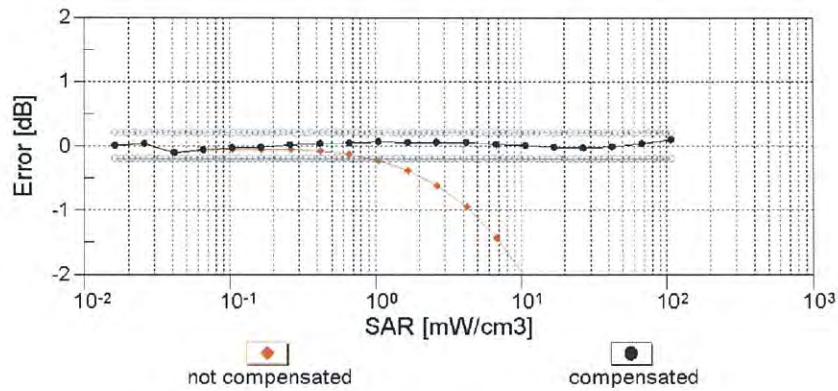
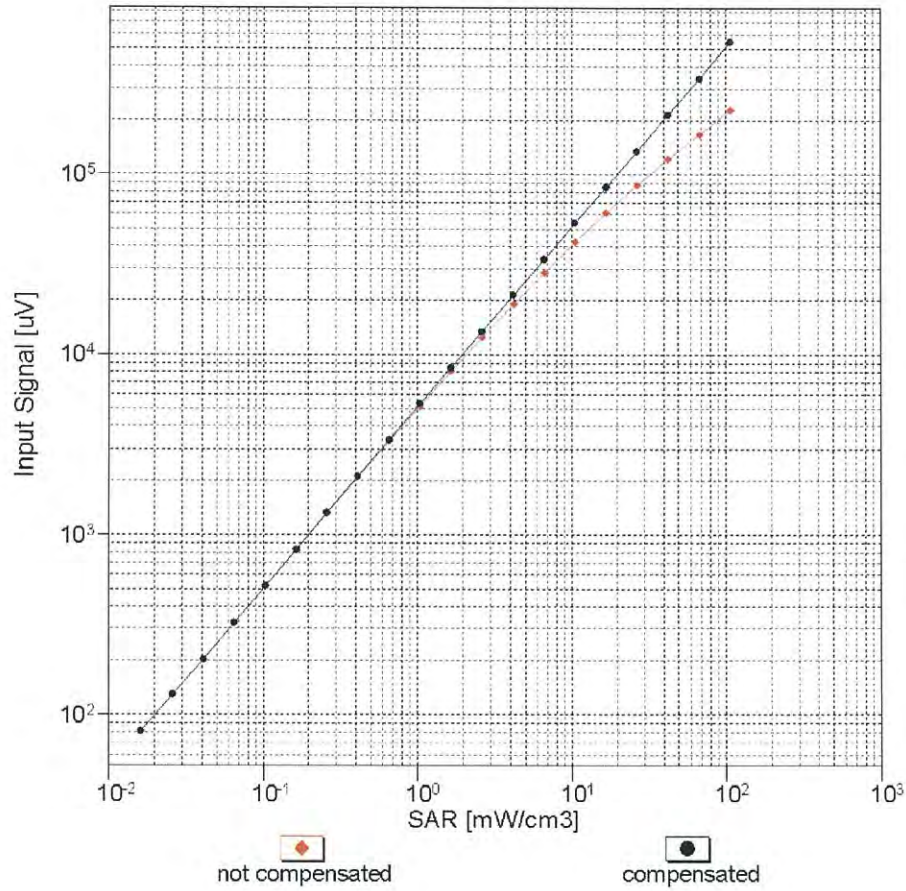

Uncertainty of Linearity Assessment: ± 0.6% (k=2)

Conversion Factor Assessment

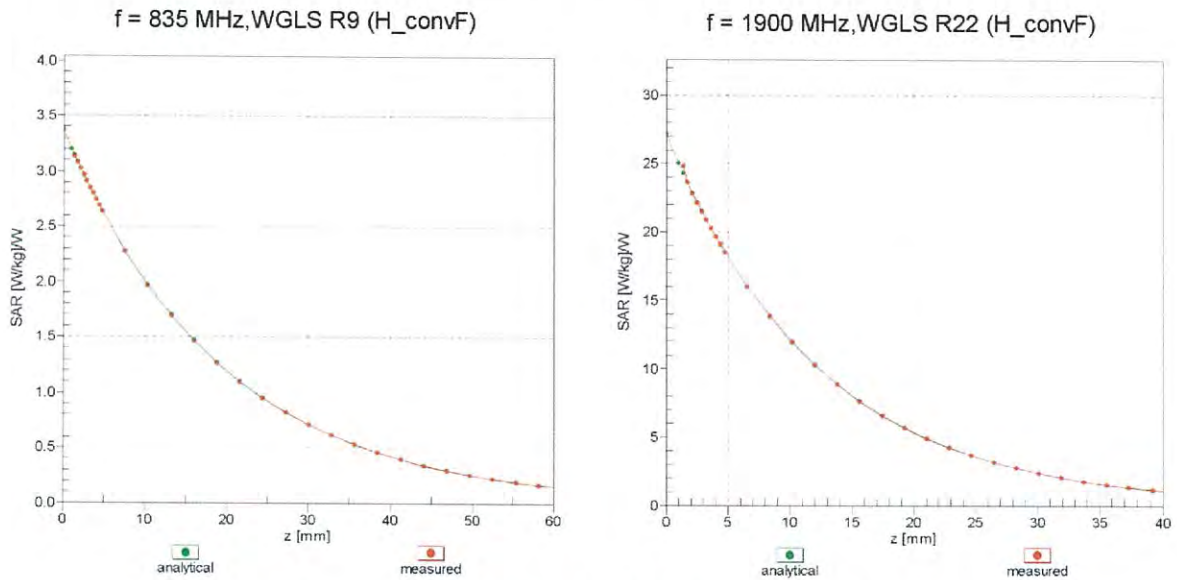

Deviation from Isotropy in Liquid Error (ϕ, ϑ), f = 900 MHz

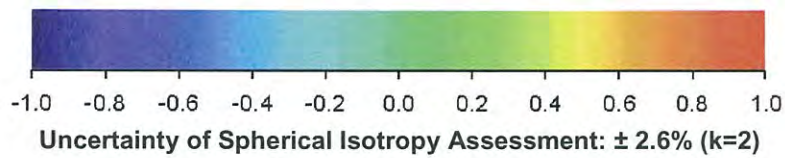
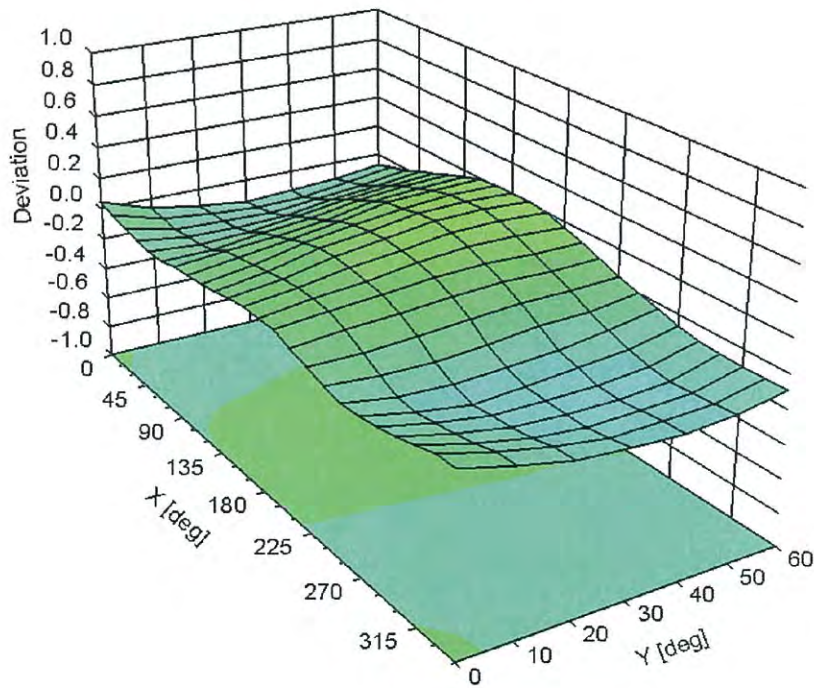

DASY/EASY - Parameters of Probe: EX3DV4 - SN:3820

Other Probe Parameters

Sensor Arrangement	Triangular
Connector Angle (°)	-69.3
Mechanical Surface Detection Mode	enabled
Optical Surface Detection Mode	disabled
Probe Overall Length	337 mm
Probe Body Diameter	10 mm
Tip Length	9 mm
Tip Diameter	2.5 mm
Probe Tip to Sensor X Calibration Point	1 mm
Probe Tip to Sensor Y Calibration Point	1 mm
Probe Tip to Sensor Z Calibration Point	1 mm
Recommended Measurement Distance from Surface	2 mm