

FCC Test Report

(PART 22)

Report No.: RF141112E01A-3 R1

FCC ID: MQT-XCE200WU

Test Model: xCE-200WU-UH

Series Model: xCE-200WU-U

Received Date: Dec. 29, 2014

Test Date: Feb. 02, 2015

Issued Date: Apr. 10, 2015

Applicant: XAC AUTOMATION CORP.

Address: 4F, No. 30, INDUSTRY E. RD. IX, SCIENCE-BASED INDUSTRIAL
PARK,HSINCHU,TAIWAN

Issued By: Bureau Veritas Consumer Products Services (H.K.) Ltd., Taoyuan Branch
Hsin Chu Laboratory

Lab Address: No. 81-1, Lu Liao Keng, 9th Ling,Wu Lung Tsuen, Chiung Lin Hsiang, Hsin
Chu Hsien 307, Taiwan R.O.C.

Test Location (1): No. 81-1, Lu Liao Keng, 9th Ling,Wu Lung Tsuen, Chiung Lin Hsiang, Hsin
Chu Hsien 307, Taiwan R.O.C.

Test Location (2): No. 49, Ln. 206, Wende Rd., Shangshan Tsuen, Chiung Lin Hsiang, Hsin
Chu Hsien 307, Taiwan R.O.C.



This report is for your exclusive use. Any copying or replication of this report to or for any other person or entity, or use of our name or trademark, is permitted only with our prior written permission. This report sets forth our findings solely with respect to the test samples identified herein. The results set forth in this report are not indicative or representative of the quality or characteristics of the lot from which a test sample was taken or any similar or identical product unless specifically and expressly noted. Our report includes all of the tests requested by you and the results thereof based upon the information that you provided to us. You have 60 days from date of issuance of this report to notify us of any material error or omission caused by our negligence, provided, however, that such notice shall be in writing and shall specifically address the issue you wish to raise. A failure to raise such issue within the prescribed time shall constitute your unqualified acceptance of the completeness of this report, the tests conducted and the correctness of the report contents. Unless specific mention, the uncertainty of measurement has been explicitly taken into account to declare the compliance or non-compliance to the specification. The report must not be used by the client to claim product certification, approval, or endorsement by TAF or any government agencies

Table of Contents

Release Control Record	3
1 Certificate of Conformity	4
2 Summary of Test Results	5
2.1 Measurement Uncertainty	5
2.2 Test Site And Instruments	6
3 General Information	8
3.1 General Description of EUT	8
3.2 Configuration of System under Test.....	10
3.2.1 Description of Support Units.....	11
3.3 Test Mode Applicability and Tested Channel Detail	12
3.4 EUT Operating Conditions	13
3.5 General Description of Applied Standards	13
4 Test Types and Results	14
4.1 Output Power Measurement	14
4.1.1 Limits of Output Power Measurement.....	14
4.1.2 Test Procedures.....	14
4.1.3 Test Setup.....	15
4.1.4 Test Results	16
4.2 Frequency Stability Measurement	18
4.2.1 Limits of Frequency Stability Measurement	18
4.2.2 Test Procedure	18
4.2.3 Test Setup.....	19
4.2.4 Test Results	19
4.3 Occupied Bandwidth Measurement	20
4.3.1 Test Procedure	20
4.3.2 Test Setup.....	20
4.3.3 Test Result.....	21
4.4 Band Edge Measurement	22
4.4.1 Limits of Band Edge Measurement	22
4.4.2 Test Setup.....	22
4.4.3 Test Procedures.....	22
4.4.4 Test Results	23
4.5 Peak To Average Ratio.....	25
4.5.1 Limits of Peak To Average Ratio Measurement	25
4.5.2 Test Setup.....	25
4.5.3 Test Procedures	25
4.5.4 Test Results.....	26
4.6 Conducted Spurious Emissions	27
4.6.1 Limits of Conducted Spurious Emissions Measurement.....	27
4.6.2 Test Setup.....	27
4.6.3 Test Procedure	27
4.6.4 Test Results	28
4.7 Radiated Emission Measurement	31
4.7.1 Limits of Radiated Emission Measurement.....	31
4.7.2 Test Procedure	31
4.7.3 Deviation from Test Standard	31
4.7.4 Test Setup.....	32
4.7.5 Test Results	33
5 Pictures of Test Arrangements	39
Appendix – Information on the Testing Laboratories	40



Release Control Record

Issue No.	Description	Date Issued
RF141112E01A-3	Original release.	Feb. 16, 2015
RF141112E01A-3 R1	1. Added the model names. 2. Modified the antenna model name and gain.	Apr. 10, 2015



1 Certificate of Conformity

Product: Terminal

Brand: XAC

Test Model: xCE-200WU-UH

Series Model: xCE-200WU-U

Sample Status: ENGINEERING SAMPLE

Applicant: XAC AUTOMATION CORP.

Test Date: Feb. 02, 2015

Standards: FCC Part 22, Subpart H

The above equipment has been tested by **Bureau Veritas Consumer Products Services (H.K.) Ltd., Taoyuan Branch**, and found compliance with the requirement of the above standards. The test record, data evaluation & Equipment Under Test (EUT) configurations represented herein are true and accurate accounts of the measurements of the sample's EMC characteristics under the conditions specified in this report.

Prepared by :  , **Date:** Apr. 10, 2015
Claire Kuan / Specialist

Approved by :  , **Date:** Apr. 10, 2015
May Chen / Manager

2 Summary of Test Results

Applied Standard: FCC Part 22 & Part 2			
FCC Clause	Test Item	Result	Remarks
2.1046 22.913 (a)	Effective radiated power	PASS	Meet the requirement of limit.
---	Peak To Average Ratio	PASS	Meet the requirement of limit.
2.1055 22.355	Frequency Stability	PASS	Meet the requirement of limit.
2.1049	Occupied Bandwidth	PASS	Meet the requirement of limit.
22.917	Band Edge Measurements	PASS	Meet the requirement of limit.
2.1051 22.917	Conducted Spurious Emissions	PASS	Meet the requirement of limit.
2.1053 22.917	Radiated Spurious Emissions	PASS	Meet the requirement of limit. Minimum passing margin is -21.20dB at 1672.8MHz.

2.1 Measurement Uncertainty

Where relevant, the following measurement uncertainty levels have been estimated for tests performed on the EUT as specified in CISPR 16-4-2:

Measurement	Frequency	Expanded Uncertainty (k=2) (±)
Radiated Emissions up to 1 GHz	30MHz ~ 1GHz	5.37 dB
Radiated Emissions above 1 GHz	1GHz ~ 6GHz	3.65 dB
	6GHz ~ 18GHz	3.88 dB
	18GHz ~ 40GHz	4.11 dB

2.2 Test Site And Instruments

For Radiated Spurious Emissions test:

DESCRIPTION & MANUFACTURER	MODEL NO.	SERIAL NO.	CALIBRATED DATE	CALIBRATED UNTIL
MXE EMI Receiver Agilent	N9038A	MY51210105	July 21, 2014	July 20, 2015
Pre-Amplifier Mini-Circuits	ZFL-1000VH2 B	AMP-ZFL-03	Nov. 12, 2014	Nov. 11, 2015
Trilog Broadband Antenna SCHWARZBECK	VULB 9168	9168-360	Feb. 26, 2014	Feb. 25, 2015
RF Cable	NA	CHGCAB_001	Oct. 04, 2014	Oct. 03, 2015
Horn_Antenna AISI	AIH.8018	0000320091110	Aug. 27, 2014	Aug. 26, 2015
Pre-Amplifier Agilent	8449B	3008A02578	June 24, 2014	June 23, 2015
RF Cable	NA	131205 131214 SNMY23684/4	Jan. 16, 2015	Jan. 15, 2016
Spectrum Analyzer R&S	FSV40	100964	July 05, 2014	July 04, 2015
Pre-Amplifier EMCI	EMC184045	980143	Jan. 16, 2015	Jan. 15, 2016
Horn_Antenna SCHWARZBECK	BBHA 9170	9170-424	Aug. 26, 2014	Aug. 25, 2015
RF Cable	NA	RF104-121 RF104-204	Dec. 11, 2014	Dec. 10, 2015
Antenna Tower & Turn Table CT	NA	NA	NA	NA

Note:

1. The calibration interval of the above test instruments is 12 months and the calibrations are traceable to NML/ROC and NIST/USA.
2. The horn antenna, preamplifier (model: 8449B) are used only for the measurement of emission frequency above 1GHz if tested.
3. The test was performed in 966 Chamber No. G.
4. The FCC Site Registration No. is 966073.
5. The VCCI Site Registration No. is G-137.
6. The CANADA Site Registration No. is IC 7450H-2.
7. Tested Date: Feb. 02, 2015

For other test items:

DESCRIPTION & MANUFACTURER	MODEL NO.	SERIAL NO.	CALIBRATED DATE	CALIBRATED UNTIL
Spectrum Analyzer R&S	FSP 40	100037	Oct. 30, 2014	Oct. 29, 2015
Spectrum Analyzer Agilent	E4446A	MY48250253	Dec. 18, 2014	Dec. 17, 2015
AC Power Source EXTECH Electronics	6502	1140503	NA	NA
Temperature & Humidity Chamber TERCHY	MHU-225AU	911033	Dec. 08, 2014	Dec. 07, 2015
DC Power Supply GOOD WILL INSTRUMENT CO., LTD.	GPC - 3030D	7700087	NA	NA
ESG Vector signal generator Agilent	E4438C	MY47271330 506 602 UNJ	Apr. 28, 2014	Apr. 27, 2015
Upgrade the software license on current E4438C ESG Agilent	E4438CK-403	ESG E4_010004	NA	NA
ESG Vector signal generator Agilent	E4438C	MY45094468/ 005 506 602 UK6 UNJ	Dec. 05, 2014	Dec. 04, 2015
Upgrade the software license on current E4438C ESG Agilent	E4438CK-403	ESG E4_010001	NA	NA
Power meter Anritsu	ML2495A	0824006	May 22, 2014	May 21, 2015
Power sensor Anritsu	MA2411B	0738172	May 22, 2014	May 21, 2015
Software	ADT_RF Test Software V6.6.5.3	NA	NA	NA
Universal Radio Communication Tester R&S	CMU200	121040	Dec. 16, 2014	Dec. 15, 2015
Radio Communication Analyzer Anritsu	MT8820C	6201127458	Mar. 05, 2014	Mar. 04, 2015

- NOTE:**
1. The test was performed in Oven room A.
 2. The calibration interval of the above test instruments is 12 months and the calibrations are traceable to NML/ROC and NIST/USA.
 3. Tested Date: Feb. 02, 2015

3 General Information

3.1 General Description of EUT

Product	Terminal	
Brand	XAC	
Test Model	xCE-200WU-UH	
Series Model	xCE-200WU-U	
IMEI Code	35999804	
HW Version	A07	
SW Version	02131413	
WCDMA Release Version	6	
Status of EUT	ENGINEERING SAMPLE	
Power Supply Rating	12Vdc from power adapter	
Modulation Type	GPRS	GMSK
	EDGE	GMSK, 8PSK
	WCDMA, HSDPA, HSUPA	BPSK
Operating Frequency	GPRS, EDGE	824.2MHz ~ 848.8MHz
	WCDMA, HSDPA, HSUPA	826.4MHz ~ 846.6MHz
Max. ERP Power	GPRS	891.25mW
	EDGE	309.03mW
	WCDMA	241.5mW
Emission Designator	GPRS	246KG7W
	EDGE	246KG7W
	WCDMA	4M09F9W
	HSDPA	4M07F9W
	HSUPA	4M09F9W
Antenna Type	Please see NOTE	
Antenna Connector	Please see NOTE	
Accessory Device	Adapter × 1 Handset × 1	
Data Cable Supplied	NA	

Note:

1. The EUT has below model names, which are identical to each other in all aspects except for the following table:

Brand Name	Model No.	Description
XAC	xCE-200WU-UH	With 3G (Voice+Data) function and has Handset.
	xCE-200WU-U	With 3G (Data) function.

From the above models, model: **xCE-200WU-UH** was selected as representative model for the test and its data was recorded in this report.

2. WLAN, Bluetooth, GSM and WCDMA technology can transmit at same time.
3. The EUT could be supplied with a power adapter as the following table:

Brand	Model No.	Spec.
LITEON	PA-1061-71	AC I/P: 100-240V, 50-60Hz, 1.5A AC input cable (Unshielded, 1.8m) DC O/P: 12V, 5A DC output cable(Unshielded, 1.05m, with one core)

4. The antennas provided to the EUT, please refer to the following table:

GSM / WCDMA Antenna Spec.					
Brand	Model No.	Antenna Type	Antenna Connector	Gain(dBi)	Frequency (MHz)
Ethertronics Inc.	T-000084-01	FPCB	NA	0.14	850
				2.57	1900
WLAN / Bluetooth Antenna Spec.					
Brand	Model No.	Antenna Type	Antenna Connector	Gain(dBi)	Frequency (MHz)
ACX	AT8010-E2R9HAA	Chip	NA	2.5	2400-2500

5. When EUT is under LAN mode, the EUT wireless function will be disabled.

6. The above EUT information is declared by manufacturer and for more detailed features description, please refer to the manufacturer's specifications or User's Manual.

3.2 Configuration of System under Test

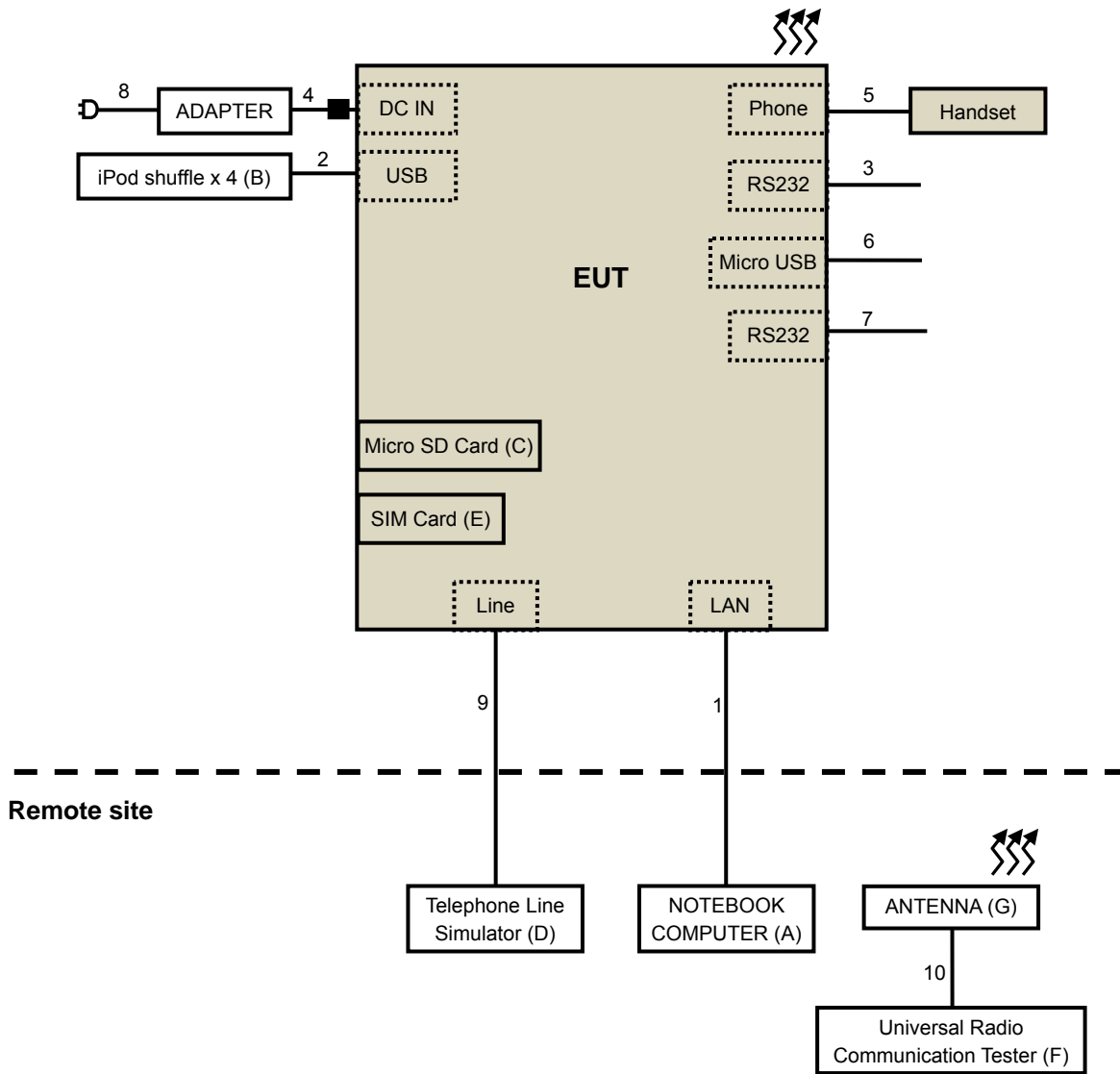

3.2.1 Description of Support Units

The EUT has been tested as an independent unit together with other necessary accessories or support units. The following support units or accessories were used to form a representative test configuration during the tests.

No.	Product	Brand	Model No.	Serial No.	FCC ID	Remark
A	NOTEBOOK COMUPTER	DELL	PP32LA	GSLB32S	FCC DoC	Provided by Lab
B	iPod shuffle	Apple	MC749TA/A	CC4DMFKUDFDM	NA	Provided by Lab
	iPod shuffle	Apple	MD778TA/A	CC4JMA9KF4T1	NA	Provided by Lab
	iPod shuffle	Apple	MC749TA/A	CC4DN25WDFDM	NA	Provided by Lab
	iPod shuffle	Apple	MC749TA/A	CC4DN29UDFDM	NA	Provided by Lab
C	Micro SD Card	Sandisk	2GB	NA	NA	Provided by Lab
D	SIM Card	NA	NA	NA	NA	Provided by Lab
E	Telephone Line Simulator	TELTONE	TLS-5C-01	250-00193-07	NA	Provided by Lab
F	Universal Radio Communication Tester	R&S	CMU200	121040	NA	Provided by Lab
G	ANTENNA	NI	Labview ver5.1	G11X54250	NA	Provided by Lab

NOTE:

1. All power cords of the above support units are non-shielded (1.8 m).

No.	Cable	Qty.	Length (m)	Shielded (Yes/ No)	Cores (Number)	Remark
1	RJ-45	1	10	No	0	Provided by Lab
2	USB	4	0.1	No	0	Provided by Lab
3	RS232	1	1.5	No	0	Supplied by Client
4	DC	1	1.05	No	1	Supplied by Client
5	RJ-11	1	1.5	No	0	Provided by Lab
6	Micro USB	1	1.5	No	0	Provided by Lab
7	RS232	1	1.5	No	0	Supplied by Client
8	AC	1	1.8	No	0	Supplied by Client
9	RJ-11	1	10	No	0	Provided by Lab
10	RF	1	10	Yes	0	Provided by Lab

NOTE:

1. The core(s) is(are) originally attached to the cable(s).

3.3 Test Mode Applicability and Tested Channel Detail

Pre-Scan has been conducted to determine the worst-case mode from all possible combinations between available modulations, data rates, XYZ axis and antenna ports

The worst case was found when positioned on Z-plane. Following channel(s) was (were) selected for the final test as listed below:

GPRS MODE

Test Item	Available Channel	Tested Channel	Mode
ERP	128 to 251	128, 189, 251	GPRS, EDGE
Frequency Stability	128 to 251	189	GPRS
Occupied Bandwidth	128 to 251	128, 189, 251	GPRS, EDGE
Band Edge	128 to 251	128, 251	GPRS, EDGE
Peak To Average Ratio	128 to 251	128, 189, 251	GPRS, EDGE
Conducuted Emission	128 to 251	189	GPRS, EDGE
Radiated Emission Below 1GHz	128 to 251	189	GPRS, EDGE
Radiated Emission Above 1GHz	128 to 251	189	GPRS, EDGE

WCDMA MODE

Test Item	Available Channel	Tested Channel	Mode
ERP	4132 to 4233	4132, 4182, 4233	WCDMA
Frequency Stability	4132 to 4233	4182	WCDMA
Occupied Bandwidth	4132 to 4233	4132, 4182, 4233	WCDMA, HSDPA, HSUPA
Band Edge	4132 to 4233	4132, 4233	WCDMA, HSDPA, HSUPA
Peak To Average Ratio	4132 to 4233	4132, 4182, 4233	WCDMA
Conducuted Emission	4132 to 4233	4182	WCDMA, HSDPA, HSUPA
Radiated Emission Below 1GHz	4132 to 4233	4182	WCDMA
Radiated Emission Above 1GHz	4132 to 4233	4182	WCDMA

Test Condition:

Test Item	Environmental Conditions	Input Power	Tested By
ERP	25deg. C, 63%RH	120Vac, 60Hz	Robert Cheng
Frequency Stability	25deg. C, 63%RH	120Vac, 60Hz	Robert Cheng
Occupied Bandwidth	25deg. C, 63%RH	120Vac, 60Hz	Robert Cheng
Band Edge	25deg. C, 63%RH	120Vac, 60Hz	Robert Cheng
Peak To Average Ratio	24deg. C, 64%RH	120Vac, 60Hz	Robert Cheng
Conducuted Emission	25deg. C, 63%RH	120Vac, 60Hz	Robert Cheng
Radiated Emission Below 1GHz	25deg. C, 68%RH	120Vac, 60Hz	Tim Ho
Radiated Emission Above 1GHz	25deg. C, 68%RH	120Vac, 60Hz	Tim Ho

3.4 EUT Operating Conditions

The EUT makes a call to the communication simulator. The communication simulator station system controlled a EUT to export maximum output power under transmission mode and specific channel frequency

3.5 General Description of Applied Standards

The EUT is a RF Product. According to the specifications of the manufacturer, it must comply with the requirements of the following standards:

FCC 47 CFR Part 2

FCC 47 CFR Part 22

KDB 971168 D01 Power Meas License Digital Systems v02r01

ANSI/TIA/EIA-603-C 2004

NOTE: All test items have been performed and recorded as per the above standards.

4 Test Types and Results

4.1 Output Power Measurement

4.1.1 Limits of Output Power Measurement

Mobile / Portable station are limited to 7 watts e.r.p.

4.1.2 Test Procedures

EIRP / ERP Measurement:

- a. All measurements were done at low, middle and high operational frequency range. RBW and VBW is 1MHz for GPRS and 5MHz for WCDMA mode.
- b. Substitution method is used for EIRP measurement. In the semi-anechoic chamber, EUT placed on the 0.8m height of Turn Table, rotated the table around 360 degrees to search the maximum radiation power and receiver antenna shall be rotated vertical and horizontal polarization and moved height from 1m to 4m to find the maximum polar radiated power. The "Read Value" is the spectrum reading the maximum power value.
- c. The substitution horn antenna is substituted for EUT at the same position and signals generator export the CW signal to the substitution antenna via a tx cable. Rotated the Turn Table and moved receiving antenna to find the maximum radiation power. Adjust output power level of S.G to get a Value of spectrum reading equal to "Read Value" of step b. Record the power level of S.G
- d. $EIRP = \text{Output power level of S.G} - \text{TX cable loss} + \text{Antenna gain of substitution horn}$ ERP power can be calculated form EIRP power by subtracting the gain of dipole, $ERP \text{ power} = EIPR \text{ power} - 2.15dBi$.

Conducted Power Measurement:

The EUT was set up for the maximum power with GPRS & WCDMA link data modulation and link up with simulator. Set the EUT to transmit under low, middle and high channel and record the power level shown on simulator.

4.1.3 Test Setup
EIRP / ERP MEASUREMENT:

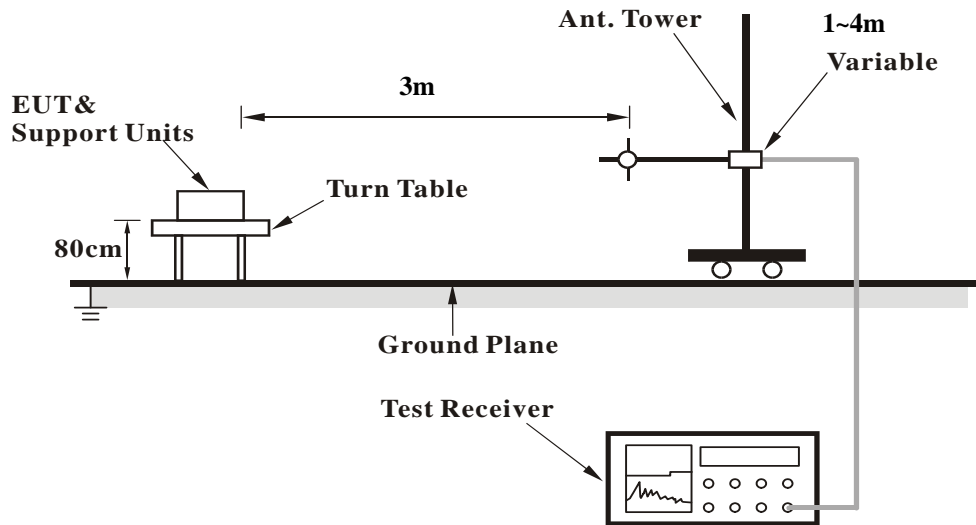

For the actual test configuration, please refer to the attached file (Test Setup Photo).

CONDUCTED POWER MEASUREMENT:

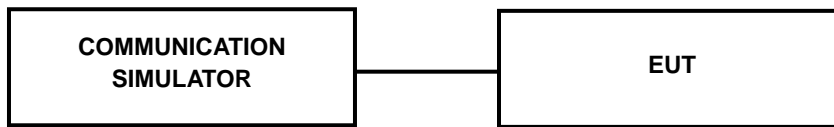

For the actual test configuration, please refer to the attached file (Test Setup Photo).

4.1.4 Test Results

CONDUCTED OUTPUT POWER (dBm)

Band	GPRS850		
Channel	128	189	251
Frequency (MHz)	824.2	836.4	848.8
GPRS 8	32.3	32.5	32.3
GPRS 10	29.4	29.4	29.5
GPRS 11	27.6	27.9	27.7
GPRS 12	26.6	26.7	26.4
EDGE 8 (MCS9)	26.6	26.8	26.7
EDGE 10 (MCS9)	23.7	23.7	23.7
EDGE 11 (MCS9)	21.8	21.9	21.9
EDGE 12 (MCS9)	20.5	20.5	20.5

Band	WCDMA V		
Channel	4132	4182	4233
Frequency (MHz)	826.4	836.4	846.6
RMC	26.43	25.54	25.65
HSDPA Subtest-1	26.35	25.46	25.56
HSDPA Subtest-2	26.39	25.48	25.61
HSDPA Subtest-3	26.28	25.39	25.47
HSDPA Subtest-4	26.34	25.54	25.64
HSUPA Subtest-1	26.35	25.46	25.62
HSUPA Subtest-2	26.34	25.41	25.47
HSUPA Subtest-3	26.35	25.49	25.62
HSUPA Subtest-4	26.31	25.45	25.56
HSUPA Subtest-5	26.36	25.44	25.59

ERP POWER (dBm)
GPRS

Channel	Frequency (MHz)	LVL (dBm)	Correction Factor(dB)	ERP(dBm)	ERP(mW)
128	824.2	26.8	2.7	29.50	891.25
189	826.4	26.6	2.7	29.30	851.14
251	848.8	26.7	2.7	29.40	870.96

EDGE

Channel	Frequency (MHz)	LVL (dBm)	Correction Factor(dB)	ERP(dBm)	ERP(mW)
128	824.2	22.0	2.7	24.70	295.12
189	826.4	22.0	2.7	24.70	295.12
251	848.8	22.2	2.7	24.90	309.03

WCDMA

Channel	Frequency (MHz)	LVL (dBm)	Correction Factor(dB)	ERP(dBm)	ERP(mW)
4132	826.4	21.1	2.7	23.83	241.5
4182	826.4	19.8	2.7	22.52	178.8
4233	846.6	20.8	2.7	23.52	224.9

REMARKS: 1. Output Power (dBm) = SPA Reading (dBm) + Correction Factor (dB).
 2. Correction factor (dB) = Free Space Loss + Antenna Factor + Cable Loss.

4.2 Frequency Stability Measurement

4.2.1 Limits of Frequency Stability Measurement

1.5 ppm is for base and fixed station. 2.5 ppm is for mobile station.

4.2.2 Test Procedure

- a. Device is placed at the oven room. The oven room could control the temperatures and humidity. Power warm up is at least 15 min and power applied should perform before recording frequency error.
- b. EUT is connected the external power supply to control the DC input power. The test voltage range is from minimum to maximum working voltage. Each step shall be record the frequency error rate.
- c. The temperature range step is 10 degrees in this test items. All temperature levels shall be hold the ± 0.5 °C during the measurement testing. The each temperature step shall be at least 0.5 hours, consider the EUT could be test under the stability condition.

NOTE: The frequency error was recorded frequency error from the communication simulator.

4.2.3 Test Setup

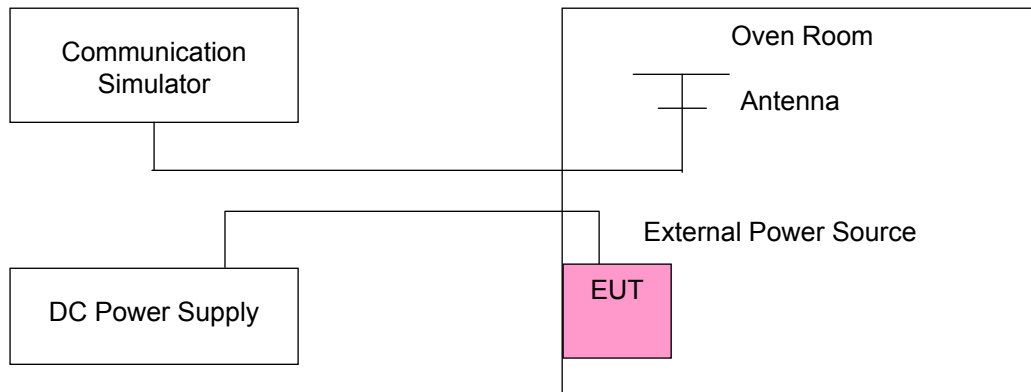

4.2.4 Test Results

Frequency Error vs. Voltage

Voltage (Volts)	Frequency Error (ppm)		Limit (ppm)
	GPRS	WCDMA	
102	0.020	0.012	2.5
138	0.018	0.010	2.5

NOTE: The applicant defined the normal working voltage of the battery is from 3.51Vdc to 4.29Vdc.

Frequency Error vs. Temperature.

TEMP. (°C)	Frequency Error (ppm)		Limit (ppm)
	GPRS	WCDMA	
75	0.041	0.027	2.5
70	0.036	0.026	2.5
60	0.037	0.024	2.5
50	0.031	0.019	2.5
40	0.029	0.017	2.5
30	0.024	0.012	2.5
20	0.023	0.010	2.5
10	0.024	0.013	2.5
0	0.026	0.012	2.5
-10	0.033	0.017	2.5
-20	0.035	0.019	2.5
-30	0.037	0.020	2.5

4.3 Occupied Bandwidth Measurement

4.3.1 Test Procedure

The EUT makes a call to the communication simulator. All measurements were done at low, middle and high operational frequency range. The communication simulator station system controlled a EUT to export maximum output power under transmission mode and specific channel frequency. Use OBW measurement function of Spectrum analyzer to measure 99 % occupied bandwidth.

4.3.2 Test Setup

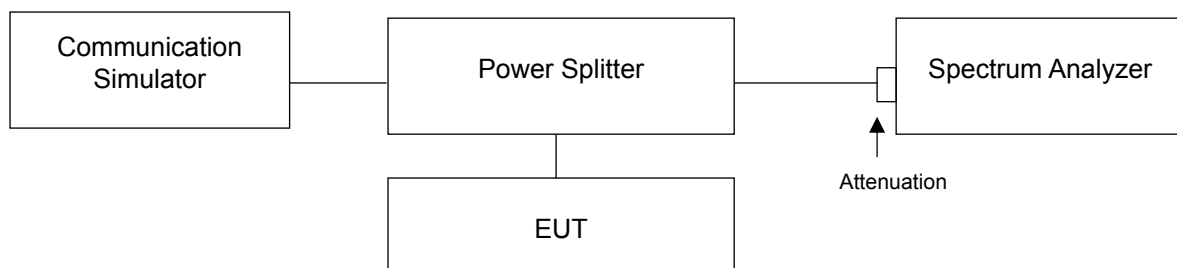

4.3.3 Test Result

GPRS / EDGE

Channel	Frequency (MHz)	99% Occupied Bandwidth (kHz)		Channel	FREQ. (MHz)	99% Occupied Bandwidth (MHz)		
		GPRS	EDGE			WCDMA	HSDPA	HSUPA
128	824.2	242.03	246.38	4132	826.4	4.07	4.07	4.06
189	836.4	243.48	244.93	4182	836.4	4.07	4.06	4.06
251	848.8	246.38	243.48	4233	846.6	4.09	4.07	4.09

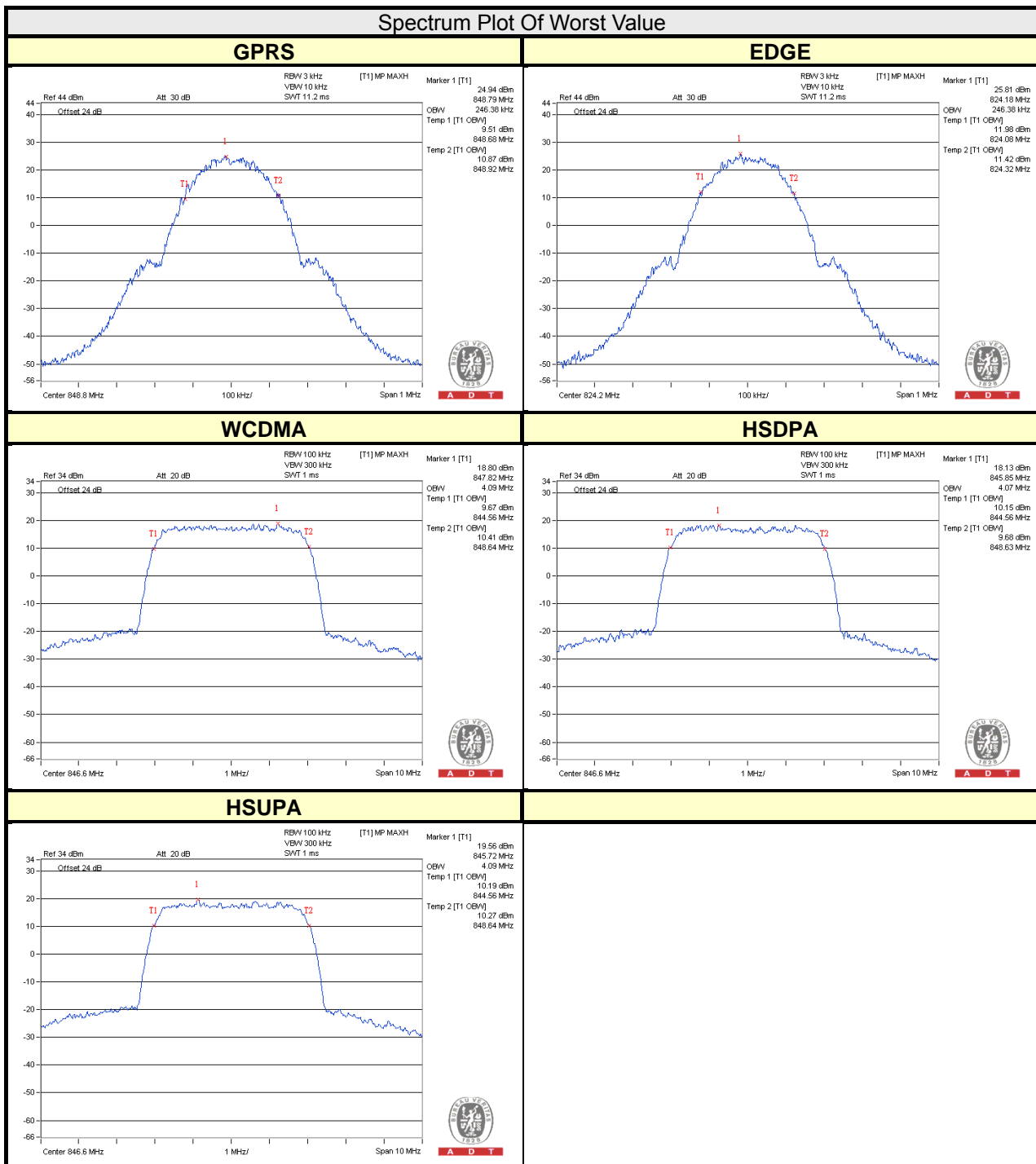

4.4 Band Edge Measurement

4.4.1 Limits of Band Edge Measurement

Power of any emission outside of the authorized operating frequency ranges must be attenuated below the transmitting power (P) by a factor of at least $43 + 10 \log(P)$ dB. In the 1 MHz bands immediately outside and adjacent to the frequency block a resolution bandwidth of at least one percent of the emission bandwidth of the fundamental emission of the transmitter may be employed.

4.4.2 Test Setup

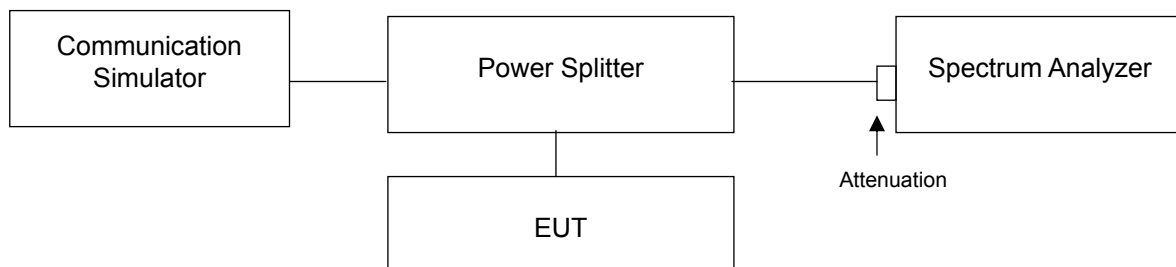

4.4.3 Test Procedures

- a. All measurements were done at low and high operational frequency range.
- b. The center frequency of spectrum is the band edge frequency and s RB of the spectrum is $>1\%$ OCCUPIED BANDWIDTH and VB of the spectrum is $\geq 3*RB$.
- c. Record the max trace plot into the test report.

4.4.4 Test Results

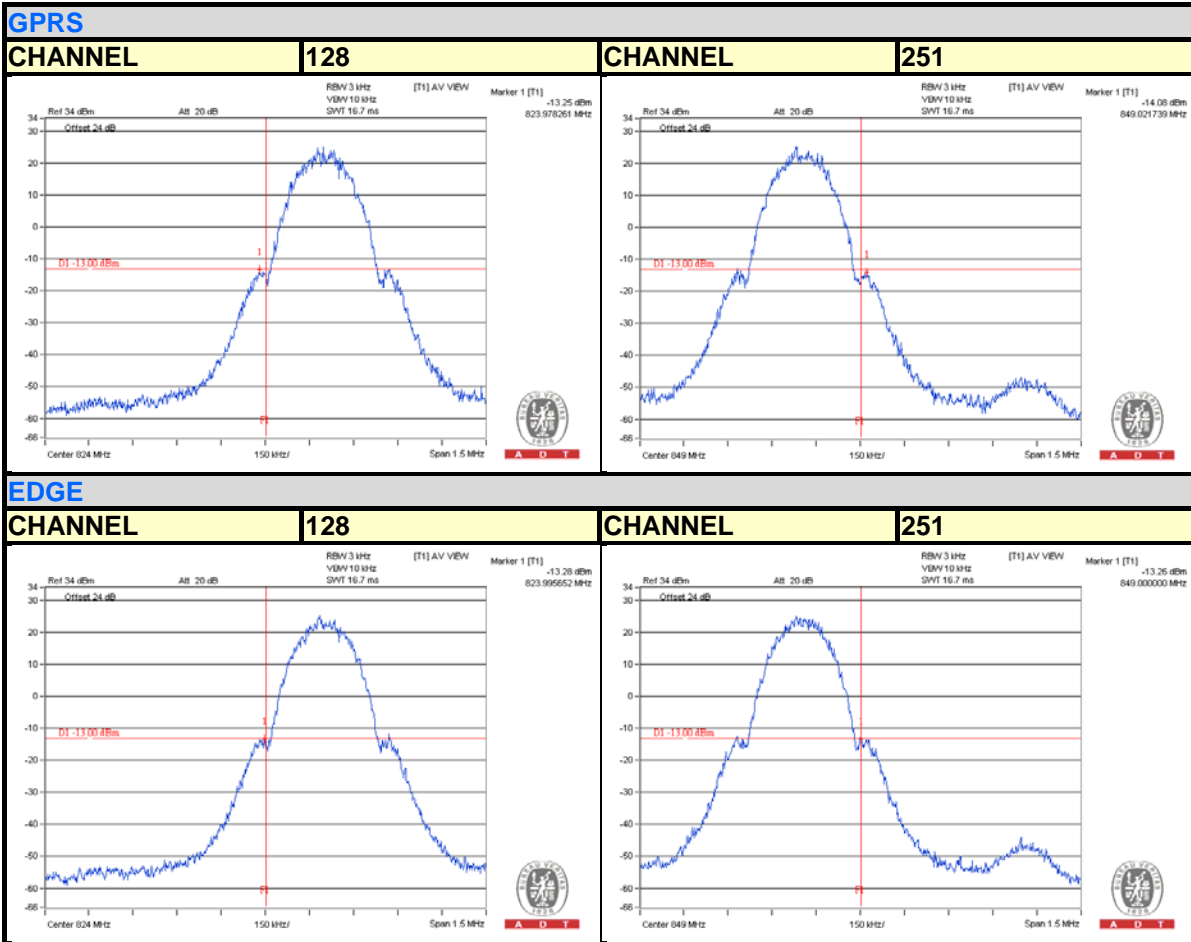

WCDMA

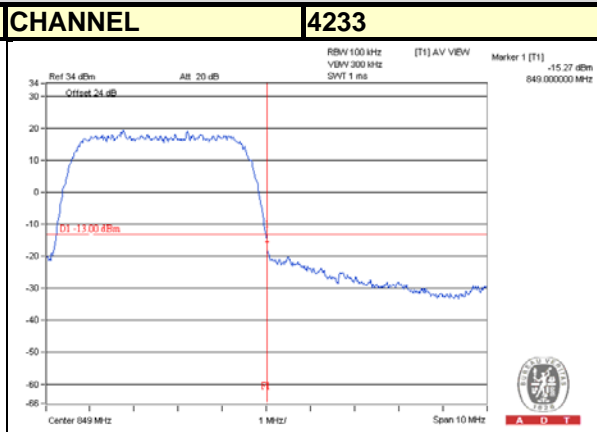
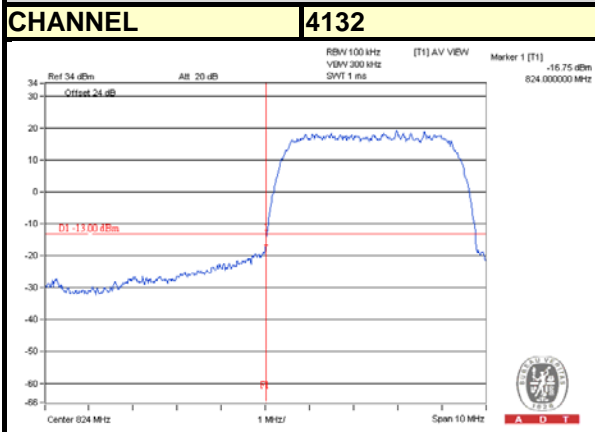

HSDPA

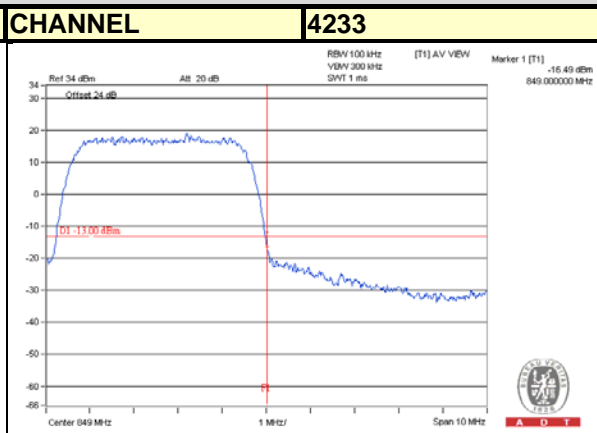
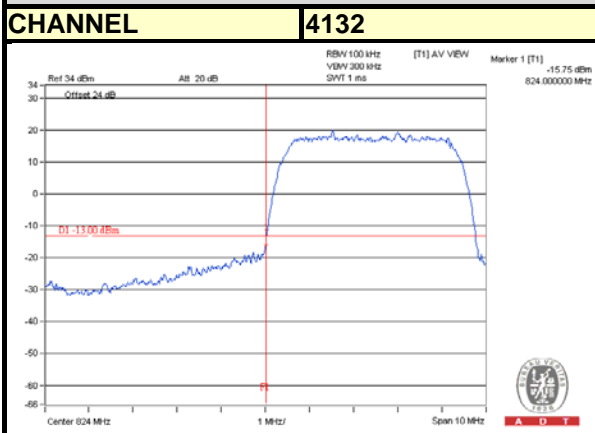

HSUPA

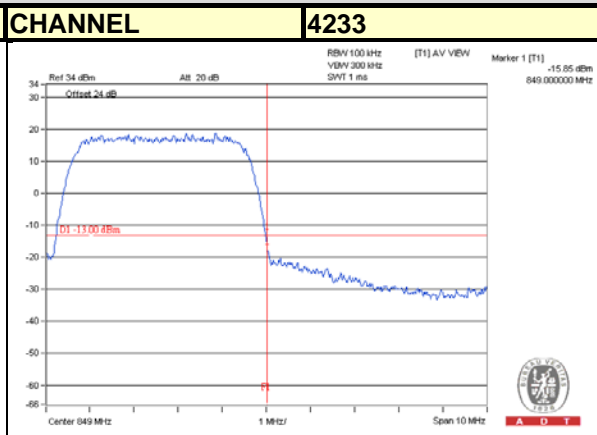
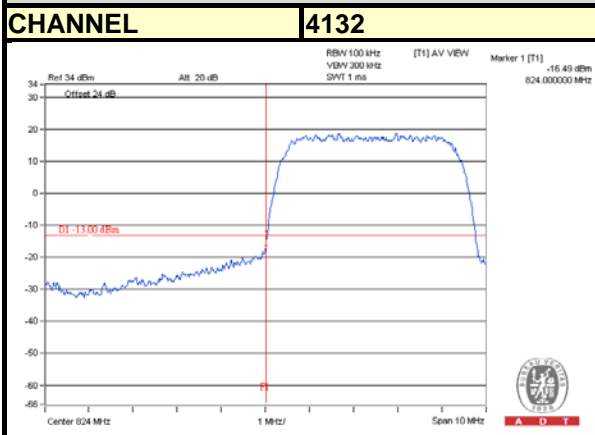

4.5 Peak To Average Ratio

4.5.1 Limits of Peak To Average Ratio Measurement

In measuring transmissions in this band using an average power technique, the peak to-average ratio (PAR) of the transmission may not exceed 13 dB

4.5.2 Test Setup

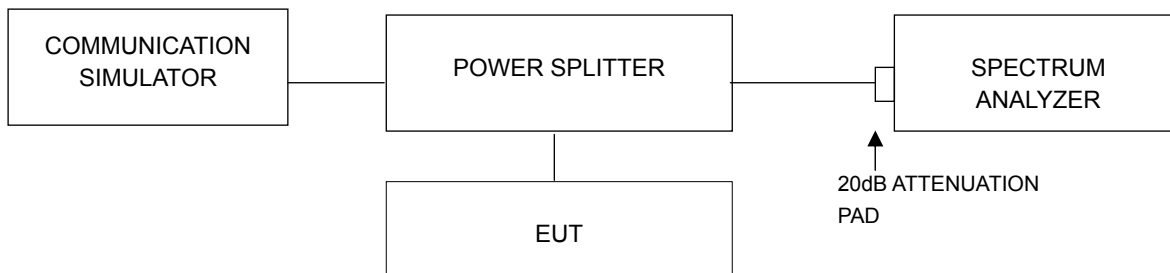

4.5.3 Test Procedures

1. Set resolution/measurement bandwidth \geq signal's occupied bandwidth;
2. Set the number of counts to a value that stabilizes the measured CCDF curve;
3. Record the maximum PAPR level associated with a probability of 0.1%.

4.5.4 Test Results

Channel	Frequency (MHz)	Peak To Average Ratio (dB)		Channel	Freq. (MHz)	Peak To Average Ratio (dB)
		GPRS	EDGE			WCDMA
128	824.2	0.31	2.95	4132	826.4	2.62
189	836.4	0.34	4.79	4182	836.4	3.02
251	848.8	0.38	5.1	4233	846.6	2.66

Spectrum Plot Of Worst Value



4.6 Conducted Spurious Emissions

4.6.1 Limits of Conducted Spurious Emissions Measurement

The power of any emission outside of the authorized operating frequency ranges must be attenuated below the transmitting power (P) by a factor of at least $43 + 10 \log(P)$ dB. The emission limit equal to -13dBm .

4.6.2 Test Setup

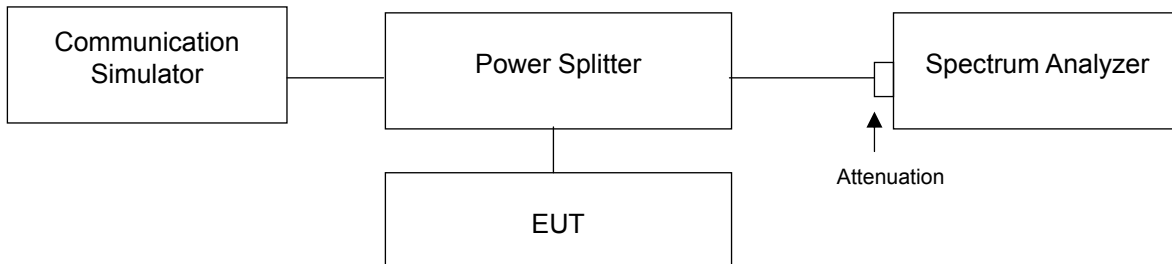

4.6.3 Test Procedure

- The EUT makes a phone call to the communication simulator. All measurements were done at low, middle and high operational frequency range.
- Measuring frequency range is from 9 kHz to 9GHz. 20dB attenuation pad is connected with spectrum. RBW=1MHz and VBW=3MHz is used for conducted emission measurement.

4.6.4 Test Results

GPRS

CHANNEL 189

FREQUENCY RANGE : 9kHz~1GHz

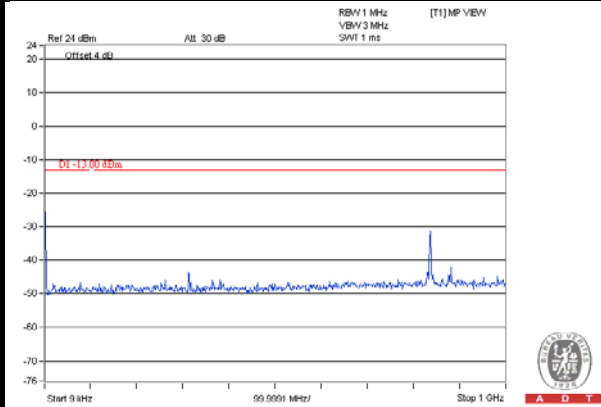

FREQUENCY RANGE : 1GHz~4GHz

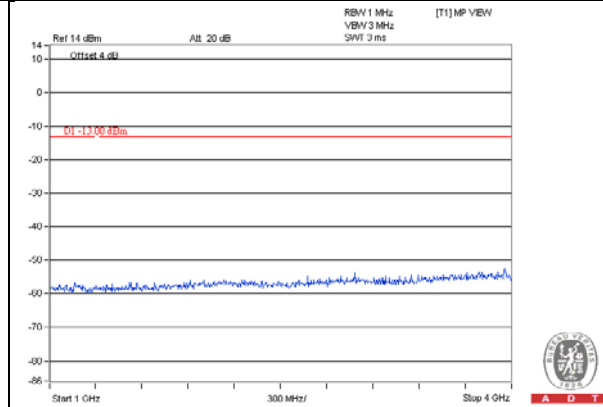

FREQUENCY RANGE : 4GHz~7GHz

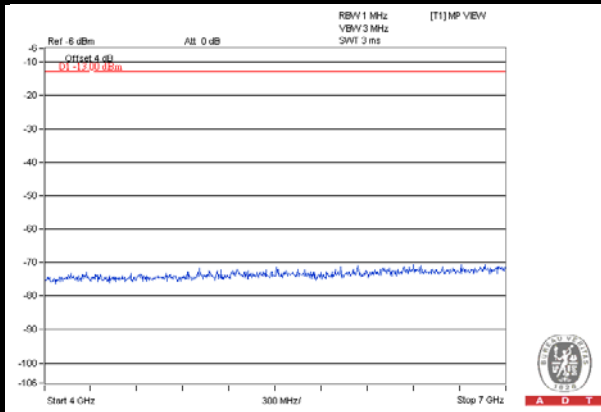

FREQUENCY RANGE : 7GHz~9GHz

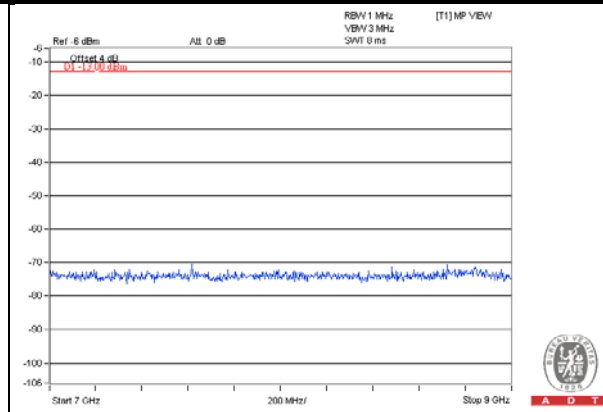

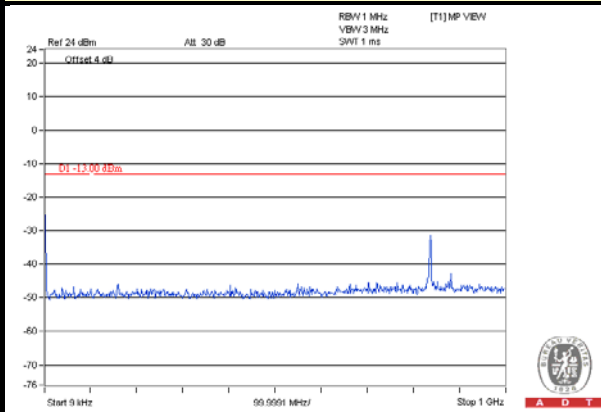
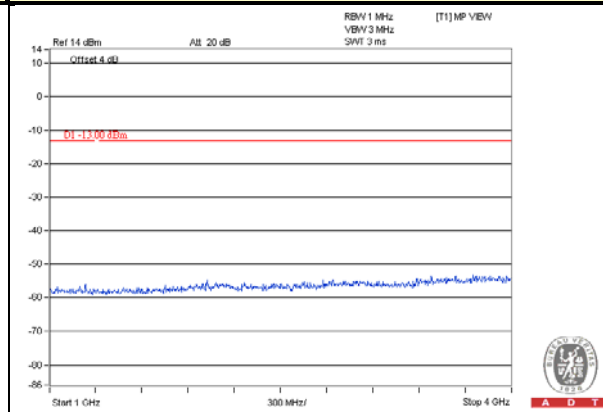
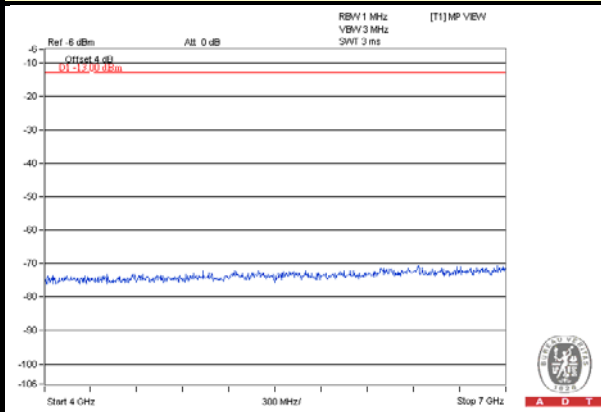
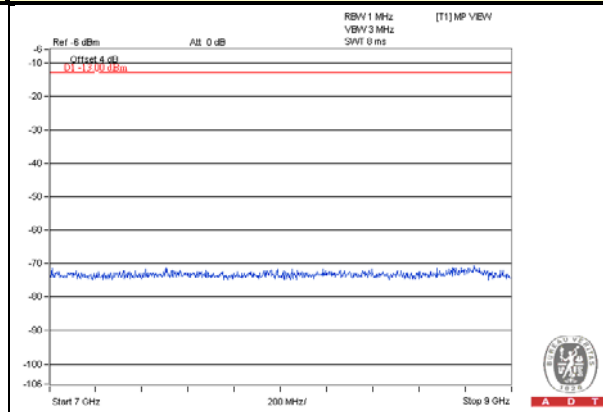
EDGE**CHANNEL 189****FREQUENCY RANGE : 9kHz~1GHz****FREQUENCY RANGE : 1GHz~4GHz****FREQUENCY RANGE : 4GHz~7GHz****FREQUENCY RANGE : 7GHz~9GHz**

WCDMA

CHANNEL 4182

FREQUENCY RANGE : 9kHz~1GHz

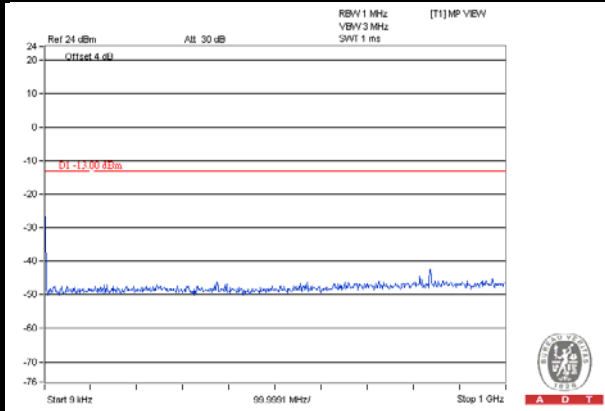

FREQUENCY RANGE : 1GHz~4GHz

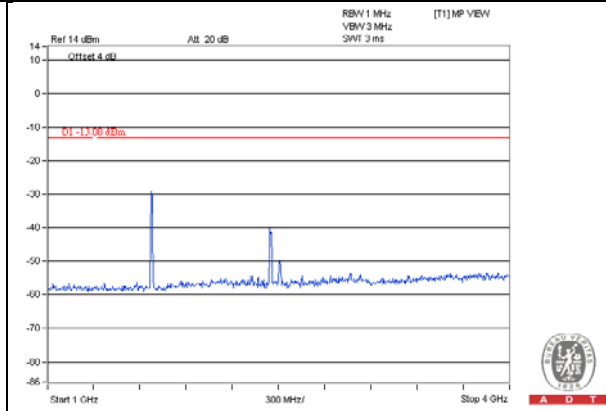

FREQUENCY RANGE : 4GHz~9GHz

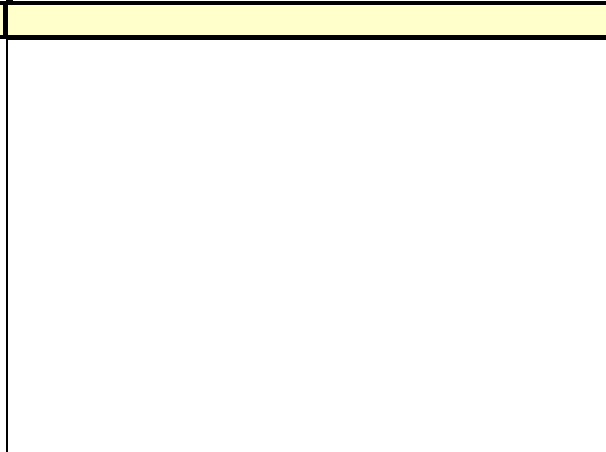
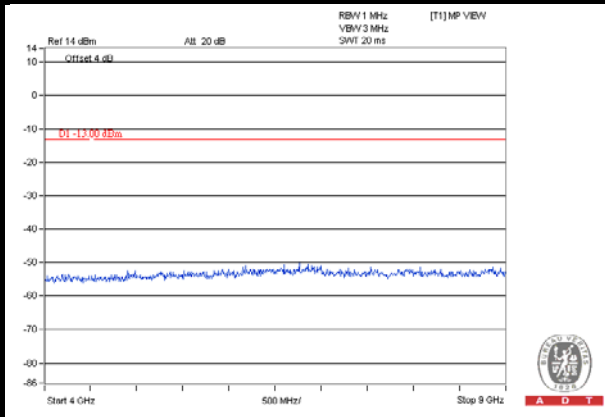

4.7 Radiated Emission Measurement

4.7.1 Limits of Radiated Emission Measurement

The power of any emission outside of the authorized operating frequency ranges must be attenuated below the transmitting power (P) by a factor of at least $43 + 10 \log(P)$ dB. The emission limit equal to -13dBm .

4.7.2 Test Procedure

- a. Substitution method is used for EIRP measurement. In the semi-anechoic chamber, EUT placed on the 0.8m height of Turn Table, rotated the table around 360 degrees to search the maximum radiation power and receiver antenna shall be rotated vertical and horizontal polarization and moved height from 1m to 4m to find the maximum polar radiated power. The "Read Value" is the spectrum reading the maximum power value.
- b. The substitution horn antenna is substituted for EUT at the same position and signals generator export the CW signal to the substitution antenna via a TX cable. Rotated the Turn Table and moved receiving antenna to find the maximum radiation power. Adjust output power level of S.G to get a Value of spectrum reading equal to "Read Value" of step a. Record the power level of S.G
- c. $\text{EIRP} = \text{Output power level of S.G} - \text{TX cable loss} + \text{Antenna gain of substitution horn}$.
- d. ERP power can be calculated form EIRP power by subtracting the gain of dipole, $\text{ERP power} = \text{EIPR power} - 2.15\text{dBi}$.

NOTE: The resolution bandwidth and video bandwidth of test receiver/spectrum analyzer is 1MHz/3MHz.

4.7.3 Deviation from Test Standard

No deviation.

4.7.4 Test Setup

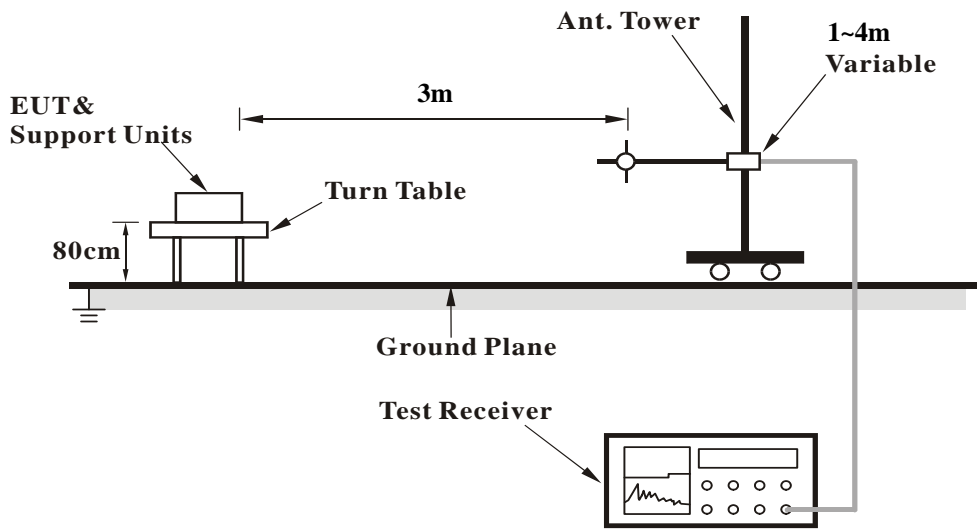

For the actual test configuration, please refer to the attached file (Test Setup Photo).

4.7.5 Test Results

Below 1GHz

GPRS:

MODE	TX channel 189	FREQUENCY RANGE	Below 1000MHz
------	----------------	-----------------	---------------

ANTENNA POLARITY & TEST DISTANCE: HORIZONTAL AT 3 M

No.	Freq. (MHz)	Reading (dBu V/m)	Limit (dBm)	S.G Power Value (dBm)	Correction Factor (dB)	Level (dBm)	Margin (dB)
1	62.797	35.15	-13	-48.65	-6.77	-55.42	-42.42
2	214.182	40.31	-13	-55.13	4.16	-50.98	-37.98
3	249.768	39.92	-13	-55.05	3.89	-51.16	-38.16
4	374.751	38.35	-13	-59.50	3.47	-56.04	-43.04
5	748.55	32.63	-13	-63.74	0.84	-62.91	-49.91
6	874.41	39.44	-13	-57.20	0.77	-56.44	-43.44

ANTENNA POLARITY & TEST DISTANCE: VERTICAL AT 3 M

No.	Freq. (MHz)	Reading (dBu V/m)	Limit (dBm)	S.G Power Value (dBm)	Correction Factor (dB)	Level (dBm)	Margin (dB)
1	62.641	37.64	-13	-46.07	-6.81	-52.88	-39.88
2	63.321	36.81	-13	-47.30	-6.62	-53.92	-40.92
3	101.661	40.34	-13	-50.24	-0.67	-50.92	-37.92
4	374.751	37.76	-13	-60.09	3.47	-56.63	-43.63
5	748.55	34.75	-13	-61.62	0.84	-60.79	-47.79
6	874.41	34.85	-13	-61.79	0.77	-61.03	-48.03

REMARKS:

1. Level (dBm) = S.G Power Value (dBm) + Correction Factor (dB).
2. Correction Factor = gain of substitution antenna + cable loss

EDGE:

MODE	TX channel 189	FREQUENCY RANGE	Below 1000MHz
-------------	----------------	------------------------	---------------

ANTENNA POLARITY & TEST DISTANCE: HORIZONTAL AT 3 M

No.	Freq. (MHz)	Reading (dBm)	Limit (dBm)	S.G Power Value (dBm)	Correction Factor (dB)	ERP (dBm)	Margin (dB)
1	62.91	35.24	-13	-48.56	-6.77	-55.33	-42.33
2	214.32	40.42	-13	-55.02	4.16	-50.87	-37.87
3	249.84	40.04	-13	-54.93	3.89	-51.04	-38.04
4	374.89	39.11	-13	-58.74	3.47	-55.28	-42.28
5	749.11	33.01	-13	-63.36	0.84	-62.53	-49.53
6	874.72	40.1	-13	-56.54	0.77	-55.78	-42.78

ANTENNA POLARITY & TEST DISTANCE: VERTICAL AT 3 M

No.	Freq. (MHz)	Reading (dBm)	Limit (dBm)	S.G Power Value (dBm)	Correction Factor (dB)	ERP (dBm)	Margin (dB)
1	62.51	37.91	-13	-45.80	-6.81	-52.61	-39.61
2	63.17	37.04	-13	-47.07	-6.62	-53.69	-40.69
3	101.54	40.84	-13	-49.74	-0.67	-50.42	-37.42
4	374.98	37.82	-13	-60.03	3.47	-56.57	-43.57
5	749.54	34.81	-13	-61.56	0.84	-60.73	-47.73
6	875.87	35.1	-13	-61.54	0.77	-60.78	-47.78

REMARKS:

1. ERP(dBm) = S.G Power Value (dBm) + Correction Factor (dB).
2. Correction Factor = gain of substitution antenna + cable loss

WCDMA:

MODE	TX channel 4182	FREQUENCY RANGE	Below 1000MHz
-------------	-----------------	------------------------	---------------

ANTENNA POLARITY & TEST DISTANCE: HORIZONTAL AT 3 M

No.	Freq. (MHz)	Reading (dBm)	Limit (dBm)	S.G Power Value (dBm)	Correction Factor (dB)	ERP (dBm)	Margin (dB)
1	78.64	38.04	-13	-54.19	-2.69	-56.88	-43.88
2	119.75	38.26	-13	-51.28	-1.18	-52.46	-39.46
3	159.51	37.21	-13	-50.86	-0.77	-51.62	-38.62
4	241.03	43.16	-13	-52.15	3.82	-48.33	-35.33
5	325.22	41.52	-13	-55.31	3.65	-51.66	-38.66
6	403.3	38.49	-13	-59.38	3.30	-56.08	-43.08

ANTENNA POLARITY & TEST DISTANCE: VERTICAL AT 3 M

No.	Freq. (MHz)	Reading (dBm)	Limit (dBm)	S.G Power Value (dBm)	Correction Factor (dB)	ERP (dBm)	Margin (dB)
1	80.72	38.24	-13	-55.75	-1.74	-57.48	-44.48
2	120.89	38.94	-13	-50.85	-1.19	-52.04	-39.04
3	242.42	43.73	-13	-51.53	3.83	-47.70	-34.70
4	255.19	42.39	-13	-52.04	4.01	-48.03	-35.03
5	269.8	42.71	-13	-51.82	3.78	-48.03	-35.03
6	406.88	37.73	-13	-60.17	3.26	-56.91	-43.91

REMARKS:

1. ERP(dBm) = S.G Power Value (dBm) + Correction Factor (dB).
2. Correction Factor = gain of substitution antenna + cable loss

Above 1GHz
GPRS:

MODE	TX channel 189	FREQUENCY RANGE	Above 1000MHz
-------------	----------------	------------------------	---------------

ANTENNA POLARITY & TEST DISTANCE: HORIZONTAL AT 3 M							
No.	Freq. (MHz)	Reading (dBm)	Limit (dBm)	S.G Power Value (dBm)	Correction Factor (dB)	ERP (dBm)	Margin (dB)
1	1672.8	59.20	-13	-43.43	6.31	-37.12	-24.12
2	2509.2	49.78	-13	-48.74	6.66	-42.08	-29.08
3	3345.6	47.70	-13	-55.31	7.63	-47.68	-34.68
4	4182	44.19	-13	-60.65	7.44	-53.21	-40.21
5	5018.4	47.8	-13	-56.46	7.01	-49.45	-36.45
6	5854.8	49.3	-13	-55.08	6.87	-48.21	-35.21
7	6691.2	52.1	-13	-51.23	5.56	-45.67	-32.67
8	7527.6	53.6	-13	-49.02	4.52	-44.50	-31.50
9	8364	53.2	-13	-49.42	4.18	-45.24	-32.24
ANTENNA POLARITY & TEST DISTANCE: VERTICAL AT 3 M							
No.	Freq. (MHz)	Reading (dBm)	Limit (dBm)	S.G Power Value (dBm)	Correction Factor (dB)	ERP (dBm)	Margin (dB)
1	1672.8	61.74	-13	-40.89	6.31	-34.58	-21.58
2	2509.2	51.3	-13	-47.22	6.66	-40.56	-27.56
3	3345.6	48.1	-13	-54.91	7.63	-47.28	-34.28
4	4182	43.6	-13	-61.24	7.44	-53.80	-40.80
5	5018.4	48.9	-13	-55.36	7.01	-48.35	-35.35
6	5854.8	51.9	-13	-52.48	6.87	-45.61	-32.61
7	6691.2	53.5	-13	-49.83	5.56	-44.27	-31.27
8	7527.6	53.4	-13	-49.22	4.52	-44.70	-31.70
9	8364	54.3	-13	-48.32	4.18	-44.14	-31.14

REMARKS:

1. ERP(dBm) = S.G Power Value (dBm) + Correction Factor (dB).
2. Correction Factor = gain of substitution antenna + cable loss

EDGE:

MODE	TX channel 189	FREQUENCY RANGE	Above 1000MHz
-------------	----------------	------------------------	---------------

ANTENNA POLARITY & TEST DISTANCE: HORIZONTAL AT 3 M

No.	Freq. (MHz)	Reading (dBm)	Limit (dBm)	S.G Power Value (dBm)	Correction Factor (dB)	ERP (dBm)	Margin (dB)
1	1672.8	59.51	-13	-43.12	6.31	-36.81	-23.81
2	2509.2	49.23	-13	-49.29	6.66	-42.63	-29.63
3	3345.6	48.38	-13	-54.63	7.63	-47.00	-34.00
4	4182	44.66	-13	-60.18	7.44	-52.74	-39.74
5	5018.4	47.92	-13	-56.34	7.01	-49.33	-36.33
6	5854.8	49.85	-13	-54.53	6.87	-47.66	-34.66
7	6691.2	51.15	-13	-52.18	5.56	-46.62	-33.62
8	7527.6	54.41	-13	-48.21	4.52	-43.69	-30.69
9	8364	53.48	-13	-49.14	4.18	-44.96	-31.96

ANTENNA POLARITY & TEST DISTANCE: VERTICAL AT 3 M

No.	Freq. (MHz)	Reading (dBm)	Limit (dBm)	S.G Power Value (dBm)	Correction Factor (dB)	ERP (dBm)	Margin (dB)
1	1672.8	61.97	-13	-40.66	6.31	-34.35	-21.35
2	2509.2	52.15	-13	-46.37	6.66	-39.71	-26.71
3	3345.6	48.46	-13	-54.55	7.63	-46.92	-33.92
4	4182	43.96	-13	-60.88	7.44	-53.44	-40.44
5	5018.4	47.97	-13	-56.29	7.01	-49.28	-36.28
6	5854.8	51.04	-13	-53.34	6.87	-46.47	-33.47
7	6691.2	52.52	-13	-50.81	5.56	-45.25	-32.25
8	7527.6	54.15	-13	-48.47	4.52	-43.95	-30.95
9	8364	54.17	-13	-48.45	4.18	-44.27	-31.27

REMARKS:

1. ERP(dBm) = S.G Power Value (dBm) + Correction Factor (dB).
2. Correction Factor = gain of substitution antenna + cable loss

WCDMA:

MODE	TX channel 4182	FREQUENCY RANGE	Above 1000MHz
-------------	-----------------	------------------------	---------------

ANTENNA POLARITY & TEST DISTANCE: HORIZONTAL AT 3 M							
No.	Freq. (MHz)	Reading (dBm)	Limit (dBm)	S.G Power Value (dBm)	Correction Factor (dB)	ERP (dBm)	Margin (dB)
1	1672.8	60.00	-13	-42.63	6.31	-36.32	-23.32
2	2509.2	49.71	-13	-48.81	6.66	-42.15	-29.15
3	3345.6	46.94	-13	-56.07	7.63	-48.44	-35.44
4	4182	43.96	-13	-60.88	7.44	-53.44	-40.44
5	5018.4	46.87	-13	-57.39	7.01	-50.38	-37.38
6	5854.8	49.32	-13	-55.06	6.87	-48.19	-35.19
7	6691.2	52.99	-13	-50.34	5.56	-44.78	-31.78
8	7527.6	53.62	-13	-49.00	4.52	-44.48	-31.48
9	8364	53.14	-13	-49.48	4.18	-45.30	-32.30
ANTENNA POLARITY & TEST DISTANCE: VERTICAL AT 3 M							
No.	Freq. (MHz)	Reading (dBm)	Limit (dBm)	S.G Power Value (dBm)	Correction Factor (dB)	ERP (dBm)	Margin (dB)
1	1672.8	62.12	-13	-40.51	6.31	-34.20	-21.20
2	2509.2	51.3	-13	-47.22	6.66	-40.56	-27.56
3	3345.6	48.92	-13	-54.09	7.63	-46.46	-33.46
4	4182	42.61	-13	-62.23	7.44	-54.79	-41.79
5	5018.4	48.55	-13	-55.71	7.01	-48.70	-35.70
6	5854.8	51.02	-13	-53.36	6.87	-46.49	-33.49
7	6691.2	53.98	-13	-49.35	5.56	-43.79	-30.79
8	7527.6	53.4	-13	-49.22	4.52	-44.70	-31.70
9	8364	53.74	-13	-48.88	4.18	-44.70	-31.70

REMARKS:

1. ERP(dBm) = S.G Power Value (dBm) + Correction Factor (dB).
2. Correction Factor = gain of substitution antenna + cable loss



5 Pictures of Test Arrangements

Please refer to the attached file (Test Setup Photo).



A D T

Appendix – Information on the Testing Laboratories

We, Bureau Veritas Consumer Products Services (H.K.) Ltd., Taoyuan Branch, were founded in 1988 to provide our best service in EMC, Radio, Telecom and Safety consultation. Our laboratories are accredited and approved according to ISO/IEC 17025.

If you have any comments, please feel free to contact us at the following:

Linko EMC/RF Lab

Tel: 886-2-26052180

Fax: 886-2-26051924

Hsin Chu EMC/RF Lab/Telecom Lab

Tel: 886-3-5935343

Fax: 886-3-5935342

Hwa Ya EMC/RF/Safety

Tel: 886-3-3183232

Fax: 886-3-3270892

Email: service.adt@tw.bureauveritas.com

Web Site: www.bureauveritas-adt.com

The address and road map of all our labs can be found in our web site also.

--- END ---