



**EMI TEST REPORT**

JQA APPLICATION NO. : 400-00249

Model No. : RI-14BTY

Type of Equipment : Immobilizer

Regulations Applied : CFR 47 FCC Rules and Regulations Part 15

FCC ID : MOZRI-14BTY

Applicant : TOKAI RIKA CO., LTD.

Address : 260, Toyota 3-chome, Oguchi-cho, Niwa-gun,  
Aichi-ken 480-0195, Japan

Manufacture : TOKAI RIKA CO., LTD.

Address : 260, Toyota 3-chome, Oguchi-cho, Niwa-gun,  
Aichi-ken 480-0195, Japan

Received date of EUT : July 4, 2000

**Final Judgment : Passed**

**TEST RESULTS IN THIS REPORT** are obtained in use of equipment that is traceable to Electrotechnical Lab. of MITI Japan and Communications Research Lab. of MPT Japan.

**The test results** only respond to the tested sample. It is not allowed to copy this report even partly without the allowance of the JQA EMC Engineering Dept. Testing Div.

---

**TABLE OF CONTENTS**

	Page
<b>1 Documentation</b>	
1.1 Test Regulation	<u>3</u>
1.2 General Information	<u>3</u>
1.3 Test Condition	<u>4 - 8</u>
1.4 EUT Modifications / Deviation from Standard	<u>9</u>
1.5 Test results	<u>10</u>
1.6 Summary	<u>11</u>
1.7 Test Configuration / Operation of EUT	<u>12</u>
1.8 EUT Arrangement(Drawing)	<u>13</u>
1.9 Preliminary Test and Test-setup (Drawings)	<u>14 - 19</u>
1.10 EUT Arrangement (Photographs)	<u>20</u>
<b>2 Test Data</b>	
2.1 AC Power Line Conducted Emission 0.45 MHz - 30 MHz	<u>N / A</u>
2.2 Radiated Emission (Electric Field)9 kHz - 30 MHz	<u>21 - 22</u>
2.3 Radiated Emission (Electric Field)30 MHz - 1000 MHz	<u>23 - 24</u>
2.4 Radiated Emission (Electric Field) Above 1 GHz	<u>N / A</u>
2.5 Frequency Stability	<u>N / A</u>
2.6 Occupied Bandwidth	<u>N / A</u>

## 1 DOCUMENTATION

### 1.1 TEST REGULATION

FCC Rules and Regulations Part 15 Subpart A and C (June 23, 1989) Intentional Radiators

#### Test procedure :

AC power line conducted emission, radiated emission, frequency stability and occupied bandwidth tests were performed according to the procedures in ANSI C63.4-1992.

### 1.2 GENERAL INFORMATION

#### 1.2.1 Test facility :

1) Test Facility located at EMC Engineering Dept. Testing Div. :

- No.2 and 3 Anechoic Chambers( 3 meters Site ).
- Shielded Enclosure.

Expiration date of FCC test facility filing : June 4, 2002

TSURU EMC Branch: Open Site No.1, No.2, An Anechoic Chamber (3 m and 10 m, on common plane) and a Shielded Room (Date of Listing: March 30,1999)

2) EMC Engineering Dept. Testing Div. and TSURU EMC Branch are recognized under the National Voluntary Laboratory accreditation Program for satisfactory compliance established in title 15, Part 285 Code of Federal Regulations.

NVLAP Lab Code : 200189-0 (Effective through : June 30, 2001)

NVLAP Lab Code : 200192-0 (Effective through : June 30, 2001)

#### 1.2.2 Description of the Equipment Under Test (EUT) :

- |                                      |   |
|--------------------------------------|---|
| 1) Type of Equipment                 | : Immobilizer                                   |
| 2) Product Type                      | : Production                                    |
| 3) Category                          | : Low Power Communication Device<br>Transmitter |
| 4) EUT Authorization                 | : Certification                                 |
| 5) FCC ID                            | : MOZRI-14BTY                                   |
| 6) Trade Name                        | : -   |
| 7) Model No.                         | : RI-14BTY                                      |
| 8) Operating Frequency Range         | : 134.0 kHz                                     |
| 9) Highest Frequency Used in the EUT | : 134.0 kHz                                     |
| 10) Serial No.                       | : -   |
| 11) Date of Manufacture              | : -   |
| 12) Power Rating                     | : 12.0 VDC                                      |
| 13) EUT Grounding                    | : None  |

#### 1.2.3 Definitions for symbols used in this test report :

x - indicates that the listed condition, standard or equipment is applicable for this report.

— - indicates that the listed condition, standard or equipment is not applicable for this report.

### 1.3 TEST CONDITION

#### 1.3.1 The measurement of the AC Power Line Conducted Emission

- was performed in the following test site.

- was not applicable.

**Test location :**

Safety Testing Center EMC Engineering Dept. Tsuru EMC Branch  
2096 Ohhata, Tanbozawa, Tsuru-shi Yamanashi-ken 402-0045, JAPAN

- Shielded Room No.1

- Shielded Room No.2

- Anechoic Chamber

- Open Site No.1

- Open Site No.2

**Used test instruments :**

Type	Model No.	Manufacturer	Serial No.	Last Cal.	Interval
<input type="checkbox"/> - Test Receiver	ESH-3	Rohde & Schwarz	872992/047	May. 2000	1 Year
<input type="checkbox"/> - Test Receiver	ESH-3	Rohde & Schwarz	881460/016	May. 2000	1 Year
<input type="checkbox"/> - LISN(for Peripheral)	KNW-407	Kyoritsu Electrical	8-833-5	May. 2000	1 Year
<input type="checkbox"/> - LISN(for EUT)	KNW-407	Kyoritsu Electrical	8-680-14	May. 2000	1 Year
<input type="checkbox"/> - LISN	KNW-243C	Kyoritsu Electrical	8-831-1	May. 2000	1 Year
<input type="checkbox"/> - LISN	KNW-243C	Kyoritsu Electrical	8-831-2	May. 2000	1 Year
<input type="checkbox"/> - LISN	KNW-243C	Kyoritsu Electrical	8-831-3	May. 2000	1 Year
<input type="checkbox"/> - LISN	KNW-243C	Kyoritsu Electrical	8-831-4	May. 2000	1 Year
<input type="checkbox"/> - LISN	ESH 2-Z5	Rohde & Schwarz	879341/007	May. 2000	1 Year
<input type="checkbox"/> - RF Cable	3D-2W	Fujikura	No.1	May. 2000	1 Year
<input type="checkbox"/> - RF Cable	3D-2W	Fujikura	No.2	May. 2000	1 Year
<input type="checkbox"/> - RF Cable	3D-2W	Fujikura	No.3	May. 2000	1 Year
<input type="checkbox"/> - 50ohm Termination	-	TDC	15406501E1	Feb. 2000	1 Year
<input type="checkbox"/> - 50ohm Termination	-	-	15406502E1	Feb. 2000	1 Year

**1.3.2 The measurement of the Radiated Emission(9 kHz - 30 MHz)**

- was performed in the following test site.

- was not applicable.

**Test location :**

Safety Testing Center EMC Engineering Dept. Tsuru EMC Branch  
2096 Ohhata, Tsuru-shi, Yamanashi-ken 402-0045, JAPAN

- Open Site No. 1 (3, 10 or 30 meters)

- Open Site No. 2 (3, 10 or 30 meters)

- Anechoic Chamber(3 or 10 meters)

**Validation of Site Attenuation :**

1) Last Confirmed Date : N/A

2) Interval : N/A

**Used test instruments :**

Type	Model No.	Manufacturer	Serial No.	Last Cal.	Interval
<input checked="" type="checkbox"/> - Test Receiver	ESH-3	Rohde & Schwarz	872992/047	May. 2000	1 Year
<input type="checkbox"/> - Test Receiver	ESH-3	Rohde & Schwarz	881460/016	May. 2000	1 Year
<input checked="" type="checkbox"/> - Loop Antenna	HFH2-Z2	Rohde & Schwarz	872994/043	May. 2000	1 Year
<input type="checkbox"/> - Loop Antenna	6502	EMCO	8905-2347	May. 2000	1 Year
<input checked="" type="checkbox"/> - RF Cable	5D-2W	Fujikura	155-21-002E0	Feb. 2000	1 Year

**1.3.3 The measurement of the Radiated Emission(30 MHz - 1000 MHz)**

- x   - was performed in the following test site.
- was not applicable.

**Test location :**

Safety Testing Center EMC Engineering Dept. Tsuru EMC Branch  
 2096 Ohhata, Tsuru-shi, Yamanashi-ken 402-0045, JAPAN

- x   - Open Site No. 1 (3, 10 or 30 meters)
- Open Site No. 2 (3, 10 or 30 meters)
- Anechoic Chamber(3 or 10 meters)

**Validation of Site Attenuation :**

- 1) Last Confirmed Date :May, 2000
- 2) Interval :1 year

**Used test instruments :**

Type	Model No.	Manufacturer	Serial No.	Last Cal.	Interval
<u>  x  </u> - Test Receiver	ESV	Rohde & Schwarz	863796/015	May. 2000	1 Year
<u>    </u> - Test Receiver	ESVS10	Rohde & Schwarz	843744/018	May. 2000	1 Year
<u>    </u> - Test Receiver	ESVS10	Rohde & Schwarz	84231/004	May. 2000	1 Year
<u>  x  </u> - Biconical Antenna	BBA9106	Schwarzbeck	11905065-2	May. 2000	1 Year
<u>    </u> - Biconical Antenna	BBA9106	Schwarzbeck	11905065-3	May. 2000	1 Year
<u>    </u> - Biconical Antenna	BBA9106	Schwarzbeck	G4397001	May. 2000	1 Year
<u>  x  </u> - Log-Periodic Antenna	UHALP9107	Schwarzbeck	91071212	May. 2000	1 Year
<u>    </u> - Log-Periodic Antenna	UHALP9107	Schwarzbeck	9107915	May. 2000	1 Year
<u>    </u> - Log-Periodic Antenna	UHALP9107	Schwarzbeck	G43597003	May. 2000	1 Year
<u>    </u> - Dipole Antenna	KBA-511A	Kyoritsu Electrical	0-195-5	May. 2000	1 Year
<u>    </u> - Dipole Antenna	KBA-511A	Kyoritsu Electrical	0-230-6	May. 2000	1 Year
<u>    </u> - Dipole Antenna	KBA-611	Kyoritsu Electrical	0-196-8	May. 2000	1 Year
<u>    </u> - Dipole Antenna	KBA-611	Kyoritsu Electrical	0-228-13	May. 2000	1 Year
<u>  x  </u> - RF Cable	20D/5D-2W	Fujikura	No.1	May. 2000	1 Year
<u>    </u> - RF Cable	20D/5D-2W	Fujikura	No.2	May. 2000	1 Year
<u>    </u> - RF Cable	20D/5D-2W	Fujikura	No.3	May. 2000	1 Year

**1.3.4 The measurement of the Radiated Emission(Above 1000 MHz)**

    - was performed in the following test site.

  x   - was not applicable.

**Test location :**

Safety Testing Center EMC Engineering Dept. Tsuru EMC Branch  
2096 Ohhata, Tsuru-shi, Yamanashi-ken 402-0045, JAPAN

    - Open Site No. 1 (3, 10 or 30 meters)

    - Open Site No. 2 (3, 10 or 30 meters)

    - Anechoic Chamber(3 or 10 meters)

**Validation of Site Attenuation :**

1) Last Confirmed Date : N/A

2) Interval : N/A

**Used test instruments :**

Type	Model No.	Manufacturer	Serial No.	Last Cal.	Interval
<u>   </u> - Spectrum Analyzer	8563E	Hewlett Packard	3438A00756	May. 2000	1 Year
<u>   </u> - Spectrum Analyzer	R4131C	Advantest	717201249	May. 2000	1 Year
<u>   </u> - Log-Periodic Antenna	94612<1	Rohde & Schwarz	97062301	May. 2000	1 Year
<u>   </u> - RF Amplifier	WJ-6611-513	Watkins-Johnson	0288	May. 2000	1 Year
<u>   </u> - RF Amplifier	WJ-6682-834	Watkins-Johnson	0052	May. 2000	1 Year
<u>   </u> - RF Amplifier	WJ-6870-506	Watkins-Johnson	0018	May. 2000	1 Year
<u>   </u> - RF Cable(7m)	SUCOFLEX 104	Suhner	52146/4	May. 2000	1 Year
<u>   </u> - RF Cable(3m)	SUCOFLEX 104	Suhner	52053/4	May. 2000	1 Year
<u>   </u> - RF Cable(2m)	SUCOFLEX 104	Suhner	39934/4	May. 2000	1 Year
<u>   </u> - RF Cable(1m)	SUCOFLEX 104	Suhner	35687/4	May. 2000	1 Year

**1.3.5 The measurement of the Frequency Stability**

- was performed.

- was not applicable.

**Used test instruments :**

Type	Model No.	Manufacturer	Serial No.	Last Cal.	Interval
<input type="checkbox"/> - Frequency Counter	53131A	Hewlett Packard	3546A11807	May 2000	1 Year
<input type="checkbox"/> - Oven	-	Ohnishi Co. Ltd.	-	Aug. 1999	1 Year
<input type="checkbox"/> - DC Power Supply	6628A	Hewlett Packard	3224A00284	July 2000	1 Year

**1.3.6 The measurement of the Occupied Bandwidth**

- was performed.

- was not applicable.

**Used test instruments :**

Type	Model No.	Manufacturer	Serial No.	Last Cal.	Interval
<input type="checkbox"/> - Spectrum Analyzer	8560E	Hewlett Packard	3240A00189	Sep. 1999	1 Year
<input type="checkbox"/> - Spectrum Analyzer	8563E	Hewlett Packard	3221A00201	May. 2000	1 Year
<input type="checkbox"/> - Spectrum Analyzer	8566B	Hewlett Packard	2140A01091	Apr. 2000	1 Year
<input type="checkbox"/> - Spectrum Analyzer	8566B	Hewlett Packard	2747A05855	May. 2000	1 Year
<input type="checkbox"/> - Function Generator	3325A	Hewlett Packard	2512A21776	May. 2000	1 Year
<input type="checkbox"/> - FM Linear Detector	MS61A	Anritsu Corp.	M77486	Sep. 1999	1 Year
<input type="checkbox"/> - Level Meter	ML422C	Anritsu Corp.	M87571	June 2000	1 Year



## 1.4 EUT MODIFICATION / Deviation from Standard

### 1.4.1 EUT MODIFICATION

- No modifications were conducted by JQA to achieve compliance to Class B levels.  
 -To achieve compliance to Class B levels, the following changes were made by JQA during the compliance test.

The modifications will be implemented in all production models of this equipment.

Applicant :

Date :

Typed Name :

Position :

### 1.4.2 Deviation from Standard:

- No deviations from the standard described in clause 1.1.  
 - The following deviations were employed from the standard described in clause 1.1:

---

---

**1.5 TEST RESULTS**

**AC Power Line Conducted Emission**                    \_\_\_ - Applicable      x   - NOT Applicable

The requirements are                                    \_\_\_ - PASSED                    \_\_\_ - NOT PASSED

**Remarks :**

**Radiated Emission [§15.209(a)(b)]**                      x   - Applicable    \_\_\_ - NOT Applicable

The requirements are                                      x   - PASSED                    \_\_\_ - NOT PASSED

**Remarks:**

**Frequency Stability**                                    \_\_\_ - Applicable      x   - NOT Applicable

The requirements are                                    \_\_\_ - PASSED                    \_\_\_ - NOT PASSED

**Remarks:**

**Occupied Bandwidth**                                    \_\_\_ - Applicable      x   - NOT Applicable

The requirements are                                    \_\_\_ - PASSED                    \_\_\_ - NOT PASSED

**Remarks:**

**1.6 SUMMARY****General Remarks :**

The EUT was tested according to the requirements of FCC Rules and Regulations Part 15 Subpart A and C (June 23, 1989) under the test configuration, as shown in clause 1.7 to 1.10.

The conclusion for the test items of which are required by the applied regulation is indicated under the final judgment.

**Final Judgment :**

The "as received" sample;

- x   - fulfill the test requirements of the regulation mentioned on clause 1.1.
- fulfill the test requirements of the regulation mentioned on clause 1.1, but with certain qualifications.
- doesn't fulfill the test regulation mentioned on clause 1.1.

Begin of testing : July 12, 2000

End of testing : July 12, 2000

- JAPAN QUALITY ASSURANCE ORGANIZATION -

Approved by:

Signatories:

Issued by:



Takaharu Hada  
Director  
Tsuru EMC Branch  
JQA EMC Engineering Dept.



Yuichi Fukumoto  
Manager  
Tsuru EMC Branch  
JQA EMC Engineering Dept.

**1.7 TEST CONFIGURATION / OPERATION OF EUT**

**1.7.1 Test Configuration**

The equipment under test (EUT) consists of :

Symbol	Item	Manufacturer	Model No.	FCC ID	Serial No.
A	Immobilizer	TOKAI RIKA CO., LTD.	RI-14BTY	MOZRI-14BTY	-

The measurement was carried out with the following support equipment connected :

Symbol	Item	Manufacturer	Model No.	FCC ID	Serial No.
B	DC Power Supply	KIKUSUI ELECTRONICS	PAB 18-2.5DU	N/A	30079912

Type of Cable :

Symbol	Description	Identification (Manufacturer etc.)	Shielded YES / NO	Ferrite Core	Connector type Shielded YES / NO	Length (m)
1	DC Power Cable(for EUT)	-	NO	NO	NO	1.0
2	AC Power Cable	-	NO	NO	NO	1.8

**1.7.2 Operating condition**

Power supply Voltage : 12.0 VDC(from DC Power Supply)

The tests have been carried out under the transmitting condition.

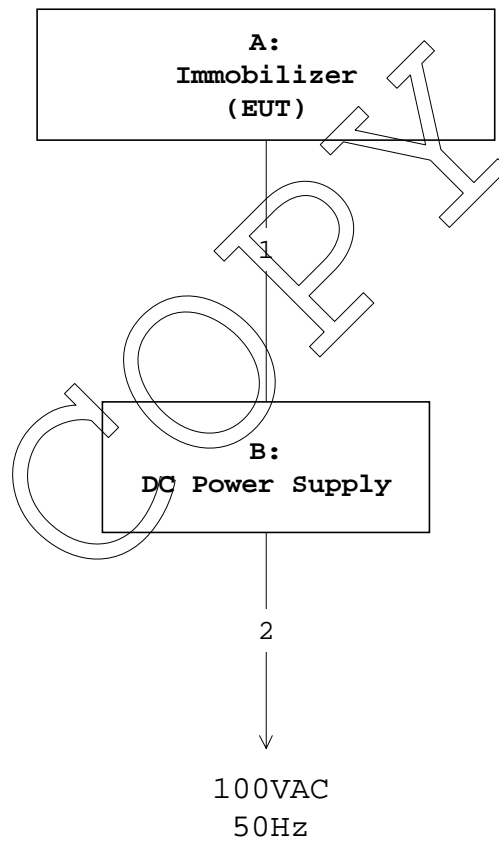
**1.8 EUT ARRANGEMENT (DRAWINGS)**

**1.9 PRELIMINARY TEST AND TEST-SETUP (DRAWINGS)**

**1.9.1 AC Power Line Conducted Emission ( 450 kHz - 30 MHz ) :**

According to description of ANSI C63.4-1992 sec.13.1.3.1, the AC power line preliminary conducted emissions measurements were carried out.

The preliminary conducted measurements were performed using the spectrum analyzer to observe the emission characteristics of the EUT.

The EUT configuration, cable configuration and mode of operation were determined for producing the maximum level of emissions. These configurations were used for final AC power line conducted emissions measurements.

**Shielded Enclosure**

- Side View -

Vertical  
Ground  
Plane

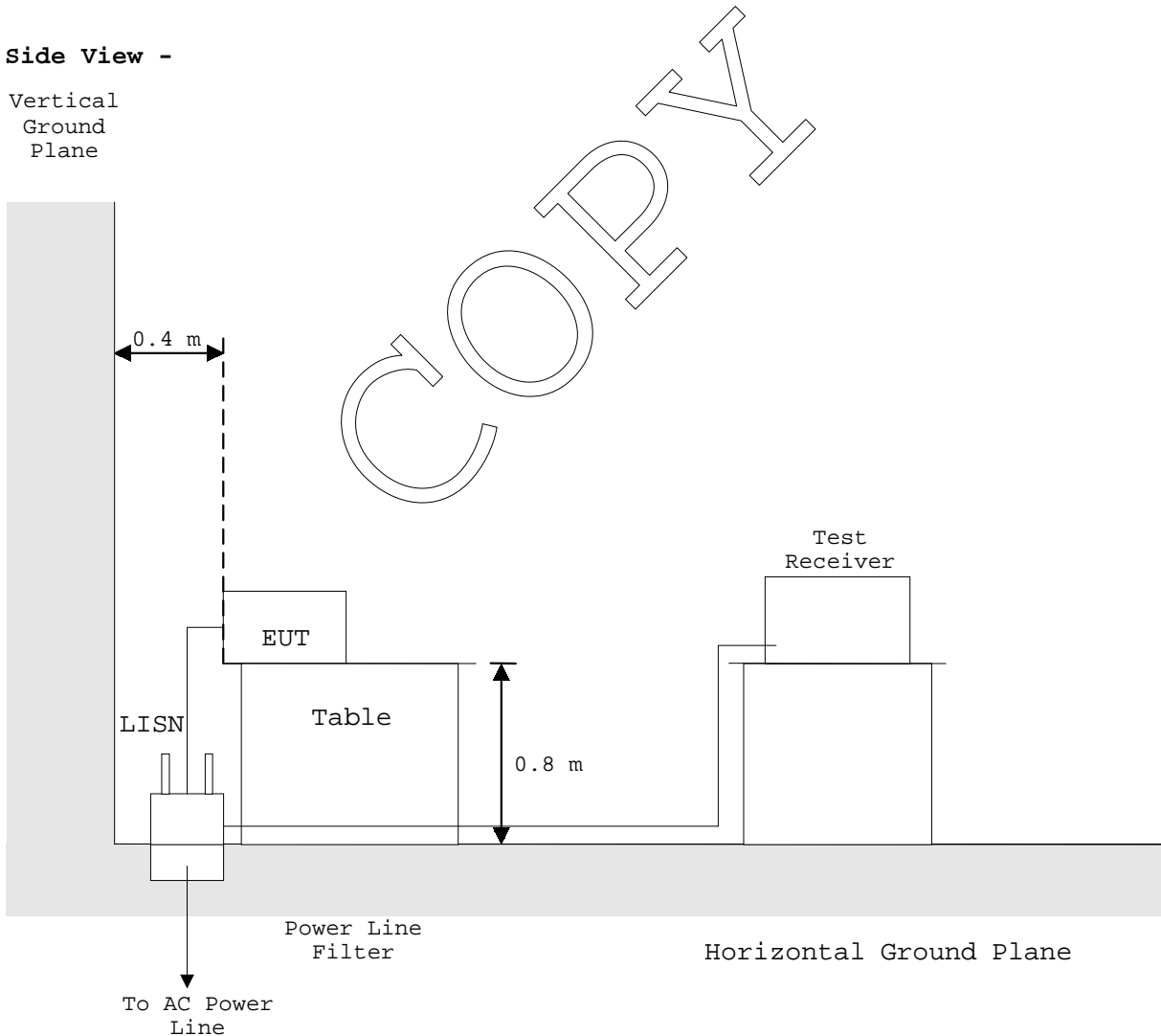

### 1.9.2 Radiated Emission ( 9 kHz - 30 MHz ) :

According to description of ANSI C63.4-1992 sec.13.1.4.1, the preliminary radiated emissions measurement were carried out. The preliminary radiated measurements were performed at the measurement distance that specified for compliance to determine the emission characteristics of the EUT.

The EUT configuration, cable configuration and mode of operation were determined for producing the maximum level of emissions. These configurations were used for the final radiated emissions measurements.

- Side View -

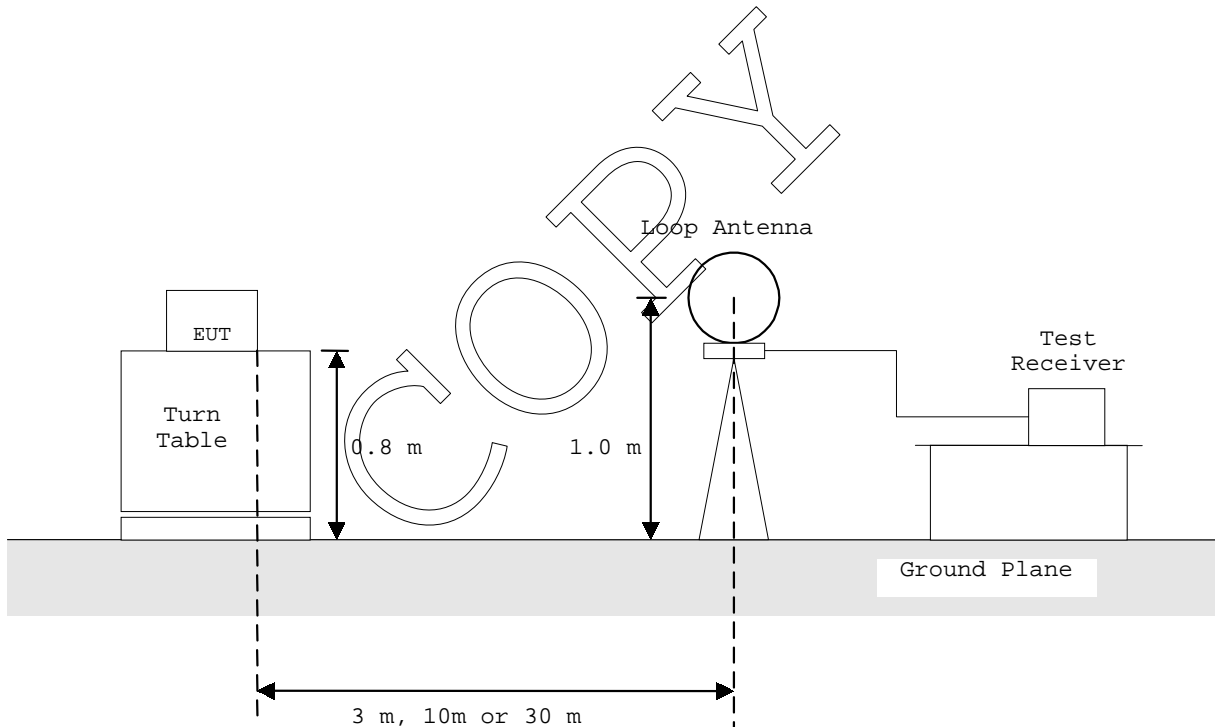

### 1.9.3 Radiated Emission ( 30 MHz - 1000 MHz ) :

According to description of ANSI C63.4-1992 sec.13.1.4.1, the preliminary radiated emissions measurement were carried out. The preliminary radiated measurements were performed at the measurement distance that specified for compliance to determine the emission characteristics of the EUT.

The EUT configuration, cable configuration and mode of operation were determined for producing the maximum level of emissions. These configurations were used for the final radiated emissions measurements.

#### Anechoic Chamber

- Side View -

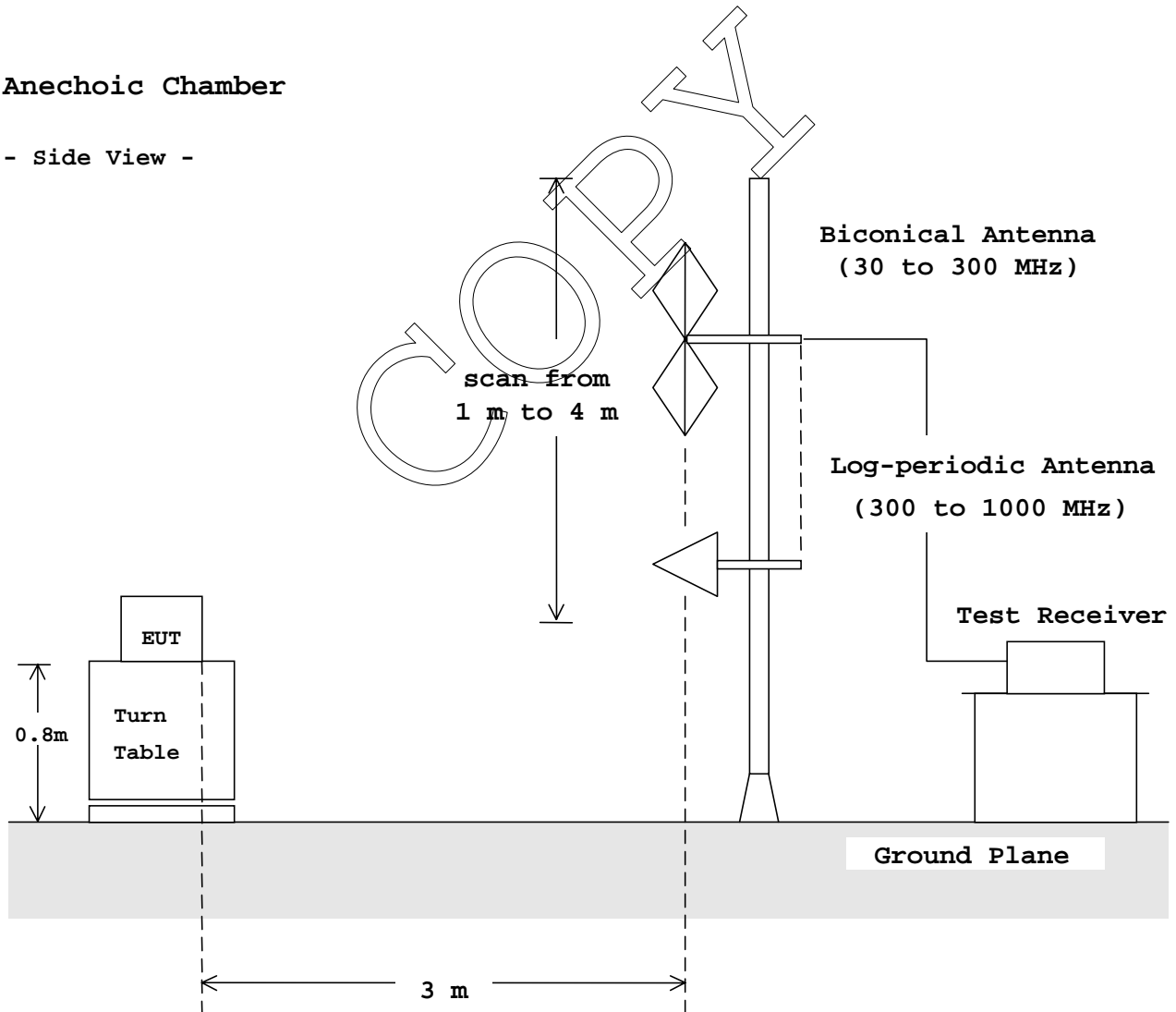



#### 1.9.4 Radiated Emission (Above 1 GHz) :

According to description of ANSI C63.4-1992 sec.13.1.4.1, the preliminary radiated emissions measurements were carried out. The preliminary radiated measurements were performed at the measurement distance that specified for compliance to determine the emission characteristics of the EUT.

The EUT configuration, cable configuration and mode of operation were determined for producing the maximum level of emissions. These configurations were used for the final radiated emissions measurements.

#### Anechoic Chamber

- Side View -

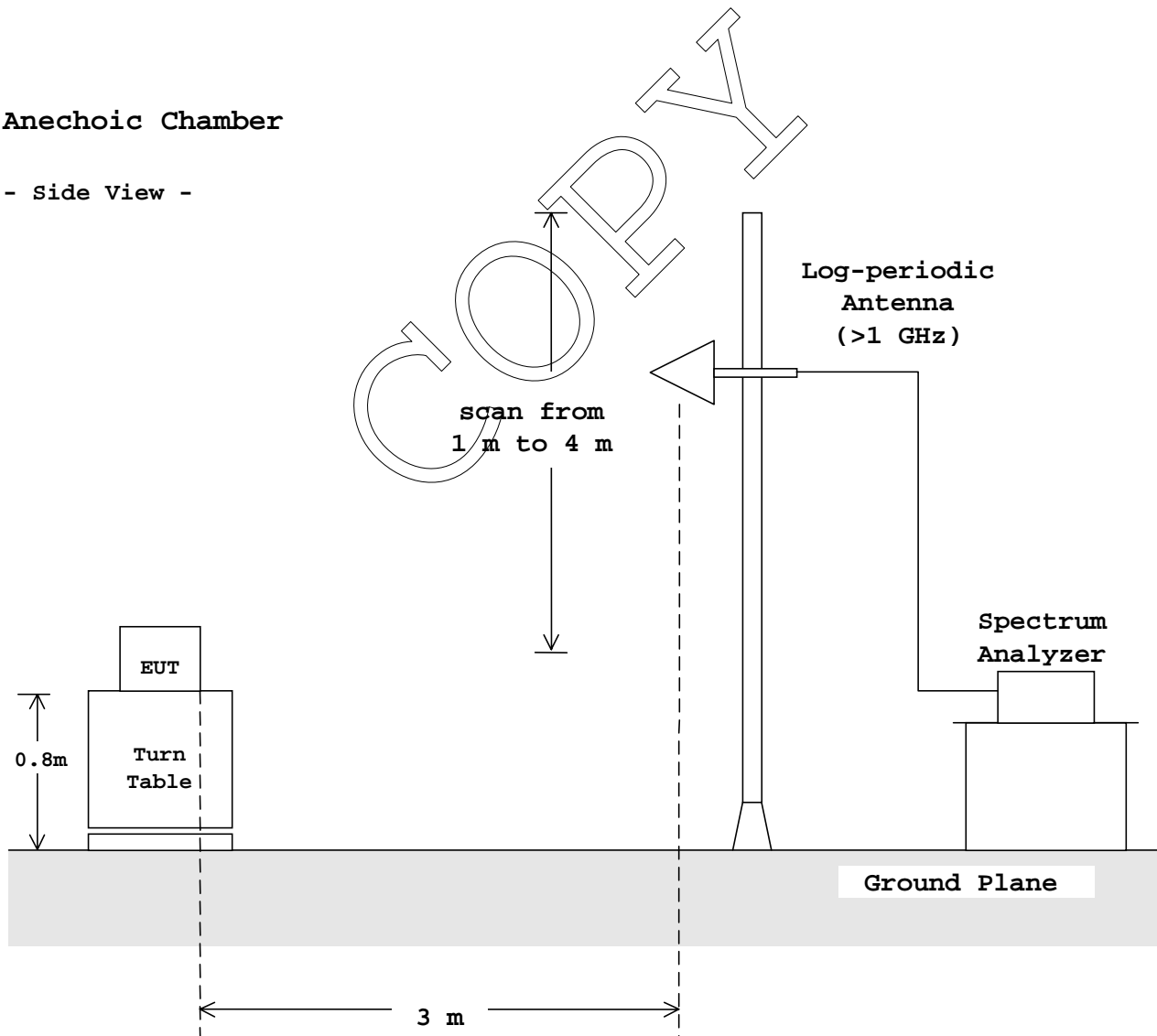

**1.9.5 Frequency Stability :**

According to description of ANSI C63.4-1992 sec.13.1.5 and sec.13.1.6, the frequency stability measurements were carried out. By using frequency counter with suitable RF amplifier, the carrier frequency of the transmitter under test was measured with a temperature variation of -20°C to +50°C at the normal supply voltage, and if required, with a variation in the primary voltage from 85 % to 115 % the rated supply voltage at the temperature of +20°C.

These measurements were carried out after allow sufficient time (approximately 1 hour) for the temperature of the chamber to stabilize.

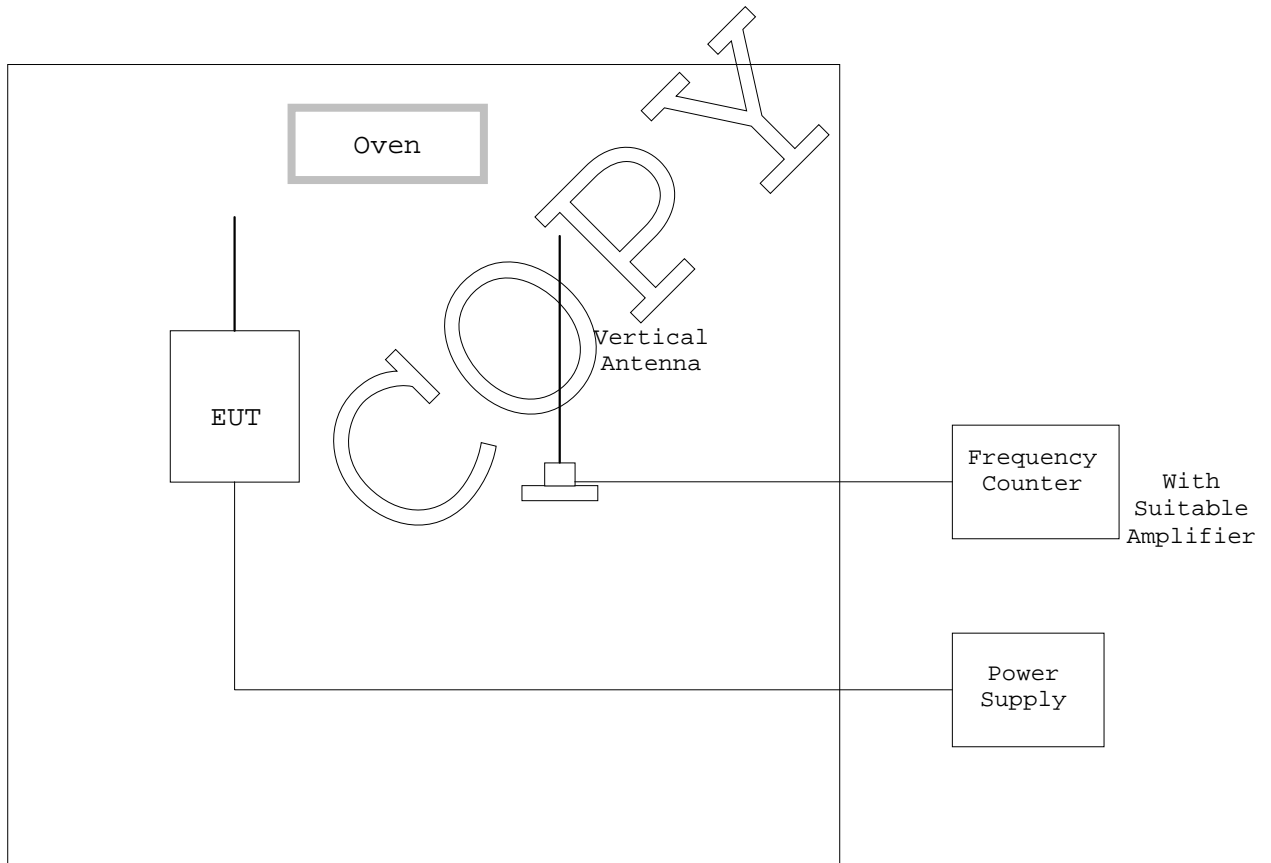

**1.9.6 Occupied Bandwidth :**

According to description of ANSI C63.4-1992 sec.13.1.7, the occupied bandwidth measurements were carried out. By using a spectrum analyzer with a vertical antenna for picking up the signal, the measurements of the emission were made under the transmitting modes of the EUT.

The resolution bandwidth of spectrum analyzer was set to the value specified in sec.13.1.7.

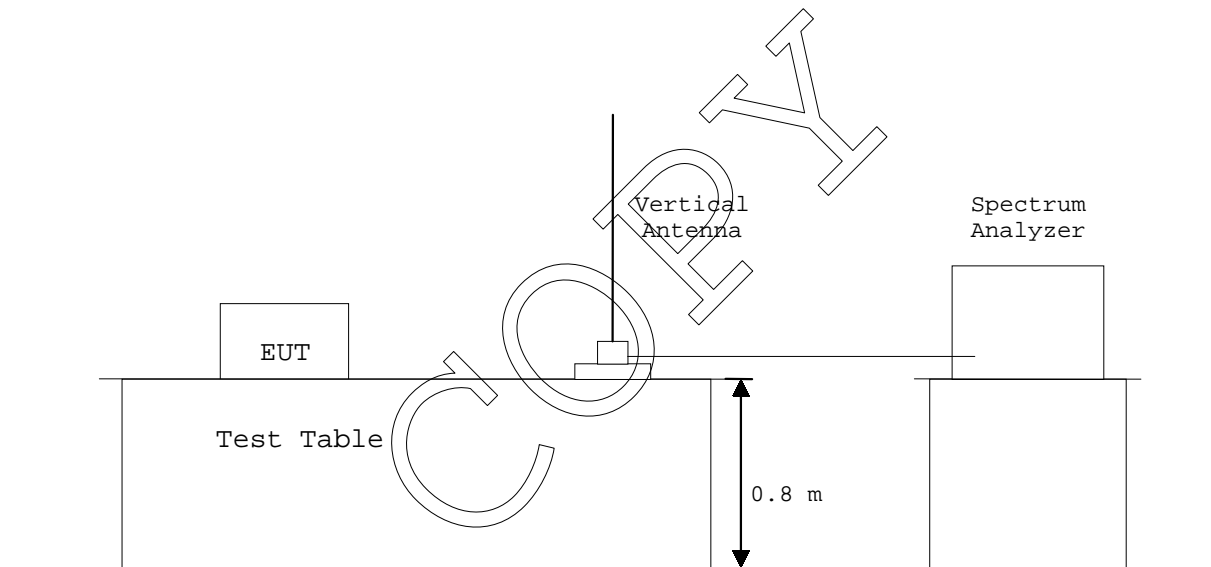

**1.10 TEST ARRANGEMENT (PHOTOGRAPHS)****PHOTOGRAPHS OF EUT CONFIGURATION FOR RADIATED EMISSIONS MEASUREMENT**

Photograph present configuration with maximum emission

- Front View -



- Rear View -

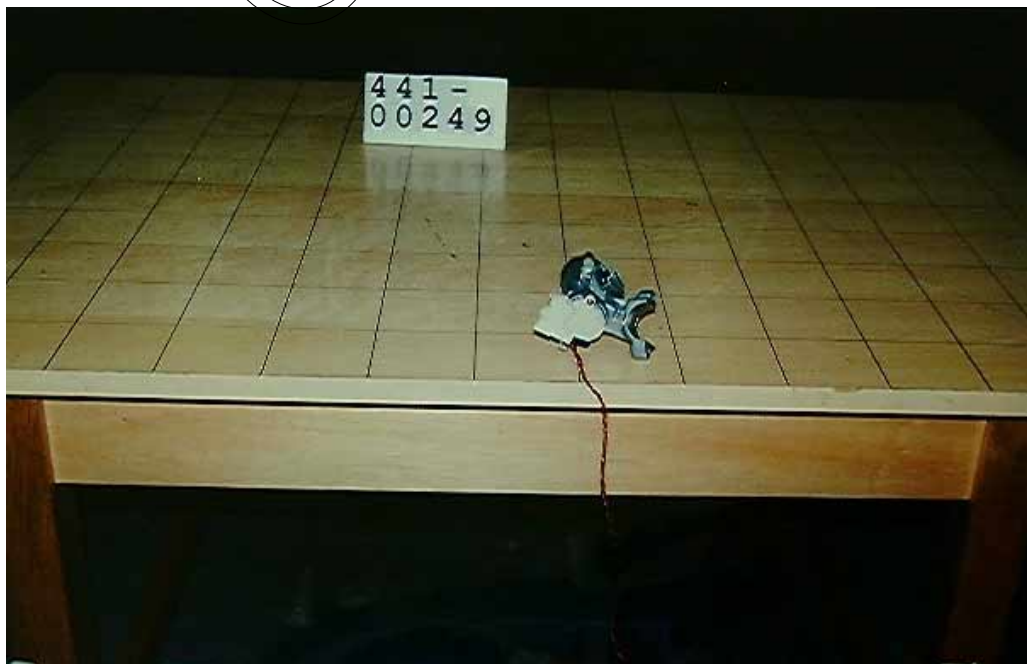

**TEST DATA****2.1 AC Power Line Conducted Emission Measurement( 0.45 MHz - 30 MHz )**

Note : This test was not applicable.

**2.2 Radiated Emissions Measurement( 9 kHz - 30 MHz )**Date : July 12, 2000Temp. : 20 °C Humi. : 41 %**Operating Frequency** : 134.0 kHz  
**Distance of Measurement** : 30 meters

Frequency (MHz)	Meter Reading (dBμV/m)	Field Strength (dBμV/m)
Fundamental		
0.1340	< 30.0	< 30.0
Harmonic Frequency		
0.2680	< 33.2	< 33.2
0.4020	< 31.4	< 31.4
0.5360	< 30.1	< 30.1
0.6700	< 29.0	< 29.0
0.8040	< 28.1	< 28.1
0.9380	< 27.3	< 27.3
1.0720	< 27.0	< 27.0
1.2060	< 27.0	< 27.0
1.3400	< 27.0	< 27.0

Note : The fundamental field strength was found undetectable weak of the field strength meter.

Tested by : Y. NakajimaYoichi Nakajima  
Testing Engineer

The distance of measurements was reduced to 3 meters.

Date : July 12, 2000

Temp.: 20 °C Humi.: 41 %

Operating Frequency : 133.8 kHz  
Distance of Measurement : 10 meters

Frequency (MHz)	Meter Reading (dBμV/m)	Field Strength (dBμV/m)
Fundamental		
0.1340	46.6	46.6
Harmonic Frequency		
0.2680	< 33.2	< 33.2
0.4020	< 31.4	< 31.4
0.5360	< 30.1	< 30.1
0.6700	< 29.0	< 29.0
0.8040	< 28.1	< 28.1
0.9380	< 27.3	< 27.3
1.0720	< 27.0	< 27.0
1.2060	< 27.0	< 27.0
1.3400	< 27.0	< 27.0

- Note: 1. Meter reading value shows field strength, because the value includes antenna factor.  
2. The symbol of "<" means "or less".  
3. Measuring Instrument Setting:

Frequency Range : 110 kHz to 490 kHz  
Detector Function : Average  
IF Band width : 10 kHz

Frequency Range : 536.8 kHz to 1345 kHz  
Detector Function : CISPR Quasi-peak Peak  
IF Band width : 9 kHz

For fundamental, the measured field strength was extrapolated to distance 300 meters, using the formula that field strength varies as the inverse distance square(40 dB per decade of distance).

Calculation :

$$46.6 \text{ dB}\mu\text{V/m} - 20\log_{10}((300/10)^2) = 46.6 - 59.1 = -12.5 \text{ dB}\mu\text{V/m at 300 meters}$$

$$\text{Limits for fundamental}(\S 15.209(a)) = 20\log_{10}(2400/134.0) = 25.1 \text{ dB}\mu\text{V/m}$$

Tested by : Y. Nakajima

Yoichi Nakajima  
Testing Engineer

**2.3 Radiated Emissions Measurement( 30 MHz - 1000 MHz )**

Date : July 12, 2000

Temp.: 20 °C Humi.: 41 %

Frequency (MHz)	Antenna Factor (dB/m)	Meter Reading (dBuV)		Limits (dBuV/m)	Emission Level (dBuV/m)		Margin (dB)		Comment
		Horiz.	Ver.		Horiz.	Ver.	Horiz.	Ver.	
32.0	18.8	< -2.0	0.7	40.0	< 16.8	19.5	> 23.3	20.6	
43.7	14.6	-0.3	8.1	40.0	14.3	22.7	25.7	17.3	
51.4	12.3	8.7	24.1	40.0	21.0	36.4	19.0	3.6	
59.5	9.6	< -2.0	3.5	40.0	< 7.6	13.1	> 32.4	26.9	
68.6	8.1	1.6	16.7	40.0	9.7	24.8	30.3	15.2	
79.2	7.4	2.0	13.1	40.0	9.4	20.5	30.6	19.5	
86.6	8.8	2.6	19.2	40.0	11.4	28.0	28.6	12.0	
102.9	12.0	-0.4	9.6	43.5	11.6	21.6	31.9	21.9	
119.9	13.9	0.7	6.6	43.5	14.6	20.5	28.9	23.0	
138.4	15.6	< -2.0	2.2	43.5	< 13.6	17.8	> 29.9	25.7	
168.0	17.2	< -2.0	< -2.0	43.5	< 15.2	< 15.2	> 28.3	> 28.3	
188.7	18.4	11.2	< -2.0	43.5	29.6	< 16.4	13.9	> 27.1	
223.0	18.6	1.3	1.3	46.0	19.9	19.9	26.1	26.1	
291.5	21.0	2.3	1.6	46.0	23.3	22.6	22.8	23.5	
325.9	18.7	15.1	13.6	46.0	33.8	32.3	12.2	13.7	
360.2	19.3	6.2	7.8	46.0	25.5	27.1	20.5	18.9	
446.0	21.0	4.0	4.4	46.0	25.0	25.4	21.0	20.6	
500.0	22.1	< -2.0	< -2.0	46.0	< 20.1	< 20.1	> 25.9	> 25.9	
600.0	24.3	< -2.0	< -2.0	46.0	< 22.3	< 22.3	> 23.7	> 23.7	
800.0	27.2	< -2.0	< -2.0	46.0	< 25.2	< 25.2	> 20.8	> 20.8	
1000.0	30.1	< -2.0	< -2.0	54.0	< 28.1	< 28.1	> 25.9	> 25.9	

- Notes:
- 1) Test Location : Anechoic Chamber
  - 2) Test Distance : 3 m
  - 3) Test spectram was checked from 30 MHz to 1000 MHz.
  - 4) Antenna factor includes the cable loss for 33 meter.
  - 5) The symbol of "<" means "or less".
  - 6) The symbol of ">" means "more than".
  - 7) A sample calculation was made at 32.0 MHz  
 $Af + Mr = 18.8 + 0.7 = 19.5 \text{ dBuV/m}$   
 Af : Antenna Factor Mr : Meter Reading
  - 8) Setting of measuring instrument :  
 Detector Function : CISPR Quasi-Peak  
 IF Bandwidth : 120 kHz

Tested by :



Yoichi Nakajima  
Testing Engineer

**Radiated Emissions Measurements (30 MHz - 1000 MHz)**

Measuring Distance : 3 m	○	Horizontal
Classifications : B	×	Vertical

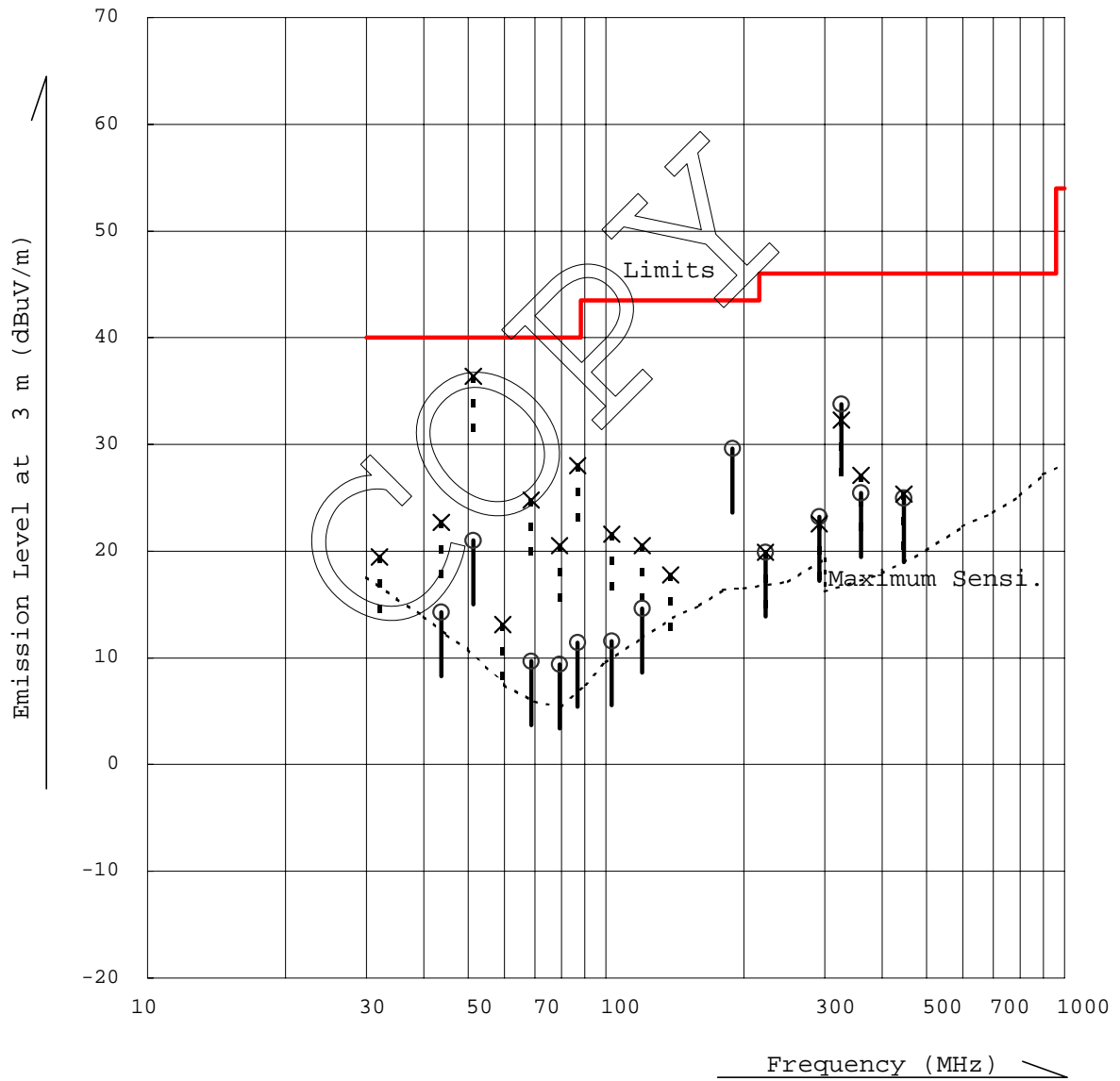



---

**2.4 Radiated Emissions Measurement( Above 1 GHz )**

Note : This test was not applicable.

**2.5 Frequency Stability Measurement**

Note : This test was not applicable.

**2.6 Occupied Bandwidth Measurement**

Note : This test was not applicable.

COPY