

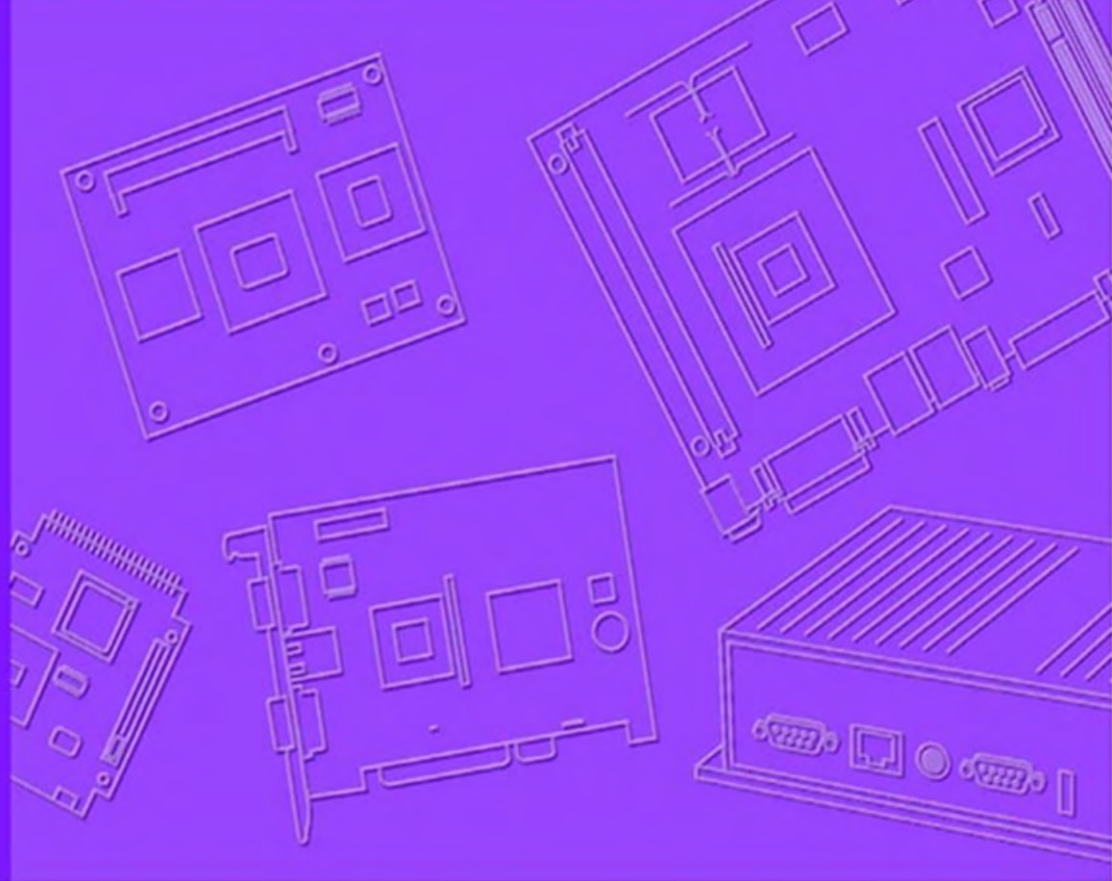

User Manual



WISE-3610

Wireless IoT LoRa Network Gateway

Trusted ePlatform Services

ADVANTECH

Copyright

The documentation and the software included with this product are copyrighted 2015 by Advantech Co., Ltd. All rights are reserved. Advantech Co., Ltd. reserves the right to make improvements in the products described in this manual at any time without notice. No part of this manual may be reproduced, copied, translated or transmitted in any form or by any means without the prior written permission of Advantech Co., Ltd. Information provided in this manual is intended to be accurate and reliable. However, Advantech Co., Ltd. assumes no responsibility for its use, nor for any infringements of the rights of third parties, which may result from its use.

Acknowledgements

ARM is trademarks of ARM Corporation.

NXP is trademarks of NXP Corporation.

All other product names or trademarks are properties of their respective owners.

Product Warranty (2 years)

Advantech warrants to you, the original purchaser, that each of its products will be free from defects in materials and workmanship for two years from the date of purchase.

This warranty does not apply to any products which have been repaired or altered by persons other than repair personnel authorized by Advantech, or which have been subject to misuse, abuse, accident or improper installation. Advantech assumes no liability under the terms of this warranty as a consequence of such events.

Because of Advantech's high quality-control standards and rigorous testing, most of our customers never need to use our repair service. If an Advantech product is defective, it will be repaired or replaced at no charge during the warranty period. For outof-warranty repairs, you will be billed according to the cost of replacement materials, service time and freight. Please consult your dealer for more details.

If you think you have a defective product, follow these steps:

1. Collect all the information about the problem encountered. (For example, CPU speed, Advantech products used other hardware and software used, etc.) Note anything abnormal and list any onscreen messages you get when the problem occurs.
2. Call your dealer and describe the problem. Please have your manual, product, and any helpful information readily available.
3. If your product is diagnosed as defective, obtain an RMA (return merchandise authorization) number from your dealer. This allows us to process your return more quickly.
4. Carefully pack the defective product, a fully-completed Repair and Replacement Order Card and a photocopy proof of purchase date (such as your sales receipt) in a shippable container. A product returned without proof of the purchase date is not eligible for warranty service.
5. Write the RMA number visibly on the outside of the package and ship it prepaid to your dealer.

Declaration of Conformity

Federal Communication Commission Interference Statement

This device complies with Part 15 of the FCC Rules. Operation is subject to the following two conditions: (1) This device may not cause harmful interference, and (2) this device must accept any interference received, including interference that may cause undesired operation.

This equipment has been tested and found to comply with the limits for a Class B digital device, pursuant to Part 15 of the FCC Rules. These limits are designed to provide reasonable protection against harmful interference in a residential installation. This equipment generates, uses and can radiate radio frequency energy and, if not installed and used in accordance with the instructions, may cause harmful interference to radio communications. However, there is no guarantee that interference will not occur in a particular installation. If this equipment does cause harmful interference to radio or television reception, which can be determined by turning the equipment off and on, the user is encouraged to try to correct the interference by one of the following measures:

- Reorient or relocate the receiving antenna.
- Increase the separation between the equipment and receiver.
- Connect the equipment into an outlet on a circuit different from that to which the receiver is connected.
- Consult the dealer or an experienced radio/TV technician for help.

FCC Caution: Any changes or modifications not expressly approved by the party responsible for compliance could void the user's authority to operate this equipment. This transmitter must not be co-located or operating in conjunction with any other antenna or transmitter.

For operation within 5.15 ~ 5.25GHz frequency range, it is restricted to indoor environment. This device meets all the other requirements specified in Part 15E, Section 15.407 of the FCC Rules.

Radiation Exposure Statement:

This equipment complies with FCC radiation exposure limits set forth for an uncontrolled environment. This equipment should be installed and operated with minimum distance 35cm between the radiator & your body.

Industry Canada statement:

This device complies with ISED's licence-exempt RSSs. Operation is subject to the following two conditions: (1) This device may not cause harmful interference, and (2) this device must accept any interference received, including interference that may cause undesired operation.

Le présent appareil est conforme aux CNR d'ISED applicables aux appareils radio exempts de licence. L'exploitation est autorisée aux deux conditions suivantes : (1) le dispositif ne doit pas produire de brouillage préjudiciable, et (2) ce dispositif doit accepter tout brouillage reçu, y compris un brouillage susceptible de provoquer un fonctionnement indésirable.

Caution:

(i) the device for operation in the band 5150-5250 MHz is only for indoor use to reduce the potential for harmful interference to co-channel mobile satellite systems;

- (ii) the maximum antenna gain permitted for devices in the band 5725-5850 MHz shall be such that the equipment still complies with the e.i.r.p. limits specified for point-to-point and non-point-to-point operation as appropriate; and
- (iii) Users should also be advised that high-power radars are allocated as primary users (i.e. priority users) of the bands 5650-5850 MHz and that these radars could cause interference and/or damage to LE-LAN devices.

Avertissement:

- (i) les dispositifs fonctionnant dans la bande 5150-5250 MHz sont réservés uniquement pour une utilisation à l'intérieur afin de réduire les risques de brouillage préjudiciable aux systèmes de satellites mobiles utilisant les mêmes canaux;
- (ii) le gain maximal d'antenne permis (pour les dispositifs utilisant la bande de 5725 à 5850 MHz) doit être conforme à la limite de la p.i.r.e. spécifiée pour l'exploitation point à point et l'exploitation non point à point, selon le cas;
- (iii) De plus, les utilisateurs devraient aussi être avisés que les utilisateurs de radars de haute puissance sont désignés utilisateurs principaux (c.-à-d., qu'ils ont la priorité) pour les bandes 5650-5850 MHz et que ces radars pourraient causer du brouillage et/ou des dommages aux dispositifs LAN-EL.

Radiation Exposure Statement:

This equipment complies with ISED radiation exposure limits set forth for an uncontrolled environment. This equipment should be installed and operated with minimum distance 44 between the radiator & your body.

Déclaration d'exposition aux radiations: Cet équipement est conforme aux limites d'exposition aux rayonnements ISED établies pour un environnement non contrôlé. Cet équipement doit être installé et utilisé avec un minimum de 44m de distance entre la source de rayonnement et votre corps.

Déclaration d'exposition aux radiations:

Cet équipement est conforme aux limites d'exposition aux rayonnements ISED établies pour un environnement non contrôlé. Cet équipement doit être installé et utilisé avec un minimum de 44m de distance entre la source de rayonnement et votre corps.

This radio transmitter (**IC: IC: 9404A-WISE3610 / Model: WISE-3610**) has been approved by ISED to operate with the antenna type listed below with maximum permissible gain indicated. Antenna types not included in this list, having a gain greater than the maximum gain indicated for that type, are strictly prohibited for use with this device.

Le présent émetteur radio (**IC: IC: 9404A-WISE3610 / Model: WISE-3610**) a été approuvé par ISED pour fonctionner avec les types d'antenne énumérés ci-dessous et ayant un gain admissible maximal. Les types d'antenne non inclus dans cette liste, et dont le gain est supérieur au gain maximal indiqué, sont strictement interdits pour l'exploitation de l'émetteur.

For LoRa								
Antenna No	Brand	Model	Antenna Gain(dBi) without cable loss	Frequency	Antenna Type	Antenna Connector	Cable Loss(dB)	Cable Length (mm)
1	Cortec	AN0915-9207BSM	0.96	902~928 MHz	Dipole	Reverse SMA	0.5	160
For WLAN								
Antenna No	Brand	Model	Antenna Gain(dBi) without cable loss	Frequency	Antenna Type	Antenna Connector	Cable Loss(dB)	Cable Length (mm)
2	Cortec	AN2450-92K01BRS	5.03	2400~2483.5 MHz	Dipole	Reverse SMA	0.5	180
			5.01	5150~5850 MHz	Dipole	Reverse SMA	0.8	180
For WWAN								
Antenna No	Brand	Model	Gain (dBi) <excluding cable loss>	Frequency	Antenna Type	Antenna Connector		
3	SINBON.	1750008424-01	-0.5	924~896 MHz	Dipole	SMA		
			-0.2	890~960 MHz				
			1.5	1427~1880 MHz				
			1.95	1850~1990 MHz				

NCC 警語:

經型式認證合格之低功率射頻電機，非經許可，公司、商號或使用者均不得擅自變更頻率、加大功率或變更原設計之特性及功能。低功率射頻電機之使用不得影響飛航安全及干擾合法通信；經發現有干擾現象時，應立即停用，並改善至無干擾時方得繼續使用。前項合法通信，指依電信法規定作業之無線電通信。低功率射頻電機須忍受合法通信或工業、科學及醫療用電波輻射性電機設備之干擾。

Safety Instructions

1. Read these safety instructions carefully.
2. Keep this User Manual for later reference.
3. Disconnect this equipment from any AC outlet before cleaning. Use a damp cloth. Do not use liquid or spray detergents for cleaning.
4. For plug-in equipment, the power outlet socket must be located near the equipment and must be easily accessible.
5. Keep this equipment away from humidity.
6. Put this equipment on a reliable surface during installation. Dropping it or letting it fall may cause damage.
7. The openings on the enclosure are for air convection. Protect the equipment from overheating. DO NOT COVER THE OPENINGS.
8. Make sure the voltage of the power source is correct before connecting the equipment to the power outlet.
9. Position the power cord so that people cannot step on it. Do not place anything over the power cord.
10. All cautions and warnings on the equipment should be noted.
11. If the equipment is not used for a long time, disconnect it from the power source to avoid damage by transient overvoltage.
12. Never pour any liquid into an opening. This may cause fire or electrical shock.
13. Never open the equipment. For safety reasons, the equipment should be opened only by qualified service personnel.
14. If one of the following situations arises, get the equipment checked by service

personnel:

- The power cord or plug is damaged.
- Liquid has penetrated into the equipment.
- The equipment has been exposed to moisture.
- The equipment does not work well, or you cannot get it to work according to the user's manual.
- The equipment has been dropped and damaged.
- The equipment has obvious signs of breakage.

DISCLAIMER: This set of instructions is given according to IEC 704-1. Advantech disclaims all responsibility for the accuracy of any statements contained herein.

Packing List

Before installation, please ensure the following items have been shipped.

- 1 WISE-3610 (refer to ordering information for different region)
- 1 Power Adapter (P/N: 96PSA-A36W12R1)
- 2 Wi-Fi Dual Band Antenna (P/N: 1750008001-01)
- 2 LoRa Antenna (Different region will pack different LoRa antenna)
- 2 Wall Mount Becket (P/N: 1960082071N001)
- 4 Wall Mount Becket Screw (P/N: 1930000071)

Optional Accessories

Part No.	Description
1700001524	Power Cable 3-pin 180cm, USA type
170203183C	Power Cable 3-pin 180cm, Europe type
170203180A	Power Cable 3-pin 180cm, UK type
1700008921	Power Cable 3-pin PSE Mark 183cm
1750008424-01	3G/LTE Antenna Dipole 4dBi Full Band
1750008669-01	3G/LTE RX Diversity Antenna Cable IPEX to IPEX Connector
968EMW0093	Mini PCIE HSPA 3G Card with Rx Diversity
1700001524	Power Cable 3-pin 180cm, USA type
170203183C	Power Cable 3-pin 180cm, Europe type
170203180A	Power Cable 3-pin 180cm, UK type

Ordering Information

Part No.	Description
WISE-3610ILS-51A1N	WISE-3610 Private LoRa Network IoT Gateway NA915
WISE-3610ILS-51A1E	WISE-3610 Private LoRa Network IoT Gateway EU868
WISE-3610ILS-51A1J	WISE-3610 Private LoRa Network IoT Gateway JP923
WISE-3610ILS-51A1T	WISE-3610 Private LoRa Network IoT Gateway TW920
WISE-3610ILS-51A1C	WISE-3610 Private LoRa Network IoT Gateway CN470

Chapter	1	2
	1.1	Product Features	4
	1.2	Mechanical Specifications	5
	1.3	Electrical Specifications	6
	1.4	Environmental Specifications	6
	1.5	Block Diagram.....	錯誤! 尚未定義書籤。
Chapter	2	7
	2.1	Jumpers	8
	2.1.1	Jumper Description	錯誤! 尚未定義書籤。
	2.1.2	Jumper List	錯誤! 尚未定義書籤。
	2.1.3	Jumper Setting.....	錯誤! 尚未定義書籤。
	2.2	Connectors	14
	2.2.1	Connector list	14
	2.2.2	Connector Settings	14
	2.3	Mechanical	錯誤! 尚未定義書籤。
	2.3.1	Jumper and Connector Location	18
	2.3.2	Board Dimension	錯誤! 尚未定義書籤。
	2.4	Quick Start Guide	錯誤! 尚未定義書籤。
	2.4.1	Debug Port Connection	錯誤! 尚未定義書籤。
	2.4.2	Debug Port Setting	錯誤! 尚未定義書籤。
Chapter	3	21
Chapter	4	錯誤! 尚未定義書籤。
Chapter	5	69
	5.1	RISC Design-in Services	錯誤! 尚未定義書籤。
	5.2	Contact Information	70
	5.3	Global Service Policy	70
	5.3.1	Warranty Policy	70
	5.3.2	Repair Process	71

Chapter 1

General Introduction

This chapter gives background information on the WISE-3610.

Sections include:

- Introduction
- Specification

Introduction

WISE-3610 is Qualcomm Atheros (QCA) ARM Cortex-A based hardware platform, which is operating at OpenWRT, described as a Linux distribution for embedded networking devices. The Advantech WISE-3610 Industrial Gateway is Advantech LPWAN IoT gateway design for smart city, Industrial 4.0 applications, even those in harsh environment, leveraging wireless sensor technology. This LPWAN IoT gateway can aggregate both the wireless sensor networks (WSN), including Low Power WAN (LPWAN) technology by Advantech Private LoRa technology – WISE-Link, wired sensors and ties them into an IP network. With modular slot design, it can agilely adapt to a variety of wireless technologies at regional RF bands, wireless communication protocol by various uplink requirement and quickly go to market.

The main features of WISE-3610 are:

- Qualcomm Atheros Quad-Core ARM Cortex-A7 SoC
- Built-in Dual Band Concurrent Wi-Fi MU-MIMO (2x2)
- LPWAN Private LoRa (WISE-Link) Connectivity
- WAN x1 / LAN x1 Gigabit Ethernet
- Integration of Modbus TCP and Modbus RTU network Translator
- IPsec / L2TP VPN Traffic Encryption
- Rich Network Scenario by S/W Configuration
- WAN / WWAN Failover backup support
- WWAN Dual SIM Failover backup support
- Modularization hardware design
- OpenWRT BSP embedded
- Web UI user interface
- Support wide temperature -20 ~ 70 °C

1.1 Product Features

Processor System	CPU	QCA Quad-core ARM Cortex A7 CPU 716 MHz
Memory	Technology	DDR3L 1066MHz
	Capacity	On-board 256MB
	Flash	128MB
Ethernet	WAN	1 x 10/100/1000Mbps
	LAN	1 x 10/100/1000 Mbps
COM (Serial)	H/W Selection	RS-232/RS-422/RS-485 (default configures as RS-485)
	ModBus	ModBus TCP / RTU Translator
Security	VPN Engine	IPSec, L2TP
Connectivity	Wi-Fi	2x2 Concurrent Dual Band 2.4Ghz/5Ghz
	LoRa	2x2 Private LoRa Network – WISE-Link
Antenna	Wi-Fi	2 2.4Ghz / 5Ghz @ 5dBi
	LoRa	2 433Mhz / 868Mhz / 915Mhz @ 1dBi
Expansion Slot	Mini-PCle	1 Full size mini PCie slot for 3G WWAN module
	SD Card	1 Micro SD Socket up-to 128GB
	SIM	2 Micro SIM Slot for WWAN dual SIM Failover
Wi-Fi	Standard	IEEE802.11a/b/g/n/ac
	Multiplexing	OFDM
	Modulation	BPSK, QPSK, 16QAM, 64QAM, 256QAM (11ac)
	Media Access	CSMA/CA with ACK
	Associated STA	100 stations per radio
	Channel	2.4Ghz: <ul style="list-style-type: none"> CH1 – 11: North America, Taiwan CH1- 13: EU, Japan, China 5Ghz: <ul style="list-style-type: none"> CH36, 40, 44, 48 (Band 1): North America, EU, Japan, China CH149, 153, CH157, 161, 165 (Band4): North America, Taiwan, China
	Bandwidth	HT20/HT40/HT80
	Max TX Power	The maximum allowable RF power level is subject to specified nation regulation <ul style="list-style-type: none"> 2.4Ghz < 20dBm 5Ghz < 23dBm
RX Sensitivity	2.4Ghz: <ul style="list-style-type: none"> HT20 (11n): -64 dBm at MCS 7/15 HT40 (11n): -61dBm at MCS 7/15 5Ghz: <ul style="list-style-type: none"> HT20 (11n): -64dBm at MCS7/15 HT40 (11n): -61dBm at MCS 7/15 HT20 (11ac): -57dBm at MCS9 HT40 (11ac): -54dBm at MCS9 HT80 (11ac): -51dBm at MCS9 	
LoRa	Standard	Sub-Ghz radio station regulation

	Bandwidth	125Khz / 250Khz / 500Khz
	Multiplexing	TDMA
	Modulation	LoRa
	Freq. Band	CN 470Mhz, EU 868Mhz, NA 915Mhz, AS 923Mhz
	Media Access	WISE-Link semi-persistent scheduling (SPS) with ACK
	Associated Node	500 nodes
	Data Rate	Spread Factor (SF) 7 - 12
	Max TX Power	The maximum allowable RF power level is subject to specified nation regulation <ul style="list-style-type: none"> LoRa < 18dBm
	RX Sensitivity	<ul style="list-style-type: none"> LoRa > -136dBm at SF = 12 / 125KHz LoRa > -133dBm at SF = 12 / 250KHz LoRa > -130dBm at SF = 12 / 500KHz
O.S	Linux	V 3.14
Dimensions	W x L x T	187.9mm x 150mm x 39mm
Weight	Net Weight (g)	990 gram
Power	DC-In	12V DC-In
Power Consumption	Watt	18 watt (Max)
Environment	Operational Temperature	-20 ~ 70° C
	Operating Humidity	10% ~ 95% relative humidity, non-condensing
Certifications	Level	CE / FCC / Class B / TELEC / SRRC / NCC

1.2 Mechanical Specifications

Dimensions

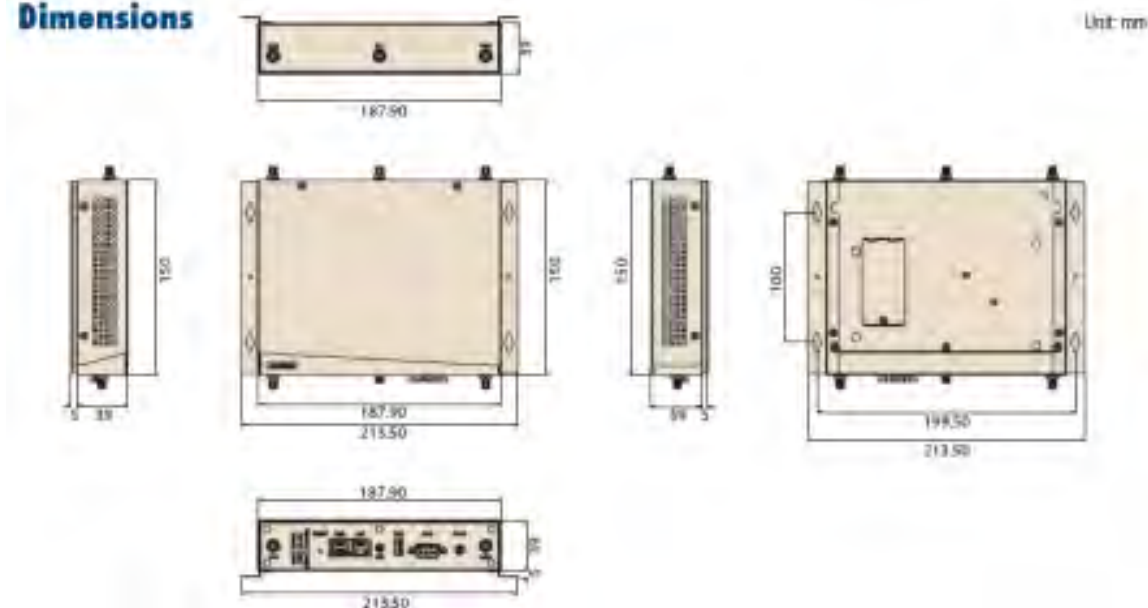

- **Dimension:** 187.9mm x 150mm
- **Height:** 39mm
- **Reference Weight:** 990g (including wall mounting kits)

1.3 Electrical Specifications

- **Power supply type:** DC-in 12V
- **RTC Super Capacitor: Panasonic (P/N: EECS0HD224)**
 - Typical voltage: 4.3V
 - Nominal capacity: 0.22F

1.4 Environmental Specifications

- **Operating temperature:** -20~70°C (-4~157°F)
- **Operating humidity:** 10% ~ 95% relative humidity, non-condensing
- **Storage temperature:** -40~85°C (-40~185°F)
- **Storage humidity:** 60°C @ 95% RH Non-condensing
- **Vibration Loading During Operation (Automotive grade):** 3 Gms, random, 5 ~ 500 Hz

Chapter 2

H/W Installation

This chapter gives mechanical and connector information on the WISE-3610

Sections include:

- Information of WISE-3610 I/O Indication
- On Board Connectors and Switches
- WISE-3610 Hardware Installation

2.1 Introduction

The following sections show the internal / external connectors and pin assignments for applications.

2.1.1 WISE-3610 I/O Indication

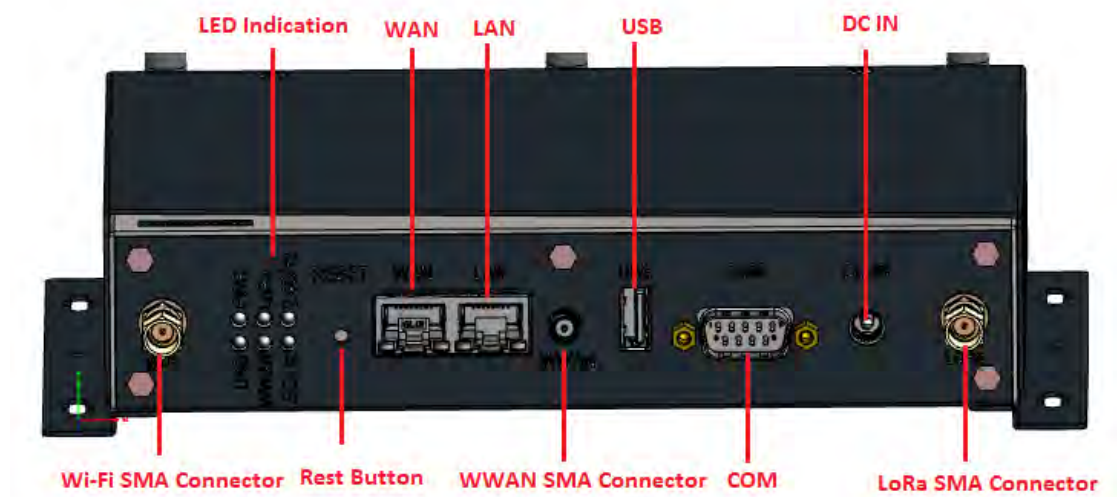

Figure 2.1 WISE-3610 Front view



Figure 2.2 WISE-3610 Rear view

2.1.2 WISE-3310 Antenna Connectors

The WISE-3610 provides 6 SMA antenna connectors; all are assembled by default on housing. Wi-Fi, LoRa antennas (total are four) are packed in the package. To enable WWAN feature, need to have following table materials and assemble manually by the guides (refer to hardware installation guide 2.3.2):



Figure 2.3 Antenna SMA in front panel



Figure 2.4 Antenna SMA in rear panel

Table 2.1 : WWAN related materials

968EMW0093	Mini PCIE HSPA 3G Card with Rx Diversity
1750008424-01	3G/LTE Antenna Dipole 4dBi
1750008669-01	3G/LTE RX Diversity Antenna Cable IPEX to IPEX Connector
193B0204C0	Mini-PCI Express Card Screw

2.1.3 LED Indication

Name	Description
PWR	Steady ON = Power Up
	OFF = Power Down
USB	Steady ON = USB device detected
	Blinking = TX / RX Transmission
	OFF = No USB device connected
LoRa	Steady ON = LoRa Module detected
	Blinking = TX / RX Transmission
	OFF = LoRa Module disabled
WWAN	Steady ON = WWAN Module detected
	Blinking = TX / RX Transmission
	OFF = No WWAN Module detected

2.4Ghz	Blinking = TX / RX Transmission
	OFF = 2.4G Wi-Fi interface disabled
5Ghz	Blinking = TX / RX Transmission
	OFF = 5G Wi-Fi interface disabled
WAN	Brown LED Blinking = 10M/100Mbps TX / RX Transmission
	Green LED Blinking = 1000Mbps TX / RX Transmission
LAN	Brown LED Blinking = 10M/100Mbps TX / RX Transmission
	Green LED Blinking = 1000Mbps TX / RX Transmission

Table 2.2 WISE-3610 LED Indication



Figure 2.5 WISE-3610 LED locations

2.1.4 Reset Button

The WISE-3610 has a reset button on the front side. Press this button to activate the hardware reset function for more than 8 seconds.



Figure 2.6 Rest button location

2.1.5 Ethernet Connector (WAN, LAN)

The WISE-3610 provides one RJ45 WAN and one RJ45 LAN interface connectors, they are fully compliant with IEEE802.3ab / IEEE 802.3u and

IEEE 802.3x Flow Control 10/100/1000 Base-T CSMA/CD standards. These Ethernet ports provide standard RJ-45 connector with LED indicators to show Active/Link status.



2.1.6 USB 3.0 Port

The WISE-3310 provides one USB 3.0 interface.



2.1.7 COM Port

The WISE-3610 provides one serial D-sub 9 COM port which could be configured either one RS-232 / RS-422 / RS-485 interface for Modbus RTU feature. Open the housing to change hardware switch (Location at SW6) on PCBA for corresponding demand interface (default setup is RS-485).



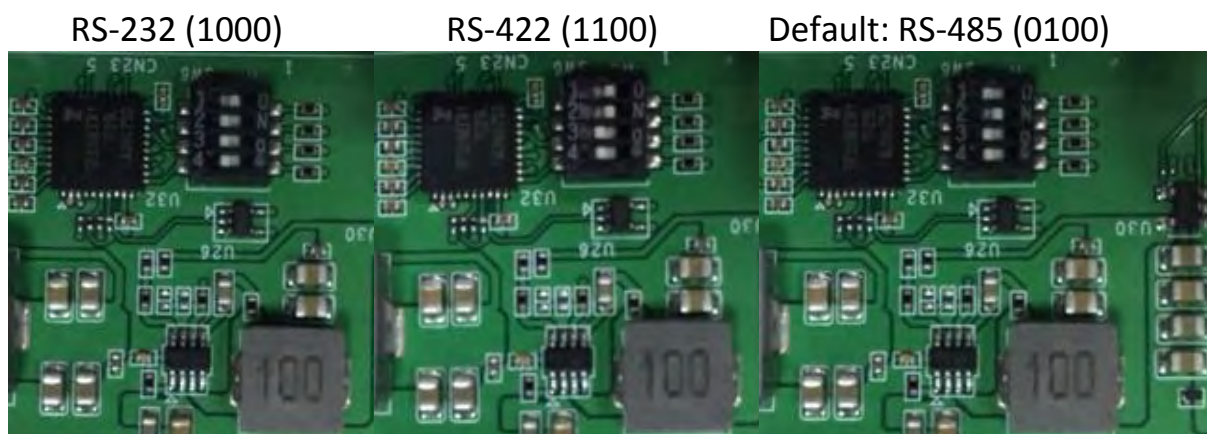

2.1.8 Power Input Connector

The WISE-3610 comes with a DC-jack header for 12V DC external power input. The Maximum power consumption is around 18 Watt.



2.1.9 Micro SD Connector

The WISE-3610 provides a Micro SD slot. Users can insert a Micro SD card easily by open the housing regarding to security concern (probably, users may save sensitive LoRa node collected data or other application into this Micro SD card supports up-to 128GB).

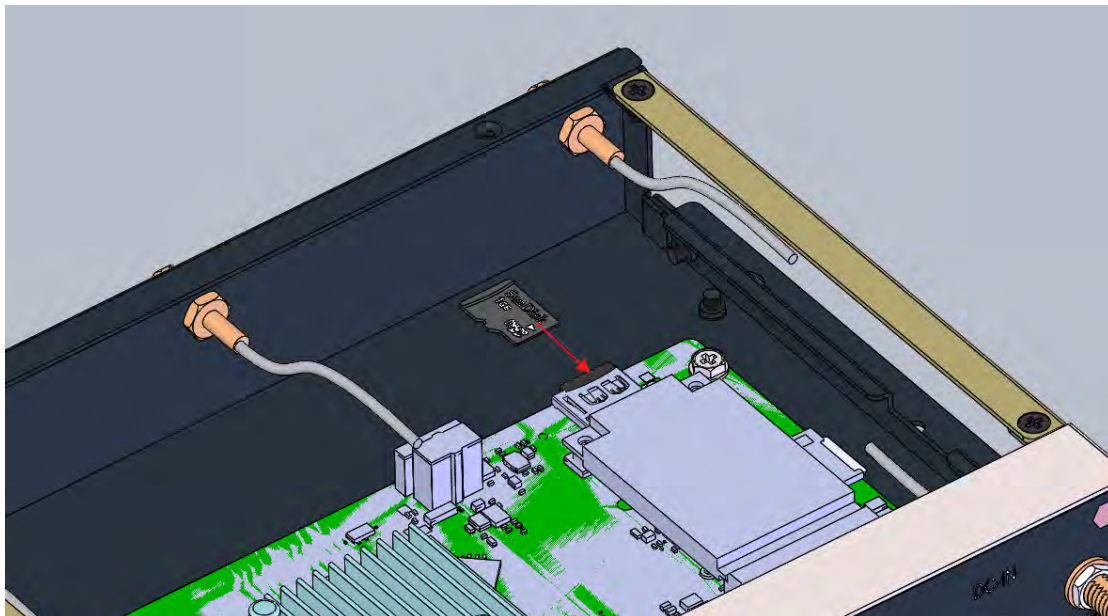

2.1.10 Micro SIM Connector

The WISE-3610 has two micro SIM slots. Users can insert two micro SIM cards manually. Two telecomm operating SIMs for backup each other if the connection loss. The SIM slot locations are on top and bottom of PCBA. The 1st priority SIM slot (Primary) is on top side of PCBA and the 2nd priority is on bottom side of PCBA. Refer to the following figures for indication.

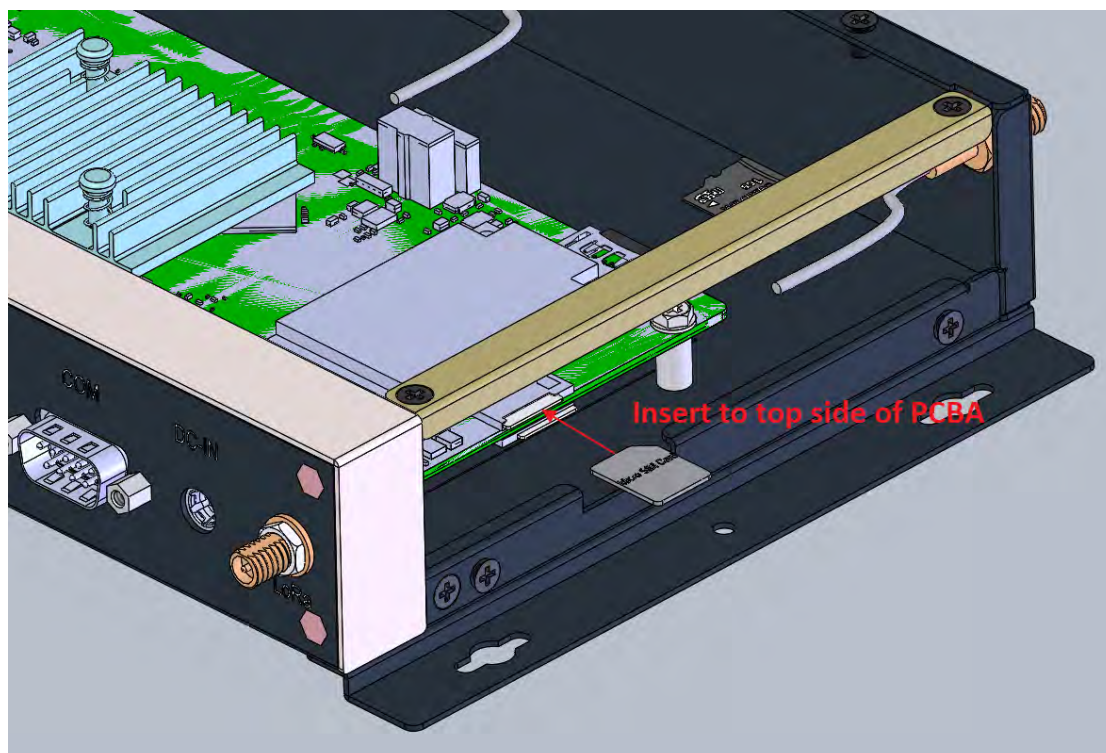

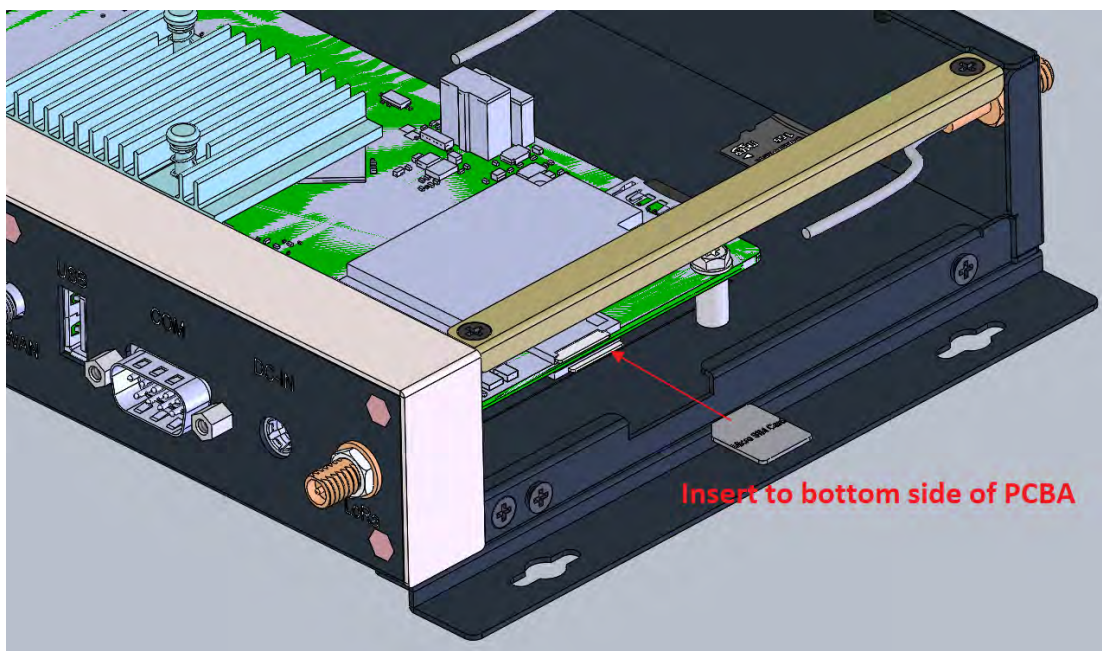

2.2 On Board Connectors and Switches

2.2.1 Connector and switch lists

CN12	SD Card Slot
CN28	Micro SIM Card Slot 1 (Primary)
CN27	Micro SIM Card Slot 2 (Secondary)
CN22	Mini-PCIe Card Slot
SW6	RS-232 / RS-422 / RS-485 hardware switch
CN18	WWAN IPEX Connector

2.2.2 Connector Settings

2.2.2.1 CN12 Micro SD Card Slot

WISE-3610 support a Micro SD card slot up-to 128GB stored space

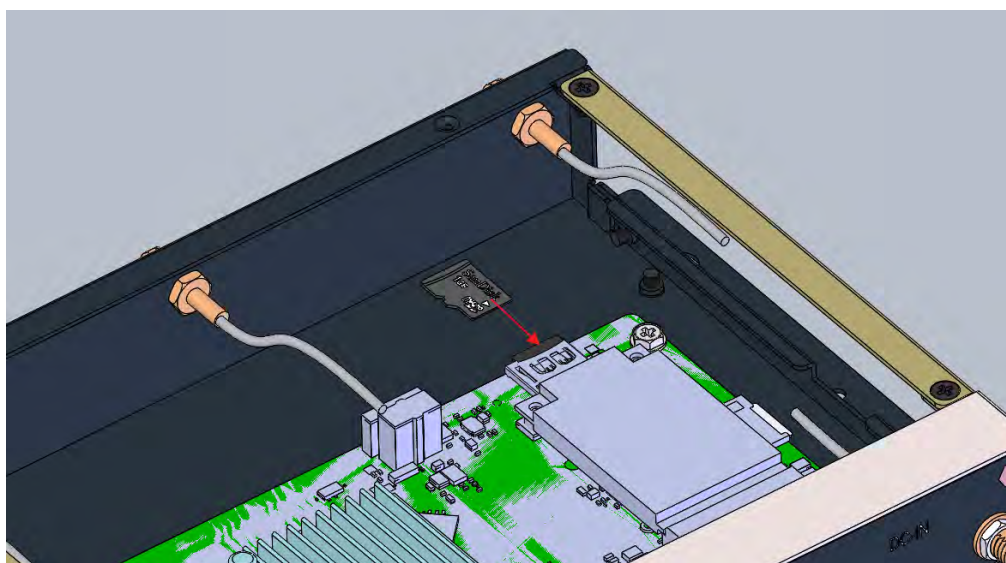

SD Slot

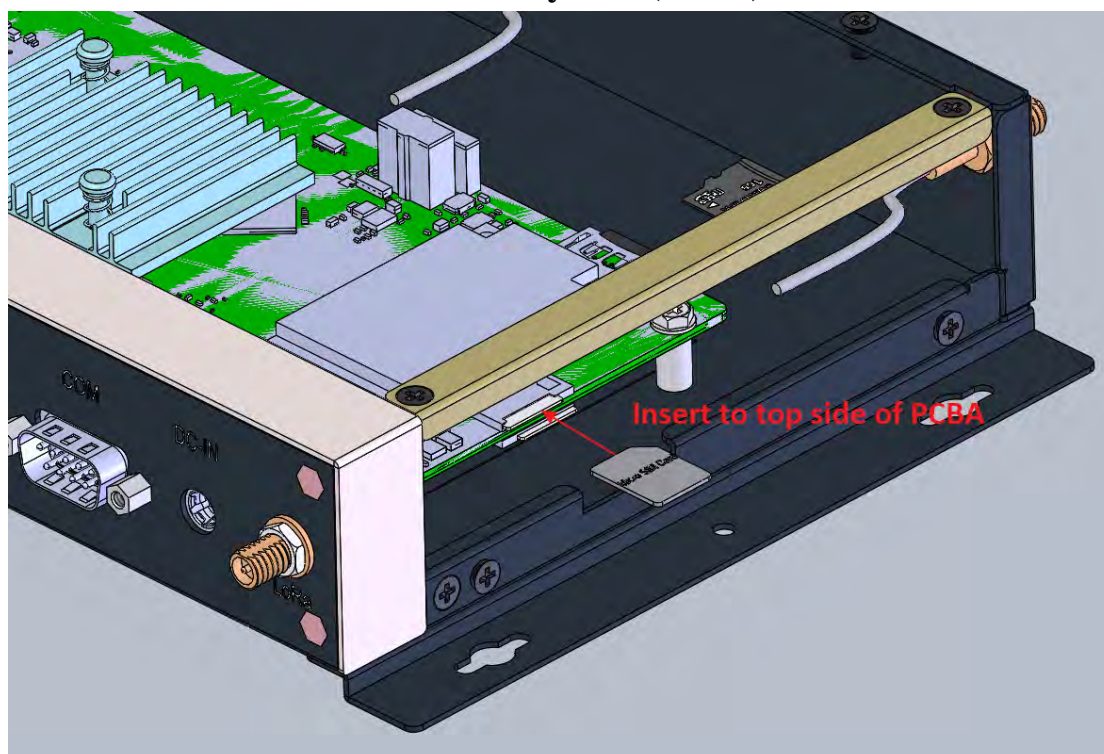
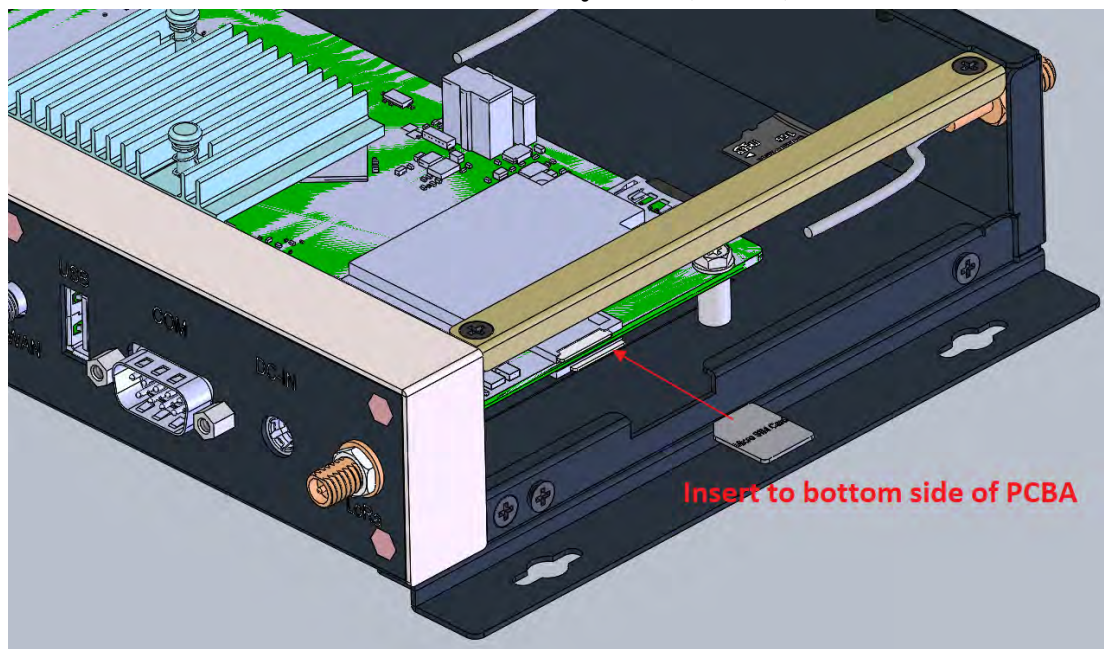
2.2.2.2 Micro SIM Card Primary Slot (CN28)**2.2.2.3 Micro SIM Card Secondary Slot (CN27)****2.2.2.4 Mini PCIE (CN5)**

WISE-3610 supports mini-pcie interface. Default support WWAN 3G module that are listed in "Table 2.1". The detailed pin definition is listed as below.

	mini-PCle	CN22		mini-PCle	
1	WAKE#	NC	+V_LTE	+3p3Vaux_1	2
3	COEX1#	NC	GND	GND_1	4
5	COEX2#	NC	NC	+1p5V_1	6
7	CLKREQ#	NC	LTE_UIM_PWR	UIM_PWR	8
9	GND_2	GND	LTE_UIM_DATA	UIM_DATA	10
11	REFCLK-	NC	LTE_UIM_CLK	UIM_CLK	12
13	REFCLK+	NC	LTE_UIM_RESET	UIM_RESET	14
15	GND_3	GND	NC	UIM_VPP	16
17	Reserved_6/UIM_C8	NC	GND	GND_4	18
19	Reserved_5/UIM_C4	NC	LTE_W_DIS#	W_DISABLE#	20
21	GND_5	GND	LTE_RTS#	PERST#	22
23	PERn0	NC	+V_LTE	+3p3Vaux_2	24
25	PERp0	NC	GND	GND_6	26
27	GND_7	GND	NC	+1p5V_2	28
29	GND_8	GND	NC	SMB_CLK	30
31	PETn0	NC	NC	SMB_DATA	32
33	PETp0	NC	GND	GND_9	34
35	GND_10	GND	LTE_USB_D-	USB_D-	36
37	GND_11	GND	LTE_USB_D+	USB_D+	38
39	+3p3Vaux_3	+V_LTE	GND	GND_12	40
41	+3p3Vaux_4	+V_LTE	LTE_LED	LED_WWAN#	42
43	GND_13	GND		LED_WLAN#	44
45	Reserved_1	NC		LED_WPAN#	46
47	Reserved_2	NC	NC	+1p5V_3	48
49	Reserved_3	NC	GND	GND_14	50
51	Reserved_4	NC	+V_LTE	+3p3Vaux_5	52

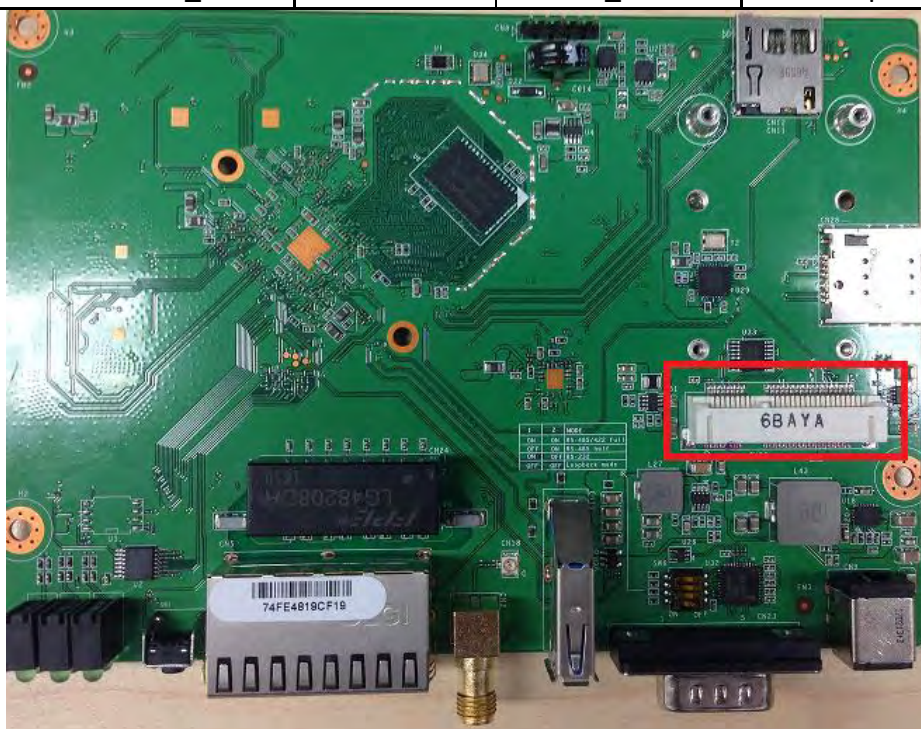

Mini-PCIE CONNECTOR

2.2.2.5 Hardware switch (SW6)

WISE-3610 supports a hardware switch to change RS-232 / RS-422 / RS-485 for selection. Default is RS-485 by manufacturer setting.

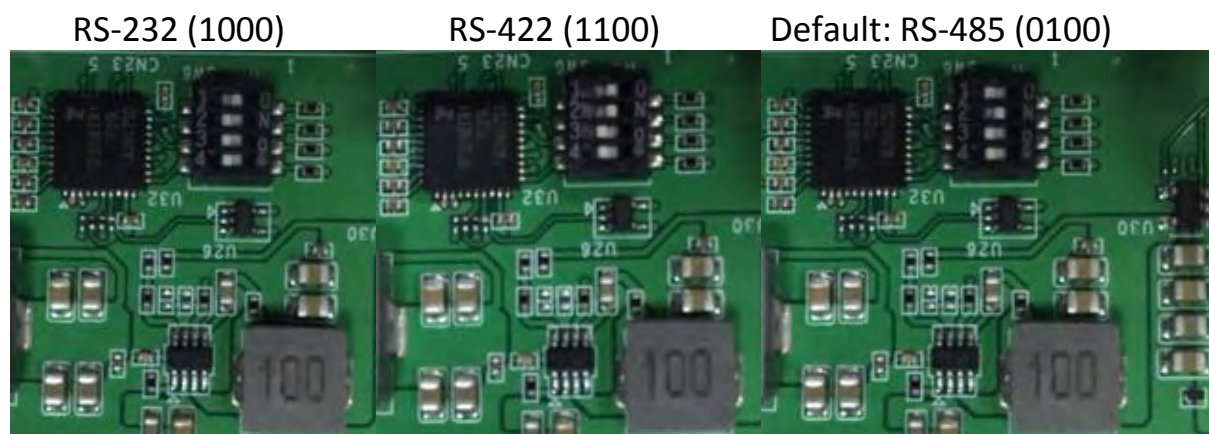

Hardware Switch for serial type selection

2.2.2.6 WWAN IPEX Connector (CN18)

If there is WWAN 2nd antenna demand to have 3G Rx diversity feature by connecting CN18 IPEX to mini-PCie IPEX connector on the 3G module.

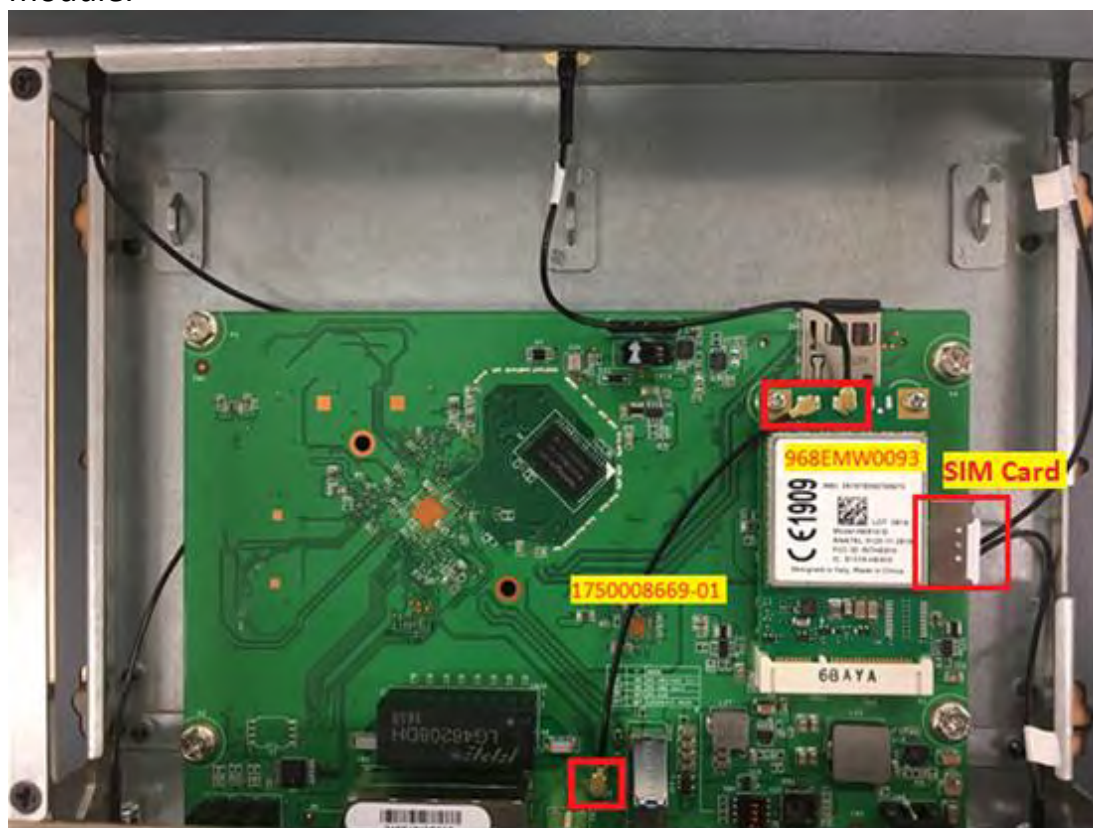

CN18

CN18 and 3G module connection guidance

2.3 WISE-3610 Hardware Installation

2.3.1 Mounting Assembly Method

You can fix WISE-3610 to a wall by using wall mounting kit, as following figure.

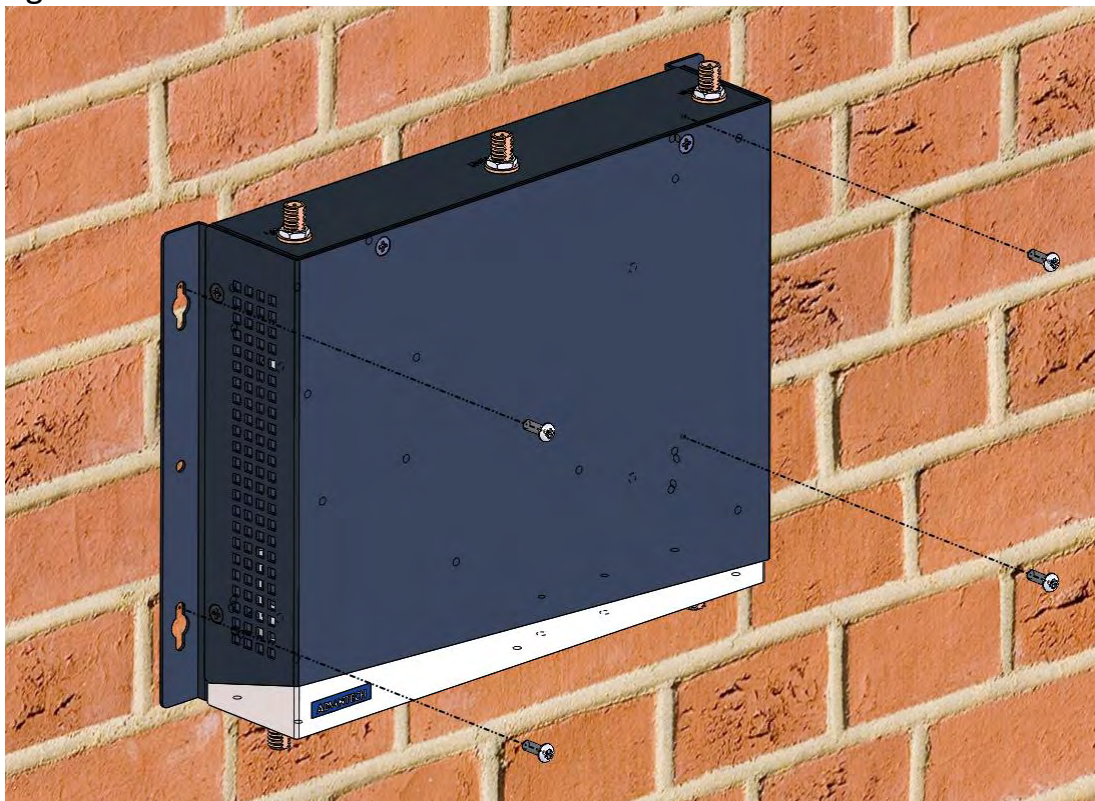

2.3.2 Enable WWAN feature with hardware installation

WISE-3610 has native support 3G and 4G LTE backhaul for WWAN card installation and accessories by the following order list and procedures:

NO	Content	Description	Qty	Remark
1	968EMW0093	Mini PCIE HSPA 3G Card with Rx Diversity	1	Frequency Band: 800/850, 900, AWS1700, 1900, 2100
2	EWM-C117FL02 E	LTE Card for Cat. 4 (150Mbps / 50Mbps)	1	LTE Bands: 1, 3, 5, 7, 8, 20 (EU, Asia)
3	1750008424-01	3G/LTE Antenna Dipole 4dBi Full Band	2	
4	1750008669-01	3G/LTE RX Diversity Antenna Cable IPEX to IPEX Connector	1	
5	193B0204C0	Mini-PCI Express Card Screw	2	

1. Open WISE-3610 top case by releasing 6 screws around housing (from top and side view)

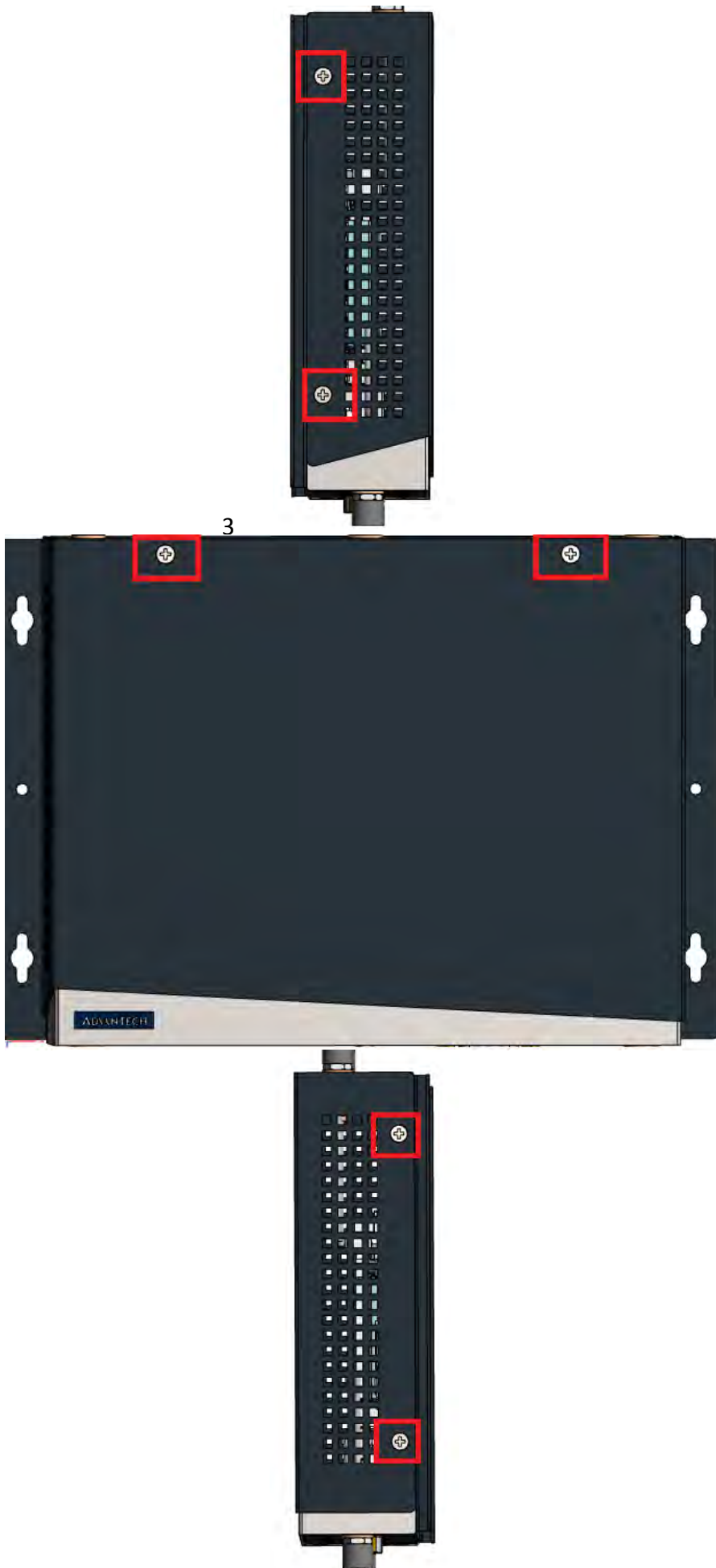

2. Install 968EMW0093 3G card into mini-PCIe slot on the top layer of WISE-3610 PCBA
3. Assembly 2 x antenna cables (one is 1750008669-01 and the other one has already provided in housing) on 3G module by the following figure guidance

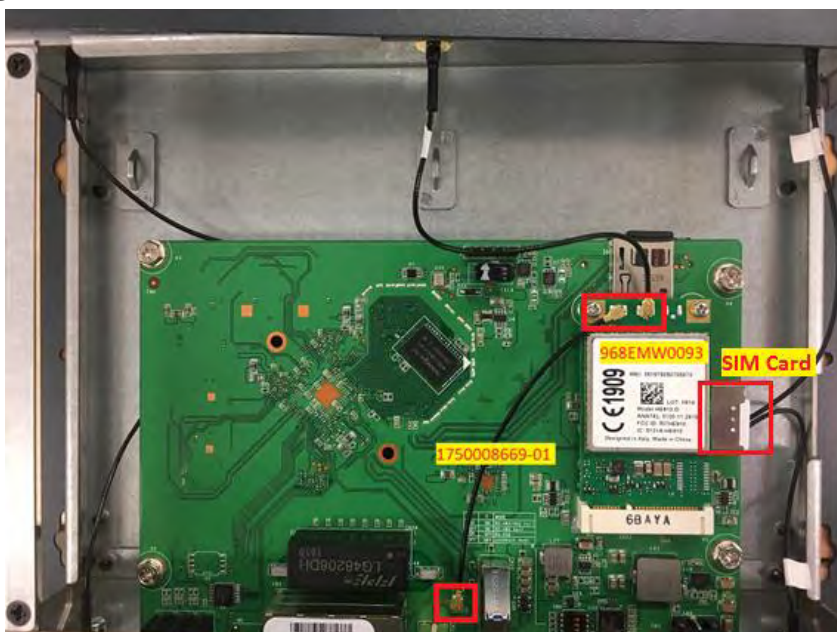

4. Insert SIM Cards applied from local Internet Service Provider (ISP) into system (there is 2 SIM slots into WISE-3610 to support Dual-SIM Failover). One is on top of PCBA and the other is on the bottom side of PCBA at the same location shown on above photo.
5. Close WISE-3610 top case
6. Assembly 2x 1750008424-01 antennas in the front / rear of panels in the location of WWAN ports for H/W installation completion.

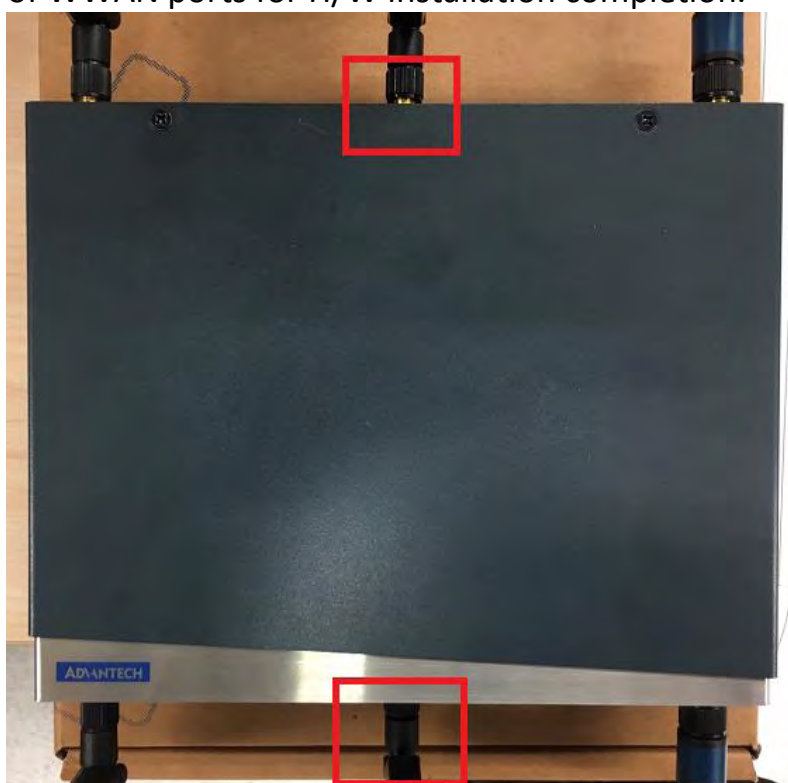

Chapter 3

Software Functionality

This chapter details the software configurations on the WISE-3610.

3 Software

3.1 WEB GUI Login

- Step 1: Access the WEB GUI, user can introduce `http://192.168.1.1` on browser tool. User can also use `http://advantech.local` local domain technology to access Web GUI without figuring out the IP address of device.
- Step 2: The default WEB GUI Login account:
Username: root
Password: Advantech

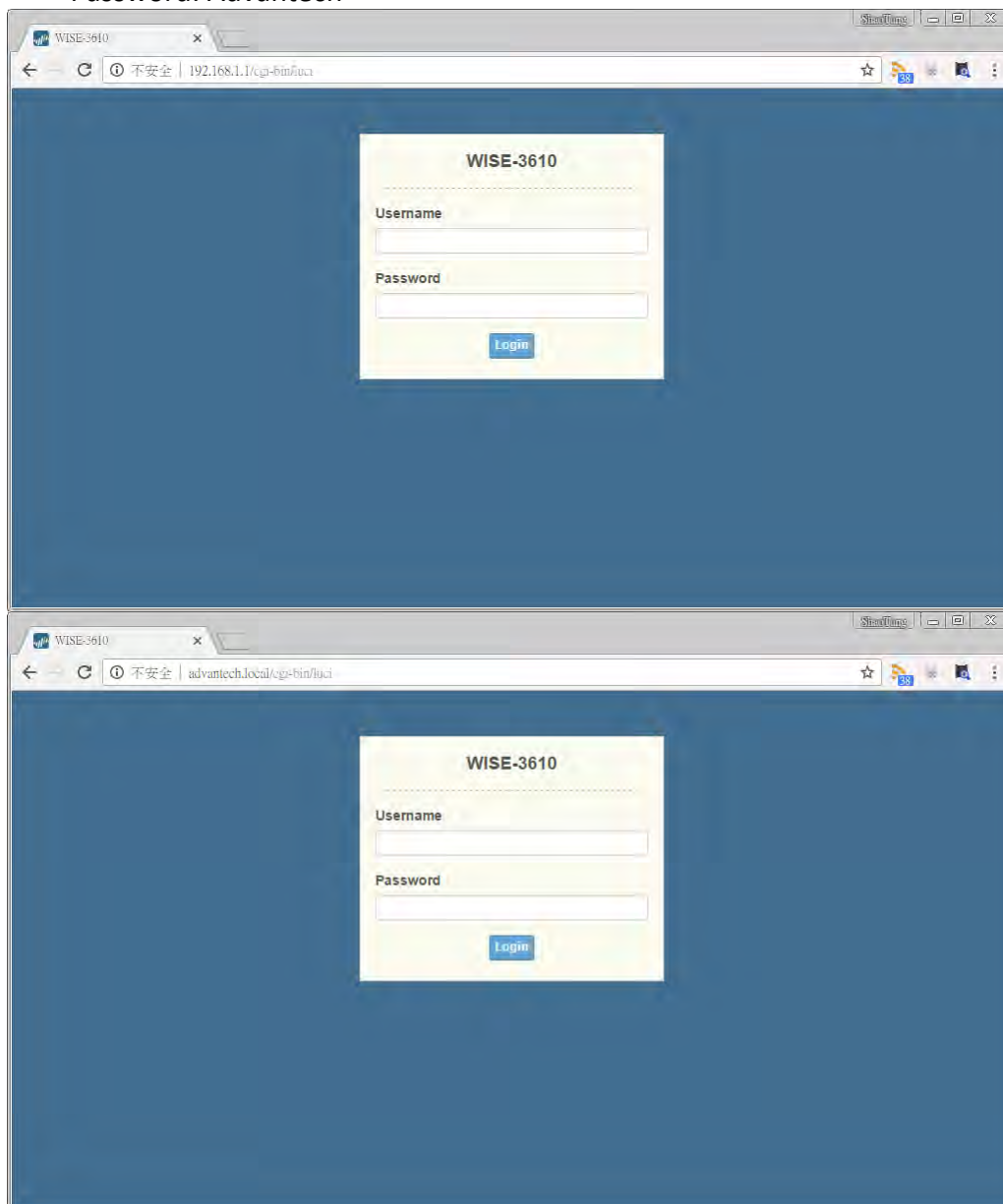

3.2 Gateway Deployment Function Comparison

There are 4 kinds of Gateway Deployment modes applied to different deployment scenarios. The NorthBound configuration is “WAN”, “WWAN”, “2.4GHz WIFI”, and “5GHz WIFI”, respectively.

Scenario NO	WWAN (3G/LTE)	WAN (Ethernet)	WISE-3610 DHCP Server @LAN/WLAN	WISE-3610 DHCP Client @WLAN	LAN (Ethernet)	Wi-Fi 2.4Ghz	Wi-Fi 5Ghz	LoRa
1	O	O	O	X	O	AP	AP	AP
2	O	X	O	X	O	AP	AP	AP
3	X	X	X	O	O	STA + AP	AP	AP
4	X	X	X	O	O	AP	STA + AP	AP

Scenario NO	WISE-3610 Wi-Fi 2.4Ghz SSID	WISE-3610 Wi-Fi 5Ghz SSID	Remarks
1	Advantech	Advantech_5Ghz	Factory Default
2	Advantech	Advantech_5Ghz	
3	Connect uplink Root AP and broadcast SSID, which SSID is the same to uplink Root AP	Copy uplink SSID and add suffix "_5Ghz" over SSID Broadcast name. i.e., XXXX_5Ghz	
4	Copy Uplink SSID and add suffix "_2Ghz" over SSID Broadcast name. i.e., XXXX_2Ghz	Connect uplink Root AP and broadcast SSID, which SSID is the same to uplink Root AP	

3.3 Gateway Deployment (WAN)

3.3.1 NorthBound

Visit [Network → Gateway Deployment](#). The LoRa Gateway support 4 kinds of deployment scenarios to connect to customer’s network, including “WAN”, “WWAN”, “2.4GHz WIFI” and “5GHz WIFI”. The NorthBound item is used to choose the deployment scenarios.

3.3.2 Protocol

To choose the protocol for NorthBound connection. This protocol item only shows up when NorthBound is configured to WAN and it will be hid when NorthBound is configured to other values.

(1) DHCP Client

To chooses DHCP client, and LoRa gateway will try to get IP on Ethernet WAN port via DHCP protocol.

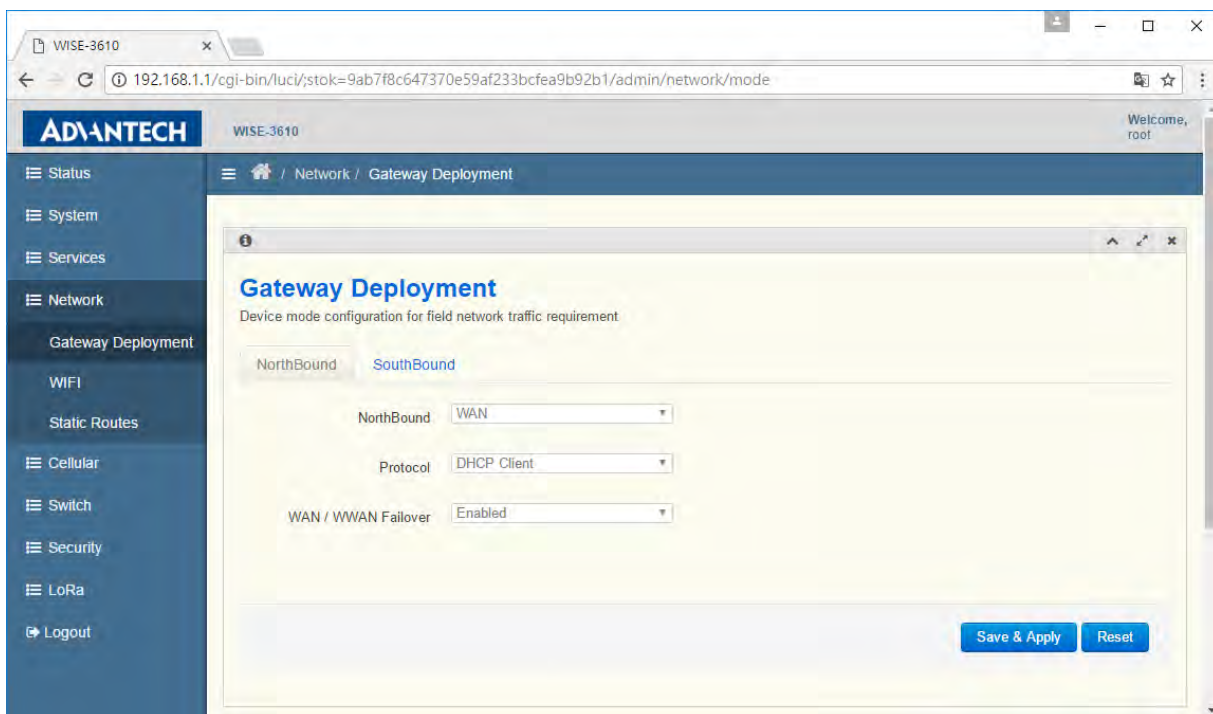

(2) Static IP

When user chooses Static IP, LoRa gateway will use static IP provided on Ethernet WAN port. In addition, user need to configure related IPv4 address, IPv4 netmask, IPv4 gateway, DNS servers.

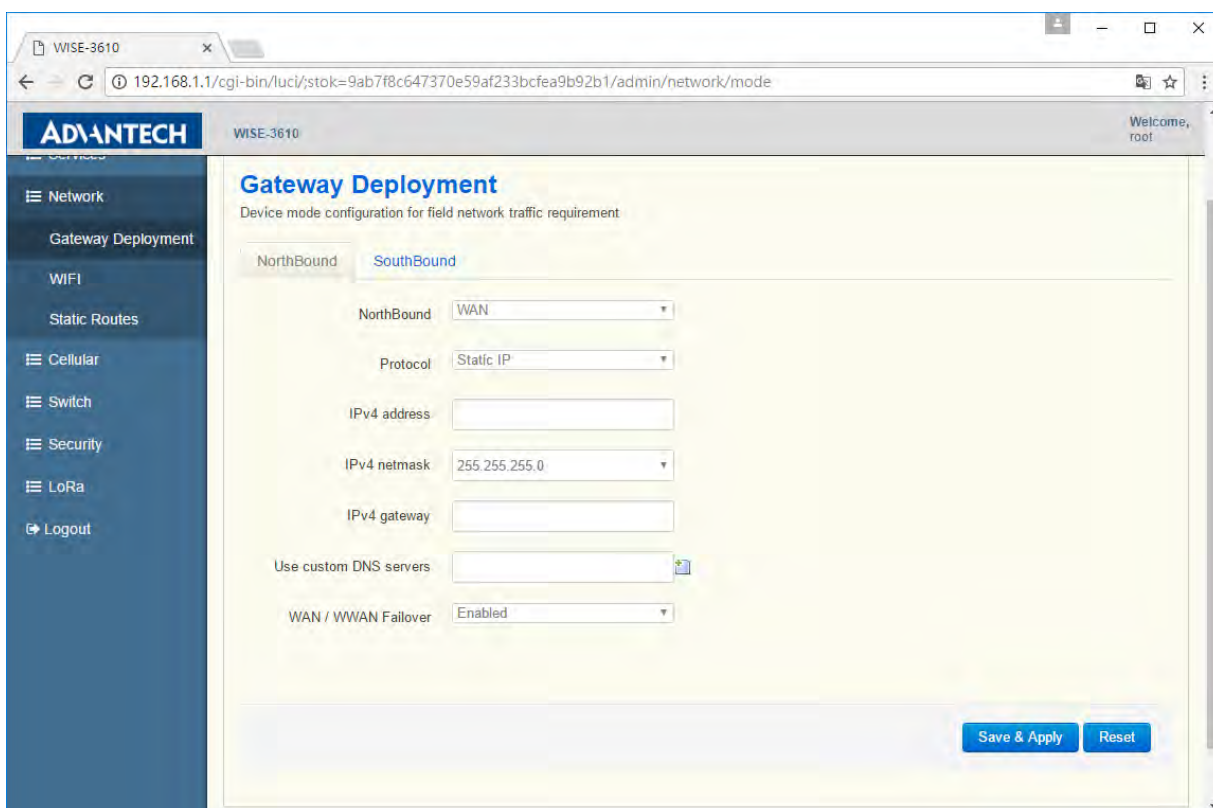

(3) PPPoE

When user chooses PPPoE, LoRa gateway will try to get IP on Ethernet WAN port via PPPoE protocol. In addition, user need to configure related PAP/CHAP username, and password. The Access Concentrator and Service Name are optional according to operator's environment.

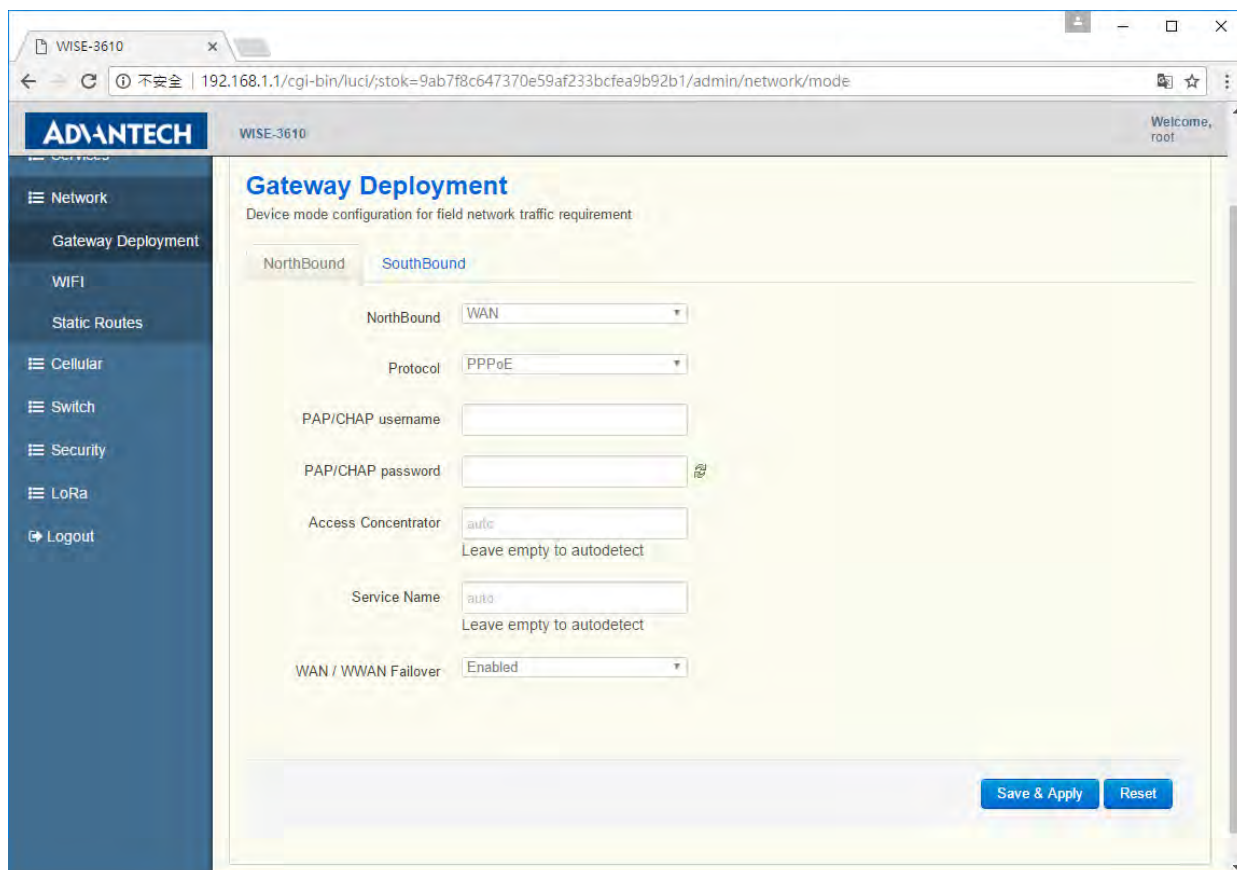

3.3.3 WAN / WAN Failover

When WAN / WWAN Failover function is enabled, LoRa gateway will use Ethernet WAN or 3G module to connect to network. When LoRa gateway boots up, it prefers to use Ethernet WAN to connect to network, and will switch to 3G if there are no traffic in a minute. In addition, it will switch to Ethernet WAN if there are no traffic on 3G interface. When this function is disabled, only Ethernet WAN can be used to connect to network.

3.3.4 SouthBound

Visit *Netowk* → *Gateway Deployment*. The SouthBound TAB includes LAN side IP and DHCP server related settings.

3.3.4.1 LAN IPv4 address and netmask

The SouthBound LAN side IP address and netmask setting

3.3.4.2 DHCP Server

The ON/OFF switch for LAN side DHCP Server function

3.3.4.3 Start

The start of IP address that DHCP Server will assign to client. User can input lowest leased address as offset from the LAN IPv4 address (e.g. 100) or input the exactly start of IP address (e.g. 192.168.1.100).

3.3.4.4 Limit

Maximum number of leased addresses from start of IP address. If user configures LAN side IP to 192.168.1.1/24, Start to 100 and Limit to 150, it means the IP address pool of DHCP server is 192.168.1.100~192.168.1.249.

3.3.4.5 Leasetime

Lease time of assigned IP address from DHCP server

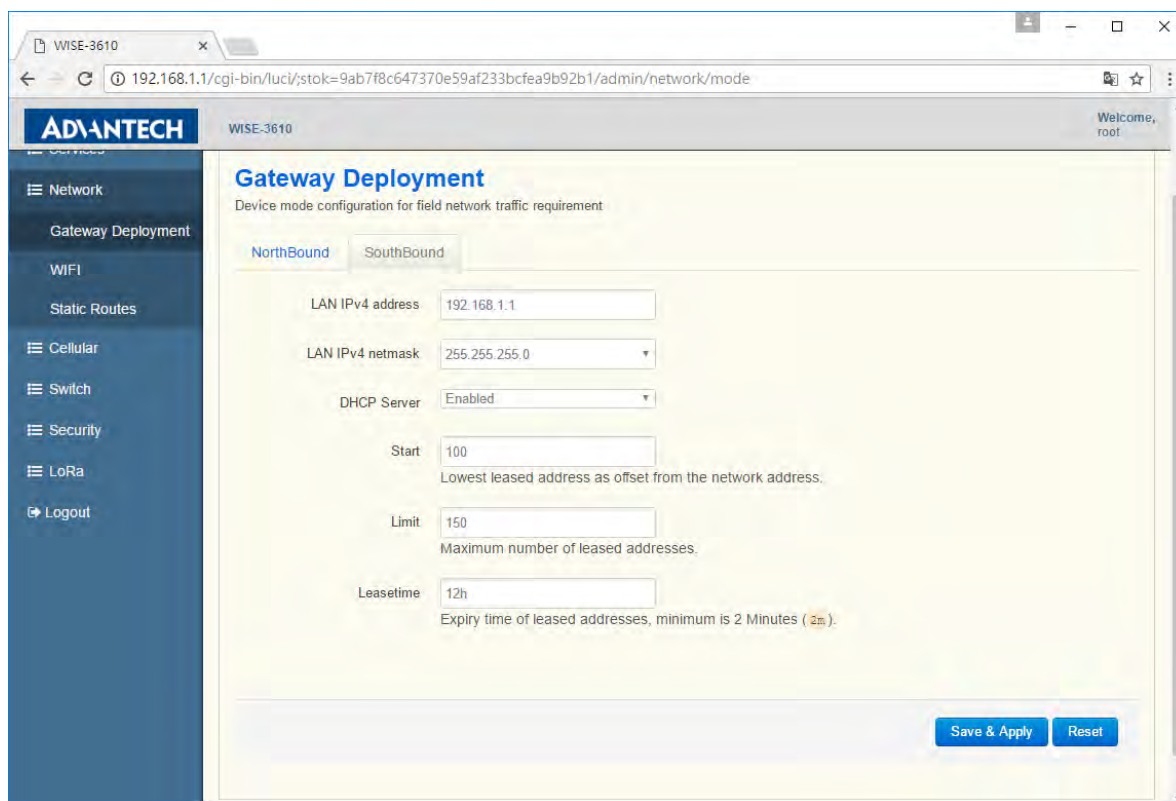

3.4 Gateway Deployment (WWAN)

3.4.1 NorthBound

Visit *Network* → *Gateway Deployment*. When NorthBound is configured to WWAN (Cellular), the 3G module is responsible for 3G network dial up using the information provided by USIM, user may not need to configure any items regarding to NorthBound.

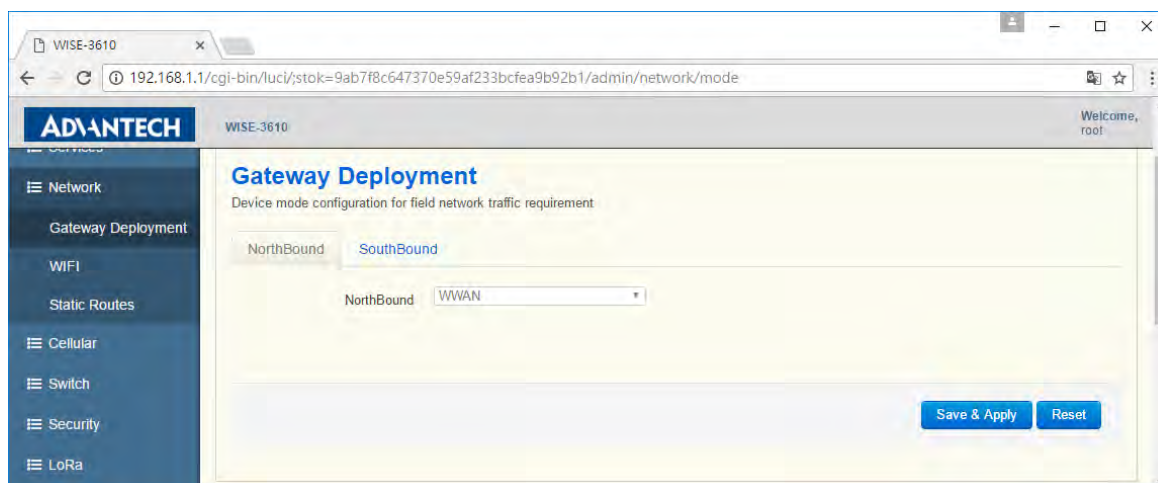

3.4.2 SouthBound

The SouthBound settings are the same as WAN mode.

3.4.3 Cellular

Visit *Cellular* → *Configuration*. By default, LoRa gateway will use the information provided by USIM to dial up to Mobile network and user can keep the default setting.

3.4.4 Enable

The ON/OFF switch for 3G module dial up function.

3.4.5 SIM

There are 3 kinds of chooses for SIM item. The **Auto** means LoRa gateway will automatically switch between two USIM cards according to dial up status. That means when the 3G link with operator #1 is down, LoRa gateway will switch to operator #2. The **Primary** and **Secondary** mean LoRa gateway will only use first or secondary USIM to dial up, respectively.

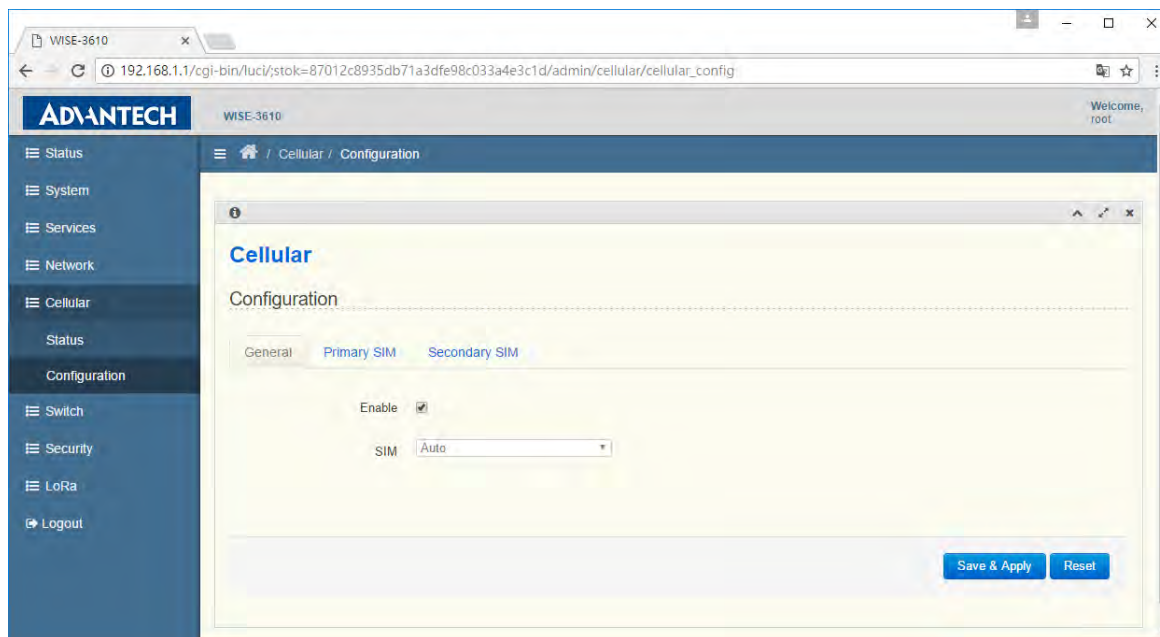

3.4.6 Cellular Status

When LoRa gateway boots up, it will automatically connect to Mobile network using the information provided by USIM, and user can visit **Cellular** → **Status** to check link status.

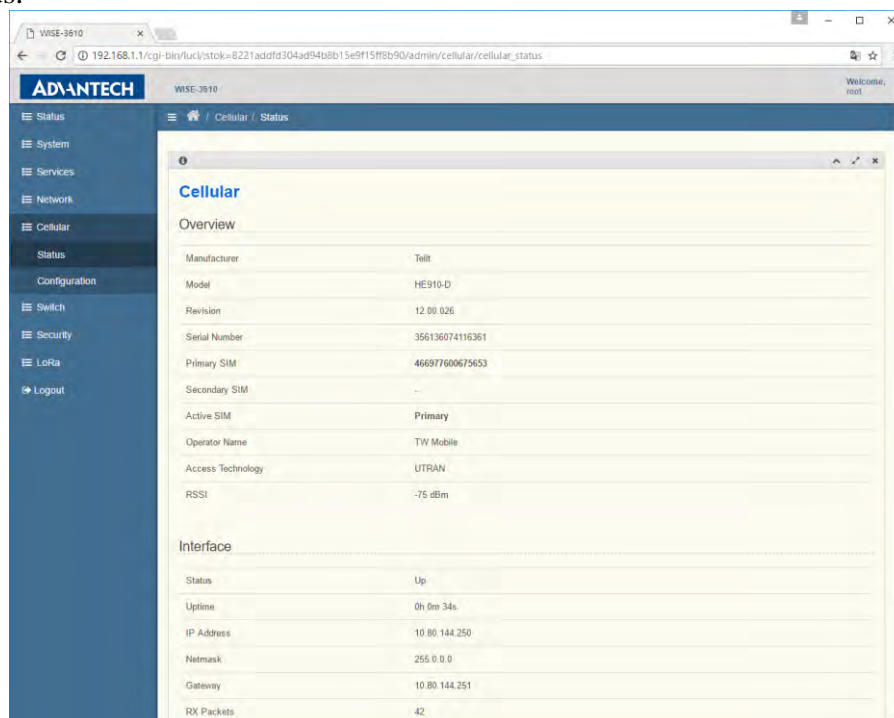

3.5 Gateway Deployment (2.4GHz WIFI)

3.5.1 NorthBound

Visit *Netowk* → *Gateway Deployment*. When NorthBound is configured to 2.4GHz WIFI, LoRa gateway will use 2.4GHz WIFI station to connect to uplink AP, and become a bridge AP. So, the clients on LAN port or 2.4GHz WIFI AP or 5GHz WIFI AP will get IP from uplink AP router via DHCP protocol.

3.5.2 Scan 2.4GHz AP Button

This button is used to scan 2.4GHz frequency and then LoRa gateway can connect to uplink AP router.

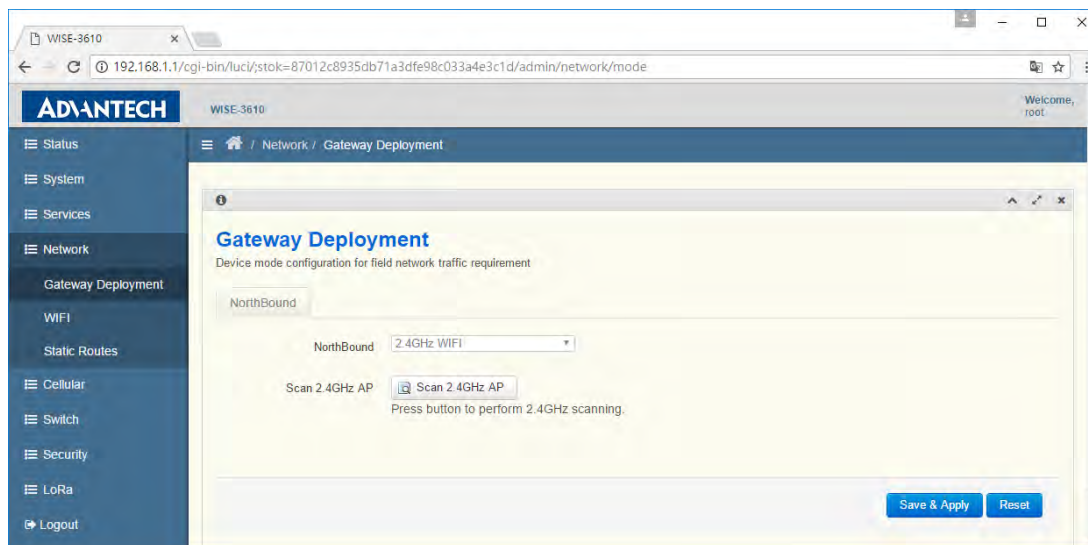

3.5.3 Join Network Button

After scanning, user can choose the specific uplink AP router and connect to it by pressing Join Network button.

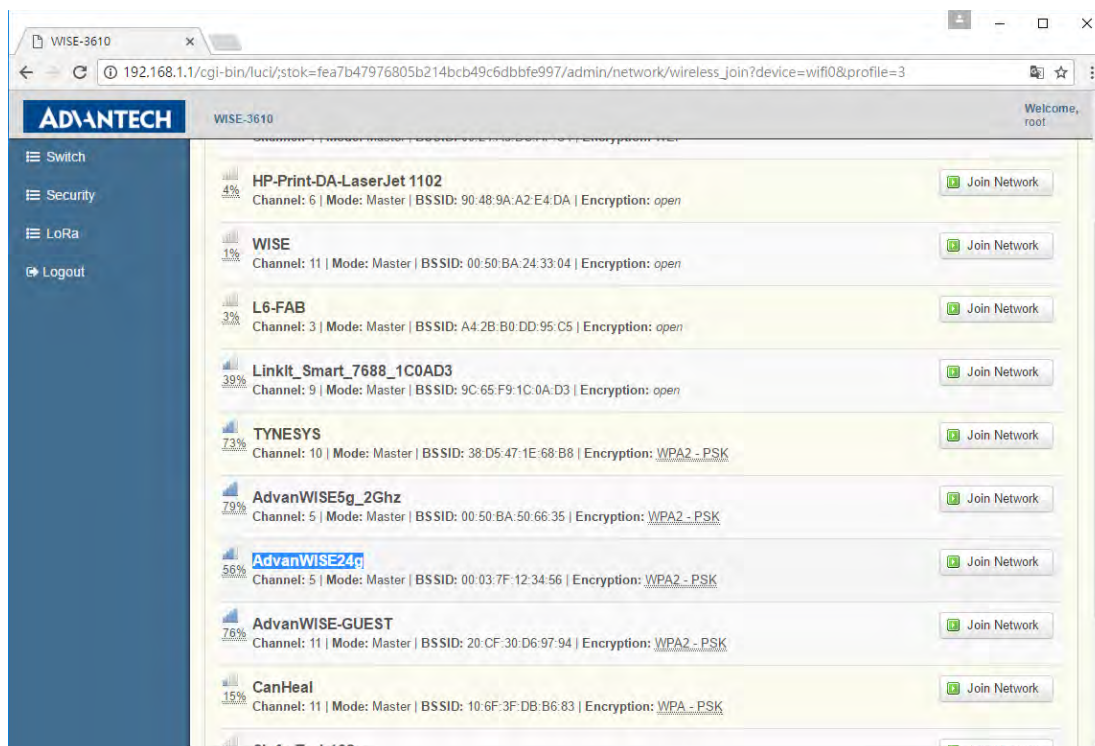

3.5.4 WPA passphrase

If uplink AP router has enabled security, user may need to input passphrase to connect to it correctly.

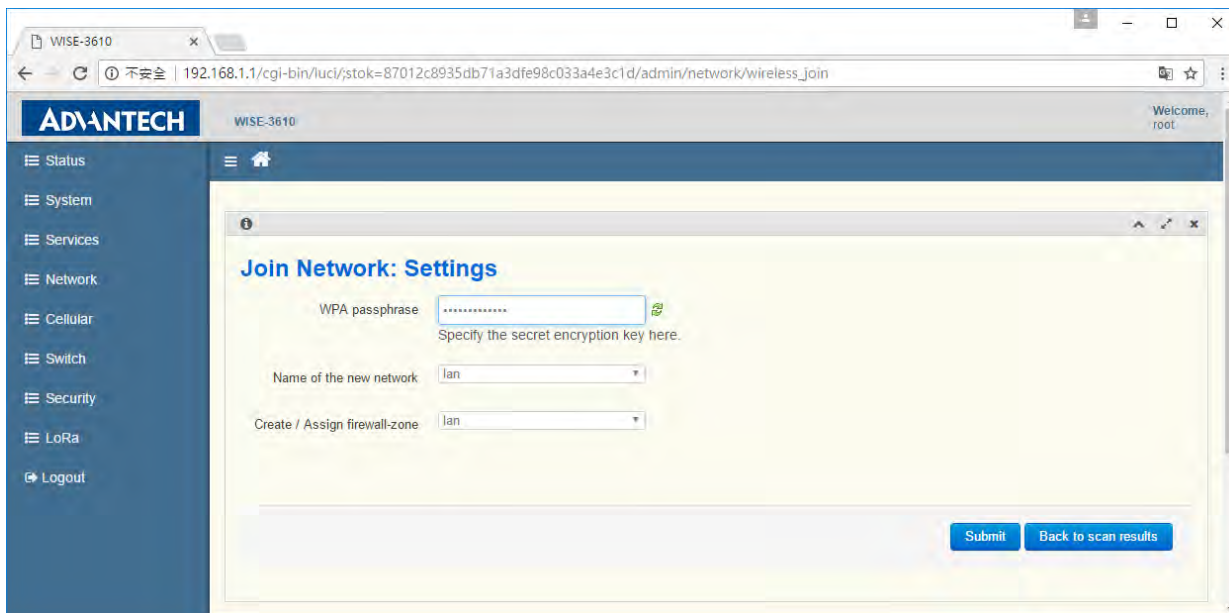

As pressing Submit button, LoRa gateway will reboot automatically to take configuration effect. When LoRa gateway boots up, it will get IP address from uplink AP router and LAN/WLAN side clients also need to get IP from uplink AP router in this mode.



3.6 Gateway Deployment (5GHz WIFI)

When NorthBound is configured to 5GHz WIFI, it uses 5G WIFI station to connect to uplink 5G AP, and it also enables 2.4G and 5G WIFI AP simultaneously. In this mode, 5G WIFI STA, 5G WIFI AP, 2.4G WIFI AP, and Ethernet LAN are bridged together, and device become an AP bridge. It uses DHCP client to get IP from uplink WIFI AP router. To connect to uplink AP, user should press “Scan 5GHz AP” button, and follow the wizard procedure. The configuration steps are like 2.4GHz WIFI steps, and user can refer 2.4GHz WIFI steps.

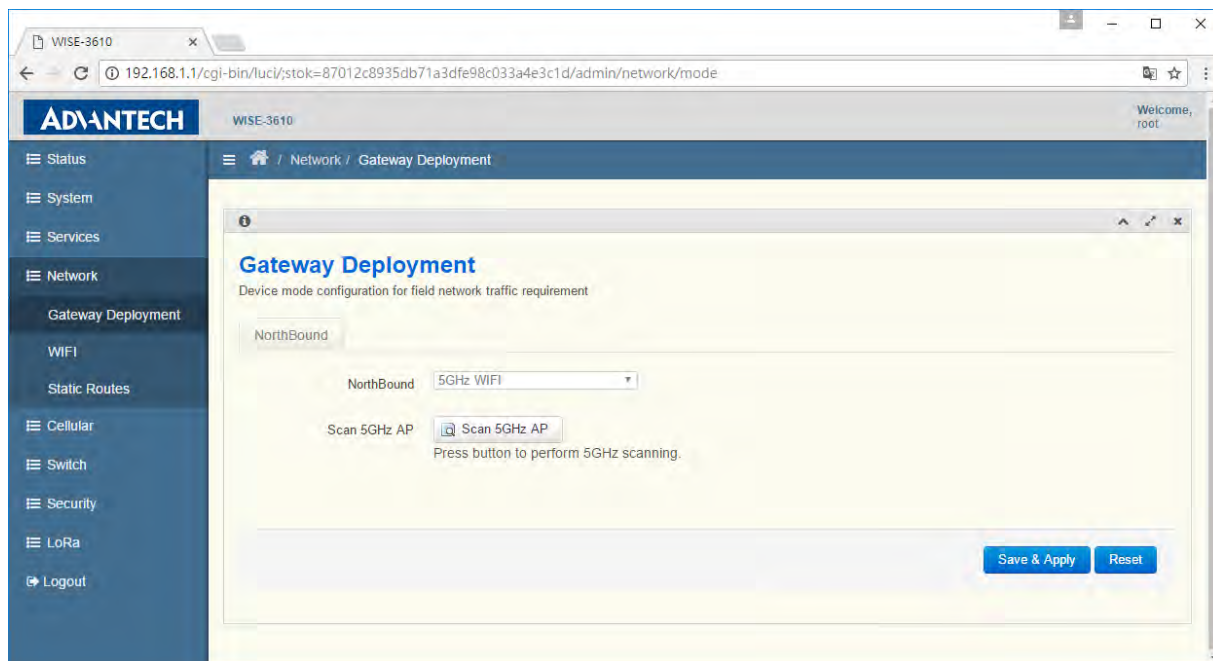

3.7 System

Visit *System* → *System* to manage hostname and time setting of LoRa gateway.

3.7.1 Local Time

It will display the time status of LoRa gateway.

3.7.2 Hostname

Hostname of this LoRa gateway.

3.7.3 Timezone

Timezone setting for LoRa gateway.

3.7.4 Enable NTP client

To enable/disable SNTP client function.

3.7.5 NTP server candidates

LoRa gateway will perform time synchronization with SNTP server configured here.

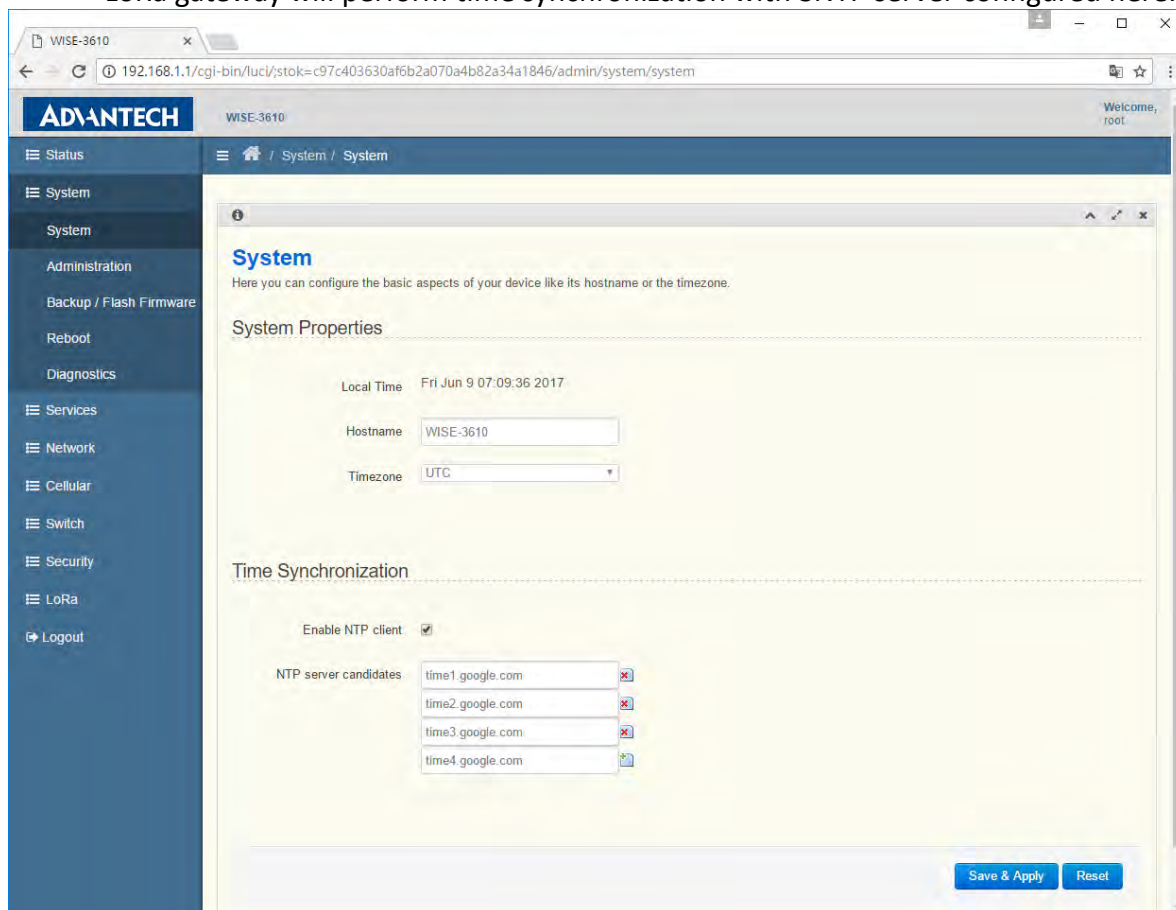

3.8 Administration

Visit *System* → *Administration* to change the password of LoRa gateway.

3.8.1 Old Password

Input the original password to pass the authentication of changing password.

3.8.2 Password and Confirmation

Input the new password twice to double confirm the new password user want to change.

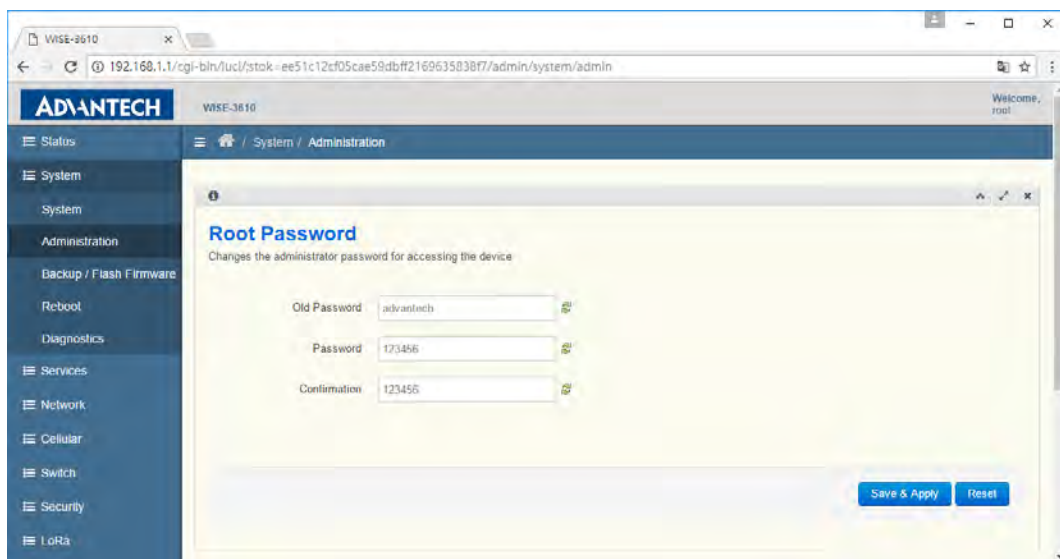

3.9 Backup / Flash Firmware

Visit *System* → *Backup / Flash Firmware* to manage LoRa gateway configuration file and perform firmware upgrade.

3.9.1 Generate archive

To backup configuration file to host PC

3.9.2 Perform reset

To perform factory reset and all LoRa gateway configuration will be reset to factory default.

3.9.3 Upload archive

To restore configuration from host PC to LoRa gateway

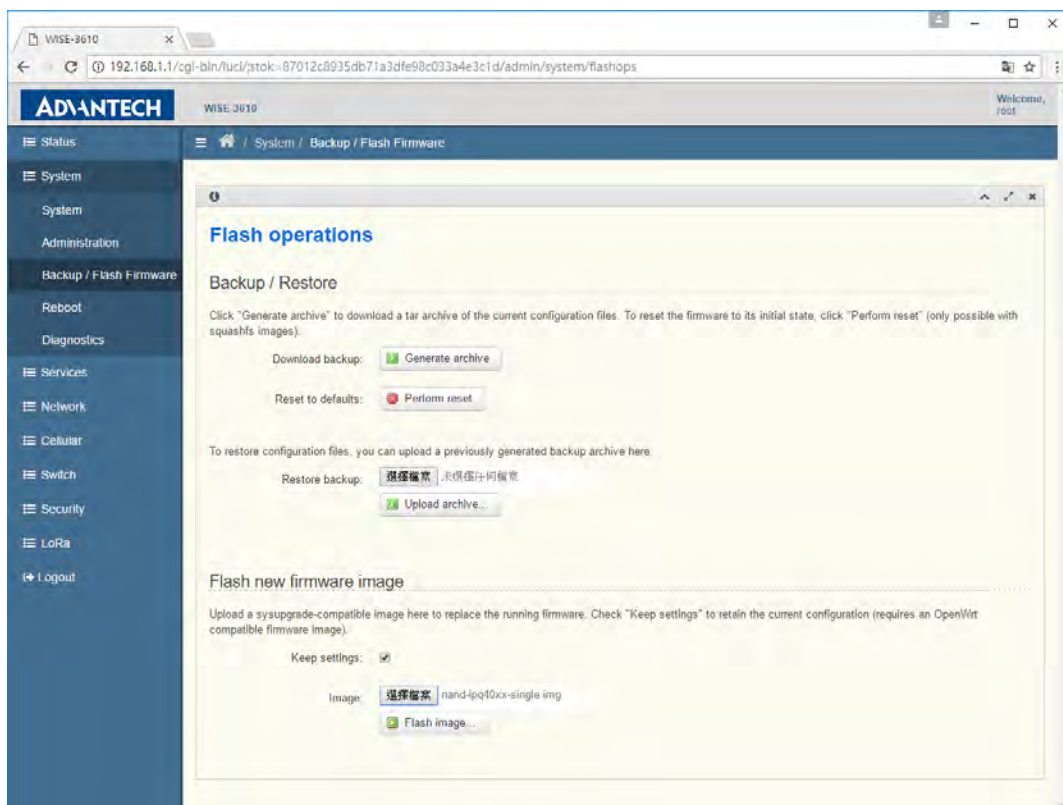

Visit *System* → *Backup / Flash Firmware* to upgrade firmware of LoRa gateway.

3.9.4 Keep settings

User can choose to only perform firmware upgrade without reset the configuration. For formal use, we suggest to not keep settings due to new function may need to load new settings.

3.9.5 Flash image

To upgrade firmware, please choose firmware and press Flash image button

3.9.6 Flash Firmware - Verify

LoRa gateway will compute the MD5CHECKSUM for checking, and ask user to Proceed or Cancel.

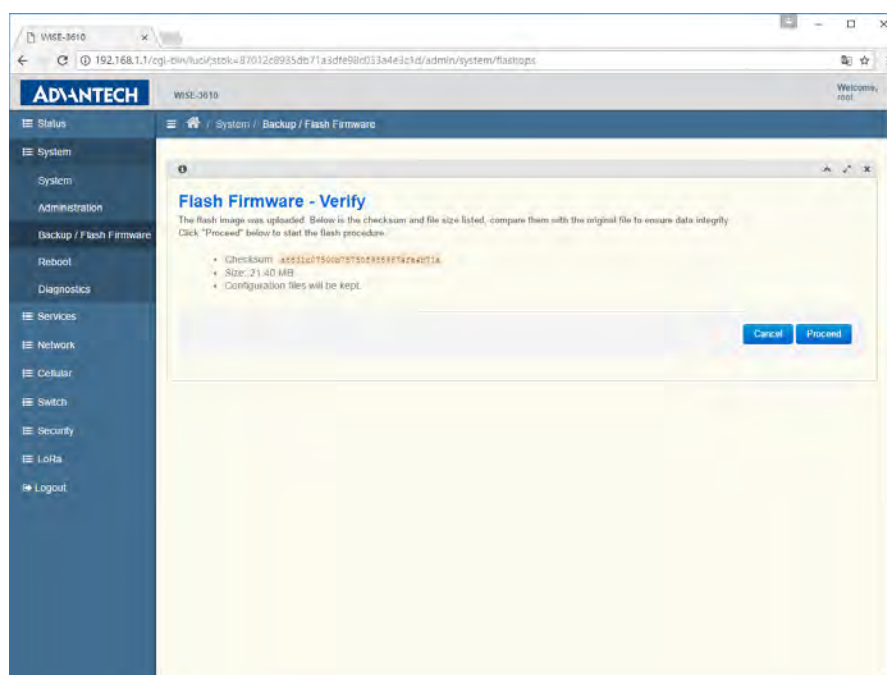

3.10 Reboot

Press ‘Perform reboot’ link to do rebooting.

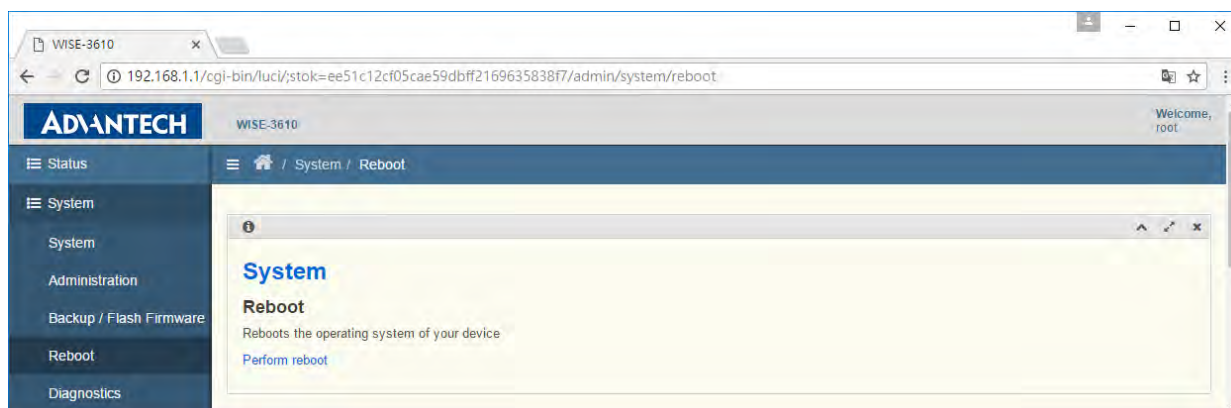

3.11 Diagnostics

Ping, Traceroute and Nslookup Diagnostics Tools.

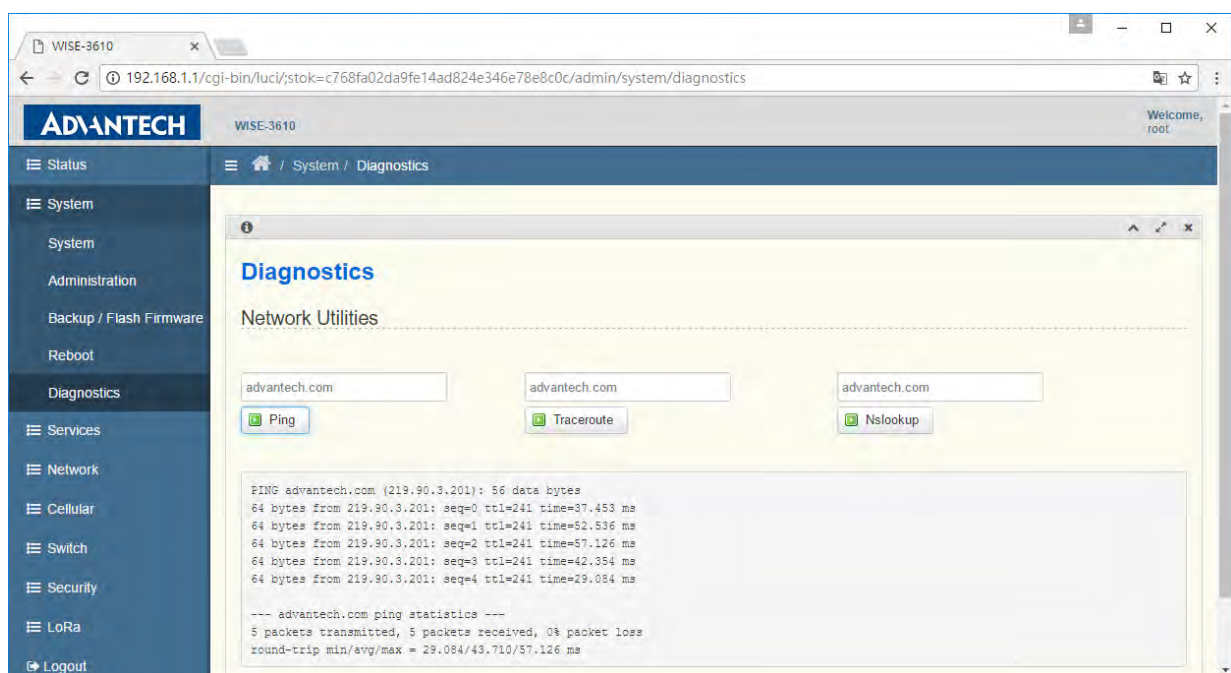

3.12 Security

3.12.1 Remote Management

Visit *Security* → *Remote Management* to open port on WAN zone interface.

3.12.1.1 HTTP / Port 80 (HTTPS / Port 443, SSH / Port 22, MQTT / Port 1883 or 8883 or 8884)

To enable/disable port access from WAN zone interface. The WAN zone interfaces include Ethernet WAN and 3G module. After enabling the port on WAN zone interface, external host can access related services running of LoRa gateway.

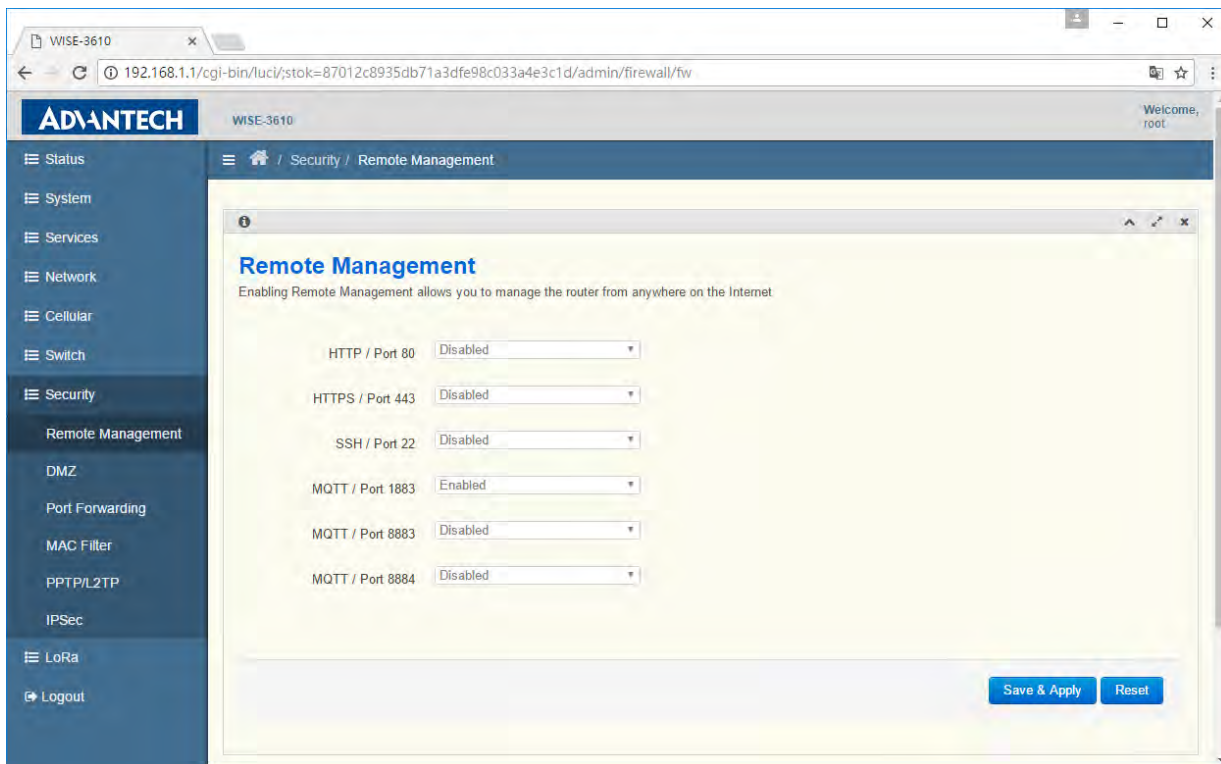

3.13 DMZ

Visit *Security* → *DMZ* to enable/disable DMZ function.

3.13.1 DMZ

To enable/disable DMZ function.

3.13.2 IPv4 address

When DMZ is enabled, traffic come to the port of WAN zone will be forwarded to this private host.

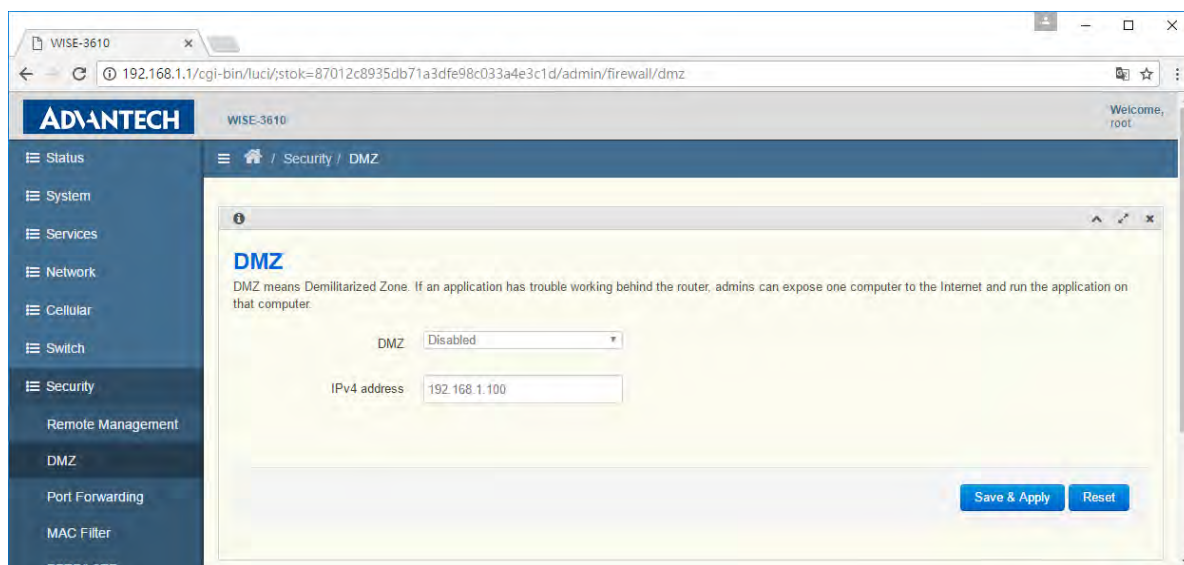

3.14 Port Forwarding

Visit *Security* → *Port Forwarding* to add/delete port forwarding rule.

3.14.1 Port Forwarding

One port forwarding rule include friendly rule name, Protocol, External Port, Internal IP address and Internal Port fields. The function of port forwarding is when traffic with configured protocol and port come to external port, LoRa gateway will forward traffic to internal IP and internal port. Port Forwarding and DMZ functions are similar. If user add a port forwarding rule to forward HTTP packets to private host PC, and then Remote Management host PC cannot surf Webpage of LoRa gateway.

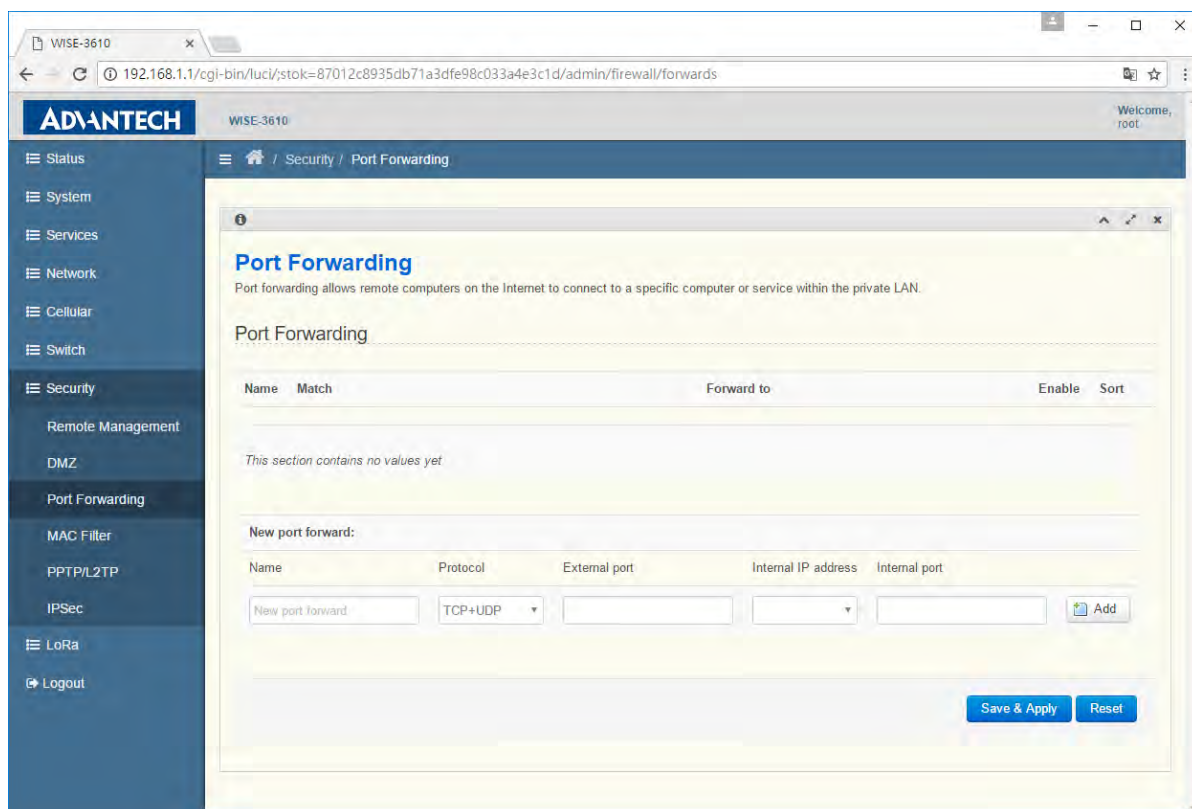

3.15 MAC Filter

Visit *Security* → *MAC filter* to add/delete MAC filter rule.

3.15.1 MAC Filter

One MAC filter rule includes friendly rule name and MAC address. The function of MAC filter is to drop packet with configured source MAC address.

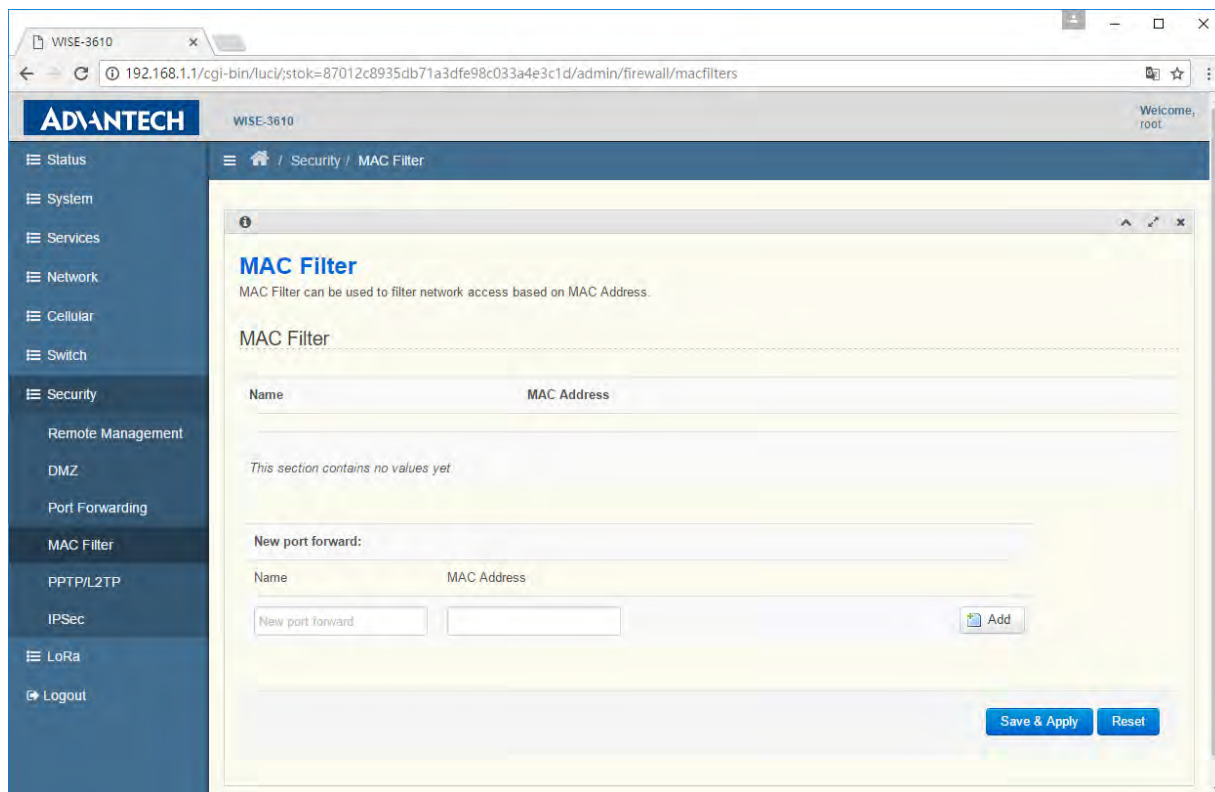

3.16 PPTP/L2TP

Visit *Security* → *PPTP/L2TP* to enable/disable PPTP/L2TP function.

3.16.1 Disabled

By default PPTP/L2TP are disabled. To enable PPTP/L2TP function, user need to uncheck this item.

3.16.2 Protocol

User can choose PPTP or L2TP according to requirement.

3.16.3 Server IP

The PPTP/L2TP server that LoRa gateway purpose to connect.

3.16.4 PAP/CHAP username and PAP/CHAP password

The account to login to PPTP/L2TP server.

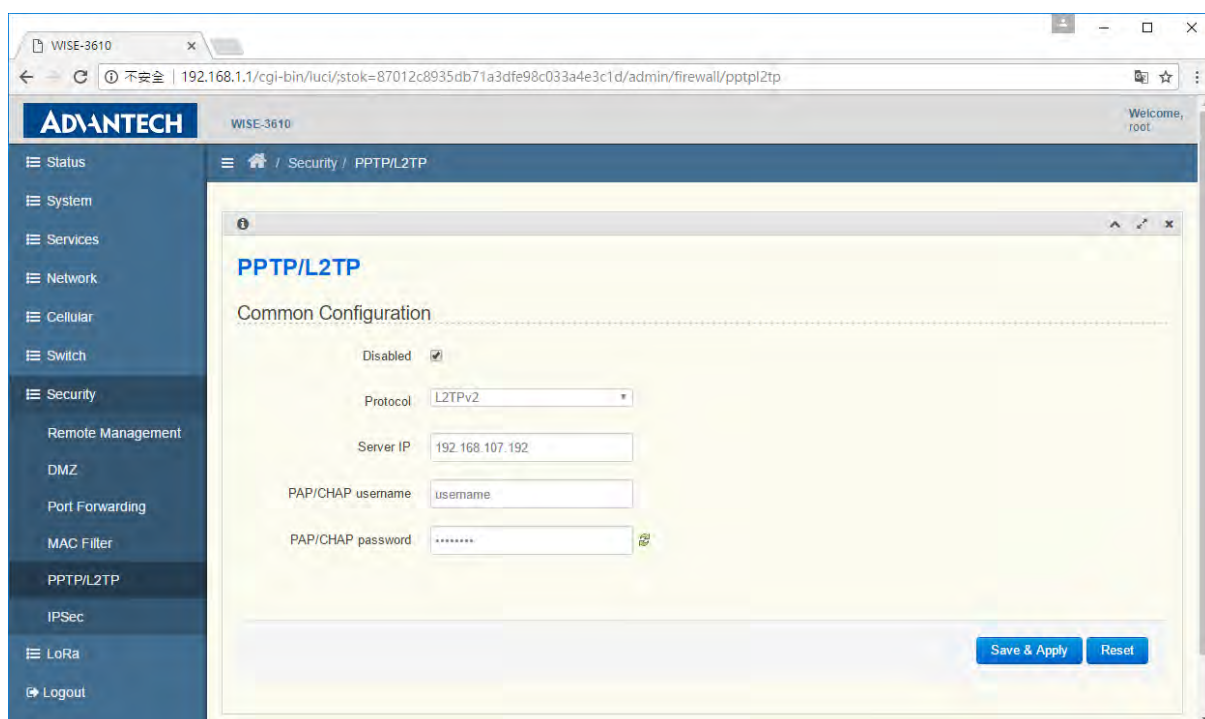

3.17 IPSec

Visit *Security* → *IPSec* to configure IPSec tunnel settings.

3.17.1 NAT Traversal

To enable/disable IPSec NAT Traversal function.

3.17.2 Add button

Introduce tunnel name and press add button to add a IPSec tunnel configuration template.

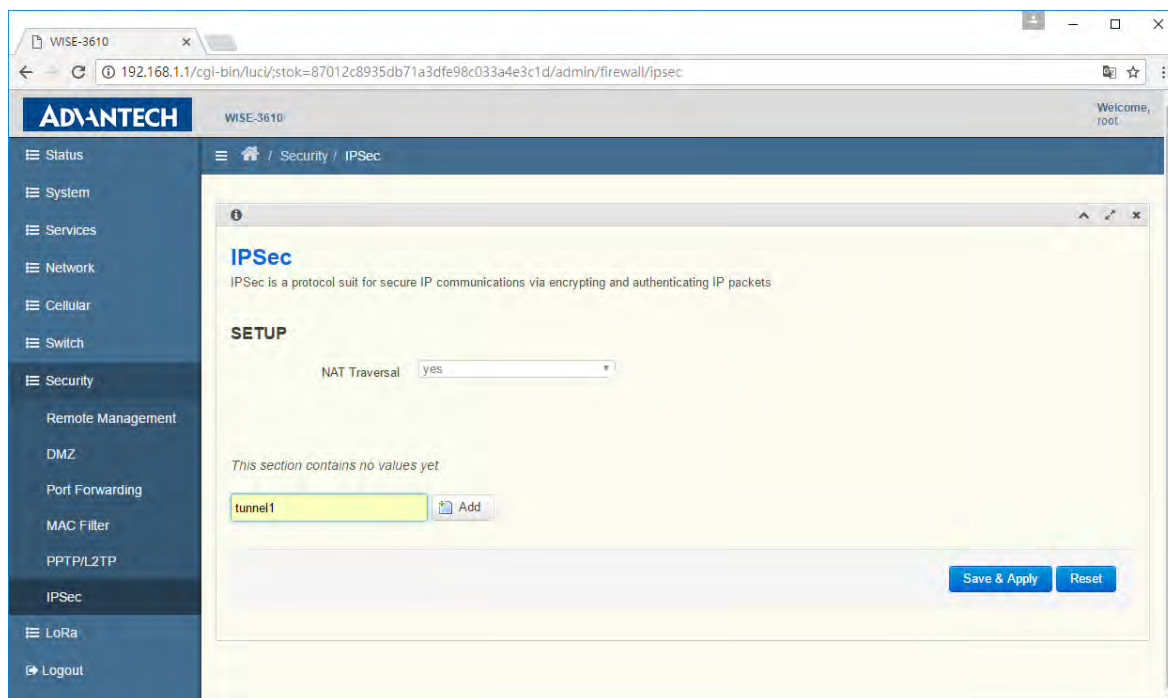

3.17.3 IKEv1/IKEv2

- (1) permit: signify no IKEv2 should be transmitted, but will be accepted if peer sites initiate with IKEv2
- (2) no: signify only use IKEv1, and no IKEv2 negotiation will be transmitted or accepted
- (3) yes: signify allow IKEv1 and IKEv2, and use IKEv2 to start the negotiate by default
- (4) insist: signify only IKEv2 is allowed, and IKEv1 will be rejected

3.17.4 Local Peer IP

The outgoing IP address of LoRa gateway. It will automatically detect if %defaultroute is configured.

3.17.5 Local Subnet

The private subnet behind the LoRa gateway, and the format is IP/mask length.

3.17.6 Local ID

The identify of LoRa gateway for IKE negotiation.

3.17.7 Remote Peer IP

The peer side IP address for IPsec tunnel.

3.17.8 Remote Subnet

The private subnet behind the peer side for IPsec tunnel.

3.17.9 Remote ID

The identify of peer side for IKE negotiation.

3.17.10 Auth By

- (1) secret: pre-shared key combined with 4.6.11
- (2) rsasig: RSA signature combined with 4.6.12~4.6.15

3.17.11 PSK Key

Pre-shared key for IPsec tunnel

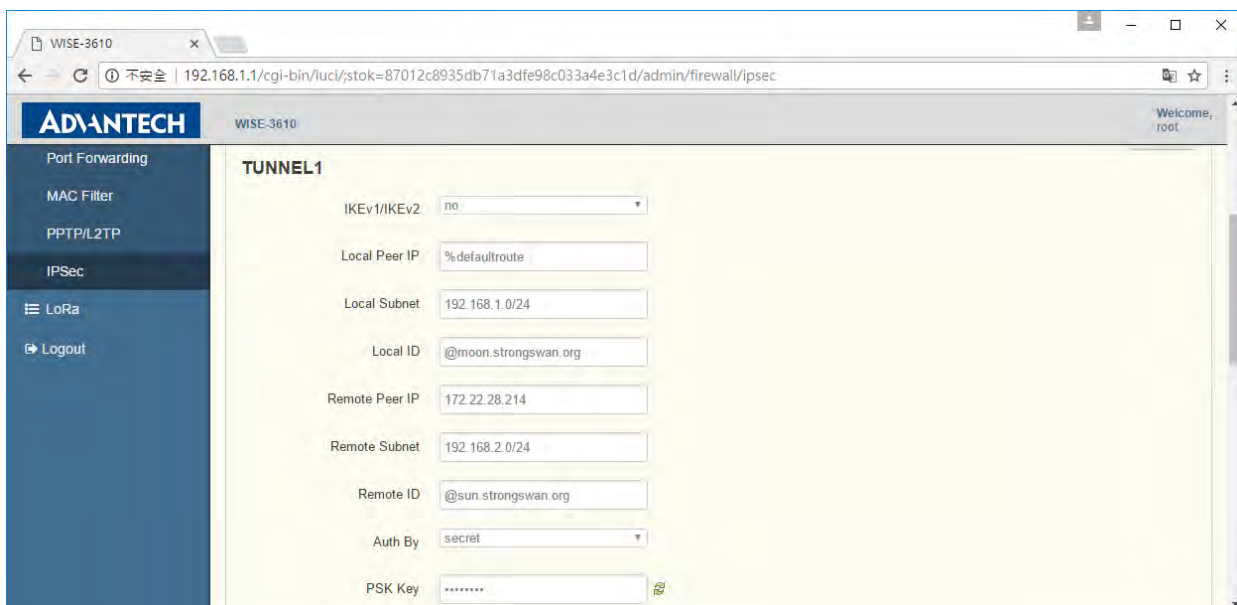

3.17.12 CA

Root CA Certificate

3.17.13 Local Certificate

The certificate of LoRa gateway for IKE negotiation.

3.17.14 Local Key

The private key of LoRa gateway for IKE negotiation.

3.17.15 Remote Certificate

The certificate of peer site for IKE negotiation.

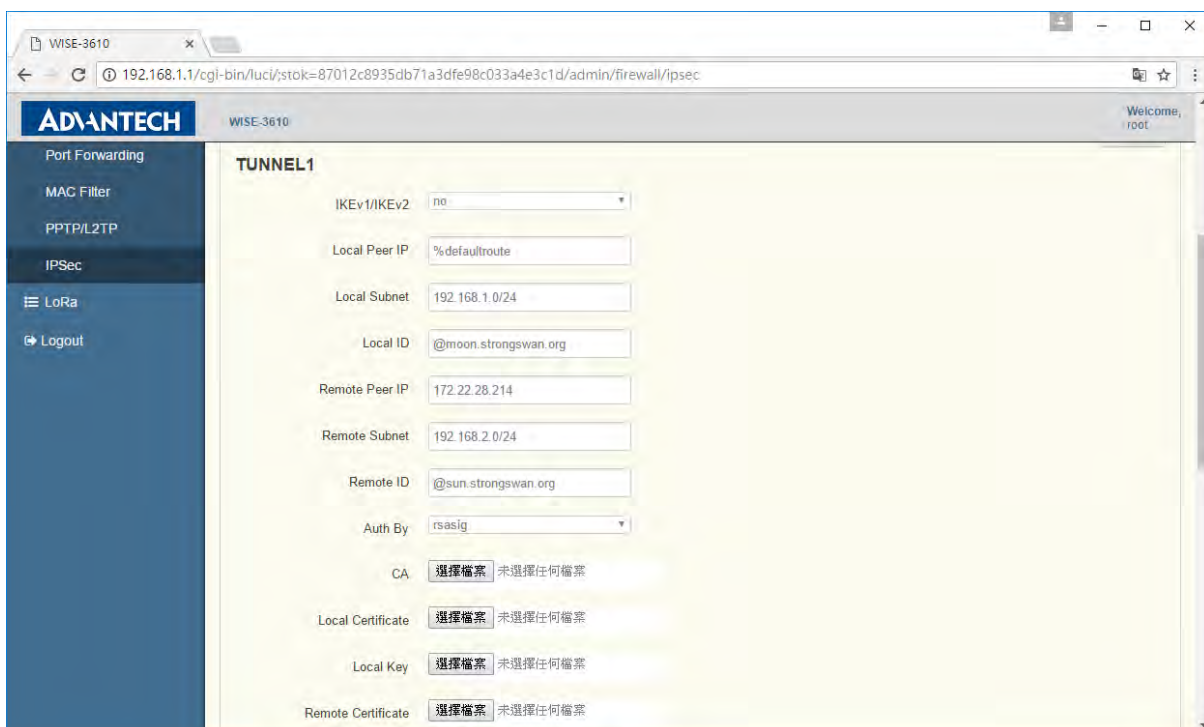

3.17.16 IKE Algorithms

The security parameters for IKE phrase 1 negotiation. It supports following

combination: 3des-md5-modp1024, 3des-md5-modp2048, 3des-sha1-modp1024,
 3des-sha1-modp2048, aes128-md5-modp1024, aes128-md5-modp2048,
 aes128-sha1-modp1024, aes128-sha1-modp2048, aes256-sha1-dh22, aes256-sha1-dh23,
 aes256-sha1-dh24.

3.17.17 IKE Lifetime

The lifetime of IKE phrase 1 negotiation. Before it is timeout, the IKE phrase 1 will be re-negotiated.

3.17.18 ESP Algorithm

The security parameters for IKE phrase 2 negotiation. It supports following
 combination: 3des-md5-modp1024, 3des-md5-modp2048, 3des-sha1-modp1024,
 3des-sha1-modp2048, aes128-md5-modp1024, aes128-md5-modp2048,
 aes128-sha1-modp1024, aes128-sha1-modp2048, aes256-sha1-dh22, aes256-sha1-dh23,
 aes256-sha1-dh24.

3.17.19 Perfect Forward Secret

Perfect Forward Secret security feature for IKE negotiation.

3.17.20 SA Lifetime

The lifetime of IKE phrase 2 negotiation. Before it is timeout, the IKE phrase 2 will be re-negotiated.

3.17.21 DPD Delay

The delay in seconds between Dead Peer Detection keepalives (R_U_THERE, R_U_THERE_ACK).

3.17.22 DPD Timeout

The length of time in seconds that there are no DPD keepalives and no traffic. After this time period, DPD action will be performed.

3.17.23 DPD Action

- (1) hold: keep the security parameters in LoRa gateway
- (2) clear: clear the security parameters in LoRa gateway
- (3) restart: immediately to re-negotiate the security parameters

3.17.24 XAuth

- (1) no: disable XAuth authentication option
- (2) yes: enable XAuth authentication option

3.17.25 Username

The username for XAuth

3.17.26 Password

The password for XAuth

3.17.27 Operation

- (1) start: the IKE will be initiated for this tunnel when LoRa gateway is bootup
- (2) ignore: the IKE will not be initiated for this tunnel when LoRa gateway is bootup

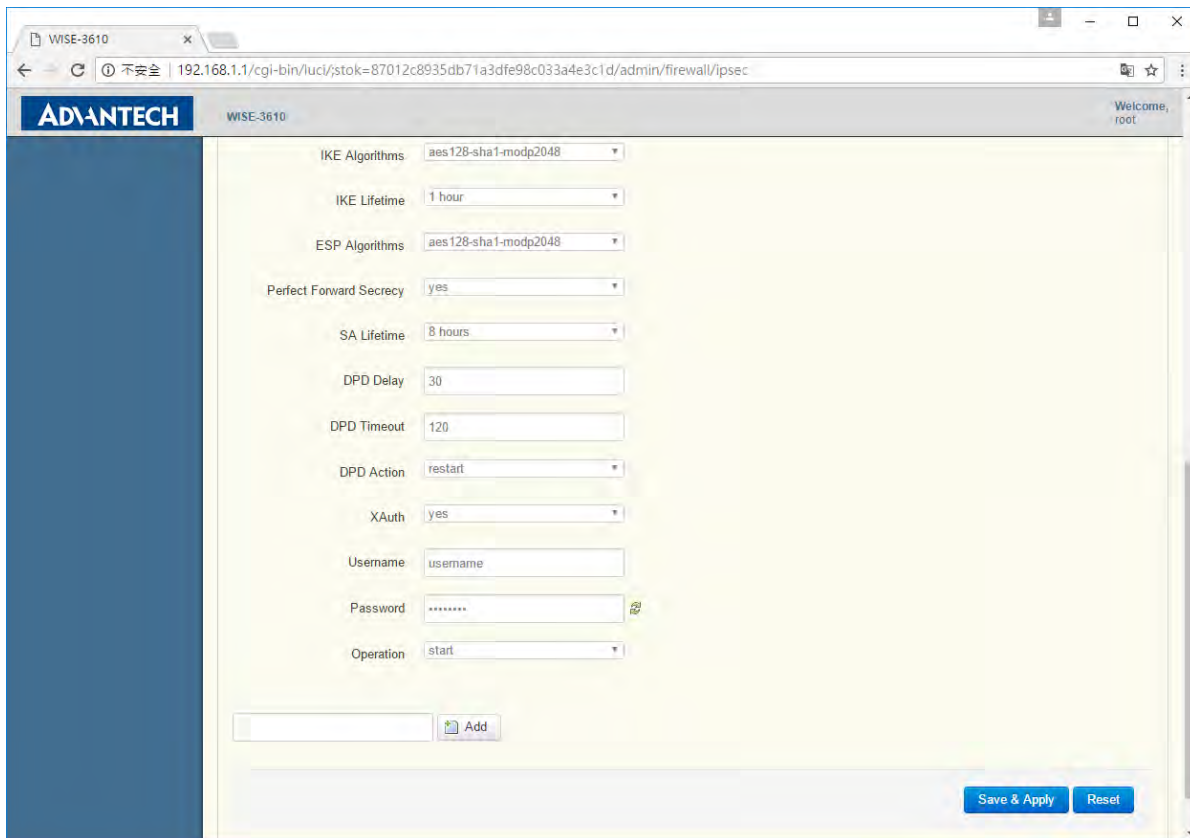

Services

3.18 Dynamic DNS

3.18.1 Enable

To enable/disable DDNS function.

3.18.2 Service

To choose the DDNS provider profile.

3.18.3 Hostname

The hostname is used to registered to DDNS provider for domain name query.

3.18.4 Username

The username is used to registered to DDNS provider.

3.18.5 Password

The password is used to registered to DDNS provider.

3.18.6 Source of IP address

The source IP address used to register to DDNS provider.

- (1) network: choose IP on specific network
- (2) URL: detect the current local IP from specified website. If LoRa gateway is behind a NAT, input the WEB URL that can report the external IP address of NAT router

3.18.7 Network

User can choose IP on wan, lan or cellular interface

3.18.8 URL

The correct URL might depend on the DDNS provider being used, the sample format should be <http://checkip.dyndns.org>

3.18.9 Check for changed IP every and Check-time unit

The unit of time to check if IP address is changed in LoRa gateway.

3.18.10 Force update every and Force-time unit

The unit of time, LoRa gateway try to update the registered information.

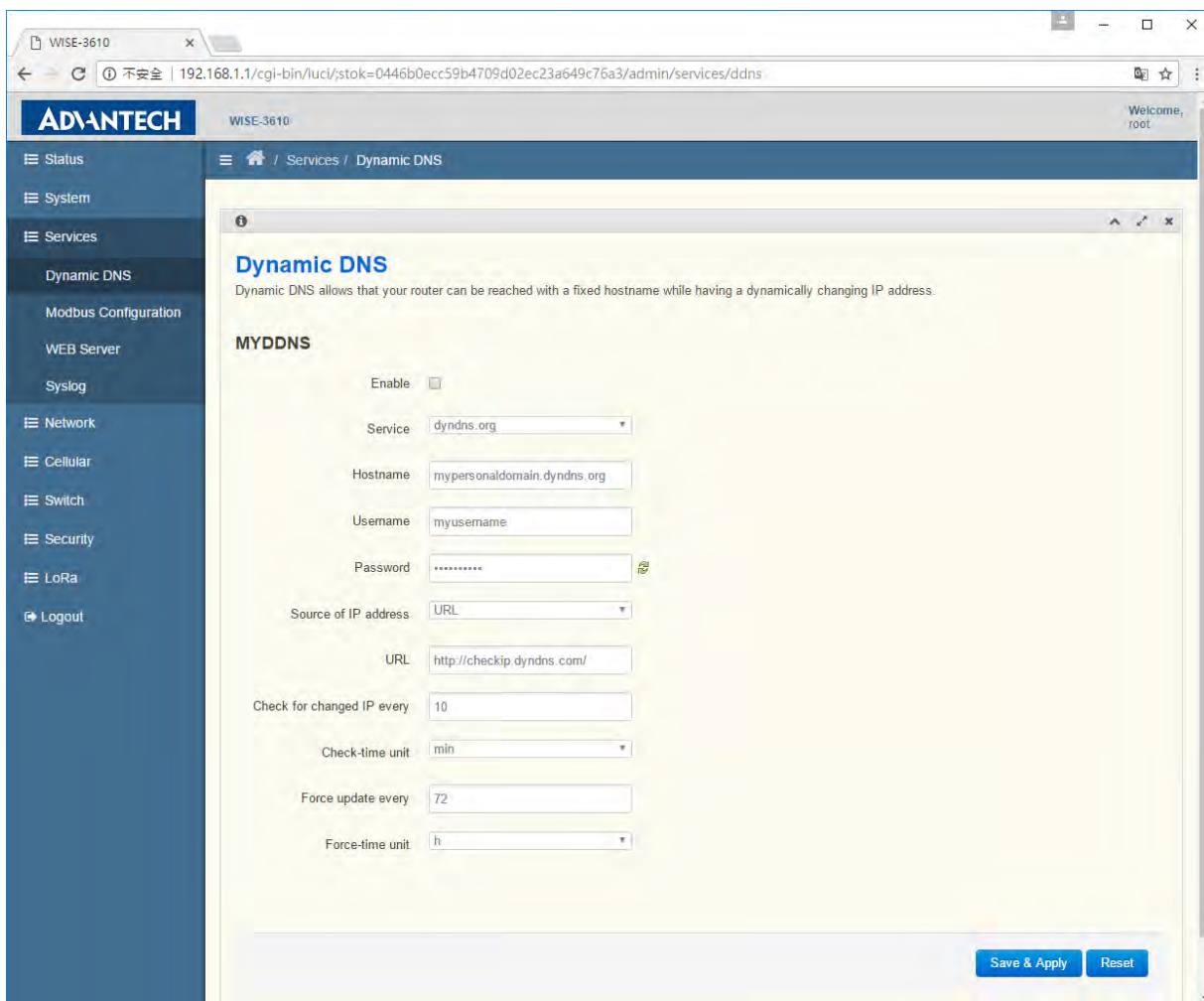

3.19 Modbus Configuration

3.19.1 Modbus Gateway

To enable/disable Modbus TCP to Modbus serial RTU function.

3.19.2 Interface

There are 3 kinds of modes LoRa gateway supported. The configuration of hardware and software must be matched to work properly.

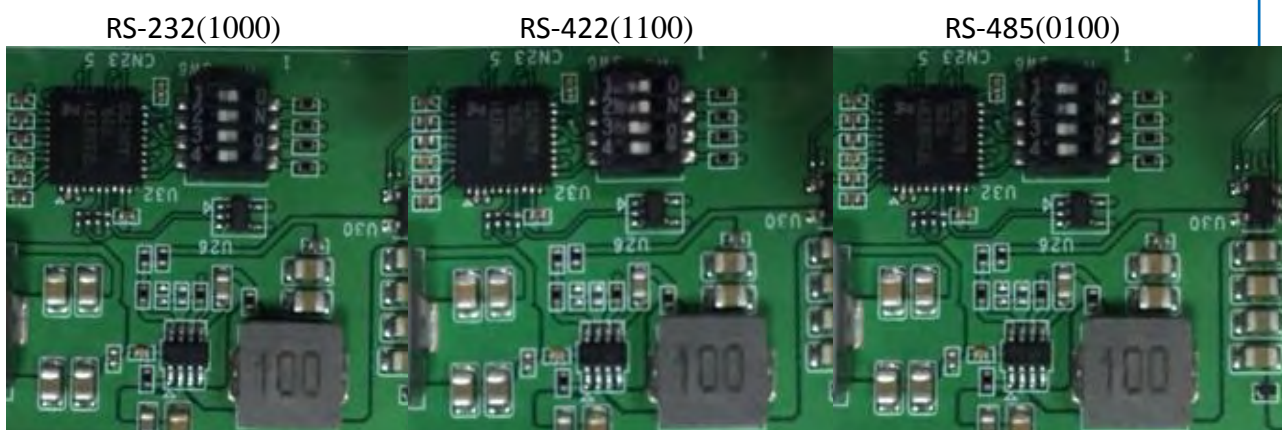

3.19.3 Baud Rate

LoRa gateway support following baud rate to communicate with RTU device: 9600, 12000, 14400, 19200, 38400, 57600, 115200.

3.19.4 Data Bits/Parity/Stop Bits

LoRa gateway support following data bits/parity/stop bits combinations: 8N1, 8O1, 8E1, 8N2, 8O2, 8E2.

3.19.5 TCP Port

The TCP Port that Modbus gateway running on LoRa gateway.

3.19.6 MAX TCP Connections

The maximum TCP connections allowed to connect to Modbus gateway.

3.19.7 Frame Break (ms)

The pause in milliseconds between requests.

3.19.8 Slave Timeout (ms)

The response wait time in milliseconds.

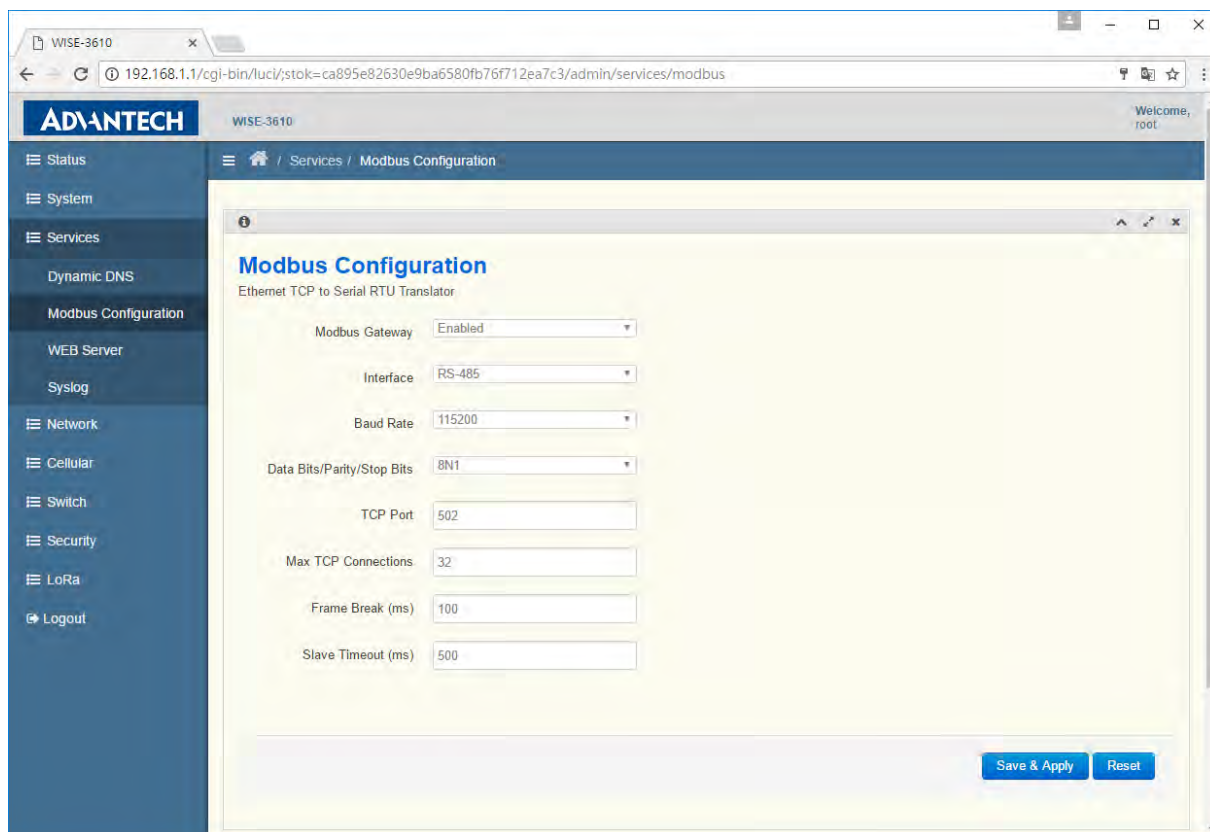

3.20 WEB Server

3.20.1 HTTPS Certificate

The https certificate for Web server. After delete, user can upload certificate prepared.

3.20.2 HTTPS Private Key

The https private key for Web server. After delete, user can upload private key prepared.

3.20.3 Remove old certificate and key

This button can remove certificate and key, and LoRa gateway will automatically generate certificate and key as bootup.

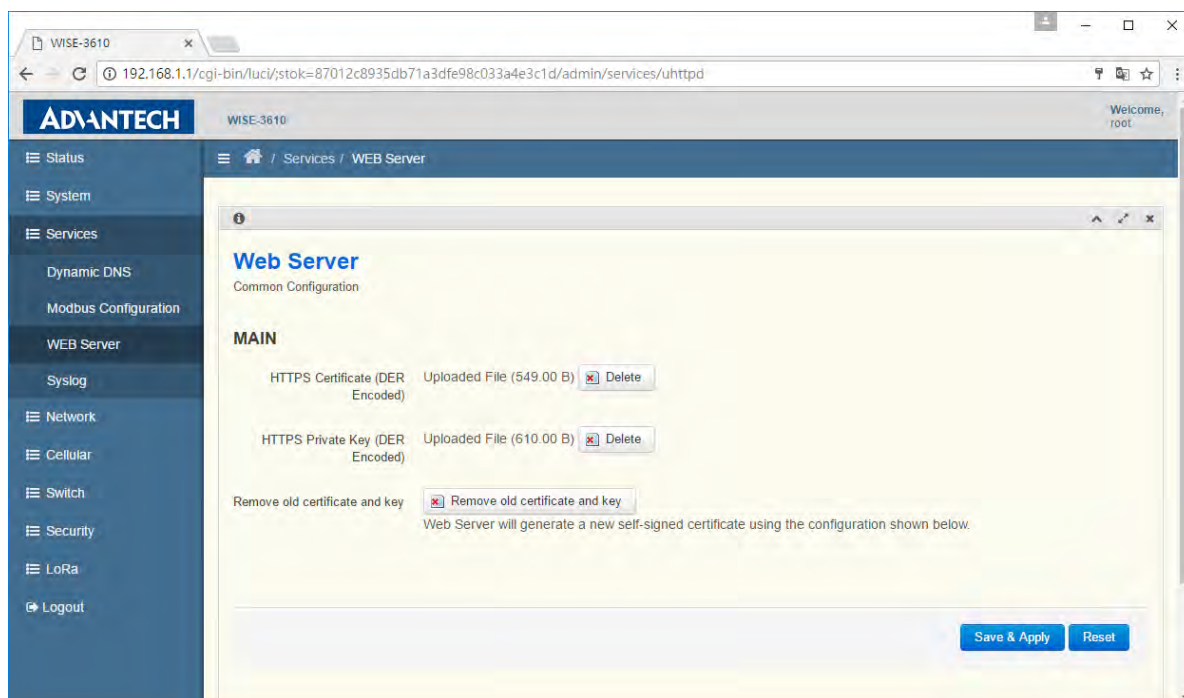

3.21 Syslog

3.21.1 Enable

To enable/disable syslog sent to remote host PC.

3.21.2 Host

The IP address of remote host PC that run syslog server.

3.21.3 Port Number

The Port Number of remote host PC that run syslog server.

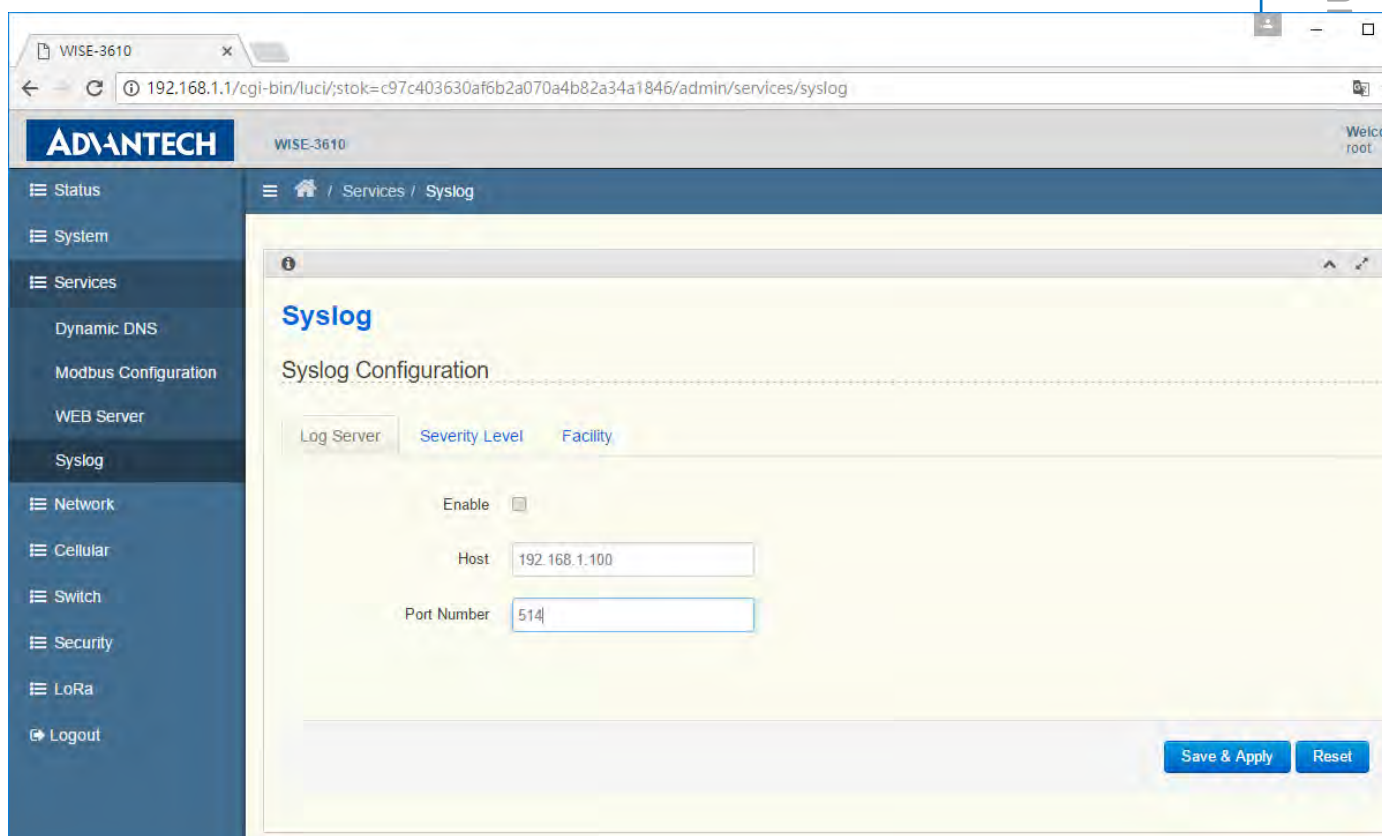

Network

3.22 WIFI Status

Visit *Network* → *WIFI* to check WIFI function status.

3.22.1 Wireless Overview

It will show 2.4Ghz WIFI SSID and then 5Ghz WIFI SSID. The **Edit** button can get into detail WIFI setting page.

3.22.2 Associated Stations

It will display the associated WIFI stations including 2.4Ghz and 5Ghz WIFI stations.

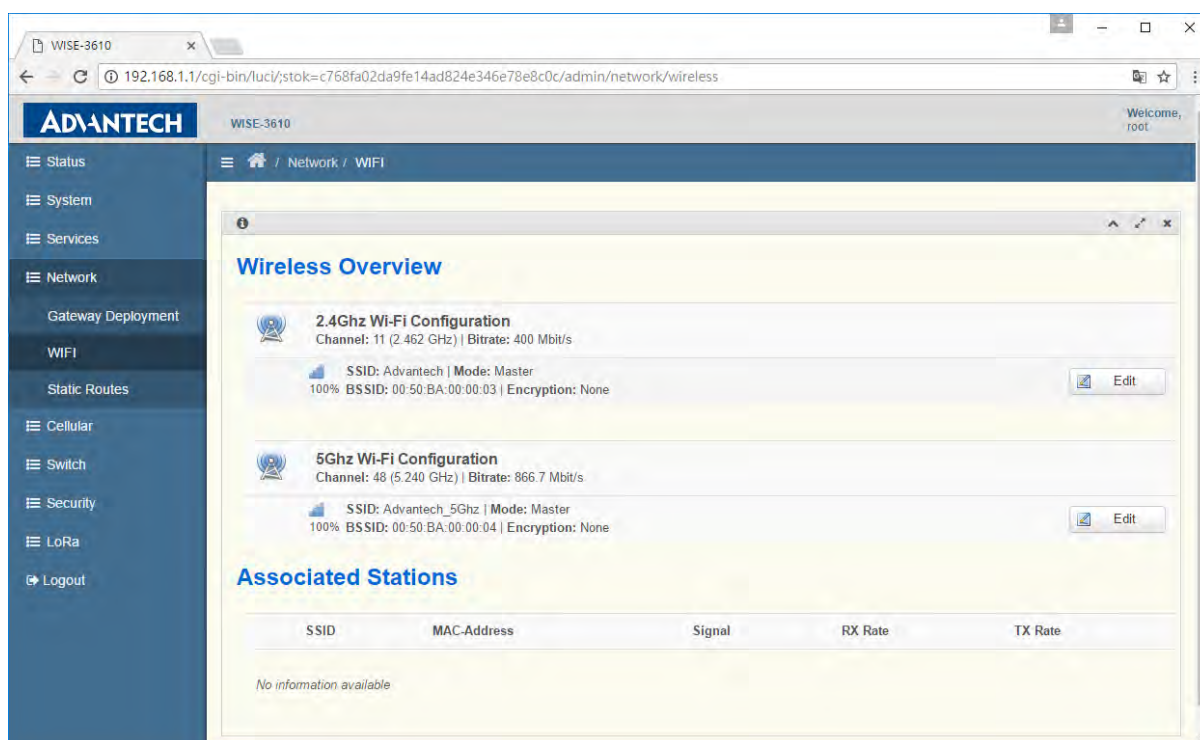

3.23 WIFI Configuration

Visit *Network* → *WIFI* → *Edit BUTTON* to check or modify general WIFI function.

3.23.1 Wireless network is enabled

To enable/disable the WIFI SSID instance.

3.23.2 Channel

User can choose the desired channel or leave it auto to automatically selection.

3.23.3 Transmit Power

The maximum power is 20dbm mapped to 100%, and user can lower down the transmission power.

3.23.4 ESSID

The SSID for this wireless interface.

3.23.5 Mode

User can configure this SSID to be AP, Client or WDS-AP, WDS-Client.

3.23.6 Hide ESSID

User can choose to hide SSID explored by clients.

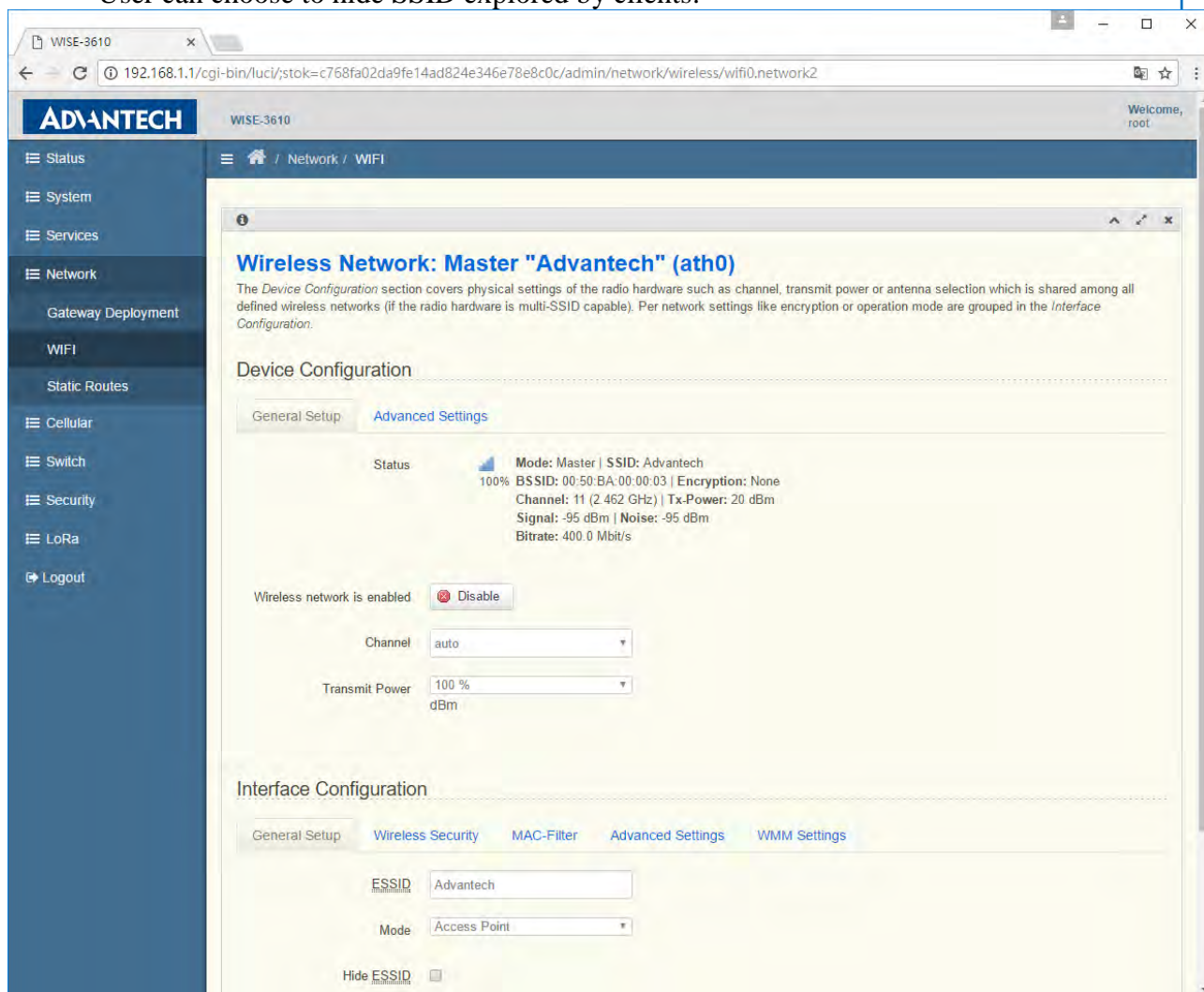

Visit *Network* → *WIFI* → *Edit BUTTON* → *Device Configuration* → *Advanced Settings*

TAB to check or modify advance settings of device level.

3.23.7 Mode

The operating mode for WIFI interface. It supports auto, 802.11b, 802.11g, 802.11g+n for 2.4Ghz band and auto, 802.11a, 802.11a+n and 802.11ac for 5GHz band.

3.23.8 HT Mode

The channel bandwidth for WIFI device. It supports 20MHz, 40MHz 2nd channel below, 40MHz 2nd channel above, and 40MHz channel for 2.4Ghz band and 20MHz, 40MHz 2nd channel below, 40MHz 2nd channel above, 40MHz channel and 80MHz channel for 5GHz band.

3.23.9 Inter SSID Isolation

WIFI station to station communication between different SSID.

3.23.10 Force 40MHz mode

Force to use 40MHz channel bandwidth. To enable it will be not compatible with IEEE 802.11n-2009, and 20MHz client cannot associate to device.

3.23.11 ANI Enable

To enable/disable hardware level automatically noise immunity.

3.23.12 Dynamic Tx Chain Enable

To enable/disable chip vendor version of efficient transmission.

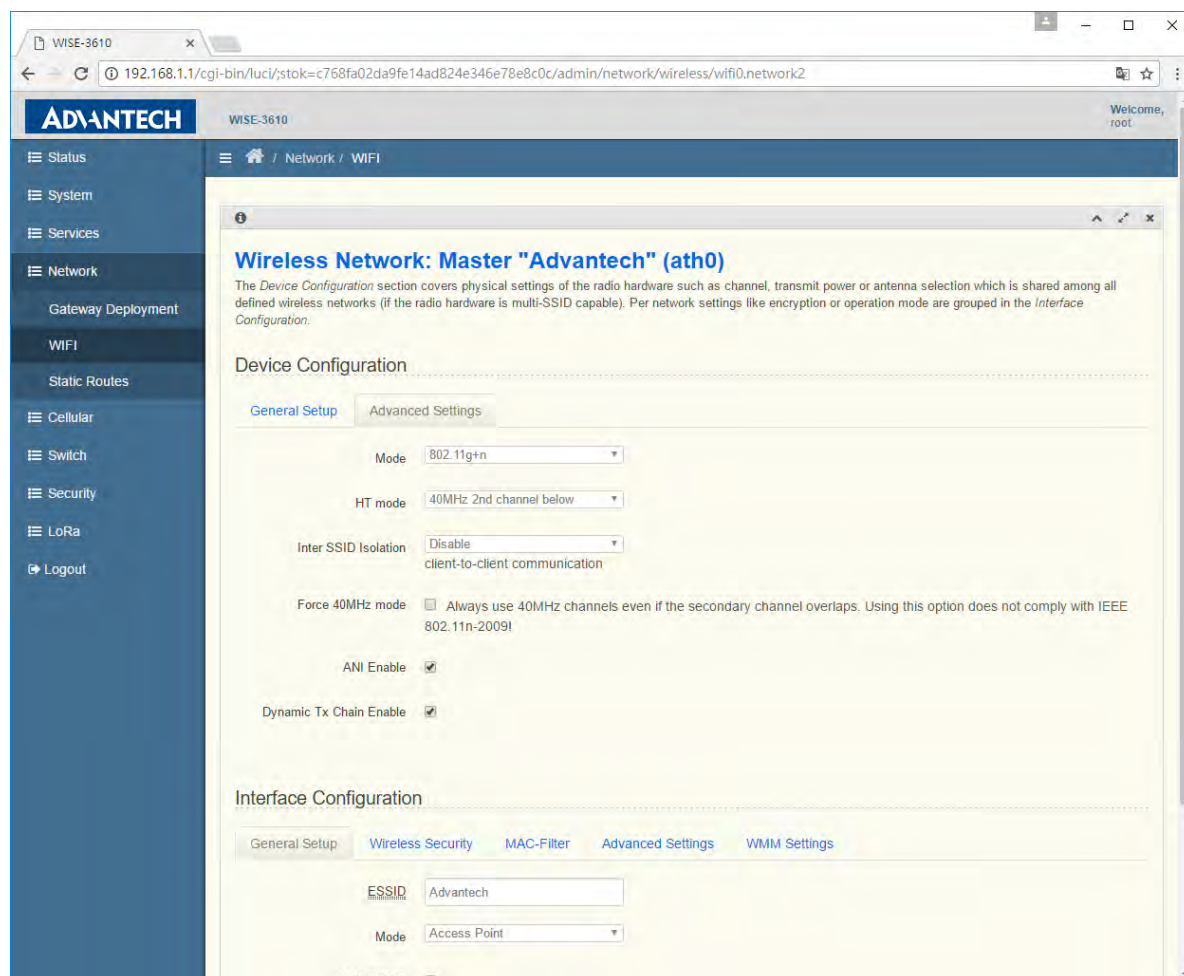

Visit **Network** → **WIFI** → **Edit BUTTON** → **Interface Configuration** → **Wireless Security TAB** to check or modify security settings of interface level.

3.23.13 Encryption

The WIFI security settings. It supports No Encryption, WEP Open System, WEP Shared Key, WEP Mixed, WPA-PSK, WPA2-PSK, WPA-PSK/WPA2-PSK Mixed Mode, WPA-EAP, and WPA2-EAP.

3.23.14 Used Key Slot / Key#1 / Key#2 / Key#3 / Key#4

The security sub items when WEP is chosen. The Used Key Slot indicate which key is used for encryption, and user can introduce 4 keys in system.

3.23.15 Cipher / Key

The Cipher method and Key value for WPA-PSK, WPA2-PSK and WPA-PSK/WPA2-PSK Mixed Mode. The Cipher method supports auto, Force CCMP(AES), Force TKIP, Force TKIP and CCMP(AES).

3.23.16 Cipher / Radius-Authentication-Server(/Port/Secret) / Radius-Account-Enable / NAS ID

The RADIUS configuration for WPA-EAP and WPA2-EAP. The authentication and accounting will be performed on RADIUS server, and LoRa gateway works as authenticator.

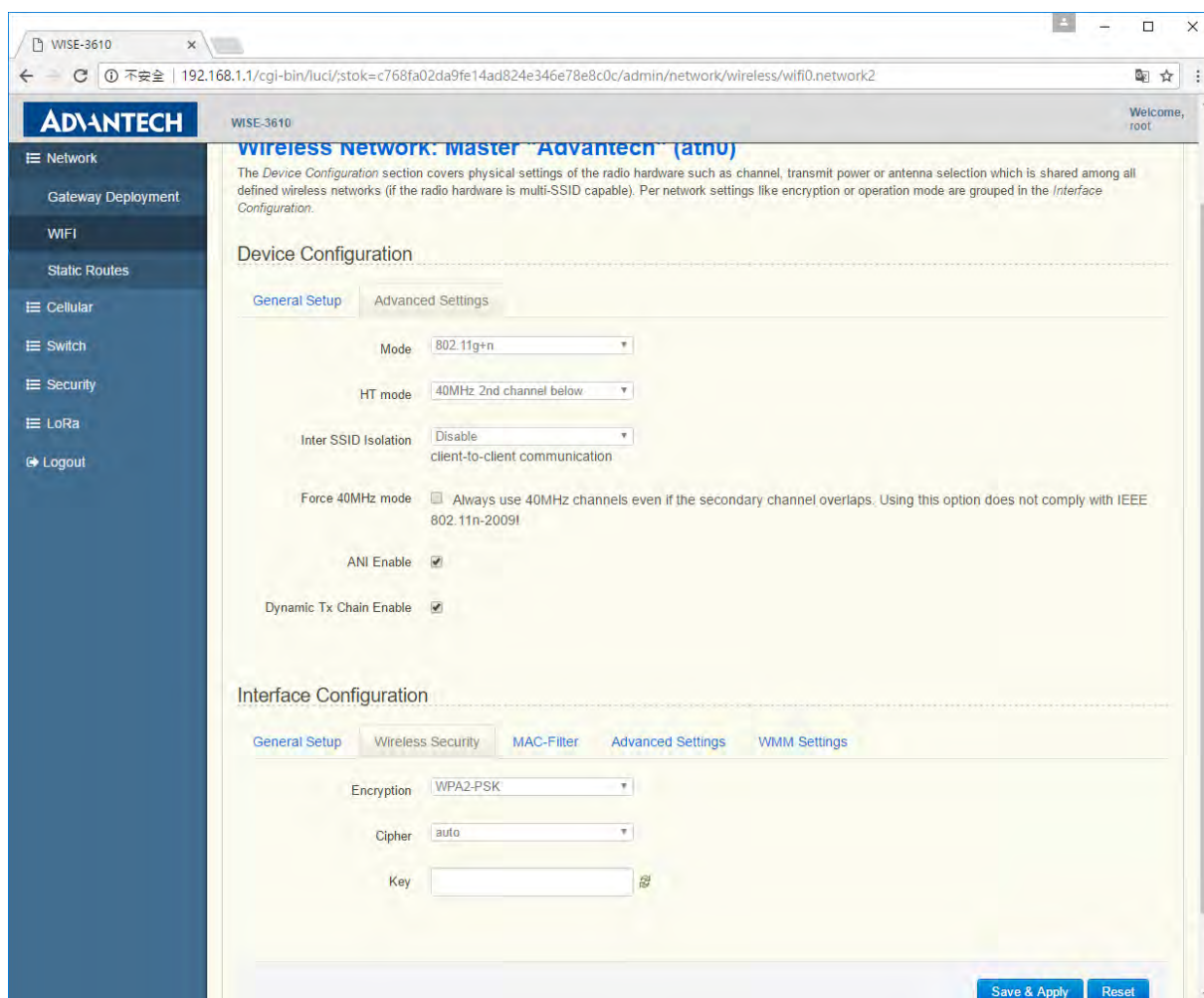

Visit *Network* → *WIFI* → *Edit BUTTON* → *Interface Configuration* → *MAC Filter TAB* to check or modify WIFI station MAC filter settings of interface level.

3.23.15 MAC-Address Filter

This is chip level MAC filter used to drop station traffic. It supports Allow listed only (white list) and Allow all except listed (black list).

3.23.16 MAC-List

To input the MAC address of station that purpose to deny.

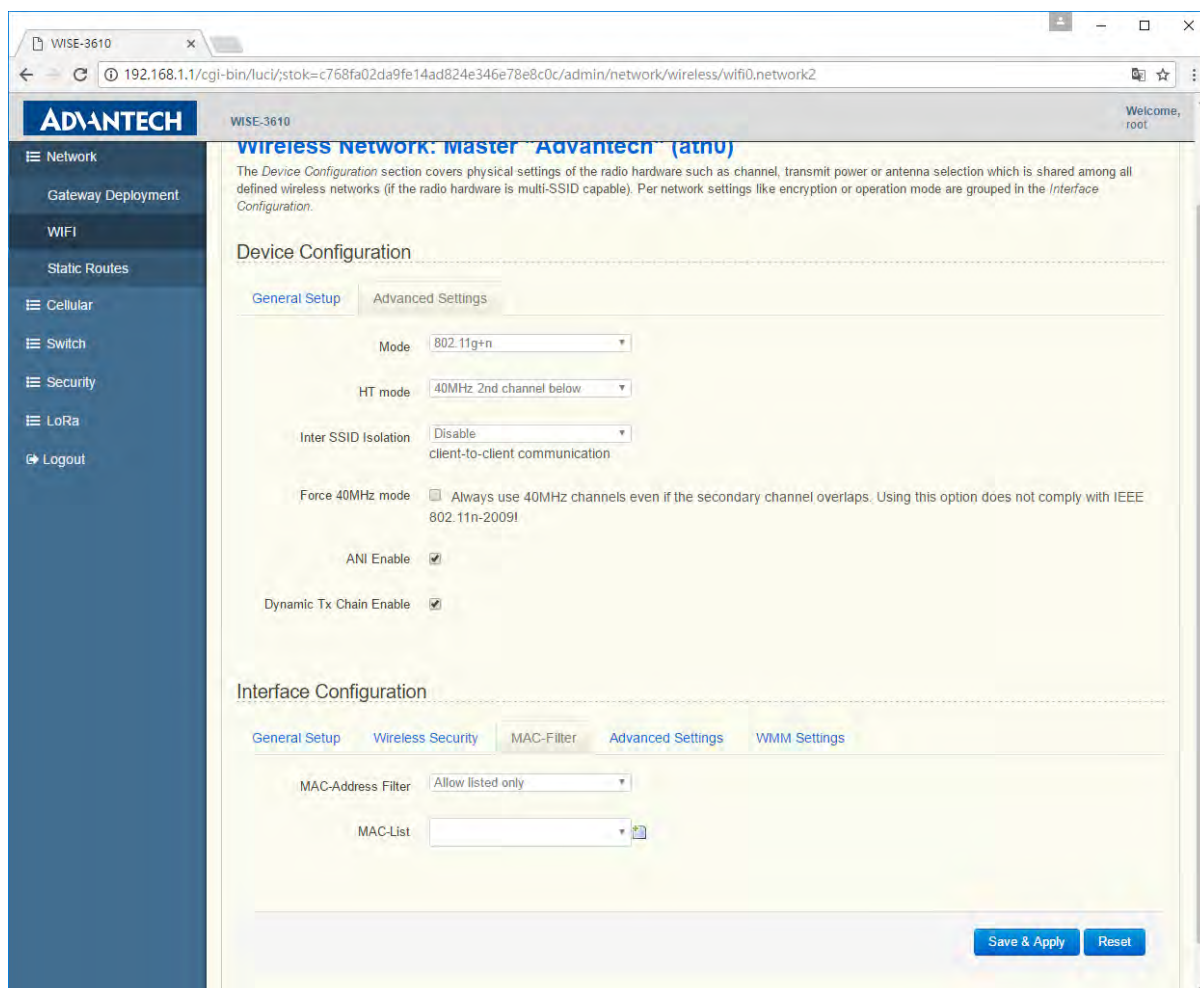

3.24 Static Routes

Visit *Network* → *Static Routes* to manage static route of LoRa gateway. User can add host route or network route according to deployment environment.

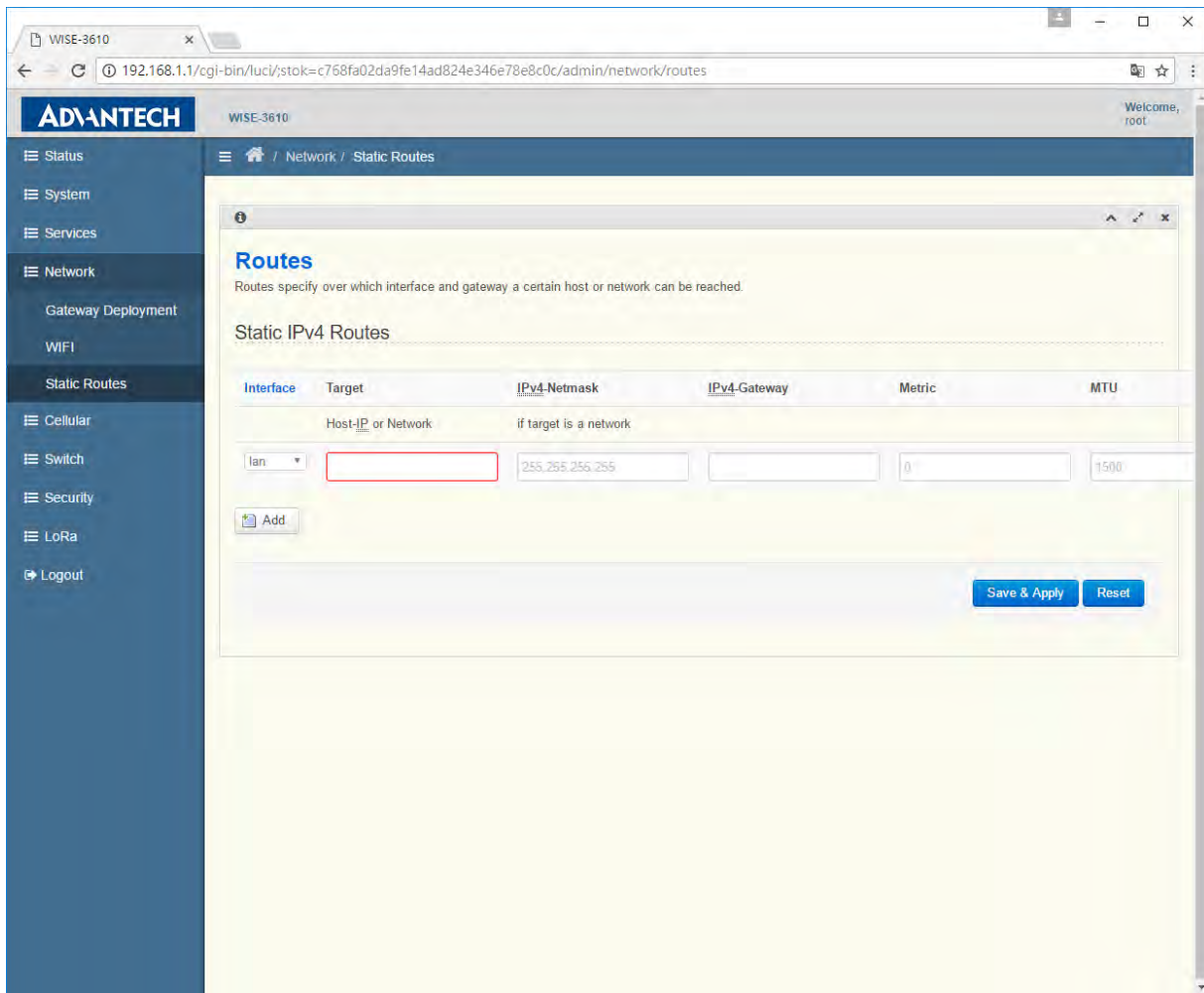

Switch

Visit *Switch* → *Port Status* to check the LAN and WAN link status.

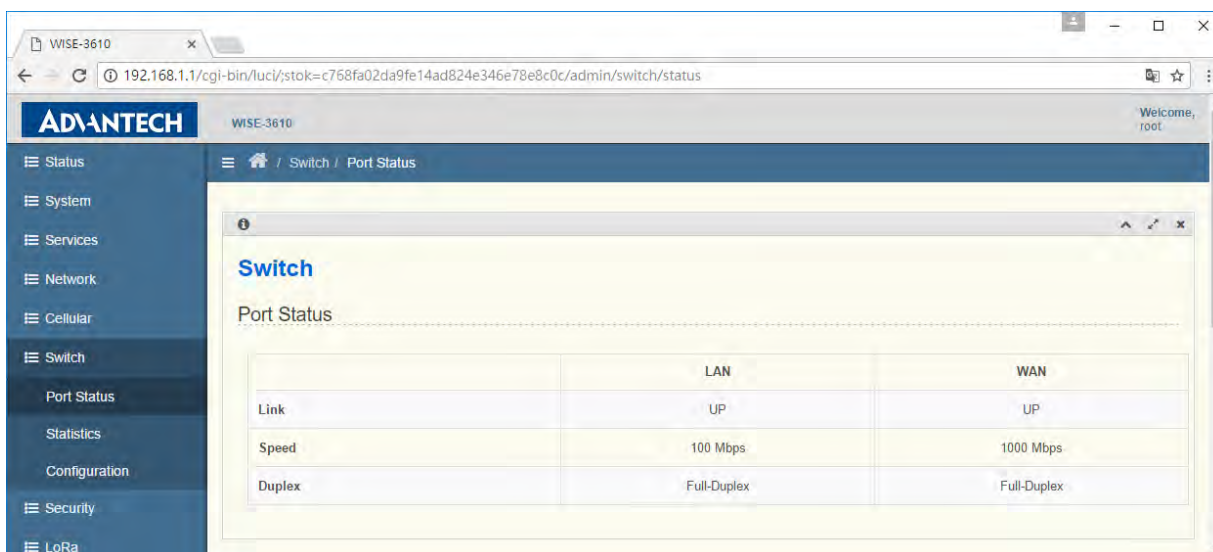

Visit *Switch* → *Statistics* to check the LAN and WAN switch port counter status.

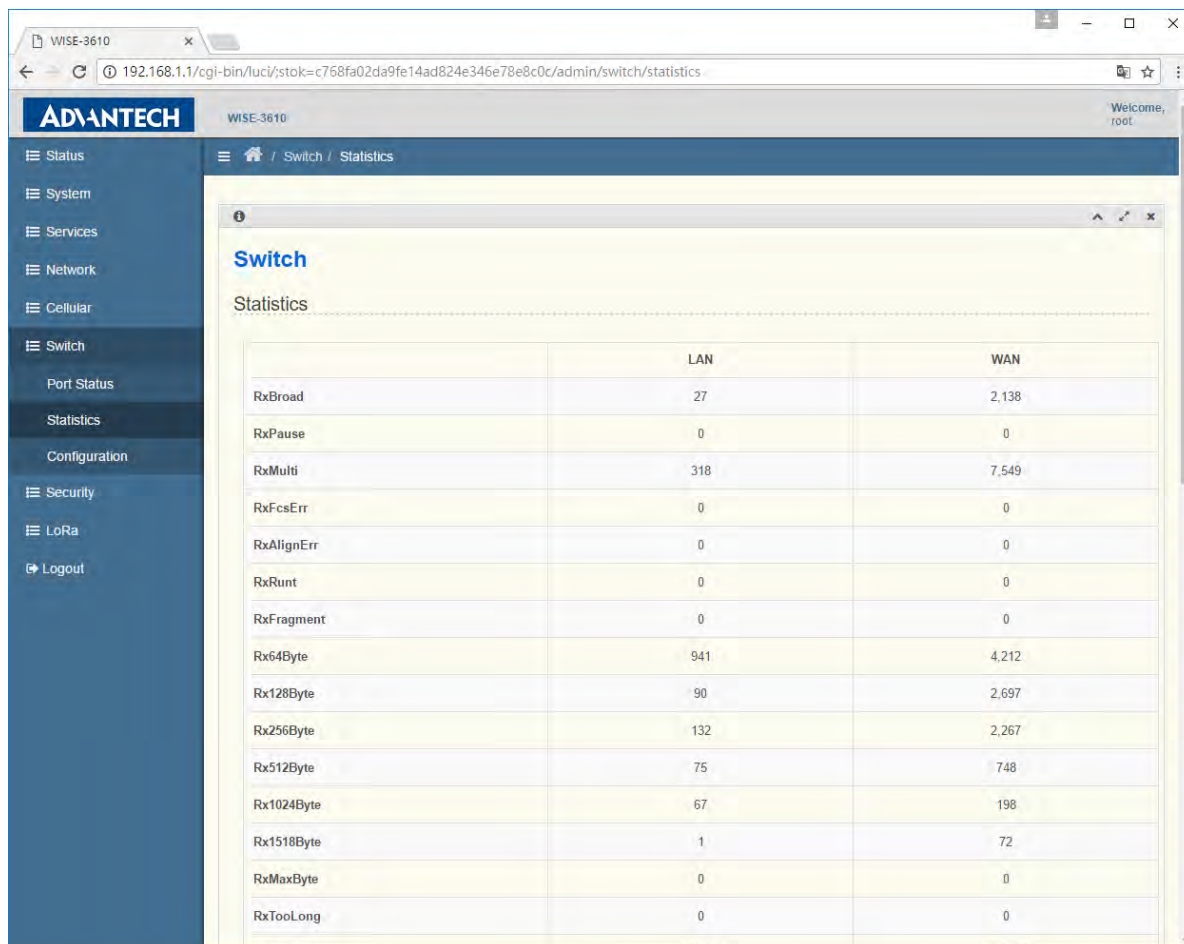

Visit *Switch* → *Configuration* to manage the LAN and WAN switch port configuration. User can enable/disable **Auto-Negotiation**, **Speed**, **Duplex Mode** and **Flow Control** according the deployment environment.

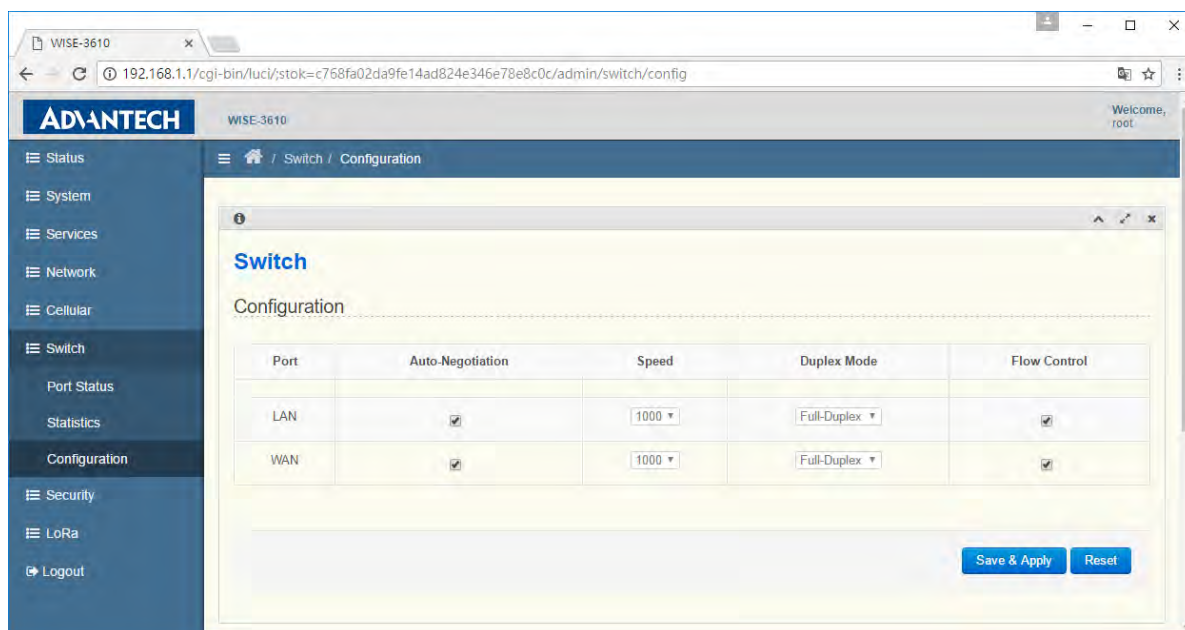

WISE Manager

3.25 Dashboard

Visit *WISE Manager* → *Dashboard* to view the sensor data reported by all nodes.

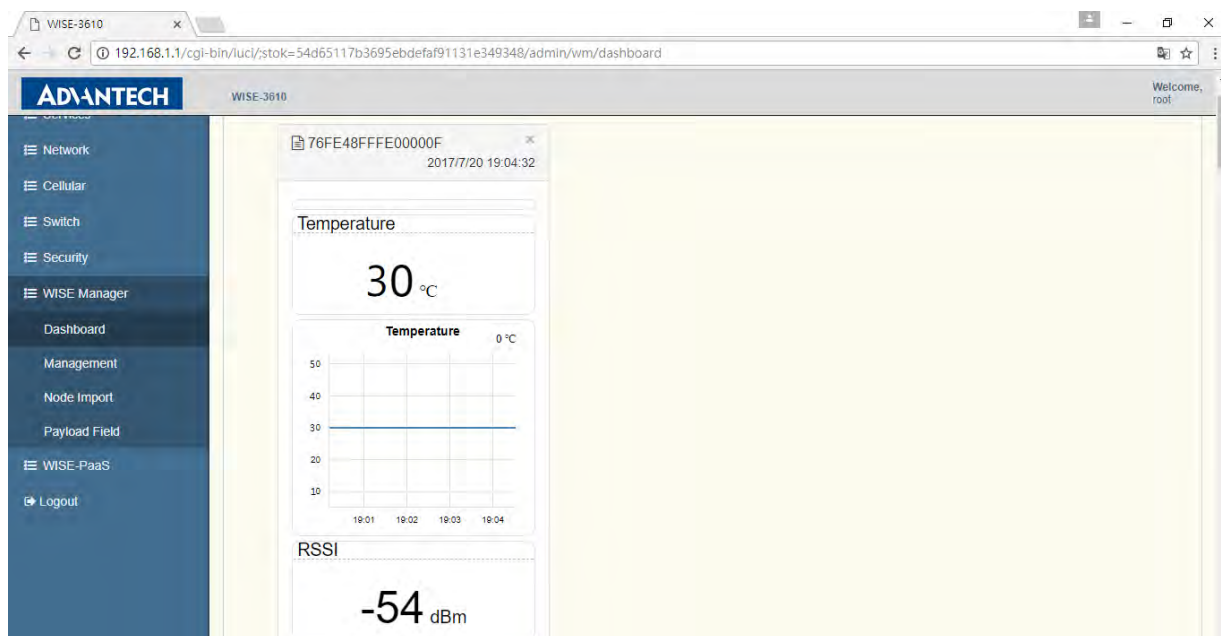

3.26 Management

Visit *WISE Manager* → *Management* to manage the database of nodes and check the status of both gateway and nodes.

Management

The ID of Manager is automatically assigned, and its status is shown afterward. The values of status include 0 for "DOWN", 1 for "START_UP", and 2 for "IN_SERVICE". The ID of LoRa Gateway and Nodes are their EUI respectively, and their status are displayed afterward.

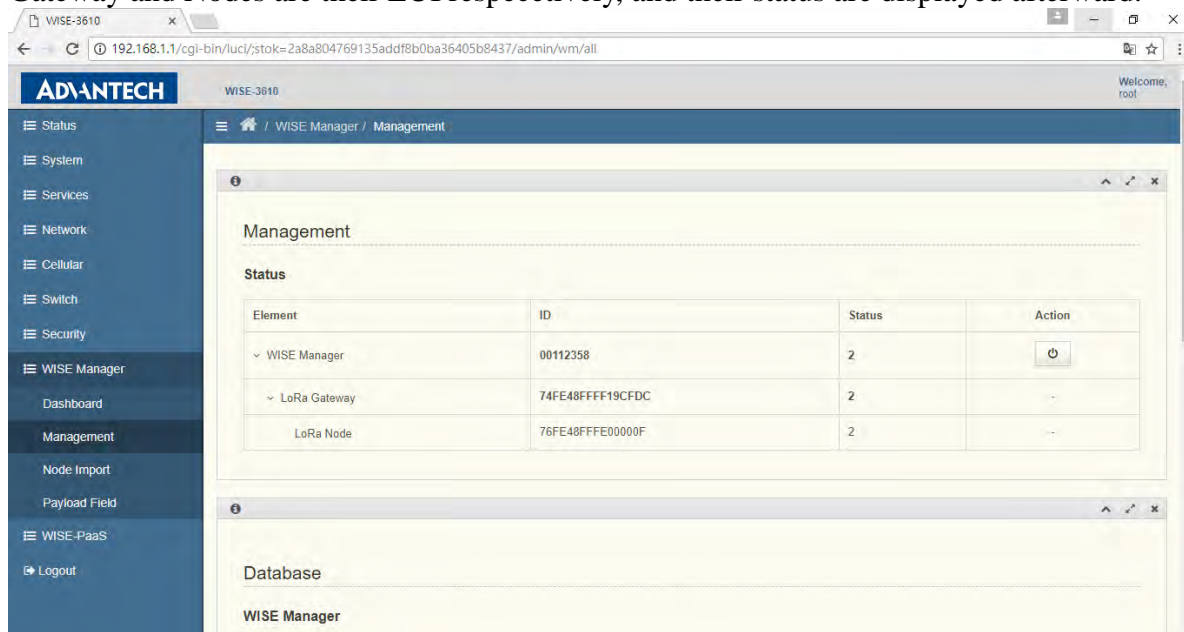

The “Action” button is used to restart WISE Manager. When clicked, the following dialog will pop up. Click “OK” to proceed, or “Cancel” to stop.

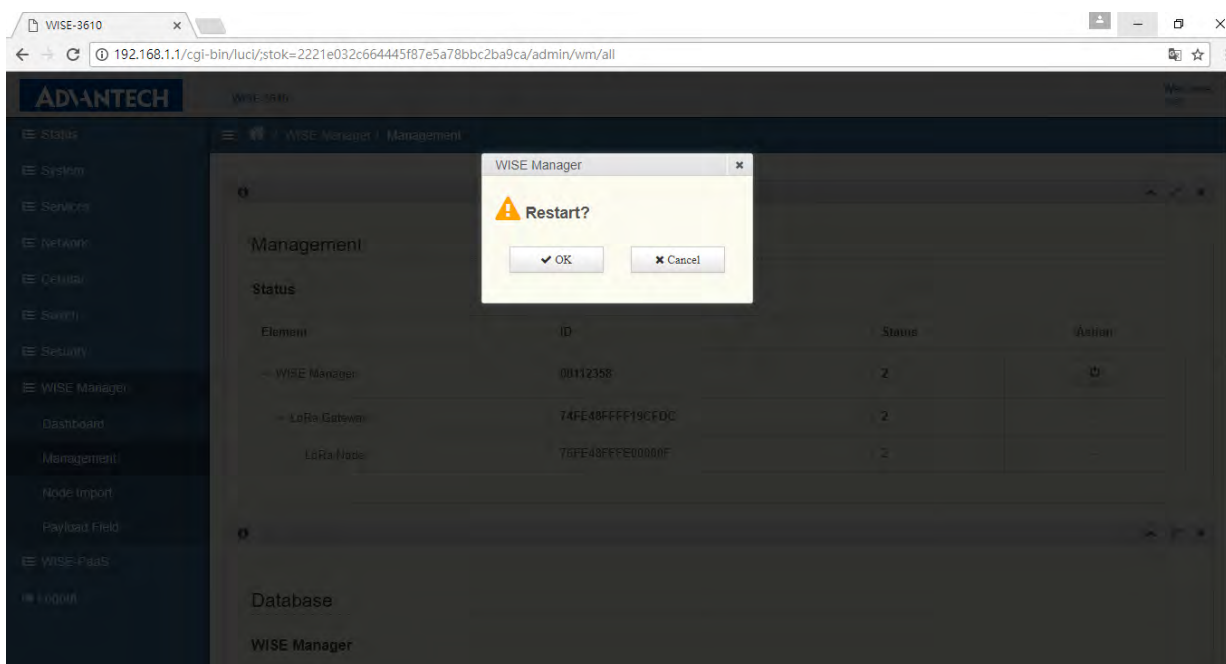

Notes: Restart of “WISE Manager” is required after “Save & Apply” any settings of Management page.

Database

To manipulate Database of WISE Manager, LoRa Gateway, and LoRa Nodes, click the buttons under “Action”.

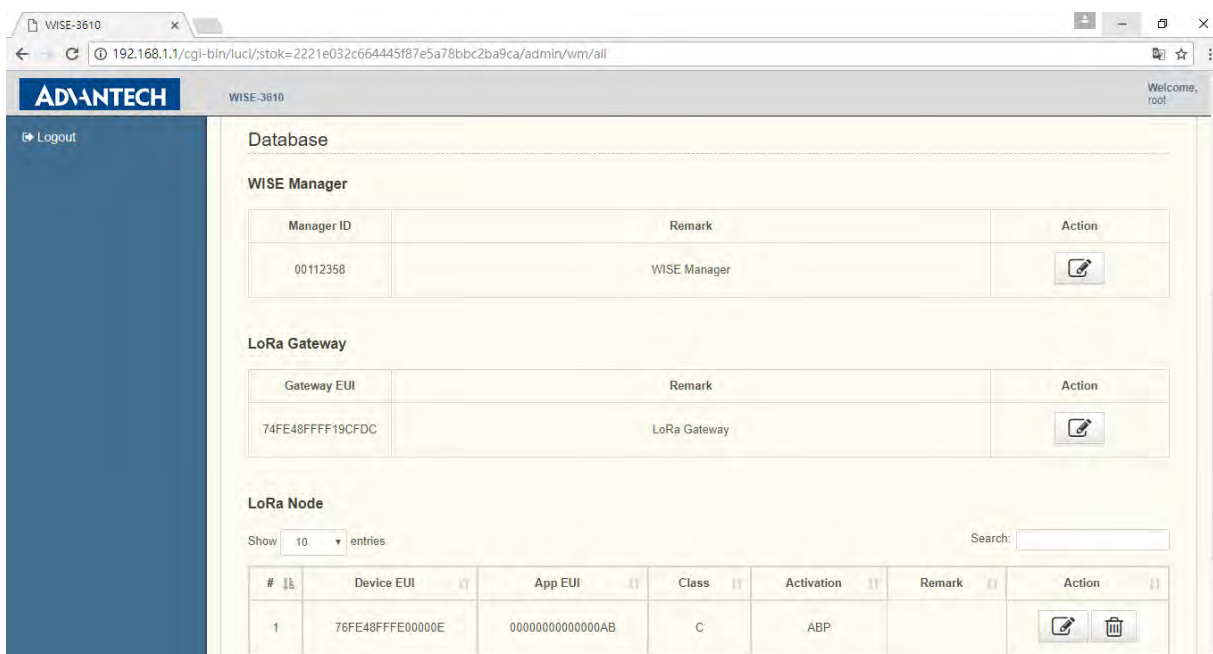

WISE Manager

This is an informative page only. Click “Back to Overview” after browsing the page.

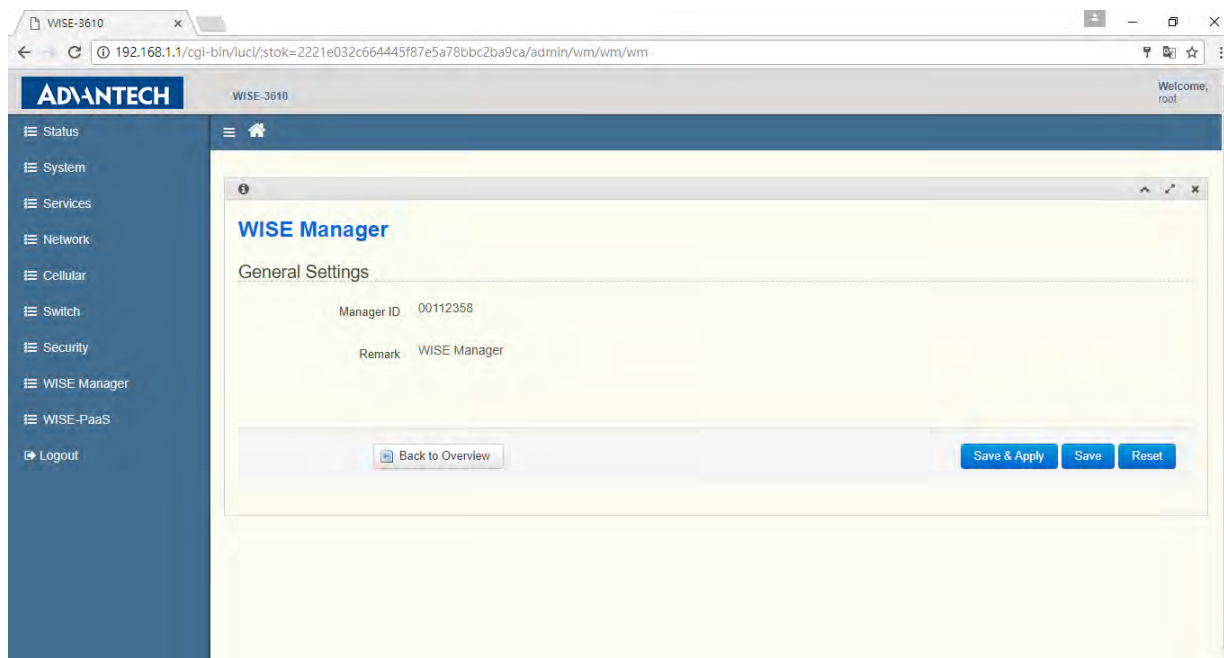

LoRa Gateway

WISE-Link

This page is used to configure all parameters of WISE-Link. The following features can be enabled/or disabled:

“**Beacon**”: On means WISE-Link 2.0. Off means WISE-Link 1.0

“**Periodical Join**”: On means Nodes have to rejoin periodically. Off means no need.

“**Semi-Persistent Scheduling**”: On means Gateway allocates SPS sub-frames for Nodes. Off means Gateway only supports Lottery sub-frames.

“**Multicasting**”: On means Gateway supports multicast to Nodes. Off means Gateway only supports uni-cast.

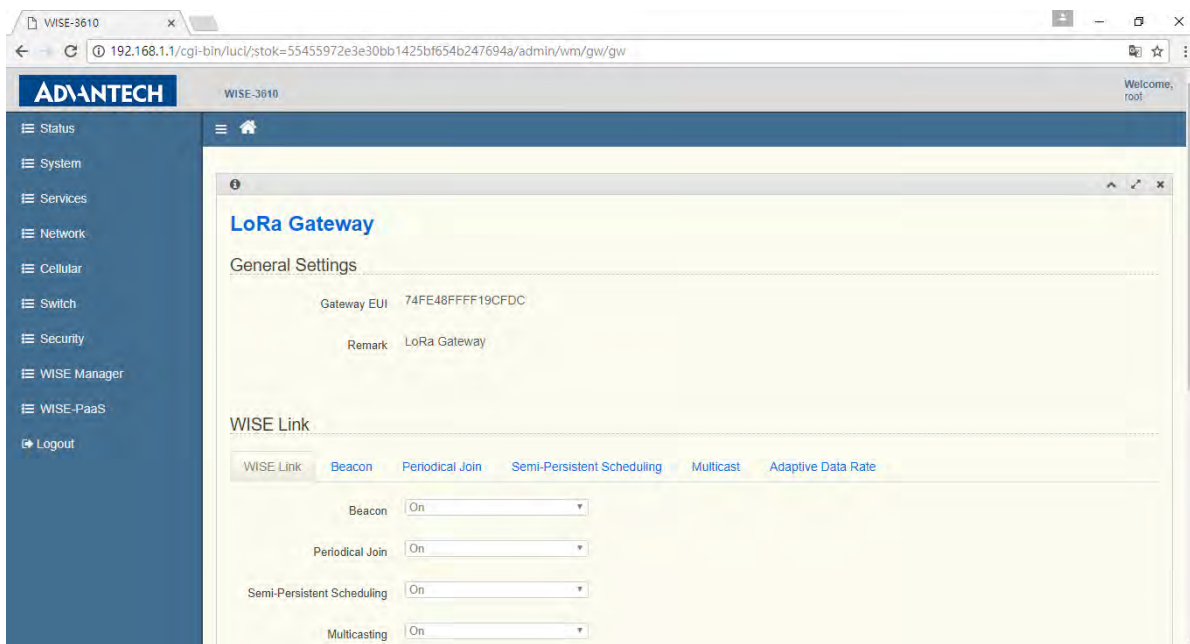

Then, configure parameters of each feature respectively.

Beacon

“**Network ID**”: 4-digits heximals, which identifies the network.

“**Sub Frame Index**”: in terms of ms, which determines the maximum over-the-air time of an uplink packet.

“**Max Tx Ratio**”: in terms of time slots, which determines the maximum over-the-air time of all downlink packets allowed within a TTI.

Note: Each time slot is 50 ms, and each TTI is 2400 ms.

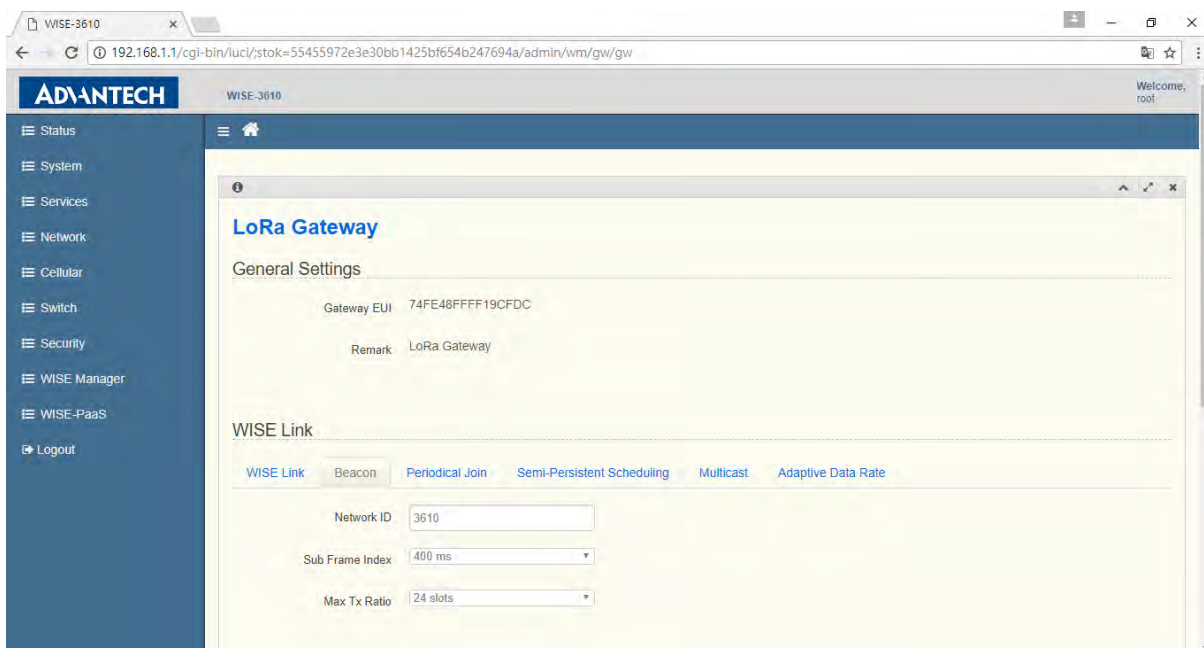

Periodical Join

“Rejoin Period”: in terms of 64 TTIs, determines the deadline nodes need to rejoin? Otherwise, the status of Nodes will be changed to “DOWN” by Gateway when the deadline arrives. For example, 1024 means $1024 * 64 \text{TTIs}$, around 163840 ($1024 * 64 * 2.5$) seconds, which is over 1 day.

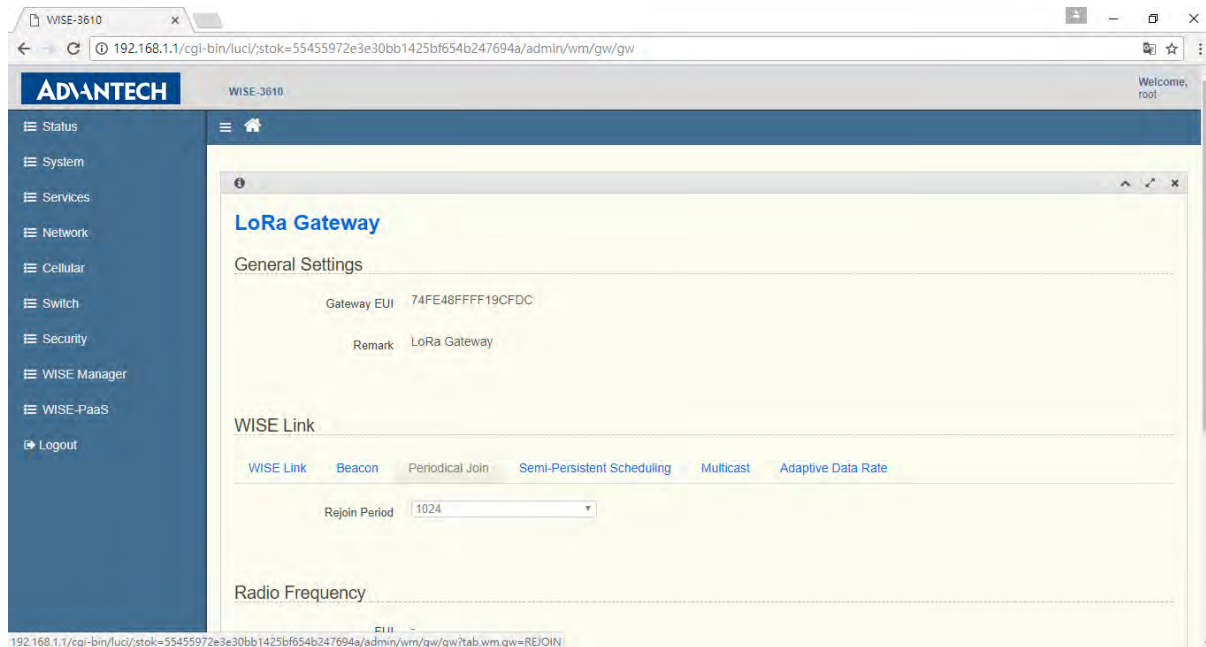

Semi-Persistent Scheduling

“SPS Cycle”: in terms of TTI if the value is less or equal to 64, otherwise in terms of 64 TTIs, determines the cycle time of SPS sub-frames allocated to a specific node. For example, 24 means 24 TTIs, around 60 ($=24 * 2.5$) seconds, and 65 means $2 * (65 - 63) * 64 \text{TTIs}$, around 320 ($=2 * 64 * 2.5$) seconds. The maximum allowed value is 1024.

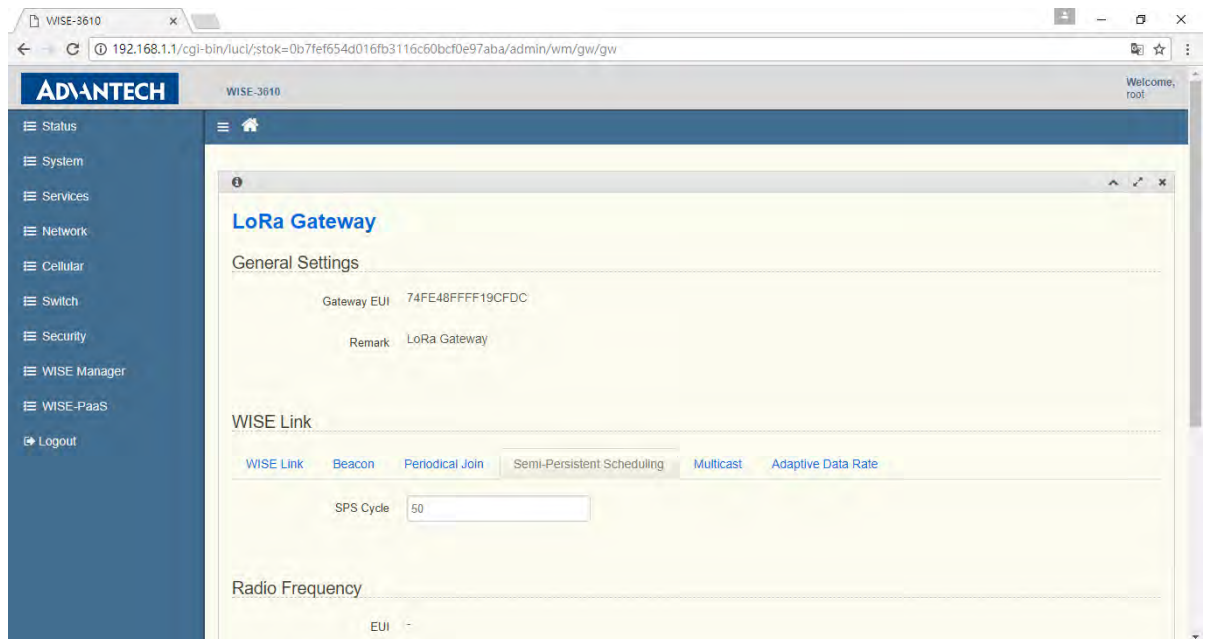

Multicast

“Broadcast Key”: 32-digit heximals, which is used to encrypt/decrypt multicast packets.

“Use Nonce to generate multicast key”: If checked, mutlicast keys will be derived from nonce, and used to encrypt/decrypt multicast packets.

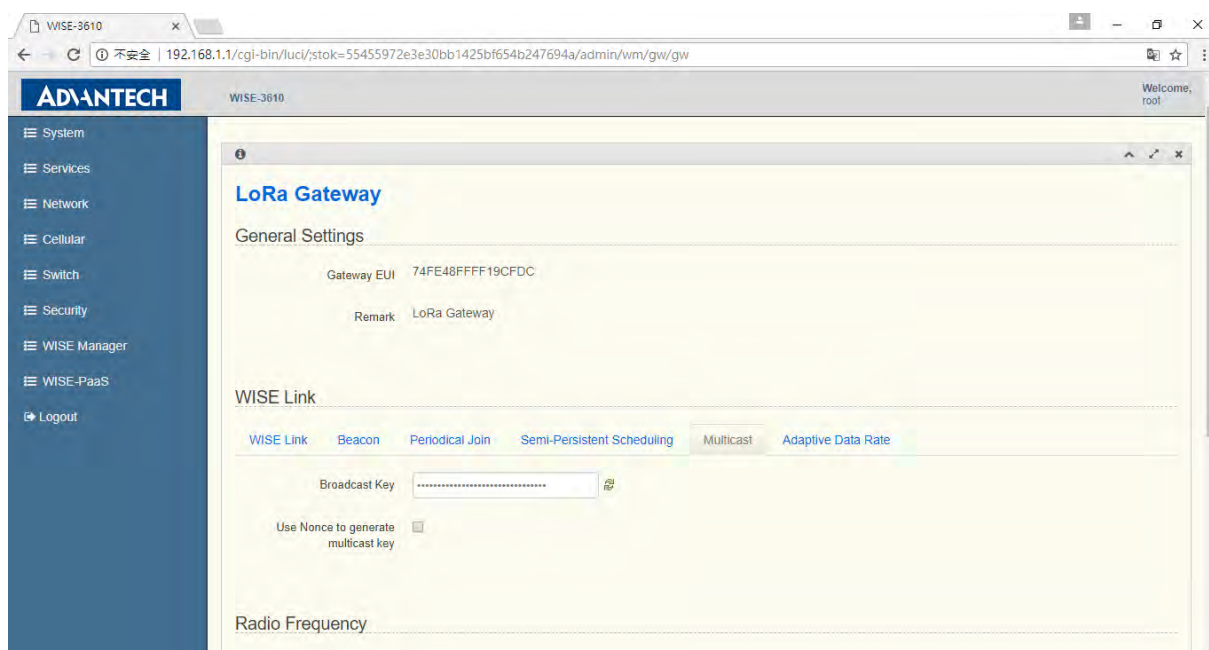

Adaptive Data Rate

“Default Uplink Data Rate”: regional dependant. Allowed range for JP is 0~5. Default 2.

“Default Downlink Data Rate”: regional dependant. Allowed range for JP is 0~5, with default 2.

“Minimum Uplink Data Rate”: regional dependant. Default for JP is 0.

“Maximum Uplink Data Rate”: regional dependant. Default for JP is 5.

“Minimum Downlink Data Rate”: regional dependant. Default for JP is 0.

“Maximum Downlink Data Rate”: regional dependant. Default for JP is 5.

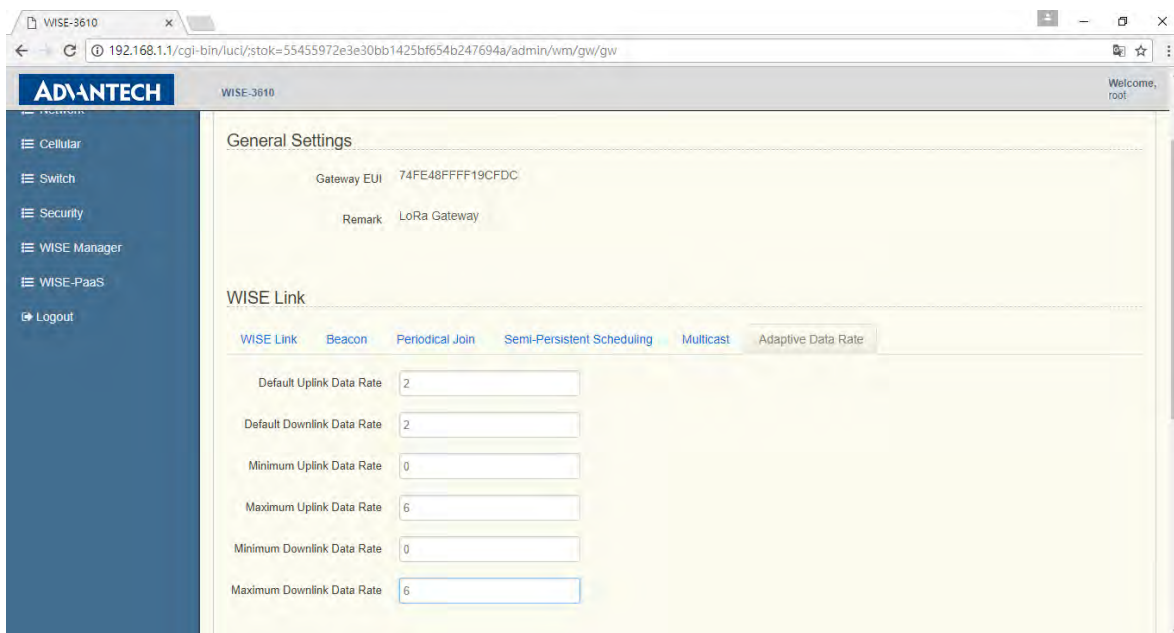

Radio Frequency

In case Beacon is On:

“**Region**” : Select region to be used by Beacon.

“**Channel Frequency**” : Select frequency to be used by Beacon. “Auto” means Gateway auto-selects the channel with the least RSSI.

“**Data Rate**” : Fixed value per region.

“**Tx Power**” : Downlink transmission power in unit of dBm.

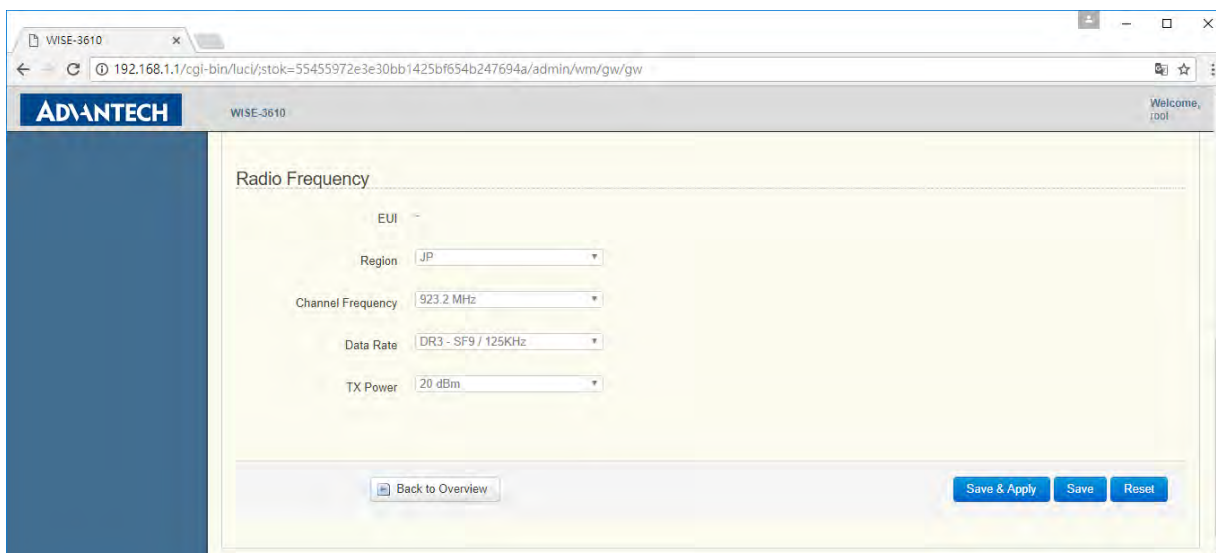

In case Beacon is Off:

“**Region**” : Select region to be used by data.

“**Channel Frequency #1**” : Select frequency to be used on channel 1.

“**Data Rate #1**” : Select data rate to be used on channel 1.

“**Tx power #1**” : Select downlink transmission power on channel 1.

“**Channel Frequency #2**” : Select frequency to be used on channel 2.

“**Data Rate #2**” : Select data rate to be used on channel 2.

“**Tx power #2**” : Select downlink transmission power on channel 2.

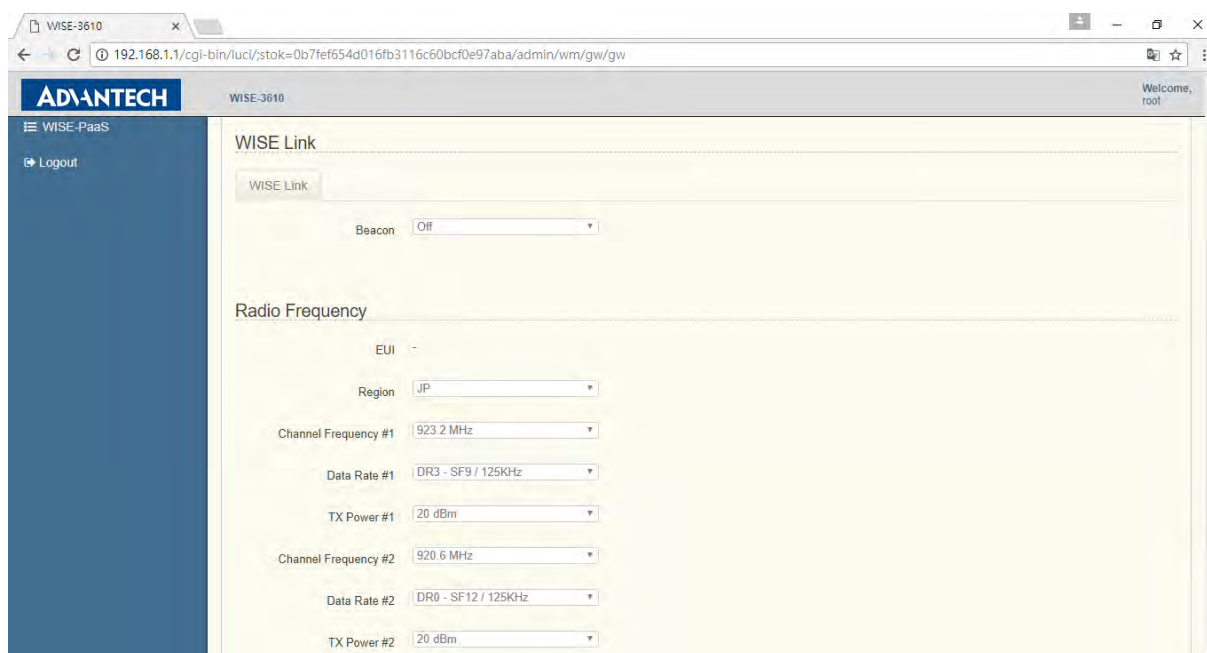

Node

Add LoRa Node

Depending on the “Activation” mode of nodes, different parameters are required.

In case of OTAA,

“**Device EUI**” : 16-digit heximals.

“**App EUI**” : 8-digit heximals.

“**Device Class**” : A stands for Class-A, and C stands for Class-C.

“**Activation**” : OTAA

“**App Key**” : 32-digit heximals.

“**Payload Field**” : Enabled means data is encoded according to rules in *WISE Manager->Payload Field*. Disabled means data is in raw format.

“**SPS**” : Enabled means SPS subframes are reserved for the node. Disabled means the node can use Lottery subframes only.

“**Remark**”: used for decorating the node, up to 64 characters.

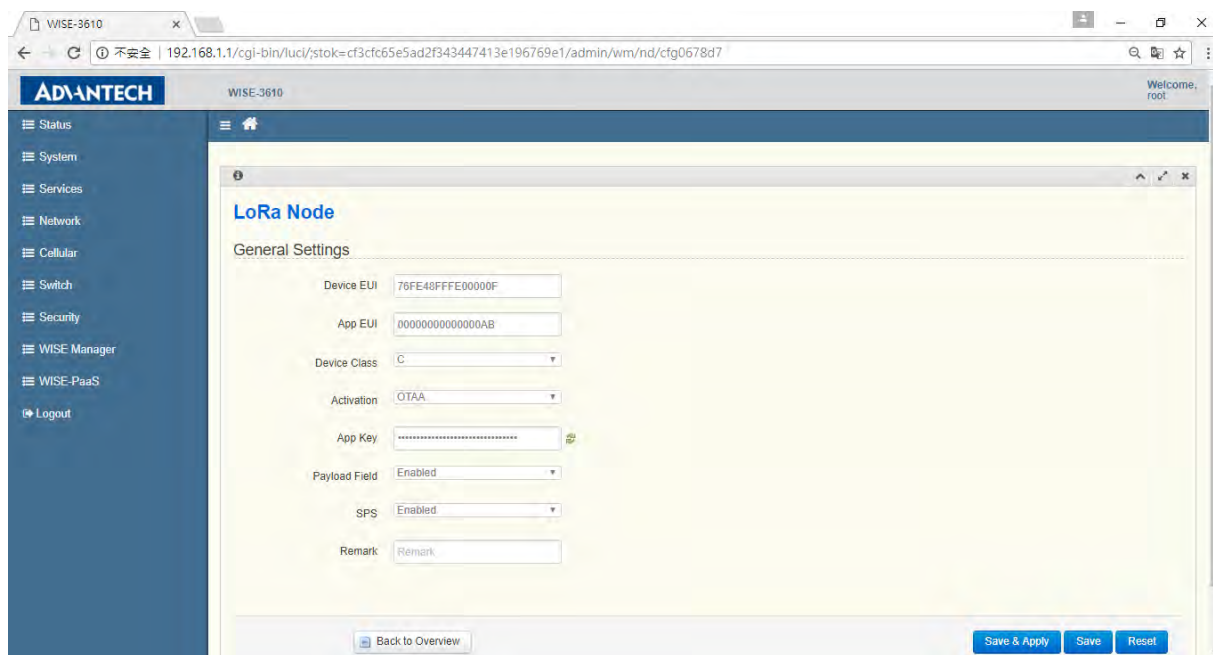

In case of ABP:

“**Device EUI**”: 16-digit heximals.

“**App EUI**”: 8-digit heximals.

“**Device Class**”: A stands for class-A, and C stands for class-C.

“**Activation**”: ABP

“**Device Address**”: 8-digit heximals

“**Network Session Key**”: 32-bit heximals

“**Application Session Key**”: 32-bit heximals

“**Payload Field**”: Enabled means data is encoded according to rules in *WISE Manager->Payload Field*. Disabled means data is in raw format.

“**SPS**”: Enabled means SPS subframes are reserved for the node. Disabled means the node can use Lottery subframes only.

“**Remark**”: used for decorating the node, up to 64 characters.

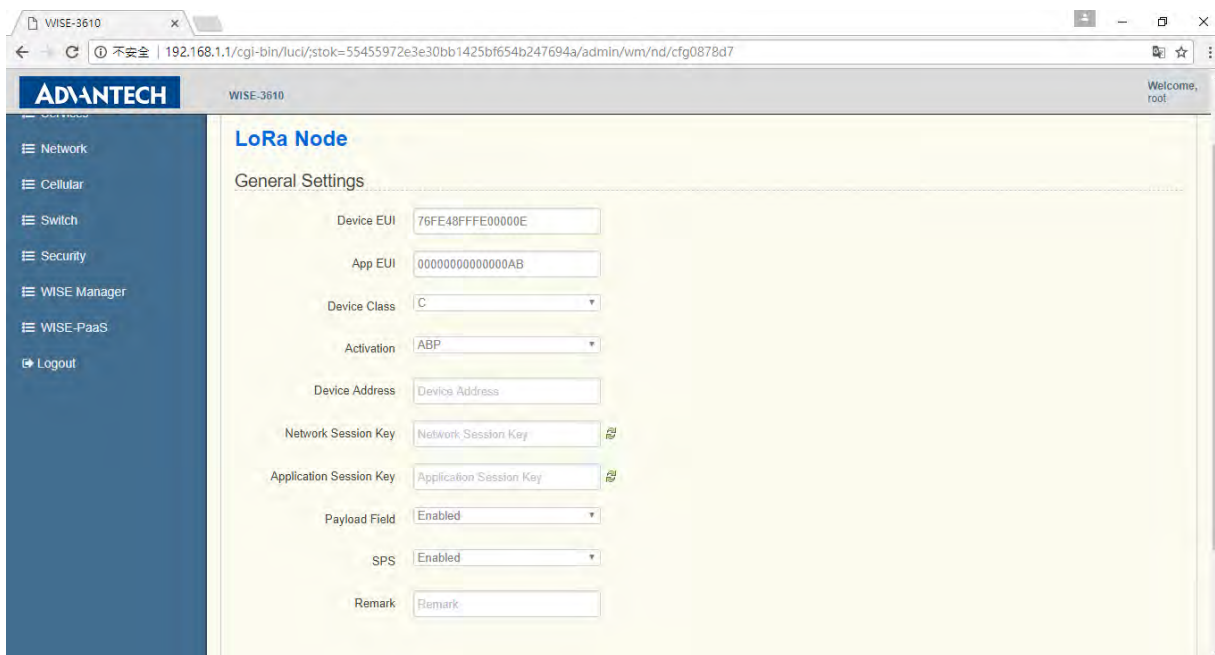

Edit

Click the circled button to edit an added node.

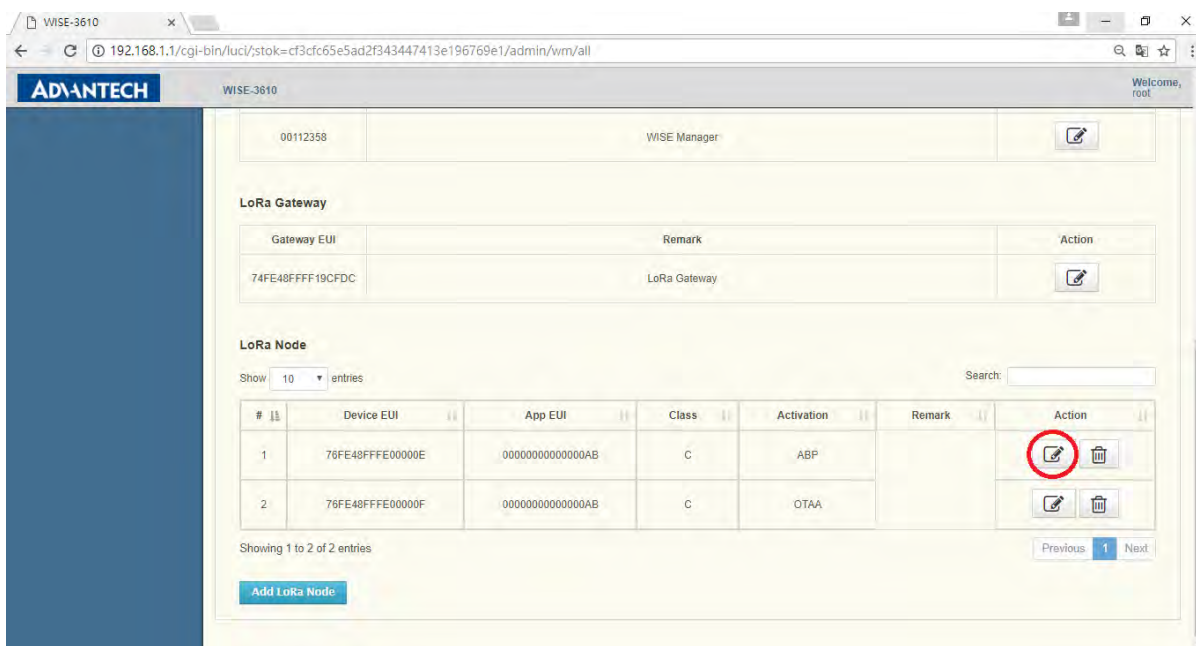

Delete

Click the circled button to delete an added node.

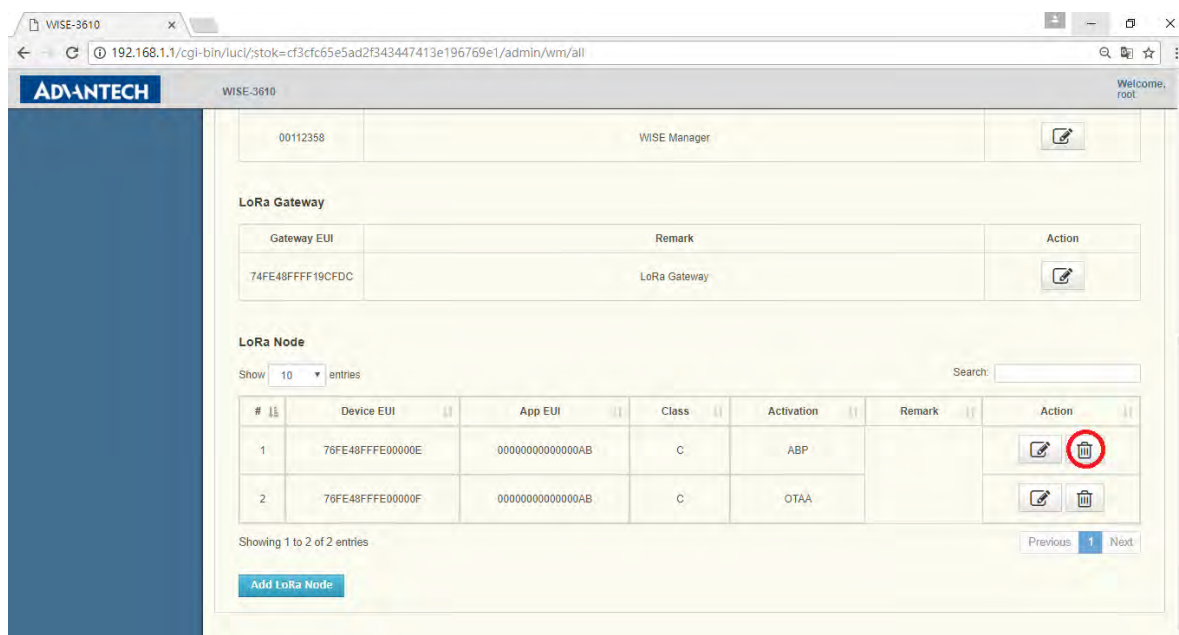

3.27 LoRa Node Import

Visit **WISE Manager->Node Import** to import node database. Click on the “Node.json” after “Template” to download the database template. The content of Node.json is as below:

```
[
  {
    "Metadata" : ["DevEUI", "AppEUI", "Class", "ActMode", "AppKey", "PayloadField",
                  "SpsConf", "Remark"],
    "Node"      : [
                  ["76FE48FFFA000001", "00000000000000ab", "C", "OTAA",
                  "00000000000000000000000000000000A1", "1", "1", "Node1"],
                  ["76FE48FFFA000002", "00000000000000ab", "A", "OTAA",
                  "00000000000000000000000000000000A2", "1", "1", "Node2"]
                  ]
  },
  {
    "Metadata" : ["DevEUI", "AppEUI", "Class", "ActMode", "DevAddr", "NwkSKey",
                  "AppSKey", "PayloadField", "SpsConf", "Remark"],
    "Node"      : [
                  ["76FE48FFFA000003", "00000000000000ab", "A", "ABP",
                  "FA000003", "00000000000000000000000000000000A3",
                  "00000000000000000000000000000000A3", "1", "1", "Node3"],
                  ["76FE48FFFA000004", "00000000000000ab", "C", "ABP",
                  "FA000004", "00000000000000000000000000000000A4",
                  "00000000000000000000000000000000A4", "1", "1", "Node4"]
                  ]
  }
]
```

Two sections are enclosed in brackets: one for OTAA and the other for ABP nodes. Preserve the content of “Metadata”, and replace the content inside “Node” with those nodes you have. Click “Select File” to select the edited data base, and then click “Append” to append the content into the current node database. Or, click “Overwrite” if you’d like overwrite the current database.

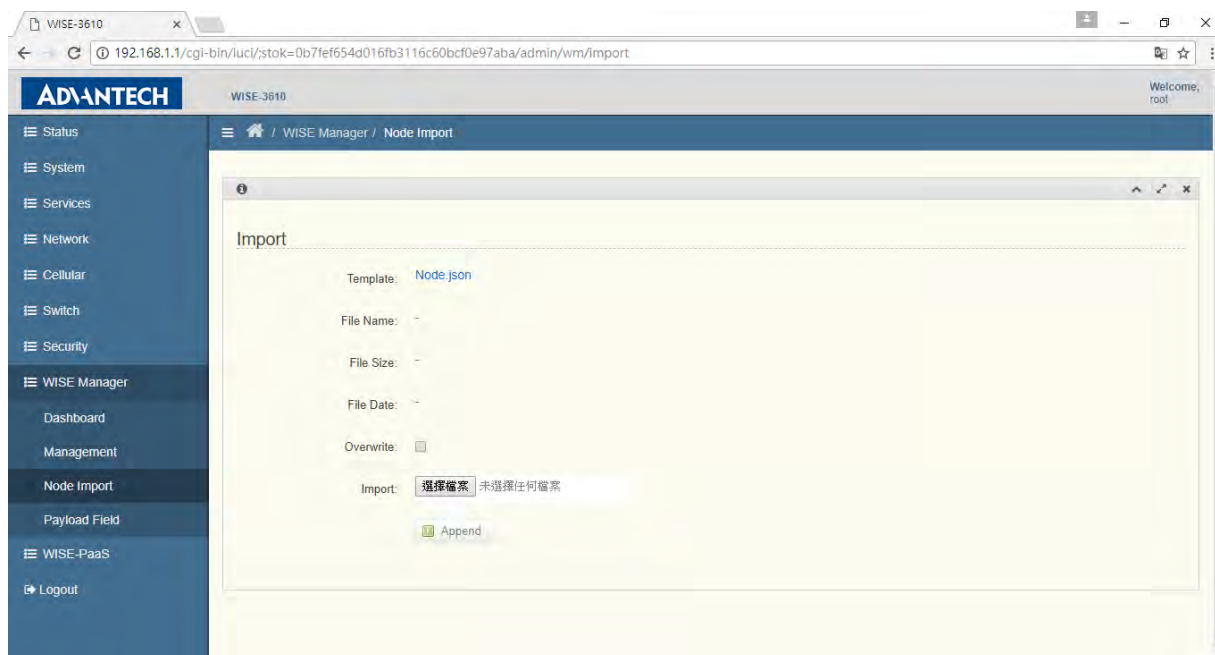

3.28 Payload Field

Visit *WISE Manager->Payload Field* to define the format of sensor data. At most 4 sensor data can be encapsulated inside a payload field. Each payload field can be distinguished by Application EUI and Port.

“**Application EUI**”: 16-digit heximals.

“**Port**”: LoRa port number. Valid range is 0 to 223.

“**Payload Field**”: Number of data formats, 1~ 4.

“**Id**”: Id of data.

“**Name**”: Name of sensor type. Select “Custom” if there are no matched sensor type, and enter the proper name manually.

“**Type**”: Type of data format, including “Raw”, “Value”, “String”, “Boolean” and “GPS”.

“**Decimal Point**”: Factorization of data. 0 means no factorization.

“**Sign**”: Signation of data. On means positive and negative, and Off means positive only.

“**Unit**”: Unit of data value. Enter unicode if necessary.

“**Minimum**”: the lower bound of data value.

“**Maximum**”: the upper bound of data value.

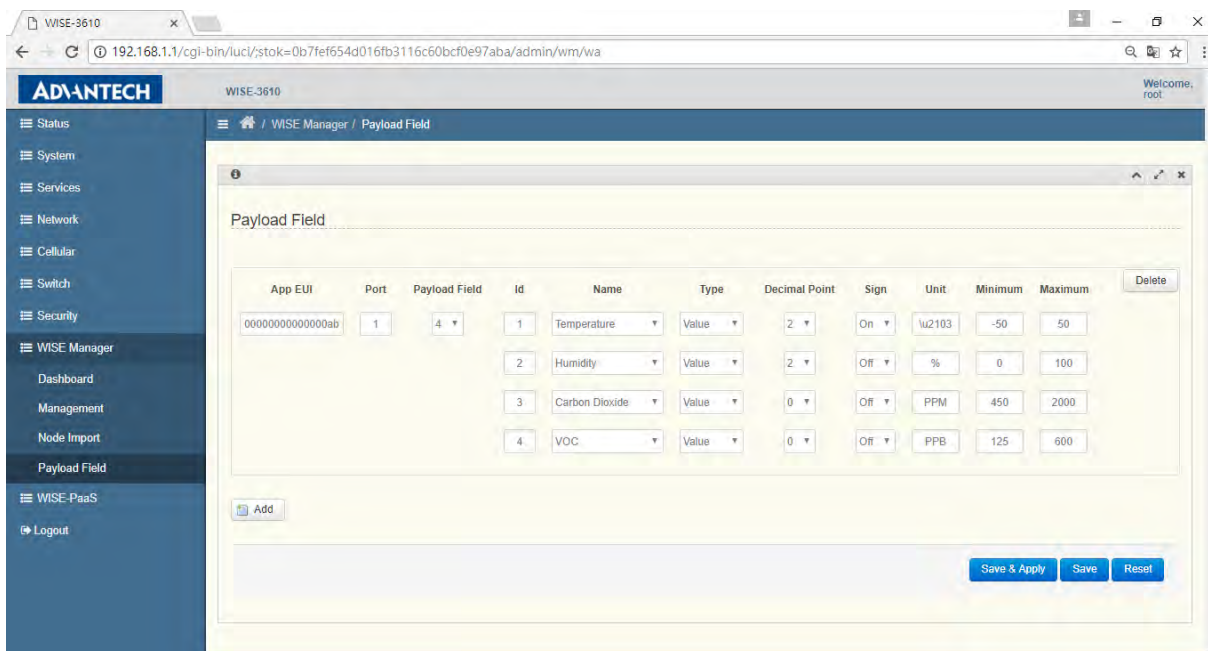

3.29 WISE-PaaS

Visit *WISE-PaaS* to configure connection of WISE-PaaS/RMM.

3.29.1 Hostname

The domain name of WISE-PaaS/RMM server.

3.29.2 Port

TCP port number of WISE-PaaS/RMM Server.

Note: Username and Password are disabled.

Chapter 5

Advantech Services

This chapter introduces Advantech technical support and warranty policy for WISE-3610

5.1 Contact Information

Below is the contact information for Advantech customer service.

Region/Country	Contact Information
America	1-888-576-9688
Brazil	0800-770-5355
Mexico	01-800-467-2415
Europe (Toll Free)	00800-2426-8080
Singapore & SAP	65-64421000
Malaysia	1800-88-1809
Australia (Toll Free)	1300-308-531
China (Toll Free)	800-810-0345 800-810-8389 Sales@advantech.com.cn
India (Toll Free)	1-800-425-5071
Japan (Toll Free)	0800-500-1055
Korea (Toll Free)	080-363-9494 080-363-9495
Taiwan (Toll Free)	0800-777-111
Russia (Toll Free)	8-800-555-01-50

On the other hand, you can reach our service team through below website, our technical support engineer will provide quick response once the form is filled out:

http://www.advantech.com.tw/contact/default.aspx?page=contact_form2&subject=Technical+Support

5.2 Global Service Policy

5.2.1 Warranty Policy

Below is the warranty policy of Advantech products:

5.2.1.1 Warranty Period

Advantech branded off-the-shelf products and 3rd party off-the-shelf products used to assemble Advantech Configure to Order products are entitled to a 2 years complete and prompt global warranty service. Product defect in design, materials, and workmanship, are covered from the date of shipment.

All customized products will by default carry a 15 months regional warranty service. The actual product warranty terms and conditions may vary based on sales contract. All 3rd party products purchased separately will be covered by the original manufacturer's warranty and time period, and shall not exceed one year of coverage through Advantech.

5.2.1.2 Repairs under Warranty

It is possible to obtain a replacement (Cross-Shipment) during the first 30 days of the purchase, thru your original ADVANTECH supplier to arrange DOA replacement if the products were purchased directly from ADVANTECH and the product is DOA

(Dead-on-Arrival). The DOA Cross-Shipment excludes any shipping damage, customized and/or build-to-order products.

For those products which are not DOA, the return fee to an authorized ADVANTECH repair facility will be at the customers' expense. The shipping fee for reconstructive products from ADVANTECH back to customers' sites will be at ADVANTECH's expense.

5.2.1.3 Exclusions from Warranty

The product is excluded from warranty if

- The product has been found to be defective after expiry of the warranty period.
- Warranty has been voided by removal or alternation of product or part identification labels.
- The product has been misused, abused, or subjected to unauthorized disassembly/modification; placed in an unsuitable physical or operating environment; improperly maintained by the customer; or failure caused which ADVANTECH is not responsible whether by accident or other cause. Such conditions will be determined by ADVANTECH at its sole unfettered discretion.
- The product is damaged beyond repair due to a natural disaster such as a lightning strike, flood, earthquake, etc.
- Product updates/upgrades and tests upon the request of customers who are without warranty.

5.2.2 Repair Process

5.2.2.1 Obtaining an RMA Number

All returns from customers must be authorized with an ADVANTECH RMA (Return Merchandise Authorization) number. Any returns of defective units or parts without valid RMA numbers will not be accepted; they will be returned to the customer at the customer's cost without prior notice .

An RMA number is only an authorization for returning a product; it is not an approval for repair or replacement. When requesting an RMA number, please access ADVANTECH's RMA web site: <http://erma.ADVANTECH.com.tw> with an authorized user ID and password.

You must fill out basic product and customer information and describe the problems encountered in detail in "Problem Description". Vague entries such as "does not work" and "failure" are not acceptable.

If you are uncertain about the cause of the problem, please contact ADVANTECH's Application Engineers (AE). They may be able to find a solution that does not require sending the product for repair.

The serial number of the whole set is required if only a key defective part is returned for repair. Otherwise, the case will be regarded as out-of-warranty.

5.2.2.2 Returning the Product for Repair

It's possible customers can save time and meet end-user requirements by returning defective products to any authorized ADVANTECH repair facility without an extra cross-region charge . It is required to contact the local repair center before offering

global repair service.

It is recommended to send cards without accessories (manuals, cables, etc.). Remove any unnecessary components from the card, such as CPU, DRAM, and CF Card. If you send all these parts back (because you believe they may be part of the problem), please note clearly that they are included. Otherwise, ADVANTECH is not responsible for any items not listed. Make sure the "Problem Description" is enclosed.

European Customers that are located outside European Community are requested to use UPS as the forwarding company. We strongly recommend adding a packing list to all shipments. Please prepare a shipment invoice according to the following guidelines to decrease goods clearance time:

1. Give a low value to the product on the invoice, or additional charges will be levied by customs that will be borne by the sender.
2. Add information "Invoice for customs purposes only with no commercial value" on the shipment invoice.
3. Show RMA numbers, product serial numbers and warranty status on the shipment invoice.
4. Add information about Country of origin of goods

In addition, please attach an invoice with RMA number to the carton, then write the RMA number on the outside of the carton and attach the packing slip to save handling time. Please also address the parts directly to the Service Department and mark the package "Attn. RMA Service Department".

All products must be returned in properly packed ESD material or anti-static bags. ADVANTECH reserves the right to return unrepaired items at the customer's cost if inappropriately packed.

Besides that, "Door-to-Door" transportation such as speed post is recommended for delivery, otherwise, the sender should bear additional charges such as clearance fees if Air-Cargo is adopted.

Should DOA cases fail, ADVANTECH will take full responsibility for the product and transportation charges. If the items are not DOA, but fail within warranty, the sender will bear the freight charges. For out-of-warranty cases, customers must cover the cost and take care of both outward and inward transportation.

5.2.2.3 Service Charges

The product is excluded from warranty if :

- The product is repaired after expiry of the warranty period.
- The product is tested or calibrated after expiry of the warranty period, and a No Problem Found (NPF) result is obtained.
- The product, though repaired within the warranty period, has been misused, abused, or subjected to unauthorized disassembly/modification; placed in an unsuitable physical or operating environment; improperly maintained by the customer; or failure caused which ADVANTECH is not responsible whether by accident or other cause. Such conditions will be determined by ADVANTECH at its sole unfettered discretion.
- The product is damaged beyond repair due to a natural disaster such as a lightning strike, flood, earthquake, etc.
- Product updates and tests upon the request of customers who are without warranty.

If a product has been repaired by ADVANTECH, and within three months after such a repair the product requires another repair for the same problem, ADVANTECH will do this repair free of charge. However, such free repairs do not apply to products which have been misused, abused, or subjected to unauthorized disassembly/modification; placed in an unsuitable physical or operating environment; improperly maintained by the customer; or failure caused which ADVANTECH is not responsible whether by accident or other cause.

Please contact your nearest regional service center for detail service quotation.

Before we start out-of-warranty repairs, we will send you a pro forma invoice (P/I) with the repair charges. When you remit the funds, please reference the P/I number listed under "Our Ref". ADVANTECH reserves the right to deny repair services to customers that do not return the DOA unit or sign the P/I. Meanwhile, ADVANTECH will scrap defective products without prior notice if customers do not return the signed P/I within 3 months.

5.2.2.4 Repair Report

ADVANTECH returns each product with a "Repair Report" which shows the result of the repair. A "Repair Analysis Report" is also provided to customers upon request. If the defect is not caused by ADVANTECH design or manufacturing, customers will be charged US\$60 or US\$120 for in-warranty or out-of-warranty repair analysis reports respectively.

5.2.2.5 Custody of Products Submitted for Repair

ADVANTECH will retain custody of a product submitted for repair for one month while it is waiting for return of a signed P/I or payment (A/R). If the customer fails to respond within such period, ADVANTECH will close the case automatically. ADVANTECH will take reasonable measures to stay in proper contact with the customer during this one month period.

5.2.2.6 Shipping Back to Customer

The forwarding company for RMA returns from ADVANTECH to customers is selected by ADVANTECH. Per customer requirement, other express services can be adopted, such as UPS, FedEx and etc. The customer must bear the extra costs of such alternative shipment. If you require any special arrangements, please indicate this when shipping the product to us .

ADVANTECH

Enabling an Intelligent Planet

www.advantech.com

Please verify specifications before quoting. This guide is intended for reference purposes only.

All product specifications are subject to change without notice.

No part of this publication may be reproduced in any form or by any means, electronic, photocopying, recording or otherwise, without prior written permission of the publisher.

All brand and product names are trademarks or registered trademarks of their respective companies.

© Advantech Co., Ltd. 2013