

User Manual

DLT-V72 Series

Industrial Computer

ADVANTECH **DLOG**

**IMPORTANT:**

For safe and proper use, follow these instructions.

Keep them for future reference.

Manual version

Manual version: V2.74

Completed on: November 19, 2021

Revision history (starting from DLT-V72 Facelift 2019):

| Version | Date | Manual modifications |
|----------------|--------------------|--|
| V2.60 | September 12, 2019 | Description of new Facelift models DLT-V7210 KD and DLT-V7212 P+. Description IGX Tool updated. |
| V2.70 | January 2, 2020 | Description of Sticky key feature for DLT-V7210 K and KD. Description IGX Tool updated. Manual layout modifications. |
| V2.71 | February 26, 2021 | Update: Radio card SPARKLAN WPEQ-261ACN (BT) supports Bluetooth Type 5.0. Description of MPair application added. Description of Sparklan WLAN driver added. |
| V2.72 | June 15, 2021 | Description of IGX Driver and Tool updated. |
| V2.73 | July 23, 2021 | DeviceOn/iService support added. |
| V2.74 | November 19, 2021 | Description of the new DLT-V7215 P+ added. |

Copyright

This document and the software and hardware included with this product are copyrighted 2019-2021 by Advantech Co., Ltd. All rights are reserved. This document is intended for reference purposes only. All product specifications are subject to change without notice. Advantech Co., Ltd. reserves the right to make improvements in this document in the products described in this document at any time without notice. No part of this document may be reproduced in any form or by any means, electronic, photocopying, recording, translating, transmitting or otherwise, without prior written permission of Advantech Co., Ltd. Information provided in this document is intended to be accurate and reliable. However, Advantech Co., Ltd. assumes no responsibility for its use, nor for any infringements of the rights of third parties, which may result from its use.

Advantech Co., Ltd. assumes no liability for technical inaccuracies, typographic errors or faults in this documentation. Advantech Co., Ltd. also assumes no liability for damages caused directly or indirectly by the delivery, performance or usage of this material.

Note regarding all links and website content included in this document:

Advantech Co., Ltd. is not responsible for the accessibility of the websites and for the content of external links contained in this document. The content and accessibility of the linked websites are the sole responsibility of their operators.

Acknowledgements

The software and hardware designations as well as the brand names used in this documentation are in most cases also registered trademarks and are subject to the international law (trademark, brand and patent-protection laws). All product names or trademarks are properties of their respective owners.

Windows® is a registered trademark of Microsoft Corporation in the United States (US) and other countries.

Bluetooth® is a registered trademark of Bluetooth SIG, Inc. (Special Interest Group).

Android™ is a registered trademark of Google LLC.

Intel® and Pentium® are registered trademarks of Intel Corp.

RAM® and RAM Mount™ are both trademarks of National Products Inc., 1205 S. Orr Street, Seattle, WA 98108.

DLT-V72 Industrial Computers can be delivered with or without preinstalled software. For devices with preinstalled software observe the associated license agreements.

FreeRTOS™ is a registered trademark of Real Time Engineers Ltd (<http://www.freertos.org>).

This product uses FreeRTOS. FreeRTOS is licensed with a modified GNU GPL:

<http://www.freertos.org/a00114.html>

The FreeRTOS source text is available from:

<http://sourceforge.net/projects/freertos/files/FreeRTOS/V7.4.0/> or from Advantech.

Manufacturer

Advantech Co., Ltd.

No. 1, Alley 20, Lane 26, Rueiguang Road, Neihu District, Taipei 11491, Taiwan, R.O.C.

Simplified EU declaration of conformity

The manufacturer:

Advantech Co., Ltd.

No.1, Alley 20, Lane 26, Rueiguang Road, Neihu District, Taipei 11491, Taiwan, R.O.C.

The importer:

Advantech Service-IoT GmbH

Industriestrasse 15, 82110 Germering, Germany

Hereby declare that the following products

Product name: Industrial Computer

Model name: DLT-V72XXXXXXXXXXXXXXXX

Comply with the provisions of the applicable EU directives, including their amendments applicable at the time of the declaration. For getting the detailed declarations of conformity please visit our websites and contact your regional person in charge: www.advantech.com / www.advantech.eu / www.advantech-service-iot.eu

Technical customer support

Contact your distributor, sales representative, or an Advantech Service Center for technical support.

Please have the following information ready:

- Product name
- Serial number
- Description of your peripheral attachments
- Description of your software (operating system, application software, etc.)
- The exact wording of any error messages
- A complete description of the problem

Find the contact data of our Global Advantech Service Centers on our website:

<http://erma.advantech.com>

Initial inspection

Before setting up the system, check that the items listed below are included and in good condition. If any item does not accord with the table, please contact your dealer immediately:

- DLT-V72 Industrial Computer
- Cable cover and cable sealing set
- Product supplement
- Possibly “OS End User License Agreement” (depends on optional OS type)

If any of these items are missing or damaged, contact your distributor or sales representative immediately. We have carefully inspected the device mechanically and electrically before shipment. It should be free of marks and scratches and in perfect working order upon receipt.

1. As you unpack the device, check it for signs of shipping damage. For example: box damage, scratches, dents, etc.
2. If it is damaged or it fails to meet the specifications, notify our service department or your local sales representative immediately.
3. Also, please notify the carrier. Retain the shipping carton and packing material for inspection by the carrier.

After inspection, we will make arrangements to repair or replace the unit.

A message to the customer

We want you to get the best performance possible from your products. If you run into technical difficulties, we are here to help. For the most frequently asked questions, you can easily find answers in your product documentation. These answers are normally a lot more detailed than the ones we can give over the phone.

Please consult this manual first. If you still cannot find the answer, gather all the information or questions that apply to your problem, and with the product close at hand, call your dealer. Our dealers are well trained and ready to give you the support you need to get the most from your Advantech products. In fact, most problems reported are minor and can be easily solved over the phone.

In addition, free technical support is available from Advantech engineers every business day. We are always ready to give advice about application requirements or specific information on the installation and operation of any of our products.

Contents

| | |
|---|-----------|
| 1. Introduction | 10 |
| 1.1. About the DLT-V72 manuals | 11 |
| 1.1.1. Manuals for all DLT-V72 models | 11 |
| 1.1.2. Further available manuals | 12 |
| 1.1.3. Abbreviations used | 12 |
| 1.1.4. Design elements used in the manuals | 13 |
| 1.1.5. Text formatting conventions | 14 |
| 2. Safety Chapter | 15 |
| 2.1. Please read and observe | 16 |
| 2.2. Requirements for commissioning and operating personnel | 16 |
| 2.3. Battery pack safety | 17 |
| 2.4. HF Radiation | 18 |
| 2.5. Information on safe mounting | 19 |
| 2.6. Information on safe electrical installation | 20 |
| 2.7. Safety during ongoing work operations | 21 |
| 2.8. Regular maintenance work | 22 |
| 2.9. Repairs, modifications | 22 |
| 2.10. Recycling information | 23 |
| 3. Functional Description | 24 |
| 3.1. Intended use | 25 |
| 3.2. Mount, operate and service the device correctly | 26 |
| 3.3. Device identification / product label | 26 |
| 4. Unpacking, Storing | 27 |
| 4.1. Packing list | 28 |
| 4.2. Unpacking | 28 |
| 4.3. Transport | 28 |
| 4.4. Storage | 29 |
| 5. Technical Data – Device | 30 |
| 5.1. General | 31 |
| 5.2. Environmental conditions | 34 |
| 5.3. Device dimensions | 35 |
| 5.3.1. DLT-V7210 P, R, D | 35 |
| 5.3.2. DLT-V7212 P, R, D | 35 |
| 5.3.3. DLT-V7210 K, KD | 36 |
| 5.3.4. DLT-V7212 P+ | 36 |
| 5.3.5. DLT-V7215 P+ | 37 |
| 5.3.6. VESA drill holes | 37 |
| 5.4. Integrated power supply, power supply cable | 38 |
| 5.4.1. DC voltage supply connection | 39 |
| 5.4.2. DC Power supply cable | 40 |

6. Technical Data – Radio.....41

| | | |
|--------|---|----|
| 6.1. | Identification of radio equipment variants..... | 42 |
| 6.2. | Radio cards (optional) | 43 |
| 6.2.1. | Radio card for WLAN: SPARKLAN WPEQ-261ACN (BT)..... | 43 |
| 6.2.2. | Radio card for WWAN: QUECTEL EC25 A/E..... | 44 |
| 6.3. | Antennas (optional) | 45 |
| 6.3.1. | WLAN antenna IEEE 802.11 a/b/g/n/ac | 45 |
| 6.3.2. | WLAN, WWAN, LTE 4G antenna (Multiband) | 46 |
| 6.3.3. | External WLAN antenna IEEE 802.11 a/b/g/n | 47 |
| 6.3.4. | External WWAN antenna 2G, 3G, 4G | 48 |
| 6.3.5. | Bluetooth integrated (optional)..... | 49 |
| 6.3.6. | GPS receiver external (optional)..... | 50 |

7. Connectors.....51

| | | |
|--------|--|----|
| 7.1. | Connectors under the cable cover | 52 |
| 7.1.1. | Opening the cable cover | 54 |
| 7.2. | Connectors under the antenna..... | 55 |
| 7.2.1. | Devices with sealing plate | 55 |
| 7.2.2. | Open/close the WLAN antenna IEEE 802.11 a/b/g/n/ac | 57 |
| 7.2.3. | Open/close the WLAN, WWAN, LTE 4G antenna | 59 |

8. Operating the DLT-V72.....62

| | | |
|--------|---|----|
| 8.1. | Safety notes | 63 |
| 8.2. | Switching the DLT-V72 on/off | 64 |
| 8.3. | Operating the touchscreen..... | 65 |
| 8.3.1. | Multi-touch capability | 65 |
| 8.3.2. | Operating the PCT with gloves | 66 |
| 8.4. | Operation elements..... | 67 |
| 8.4.1. | DLT-V72 rear side | 67 |
| 8.4.2. | Front side DLT-V7210 and DLT-V7212: P, R, D | 68 |
| 8.4.3. | Front side DLT-V7212 and DLT-V7215: P+..... | 69 |
| 8.4.4. | Front side DLT-V7210 K, KD | 70 |
| 8.5. | Using the integrated keyboard | 71 |
| 8.5.1. | Language variants | 71 |
| 8.5.2. | Description of specific keys (in all languages) | 71 |
| 8.5.3. | Integrated keyboard German (QWERTZ) features | 72 |
| 8.5.4. | Integrated keyboard French (AZERTY) features | 73 |
| 8.6. | Operating states..... | 74 |
| 8.7. | Software keyboard (optional) | 75 |
| 8.8. | Operating the DLT-V72 with UPS | 76 |
| 8.9. | Internal speaker, sound..... | 77 |

9. General Device Configuration78

| | | |
|--------|---|----|
| 9.1. | Operating systems (optional) | 79 |
| 9.2. | MS Windows (optional) | 79 |
| 9.2.1. | General..... | 79 |
| 9.2.2. | Configuring the front keys, automatic shutdown, etc. | 80 |
| 9.2.3. | Energy options and battery pack durability | 80 |
| 9.2.4. | Suppress automatic Win10IoTEnt updates | 81 |
| 9.3. | Linux (optional)..... | 82 |
| 9.4. | ADLoG Android (optional) | 82 |
| 9.5. | Automatic shut down | 83 |

| | | |
|------|--------------------------------|----|
| 9.6. | MPair..... | 85 |
| 9.7. | DeviceOn/iService support..... | 86 |

10. WLAN Configuration.....89

| | | |
|----------|---|-----|
| 10.1. | Safety notes | 90 |
| 10.2. | Preparation work at the factory | 91 |
| 10.3. | OS-specific configuration | 92 |
| 10.4. | Customer-specific WLAN profiles | 93 |
| 10.5. | Windows Zero Configuration (WZC) | 93 |
| 10.6. | Sparklan WLAN driver | 94 |
| 10.6.1. | Area of application | 94 |
| 10.6.2. | Driver download..... | 94 |
| 10.6.3. | After image reinstallation: Driver installation..... | 95 |
| 10.6.4. | “Standard” Driver installation WES7, Win7Pro, Win10IoTEnt | 95 |
| 10.6.5. | Sparklan “Roaming” Setting..... | 98 |
| 10.7. | Sparklan BT driver | 100 |
| 10.7.1. | Area of application | 100 |
| 10.7.2. | Driver download..... | 100 |
| 10.7.3. | After image reinstallation: Driver installation..... | 101 |
| 10.7.4. | “Standard” Driver installation Win10IoTEnt | 101 |
| 10.8. | Advantech WLAN Client Manager (IGX Tool)..... | 105 |
| 10.8.1. | Area of application | 105 |
| 10.8.2. | Program version 1.01 (new features) | 105 |
| 10.8.3. | Program version 1.02 (new features) | 105 |
| 10.8.4. | Driver download..... | 106 |
| 10.8.5. | After image reinstallation: Driver installation..... | 107 |
| 10.8.6. | “Silent” Driver installation WES7 / Win7Pro / Win10IoTEnt | 107 |
| 10.8.7. | “Silent” Driver uninstaller WES7 / Win7Pro / Win10IoTEnt..... | 108 |
| 10.8.8. | Start WLAN Client Manager, Login..... | 109 |
| 10.8.9. | WLAN Client Manager Functions | 112 |
| 10.8.10. | Browse nearby wireless networks..... | 113 |
| 10.8.11. | Roam Management..... | 120 |
| 10.8.12. | Import / Export feature | 127 |

11. WWAN Configuration132

| | | |
|---------|---|-----|
| 11.1. | Safety notes | 133 |
| 11.2. | Preparation work at the factory (delivery status) | 134 |
| 11.3. | SIM card for WWAN (customer-specific)..... | 134 |
| 11.4. | Configuration of Radio card QUECTEL EC25 | 135 |
| 11.4.1. | Establish Internet connection..... | 135 |
| 11.4.2. | Trouble Shooting | 138 |

12. Mechanical Installation.....140

| | | |
|---------|--|-----|
| 12.1. | Safety notes | 141 |
| 12.2. | Overview: Recommended mounting sequence..... | 141 |
| 12.2.1. | Mounting the DLT-V72 at the deployment location..... | 142 |
| 12.2.2. | Electrically isolated DLT-V72 mounting | 143 |
| 12.2.3. | Attaching accessories to the DLT-V72 | 144 |
| 12.2.4. | VESA mounting hole pattern | 145 |
| 12.2.5. | Attach the mounting bracket | 146 |
| 12.2.6. | Attach accessories..... | 147 |

13. Electrical Installation148

| | | |
|-------|--------------------|-----|
| 13.1. | Safety notes | 149 |
|-------|--------------------|-----|

| | |
|---|-----|
| 13.1.1. Disconnecting device and emergency-off | 149 |
| 13.1.2. Power cables and fuses | 150 |
| 13.1.3. Observe the potential ratios | 151 |
| 13.2. Preparations | 152 |
| 13.2.1. Material required | 152 |
| 13.3. Procedure | 154 |
| 13.3.1. Inserting the rubber seal in the cable compartment | 154 |
| 13.3.2. Ensure a proper electrical connection | 155 |
| 13.3.3. Plugging in and screwing on the power supply cable | 155 |
| 13.3.4. Secure the power supply cable to the strain relief rail | 156 |
| 13.3.5. Connecting the USB, Ethernet and COM cables | 157 |
| 13.3.6. Close off unused cable openings | 158 |
| 13.3.7. Attach the cable cover | 158 |
| 13.4. Pressure compensation element | 159 |

14. Optional Equipment.....160

| | |
|--|-----|
| 14.1. Integrated UPS (optional) | 161 |
| 14.1.1. Battery pack specifications | 161 |
| 14.1.2. Charging the battery pack | 162 |
| 14.1.3. Replacing the battery pack | 163 |
| 14.2. Screen defroster (optional) | 164 |
| 14.3. Screen blanking (optional) | 165 |
| 14.4. USB recovery stick (optional) | 165 |
| 14.5. Keyboards and keyboard mounts (optional) | 166 |
| 14.6. Scanner and scanner bracket (optional) | 167 |
| 14.7. Touch stylus (optional) | 168 |
| 14.8. Protective film for touchscreen (optional) | 169 |

15. Repairs, Modifications.....170

| | |
|--|-----|
| 15.1. Authorized Advantech Service Centers | 171 |
|--|-----|

16. Maintenance172

| | |
|--|-----|
| 16.1. Regular maintenance work | 173 |
| 16.1.1. General | 173 |
| 16.1.2. Cleaning the device | 173 |
| 16.1.3. Devices used in vehicles | 173 |
| 16.2. Replacing the integrated keyboard | 174 |
| 16.2.1. Remove the integrated keyboard | 174 |
| 16.2.2. Attach the integrated keyboard (example) | 175 |
| 16.3. Replacing the battery pack | 177 |
| 16.4. Replacing the touchscreen protective film | 177 |

17. Troubleshooting178

18. Guidelines and Certificates.....181

| | |
|---|-----|
| 18.1. USA/CANADA: FCC Part 15 Statement | 182 |
| 18.2. ICES Kanada | 183 |
| 18.3. CNROHS | 183 |

19. List of figures184



1. Introduction

1.1. About the DLT-V72 manuals

NOTE  Pay attention to the DLT-V72 manuals because they help avoid hazards, reduce repair costs and downtimes, and increase the reliability and service life of the DLT-V72.

Keep the manuals for future use.

Please contact Advantech if you require additional information or clarification. You can find the contact address in section **Technical Customer Support**.

The latest versions of our manuals are available at our websites:

www.advantech.com

www.advantech-service-iot.eu

1.1.1. Manuals for all DLT-V72 models

The following manuals are available for all DLT-V72 device models:

| Manual type | Contents | For target group | Availability |
|----------------|---|-------------------|-----------------------------------|
| Startup Manual | Safety instructions, First commissioning: mechanical mounting and electrical installation | Skilled personnel | Printed, enclosed with the device |
| User Manual | Complete operating instructions | Skilled personnel | PDF file at our websites |

Startup Manual and User Manual apply to all models of the DLT-V72 Series:

- DLT-V7210 P (PCT)
- DLT-V7210 R (Resistive Touch)
- DLT-V7210 D (Defroster)
- DLT-V7212 P (PCT)
- DLT-V7212 R (Resistive Touch)
- DLT-V7212 D (Defroster)
- DLT-V7210 K (Integrated Keyboard)
- DLT-V7210 KD (Integrated Keyboard and Defroster)
- DLT-V7212 P+ (PCT)
- DLT-V7215 P+ (PCT)

1.1.2. Further available manuals

| Manual | Contents | OS | For target group | Availability |
|---------------------------------|---|------------|-------------------|---|
| ADLoG Config | Software configuration tool description | MS Windows | Skilled personnel | PDF file at our websites |
| ADLoG Linux | OS and configuration | Linux | Skilled personnel | Upon request, please contact our Technical Customer Support |
| Android Nougat 1.xx for DLT-V72 | OS and configuration | Android | Skilled personnel | PDF file at our websites |
| Android 9 2.xx for DLT-V72 | OS and configuration | Android | Skilled personnel | PDF file at our websites |

1.1.3. Abbreviations used

| Term | Abbreviation |
|--------------------------------|--------------|
| Lithium-ion battery pack | Battery pack |
| MS Windows | MS Win |
| MS Windows 10 IoT Enterprise | Win10IoTEnt |
| MS Windows 7 Pro | Win7Pro |
| MS Windows Embedded Standard 7 | WES7 |
| Operating System | OS |
| Uninterrupted Power Supply | UPS |

1.1.4. Design elements used in the manuals

Safety notes and other notices

<Signal word> Damage to persons



Signal word **DANGER** means that death or severe bodily injury will occur if this information is not observed.

Signal word **WARNING** means that death or severe bodily injury can occur if this information is not observed.

Signal word **CAUTION** means that slight bodily injury can occur if this information is not observed.

NOTICE Prevent system malfunction and property damage

Information about possible property damage to avoid damaging hardware or losing data

NOTE Notes provide optional additional information



1.1.5. Text formatting conventions

| Subject | Formatting | Example |
|--|--|--|
| Lists | Bullet points | <ul style="list-style-type: none"> • Part 1 • Part 2 |
| Instructions | Numbers | <ol style="list-style-type: none"> 4. Copy file ... 5. Rename file ... |
| Product names | Normal, not highlighted | Software MDevice is a setup tool for ... |
| Buttons in software dialogues | Bold | With button Next ... |
| Texts, parameters in software dialogues | Bold | Parameter setting ID-Test should be ... |
| Placeholder for a variable | <x> value in angle brackets | Value <x> depends on ... |
| Syntax, Strings | Courier New Size 11 | The AT prefix must be set. |
| Keyboard keys | In capital letters, sequence with + | CTRL + ALT + DEL |
| Cross reference to other manual chapters | Text in <i>italics</i> , <u>underlined</u> | Please refer to manual section <u>1.1 Examples</u> |
| Program files File names Directories | In quotation marks | File "quectel.exe" ... In directory "C:/Program Files" |
| Links | Underlined, blue | Website https://advantech.eu |

2. Safety Chapter

2.1. Please read and observe.

These safety instructions apply to all device models in the DLT-V72 Series: For DLT-V7210, DLT-V7212 and DLT-V7215 in various equipment levels.

WARNING



Non-observance of the safety instructions can result in injury to persons and in physical damage, e.g. due to incorrect commissioning procedures or due to maintenance work not being completed. The manufacturer accepts no liability for damage resulting from a failure to comply with this information.

1. *Read and observe these safety instructions before commissioning and using the DLT-V72. This protects you and other persons and prevents damage to the equipment and to technical equipment in the surrounding environment.*

2.2. Requirements for commissioning and operating personnel

Work such as commissioning and maintaining the DLT-V72 is only permitted to be performed by skilled personnel who have specialist vocational training and who have up-to-date knowledge and experience in the area of work in question.

Examples:

- Mechanical mounting work must be performed by skilled mechanical personnel.
- If the DLT-V72 is incorrectly mounted onto vehicles, for example, this can result in serious accidents.
- Electronic work on the DLT-V72 must be performed by skilled electronics personnel; there is a risk of electric shock when connecting to the power supply, for example.
- For the DLT-V72 with integrated UPS, specialist knowledge on the handling of battery packs is required.

Requirements for the operating personnel

Users of the DLT-V72 must be trained by skilled personnel and instructed in the operation of the device. All users must be familiar with all functions of the product they come into contact with.

2.3. Battery pack safety

The DLT-V72 is optionally available with an integrated UPS. The battery pack of the UPS is located in the battery pocket of the device:



Fig. 2.1: Battery pocket with UPS DLT-V72

EXPLOSION HAZARD! BATTERY PACK SAFETY NOTICE

Battery packs may ignite if stored or handled incorrectly (fire risk, explosion risk), and may cause chemical burns or release poisonous substances.

1. Handle the DLT-V72 and the integrated battery pack with care, and do not allow it to become damaged, to fall or be dropped, or be short-circuited.
2. Do not tamper with, disassemble or repair the battery packs.
3. Observe the specified temperature range, both during storage and in the work environment.
4. Do not utilize the device near sources of heat or fire, open flames or heaters.
5. Do not allow water or other liquids to come into contact with the device (exercise particular caution with corrosive liquids).
6. Suitable fire extinguishers must be provided in line with safety regulations.
7. If battery packs become damaged, caustic electrolyte liquid may leak out. This liquid must not under any circumstances be permitted to come into contact with eyes, skin or clothing. On contact with eyes or skin, rinse immediately with clear, running water and consult a doctor.

THERE IS A RISK OF EXPLOSION IF THE BATTERY PACK IS SWAPPED OUT AND REPLACED WITH AN INCORRECT/NON-APPROVED BATTERY PACK.

This also applies to the real time clock battery installed in the DLT-V72.

Do not open the DLT-V72, and do not replace the RTC battery.

No third-party battery packs permitted.

1. Use only original battery packs from Advantech. If battery packs from other manufacturers are inserted in the DLT-V72, the warranty for this device will be rendered void.
2. The battery packs must be certified for the DLT-V72.
3. Do not use battery packs from any other Advantech devices; they are not compatible.

Prevent physical damage due to deep discharge.

Storing the battery packs incorrectly will cause them to discharge completely (deep discharge) and thus damage them irreparably.

To prevent a deep discharge:

1. Remove the battery pack from the battery pocket, if the DLT-V72 is not used for a longer period of time (more than one month).
2. Charge the battery pack in the DLT-V72 device every six months.

2.4. HF Radiation

Only applies to devices with radio equipment: Danger of radiation.

DLT-V72 devices with radio equipment emit high frequency energy (abbreviation: HF).

To protect persons and domestic animals against HF radiation:

1. Mount the DLT-V72 so that persons and domestic animals maintain a minimum distance of 20 to 50 cm from the radio antennas.
2. Ensure that persons observe this minimum distance when operating the DLT-V72.
3. High frequency energy can interfere with technical devices. For this reason, do not use the DLT-V72 in the vicinity of pacemakers or other medical devices.
4. Only operate the DLT-V72 with radio equipment that is approved by the manufacturer for this device.
5. Make sure that the transmission power and the radio frequency of the DLT-V72 comply with the regulations for the respective country where the device is deployed.
6. Observe all applicable regulations for your deployment location/country with regard to operating channels, radio frequencies and the maximum permissible transmitting power. Responsibility for this lies with the company operating the DLT-V72. The regulatory authorities in the relevant country can provide information on this.

Any modifications to the DLT-V72 radio equipment which are not expressly approved by the party responsible for the compliance can lead to the withdrawal of the operating license for this device.

2.5. Information on safe mounting

During the mounting process

The DLT-V72 can fall down and cause injuries due to its weight.

1. Use the assistance of a second person for installation work.
2. Always hold the DLT-V72 by the housing with both hands.
3. Never use the antenna cap as a handle as it may break due to the weight involved.

The strain relief rail of the DLT-V72 can have sharp edges and cause cutting injuries.

1. Do not hold the DLT-V72 by the strain relief rail.

Choosing the mounting position and installation environment

The installation height of the device shall not exceed 2 m.

1. The ergonomic operability of the DLT-V72 should be taken into account when selecting the mounting position.
2. Mount the DLT-V72 in such a way that no persons can be injured if the device mounting should break (e.g. as a result of a fatigue fracture).
3. Otherwise, it is essential to adopt corresponding safety measures.
4. Ensure that the installation environment is correct, as is not permitted to result in an enclosed system because the cooling concept of the DLT-V72 requires fresh air. Without a supply of fresh cooling air, the DLT-V72 may overheat and may be damaged beyond repair.

Specific information on vehicle mounting (forklifts, etc.)

1. Mount the DLT-V72 so that the driver's field of view remains clear and safe driving operation is guaranteed.
2. During the mounting process, observe the requirements of the vehicle manufacturer relating to attaching auxiliary devices and connecting auxiliary consumers.
3. Observe all requirements relating to welding or drilling on support components of the vehicle.

2.6. Information on safe electrical installation

Danger of electric shock

1. Do not put the DLT-V72 into operation if it is showing damage.
2. Do not open or modify the DLT-V72.
3. Only connect or disconnect electrical connections when the device is in a de-energized state.
4. Use only original Advantech power supply cables; these meet the specific requirements for low-temperature flexibility, UV resistance, oil resistance, etc.

Installing the disconnecting device

The DLT-V72 is not equipped with disconnecting devices that are accessible from the outside; it does not have switches.

1. To allow the device to be quickly disconnected from the power supply in emergency situations, install an easily accessible disconnecting device close to the device and ensure that the disconnecting device isolates all supply lines.

Fuses

2. Only connect DLT-V72 devices to Safety Extra Low Voltage (SELV) circuits.
3. The DC+ connecting cable must be protected by a fuse (30 AT max.).
4. The ignition connecting cable must be protected by a fuse of the following type:
5x20 mm T 125 mA L / 250 V, for example, a Wickmann 195-125 mA / 250 V.

Power supply unit fuse blows repeatedly

If the fuse of the integrated power supply unit blows again immediately after replacement, proceed as follows:

1. Check the electrical installation.
2. If it's excluded that a faulty installation causes the problem: Send in the DLT-V72 immediately for repair.

2.7. Safety during ongoing work operations

Users of the DLT-V72 must be trained by skilled personnel and instructed in the operation of the device. All users must be familiar with all functions of the product they come into contact with.

General

1. Do not use the DLT-V72 in explosion hazard areas.
2. Switch off the DLT-V72 if located in the vicinity of petrol stations, fuel depots, chemical plants, etc.
3. Switch off the DLT-V72 before using the interfaces underneath the antenna.
4. Switch off the DLT-V72 before replacing the battery pack.

The following applies when using the DLT-V72 on vehicles:

The vehicle driver is not permitted to operate the DLT-V72 while driving. Operating the device can represent a distraction from driving operations and there is an increased risk of accident.

The DLT-V72 must be disconnected from the vehicle battery while the vehicle battery is being charged. Or it must be ensured that the maximum permitted input voltage of the DLT-V72 is not exceeded.

2.8. Regular maintenance work

Please read manual section 16 Maintenance.

2.9. Repairs, modifications

Only authorized Advantech Service Centers may perform the following:

- Open the device (front unit and base unit)
- Repairs
- Modifications
- Replace integrated modules, e.g. radio cards

The device operator may perform the following (only qualified skilled personnel):

- Opening/closing the antenna cap (e.g. for replacing CFast card and SIM card)
- Opening/closing the cable cover
- Opening/closing the battery pocket to replace the battery pack
- Replacing the integrated keyboard of the DLT-V7210 K, KD versions

The legal warranty shall apply. It expires if the customer performs measures on the device that are only permitted to be performed by Advantech Service Centers.

Accessories and peripherals

Accessories and peripherals may only be installed or integrated if expressly approved by Advantech for the respective DLT-V72. If other parts are attached or installed and connected, claims for warranty and / or product liability will be lost.

THERE IS A RISK OF EXPLOSION IF THE BATTERY PACK IS SWAPPED OUT AND REPLACED WITH AN INCORRECT/NON-APPROVED BATTERY PACK.

2.10. Recycling information



Fig. 2.2: Recycling information icons

DLT-V72 devices and lithium-ion batteries are recyclable; they may not be disposed of with general/domestic waste. They must be disposed of properly in accordance with local regulations. Please contact the responsible authorities in your country/region to find out about the applicable regulations for proper disposal, if necessary.

3. Functional Description

3.1. Intended use

DLT-V72 Industrial Computers are data communication terminals for use in commercial industries such as logistics, warehousing and manufacturing. Any other or additional use beyond this is regarded as improper use.

DLT-V72 Industrial Computers are only permitted to be operated:

- In accordance with the defined intended use.
- Within the usage limits and in accordance with the technical data.
- Observing the information in the documentation and in particular the safety and warning notices.

DLT-V72 Industrial Computers:

- Are not approved for use in explosion-hazard areas.
- Are not approved for use on ships.
- Are not approved for use on rail vehicles.
- Are not approved for use in life-support systems or critical safety systems where system malfunction can lead to the direct or indirect hazard of human life.

DLT-V72 Industrial Computers were designed and built according to modern technology and accepted safety regulations. Improper use can result in injury to persons and in property damage, however, necessitating the following:

- Correct transport, storage, commissioning and maintenance as specified
- Operation by trained personnel

Accessories

Only use accessories that have been tested and certified for the respective DLT-V72.

Requirements for safe operation

- Proper transport and storage
- Proper setup and use
- Proper maintenance and service
- Operation by trained personnel

3.2. Mount, operate and service the device correctly

DLT-V72 Industrial Computers were designed and built according to modern technology and accepted safety regulations. However, the operation of the DLT-V72 can endanger personnel or third parties and cause damage to the device and other material assets when, for example, the device is

- Installed incorrectly or configured improperly
- Operated by untrained or uninstructed personnel
- Improperly operated and maintained
- Not used as intended

The owner/operator commitments with regards to safety (accident prevention regulations, occupational safety) are to be followed.

3.3. Device identification / product label

The name plate on the rear side of the DLT-V72 must be legible at all times.

Do not damage the name plate or remove it from the device.

Information on the labels on the device (examples):

- Model name
- Serial number
- FCC ID (Radio)
- Barcode (for Advantech-internal use only)

4. Unpacking, Storing

4.1. Packing list

Before setting up the system, check that the items listed below are included and in good condition. If any item does not accord with the table, please contact your dealer immediately:

- DLT-V72 Industrial Computer
- Cable cover and cable sealing set
- Product supplement (Startup Manual; possibly “OS End User License Agreement”)

4.2. Unpacking

1. Open the packaging carefully to prevent damaging the device inside.
2. Save the packaging material (for possible forwarding transports or returns of the DLT-V72).
3. Check the shipment for completeness and any possible damage.
4. Always keep the supplied manuals and documents.

4.3. Transport

WARNING



Risk of personal injury due to weight and sharp-edged parts

The DLT-V72 can fall down and cause injuries due to its weight.

The strain relief rail can have sharp edges and cause cutting injuries.

1. *Always hold the DLT-V72 by the housing with both hands.*
2. *Never use the antenna as a handle. It can break due to the weight involved.*
3. *Do not hold the DLT-V72 by the strain relief rail.*
4. *Use the assistance of a second person for installation work.*

4.4. Storage

WARNING***Personal injury from integrated UPS battery pack: Short-circuit, fire, chemical burns, toxic substances***

Some DLT-V72 devices contain an integrated UPS with a battery pack (hereinafter referred to as “battery pack”). These can ignite (risk of fire), cause chemical burns or release toxic substances.

- 1. Observe manual section 2 Safety Chapter regarding DLT-V72 devices with integrated UPS.*
- 2. Store battery packs separately from acids and other materials.*
- 3. Store the DLT-V72 and accessories in a cool and dry location and comply with the specified storage temperature and air humidity.*
- 4. Provide for sufficient ventilation of the storage location.*
- 5. Do not store the device near sources of heat or fire, open flames or heaters.*

Protecting touchscreens during storage

1. Protect touchscreens from sharp edges, impacts, and heavy objects.
2. If stacking, do not stack higher than four devices.
3. Place devices front-to-front in this case. The VESA mounting point on the rear side of the device can damage the touchscreen of another device.
4. Use protective material (non-flammable!) between the devices as a precaution.

5. Technical Data – Device

5.1. General

NOTE *The latest status of technical data is available in the DLT-V72 data sheets at our websites.*



CPU

| | |
|-------------------------|---|
| CPU Chipset Cache | Intel® ATOM™ E3845 Quad Core 1.91 GHz Processor Dual channel 1333 MHz memory bus speed 2 MB L2 cache, 22 nm |
| RAM | 4 GB RAM DDR3L Technology |
| BIOS | AMI Aptio UEFI; ACPI 5.0 compliant |
| Real-time clock | Real-time clock with a power reserve of up to 5 years |
| CFast | 4 GB and more CFast memory card |

Weight (without accessories, antenna, battery pack), material

| | |
|---------------------|--|
| DLT-V7210 P / R / D | Approx. 3.6 kg |
| DLT-V7212 P / R / D | Approx. 4.6 kg |
| DLT-V7210 K / KD | Approx. 3.7 kg |
| DLT-V7212 P+ | Approx. 3.7 kg |
| DLT-V7215 P+ | Approx. 5.4 kg |
| Battery pack | Approx. 0.15 kg |
| Material | Rugged aluminum-cast housing, ESD safe |

Display

| | |
|-----------------------------|--|
| DLT-V7210 | 10.4" XGA color TFT 1024 x 768 resolution 400 cd/m ² brightness |
| DLT-V7212 | 12.1" XGA color TFT 1024 x 768 resolution 500 cd/m ² brightness |
| DLT-V7210 K DLT-V7210 KD | 10.1" widescreen WXGA color TFT 1280 x 800 resolution 500 cd/m ² brightness |
| DLT-V7212 P+ | 12.1" XGA color TFT 1024 x 768 resolution 600 cd/m ² brightness |

Display

| | |
|--------------|--|
| DLT-V7215 P+ | 15" XGA color TFT 1024 x 768 resolution 600 cd/m ² brightness |
|--------------|--|

The LCD display of the DLT-V72 series fulfills the highest quality standards and was inspected for pixel defects. However, due to technological reasons pixel defects can occur. This is not a malfunction; it is a part of the technical specifications.

NOTICE **Prevent system malfunction and property damage**

The display of the DLT-V72 has to be protected from the burning in of a motionless image. An image that has remained motionless for too long can cause irreversible damage to the display.

Recommendation:

1. *Use a screensaver.*
2. *In the power management, set the display to turn off when there is no user input.*

Resistive touchscreen

| | |
|-----------------------|--|
| Type | 5-wire analog resistive touchscreen |
| Construction | Film-Film-Glass (FFG) Fully laminated front |
| Surface | Hardness JIS-K-5400: 2H/3H at 750 g Chemically hardened glass |
| Resistance | Shock resistance IK08 |
| Mechanical resistance | Tapping: > 1 million times with rubber test pen Swiping: > 100,000 times with polydactyl pen |
| Chemical resistance | Alcohols, Dilute Acids, Dilute Alkalis, Esters, Hydrocarbons, Ketones, Household Cleaning agents (according to DIN 42 115) |

Projected-capacitive touchscreen (PCT)

| | |
|-----------------------|--|
| Type | Projected-capacitive touchscreen |
| Construction | Glass film |
| Surface | Hardness JIS-K-5400: > 10 H at 750 g Chemical AR coated glass: DLT-V7210 P and DLT-V7212 P gloss value 85 at 60° DLT-V7210 K, KD and DLT-V7212 P+ gloss value 70 at 60° DLT-V7215 P+ gloss value 80 at 60° (According to ISO 2813, 7668; ASTM D 523, D 2457; DIN 67539) |
| Resistance | Shock resistance IK08 |
| Mechanical properties | Thermally pre-stressed, acid-frosted float glass |
| Chemical resistance | Alcohols, Dilute Acids, Dilute Alkalis, Esters, Hydrocarbons, Ketones, Household Cleaning agents (according to DIN 42 115) |

5.2. Environmental conditions

DLT-V72 without integrated UPS

| | | |
|---|---|--|
| Operating temperature | -30 to +50 °C Specification according to EN 60068-2-1/2 | |
| Storage temperature | -30 to +65 °C Specification according to EN 60068-2-1/2 | |
| Relative humidity | 10% to 90% at 40 °C relative humidity Noncondensing Specification according to EN 60068-2-3 | |
| Mechanical vibration and shock resistance | Class 5M3 according to EN 60721-3-5 US Highway Truck according to MIL-STD 810F | |
| IP protection class | IP65 and IP66 for: DLT-V7210 DLT-V7212 DLT-V7212 P+ DLT-V7215 P+ | IP65 for: DLT-V7210 K DLT-V7210 KD |

DLT-V72 with integrated UPS (optional)

| | | |
|---|---|--|
| Operating temperature | -30 to +50 °C Specification according to EN 60068-2-1/2 | |
| Storage temperature | -30 to +60 °C Specification according to EN 60068-2-1/2 | |
| Charging temperature | -10 to +50 °C (ambient temperature) | |
| Relative humidity | 10% to 90% at 40 °C relative humidity Noncondensing Specification according to EN 60068-2-3 | |
| Mechanical vibration and shock resistance | Class 5M3 according to EN 60721-3-5 US Highway Truck according to MIL-STD 810F | |
| IP protection class | IP65 and IP66 for: DLT-V7210 DLT-V7212 DLT-V7212 P+ DLT-V7215 P+ | IP65 for: DLT-V7210 K DLT-V7210 KD |

5.3. Device dimensions

5.3.1. DLT-V7210 P, R, D

Dimensions without add-ons (in mm)

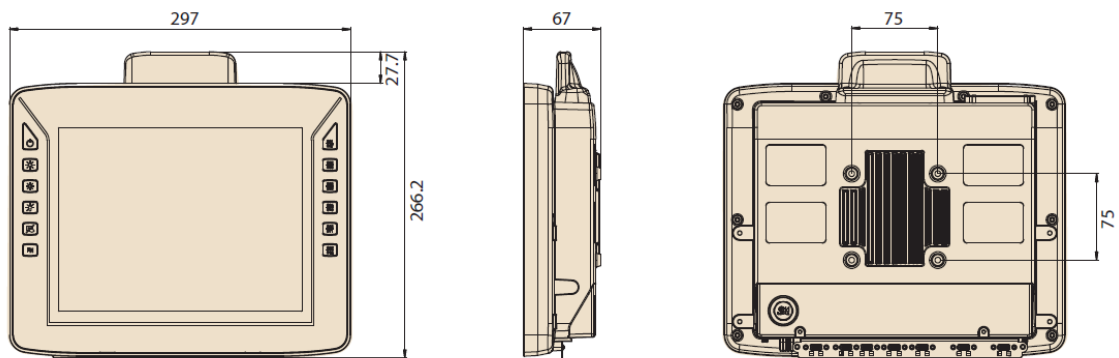

Fig. 5.1: Dimensions DLT-V7210 P, R, D (in mm)

5.3.2. DLT-V7212 P, R, D

Dimensions without add-ons (in mm)

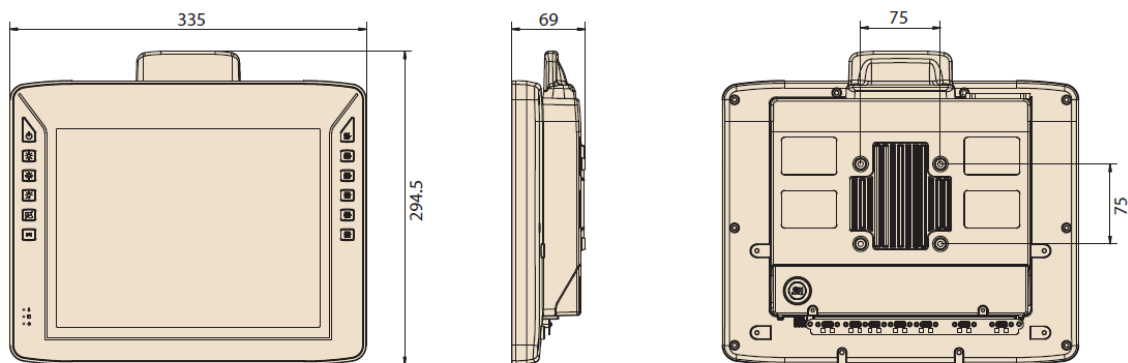

Fig. 5.2: Dimensions DLT-V7212 P, R, D (in mm)

5.3.3. DLT-V7210 K, KD

Dimensions without add-ons (in mm)

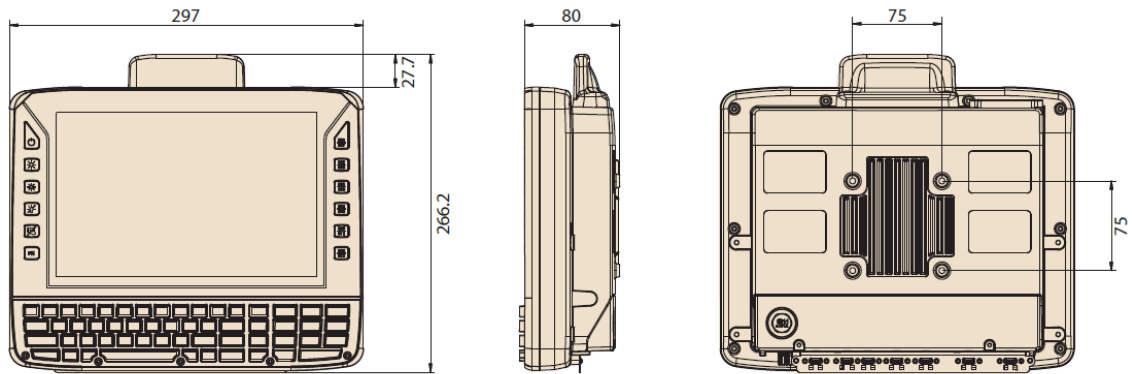

Fig. 5.3: Dimensions DLT-V7210 K, KD (in mm)

5.3.4. DLT-V7212 P+

Dimensions without add-ons (in mm)

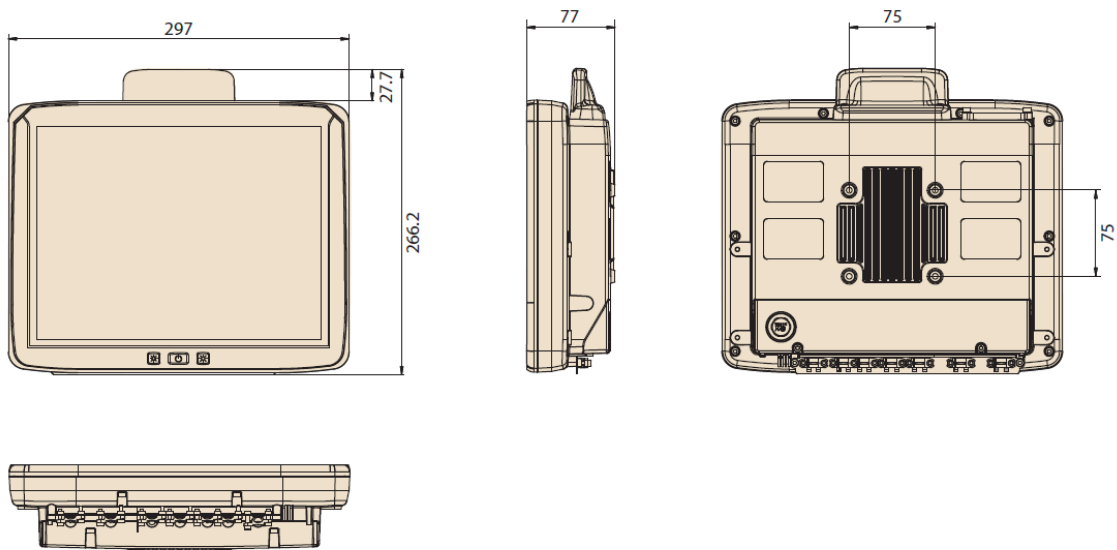

Fig. 5.4: Dimensions DLT-V7212 P+ (in mm)

5.3.5. DLT-V7215 P+

Dimensions without add-ons (in mm)

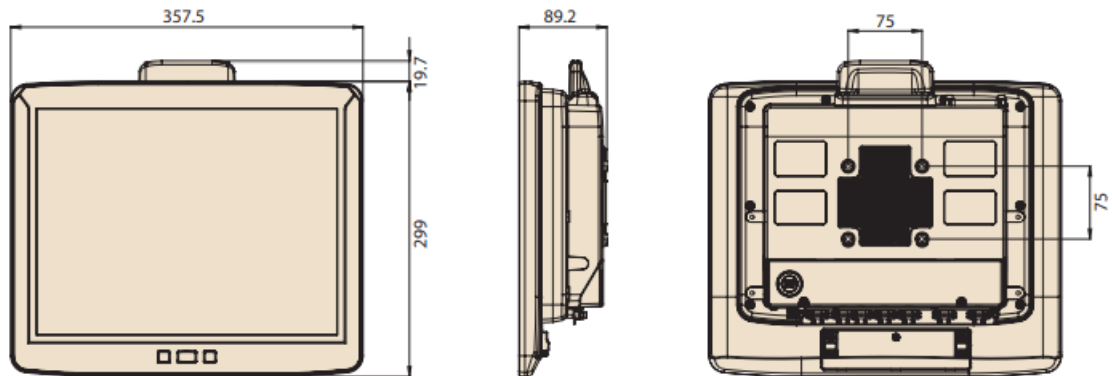

Fig. 5.5: Dimensions DLT-V7215 P+ (in mm)

5.3.6. VESA drill holes

The back of the DLT-V72 has a VESA-compatible 75 x 75 mm mounting hole pattern.

It is used to attach VESA-compatible mountings to mount the DLT-V72 at the deployment location.

Depth of thread: M6 x 6mm

Please observe the mounting information in manual chapter:

[12.2.4 VESA mounting hole pattern](#)

5.4. Integrated power supply, power supply cable

DLT-V72 is equipped with a galvanically separated, integrated DC power supply unit.

Power is connected to the back of the unit using a Phoenix Contact plug. There is no power switch.

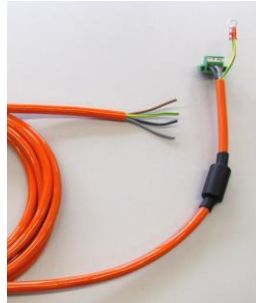

Fig. 5.6: DC Power supply cable with Phoenix Combicon, 3-pin

Power supply

| | |
|---|---|
| DC power pack 12/24/48 VDC (wide-range power supply unit) 60 W / 80 W internal Type DC-16 | 12/24/48 VDC nominal Galvanically isolated Withstands bursts up to 2 kV Full output power of the 12/24/48 VDC power supply unit for 20 seconds each: For 6 V: 40 W For 9 V: 60 W Rising in linear fashion between the above |
| Voltage range | 9 to 60 VDC |
| Bridged power failures | Typically 2 ms at 12 V Typically 10 ms at 24 V Typically 40 ms at 48 V |
| Maximum output power | 60 W (+10 to +70 °C internal device temperature); or 80 W (-30 to +10 °C internal device temperature) |
| Nominal current | 8.4 A |

Connection to SELV circuit only. The SELV circuit is a secondary circuit that is designed and protected so that its voltages will not exceed a safe value both when operating correctly or if a single error occurs.

Power consumption

| | |
|-----------------------------|---------------------------------------|
| DLT-V7210 (all model types) | Typically 25 W; Standby typically 1 W |
| DLT-V7212 (all model types) | Typically 30 W; Standby typically 1 W |
| DLT-V7215 P+ | Typically 30 W; Standby typically 1 W |

Power supply unit fuses

| Power supply unit | Fuse type | Example |
|-------------------|---------------------------------|---|
| DC-16 | 5 x 20 mm T 12,5 A H / 250 V | Schurter 0001.2515 Siba 179200.12,5 or similar produced by other manufacturers |

The symbol for the fuse is **FA**. You will find the exact position on the sticker located on the connection plate of the DLT-V72.

5.4.1. DC voltage supply connection

Version: Phoenix Combicon, 3-pin.

External view:

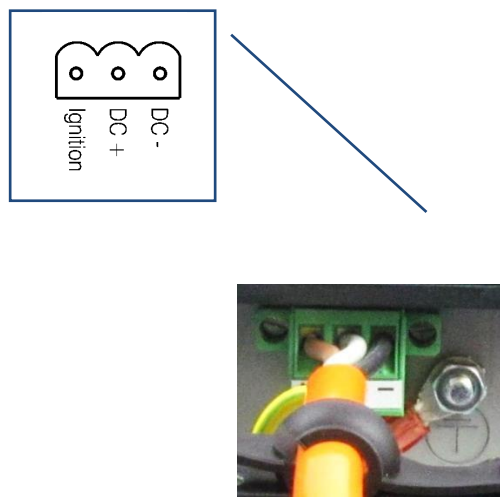

Fig. 5.7: DC power supply connector with connector detail view

Explanation: “Ignition on” means that a control signal can be routed to this connection (e.g., ignition of a vehicle), that matches the supply voltage level and is able to supply at least 1 W to the DLT-V72.

The signal reference is DC-.

5.4.2. DC Power supply cable

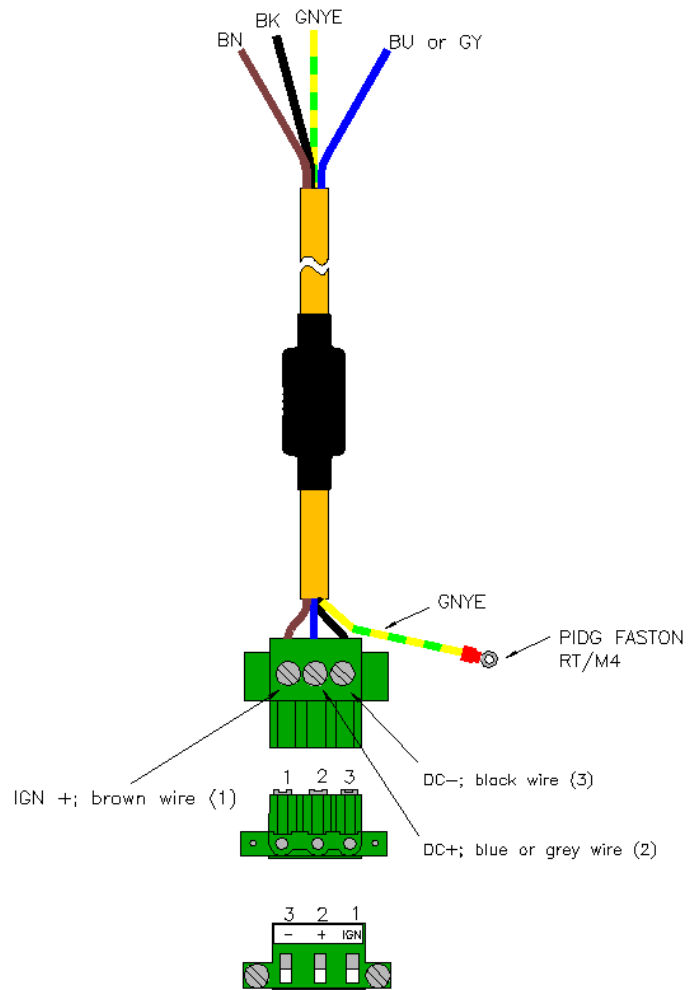

Fig. 5.8: DC connection cable assignment

6. Technical Data – Radio

6.1. Identification of radio equipment variants

The DLT-V72 offers numerous radio modules for WLAN, WWAN, GNSS and Bluetooth. This radio modules are available as options and are not included in the standard scope of delivery of the DLT-V72 device.

To identify the modules installed in your device, proceed as follows:

1. Read off the FCCID on the device name plate/label and compare with the technical data on the following pages.
2. Or open the **Device Manager** to determine the name of the radio card, for example.

6.2. Radio cards (optional)

NOTICE **Prevent system malfunction and property damage**

DLT-V72 may only be operated with the radio modules described in the following section. Radio cards are located inside the devices and are not accessible from the outside. Only the manufacturer and its authorized service centers may open the device and install / remove it.

6.2.1. Radio card for WLAN: SPARKLAN WPEQ-261ACN (BT)

SPARKLAN WPEQ-261ACN(BT)

| | |
|-----------------------------|---|
| Card type | WLAN PCIe Half-Mini Card |
| Technology | WLAN IEEE802.11 a/b/g/n/ac and Bluetooth (both supported via a single antenna) |
| FCCID | RYK-261ACNBT |
| IC ID | 6158A-261ACBT |
| Band 1: WLAN 2.4 GHz | |
| Frequency range | 2400 to 2485 MHz |
| Frequency band ETSI Europe | 2.4 GHz to 2.483 GHz |
| Channels available | 1 to 13 |
| Supported standards | WLAN IEEE802.11 a/b/g/n/ac and Bluetooth (both supported via a single antenna) |
| Maximum TX power | 100 mW / 20 dBm |
| Band 2: WLAN 5 GHz | |
| Frequency range | 5150 to 5875 MHz |
| Frequency band ETSI Europe | 5.15 GHz to 5.35 GHz 5.47 GHz to 5.725 GHz |
| Channels available | 36 to 165 |
| Supported standards | WLAN IEEE802.11 a/b/g/n/ac |
| Maximum TX power | 100 mW / 20 dBm |

6.2.2. Radio card for WWAN: QUECTEL EC25 A/E

USA: QUECTEL EC25A

Europe: QUECTEL EC25E

| | |
|----------------------------|--|
| Card type | WWAN PCIe Full-Mini Card |
| Technology | WWAN 2G, 3G, 4G cellular bands and GNSS |
| FCCID | FCC ID: XMR201605EC25A (valid for the EC25-A variant) |
| Maximum transmitting power | Class 3 (23dBm±2dB) for LTE FDD Class 3 (23dBm±2dB) for LTE TDD Class 3 (24dBm+1/-3dB) for TD-SCDMA Class 3 (24dBm+1/-3dB) for WCDMA Class E2 (27dBm±3dB) for EDGE 850/900MHz Class E2 (26dBm+3/-4dB) for EDGE 1800/1900MHz Class 4 (33dBm±2dB) for GSM 850/900MHz Class 1 (30dBm±2dB) for GSM 1800/1900MHz |

6.3. Antennas (optional)

6.3.1. WLAN antenna IEEE 802.11 a/b/g/n/ac



Fig. 6.1: WLAN antenna IEEE 802.11 a/b/g/n/ac

Technical data

| | |
|----------------------------|---|
| Application | WLAN a/b/g/n/ac Dual Band with MRC Bluetooth (integrated via Radio card) |
| WLAN frequency range | Band 1: 2400 to 2485 MHz Band 2: 5150 to 5850 MHz |
| Bluetooth features | See section 6.3.5 Bluetooth integrated (optional) |
| Number of antennas | 2 |
| Available color | Red |
| Type | Omnidirectional antenna |
| Antenna gain | Max. 4.44 dBi (without loss through the cable) |
| Impedance | 50 Ω |
| Polarization | Vertical/horizontal |
| Maximum transmitting power | 100 mW / 20 dBm |
| Compatible Radio card: | SPARKLAN WPEQ-261ACN(BT) (see section 6.2.1 Radio card) |

6.3.2. WLAN, WWAN, LTE 4G antenna (Multiband)



Fig. 6.2: WLAN, WWAN, LTE 4G antenna (Multiband)

Technical data

| | |
|----------------------------------|--|
| Application | WLAN IEEE 802.11 ac/a/b/g/n/ac Dual Band with MRC WWAN 4G Bluetooth |
| WLAN frequency range | Band 1: 2400 to 2485 MHz Band 2: 5150 to 5875 MHz |
| WWAN frequency bands with EC25-E | FDD LTE: B1/B3/B5/B7/B8/B20 TDD LTE: B38/B40/B41 WCDMA: B1/B5/B8 GSM: 900/1800 |
| WWAN frequency bands with EC25-A | FDD LTE: B2/B4/B12 WCDMA: B2/B4/B5 |
| Bluetooth features | See section 6.3.5 Bluetooth integrated (optional) |
| Number of antennas | 4 |
| Available color | Red |
| Type | Omnidirectional antenna |
| Antenna gain | WLAN: Max. 5.8 dBi WWAN: Max. 3.5 dBi |
| Impedance | 50 Ω |
| Polarization | Vertical/horizontal |
| Maximum transmitting power | WLAN: 100 mW / 20 dBm WWAN: Class 3 (23dBm \pm 2dB) for LTE FDD Class 3 (23dBm \pm 2dB) for LTE TDD Class 3 (24dBm+1/-3dB) for TD-SCDMA Class 3 (24dBm+1/-3dB) for WCDMA Class E2 (27dBm \pm 3dB) for EDGE 850/900MHz Class E2 (26dBm+3/-4dB) for EDGE 1800/1900MHz Class 4 (33dBm \pm 2dB) for GSM 850/900MHz Class 1 (30dBm \pm 2dB) for GSM 1800/1900MHz |

| | |
|-----------------------|--|
| Compatible WLAN card: | SPARKLAN WPEQ-261 ACN (BT) (see section 6.2.1 Radio card) |
| Compatible WWAN card: | USA: QUECTEL EC25A Europe: QUECTEL EC25E (see section 6.2.2 Radio card) |

6.3.3. External WLAN antenna IEEE 802.11 a/b/g/n



Fig. 6.3: External WLAN antenna

Technical data

| | |
|----------------------------|--|
| Application | WLAN IEEE 802.11 a/b/g/n Dual Band |
| Mounting location | For detached mounting, e.g. on the roof of the forklift |
| WLAN frequency range | Band 1: 2400 to 2485 MHz Band 2: 5150 to 5875 MHz |
| Number of antennas | 1 |
| Type | Omnidirectional antenna |
| Antenna gain | Band 1: Max. 4 dBi (without loss through the cable) Band 2: Max. 6.5 dBi (without loss through the cable) |
| Impedance | 50 Ω |
| Polarization | Vertical/horizontal |
| Dimensions | \varnothing 86 x 43 mm (\varnothing 3.39" x 1.69") |
| Weight | 0.3 kg (0.66 lbs) |
| Connector labeling | N-type or TNC N, Jack, female, bottom RSMA plug for RSMA socket on the terminal |
| Scope of delivery | 3 m antenna cable |
| Maximum transmitting power | 100 mW / 20 dBm |
| Corresponding WLAN card | SPARKLAN WPEQ-261 ACN (BT) (see section 6.2.1 Radio card) |

6.3.4. External WWAN antenna 2G, 3G, 4G



Fig. 6.4: External 2G, 3G, 4G WWAN antenna

Technical data

| | |
|------------------------------------|--|
| Application | WWAN 2G, 3G, 4G cellular bands |
| Mounting location | For detached mounting, e.g. on the roof of the forklift |
| Number of antennas | 1 |
| Type | Omnidirectional antenna |
| Antenna gain | Typically 2.2 dBi |
| Impedance | 50 Ω |
| Polarization | Vertical |
| Dimensions | Height 79.45 mm Diameter 42 mm |
| Cable length | 3 m |
| IP protection | IP67 and IP69K |
| Max. transmitting power of antenna | Class 3 (23dBm \pm 2dB) for LTE FDD Class 3 (23dBm \pm 2dB) for LTE TDD Class 3 (24dBm+1/-3dB) for TD-SCDMA Class 3 (24dBm+1/-3dB) for WCDMA Class E2 (27dBm \pm 3dB) for EDGE 850/900MHz Class E2 (26dBm+3/-4dB) for EDGE 1800/1900MHz Class 4 (33dBm \pm 2dB) for GSM 850/900MHz Class 1 (30dBm \pm 2dB) for GSM 1800/1900MHz |
| Compatible WWAN card: | USA: QUECTEL EC25A Europe: QUECTEL EC25E (see section 6.2.2 Radio card) |

6.3.5. Bluetooth integrated (optional)

Requirement: Use of the radio card **SPARKLAN WPEQ-261ACN (BT)**

- Bluetooth Type 5.0
- Standards: V5.0, V4.2 +HS, V4.0 LE, V3.0+HS, V2.1+EDR
- Transmission rate: 1 Mbps, 2 Mbps, up to 3 Mbps

NOTICE *For full Bluetooth 5.0 SW support you need at least Sparklan driver version v1159 (or higher) in combination with Windows 10 Enterprise (2016, 2019, and 2021).*

For more information on downloading the last available Sparklan WLAN driver see chapter [10.6.2 Driver download](#).

6.3.6. GPS receiver external (optional)

With the optional GPS receiver the DLT-V72 can be used for GPS navigation. The GPS receiver has an integrated antenna for position data of the Global Positioning System and communicates with the DLT-V72 via USB interface.

We recommend using only a GPS receiver approved by Advantech.



Fig. 6.5: External GPS receiver (optional)

Installation

The installation CD supplied with the GPS receiver includes installation files and a multi-lingual manual. Please read the additional information in the manual about the GPS receiver.

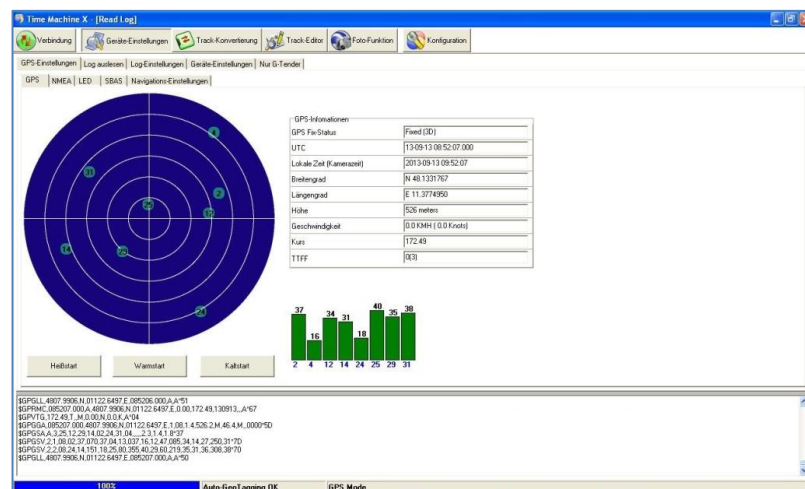
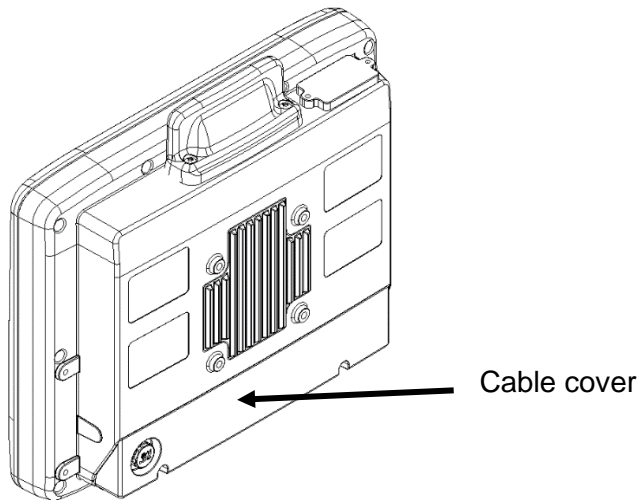

Fig. 6.6: Ext. GPS receiver, display example during installation

7. Connectors

7.1. Connectors under the cable cover



Connectors located on the connector panel under the cable cover:

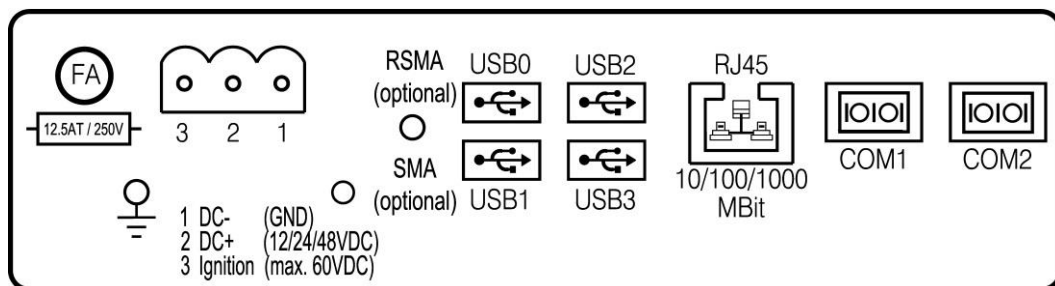

Fig. 7.1: Connectors on the connector panel under the cable cover

Pin assignment description

| | |
|---------------------------|--|
| Power supply | 12/24/48 VDC nominal |
| 1 x SMA (optional) | Remote WWAN antenna |
| 1 x RSMA (optional) | Remote WLAN antenna |
| USB0, USB1, USB2, USB3 | USB 2.0 interfaces (HI-SPEED™), bootable Fused at 1.0 A per channel ESD Level 4 protected (according to EN 61000-4-2) |
| RJ45 | LAN Ethernet 10/100/1000 MBit/s |
| COM1, COM2 | Serial interfaces Max. 115,200 Baud (16550A compatible, 16 byte FIFO) Supports EIA-232-E on external 9-pin D-Sub connection ESD Level 4 protected (according to EN 61000-4-2) |

COM1 as a voltage source

The COM1 interface can optionally supply to externally connected equipment with +5 VDC. The voltages are protected by internal fuses and may not exceed a continuous consumed current of 1 A at 5 V. Depending on the connected devices, the maximum current consumption may be significantly lower.

Using the DLoG Config tool, you can select whether “+5 VDC” or “RI” is output on pin 9 of COM1.

Network adapter (10/100/1000)

The DLT-V72 is equipped with a 10/100/1000 Mbit network adapter with 10/100/1000 Mbit per second. This adapter can be accessed via the bottom of the device and offers an RJ45 connection jack. The RJ45 connection port has two integrated status LEDs and are assigned as follows:

| | | |
|---------------------------|---|------------------------|
| Left LED (green): |  | Right LED (orange): |
| LED off: no connection | | LED off: no activity |
| LED on: connection (link) | | LED flashing: activity |

Fig. 7.2: RJ45 network port

Problems with data transmission via LAN/Ethernet

If problems occur during data transmission over LAN/Ethernet (e.g. data is lost or not detected), the cause of these problems may be a cable which is too long. Depending on the cable layout and interference from the environment, it may be impossible to use the cable length of 100 m given in the specification (IEEE 802.3 standard). The solution here is the use of a shorter cable.

7.1.1. Opening the cable cover

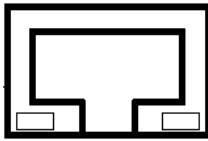
1. Unscrew the thin headless screws of the cable cover with an Allen wrench, size 3.
2. Carefully remove the cable cover.

NOTICE***Prevent system malfunction and property damage***

Improper opening of the cable cover can impair the function of the entire DLT-V72 system.

1. *The cable cover is only permitted to be removed by qualified expert personnel and only for the duration of servicing work.*
2. *Switch off the DLT-V72 before removing the cable cover.*
3. *The device has to be fully deenergized.*
4. *No objects or liquids are permitted to enter the opened DLT-V72.*
5. *The device is only permitted to be operated again once the cable cover is properly sealed again; only then is the protection class guaranteed.*

Closing the cable cover

Please refer to section [13.3.7 Attach the cable cover](#) .

7.2. Connectors under the antenna

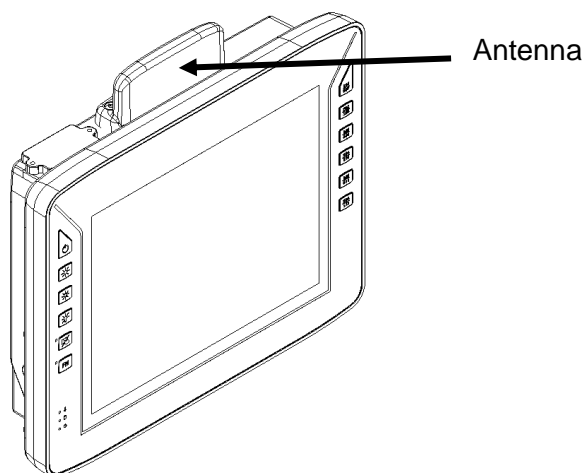

Connectors located under the antenna:

- Service-USB (USB 3.0 Host, SUPERSPEED™)
- CFast slot
- Mini-SIM card slot (optional)

7.2.1. Devices with sealing plate

DLT-V72 devices without radio equipment have a sealing plate instead of the radio antenna:



Fig. 7.3: DLT-V72 with a sealing plate (no radio antenna)

NOTICE **Prevent system malfunction and property damage**

Improper opening of the sealing plate can impair the function of the entire DLT-V72 system.

1. *Sealing plates are only permitted to be removed by qualified expert personnel and only for the duration of servicing work.*
1. *Switch off the DLT-V72 before removing the sealing plate.*
2. *No objects or liquids are permitted to enter the opened DLT-V72.*
3. *Insert/remove cards and sticks when the device has been fully deenergized.*

4. *Hold cards and sticks securely and carefully, and insert precisely into the connections to avoid anything falling inside the device.*
5. *To remove the CFast card, carefully push on the card.*
6. *Use only CFast cards that have been approved by Advantech.*
7. *The device is only permitted to be operated again once the sealing plate is properly sealed again; only then is the protection class guaranteed.*

Open sealing plate:

1. Unfasten both screws on the sealing plate with a 3 mm Allen wrench.
2. Remove the sealing plate from the device. The interfaces are now accessible.

Close sealing plate:

1. Place the sealing plate back onto the DLT-V72.
2. Tighten both screws with a 3 mm Allen wrench (1 Nm torque).

7.2.2. Open/close the WLAN antenna IEEE 802.11 a/b/g/n/ac



Fig. 7.4: WLAN antenna IEEE 802.11 a/b/g/n/ac

NOTICE

Prevent system malfunction and property damage

Improper opening of the antenna can impair the function of the entire DLT-V72 system and in particular the radio functionality.

- 1. Antennas are only permitted to be removed by qualified expert personnel and only for the duration of servicing work.*
- 2. Switch off the DLT-V72 before removing the antenna.*
- 3. No objects or liquids are permitted to enter the opened DLT-V72.*
- 4. Insert/remove cards and sticks when the device has been fully deenergized.*
- 5. Hold cards and sticks securely and carefully, and insert precisely into the connections to avoid anything falling inside the device.*
- 6. To remove the CFast card, carefully push on the card.*
- 7. Use only CFast cards that have been approved by Advantech.*
- 8. The device is only permitted to be operated again once the antenna is properly sealed again; only then is the protection class guaranteed.*

Follow these steps to open antenna “WLAN antenna IEEE 802.11 a/b/g/n/ac”:

Tools required:

- Torx screwdriver, Tx20

Opening the antenna:



Fig. 7.5: WLAN antenna IEEE 802.11 a/b/g/n/ac

1. Unfasten both screws on the antenna with a Torx screwdriver, Tx20.
2. Remove the antenna from the device.

Result:



Fig. 7.6: WLAN antenna IEEE 802.11 a/b/g/n/ac opened

Closing the antenna:

1. Place the antenna back onto the DLT-V72.
2. Tighten both screws alternatingly (0.75 Nm torque).

7.2.3. Open/close the WLAN, WWAN, LTE 4G antenna



Fig. 7.7: WLAN, WWAN, LTE 4G antenna (Multiband)

NOTICE

Prevent system malfunction and property damage

Improper opening of the antenna can impair the function of the entire DLT-V72 system and in particular the radio functionality.

- 1. Antennas are only permitted to be removed by qualified expert personnel and only for the duration of servicing work.*
- 2. Switch off the DLT-V72 before removing the antenna.*
- 3. No objects or liquids are permitted to enter the opened DLT-V72.*
- 4. Insert/remove cards and sticks when the device has been fully deenergized.*
- 5. Hold cards and sticks securely and carefully, and insert precisely into the connections to avoid anything falling inside the device.*
- 6. Exercise special care when removing and plugging in USB connectors.*
- 7. Exercise special care when removing and re-inserting a CFast card.*
- 8. To remove the CFast card, carefully push on the card.*
- 9. Use only CFast cards that have been approved by Advantech.*
- 10. The device is only permitted to be operated again once the antenna is properly sealed again; only then is the protection class guaranteed.*

Follow these steps to open antenna type “WLAN, WWAN, LTE 4G”:

Tools required:

- Torx screwdriver, Tx20
- Allen key size 7

Step 1: Opening the antenna cap:

1. Unfasten both screws on the antenna cap with a Torx screwdriver, Tx20.
2. Remove the antenna cap carefully.



Fig. 7.8: Opening the WLAN, WWAN LTE 4G antenna (Torx Tx20)

The antenna module is located underneath the antenna cap:



Fig. 7.9: WLAN, WWAN LTE 4G antenna opened

Step 2: Removing the antenna module:

1. Unfasten both screws on the antenna module with an Allen key (size 7)
2. Remove the antenna module extremely carefully.

Service USB, CFast and mini SIM card slot are now accessible:



Fig. 7.10: Antenna module WLAN, WWAN LTE 4G is open

NOTICE **Prevent system malfunction and property damage**

1. *Remove the antenna module extremely carefully from the device, as it is secured using thin connection cables onto the Radio card(s) in the interior of the device. The connection cables can be detached from the antenna module and the radio card, meaning radio operation is no longer guaranteed.*

STEP 3: Fasten antenna module and antenna cap:

1. Place the antenna module back onto the DLT-V72.
2. Take care not to pinch or damage the connection cables when doing this.
3. Tighten the two bolts again (1 Nm torque).
4. Place the antenna cap back onto the DLT-V72.
5. Tighten the two screws of the antenna cap again (0.75 Nm torque).

8. Operating the DLT-V72

8.1. Safety notes

WARNING



Personal injury, Property damage and downtimes due to improper operation

Users of the DLT-V72 must be trained by skilled personnel and instructed in the operation of the device. All users must be familiar with all functions of the product they come into contact with.

General

1. *Observe section 2.7 Safety during ongoing work operations in the Safety Chapter of this manual.*
2. *Do not use the DLT-V72 in explosion hazard areas.*
3. *Switch off the DLT-V72 before using the interfaces underneath the antenna.*
4. *Switch off the DLT-V72 before replacing the battery pack.*
5. *Ensure that the deployment location of the DLT-V72 complies with the permissible environmental conditions.*

The following applies when using the DLT-V72 on vehicles:

1. *Risk of accident! The vehicle driver is not permitted to operate the DLT-V72 while driving. Operating the device can represent a distraction from driving operations and there is an increased risk of accident.*

Deployment location fueling stations, chemical plants.

1. *The operation of electrical equipment at locations where flammable gases or vapors are present poses a safety hazard.*
2. *Turn off the DLT-V72 when you are near gas stations, fuel depots, chemical plants or places where blasting operations take place.*

NOTICE

Prevent system malfunction and property damage

1. *While the vehicle battery is charging, disconnect the DLT-V72 from the vehicle battery.*
2. *Alternatively, ensure that the maximum permitted input voltage of the DLT-V72 is not exceeded.*

8.2. Switching the DLT-V72 on/off

The following factors determine how the DLT-V72 can be switched on and off:

- Is the DLT-V72 mounted on a vehicle and connected with the ignition signal?
- What are the automatic shutdown settings that were defined in the respective configuration, e.g. “DLoG Config” program?

Switch on – depending on the configuration:

1. Press the POWER button.
2. Or: Apply the supply voltage.
3. Or: Through the ignition signal of the vehicle (depends on automatic shutdown settings).

Switch off – depending on the configuration:

1. Press the POWER button of the activated DLT-V72.
Note for DLT-V7212 P+ model: Press the button at least 2 seconds.
2. Or: Disconnect the supply voltage.
NOTICE: Devices without integrated UPS will be hard-terminated (data loss possible).
Devices with integrated UPS will switch automatically to UPS/battery power supply when the supply voltage is broken.
3. Or: Deactivate the ignition of the connected vehicle (depends on automatic shutdown settings).

WARNING



Personal injury. Electric shock due to incomplete switching off of the DLT-V72 with integrated UPS

Because of the battery pack, the integrated UPS may still carry current even if the DLT-V72 itself is switched off. Reason: If the DLT-V72 has been configured to also start without POWER button and ignition in the DLoG Config program, this setting will need to be changed first. Otherwise, the DLT-V72 will restart after a short pause as long as there is available battery capacity.

1. *Shut down the DLT-V72 via the operating system function.*
2. *Disconnect from the power supply.*
3. *Open the battery cover; unplug the battery pack.*

Time between switching off and on: 10 seconds

After the DLT-V72 has been shut down and switched off, it takes 10 seconds until the device will react to a switch-on signal (POWER button / ignition).

8.3. Operating the touchscreen

All touchscreens (Resistive and PCT) can be operated with:

- Clean, dry fingers
- Clean, dry gloves

Resistive touchscreens can be operated with:

- Suitable touch stylus plastic or wood, rounded tip

PCT touchscreens can be operated with:

- Suitable touch stylus with capacitive (electrically conductive) tip

Prevent damage to all touchscreens Resistive and PCT

1. Keep the touchscreen clean.
2. Do not touch the touchscreen with pointed, sharp, rough or hard objects, e.g. ball point pens, writing implements, tools of any kind (e.g. screwdrivers).
3. Make sure that no adhesives get on the surface of the touchscreen.
4. Ensure that the screen surface is not influenced by high voltages or static electricity.
5. Do not use excessive force when touching touchscreens, do not hit or press hard.
6. If the device with the touchscreen is placed down: Place a clean, soft cloth underneath.

NOTICE **Prevent system malfunction and property damage**

Salt water on the PCT touchscreen can be interpreted as a "touch" and lead to malfunctions.

8.3.1. Multi-touch capability

Depending on the installed operating system type, the PCT touchscreen of the DLT-V72 is multi-touch capable. This means it can detect two touches simultaneously.

8.3.2. Operating the PCT with gloves

For PCT touchscreens, you can adjust the touch sensitivity with the ADLoG Config tool.

NOTE *The “ADLoG Config Manual” is available at our websites:*



www.advantech.com

www.advantech-service-iot.eu

8.4. Operation elements

8.4.1. DLT-V72 rear side

Antenna:

- Do not cover
- Must have a distance of > 20 to 50 cm to persons

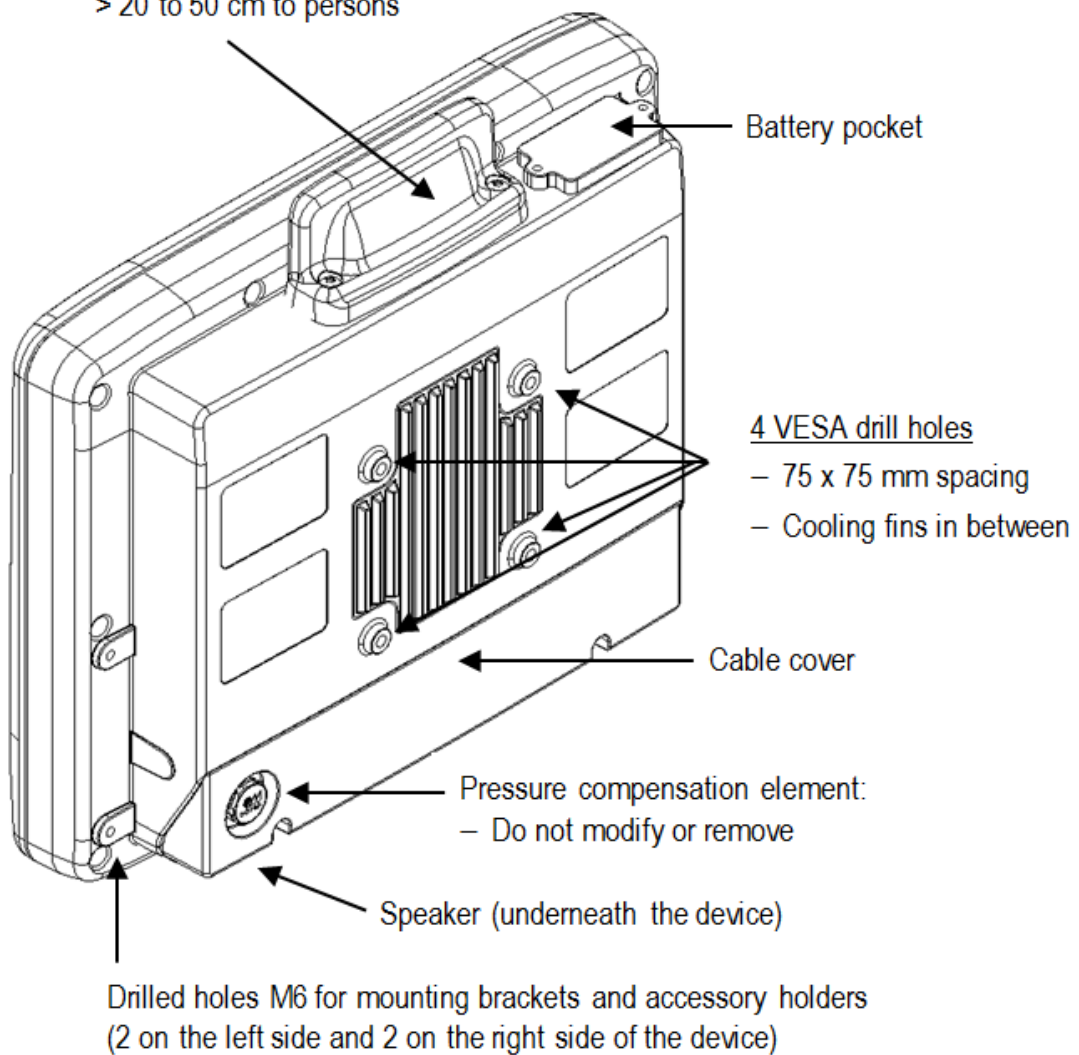

8.4.2. Front side DLT-V7210 and DLT-V7212: P, R, D

Note on the backlighting function on/off: The DLT-V72 will continue to react to keyboard, mouse and touchscreen inputs even if the backlight is switched off.

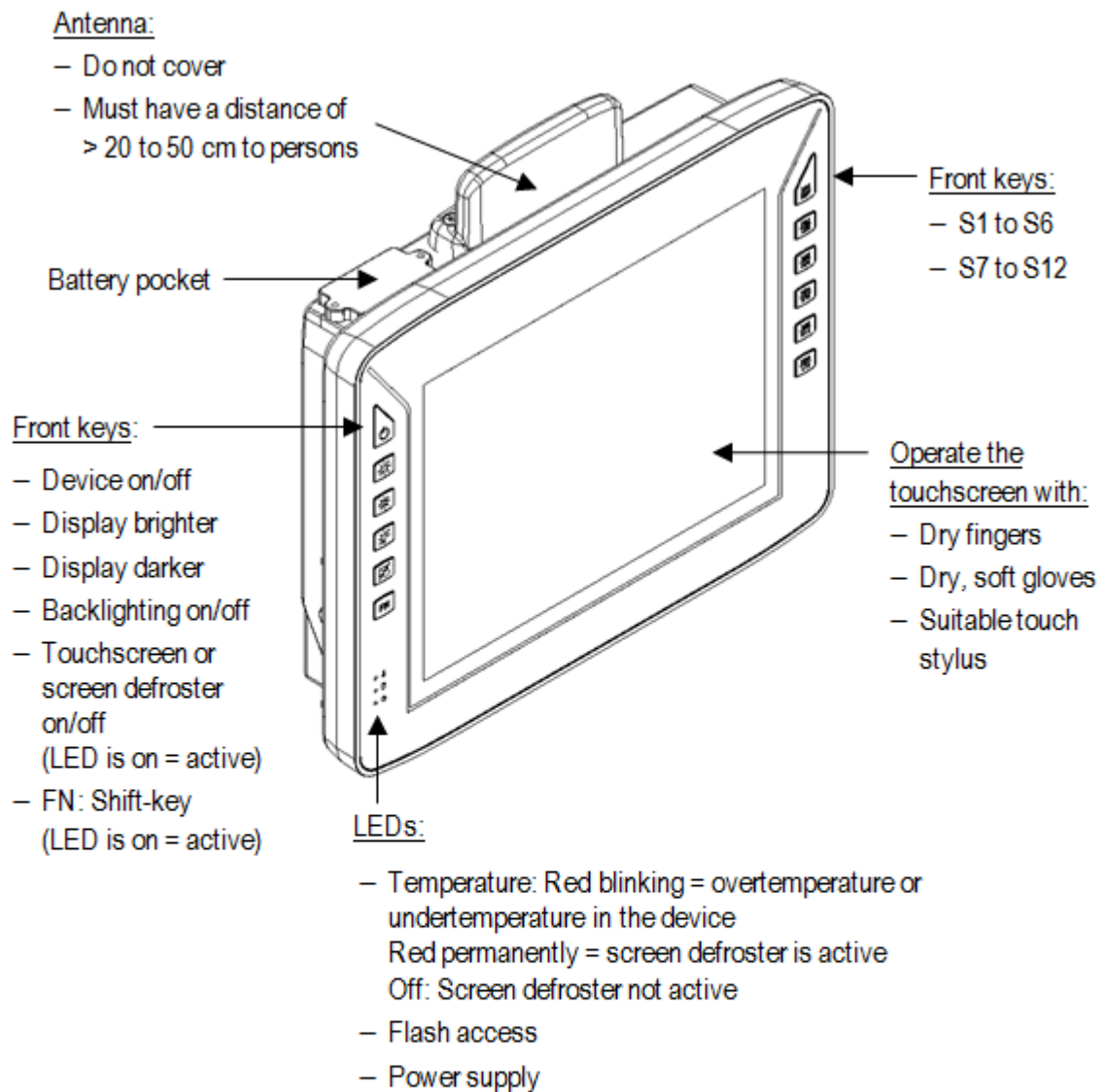

Note for the **Touch** key:

This key has two functions if the device is equipped with a screen defroster (optional) (**D** in the device name):

- Function 1: Activate/deactivate touchscreen
- Function 2: Combined with **FN** – Activate/deactivate screen defroster

8.4.3. Front side DLT-V7212 and DLT-V7215: P+

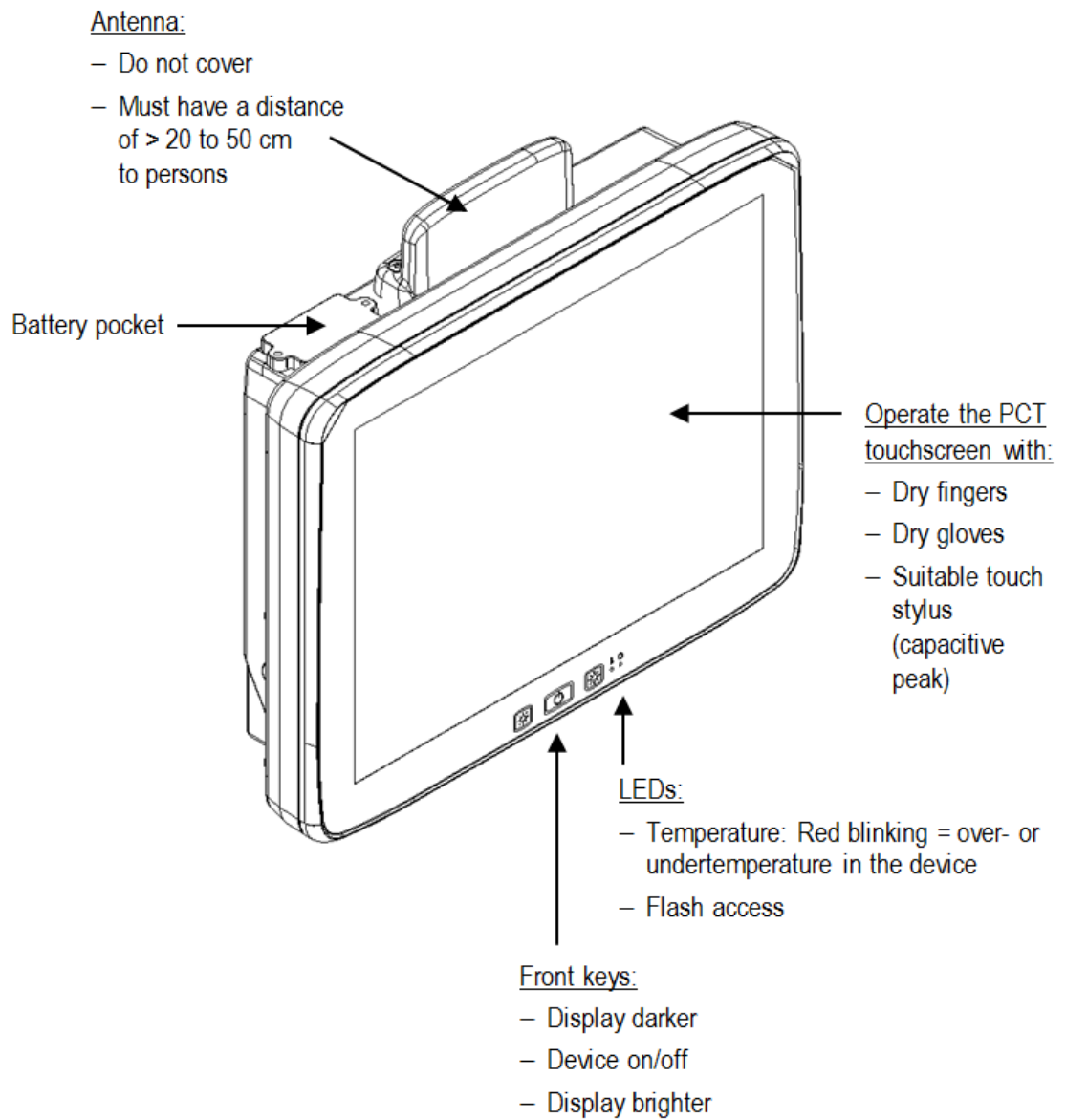

8.4.4. Front side DLT-V7210 K, KD

Note on the backlighting function on/off: The DLT-V72 will continue to react to keyboard, mouse and touchscreen inputs even if the backlight is switched off.

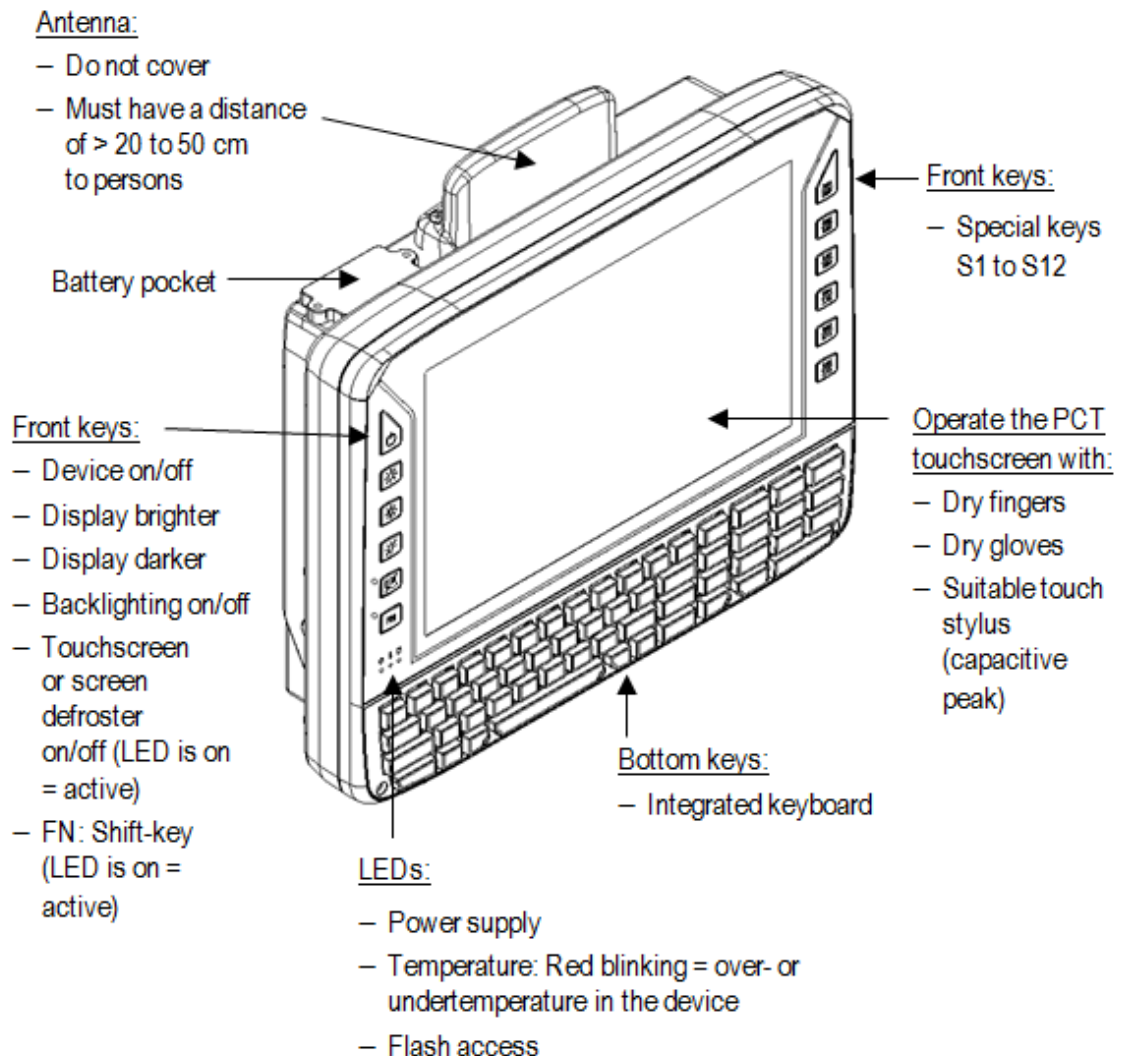

Details on the **Touch** key:

Key has two functions if the device is equipped with a screen defroster (**D** in the device name):

- Function 1: activate/deactivate the touchscreen
- Function 2: activate/deactivate the screen defroster in combination with **FN**

Details on the **FN** key:

FN key pressed has the following effect:

- The special keys to the right on the device are shifted to assignment S7 to S12 (permanent, until **FN** is pressed again).
- The brightness/illumination keys to the left on the device affect the integrated keyboard, not the display (permanent, until **FN** is pressed again).
- The alternative characters of the individual keys shown in red are activated on the integrated keyboard (not permanent).

8.5. Using the integrated keyboard

8.5.1. Language variants

| Device model | Languages available |
|--------------|---|
| DLT-V7210 K | <ul style="list-style-type: none"> English German French |
| DLT-V7210 KD | <ul style="list-style-type: none"> English |

Example English version (QWERTY):

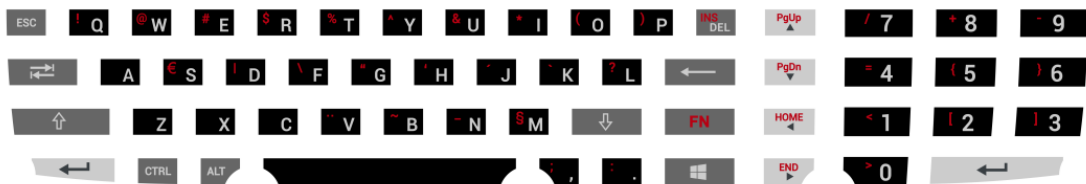









Fig. 8.1: Integrated keyboard English (QWERTY)

8.5.2. Description of specific keys (in all languages)

General

| Key | Function |
|---|--|
|  | Caps Lock: permanent switch to uppercase letters |
|  | FN key pressed has the following effect: The alternative characters of the individual keys shown in red are activated on the integrated keyboard (not permanent). |
|  | Windows key |

Sticky key function for one-hand operation

| Modifier Key | Operation mode on the DLT-V72 |
|---|--|
|  | <p>When you press a modifier key (SHIFT, CTRL, and ALT) on the DLT-V72 keyboard, this key is active for the duration of 4 seconds.</p> <p>This facilitates inputting key combinations with one hand.</p> <p>Example: Press SHIFT and, within 4 seconds, key . The upper-case letter "A" is written.</p> |
|  | |
|  | |

8.5.3. Integrated keyboard German (QWERTZ) features

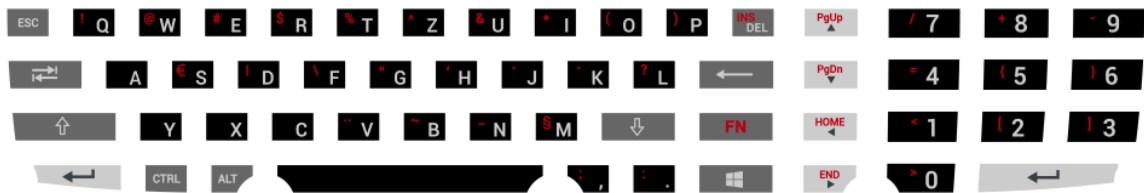











Fig. 8.2: Integrated keyboard German (QWERTZ)

German „Umlaute“

| Umlaut | Press the keys successively: |
|--------|---|
| ä |  + V + A |
| Ä |  +  + V + A |
| ö |  + V + O |
| Ö |  +  + V + O |
| ü |  + V + U |
| Ü |  +  + V + U |

8.5.4. Integrated keyboard French (AZERTY) features

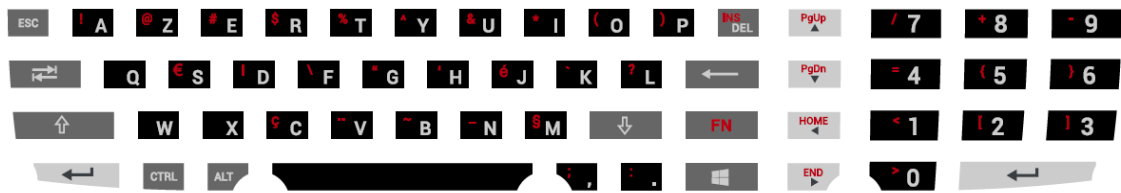



Fig. 8.3: Integrated keyboard French (AZERTY)

Special characters French:

| Character | Press the keys successively: |
|-----------|------------------------------|
| Æ | ALT + 146 |
| æ | ALT + 145 |
| Ç | FN + C or ALT + 128 |
| É | FN + J or ALT + 144 |
| Œ | ALT + 0140 |
| œ | ALT + 0156 |
| » | ALT + 175 |
| « | ALT + 174 |

8.6. Operating states

| LED status | | DLT-V72 status |
|---|--|--|
| Supply voltage  | Temperature  | |
| OFF | OFF | Initial state, idle time – waiting for a new ignition signal or for the POWER button after switch-off; no voltage supply |
| OFF | FLASHING | Temperature sensor faulty |
| FLASHING | OFF | DLT-V72 is in standby mode (S3) |
| OFF | ON | Computer will only start if the temperature in the device is in the range between -30 and +59 °C again. |
| ON | OFF | Computer start-up/normal operational state/shutdown delay time |
| ON | ON | Screen defroster active |
| ON | FLASHING | Ambient temperature lies outside of the permitted range, i.e. < -30 or > +50 °C |

8.7. Software keyboard (optional)

The optional “DLoG software keyboard” brings the complete standard keyboard with function keys and numeric pad directly to your DLT-V72 screen – with easy touch operation. Any entries made, for example, letters and numbers, are passed to the currently active application program.

Example for a software keyboard (the layout can be configured individually):

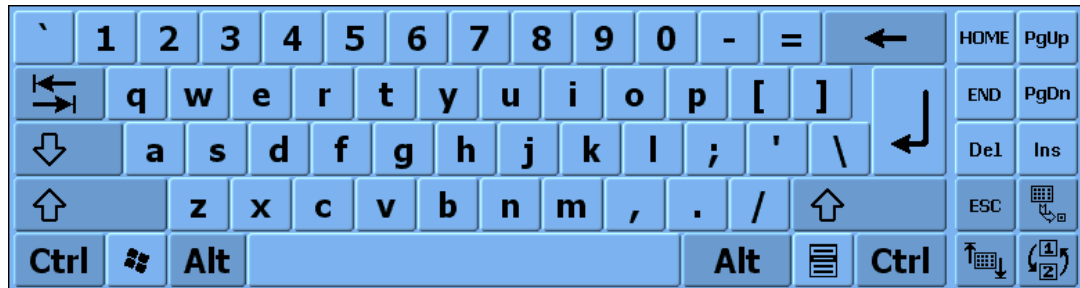

Fig. 8.4: Software keyboard

If the software keyboard was ordered together with the DLT-V72 industrial PC, then the program will have been fully pre-licensed by the Advantech production department. For subsequent installation, an installation program is available.

NOTE *The “DLoG software keyboard manual” is available at our websites.*



8.8. Operating the DLT-V72 with UPS

The DLT-V72 is optionally available with an integrated UPS. The battery pack of the UPS is located in the battery pocket of the device:



Fig. 8.5: Battery pocket with UPS DLT-V72

WARNING



Personal injury due to short-circuit, fire, chemical burns, toxic substances.

DLT-V72 devices with integrated UPS contain battery packs. These can ignite if handled or stored improperly (risk of fire), cause chemical burns or release toxic substances.

- 1. Use care when handling battery packs.*
- 2. Do not damage battery packs; do not drill through and do not crush or drop.*
- 3. Do not allow water or other liquids to come into contact with the device (exercise particular caution with corrosive liquids).*
- 4. Do not allow it to come into contact with fire.*

For details about the UPS, see section [14.1 Integrated UPS \(optional\)](#).

8.9. Internal speaker, sound

The DLT-V72 is equipped with an internal speaker as standard (2 W). The system messages from the industrial PC are output via this speaker. The internal speaker is configured in the audio settings for the operating system in question.

Antenna:

- Do not cover
- Must have a distance of > 20 to 50 cm to persons

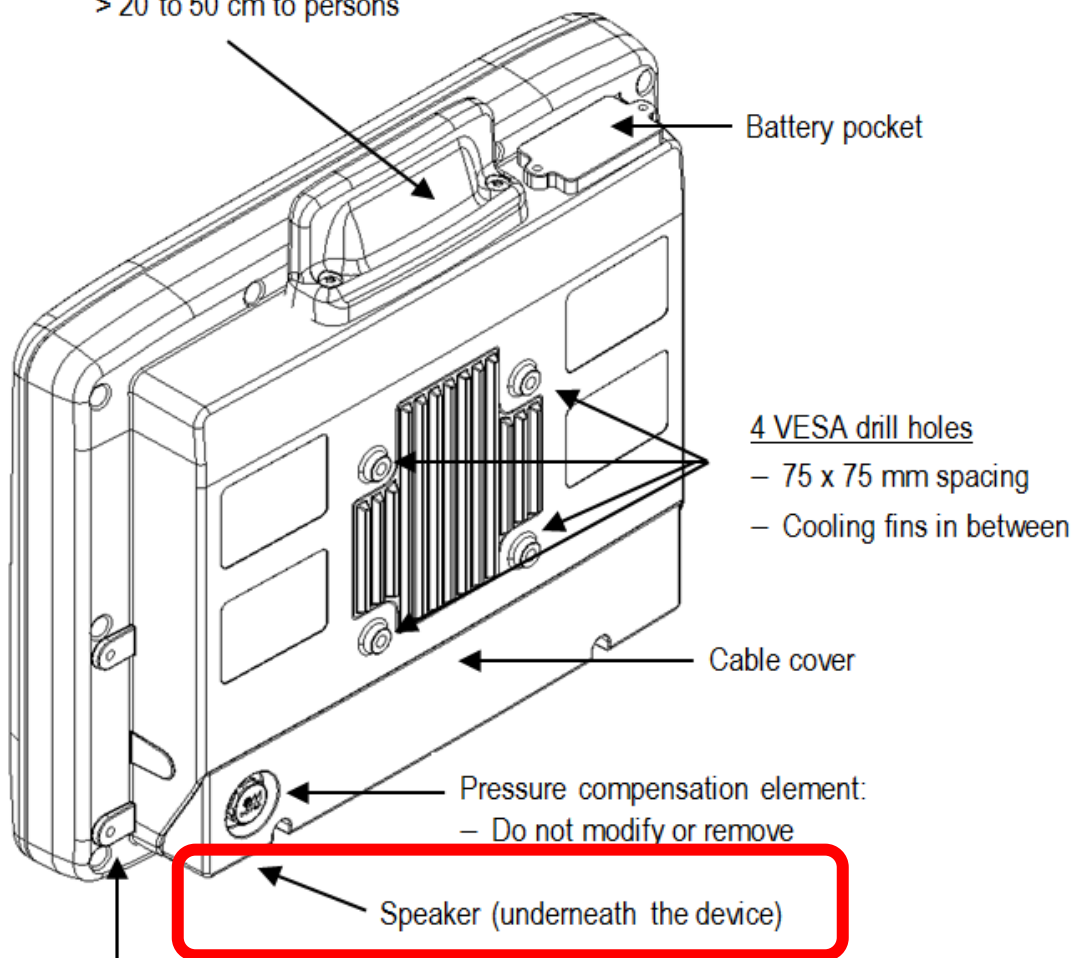

Drilled holes M6 for mounting brackets and accessory holders
(2 on the left side and 2 on the right side of the device)

9. General Device Configuration

9.1. Operating systems (optional)

NOTE

Please find the latest overview of all supported operating systems in the DLT-V72 data sheets at our websites.

The following operating systems are available at the time of manual creation, Feb 2021:

- MS Windows 10 IoT Enterprise (Win10IoTEnt)
- MS Windows 7 Pro (Win7Pro)
- MS Windows Embedded Standard 7 (WES7)
- Debian-based Linux
- IGEL Linux
- Android 7.1.2
- Android 9

9.2. MS Windows (optional)

9.2.1. General

If a DLT-V72 with preinstalled operating system is placed into operation, this operating system will be loaded after the BIOS system messages. System-specific device drivers (e.g. for graphics, sound, network, touchscreen) are already installed.

In DLT-V72 units with a pre-installed operating system, the system is located on the C partition.

When a DLT-V72 is started up for the first time without a pre-installed operating system, the user needs to carry out a number of steps that will vary depending on the system to be installed. Refer to the relevant operating system manual for specific instructions.

9.2.2. Configuring the front keys, automatic shutdown, etc.

The DLoG Config software is used to configure DLT-V72 devices with a MS Windows operating system.

For configuring DLT-V72, the DLoG Config version **5.0** or higher is required.

Configuration examples:

- Automatic shut down
- Front-key assignment
- Network settings

And depending on the equipment of the DLT-V72 also:

- Battery pack charge settings (only on devices with optional UPS)
- Screen defroster heating function (only on devices with optional screen defroster)
- Operation with gloves possible (only on devices with optional PCT touchscreen)

NOTE *The “DLoG Config manual” is available at our websites.*



9.2.3. Energy options and battery pack durability

Valid for all MS Windows operating systems:

NOTICE ***Prevent system malfunction and property damage***

*All DLT-V72 devices with MS Windows have had the **power options** set at the factory so that the optimal duration of the battery pack can be achieved: The power saving plan is set to **power options (DLoG)**. Do not modify or deactivate the **power options (DLoG)***

9.2.4. Suppress automatic Win10IoTent updates

Under Win10IoTent, the automatic Windows updates can no longer be deactivated; the **Never check for updates** setting in the **Windows Update** dialog is not available.

With the following entry in the Windows registry, the **Never check for updates** setting can be set anyway:

1. Manually create the following entry in the Windows registry (type "dwords"):

```
[HKEY_LOCAL_MACHINE\SOFTWARE\Policies\Microsoft\Windows\WindowsUpdate\AU]
"NoAutoUpdate"=dword:00000001
```

```
[HKEY_LOCAL_MACHINE\SOFTWARE\WOW6432Node\Policies\Microsoft\Windows\WindowsUpdate\AU]
"NoAutoUpdate"=dword:00000001
```

2. Restart Windows.
3. Via **Start ->Settings -> Update & Security**, switch to the Windows Updates dialog.
4. Click on **Retry** to search for updates.
5. Click on Advanced Options.
The **Never check for updates** setting is now set.

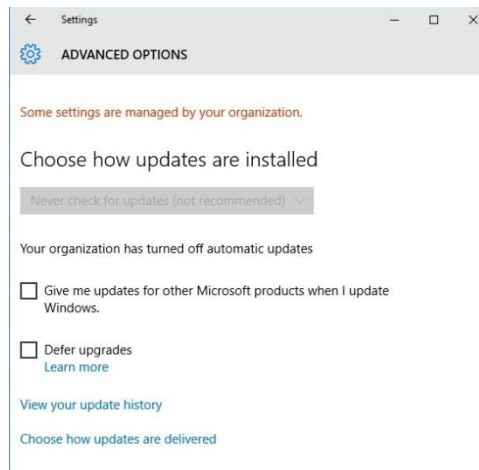

Fig. 9.1: Automatic Win10IoTent Updates

To deactivate **Never check for Updates**:

1. Delete the entry manually from the Windows registry.
2. Restart the computer.
3. Search for updates.

9.3. Linux (optional)

NOTE



The configuration of the DLT-V72 with Linux with regard to radio networks, touchscreen calibration, etc. is described in the “Advantech Linux Manual”. Please contact our Technical Customer Support if required.

9.4. ADLoG Android (optional)

NOTE



The configuration of the DLT-V72 with Android with regard to radio networks, touchscreen calibration, etc. is described in the “ADLoG Android Manual” available at our websites.

9.5. Automatic shut down

Functional description

The DLT-V72 is equipped with an automatic shutdown module.

If wired up accordingly, the DLT-V72 conveniently switches off together with the vehicle's ignition.

As disconnecting the power supply during operation can lead to data loss, the operating system needs to be shut down normally using the appropriate hardware and software installed on the system when the ignition is switched off.

The DLT-V72 is connected to the vehicle with three supply cables.

DC+ and DC- are directly connected to the power supply of the vehicle, the connection is of course run through fuses. The supply voltage connected is then linked to the DLT-V72's ignition input via a switch, for example, the key switch of the ignition (also with a fuse).

Sequence

When the vehicle ignition is turned on or the DLT-V72 POWER button is pressed, the DLT-V72 checks its internal temperature and runs a test to confirm that the automatic shutdown function is working.

If this check of the environmental conditions is successful, the DLT-V72 starts the operating system normally.

Once these checks have been successfully completed, the DLT-V72 starts the operating system. No environmental conditions (e.g. the internal temperature of the device or the state of the ignition input) are checked for one minute during startup.

After one minute, the DLT-V72's internal temperature and the state of the ignition input are constantly monitored.

If the DLT-V72's internal temperature reaches a critical level, a controlled shutdown of the operating system is carried out. The computer will remain switched off until the temperature is once again within the permitted range.

If the ignition input is grounded or isolated during normal operation of the DLT-V72, the device will switch to a delayed shut-off state.

The device will continue to operate normally in this state until the shut-off delay (e.g. 20 minutes) has elapsed.

If the ignition is turned on again during this shut-off delay, the DLT-V72 will revert to a normal operational state.

Once the shut-off delay (after run time) has elapsed, the operating system will shut down and the device will automatically shut down (e.g. after one minute or a signal from the operating system).

Device shut down

If the operating system is shut down, all applications will be notified via the Windows message "WM_QUERYENDSESSION" first.

Every application must then respond within the time set in the registry. If there is no response within the preset time, the application will be hard-terminated.

It may not be possible to close an application automatically if it has unsaved data. Example: For example, the „WORDPAD.EXE" program (included in Windows) cannot be closed automatically if there are unsaved changes. In such a situation, „WORDPAD.EXE" will acknowledge the "WM_QUERYENDSESSION" Windows message by prompting the user to choose whether to save or not.

All applications that can be terminated without user confirmation using the keyboard shortcut ALT + F4 will normally also respond correctly to the "WM_QUERYENDSESSION" message and therefore do not need to be hard-terminated.

To ensure that important data is saved correctly, the application must respond appropriately to "WM_QUERYENDSESSION", i.e. the backup data must be saved without user confirmation and within the preset time.

9.6. MPair

With the help of the MPair application Bluetooth® capable 2D scanners can be connected to the terminal by scanning an onscreen barcode.

NOTE



This function is only available for industrial computers of the DLT-V72 and DLT-V83 series, which are equipped with the WLAN-Card SPARKLAN WPEQ-261ACN (BT).

MPair supports the following operating systems.

- Windows 10 IoT Enterprise 2016
- Windows 10 IoT Enterprise 2019
- Windows 10 IoT Enterprise 2021

NOTE



MPair only supports the connection of scanners with the Bluetooth® profile SPP “Serial-Port-Profile”. USB-HID Bluetooth® connections are not supported by MPair.

For a more detailed description of the configuration to be made and the handling of the MPair application, please refer to the separately available **ADLoG Config manual v530 (or higher)** from our homepage.

www.advantech-service-iot.eu -> Downloads -> Service -> Paperwork -> Manual

9.7. DeviceOn/iService support

Advantech's DeviceOn/iService is a next-generation unified device management solution based on the WISE-DeviceOn platform. Designed to enable centralized monitoring and remote management, DeviceOn/iService supports Advantech devices equipped with Windows, Linux, or Android operating systems. The software also supports the management of applications and integrated peripherals, such as barcode scanner, card reader, camera, and printer. Users can remotely access and control connected devices, take screenshots, rollout OTA updates and use remote desktop capabilities for troubleshooting from any location at any time.

The main features of Advantech's DeviceOn/iService reads:

- Device runtime status overview dashboard
- Real-time alarm and notifications features
- Device grouping and management
- Remote real-time device runtime status monitoring
- Over-the-air (OTA) software updates (app and OS)
- Remote desktop features
- Kiosk mode settings

Moreover, DeviceOn/iService supports batch operations to facilitate the management of multiple devices simultaneously for easy and convenient device configuration and deployment.

Installation requirements

The following Windows 10 IoT Enterprise version (or newer) is required to support Advantech's DeviceOn/iService for ADLoG DLT-V72:

| Part number: | Description: |
|----------------|--|
| 20708WX6ES0039 | Win10 IoT Ent 2016 x64 APAC V72 v1.07 |
| 20708WX6ES0040 | Win10 IoT Ent 2016 x64 US_EU V72 v1.07 |
| 20708WX9ES0032 | Win10 IoT Ent 2019 x64 US_EU V72 v1.03 |
| 20708WX9ES0033 | Win10 IoT Ent 2019 x64 APAC V72 v1.03 |

NOTE



The Part number can be read out inside the Windows 10 image at location **C:\Windows\Version.txt**

In addition to the image file the initial BIOS version (or newer) that supports DeviceOn/iService must be available that all functions work correctly:

| Version: | Part number: | Description: |
|----------|--------------|--|
| G7I06A02 | 1420051553 | BIOS DLT-V72 FL IF60V111 CS:AAC1 MX25L6435EM2I-1 |

NOTE



The actual BIOS version can be read out inside the **ADLoG config tool** at rubric **Hardware Monitor**

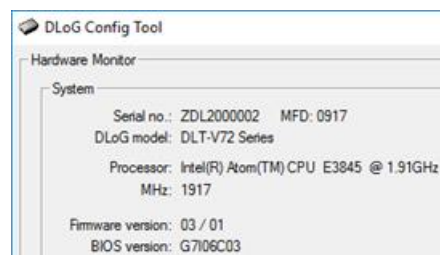

Fig. 9.2: ADLoG config tool Hardware Monitor

When the BIOS version is not the correct one to support DeviceOn/iService, but the correct Win10 image is already installed, the Windows Device Manager will show an exclamation mark in the Device Manager at driver **System Devices\SUSI4 driver**.

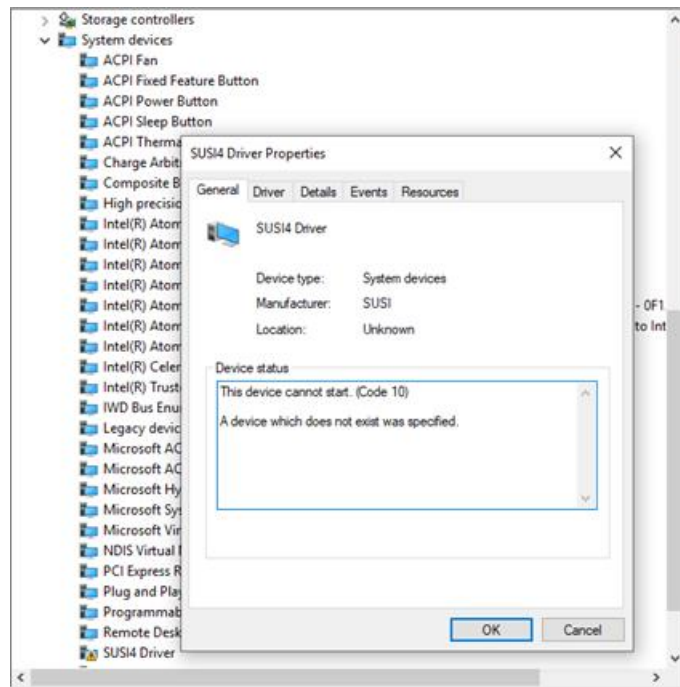

Fig. 9.3: Windows Device Manager SUSI4 Driver

To resolve this please contact **ADV Helpdesk** to receive the required BIOS file to support DeviceOn/iService.

If you do not plan to use the DeviceOn/iService the driver can as alternative way also removed from system.

More information about Advantech's DeviceOn/iService can be reviewed at official Homepage:

<https://www.advantech.com/campaign/DeviceOn-iService>

10. WLAN Configuration

10.1. Safety notes

CAUTION



Danger of radiation.

DLT-V72 devices with radio technology emit high frequency energy (abbreviation: HF). To protect persons and domestic animals against HF radiation:

1. *Observe section 2.4 HF Radiation in the Safety Chapter of this manual.*
2. *Observe all applicable regulations for your deployment location/country with regard to operating channels, radio frequencies and the maximum permissible transmitting power.*

Examples of country-specific regulations:

| Region | Radio approval |
|---------------|-----------------------|
| EU | RED (formerly R&TTE) |
| China | SRRC |
| Japan | MIC (formerly TELEC) |
| Taiwan | NCC |
| Canada | Canada IC |
| USA | FCC |

Antenna solutions for use in Germany

The Advantech antenna solutions are based on the prevailing IEEE 802.11 standard. This standard allows radio data transfer at rates from 1 Mbps to 54 Mbps (867 Mbit/s if using IEEE 802.11ac) using the 2.4 GHz and 5 GHz frequency band.

Information on radio performance

The consistency of the radio performance is dependent on the following factors:

- Radio card (set transmission power)
- Connecting cables
- Antenna gain

Help table for the correct setting:

| Translation between mW and dBm | | | | | | | | | | | | | | | | | | | | | | | |
|--------------------------------|----|---|---|---|---|---|---|----|----|----|----|----|----|----|----|----|----|-----|-----|-----|-----|-----|--|
| dBm | -1 | 2 | 5 | 6 | 7 | 8 | 9 | 10 | 11 | 12 | 13 | 14 | 15 | 16 | 17 | 18 | 19 | 20 | 21 | 22 | 23 | 24 | |
| mW | 1 | 2 | 3 | 4 | 5 | 6 | 8 | 10 | 12 | 15 | 20 | 25 | 30 | 40 | 50 | 60 | 80 | 100 | 125 | 150 | 200 | 250 | |

Fig. 10.1: WLAN table mW and dBm

10.2. Preparation work at the factory

The following preparations have already been carried out at the factory for the optional radio functionality of the DLT-V72:

- The radio card and the corresponding drivers are installed. (Sparklan or IGX)
- A default profile with basic settings is defined.

NOTICE **Prevent system malfunction and property damage**

Radio cards are located inside the devices and are not accessible from the outside. Only the manufacturer and its authorized service centers may open the device and install/remove radio cards.

10.3. OS-specific configuration

Observe the following manuals to find more details about OS-specific configuration:

| OS | WLAN configuration description |
|--|---|
| DLT-V72 with MS-Windows | In the following manual sections |
| DLT-V72 with Linux | In manual “Advantech Linux”; please contact our Technical Customer Support if required. |
| DLT-V72 with Android Nougat 1.xx for DLT-V72 | In manual “Android Nougat 1.xx for DLT-V72” available at our websites |
| DLT-V72 with Android 9 2.xx for DLT-V72 | In manual “Android 9 2.xx for DLT-V72” available at our websites |

10.4. Customer-specific WLAN profiles

To create a customer-specific profile:

1. Use the configuration program that is already factory-installed on the DLT-V72. (Sparklan or IGX)
2. Observe the description of the configuration programs in the following sections.

| Radio card | | OS | Configuration program |
|----------------------------------|--|---------|--|
| SPARKLAN WPEQ 261 ACN (BT) | Qualcomm Atheros QCA61x4A Wireless Network Adapter | Windows | Advantech WLAN Client Manager (IGX Tool) Password: gold |
| | | | Wireless Zero Configuration (abbreviation: WZC) No password required |
| | | Linux | Linux Configuration Utility |
| | | Android | Android WLAN settings utility |

10.5. Windows Zero Configuration (WZC)

WZC (Windows Zero Configuration) is a tool for automatic WLAN configuration in MS Windows.

NOTE

Comprehensive information can be found in the WZC Online Help.



Using the Sparklan WLAN driver, the WZC tool is used to connect and set up the WLAN profile as described in more detail in the next chapter.

10.6. Sparklan WLAN driver

10.6.1. Area of application

This chapter describes the **Sparklan WLAN driver** under the following OS:

- Win7Pro
- WES7
- Win10IoTEnt

Required: DLT-V72 with radio card **SPARKLAN WPEQ-261ACN (BT) MiniPCle**

10.6.2. Driver download

The currently available Sparklan WLAN driver can be downloaded from the following website:

www.advantech-service-iot.eu -> Downloads -> Service -> Drivers -> Link to FTP:

Advantech-DLoG_Products\Additional-Drivers-Software\WLAN_driver\X86_(DLoG_MPC_MTC_IPC_series)\Sparklan_261_ACN_BT

Once the download has completed, the contents of the ".zip" directory on the desktop must be unzipped.

NOTE



Requirements:

*The following steps should be performed as the **Administrator** for the installation process.*

10.6.3. After image reinstallation: Driver installation

If the image has been reinstalled, the DLT-V72 must be set up again using the Sparklan WLAN driver. Two drivers are available:

- Driver for Win7Pro and WES7
- Driver for Win10IoTent

10.6.4. “Standard” Driver installation WES7, Win7Pro, Win10IoTent

1. Open the corresponding installation directory depending on the OS.
2. Run **Setup.exe** to start the installation.

NOTE



The following installation example shows the Win 8.1 IndPro \ Win 10 IoT driver. For Win 7 installation, please use the corresponding Win7 driver.

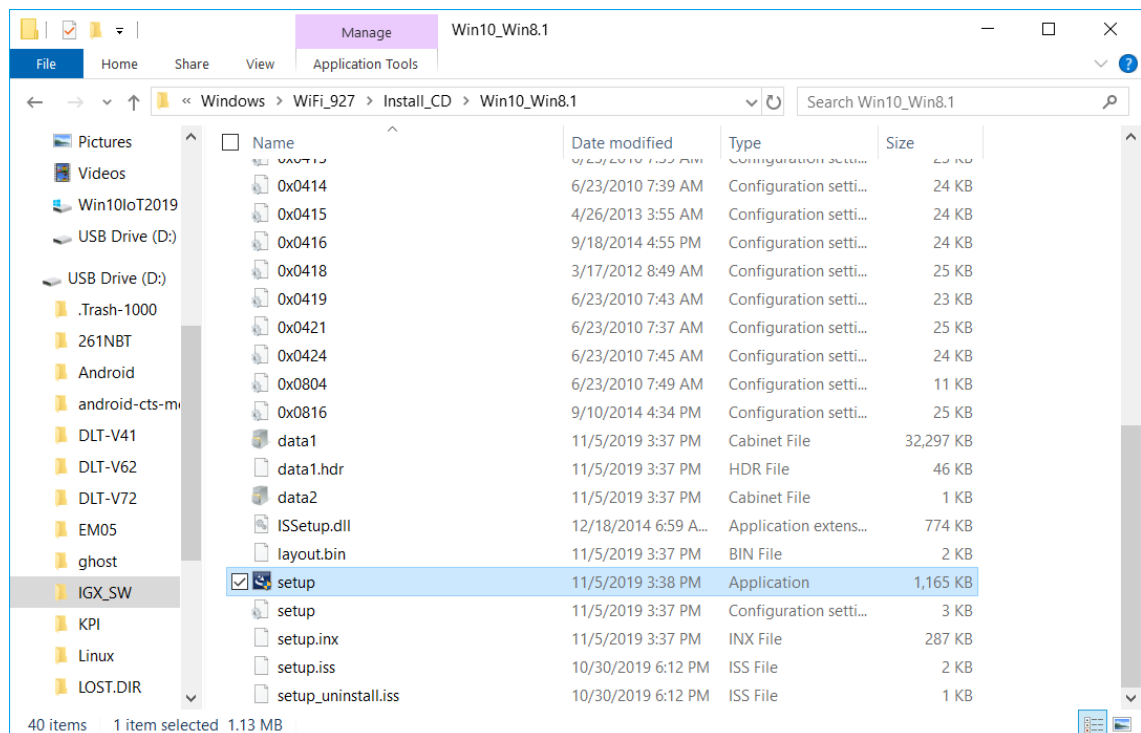

Fig. 10.2: Setup.exe for 64 bit operating system Win10IoTent (Sparklan WLAN)

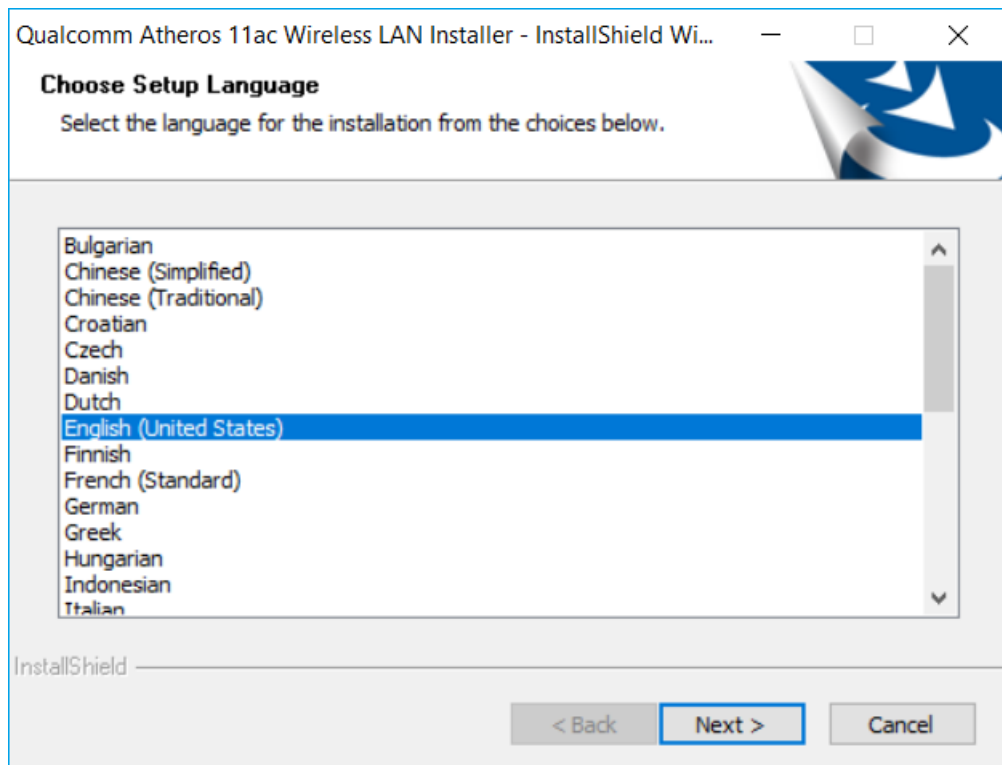

Fig. 10.3: Setup.exe Choose Setup Language (Sparklan WLAN)

3. Select the language and continue with **Next**.

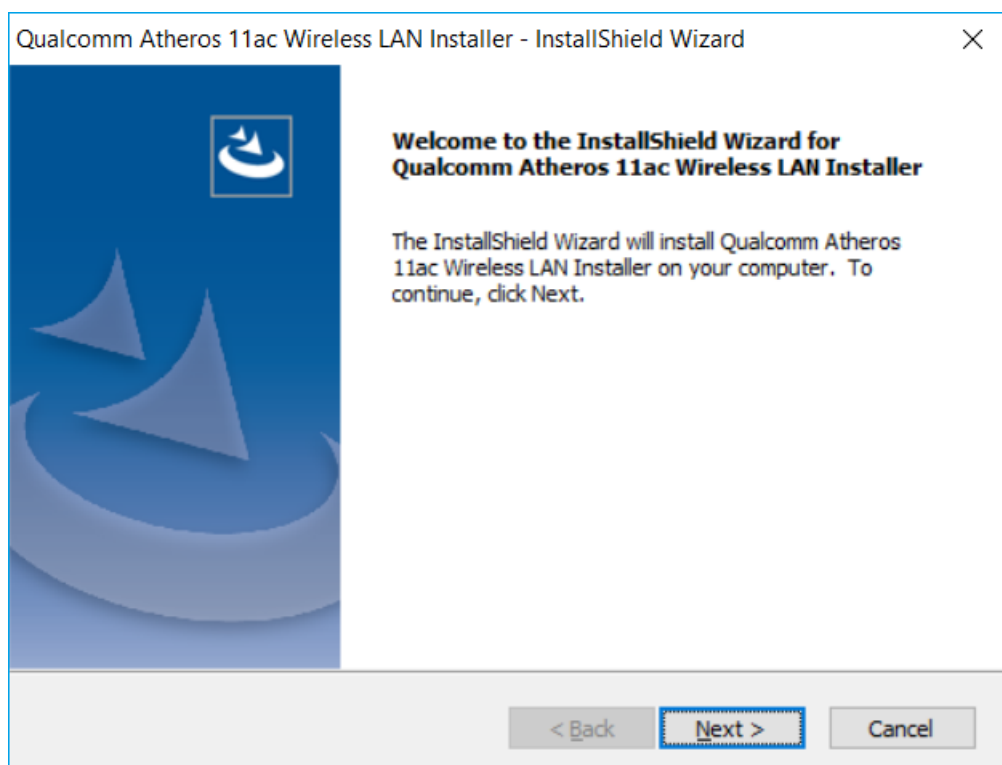

Fig. 10.4: Sparklan WLAN driver installation Welcome dialog

4. Continue the installation with **Next**.

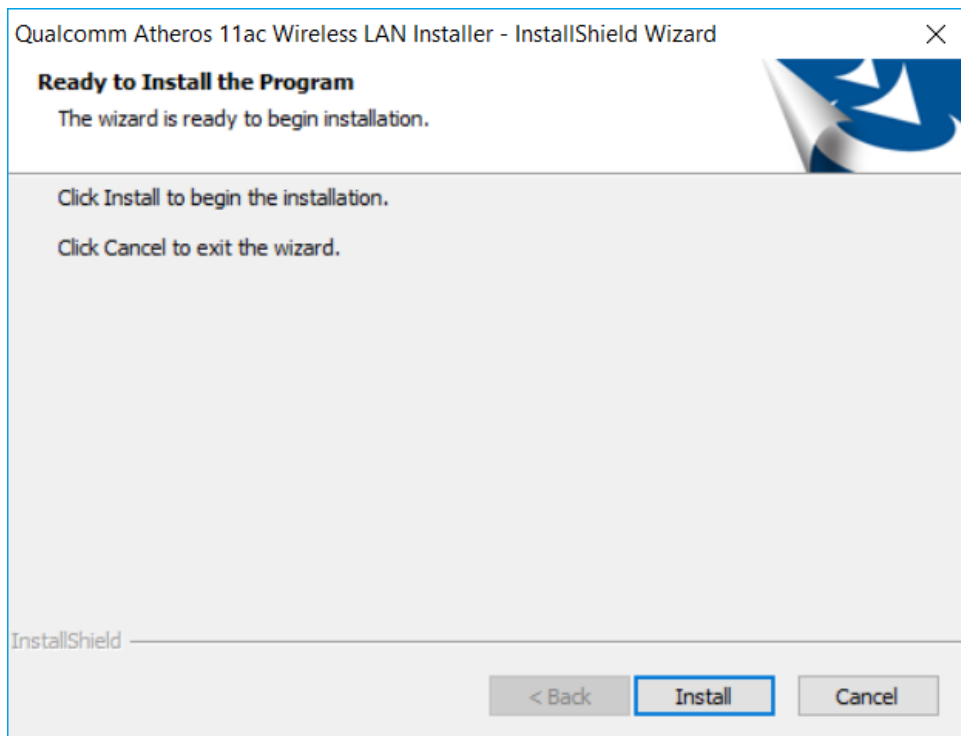

Fig. 10.5: Sparklan WLAN driver installation starts

5. Continue the installation of the required files with **Install**.

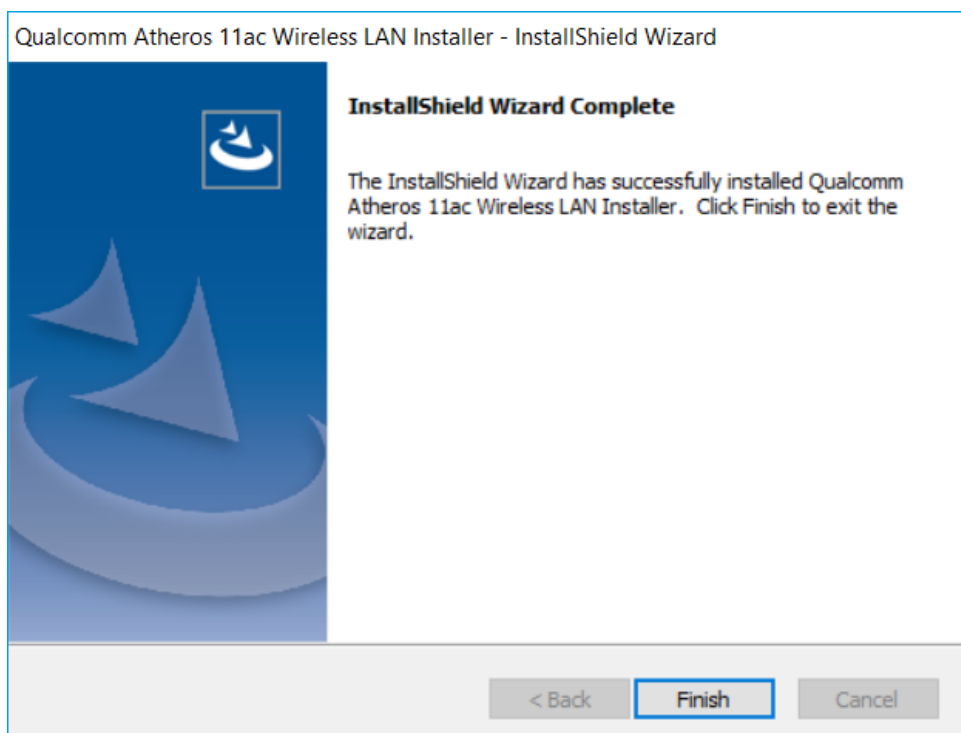

Fig. 10.6: Sparklan WLAN driver installation Exit with Finish

6. Exit the driver installation with **Finish**.

The WLAN configuration is then carried out using the WZC tool under Windows.

10.6.5. Sparklan “Roaming” Setting

For an optimal “roaming” result, we recommend using the Windows device manager to manually adjust the following setting after the standard WLAN driver installation.

1. Open Windows Device Manager.

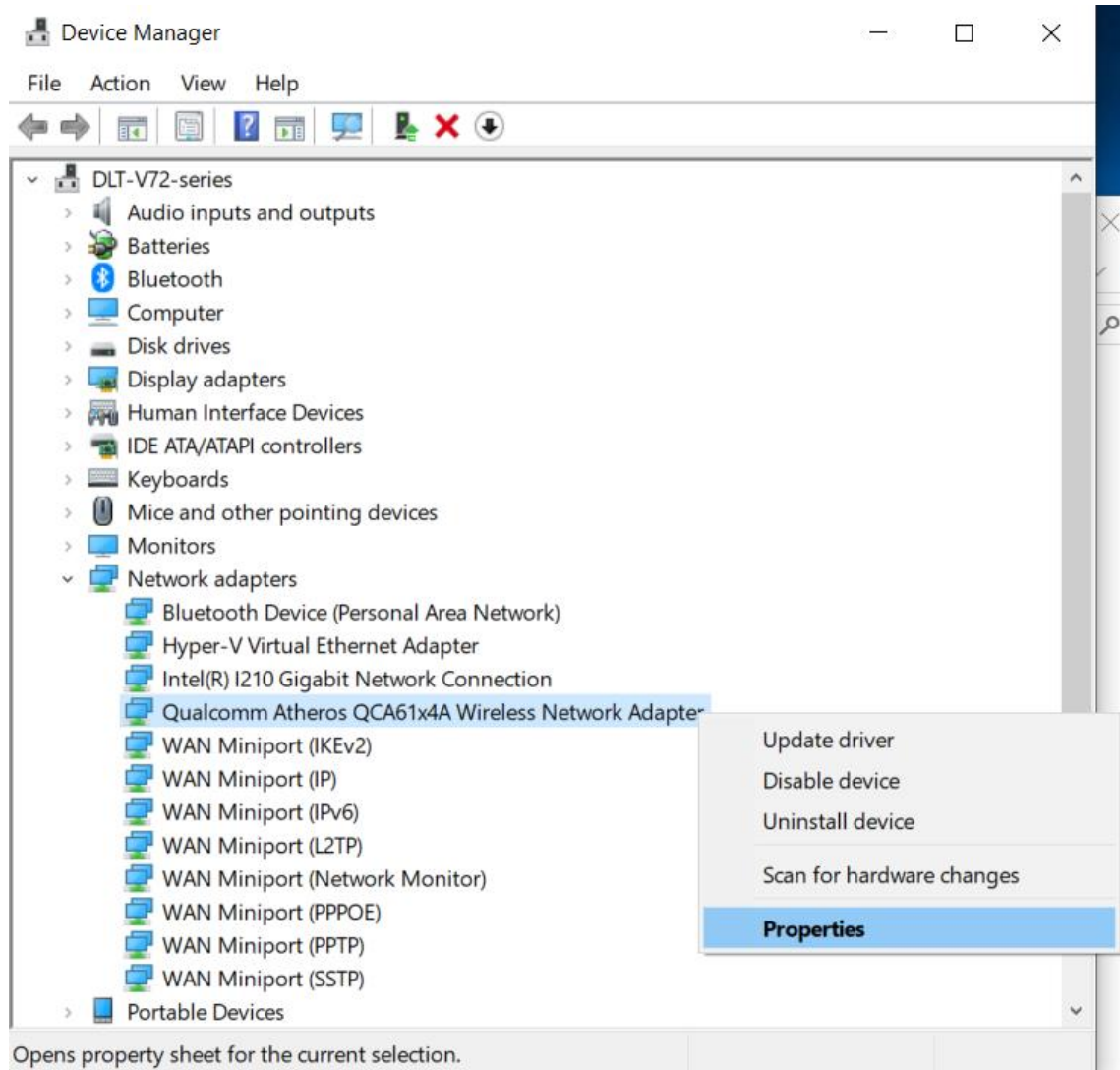

Fig. 10.7: Device Manager network adapter Properties (Qualcomm)

2. Open right click option **Properties** of the network adapter **Qualcomm Atheros QCA...**

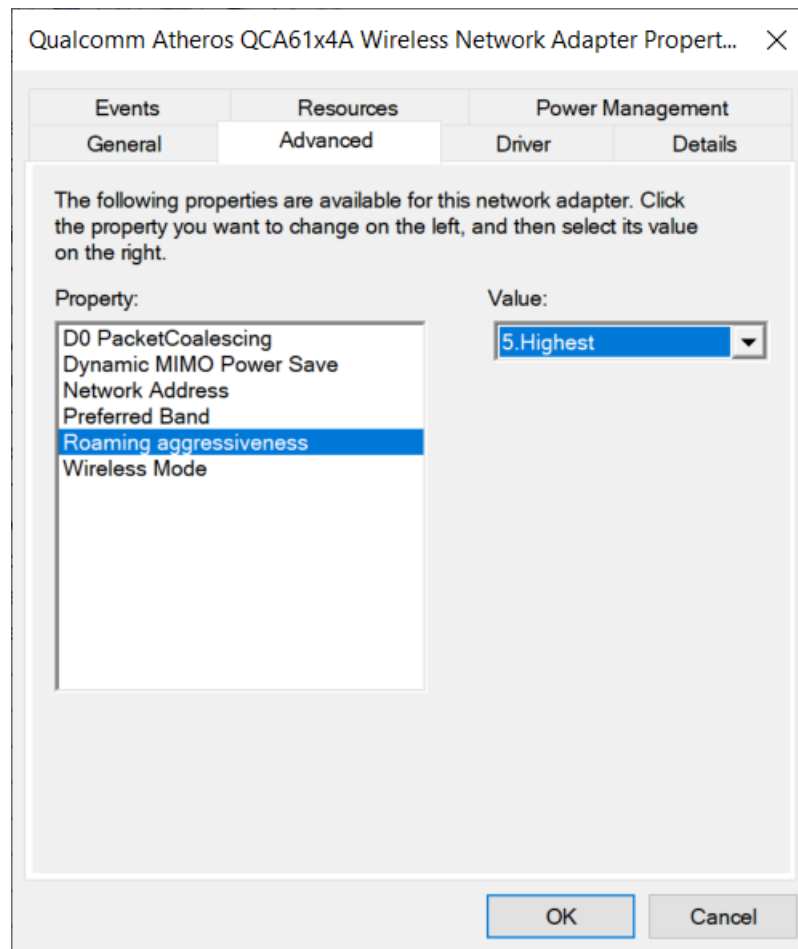

Fig. 10.8: Advanced – Roaming aggressiveness Property

3. Under the **Advanced** tab, set the **Roaming aggressiveness** property to value **5. Highest**.
4. Confirm the setting made with **OK**.

10.7. Sparklan BT driver

In addition to the WLAN driver, Sparklan provides a suitable Bluetooth® driver separately.

NOTICE *For full Bluetooth 5.0 SW support you need at least Sparklan driver version v1159 (or higher) in combination with Windows 10 Enterprise (2016, 2019, and 2021).*

10.7.1. Area of application

This chapter describes the **Sparklan BT driver** under the following OS:

- Win10IoTent

Required: DLT-V72 with radio card **SPARKLAN WPEQ-261ACN (BT) MiniPCle**

10.7.2. Driver download

The currently available Sparklan BT driver can be downloaded from the following website:

www.advantech-service-iot.eu -> Downloads -> Service -> Drivers -> Link to FTP:

[Advantech-DLoG_Products\Additional-Drivers-Software\WLAN_driver\X86_\(DLoG_MPC_MTC_IPC_series\)\Sparklan_261_ACN_BT](ftp://Advantech-DLoG_Products\Additional-Drivers-Software\WLAN_driver\X86_(DLoG_MPC_MTC_IPC_series)\Sparklan_261_ACN_BT)

Once the download has completed, the contents of the ".zip" directory on the desktop must be unzipped.

NOTE



Requirements:

The installation of the Sparklan BT driver is only approved in conjunction with the Sparklan WLAN driver.

Using the IGX WLAN driver, the appropriate BT driver is installed automatically!

*The following steps should be performed as the **Administrator** for the installation process.*

10.7.3. After image reinstallation: Driver installation

If the image has been reinstalled, the DLT-V72 must be set up again using the Sparklan BT driver. One driver is available:

- Driver for Win10IoTent

10.7.4. “Standard” Driver installation Win10IoTent

1. Run **Setup.exe** to start the installation.

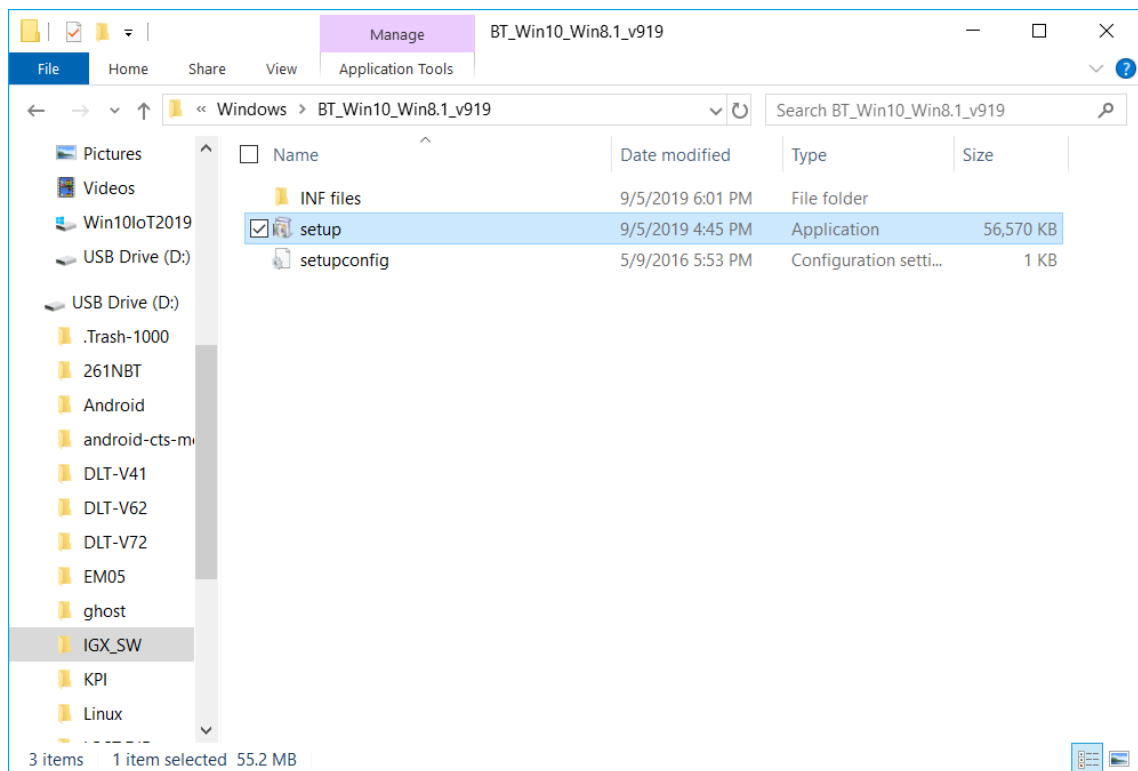

Fig. 10.9: Setup.exe for 64 bit operating system Win10IoTent (Sparklan BT)

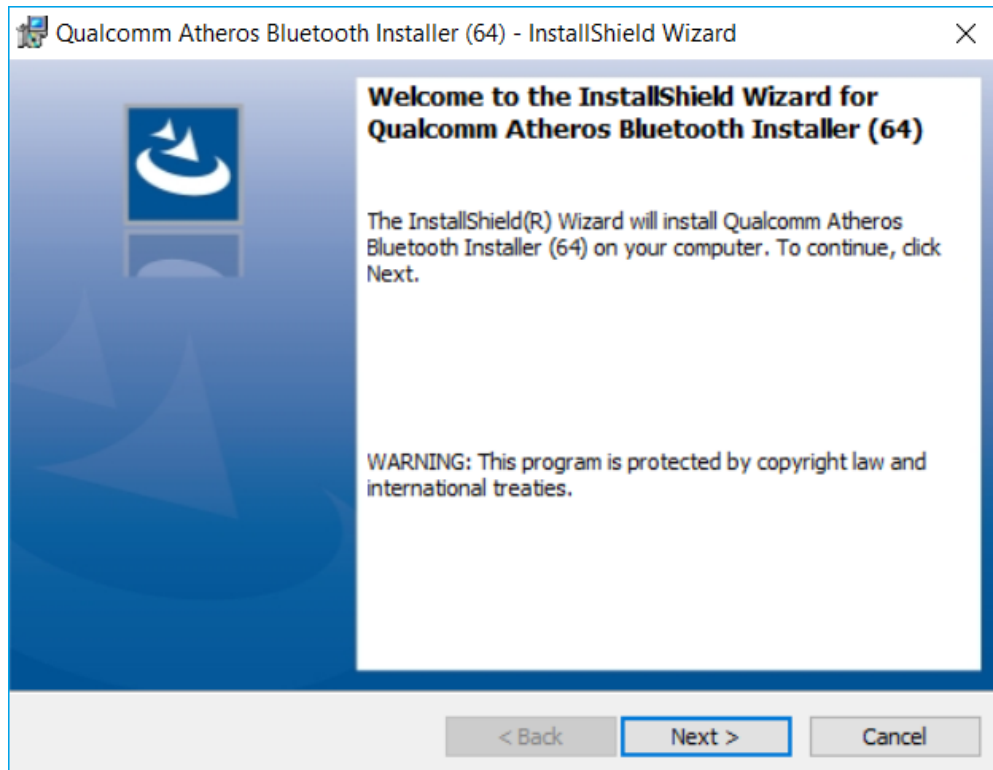

Fig. 10.10: Sparklan WLAN driver installation Welcome dialog

2. Continue the installation with **Next**.

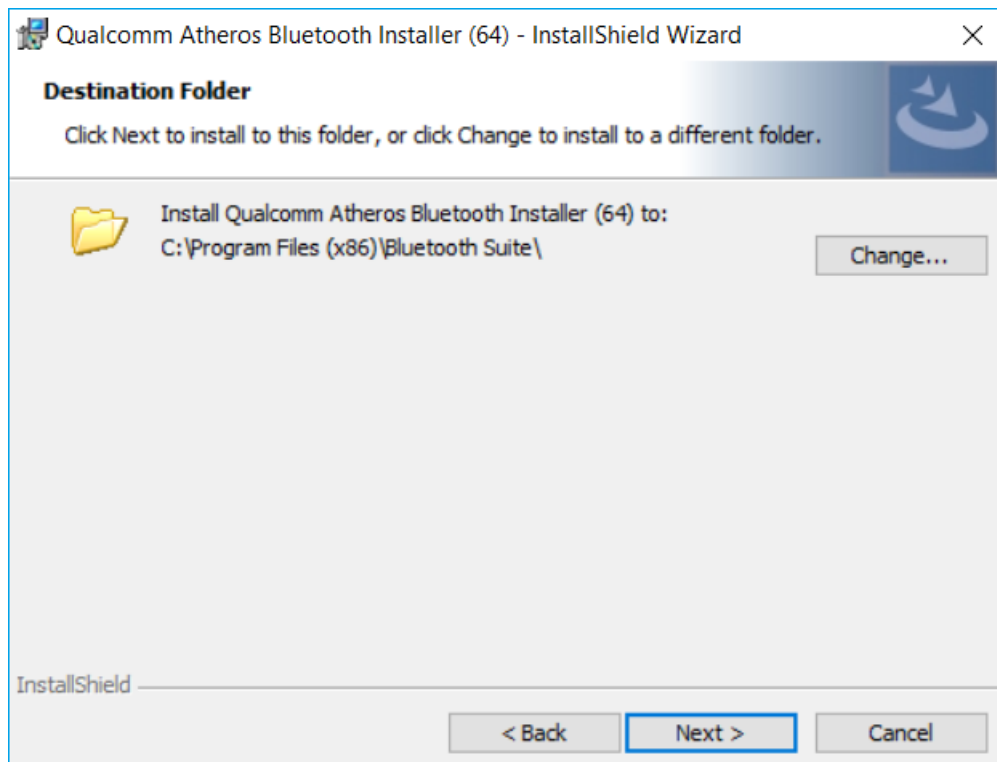

Fig. 10.11: Sparklan BT driver installation destination folder

3. Continue the installation with **Next**.

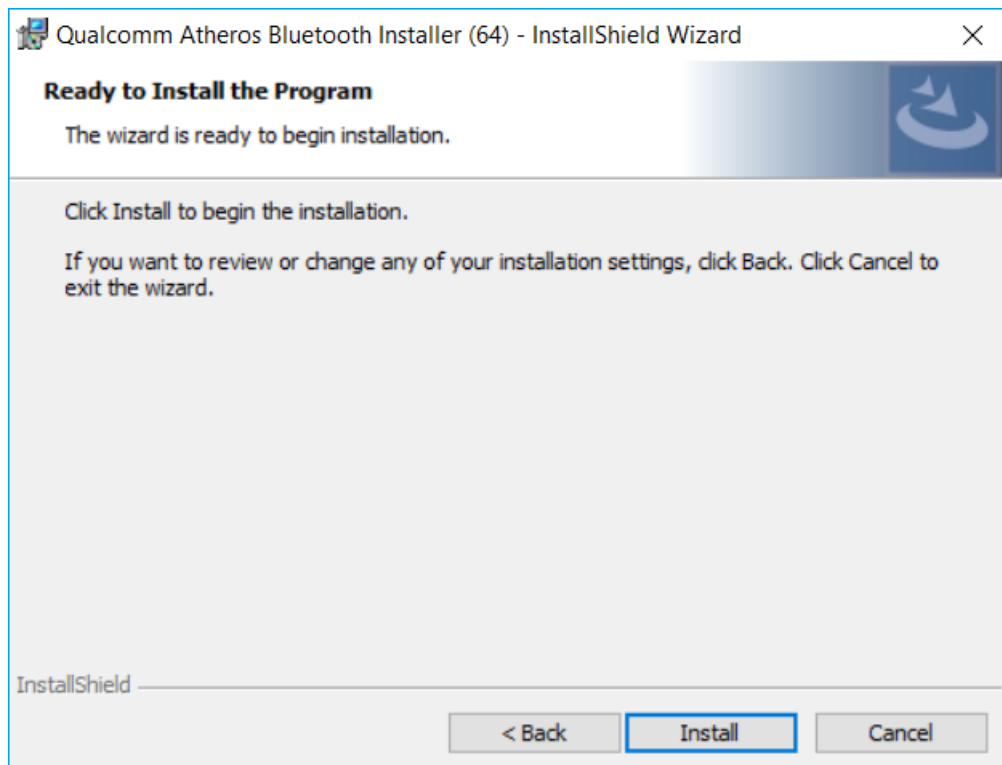

Fig. 10.12: Sparklan BT driver installation starts

4. Continue the installation of the required files with **Install**.

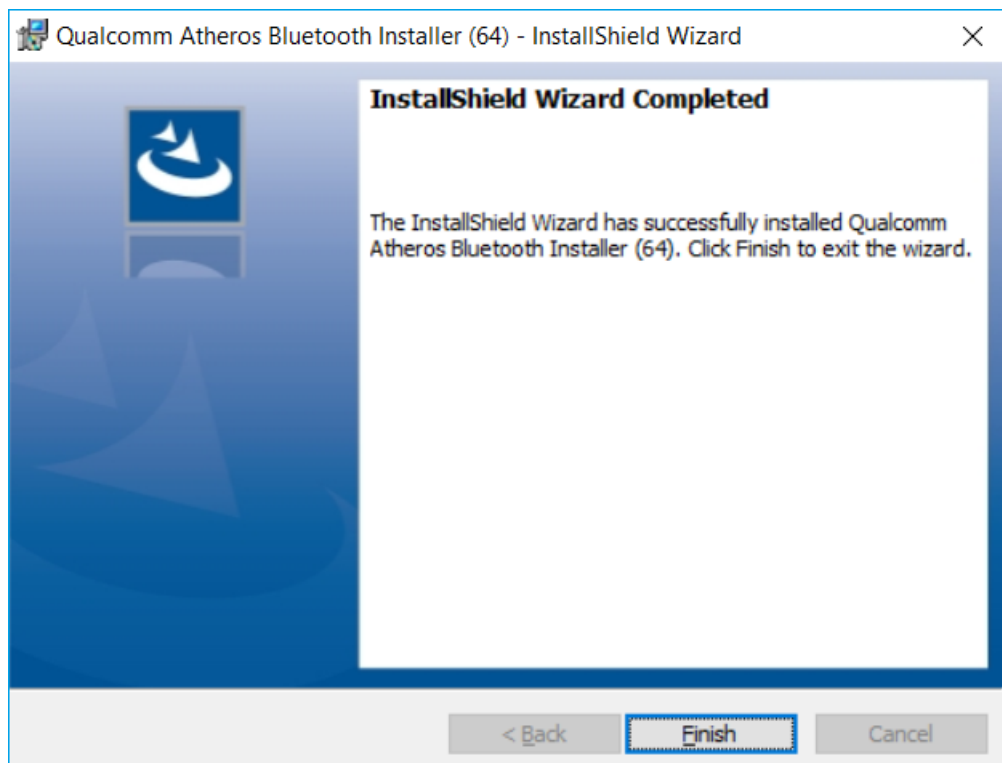

Fig. 10.13: Sparklan BT driver installation Exit with Finish

5. Exit the driver installation with **Finish**.

6. It is recommended to restart the system immediately after the installation.

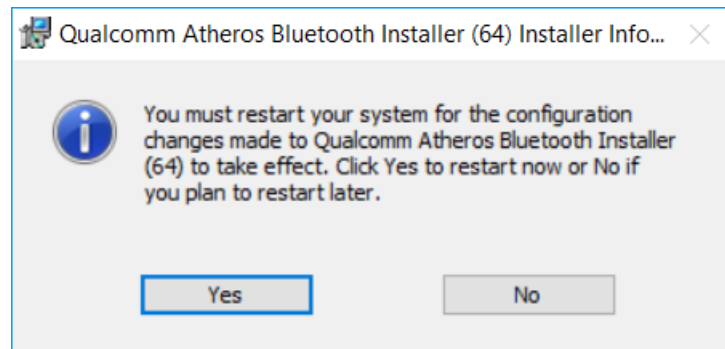

Fig. 10.14: Sparklan BT driver installation perform system restart

7. Continue with **Yes**.

The system restart is being performed.

10.8. Advantech WLAN Client Manager (IGX Tool)

10.8.1. Area of application

This chapter describes the **Advantech WLAN Client Manager** version 1.02 under the following OS:

- Win7Pro
- WES7
- Win10IoTEnt

Required: DLT-V72 with radio card **SPARKLAN WPEQ-261ACN (BT) MiniPCle**

10.8.2. Program version 1.01 (new features)

Advantech WLAN Client Manager program version 1.01 offers the following new features:

- “Silent installer” (does not require user interaction during whole process)
- “Silent uninstaller” (does not require user interaction during whole process)
- “Import / Export” feature of current configured wireless settings + profiles

10.8.3. Program version 1.02 (new features)

Advantech WLAN Client Manager program version 1.02 offers the following new features:

- Optimized “silent” installer / uninstaller
- Setup.exe GUI installation dismissed
- WES7 OS specific “PreInstall.bat” requirement dismissed
- Logging functionality added (allows capturing roaming details for debug purpose)
- Updated threshold values for default “fast roaming behavior”
- Updated WLAN driver version **v11.0.0.627**

10.8.4. Driver download

The currently available IGX drivers can be downloaded from the following website:

www.advantech-service-iot.eu -> Downloads -> Service -> Drivers -> Link to FTP:

Advantech-DLoG_Products\Additional-Drivers-
Software\WLAN_driver\X86_(DLoG_MPC_MTC_IPC_series\Sparklan_261_ACN_BT

Once the download has completed, the contents of the ".zip" directory on the desktop must be unzipped.

NOTE



Requirements:

The IGX driver needs a valid license.

*The following steps should be performed as the **Administrator** for the installation process.*

10.8.5. After image reinstallation: Driver installation

If the image has been reinstalled, the DLT-V72 must be set up again using the IGX WLAN driver. Two drivers are available:

- Driver for Win7Pro and WES7
- Driver for Win10IoTent

10.8.6. “Silent” Driver installation WES7 / Win7Pro / Win10IoTent

1. Open the corresponding installation directory depending on the operating system.
2. Run “**Silent_Install.bat**” (**Run as administrator**) to start the installation.
3. Confirm the Windows UAC (**User-Account-Control**) message.

The installation process will be done automatically in background and takes around 2 minutes.

At the end of process, no dialog will be shown to user and system restart is required.

NOTE



*Please allow **2 minutes** waiting time that process can be finished successfully before restarting the system.*

10.8.7. “Silent” Driver uninstaller WES7 / Win7Pro / Win10IoTent

1. Open the corresponding installation directory depending on the operating system.
2. Run “**Silent_UnInstall.bat**” (**Run as administrator**) to start the uninstall process.
3. Confirm the Windows UAC (**User-Account-Control**) message.

The uninstall process will be done automatically in background and takes around 2 minutes.

At the end of process, no dialog will be shown to user and system restart is required.

NOTE



*Please allow **2 minutes** waiting time that process can be finished successfully before restarting the system.*

*Please use **ONLY** the prepared **batch file** for the uninstall process and **NOT** the standard Windows Add / Remove programs function!*

10.8.8. Start WLAN Client Manager, Login

1. Launch the WLAN Client Manager by double-clicking the **Launch WCU** icon:

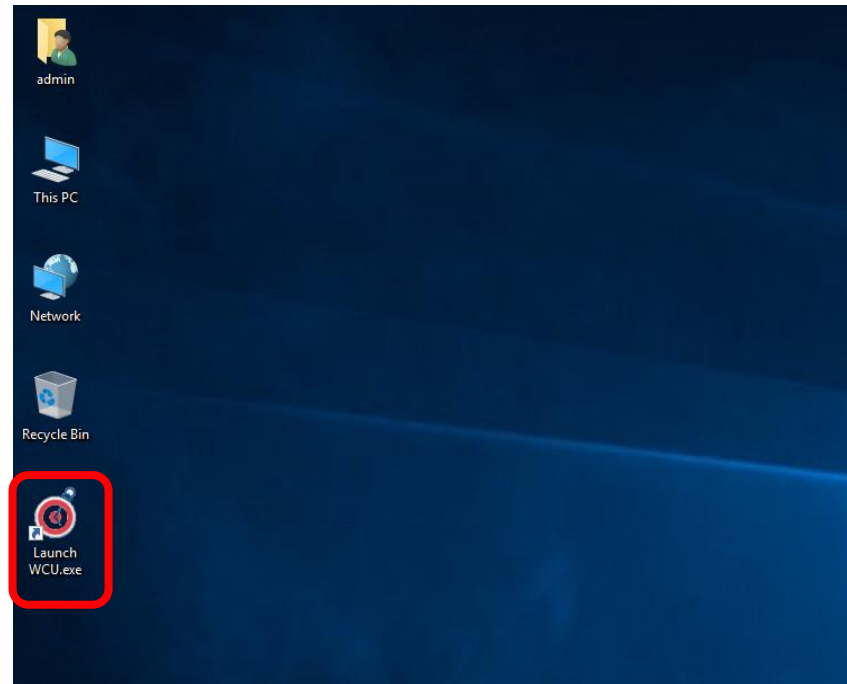

Fig. 10.15: WCU icon on the desktop

You must login as "WCU_Administrator" first.

2. To do this, click **Admin Login**.

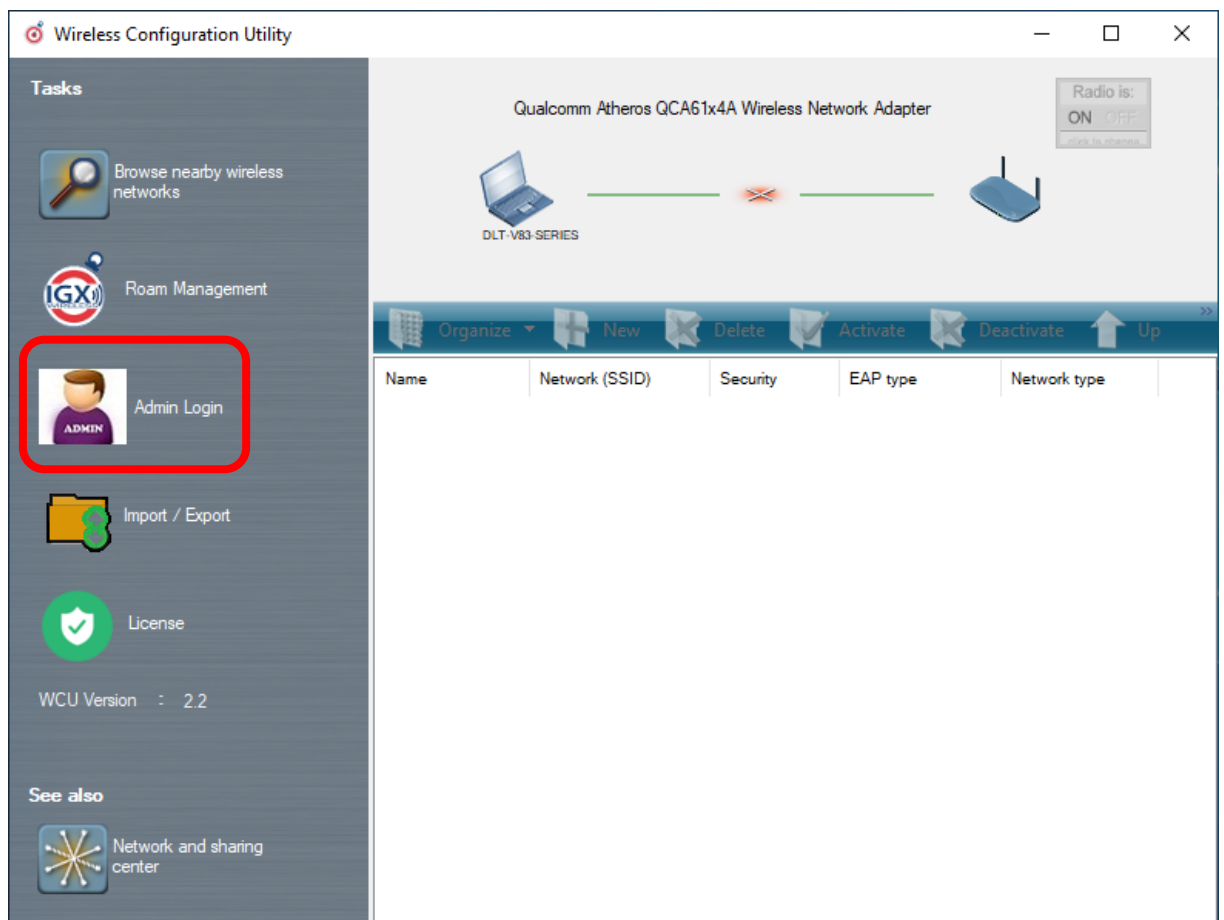

Fig. 10.16: WCU main window, Admin Login

3. Then open the login window.
4. Enter the passport, which by default is "gold".
5. Confirm the input with the **Login** button.

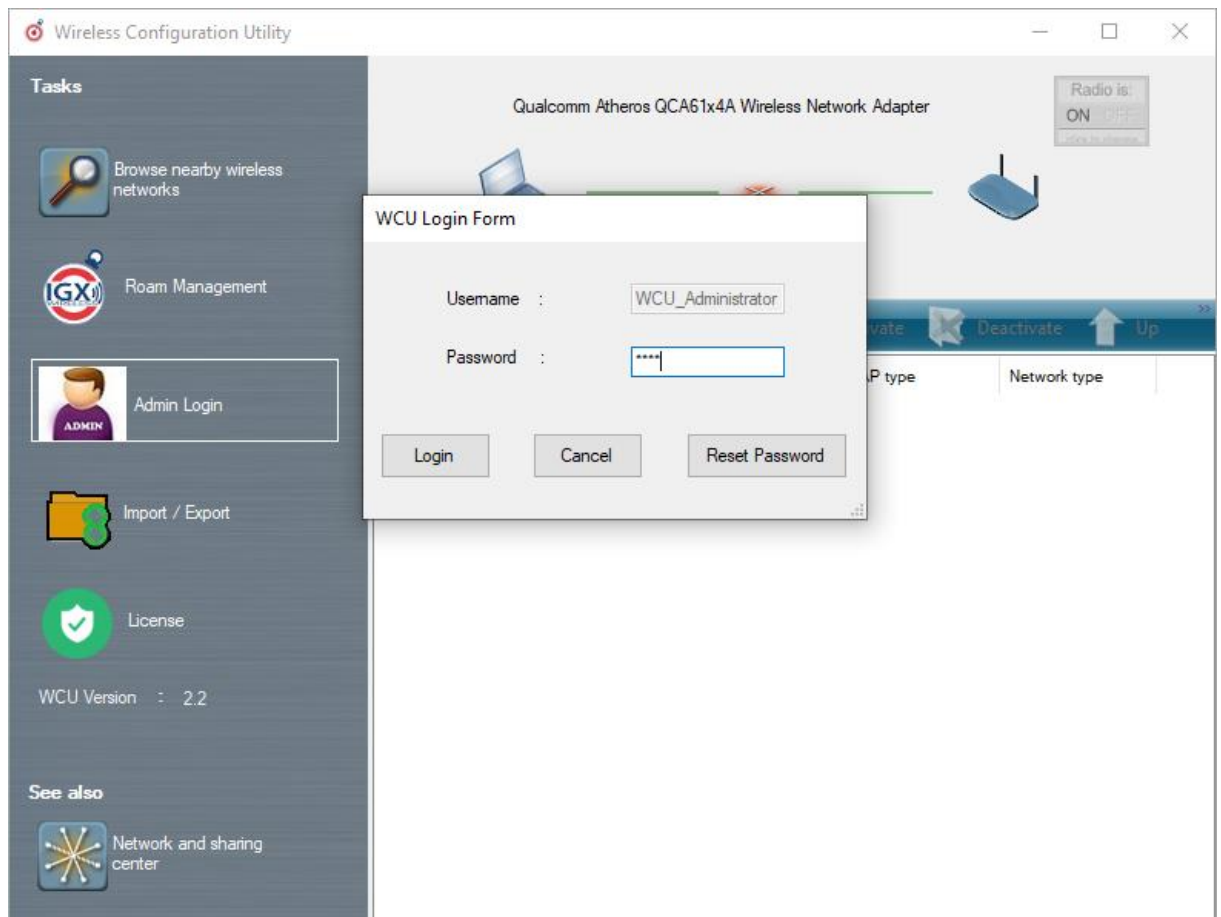

Fig. 10.17: WCU-Administrator login window

After successful Admin-login, speed buttons for managing profiles are available:



Fig. 10.18: Speed buttons for managing profiles

10.8.9. WLAN Client Manager Functions

License

The **License** function lists the current status of the enabled options:

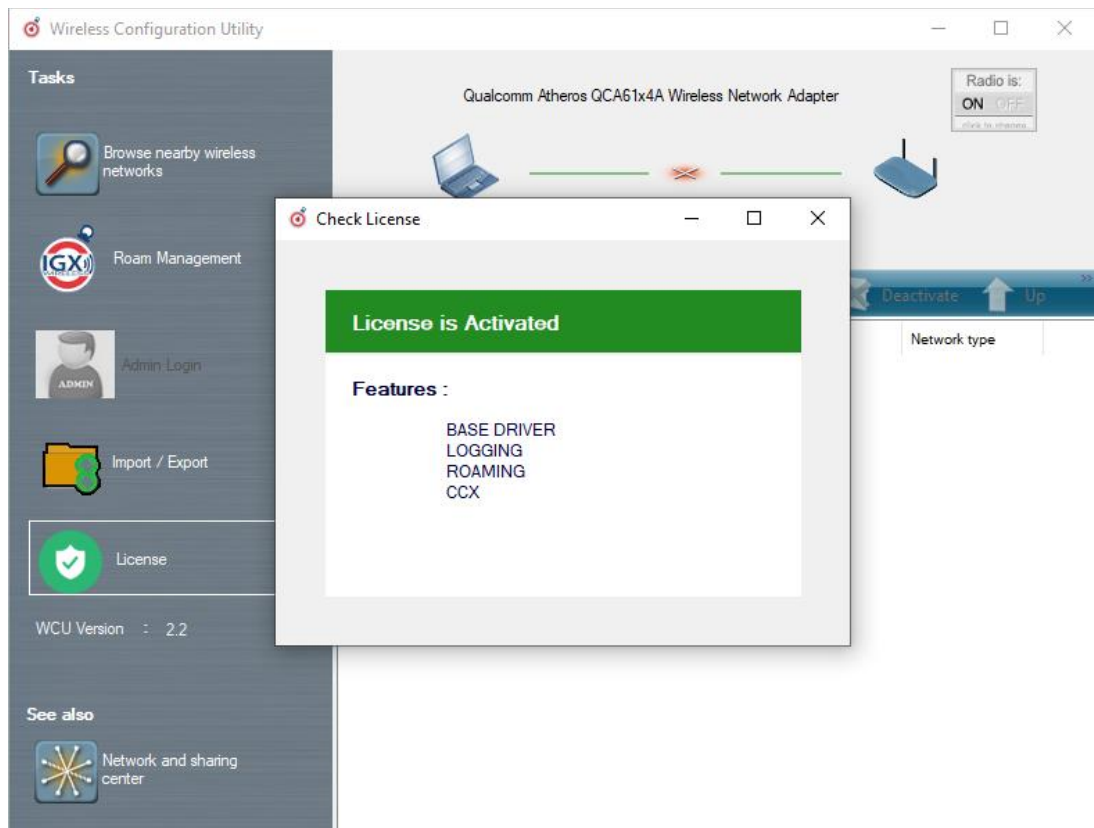

Fig. 10.19: Check License

NOTE



The correct implementation of the WLAN driver requires a valid license in combination with the DLT-V72 terminal.

If, as shown in the image, the license information is missing: Contact technical customer support to solve the problem.

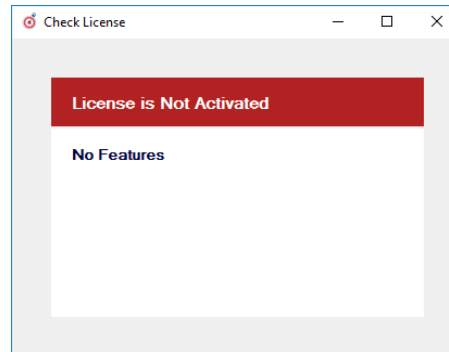

Fig. 10.20: Info display via existing license

10.8.10. Browse nearby wireless networks

Set up the WLAN connection

To set up a WLAN connection, you can show all available networks using the **Browse nearby wireless networks** function.

You can select the appropriate network from here.

1. Double-click a network name (SSID).
Dialog **Create new profile** is available now.

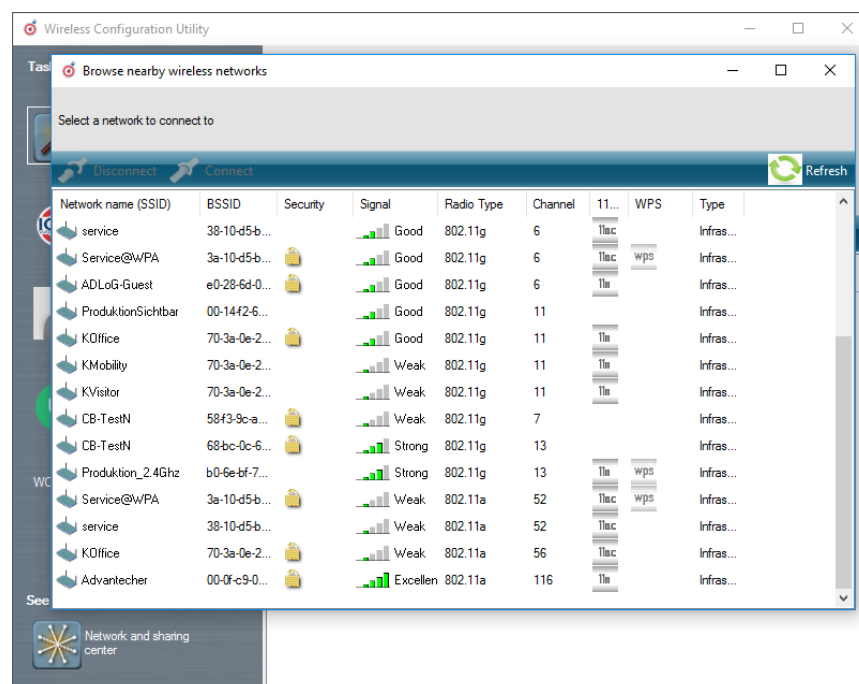

Fig. 10.21: Browse nearby wireless networks function

Define security settings

The security settings must be selected (depending on the network).

These settings can be made in the **Advanced Security Settings** section:

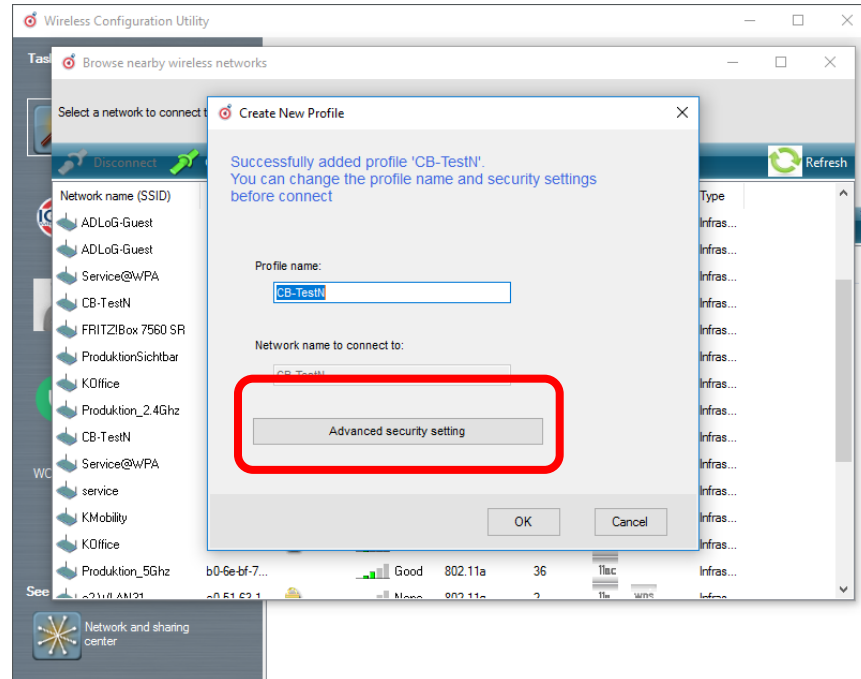

Fig. 10.22: Advanced Security Settings dialog

To be able to connect with the network automatically, set the checkmark to **connect automatically when the network is in range**:

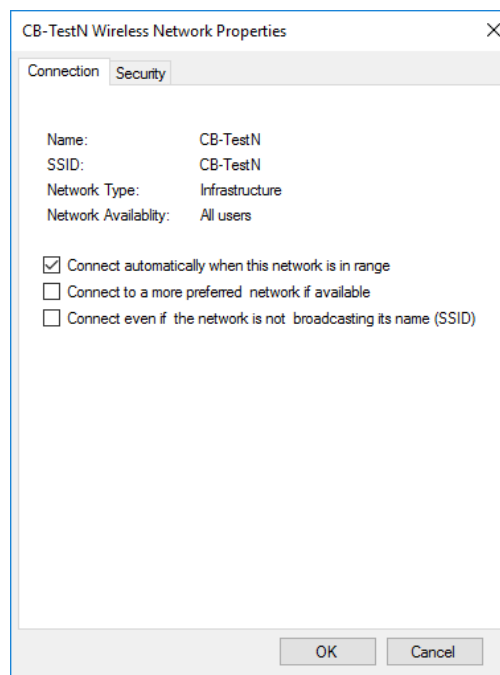

Fig. 10.23: Connection when the network is in range dialog

Available parameters in the **Connection** and **Security** sections:

| | |
|---|--|
| Connect automatically when the network is in range | Enable this parameter to set up an automatic connection to the network. |
| Connect to a more preferred network if available | In the event of multiple profiles being present, this option can be used to select the preferred profile. |
| Connect even if the network is not broadcasting its name (ssid) | This option can be used to set that a connection is still established when the name of the network is not being transmitted. |

The **security settings** (*Fig. 10.22: Advanced Security Settings dialog*) must be adapted. These settings differ depending on the network.

The **Security Type** must be selected first. The following options are available:

- No authentication (Open)
- WPA2-Personal
- WPA2-Enterprise
- CCKM

The encryption process (**Encryption Type**) is selected then. The options available here depend on the selected **Security Type**.

- None
- WEP
- AES

This results in the following selection options and settings:

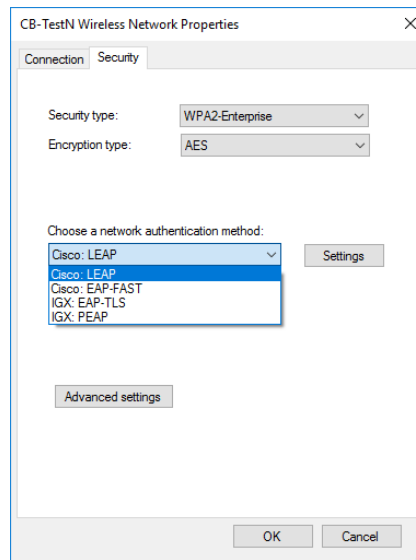

Fig. 10.24: Security settings - network authentication methods

The **network authentication methods** shown, as well as their designations, differ depending on the operating system used. For the remaining settings as in the case shown above (**Cisco: Leap**), the required additional parameters are carried out using the two buttons **Settings** and **Advanced settings**.

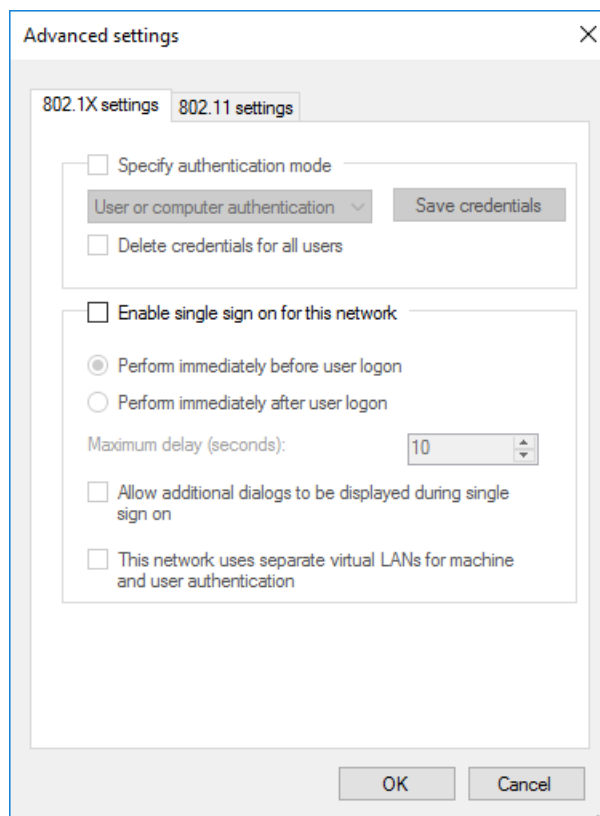

Fig. 10.25: Security settings – Advanced settings (Cisco: Leap)

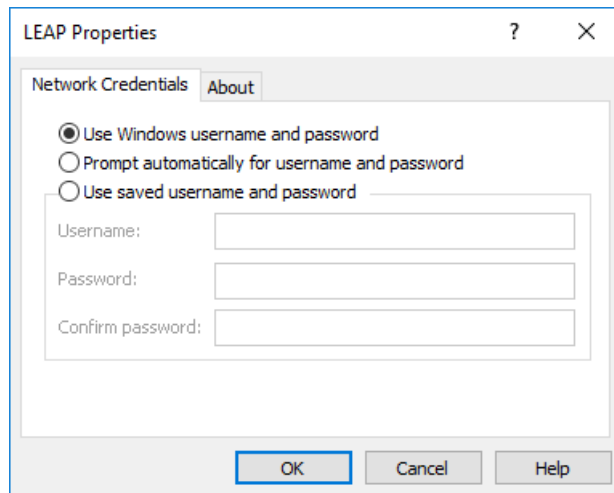

Fig. 10.26: Security settings – LEAP properties

2. Lastly, the network key must be entered in the following example (**WPA2-Personal**) (**Network Security Key**).
3. Confirm the settings with **OK**.

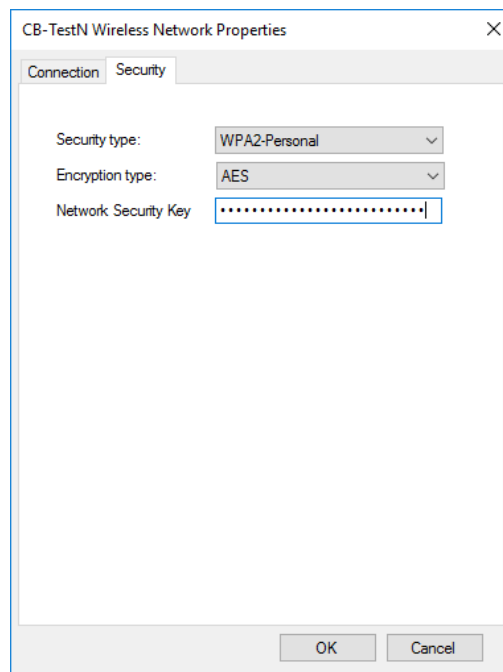

Fig. 10.27: Wireless Network properties dialog

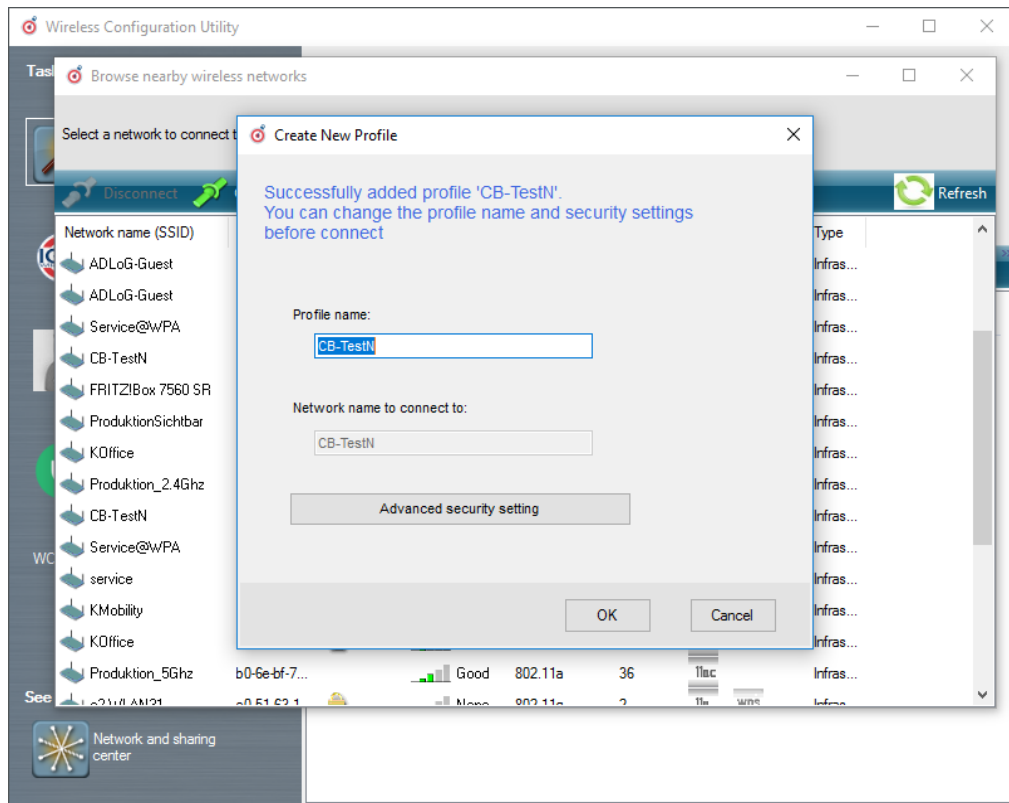

Fig. 10.28: Create new profile dialog

4. Confirm the new profile with the **OK** button.

Establish network connection

After the WLAN profile settings have been made, a connection to the network is established automatically.

The connection setup with the selected network is successful only if the "green" connection line is displayed in the **WCU** main window.

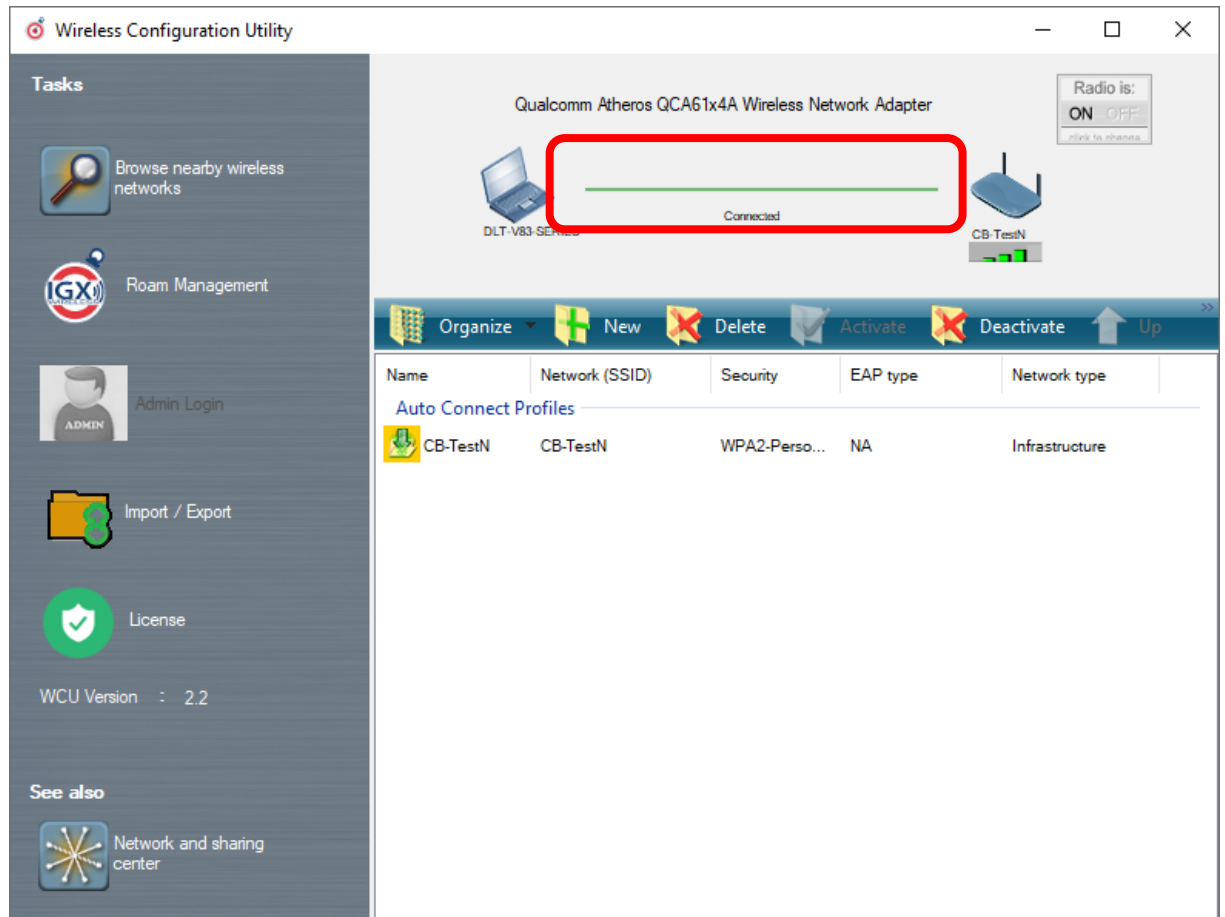

Fig. 10.29: Network connection is established

10.8.11. Roam Management

General tab

After clicking the **General** dialog, the following information is displayed on the screen:

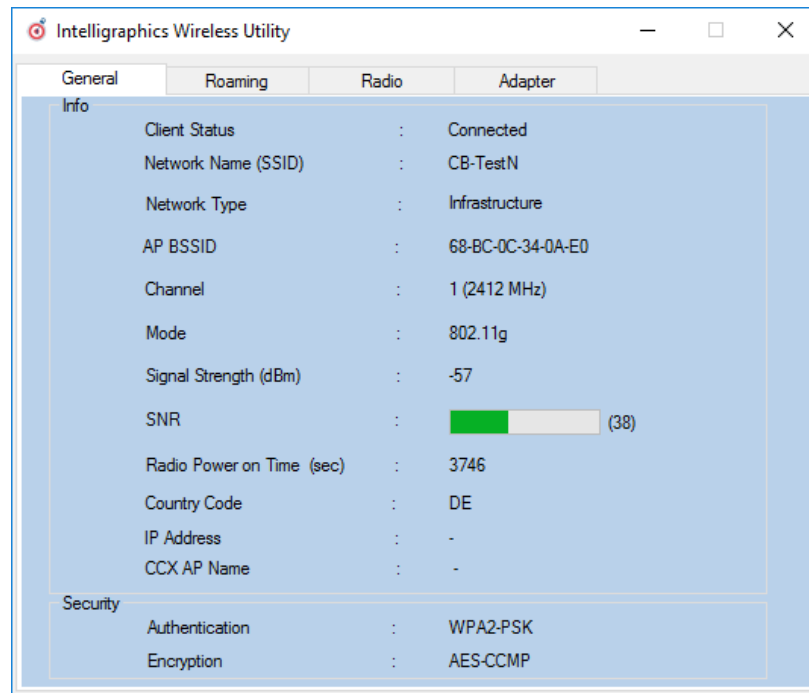

Fig. 10.30: General dialog in the Roam Management menu

Info section

| Info | Meaning of the display |
|---------------------------|---|
| Client Status | Current connection status: Connected / Disconnected |
| Network Name SSID | SSID of the currently connected access points |
| Network Type | Network type Ad-hoc or Infrastructure |
| AP BSSID | Corresponding MAC address of the currently connected access points |
| Channel | Displays the configured channel used in the access point |
| Mode | Frequency band used, e.g. "802.11g" |
| Signal Strength (dBm) | Current signal strength of the connected access points in (dBm) |
| SNR | Relative signal strength (SNR) as bar chart |
| Radio Power on Time (sec) | Display of the current elapsed operating time of the Radio card |
| Country Code | The country code supplied by the access point such as US, DE, JP |
| IP Address | The Client IP address configured by the access point (DHCP) or manually (static) assigned |
| CCX AP Name | SSID of the Cisco CCX Access Points (if present) |

Security section

| | |
|----------------|--|
| Authentication | The authentication process used, e.g. WPA2-PSK (Pre-Shared-Key) |
| Encryption | Display of the corresponding encryption process, e.g. (AES-CCMP, TKIP) |

Roaming tab

The **Roaming** dialog is used to define the following parameters:

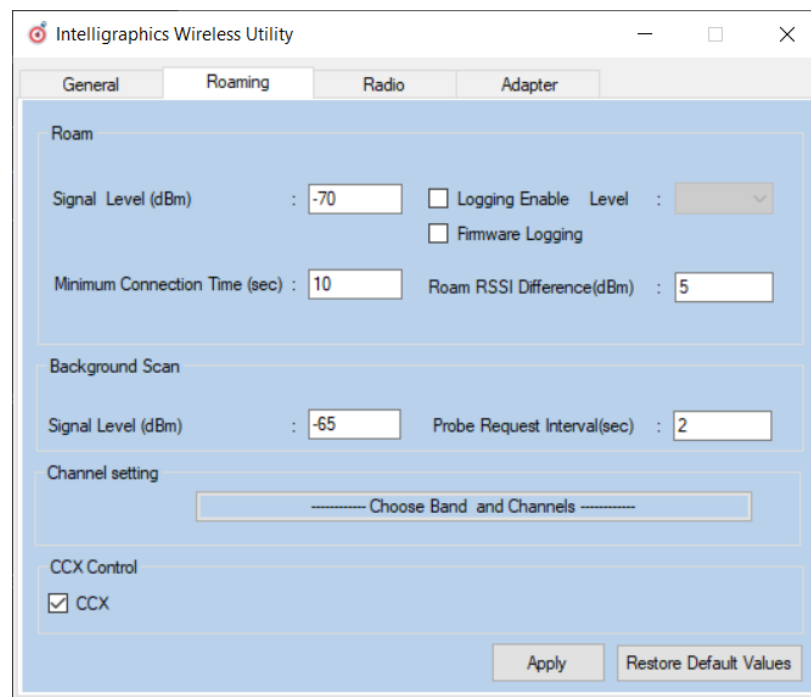

Fig. 10.31: Roaming dialog in the Roam Management menu

Roam section

| | |
|-------------------------------|--|
| Signal Level (dBm): | <p>The client decides to roam only when the current signal strength is weaker than the setting value and the new visible access point has higher signal strength (defined in <i>Roam RSSI Difference</i>). Possible values: -55 dBm to -80 dBm</p> <p>Default value: -70 dBm (adjustable in 5 dBm increments)</p> |
| Minimum Connection Time (sec) | <p>This setting defines how long the client is to remain connected to the current access point before roaming to the new access point starts.</p> <p>Possible values: 5 to 25 seconds</p> <p>Default value: 10 seconds</p> |
| Logging Enable Level | <p>This setting can be used to define that the activities of the driver are recorded in a log. Two levels are available: Critical and All.</p> <p>Critical: If the debug level is set to Critical, only the critical messages from the driver will be recorded.</p> <p>All: If the debug level is set to All, all messages from the driver will be recorded.</p> <p>The log file is saved in the C:\WlanLogs folder and a current timestamp is added.</p> <p>If the log file is larger than 100 mb, a new file is created.</p> <p>NOTE: This option should only be enabled for short periods for analysis purposes, not permanently!</p> |
| Firmware Logging | <p>Option can be enabled to create a "Firmware" log.</p> <p>The log file is saved to the C:\WlanLogs folder and is assigned the current timestamp and the extension _fw.</p> <p>If the log file is larger than 100 mb, a new file is created.</p> <p>NOTE: This option should only be enabled for short periods for analysis purposes, not permanently!</p> |
| Roam RSSI Difference (dBm) | <p>The client will not connect to the new access point until the defined RSSI difference between the new visible access point and the currently connected access point is reached. Proper difference could avoid unnecessary roaming frequency.</p> <p>Possible values: 5 dBm to 25 dBm</p> <p>Default value: 5 dBm</p> |

Background Scan section

| | |
|------------------------|---|
| Signal Level (dBm) | <p>The client begins the background scan only when the current signal strength is weaker than the setting value.</p> <p>Possible values: -55 dBm to -80 dBm</p> <p>Default value: -65 dBm</p> |
| Probe request interval | <p>This setting is used to define how frequently the probes are to be sent when the client is in the "Connected" status.</p> <p>The minimum value here is 1 second.</p> <p>The maximum value is 10 seconds.</p> <p>Each scan process (repetition) takes 4 to 5 seconds.</p> |

Clicking the **Choose Band and Channels** button opens the following dialog:

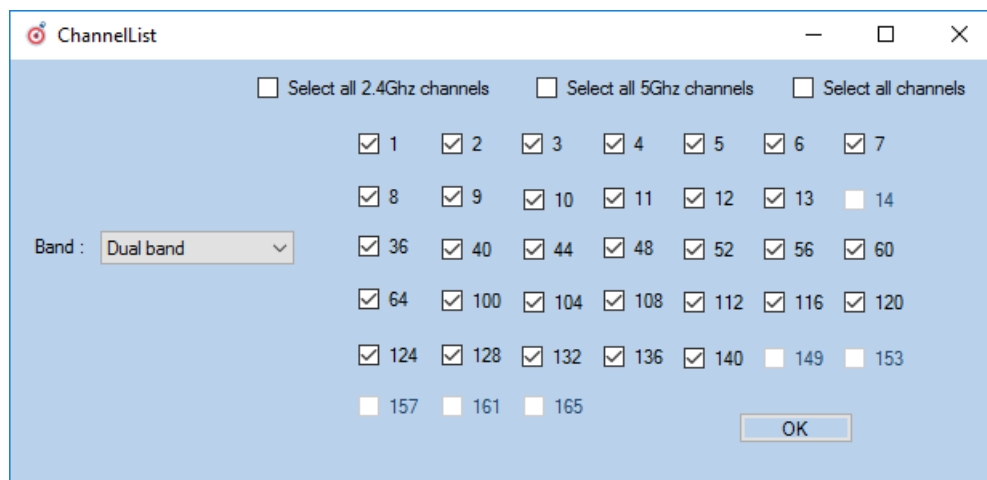

Fig. 10.32: Roam Management – Choose Band and Channels

Channel List

| | |
|----------------------------|--|
| Select all 2.4Ghz channels | <p>This option can be used for simultaneous pre-selection of all 2.4 GHZ channels 1 to 13 supported by the WLAN driver.</p> <p>Modifications to individual channels can be carried out at any time by clicking the checkboxes for each channel.</p> <p>NOTICE: Country-specific channel settings / residual restrictions on the use of special channels should be set according to the legal guidelines and must be observed!</p> |
| Select all 5Ghz channels | <p>This option can be used for simultaneous pre-selection of all 5 GHZ channels 36 to 140 supported by the WLAN driver.</p> <p>Modifications to individual channels can be carried out at any time by clicking the checkboxes for each channel.</p> <p>NOTICE: Country-specific channel settings / residual restrictions on the use of special channels should be set according to the legal guidelines and must be observed!</p> |
| Select all channels | Used to select or de-select the complete channel list 2.4/5 GHZ (to simplify channel selection). |
| Band | <p>The following selection options are available:</p> <ul style="list-style-type: none"> 2.4 GHz 5 GHz Dual band (2.4 GHz and 5 GHz) <p>The corresponding settings mean that only channels occurring in the frequency band are displayed for selection and de-selection.</p> |

CCX Control

| | |
|------------|--|
| CCX / CCKM | <p>The CCX specification (Cisco®Compatible eXtensions) contains a series of functional extensions to the IEEE 802.11 WLAN standard to support rapid roaming (CCKM): with improved security, reliability and diagnostic performance.</p> <p>The CCX specification is a brand from Cisco® and requires a license agreement to be able to equip mobile devices with this technology.</p> <p>Currently the CCX versions 4 (CCXv4) and 5 (CCXv5) are supported.</p> |
|------------|--|

Radio Tab

The **Radio** dialog is used to define the following parameters:

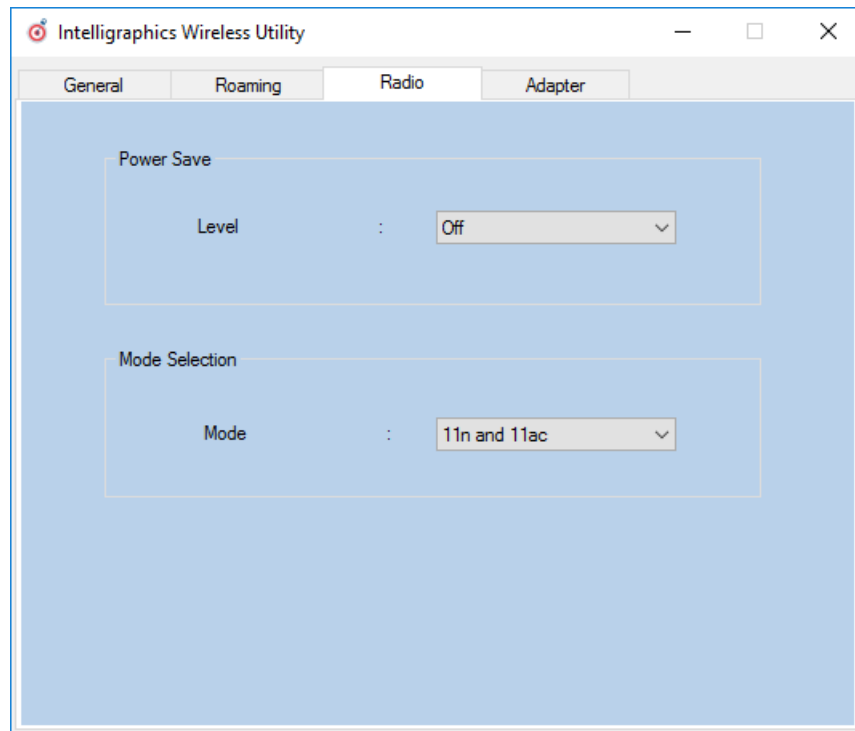

Fig. 10.33: Radio dialog in the Roam Management menu

| | |
|----------------|--|
| Power Save | The Power Save Level is set. The levels OFF and Auto-PSM are available. |
| Mode Selection | The client's band is specified. The possible options are: 11n and 11ac , 11n , 11a/b/g |

Adapter Tab

After clicking the **Adapter** dialog, the following information is displayed on the screen:

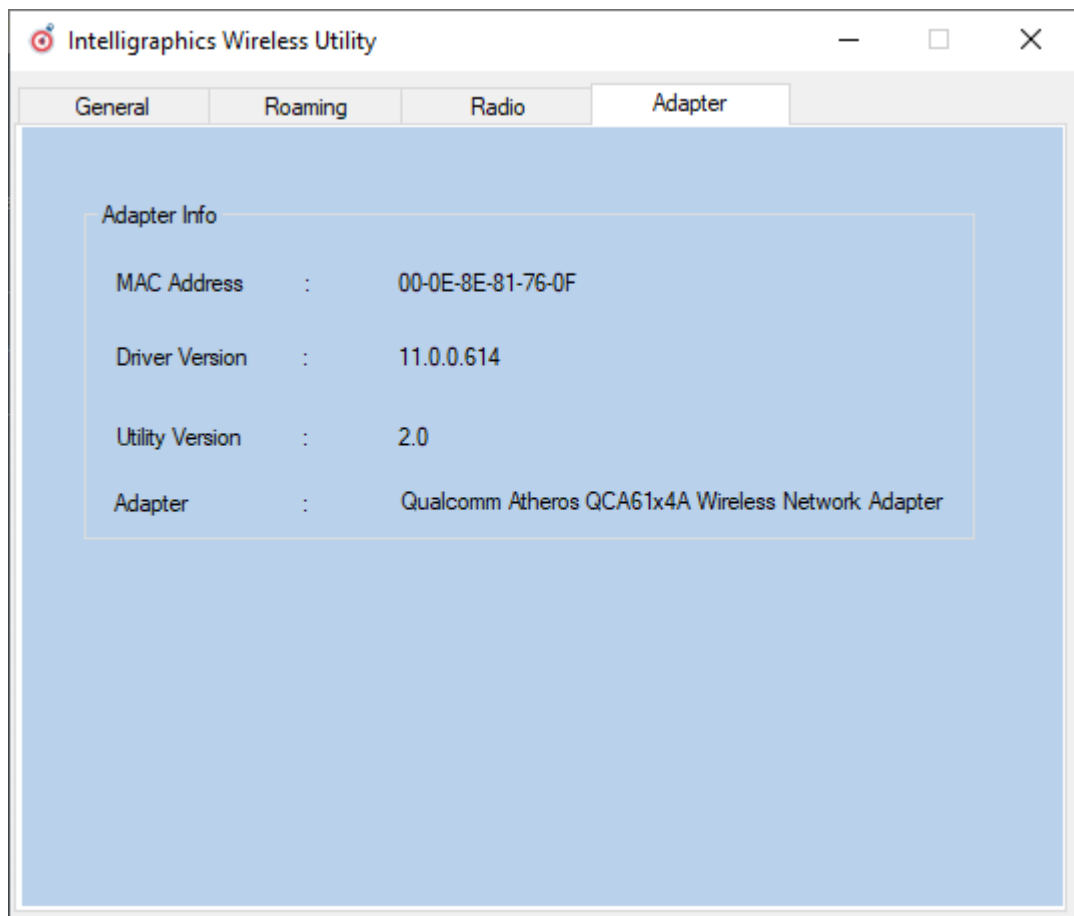

Fig. 10.34: Adapter Tab in Roam Management menu

10.8.12. Import / Export feature

This feature in program version 1.01 (or higher) allows export and import of configured WLAN profiles and settings.

The “OutputFile.txt” contains the following saved information:

- Roam parameters: Roam RSSI difference, Signal Level, Min Connection Time
- Background Scan Parameters: Signal Level, Probe Request Interval
- Band and Channel list
- CCX control state
- Radio Tab: Power Save Level and Mode

To start importing or exporting WLAN configuration file including all defined profiles click at **Import / Export** button.

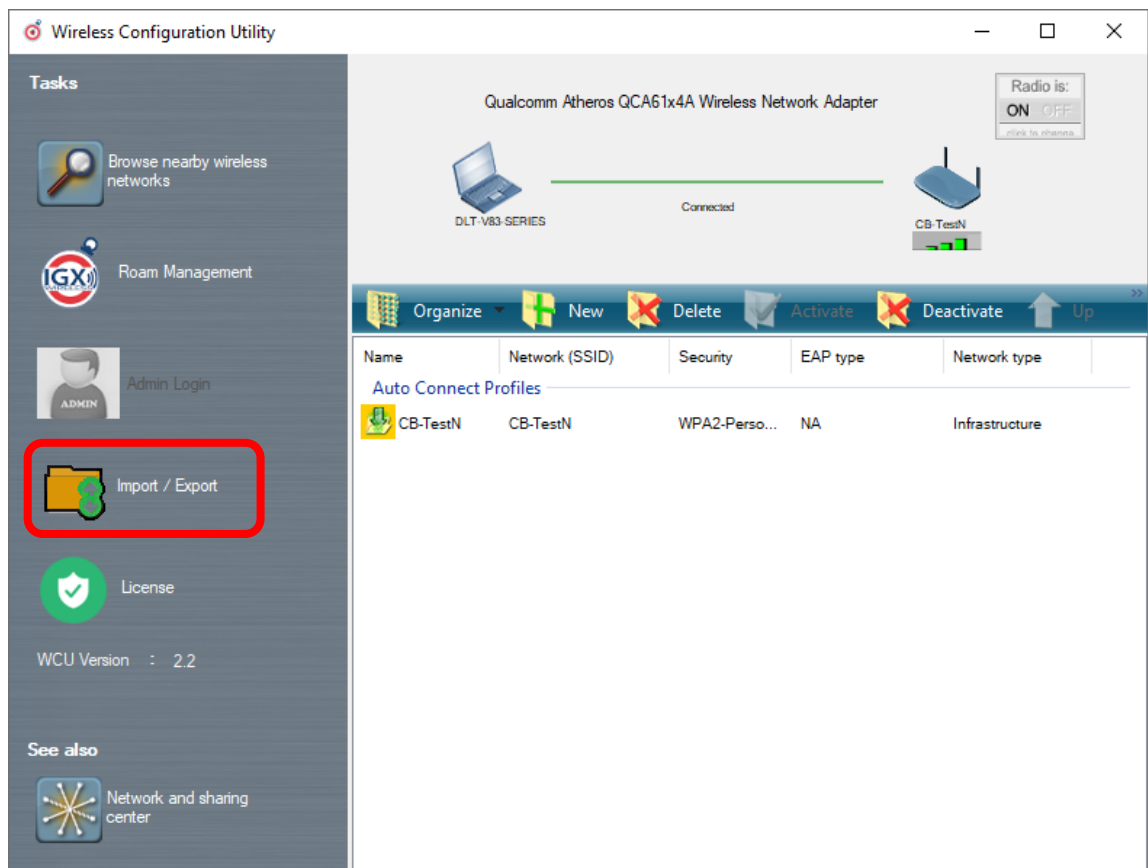

Fig. 10.35: WLAN Client Manager - Import/Export feature

The following dialog will be shown:

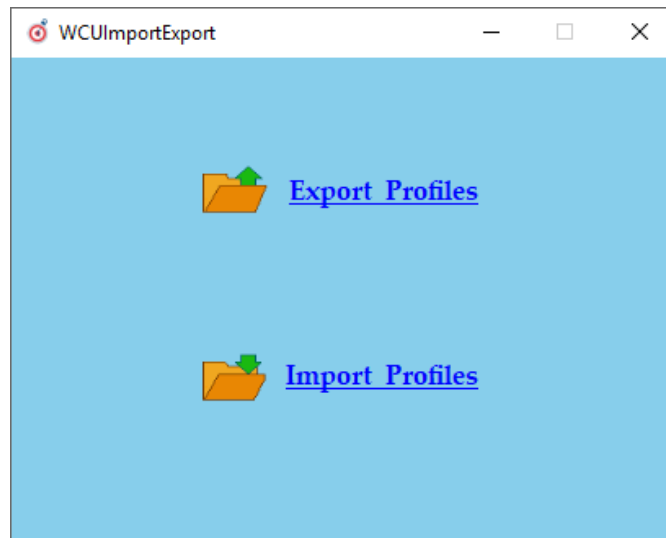

Fig. 10.36: WLAN Client Manager - Import/Export dialog

Choose **Export Profiles** to create an “OutputFile.txt” using standard windows directory dialog for free selectable file location:

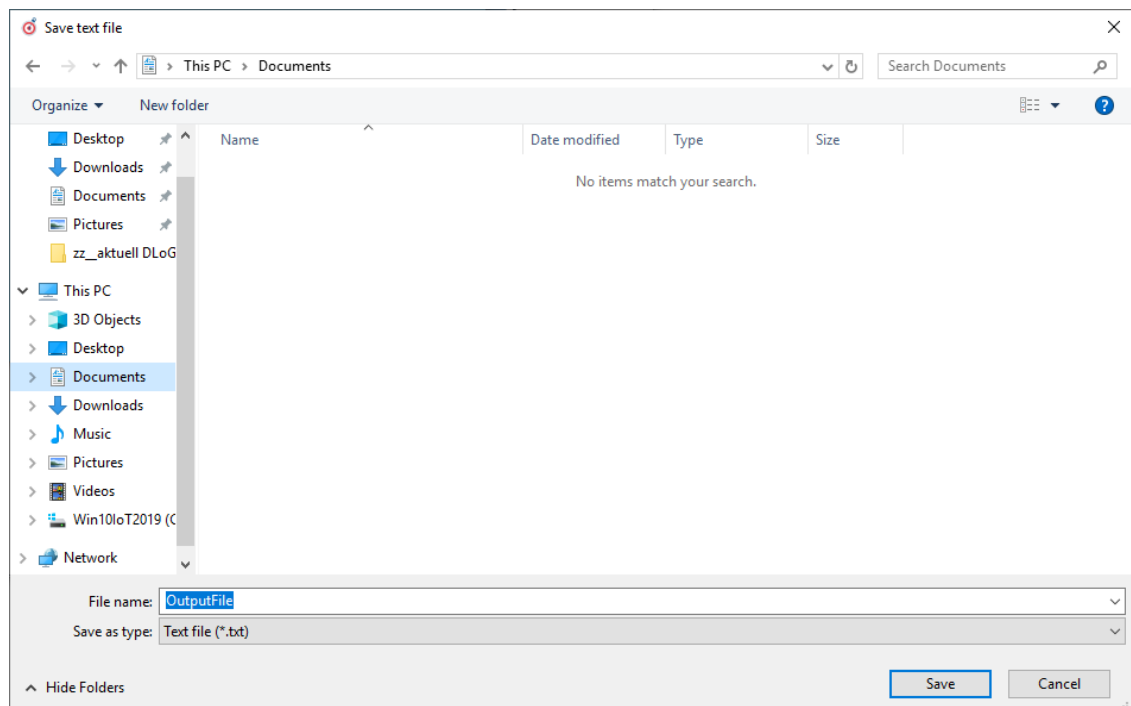

Fig. 10.37: WLAN Client Manager - Export Profiles in OutputFile.txt

With button **Save** “OutputFile.txt” will be generated followed by message:

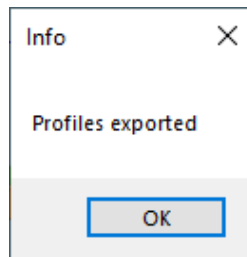

Fig. 10.38: WLAN Client Manager - Info box Profiles exported

Import process requires afterwards to select an existing “OutputFile.txt”:

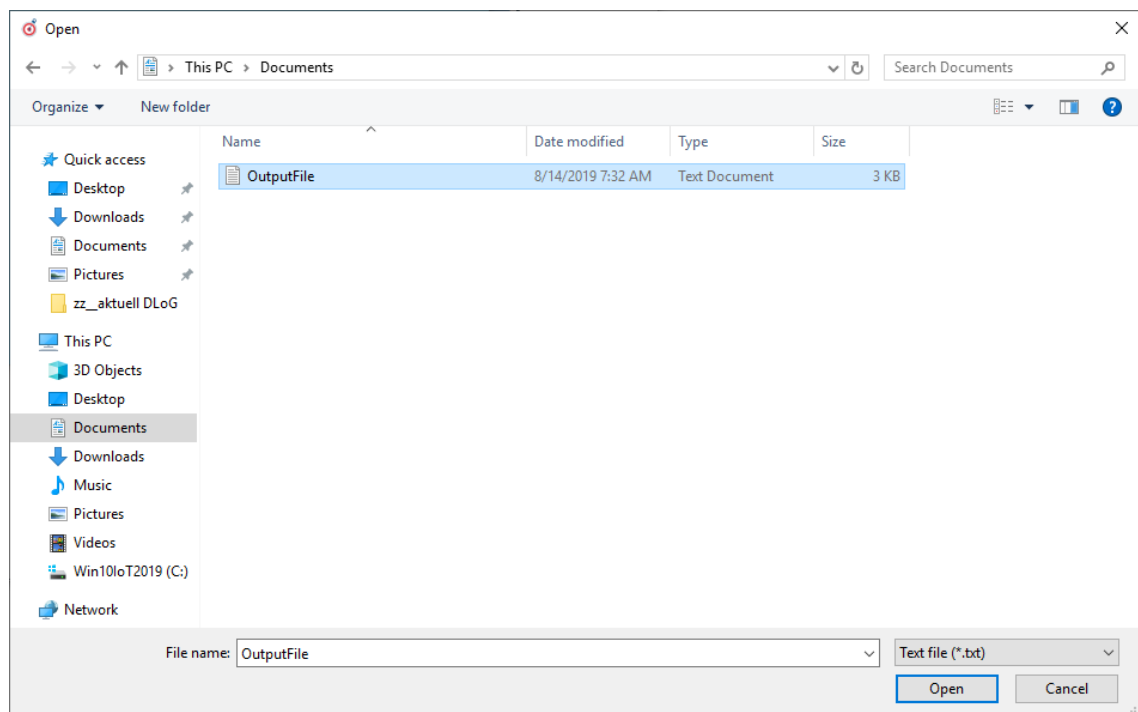

Fig. 10.39: WLAN Client Manager - Select an existing “OutputFile.txt”

By clicking **Open** button the file will be imported (existing setup will be overwritten during this process!)

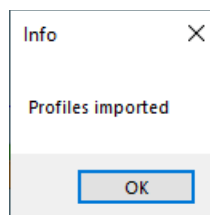

Fig. 10.40: WLAN Client Manager - Info box Profiles imported

“Auto” Import wireless settings file as part of “silent” driver installation

This option is useful for multiple installation scenarios to skip the graphical dialog that requires admin login to import the wireless setting automatically as part of “silent” driver installation process.

1. Rename the “OutputFile.txt” file to “config.txt”
2. Place the file into the following directory part of driver installation:

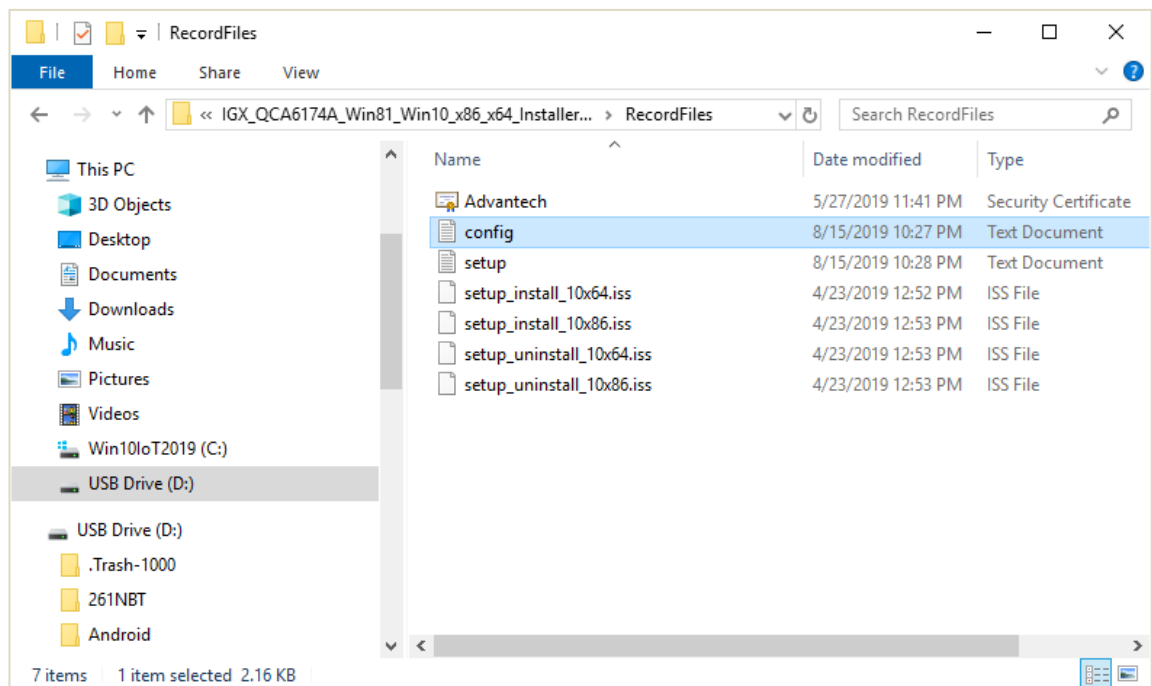

Fig. 10.41: Start „Auto” Import of a WLAN settings file

Driver installer path is variable, example:

`\\%Driver_Installer%\RecordFiles\config.txt`

Run **Silent_Install.bat** from driver installation root directory to start the installation.

The wireless profiles and settings will be installed next to driver.

After the required reboot the wireless connection will be set up automatically based on imported settings:

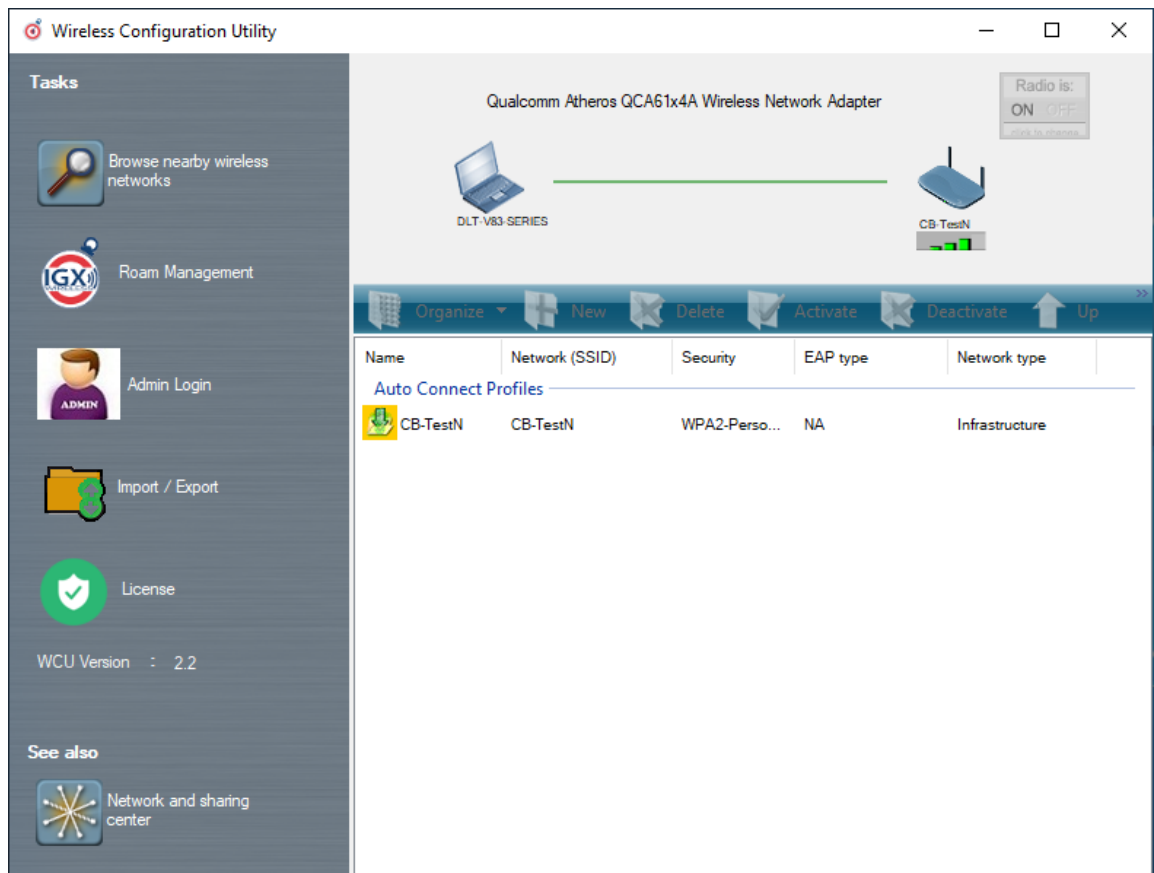

Fig. 10.42: Successful „Auto” Import of a WLAN settings file

11. WWAN Configuration

11.1. Safety notes

CAUTION



Danger of radiation.

DLT-V72 devices with radio technology emit high frequency energy (abbreviation: HF). To protect persons and domestic animals against HF radiation:

1. *Observe section 2.4 HF Radiation in the Safety Chapter of this manual.*
2. *Observe all applicable regulations for your deployment location/country with regard to operating channels, radio frequencies and the maximum permissible transmitting power.*

Examples of country-specific regulations

| Region | Radio approval |
|---------------|-----------------------|
| EU | RED (formerly R&TTE) |
| China | SRRC |
| Japan | MIC (formerly TELEC) |
| Taiwan | NCC |
| Canada | Canada IC |
| USA | FCC |

11.2. Preparation work at the factory (delivery status)

The following preparations have already been carried out at the factory for the optional WWAN functionality of the DLT-V72:

- The WWAN radio card and the corresponding drivers are installed.
- GNSS is enabled at the factory

NOTICE **Prevent system malfunction and property damage**

Radio cards are located inside the devices and are not accessible from the outside. Only the manufacturer and its authorized service centers may open the device and install/remove radio cards.

11.3. SIM card for WWAN (customer-specific)

A SIM card is required in addition to the WWAN card. The SIM card must be plugged in into the SIM card slot underneath the DLT-V72 antenna.

NOTICE **Prevent system malfunction and property damage**

Before opening the antenna:

Please refer to chapter [7.2 Connectors under the antenna](#) to find information about correctly opening and closing the antenna (required tools, etc.).

Inserting the SIM card: DLT-V72 must be switched off!

NOTE



If the SIM card contains a PIN, the customer must set up an application for the PIN query. For this reason, we recommend not using a PIN

11.4. Configuration of Radio card QUECTEL EC25

The following information is valid for the radio card **QUECTEL EC25**. Its precise designation is:

- USA: QUECTEL EC25A or EC25V
- Europe: QUECTEL EC25E

The WWAN configuration is identical for both radio cards. For this reason, the abbreviation **QUECTEL EC25** is used.

11.4.1. Establish Internet connection

In the section below, the provider **Vodafone** is used as an example. Adjust the settings for your provider.

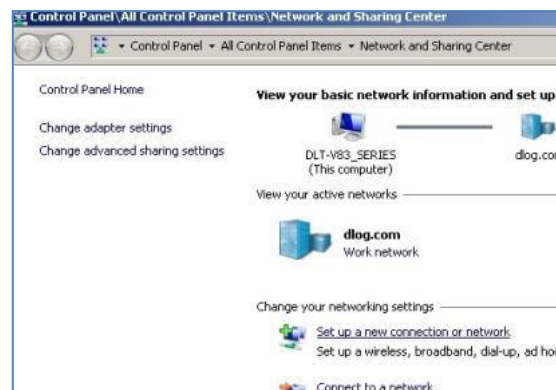

1. Open the Network and Sharing Center.
2. Click Set up a new connection or network.

Fig. 11.1: QUECTEL EC25 - Set up a new connection or network



3. Connect to the Internet - select and confirm.

Fig. 11.2: QUECTEL EC25 - Connect to the Internet

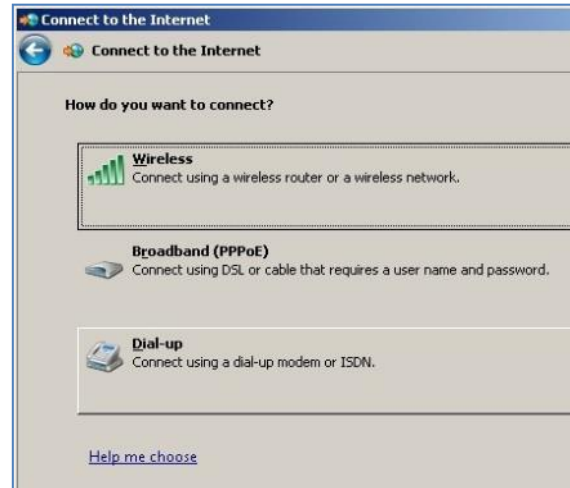

4. Click **Dial-up**.

Fig. 11.3: QUECTEL EC25 - Connect to the Internet - Dial-up

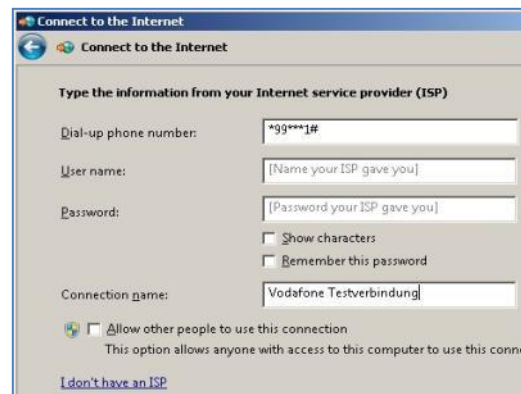

5. Specify as a telephone number, e.g. ***99***1#**.

6. Enter a connection name, e.g. **Vodafone test connection**.

Username and password are not required in the example. (Provider-dependent)

Fig. 11.4: QUECTEL EC25 - Connect to the Internet - Telephone number

7. Open the Vodafone test connection under **Network connections**.

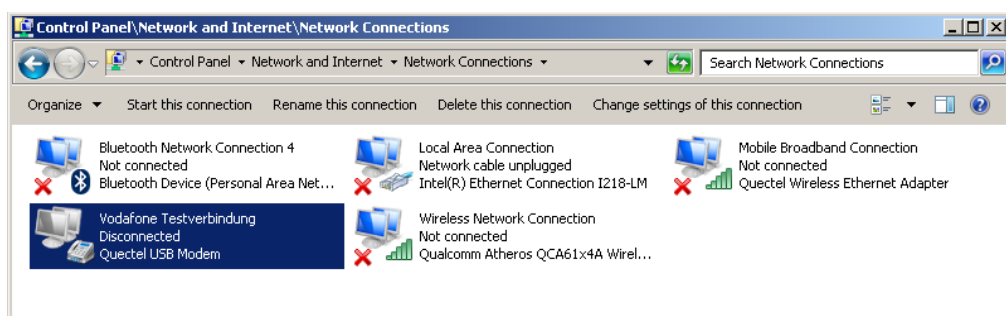

Fig. 11.5: QUECTEL EC25 - Network connections - Vodafone test connection



8. Do not enter a user name or password.
9. Click **Dial**. The test connection is established.

Fig. 11.6: QUECTEL EC25 - Dial Vodafone test connection

In the **Network and activation center** of the device, the status of the test connection can be tested:

10. Right-click the network and then select **Status**.

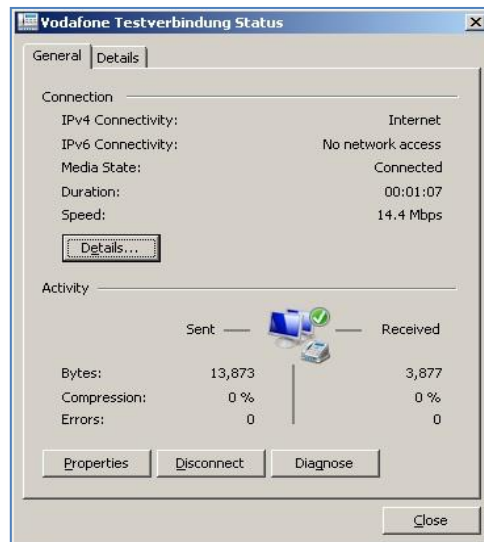

Fig. 11.7: QUECTEL EC25 - Function test GSM / GNSS, test connection status

11.4.2. Trouble Shooting

Test virtual COM ports

In the device manager it is possible to test that the virtual COM ports are correctly set.

If they are not correctly set, they must be modified as appropriate.

The virtual COM ports must be set up as shown in the figure:

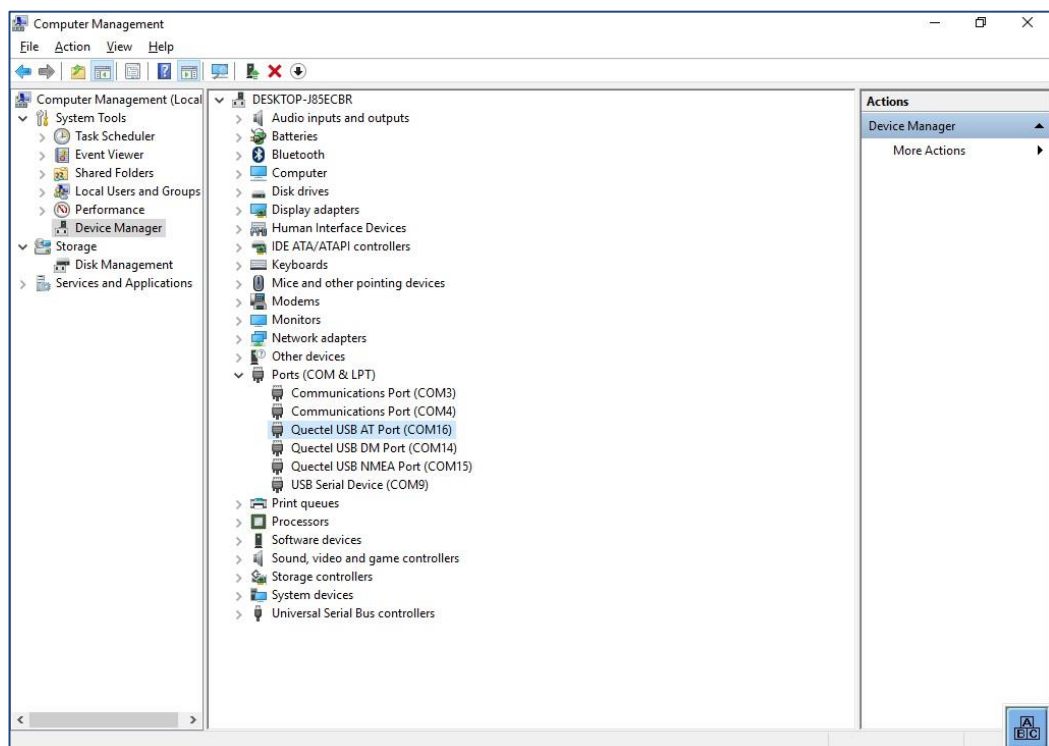

Fig. 11.8: QUECTEL EC25 - Virtual COM ports DLT-V72

12. Mechanical Installation



12.1. Safety notes

WARNING

Risk of personal injury and property damage due to improper mechanical installation.

These mounting instructions are directed to skilled personnel. Only qualified skilled personnel may perform the mechanical installation work on the DLT-V72.

1. Observe manual section 2.5 Information on safe mounting.

NOTICE

Prevent system malfunction and property damage

The front display of the DLT-V72 is protected during transport by a transparent film. This film should remain on the front display during assembly to avoid damage to the front display surface.

Only remove the film after all of the installation work has been completed.

12.2. Overview: Recommended mounting sequence

Requirement: The vehicle/installation location must be prepared (e.g. connection to the ignition, correct voltage, etc.)

1. Find a suitable installation position for the DLT-V72.
2. Secure the device mounting (RAM or mounting bracket) to the targeted subject/vehicle.
3. Connect external accessories to the DLT-V72.
4. Install an easily accessible disconnecting device such as a switch close to the device.
5. Connect all cables (power supply, peripherals).
6. Close off all unused cable openings of the rubber seal using the accompanying blind plugs so that they are sealed.
7. Close the DLT-V72 with the cable cover.
8. Install the DLT-V72 on the device mounting.

12.2.1. Mounting the DLT-V72 at the deployment location

WARNING



Risk of injury and damage due to improper deployment location.

1. *Observe the intended use of the DLT-V72, e.g. not in potentially explosive areas, not in life-supporting facilities.*
2. *Ensure that the deployment location of the DLT-V72 complies with the permissible environmental conditions.*
3. *The installation height of the device shall not exceed 2 m.*
4. *When installing the DLT-V72, make sure that if the bracket breaks (e.g. because of a stress fracture) no one will be injured.*
5. *Alternatively please put appropriate safety measures in place (e.g. install a security cable in addition to the mounting bracket).*
6. *To ensure that the limits set for exposure to radio waves are not exceeded: Install the DLT-V72 so that persons maintain a minimum distance of 20 to 50 cm to the antenna.*

Never install the system in a closed environment without cooling air!

NOTICE ***Prevent system malfunction and property damage***

Installation environment without cooling air can overheat / damage the DLT-V72.

The DLT-V72 employs a passive cooling concept whereby the waste heat generated inside the device is emitted from the surface of the housing. For this system to function properly, sufficient fresh air circulation is required. If there is no access to fresh cooling air, it may result in overheating and severe damage to the device.

Never install the system in a closed environment where the cooling air is unable to dissipate accumulated heat to the outside.

The maximum permissible ambient temperature for the entire system needs to be taken into account for the specific application area.

12.2.2. Electrically isolated DLT-V72 mounting

Due to a variety of technical properties of forklifts and forklift trucks, it can be necessary to electrically isolate DLT-V72 from the chassis of the vehicle to prevent malfunctions.

The necessity of this must be studied on a case-by-case basis, however, it is recommended for vehicles with potential-free chassis. For example, using rubber buffers ensures that the terminal has no electrically conducting connection to the vehicle chassis.

Measures:

1. If peripheral equipment (such as scanners, printers, scales or similar), which has its own power supply unit is used, you must ensure that the power supply units of these peripherals are galvanically separated from the supply of the vehicle.
2. Moreover, the peripheral equipment and its cabling must be attached electrically isolated.
3. If external antennas are being used, you must ensure that the antennas are isolated at the mounting point on the vehicle chassis.

DANGER



Risk of accident on vehicles due to unexpected vehicle emergency stop because of electro-conductive connection of the DLT-V72 to the vehicle chassis.

1. *Some vehicles have a chassis that is connected to DC+. Therefore, the DLT-V72 chassis is also connected to DC+. If the ground potential of a peripheral device is "DC -", short circuits can occur. This will inevitably lead to malfunctions or even a total system failure.*
2. *Most electrically driven forklift vehicles have a floating chassis, connected to neither DC+ nor DC-. In the case of an error, either the plus or the minus potential could be connected to the chassis via low resistance paths. For this reason all connected peripherals must be attached isolated*
3. *Make sure that the DLT-V72 power supply cable is attached as close to the battery as possible.*
4. *Do not connect the power supply cable to supply lines that are severely disturbed (e.g. motor supply) or that are otherwise burdened by consumers. Connecting the DLT-V72 to large electrical loads, such as converters for the forklift motor may result in random restarts, malfunctions and/or irreparable damage to the device.*

5. *If you want to connect devices fed by other power sources to the DLT-V72, such as certain Wedges, printers and so on, be sure to power up the peripheral devices at the same time or after the vehicle-mount. Otherwise, you may encounter start-up problems, malfunctions or even irreparable damage to the device.*

Read more about this in manual chapter [13.1.3 Observe the potential ratios.](#)

12.2.3. Attaching accessories to the DLT-V72

Only use mounting brackets, accessories and mounting materials that have been tested and approved for the respective DLT-V72.

All mounting brackets, accessories and mounting materials supplied by Advantech are only intended to be used for attachment of the Advantech Industrial Computers and the peripheral devices and may not be misused.

DANGER



Risk of accident during vehicle operation if the mounting of the DLT-V72 becomes loose and breaks while driving.

Ensure the following when attaching the mounting on the VESA mounting hole pattern:

1. *Special **mechanical knowledge** is required for correct mounting!*
2. *Use suitable mounting material.*
3. *Use suitable screws: Screws that are too long can penetrate the back of the DLT-V72 and cause irreparable damage. Screws that are too short do not provide secure mounting.*
4. *Use suitable washers.*
5. *Observe the maximum screw-in depth of the hole of the mounting hole pattern: The recommended screw-in depth of $Dx1$ always applies (screw diameter x 1).*
6. *If you ordered a bracket from Advantech, it includes the suitable screws and washers. Please use them.*

12.2.4. VESA mounting hole pattern

The rear side of the DLT-V72 has a VESA-compatible mounting hole pattern with 75 x 75 mm for a RAM Mount bracket or swivel mounting.

- Screw-in depth VESA mounting hole pattern: M6 x 6 mm
- Suitable mounting material: Cylinder-head screws int.hex DIN912 M6
- Washers ISO 8738 (DIN 1440)-A6-A2



Fig. 12.1: VESA mounting hole pattern on the rear side of the DLT-V72

12.2.5. Attach the mounting bracket

The DLT-V72 housing has holes provided for attaching a mounting bracket.

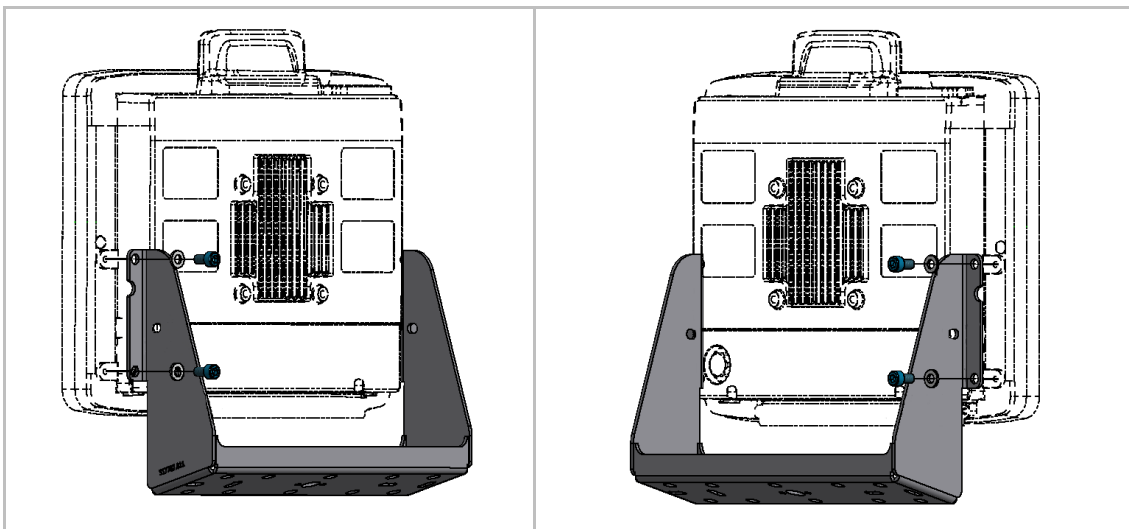

Fig. 12.2: Mounting bracket on the DLT-V72

- 4 x cylinder head screws DIN912 M6
- Screw-in depth: M6 x 6 mm
- Washers DIN 125 - A 6.4

12.2.6. Attach accessories

The housing of the DLT-V72 has holes provided for attaching an accessory.

Example:

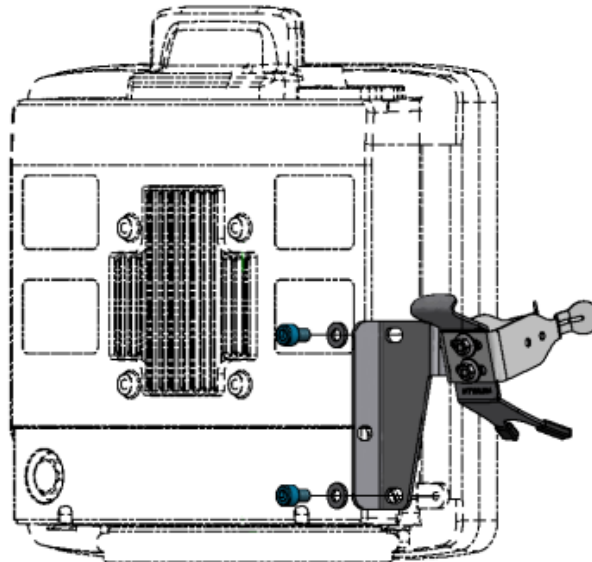

Fig. 12.3: Scanner mounting attachment

- Screw-in depth: M6 x 6 mm
- Suitable mounting material: Cylinder head screw DIN 912 M6
- Washer ISO 8738 - A6-A2

Installation sequence if mounting bracket and additional accessory are being attached

If you are mounting a mounting bracket and a keyboard holder:

1. Attach the mounting bracket to the DLT-V72 first.
2. Then mount the keyboard holder.
3. Only mount the complete system at the deployment location, e.g. to the forklift.

Please note: In addition to the mounting bracket, one accessory holder per side can still be attached in each case.

13. Electrical Installation

13.1. Safety notes

13.1.1. Disconnecting device and emergency-off

WARNING

Risk of personal injury and property damage due to improper electrical installation.

These mounting instructions are directed to skilled personnel. Only qualified skilled personnel may perform the electrical installation work on the DLT-V72.

- 1. Observe section 2.6 Information on safe electrical installation in the Safety Chapter of this manual.*
- 2. Comply with the appropriate national installation regulations for any and all cable routing.*
- 3. Install a disconnecting device.
The DLT-V72 is not equipped with a disconnecting device that is accessible from the outside; it does not have a switch.
To be able to quickly disconnect the DLT-V72 from the power supply in emergency situations, install an easily accessible disconnecting device close to the DLT-V72, e.g. a suitable load switch for low voltage.*
- 4. Ensure that the disconnecting device disconnects all power supply lines.*
- 5. If the EMERGENCY-OFF switch of the vehicle does not switch off the DLT-V72, there is a risk of electrical shock. Install the DLT-V72 and the EMERGENCY-OFF switch so that the DLT-V72 also switches off when the EMERGENCY-OFF switch is operated.*
- 6. Important: If a DLT-V72 with integrated UPS is installed in a vehicle, the EMERGENCY-OFF switch of the vehicle has no effect on the DLT-V72. This also applies to the peripherals supplied by the device.*

13.1.2. Power cables and fuses

WARNING

Electric shock, fire due to incorrect cable routing or insufficient grounding.

1. *Use only original Advantech power cables; these meet the specific requirements for low-temperature flexibility, UV resistance, oil resistance, etc.*
2. *Make sure that the power supply cables are run without kinks and are protected (securely protected against crushing and abrading).*
3. *The DLT-V72 may only be connected to a SELV circuit (Safety Extra Low Voltage). The SELV circuit is a secondary circuit that is designed and protected so that its voltages will not exceed a safe value both when operating correctly or if a single error occurs.*
4. *The DC+ connecting cable must be protected by a fuse (30 AT max.).*
5. *The ignition connecting cable must be protected by a fuse of the following type: 5x20 mm T 125 mA L / 250 V, for example, a Wickmann 195-125 mA / 250 V.*
6. *Observe correct voltage ranges.*
7. *Ensure that power supply cables are fused correctly.*
8. *Read the labeling on the cable and connect the power supply cable with the correct polarity.*
9. *Cut the supply cable to the minimum length. This avoids tangled cables and improves the quality of the power supply.*
10. *Connect the power supply cable to a suitable place. Ensure that the connecting cable has an adequate cross section and ampacity at the connection point.*

13.1.3. Observe the potential ratios

On the DLT-V72, the logic ground and the shield ground are firmly connected to each other. Logic ground is the ground (GND) used to supply the internal parts and components such as the display or CPU. All cable shields and the housing are connected to shield ground.

Read more about this in manual chapter [12.2.2 Electrically isolated DLT-V72 mounting](#).

Some vehicles have a chassis that is connected to DC+. Therefore, the DLT-V72 chassis is also connected to DC+. If the ground potential of a peripheral device is “DC -“, short circuits can occur. This will inevitably lead to malfunctions or even a total system failure

1. Always attach ring tongue of the supply voltage cable to the provided ground bolt situated on the connector panel.
2. In most installation cases, connect the other end of the yellow-green power supply cable to the vehicle's chassis.

ATTENTION:

In the following cases, the correct connection of the green-yellow cable must be clarified individually from case to case:

- If you have a chassis connected to DC+.
- If you have a floating chassis.

3. Connect the power supply cable of the DLT-V72 as directly as possible to the battery and not to power supply lines with a great deal of interference (e.g. the engine power supply) or otherwise affected by consumers.
4. Connecting the DLT-V72 to large electrical loads, such as converters for the forklift motor may result in random restarts, malfunctions and/or irreparable damage to the device.
5. If you want to connect devices fed by other power sources to the DLT-V72 (e.g. printers), be sure to power up the peripheral devices at the same time or after the DLT-V72; otherwise, you may encounter start-up problems, malfunctions or even irreparable damage to the device.

13.2. Preparations

1. Lay out ready all cables that are to be connected to the DLT-V72.
2. Select the appropriate slots on the connector panel of the DLT-V72.
3. Test in which order the cables best fit in the cable compartment.

Overview of connectors located on the connector panel under the cable cover:

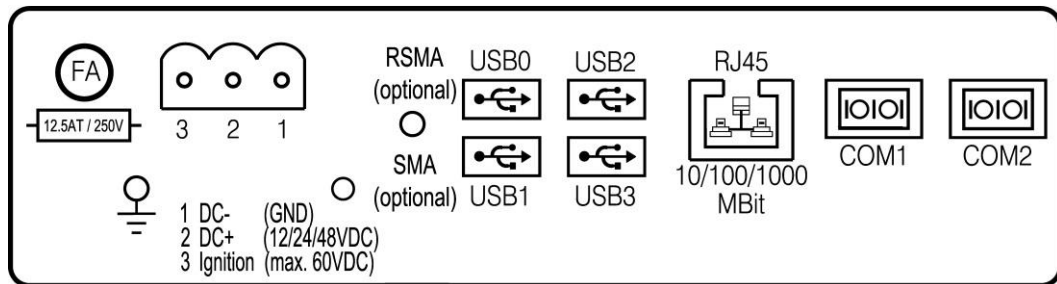

Fig. 13.1: Connectors on the connector panel under the cable cover

13.2.1. Material required

Cable sealing set: Screws and rubber seal

Note: Some parts in the scope of delivery are replacement parts.



10 x cylinder head screws DIN 912 M3x12 for fastening the cables to the strain relief rail



7 x cable clips for fastening the cables to the strain relief rail

Rubber seal:



Fig. 13.2: DLT-V72 cable sealing set

Cable cover

Including 2 x special screws M4x12, neck 8 mm, thread length 4 mm, (latching in the holes of the cable cover)



Fig. 13.3: DLT-V72 cable cover with screws

Power supply cable

DC power supply cable with Phoenix contact connector

Tools

- Allen wrench, size 3
- Philips screwdriver, size 3
- Torque wrench
- Allen wrench, size 2.5
- Flat head screwdriver, size 0
- Socket wrench, size 7

13.3. Procedure

13.3.1. Inserting the rubber seal in the cable compartment

1. Insert the rubber seal in the cable compartment.
2. Place the rubber seal in the frame of the cable compartment (see figure).
3. Press the plugs of the rubber seal into the holes of the frame.



Fig. 13.4: Rubber seal inserted in the cable compartment

13.3.2. Ensure a proper electrical connection

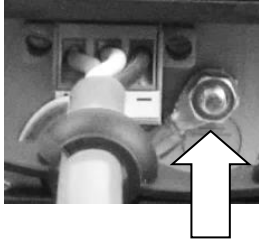



Ground bolt, with the following components factory-fitted:

1 x toothed washer
 D=8.5 d=4.2 t=0.5 ST Ni
 1 x nut (W)
 W=6 M4*0.7 H=2.5 ST
 Zn

1. Remove the nut from the ground bolt.
2. The toothed washer remains on the ground bolt.
3. Plug the ring tongue on the power supply cable onto the ground bolt; the flat side of the ring tongue points towards the DLT-V72 connector panel.
4. Lastly, fit the nut and fasten it.

NOTICE: For a proper electrical connection, it is important to have the correct order of the components on the ground bolt (from inside to outside):

| | |
|--|---|
| Toothed washer (internal) |  |
| Ring tongue on the power supply cable (center) |  |
| Nut (external) |  |

13.3.3. Plugging in and screwing on the power supply cable

Mounting screws

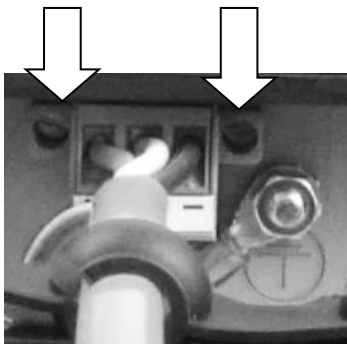

1. Plug the DC power supply cable into the DC slot.
2. Tighten the mounting screws hand-tight.

13.3.4. Secure the power supply cable to the strain relief rail

Mounting screws

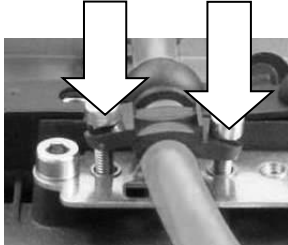

1. Open the round cable passage in the rubber seal.
2. Insert the power supply cable.
3. Place one cable clip on the power supply cable.
4. Secure the cable clip to the strain relief rail using 2 mounting screws.
5. Tighten the mounting screws alternately.

NOTICE:

Tighten the mounting screws sufficiently but make sure not to pinch the cable. Otherwise, the cables may break or the insulation may be damaged.

Make sure that the power supply cables are run without kinks and are mechanically protected, securely protected against crushing and abrading.

13.3.5. Connecting the USB, Ethernet and COM cables

Procedure as described for the **power supply cable**:

1. Connect the cable.
2. Open the round cable passage in the rubber seal.
3. Insert the cable.
4. Insert both components into the cable passage.
5. Secure using cable clip and screws to the strain relief rail.

NOTICE **Prevent system malfunction and property damage**

Observe the following when connecting/removing external devices on the DLT-V72.

1. *Only use accessories that have been tested and approved for the respective DLT-V72.*
2. *The DLT-V72 may not be connected to the power supply if external devices are being connected/removed (not applicable for USB devices)*
3. *Otherwise considerable damage could be caused to both the DLT-V72 and the peripheral devices.*
4. *Make sure that peripherals with their own power supply are either switched on at the same time as the DLT-V72 or after the start of the DLT-V72.*
5. *Otherwise, you must ensure that a backflow from the external device to the DLT-V72 cannot take place.*
6. *Only power up the DLT-V72 when all devices have been connected and the DLT-V72 has been closed correctly (remember the cable cover!). Otherwise, you may damage the DLT-V72.*

13.3.6. Close off unused cable openings

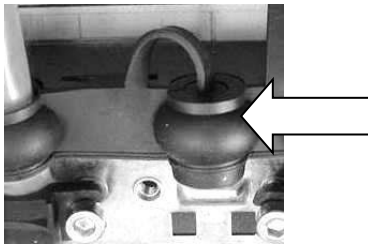

Close off all unused cable openings of the rubber seal using the accompanying blind plugs so that they are sealed.

13.3.7. Attach the cable cover

1. Place the cable cover in the DLT-V72 housing slot.
2. Screw the thin headless screws loosely into the holes of the cable cover.
3. Then fully tighten the screws with 3 Nm torque.

Example for a correctly attached cable cover:

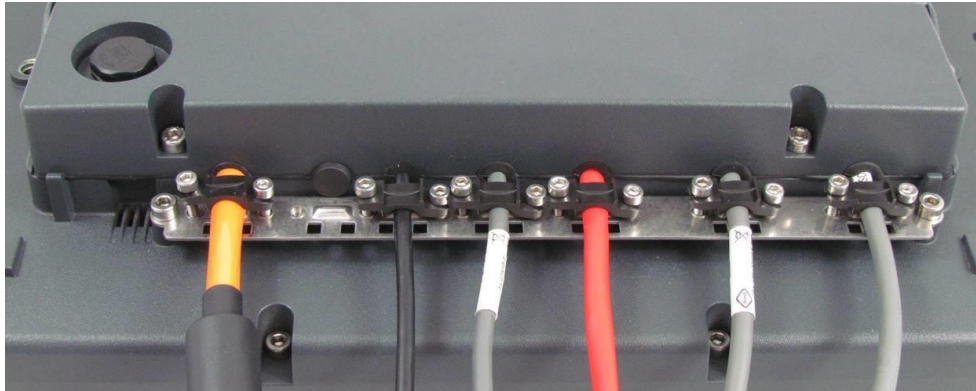

Fig. 13.5: Cable cover closed and screwed together

NOTICE **Prevent system malfunction and property damage**

To prevent fluids or dust penetrating the DLT-V72 during ongoing operation, the cable compartment on the device must be sealed using the corresponding cable cover. The protection class is only ensured if the cable cover is properly installed.

13.4. Pressure compensation element

The DLT-V72 cable cover has a pressure compensation element.

NOTICE ***Prevent system malfunction and property damage***

Do not modify or remove the pressure compensation element; doing so would make the device leak and the IP protection would no longer be ensured.

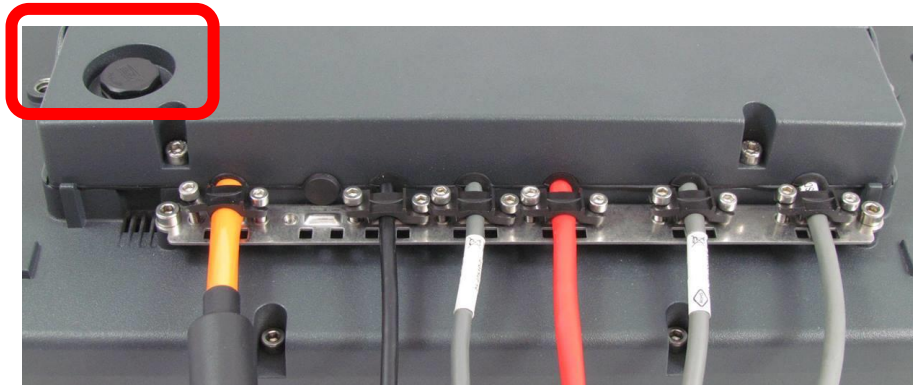

Fig. 13.6: Pressure compensation element

14. Optional Equipment

14.1. Integrated UPS (optional)

The DLT-V72 is optionally available with an integrated UPS. The battery pack of the UPS is located in the battery pocket of the device.



Fig. 14.1: Battery pocket with UPS DLT-V72

WARNING



Personal injury due to short-circuit, fire, chemical burns, toxic substances

DLT-V72 devices with integrated UPS contain battery packs. These can ignite if handled or stored improperly (risk of fire), cause chemical burns or release toxic substances.

1. Use care when handling battery packs.
2. Please observe manual section 2.3 Battery pack safety .

14.1.1. Battery pack specifications

Battery pack (Lithium-Ion technology)

| | |
|-----------------------|--|
| Bridging time | The integrated UPS can bridge an interruption of the main supply for typically 20 minutes. Requirement: The battery pack is fully charged. |
| Operating temperature | -30 to +50 °C |
| Charging time | 4 h (fully recharge a completely discharged battery pack). |
| Charging temperature | -10 to +50 °C (ambient temperature) |
| Storage temperature | -30 to +60 °C |
| Maximum output power | 40 W |
| Battery voltage | 7,2 V |
| Battery capacity | 2000 mAh |

14.1.2. Charging the battery pack

Connect the properly installed DLT-V72 to the main supply voltage.

WARNING



Electric shock when charging the battery pack

DLT-V72 devices with integrated UPS contain battery packs. These can ignite if handled or stored improperly (risk of fire), cause chemical burns or release toxic substances.

- 1. The cable cover of the DLT-V72 must be screwed together properly.*
- 2. The battery pocket must be screwed together properly.*
- 3. The device must be fully closed.*
- 4. Do not connect damaged battery packs to the DLT-V72; do not charge.*
- 5. Battery packs become warm while charging; this is normal. However, if they become excessively hot, immediately disconnect the DLT-V72 from the power source.*
- 6. Do not continue to use the DLT-V72 if you notice an unusual level of heat or an unusual smell during charging.*
- 7. Provide for sufficient ventilation of the DLT-V72 during charging.*

14.1.3. Replacing the battery pack

The battery pack of the DLT-V72 can be charged approx. 600 times. It may only be replaced by an original battery pack from Advantech.

WARNING

Personal injury due to short-circuit, fire, chemical burns, toxic substances. No third-party battery packs permitted.

1. *Use only original Advantech battery packs.*
2. *The battery packs must be authorized/approved for the DLT-V72.*
3. *Do not use battery packs from any other Advantech devices; they are not compatible.*
4. *If battery packs from other manufacturers are inserted in the DLT-V72, the warranty provided by Advantech for this device will be rendered void.*

Procedure for opening the battery cover

1. **IMPORTANT:** Switch off the DLT-V72.
2. Loosen the two screws of the battery cover using an Allen wrench.
3. Remove the battery cover.
4. Remove the battery pack.
5. Insert the new battery pack into the battery pocket as shown in the figure.
6. Make sure that the removal tab of the battery pack is inside the sealing surface.
7. Then reattach the battery cover (tightening torque 2 Nm).
8. Be sure the sealing of the battery cover is inside its slot.



Fig. 14.2: Inserting the battery pack in the battery pocket

14.2. Screen defroster (optional)

Some DLT-V72 models are optionally available with a screen defroster (containing “D” in the model name, e.g. “DLT-V7210 D”).

Functional description

As soon as the internal temperature of the DLT-V72 device falls below 5°C, the screen defroster is automatically activated and heats the front of the device. The front of the device thus thaws more quickly when leaving cold stores, for example.

In terms of the ambient temperature, this means:

- The defroster is typically active at an ambient temperature of 0°C to -10°C. This depends on how quickly the ambient temperature changes or how quickly the DLT-V72 cools.
- Analogously, the screen defroster is typically deactivated again when the ambient temperature rises to +10°C to +20°C.

The screen defroster has a heat output of approx. 30 Watts.

It does not work when the DLT-V72 is running on battery power.

It will switch off automatically if the internal device temperature is too high and cannot be switched on manually using the front keys.

Notes for parking vehicles with DLT-V72 devices with Screen-Defroster option:

Do not park or store vehicles on which DLT-V72 devices with a Screen-Defroster and an integrated UPS are installed in areas with ambient temperatures below 0°C.

If vehicles on which DLT-V72 devices with a Screen-Defroster and an integrated UPS are installed are parked or stored for a significant length of time, disconnect the DLT-V72 from the vehicle battery.

14.3. Screen blanking (optional)

An optional Screen Blanking Solution is available for the DLT-V72 for use in vehicles. This solution blanks the DLT-V72 screen automatically as soon as the vehicle starts driving.

NOTE *The “DLT-SA6100 Screen Blanking Solution Manual” is available at our websites.*



14.4. USB recovery stick (optional)

The optional Advantech recovery stick allows images to be backed up and restored onto the DLT-V72 when necessary (backup & recovery).

NOTE *The “ADLoG USB Recovery Stick Manual” is available at our websites.*



14.5. Keyboards and keyboard mounts (optional)

Any USB keyboard can be connected to the DLT-V72.

Advantech offers the following keyboards:



Fig. 14.3: SMALL keyboard

SMALL keyboard

1. Mountable
2. Protection class IP65
3. Keyboard layouts: German, English, French



Fig. 14.4: 24-key keypad

24-key keypad

- Mountable
- Protection class IP65

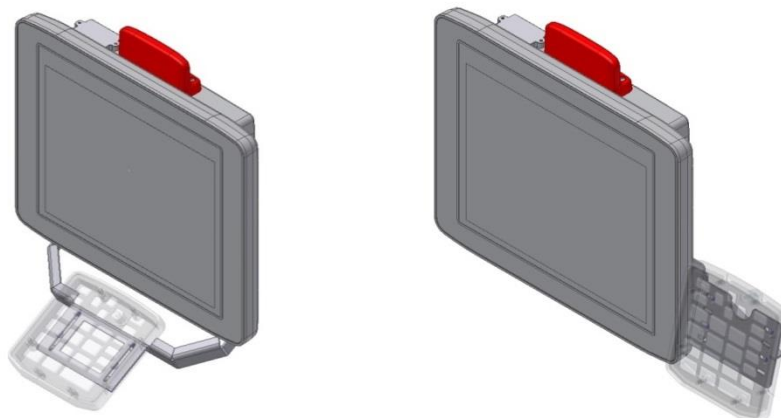

Fig. 14.5: Keyboard mounting examples

14.6. Scanner and scanner bracket (optional)

You can connect scanners to either the USB interface or the serial interface. If connected to COM1, the scanner can be powered through the interface with a voltage of 5 V.

Use only scanners that have been approved by Advantech.

Optional scanner brackets are available for the DLT-V72.

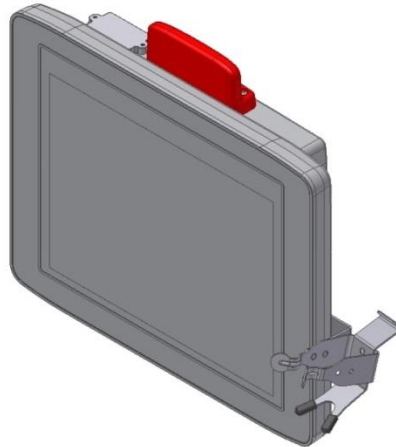

Fig. 14.6: Example scanner bracket

14.7. Touch stylus (optional)

Advantech offers some touch stylus pens (with associated mountings) for resistive and PCT touchscreens.

Use only touch stylus that have been approved by Advantech.

Touch stylus with mounting
for resistive touchscreen:



Touch stylus with mounting
for PCT touchscreen:

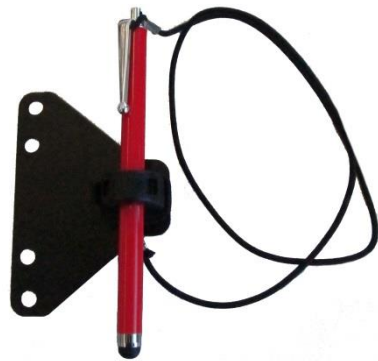

Fig. 14.7: Examples touch stylus

14.8. Protective film for touchscreen (optional)

An optional protective film is available for DLT-V72 touchscreens. This film protects the touchscreen during extreme use.

NOTICE ***Prevent system malfunction and property damage***

Do not attach the protective film to damaged or worn out touchscreens. Air bubbles can get trapped and cause malfunctions.

The ordered protective film is normally attached to the DLT-V72 touchscreen at the factory. If the film must be attached by the customer or replaced:

1. Turn off the DLT-V72.
2. Use a neutral glass cleaner without ammonia or isopropyl alcohol applied to a lint-free cloth.
3. Wipe off the touchscreen with it.
4. Then use distilled water to remove any residual glass cleaner.

NOTICE ***Prevent system malfunction and property damage***

1. *Never use any kind of chemical solvent, acidic or alkali solution.*
2. *Do not use any abrasive glass cleaner or cloths that could scratch the touchscreen.*
3. *Make sure that the surface of the touchscreen is free of dust and other particles.*
4. *Position the protective film tight at one corner of the viewing window. The adhesive side of the film must be facing downwards!*
5. *Carefully press on the foil.*
6. *Then using a wiper (wooden wiper) to push out any air bubbles to the corners.*

15. Repairs, Modifications

15.1. Authorized Advantech Service Centers

Only authorized Advantech Service Centers may perform the following:

- Open the device (front unit and base unit)
- Repairs
- Modifications
- Replace integrated modules, e.g. radio cards

The device operator may perform the following (only qualified skilled personnel):

- Opening/closing the antenna cap (e.g. for replacing CFast card and SIM card)
- Opening/closing the cable cover
- Opening/closing the battery pocket to replace the battery pack
- Replacing the integrated keyboard of the DLT-V7210 K, KD versions

The legal warranty shall apply. It expires if the customer performs measures on the device that are only permitted to be performed by Advantech Service Centers.

Accessories and peripherals

Accessories and peripherals may only be installed or integrated if expressly approved by Advantech for the respective DLT-V72. If other parts are attached or installed and connected, claims for warranty and / or product liability will be lost.

THERE IS A RISK OF EXPLOSION IF THE BATTERY PACK IS SWAPPED OUT AND REPLACED WITH AN INCORRECT/NON-APPROVED BATTERY PACK.

16. Maintenance

16.1. Regular maintenance work

16.1.1. General

To avoid damage to the DLT-V72 and to ensure safe functioning: Depending on the load and environmental conditions, check at least once per month, and more often if necessary, that all connected cables are secured and that the cable cover is tightly sealed (important for IP protection against dust, etc.).

16.1.2. Cleaning the device

1. Switch off the DLT-V72 before cleaning.
2. Disconnect from the power supply.
3. Disconnect connected accessories.
4. Clean the touchscreen and housing with a damp cloth and a neutral glass-cleaning agent.
5. Do not use any chemicals such as benzene, thinner or acidic/alkaline solutions for cleaning.
6. Do not use any compressed air or high-pressure cleaning equipment.

16.1.3. Devices used in vehicles

DLT-V72 devices used in vehicles are subject to high loads due to vibration and shocks. To ensure the secure fastening of the device to the vehicle, the following points must be checked at least once a month, and where necessary more often, depending on the load and environmental conditions:

1. Check that the DLT-V72 is securely positioned in the corresponding mount (e.g. in the RAM mount or in the mounting bracket).
2. Check that all fastening elements are correctly secured (e.g. screws, etc.).
3. Check that the mounting with the DLT-V72 is securely fastened to the vehicle.

Risk of accident due to unstable attachment of DLT-V72

If the attachment of DLT-V72 becomes loose and breaks during moving, this can lead to severe accidents. Perform checks for the attachment as described above at regular intervals.

16.2. Replacing the integrated keyboard

If necessary, the integrated keyboard of the DLT-V7210 K and DLT-V7210 KD can be removed and replaced by a new keyboard (only by skilled personnel).

WARNING



Hazardous voltage, electric shock from contact with live parts.

To prevent an electric shock:

1. Switch off the device before replacing the integrated keyboard.
2. Disconnect the device from the power supply.
3. Disconnect connected accessories.

16.2.1. Remove the integrated keyboard

NOTICE

Prevent system malfunction and property damage

Preventing damage to the device:

1. Observe the applicable ESD and accident prevention regulations.
2. The work may only be performed in an ESD-protected, clean environment.
3. ESD protective mats must be installed on the floor and on the worktable.
4. The installer must also wear ESD shoes and clothing.

Procedure:

1. Use a TX10 screwdriver to loosen the 5 mounting screws.
2. Carefully remove the keyboard grid; it will be used again later.
3. Carefully remove the silicon keyboard mat.
4. Make sure you do not damage the circuit board or components on the circuit board.



Fig. 16.1: Integrated keyboard: Unscrew the mounting screws

16.2.2. Attach the integrated keyboard (example)

Reuse the black keyboard grid.

New, replacement parts:

- Silicon keyboard mat
- 5 x screws ISO14580-m3x8 A2



Fig. 16.2: Integrated keyboard: Keyboard components

Procedure

1. Place the silicon keyboard mat on the circuit board.

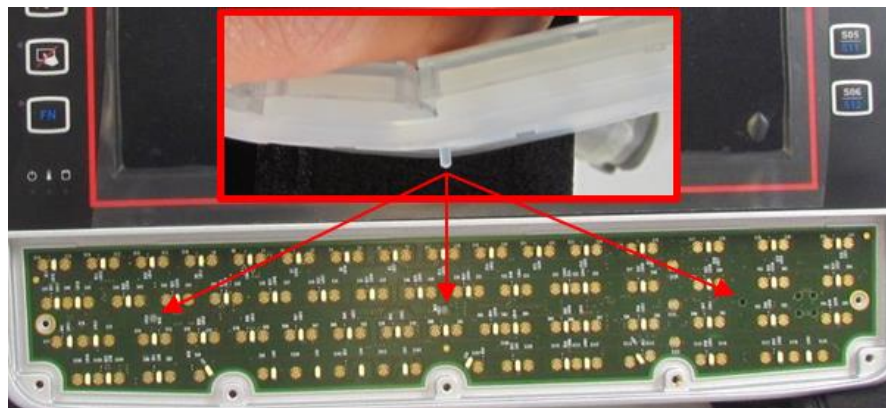

Fig. 16.3: Integrated keyboard: Position at which the 3 nubs are inserted

- Carefully press the 3 nubs on the back of the silicone keypad into the openings provided on the circuit board.

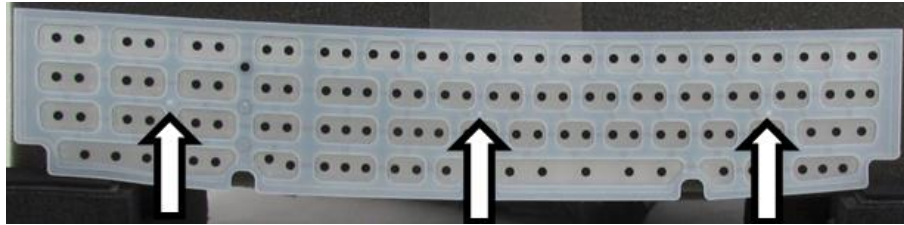

Fig. 16.4: Integrated keyboard: Silicone keypad

- Place on the keyboard grid at a 45° angle, see Fig. 16.5.

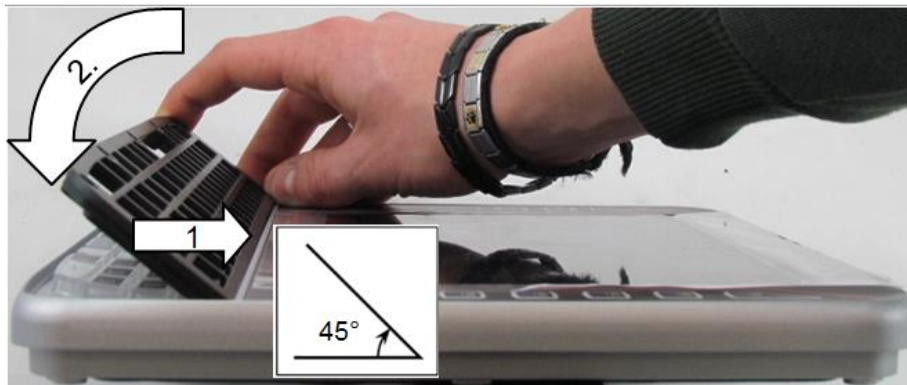

Fig. 16.5: Integrated keyboard: Attach keyboard grid

- Snap in keyboard grid lugs.
- Fold keyboard grid onto keyboard.
- Align keys.
- Press keyboard grid firmly.
- Use a TX10 screwdriver to tighten the 5 mounting screws of the integrated keyboard.
- Tightening torque: Maximum 2 Nm.

16.3. Replacing the battery pack

See manual section [14.1 Integrated UPS \(optional\)](#) .

16.4. Replacing the touchscreen protective film

NOTICE ***Prevent system malfunction and property damage***

Do not attach the protective film to damaged or worn out touchscreens. Air bubbles can get trapped and cause malfunctions.

The ordered optional protective film is normally attached to the DLT-V72 touchscreen at the factory.

If the film must be attached or replaced:

1. Turn off the DLT-V72.
2. Use a neutral glass cleaner without ammonia or isopropyl alcohol applied to a lint-free cloth.
3. Wipe off the touchscreen with it.
4. Then use distilled water to remove any residual glass cleaner.

NOTICE:

Never use any kind of chemical solvent, acidic or alkali solution.
Do not use any abrasive glass cleaner or cloths that could scratch the touchscreen.

5. Make sure that the surface of the touchscreen is free of dust and other particles.
6. Position the protective film with the adhesive side facing downwards tight at one corner of the viewing window.
7. Carefully press on the foil.
8. Then using a wiper (wooden wiper) to push out any air bubbles to the corners.

17. Troubleshooting

| Error | Possible cause(s) | Remedy |
|--|--|---|
| Battery pack run time is significantly shorter than specified. | The device may possibly not be in the temperature range, which is necessary for charging the battery pack. | Check the temperature specifications for the device and surroundings. |
| | Maximum number of charging cycles of the battery pack has been reached. | If temperature causes can be ruled out, the battery pack has possibly reached the maximum number of charging cycles. Replace the battery pack. Use only original battery pack from Advantech. |
| No UPS functionality although battery pack is plugged in. | Battery pack is discharged or deep discharged. | Charge the battery pack properly. Observe: If the battery pack is deep discharged, the charging time can increase by a multiple. |
| Nothing is shown on the display, Power LED does not light up. | There is no voltage present on the device. | Check the power switch, plug connection, power supply cable and fuse. |
| | Ignition signal missing. | Check ignition cable and signal |
| Nothing is shown on the display, Power LED active. | Backlight is switched off. | Press backlight key ("light bulb" symbol). |
| | Brightness too low | Increase display brightness with key |
| Nothing is shown on the display, Temp LED active. | Operating temperature limits exceeded/undershot. | Wait until the device has cooled down resp. warmed up. |
| Touchscreen reacts imprecisely. Device cannot be operated by touch input. | Touchscreen is switched off. | Press touchscreen on/off. |
| | Touch driver error | Reinstall the touch driver or change settings |
| | Touchscreen is not calibrated correctly. | The touchscreens is already calibrated at the factory and therefore and does usually not need to be recalibrated. However, the operating systems Win7Pro, Windows 8.1 Industry and WE8S do permit recalibration of the touchscreen via software (Menu Control Panel -> Tablet PC Settings). This resets the sensitivity of the touchscreen to an |

| | | |
|---|----------------------------|--|
| | | operating system default setting, which can result in poorer detection of taps on the screen. You can use Reset to reset the software recalibration. |
| Operating system does not start | External boot media lock | Remove all external storage |
| | Operating system damage | Operating system or image must be reinstalled |
| No WLAN connection | Connection deactivated | Activate connection in the Control Panel |
| | AP access problem | List ACL and check access rights to AP |
| | Invalid network settings | Check WLAN, authorization parameters, network and protocol settings |
| | Signal strength too weak | Check signal strength and quality in software; if necessary, the network must be enlarged |
| The system loses settings after a restart | Write protection activated | Deactivate write protection or authorize changes in operating system |
| | Operating system damage | Operating system or image must be reinstalled |
| No network connection | Connection deactivated | Activate connection in the Control Panel |
| | Invalid network settings | Check network and protocol settings |
| | Network problems | Check status LEDs on RJ45 connection socket, plug connection and cable |

18. Guidelines and Certificates

18.1. USA/CANADA: FCC Part 15 Statement

This equipment has been tested and found to comply with the limits for a Class B digital device, pursuant to part 15 of the FCC Rules.

These limits are designed to provide reasonable protection against harmful interference in a residential installation.

This equipment generates, uses and can radiate radio frequency energy and, if not installed and used in accordance with the instructions, may cause harmful interference to radio communications. However, there is no guarantee that interference will not occur in a particular installation. If this equipment does cause harmful interference to radio or television reception, which can be determined by turning the equipment off and on, the user is encouraged to try to correct the interference by one or more of the following measures:

Reorient or relocate the receiving antenna.

Increase the separation between the equipment and receiver.

Connect the equipment into an outlet on a circuit different from that to which the receiver is connected.

Consult the dealer or an experienced radio/TV technician for help.

CAUTION



Radio frequency exposure

In order to comply with the FCC requirements regarding radio frequency exposure from vehicle-mounted transmission devices:

The antenna has to be kept at least 20 cm to 50 cm away from people and domestic animals.

Any change or modification which is not expressly approved in the corresponding pages can lead to the withdrawal of the operating license for this device.

FCC ID

Please find the FCC ID on the device labels.

18.2. ICES Kanada

| | |
|--------------------|--|
| Deutsch [German]: | DLT-V72 Industrie-PCs sind digitale Geräte der Klasse A und entsprechen der Kanadischen ICES-003 Norm. |
| English: | This Class A digital apparatus complies with Canadian ICES-003. |
| Français [French]: | Cet appareil numérique de la classe A est conforme à la norme NMB-003 du Canada. |

IC ID

Please find the IC ID on the device labels.

18.3. CNROHS

Dear Customer,

Thanks for choosing an Advantech-DLoG Product, to comply with China Electronic Industry Standard SJ/T11364 which require Marking for the Restriction of the Use of Hazardous Substances in Electrical and Electronic Products, herein report to you product's environmental protection as follows.

Please disregard this notice if the product is not to be sold / installed in China.

| 品号 Model name | MTC6, XMT5, DLT-V83 and DLT-V72 series | | | | | |
|-------------------|---|-----------|-----------|-----------------|---------------|-----------------|
| 部件名称 Substance | 产品中有害物质或元素的名称及含量 Name and concentration of hazardous substances contained in product | | | | | |
| | 铅 (Pb) | 汞 (Hg) | 镉 (Cd) | 六价铬 (Cr(VI)) | 多溴联苯 (PBB) | 多溴二苯醚 (PBDE) |
| 外壳 | O | O | O | O | O | O |
| LED 显示屏 | O | O | O | O | O | O |
| 主板 | X | O | O | O | O | O |
| 塑胶件 | O | O | O | O | O | O |
| 线材 | O | O | O | O | O | O |
| 电源 | X | O | O | O | O | O |

O: 表示该有害物质在该部件所有均质材料中的含量均在GB/T 26572标准规定的限量要求以下。
O: Represent the concentration for this hazardous substance in all homogeneous materials of the part Comply with the limit of the standard of GB/T 26572. X: 表示该有害物质至少在该部件的某一均质材料中的含量超出GB/T 26572标准规定的限量要求。 X: Represent the concentration for this hazardous substance at least in one homogeneous material of this part exceeds the limit of the standard of GB/T 26572. 企业说明:(对于超出标准的部分)

Enterprise statements: (for those exceeding the standard)
填写的内容:
Content:
产品标签上的环保使用期限(Environmental Protection Use Period, EPUP)标识表示在此期间内,在正常操作条件下,产品中所含有害物质或成分不会发生泄漏和变异。因而此类产品的使用不会导致任何严重的环境污染、任何人身伤害或财产损失。同时,不应将此期间视为保修期或保证有效期。
The mark of EPUP(Environmental Protection Use Period) in product label means in this period, by the normal operation mode, the hazardous substances won't leak out and deviate, so the product use won't result in serious environmental pollution, human injury or property loss, meanwhile, please don't take this period as the warranty date. 标签上带有污染控制标志的产品是可以回收的,不应随意进行处理。
The products which attach with pollution control mark can be recycled, and should not be discarded at will.



CNROHS-A0

19. List of figures

| | |
|--|-----|
| Fig. 2.1: Battery pocket with UPS DLT-V72 | 17 |
| Fig. 2.2: Recycling information icons..... | 23 |
| Fig. 5.1: Dimensions DLT-V7210 P, R, D (in mm)..... | 35 |
| Fig. 5.2: Dimensions DLT-V7212 P, R, D (in mm)..... | 35 |
| Fig. 5.3: Dimensions DLT-V7210 K, KD (in mm)..... | 36 |
| Fig. 5.4: Dimensions DLT-V7212 P+ (in mm)..... | 36 |
| Fig. 5.5: Dimensions DLT-V7215 P+ (in mm)..... | 37 |
| Fig. 5.6: DC Power supply cable with Phoenix Combicon, 3-pin | 38 |
| Fig. 5.7: DC power supply connector with connector detail view | 39 |
| Fig. 5.8: DC connection cable assignment..... | 40 |
| Fig. 6.1: WLAN antenna IEEE 802.11 a/b/g/n/ac | 45 |
| Fig. 6.2: WLAN, WWAN, LTE 4G antenna (Multiband) | 46 |
| Fig. 6.3: External WLAN antenna..... | 47 |
| Fig. 6.4: External 2G, 3G, 4G WWAN antenna | 48 |
| Fig. 6.5: External GPS receiver (optional)..... | 50 |
| Fig. 6.6: Ext. GPS receiver, display example during installation..... | 50 |
| Fig. 7.1: Connectors on the connector panel under the cable cover..... | 52 |
| Fig. 7.2: RJ45 network port..... | 53 |
| Fig. 7.3: DLT-V72 with a sealing plate (no radio antenna)..... | 55 |
| Fig. 7.4: WLAN antenna IEEE 802.11 a/b/g/n/ac | 57 |
| Fig. 7.5: WLAN antenna IEEE 802.11 a/b/g/n/ac | 58 |
| Fig. 7.6: WLAN antenna IEEE 802.11 a/b/g/n/ac opened..... | 58 |
| Fig. 7.7: WLAN, WWAN, LTE 4G antenna (Multiband) | 59 |
| Fig. 7.8: Opening the WLAN, WWAN LTE 4G antenna (Torx Tx20)..... | 60 |
| Fig. 7.9: WLAN, WWAN LTE 4G antenna opened | 60 |
| Fig. 7.10: Antenna module WLAN, WWAN LTE 4G is open..... | 61 |
| Fig. 8.1: Integrated keyboard English (QWERTY)..... | 71 |
| Fig. 8.2: Integrated keyboard German (QWERTZ)..... | 72 |
| Fig. 8.3: Integrated keyboard French (AZERTY)..... | 73 |
| Fig. 8.4: Software keyboard | 75 |
| Fig. 8.5: Battery pocket with UPS DLT-V72 | 76 |
| Fig. 9.1: Automatic Win10IoTent Updates | 81 |
| Fig. 9.2: ADLoG config tool Hardware Monitor..... | 87 |
| Fig. 9.3: Windows Device Manager SUSI4 Driver..... | 88 |
| Fig. 10.1: WLAN table mW and dBm | 91 |
| Fig. 10.2: Setup.exe for 64 bit operating system Win10IoTent (Sparklan WLAN) | 95 |
| Fig. 10.3: Setup.exe Choose Setup Language (Sparklan WLAN) | 96 |
| Fig. 10.4: Sparklan WLAN driver installation Welcome dialog..... | 96 |
| Fig. 10.5: Sparklan WLAN driver installation starts | 97 |
| Fig. 10.6: Sparklan WLAN driver installation Exit with Finish | 97 |
| Fig. 10.7: Device Manager network adapter Properties (Qualcomm) | 98 |
| Fig. 10.8: Advanced – Roaming aggressiveness Property | 99 |
| Fig. 10.9: Setup.exe for 64 bit operating system Win10IoTent (Sparklan BT) | 101 |
| Fig. 10.10: Sparklan WLAN driver installation Welcome dialog..... | 102 |
| Fig. 10.11: Sparklan BT driver installation destination folder..... | 102 |
| Fig. 10.12: Sparklan BT driver installation starts | 103 |
| Fig. 10.13: Sparklan BT driver installation Exit with Finish | 103 |
| Fig. 10.14: Sparklan BT driver installation perform system restart | 104 |

| | |
|---|-----|
| Fig. 10.15: WCU icon on the desktop..... | 109 |
| Fig. 10.16: WCU main window, Admin Login | 110 |
| Fig. 10.17: WCU-Administrator login window | 111 |
| Fig. 10.18: Speed buttons for managing profiles..... | 111 |
| Fig. 10.19: Check License | 112 |
| Fig. 10.20: Info display via existing license | 113 |
| Fig. 10.21: Browse nearby wireless networks function..... | 113 |
| Fig. 10.22: Advanced Security Settings dialog | 114 |
| Fig. 10.23: Connection when the network is in range dialog | 114 |
| Fig. 10.24: Security settings - network authentication methods..... | 116 |
| Fig. 10.25: Security settings – Advanced settings (Cisco: Leap) | 116 |
| Fig. 10.26: Security settings – LEAP properties | 117 |
| Fig. 10.27: Wireless Network properties dialog | 117 |
| Fig. 10.28: Create new profile dialog..... | 118 |
| Fig. 10.29: Network connection is established | 119 |
| Fig. 10.30: General dialog in the Roam Management menu | 120 |
| Fig. 10.31: Roaming dialog in the Roam Management menu..... | 121 |
| Fig. 10.32: Roam Management – Choose Band and Channels..... | 123 |
| Fig. 10.33: Radio dialog in the Roam Management menu..... | 125 |
| Fig. 10.34: Adapter Tab in Roam Management menu..... | 126 |
| Fig. 10.35: WLAN Client Manager - Import/Export feature | 127 |
| Fig. 10.36: WLAN Client Manager - Import/Export dialog..... | 128 |
| Fig. 10.37: WLAN Client Manager - Export Profiles in OutputFile.txt..... | 128 |
| Fig. 10.38: WLAN Client Manager - Info box Profiles exported | 129 |
| Fig. 10.39: WLAN Client Manager - Select an existing “OutputFile.txt” | 129 |
| Fig. 10.40: WLAN Client Manager - Info box Profiles imported | 129 |
| Fig. 10.41: Start „Auto” Import of a WLAN settings file | 130 |
| Fig. 10.42: Successful „Auto” Import of a WLAN settings file | 131 |
| Fig. 11.1: QUECTEL EC25 - Set up a new connection or network..... | 135 |
| Fig. 11.2: QUECTEL EC25 - Connect to the Internet | 135 |
| Fig. 11.3: QUECTEL EC25 - Connect to the Internet - Dial-up..... | 136 |
| Fig. 11.4: QUECTEL EC25 - Connect to the Internet - Telephone number | 136 |
| Fig. 11.5: QUECTEL EC25 - Network connections - Vodafone test connection | 136 |
| Fig. 11.6: QUECTEL EC25 - Dial Vodafone test connection | 137 |
| Fig. 11.7: QUECTEL EC25 - Function test GSM / GNSS, test connection status..... | 137 |
| Fig. 11.8: QUECTEL EC25 - Virtual COM ports DLT-V72..... | 138 |
| Fig. 11.9: QUECTEL EC25 - Test NMEA data flows | 139 |
| Fig. 12.1: VESA mounting hole pattern on the rear side of the DLT-V72..... | 145 |
| Fig. 12.2: Mounting bracket on the DLT-V72..... | 146 |
| Fig. 12.3: Scanner mounting attachment | 147 |
| Fig. 13.1: Connectors on the connector panel under the cable cover..... | 152 |
| Fig. 13.2: DLT-V72 cable sealing set | 152 |
| Fig. 13.3: DLT-V72 cable cover with screws | 153 |
| Fig. 13.4: Rubber seal inserted in the cable compartment | 154 |
| Fig. 13.5: Cable cover closed and screwed together..... | 158 |
| Fig. 13.6: Pressure compensation element..... | 159 |
| Fig. 14.1: Battery pocket with UPS DLT-V72 | 161 |
| Fig. 14.2: Inserting the battery pack in the battery pocket | 163 |
| Fig. 14.3: SMALL keyboard | 166 |

| | |
|--|-----|
| Fig. 14.4: 24-key keypad..... | 166 |
| Fig. 14.5: Keyboard mounting examples..... | 166 |
| Fig. 14.6: Example scanner bracket..... | 167 |
| Fig. 14.7: Examples touch stylus | 168 |
| Fig. 16.1: Integrated keyboard: Unscrew the mounting screws | 174 |
| Fig. 16.2: Integrated keyboard: Keyboard components | 175 |
| Fig. 16.3: Integrated keyboard: Position at which the 3 nubs are inserted..... | 175 |
| Fig. 16.4: Integrated keyboard: Silicone keypad | 176 |
| Fig. 16.5: Integrated keyboard: Attach keyboard grid..... | 176 |