

FCC PART 74 TEST REPORT
for
Digital Handheld Transmitter
Model No.: ACT-8Ha
FCC ID: M5X-ACT8HA

of

Applicant: **MIPRO Electronics Co., Ltd.**
Address: **814 Pei-kang Road 600 Chia-yi Taiwan, R.O.C**

Tested and Prepared

by

Worldwide Testing Services (Taiwan) Co., Ltd.

FCC Registration No.: 930600

Industry Canada filed test laboratory Reg. No. IC 5679A-1

A2LA Accredited No.: 2732.01



Report No.: W6M21108-11777-C-1

6F, NO. 58, LANE 188, RUEY-KUANG RD., NEIHU TAIPEI 114, TAIWAN, R.O.C.
TEL: 886-2-66068877 FAX: 886-2-66068879 E-mail: wts@wts-lab.com



Registration number: W6M21108-11777-C-1
FCC ID: M5X-ACT8HA

TABLE OF CONTENTS

1	GENERAL INFORMATION.....	3
1.1	NOTES.....	3
1.2	TESTING LABORATORY	4
1.2.1	Location	4
1.2.2	Details of accreditation status	4
1.3	DETAILS OF APPROVAL HOLDER.....	5
1.4	APPLICATION DETAILS	5
1.5	GENERAL INFORMATION OF TEST ITEM	5
1.6	TEST STANDARDS.....	6
2	TECHNICAL TEST	7
2.1	SUMMARY OF TEST RESULTS	7
2.2	TEST ENVIRONMENT	7
2.3	TEST EQUIPMENT LIST	8
2.4	GENERAL TEST PROCEDURE	12
3	TEST RESULTS (ENCLOSURE)	13
4	RF POWER OUTPUT (CONDUCTED) , FCC 2.1046 (A) ; 74.861 (E)	14
4.1	TEST PROCEDURE.....	14
4.2	TEST RESULTS	14
5	RADIATED POWER.....	15
5.1	TEST PROCEDURE	15
5.2	TEST RESULTS	17
6	MODULATION DEVIATION , FCC 2.1047 (B) ; 74.861(E).....	23
6.1	TEST PROCEDURE.....	23
6.2	TEST RESULTS	23
7	AUDIO FREQUENCY RESPONSE , FCC 2.1047 (A).....	24
7.1	TEST PROCEDURE.....	24
7.2	TEST RESULTS	24
8	OCCUPIED BANDWIDTH/EMISSION MASK, FCC 2.1049 (C) ; 74.861 (E)(5)	25
8.1	TEST PROCEDURE.....	25
8.2	TEST RESULTS	25
8.3	LIMIT	27
9	SPURIOUS EMISSIONS AT ANTENNA TERMINALS FCC2.1051 ; 74.861 (E)	28
9.1	TEST PROCEDURE.....	28
9.2	TEST RESULTS	28
9.3	LIMIT	28
10	RADIATED SPURIOUS EMISSION , FCC 2.1053 ; 74.861 (E).....	29



Worldwide Testing Services(Taiwan) Co., Ltd.

Registration number: W6M21108-11777-C-1

FCC ID: M5X-ACT8HA

10.1	TEST PROCEDURE.....	29
10.2	TEST RESULTS	29
10.3	EXPLANATION OF TEST RESULT.....	31
10.4	LIMITS	31
11	LINE CONDUCTED EMISSION , FCC 15.207.....	32
11.1	TEST PROCEDURE.....	32
11.2	TEST RESULTS	32
12	FREQUENCY STABILITY VS. TEMPERATURE , FCC 2.1055 , 74.861 (E)	34
12.1	TEST PROCEDURE.....	34
12.2	TEST RESULTS	34
13	FREQUENCY STABILITY VS. VOLTAGE , FCC 2.1055 (D) ; 74.861 (E).....	36
13.1	TEST PROCEDURE.....	36
13.2	TEST RESULTS	36
APPENDIX		37



Worldwide Testing Services(Taiwan) Co., Ltd.

Registration number: W6M21108-11777-C-1
FCC ID: M5X-ACT8HA

1 General Information

1.1 Notes

The purpose of conformity testing is to increase the probability of adherence to the essential requirements or conformity specifications, as appropriate.

The complexity of the technical specifications, however, means that full and thorough testing is impractical for both technical and economic reasons.

Furthermore, there is no guarantee that a test sample which has passed all the relevant tests conforms to a specification.

Neither is there any guarantee that such a test sample will interwork with other genuinely open systems. The existence of the tests nevertheless provides the confidence that the test sample possesses the qualities as maintained and that its performance generally conforms to representative cases of communications equipment.

The test results of this test report relate exclusively to the item tested as specified in 1.5.

The test report may only be reproduced or published in full.

Reproduction or publication of extracts from the report requires the prior written approval of the Worldwide Testing Services (Taiwan) Co., Ltd.

Tester:

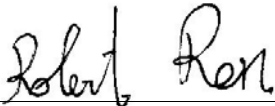
October 13, 2011	Robert Ren	
Date	WTS-Lab. Name	Signature

Technical responsibility for area of testing:

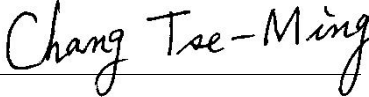
October 13, 2011	Chang Tse-Ming	
Date	WTS Name	Signature



Worldwide Testing Services(Taiwan) Co., Ltd.

Registration number: W6M21108-11777-C-1
FCC ID: M5X-ACT8HA

1.2 Testing laboratory

1.2.1 Location

OATS
No.5-1, Shuang Sing Village,
LiShuei Rd., Wanli Dist.,
New Taipei City 207, Taiwan (R.O.C.)

Company
Worldwide Testing Services(Taiwan) Co., Ltd.
6F, NO. 58, LANE 188, RUEY-KUANG RD.
NEIHU, TAIPEI 114, TAIWAN R.O.C.
Tel : 886-2-66068877
Fax : 886-2-66068879

1.2.2 Details of accreditation status

Accredited testing laboratory

A2LA accredited number: 2732.01

FCC filed test laboratory Reg. No. 930600

Industry Canada filed test laboratory Reg. No. IC 5679A-1



Test location, where different from Worldwide Testing Services (Taiwan) Co., Ltd. :

Name: ./.
Accredited number: ./.
Street: ./.
Town: ./.
Country: ./.
Telephone: ./.
Fax: ./.

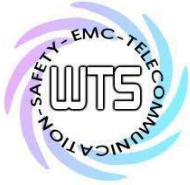

Worldwide Testing Services(Taiwan) Co., Ltd.

Registration number: W6M21108-11777-C-1

FCC ID: M5X-ACT8HA

1.3 Details of approval holder

Name: MIPRO Electronics Co., Ltd.
Street: 814 Pei-kang Road
Town: Chia-yi, 600
Country: Taiwan, R.O.C.
Telephone: +886-5-238-0809
Fax: +886-5-238-0803

1.4 Application details

Date of receipt of test item: August 30, 2011
Date of test: from August 30, 2011 to October 13, 2011

1.5 General information of Test item

Type of test item: Digital Handheld Transmitter
Model Number: ACT-8Ha
Brand Name: MIPRO
Multi-listing model number: ./.
Photos: see Appendix

Technical data

Frequency band :

Frequency(MHz)	TV Band	Used Band
26.100-26.480	<input type="checkbox"/>	<input type="checkbox"/>
54.000-72.000	<input type="checkbox"/>	<input type="checkbox"/>
76.000-88.000	<input type="checkbox"/>	<input type="checkbox"/>
161.625-161.775	<input type="checkbox"/>	<input type="checkbox"/>
174.000-216.000	<input type="checkbox"/>	<input type="checkbox"/>
450.000-451.000	<input type="checkbox"/>	<input type="checkbox"/>
455.000-456.000	<input type="checkbox"/>	<input type="checkbox"/>
470.000-488.000	<input checked="" type="checkbox"/>	<input checked="" type="checkbox"/>
488.000-494.000	<input checked="" type="checkbox"/>	<input checked="" type="checkbox"/>
494.000-608.000	<input checked="" type="checkbox"/>	<input checked="" type="checkbox"/>
614.000-698.000	<input type="checkbox"/>	<input type="checkbox"/>
944.000-952.000	<input type="checkbox"/>	<input type="checkbox"/>

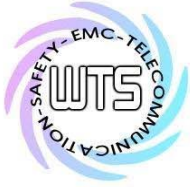

Worldwide Testing Services(Taiwan) Co., Ltd.

Registration number: W6M21108-11777-C-1
FCC ID: M5X-ACT8HA

Frequency band: 482~602 MHz
Frequency (ch A): 482.1 MHz
Frequency (ch B): 542.0 MHz
Frequency (ch C): 601.9 MHz
Antenna Type: Helical antenna / gain:0 dBi
Power supply: Adapter (I/P: 100-240V, 1.0A, 50-60Hz; O/P: 12V, 2.2A)
Battery (7.4V, 1120mAh)
Operation modes: Simplex

Additional information: The EUT is the portable device. So the EUT was tested on three different axes. The EUT uses the frequency range that are more than 10 MHz, so that was tested on low, middle, and high three different frequencies.

Manufacturer: (if different from approval holder)

Name: ./.
Street: ./.
Town: ./.
Country: ./.

1.6 Test standards

Technical standard: FCC Part 74 Subpart H , section 74.861 (2010-10)

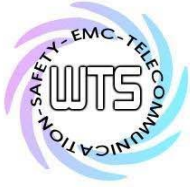

Registration number: W6M21108-11777-C-1

FCC ID: M5X-ACT8HA

2 Technical test

2.1 Summary of test results

No deviations from the technical specification(s) were ascertained in the course of the tests performed.

or

The deviations as specified in 3 were ascertained in the course of the tests performed.

2.2 Test environment

Temperature: 25 °C

Relative humidity content: 20 ... 75 %

Air pressure: 86-103 KPa

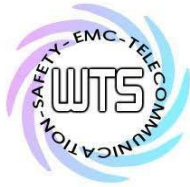

Registration number: W6M21108-11777-C-1

FCC ID: M5X-ACT8HA

2.3 Test Equipment List

No.	Test equipment	Type	Serial No.	Manufacturer	Cal. Date	Next Cal. Date
ETSTW-CE 001	EMI TEST RECEIVER	ESHS10	842121/013	R&S	2011/9/2	2012/9/1
ETSTW-CE 003	AC POWER SOURCE	APS-9102	D161137	GW	Function Test	
ETSTW-CE 004	ZWEILEITER-V-NETZNACHBILDUNG TWO-LINE V-NETWORK	ESH3-Z5	840731/011	R&S	2011/3/10	2012/3/9
ETSTW-CE 005	Line-Impedance Stabilisation Network	NNBM 8126D	137	Schwarzbeck	2011/9/5	2012/9/4
ETSTW-CE 006	IMPULSBEGRENZER PULSE LIMITER	ESH3-Z2	100226	R&S	2011/3/8	2012/3/7
ETSTW-CE 007	SPECTRUM ANALYZER 5GHz	FSB	849670/001	R&S	Pre-test Use NCR	
ETSTW-CE 008	HF-EICHLITUNG RF STEP ATTENUATOR 139dB DPSP	334.6010.02	844581/024	R&S	Function Test	
ETSTW-CE 009	TEMP.&HUMIDITY CHAMBER	GTH-225-40-1P-U	MAA0305-009	GIANT FORCE	2011/7/13	2012/7/12
ETSTW-CE 013	CISPR 22 TWO BALANCED TELECOM PAIRS IMPEDANCE STABILIZATION NETWORK	FCC-TLISN-T4-02	20242	FCC	2011/9/6	2012/9/5
ETSTW-CE 016	TWO-LINE V-NETWORK	ENV216	100050	R&S	2011/2/21	2012/2/20
ETSTW-CE 024	IMPEDANCE STABILIZATION NETWORK	ISN T800	29454	TESEQ	2011/1/10	2012/1/9
ETSTW-CS 004	COUPLING AND DECOUPLING NETWORK	CDN M016	20053	SCHAFFNER	2011/8/12	2012/8/11
ETSTW-CS 005	RF Power Amplifier	100A250A	306547	AR	Function Test	
ETSTW-CS 009	6 dB Attenuator	75-A-FFN-06	70998	BIRD	2011/5/20	2012/5/19
ETSTW-CS 010	6 dB Attenuator	SA3N1007-06	None	AISI	2011/7/29	2012/7/28
ETSTW-RE 003	EMI TEST RECEIVER	ESI 26	831438/001	R&S	2011/8/16	2012/8/15
ETSTW-RE 004	EMI TEST RECEIVER	ESI 40	832427/004	R&S	2011/9/5	2012/9/4
ETSTW-RE 005	EMI TEST RECEIVER	ESVS10	843207/020	R&S	2011/9/2	2012/9/1
ETSTW-RE 010	ABSORBING CLAMP	MDS 21	3469	Schwarzbeck	2011/9/7	2012/9/6
ETSTW-RE 012	TUNABLE BANDREJECT FILTER	D.C 0309	146	K&L	Function Test	
ETSTW-RE 013	TUNABLE BANDREJECT FILTER	D.C 0336	397	K&L	Function Test	
ETSTW-RE 019	MICROWAVE HORN ANTENNA	22240-25	121074	FM	2011/4/25	2012/4/24
ETSTW-RE 020	MICROWAVE HORN ANTENNA	AT4002A	306915	AR	Function Test	
ETSTW-RE 027	Passive Loop Antenna	6512	00034563	ETS-Lindgren	2011/7/19	2012/7/18
ETSTW-RE 030	Double-Ridged Guide Horn Antenna	3117	00035224	EMCO	2011/2/25	2012/2/24
ETSTW-RE 032	Millivoltmeter	URV 55	849086/013	R&S	2011/10/3	2012/10/2
ETSTW-RE 033	WaveRunner 6000A Serie Oscilloscope	WAVERUNNER 6100A	LCRY0604P1450 8	LeCroy	Function Test	
ETSTW-RE 034	Power Sensor	URV5-Z4	839313/006	R&S	2011/10/3	2012/10/2
ETSTW-RE 042	Biconical Antenna	HK116	100172	R&S	2011/1/14	2012/1/13
ETSTW-RE 043	Log-Periodic Dipole Antenna	HL223	100166	R&S	2011/4/26	2012/4/25
ETSTW-RE 044	Log-Periodic Antenna	HL050	100094	R&S	2011/4/25	2012/4/24

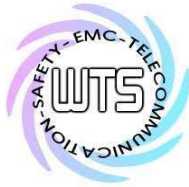

Worldwide Testing Services(Taiwan) Co., Ltd.

Registration number: W6M21108-11777-C-1

FCC ID: M5X-ACT8HA

ETSTW-RE 045	ESA-E SERIES SPECTRUM ANALYZER	E4404B	MY45111242	Agilent	Pre-test Use NCR	
ETSTW-RE 048	Triple Loop Antenna	HXYZ 9170	HXYZ 9170-134	Schwarzbeck	2011/8/29	2012/8/28
ETSTW-RE 049	TRILOG Super Broadband test Antenna	VULB 9160	9160-3185	Schwarzbeck	2011/4/8	2012/4/7
ETSTW-RE 050	Attenuator 10dB	50HF-010-1	None	JFW	2011/3/4	2012/3/3
ETSTW-RE 051	Attenuator 6dB	50HF-006-1	None	JFW	2011/3/4	2012/3/3
ETSTW-RE 053	Attenuator 3dB	50HF-003-1	None	JFW	2011/3/4	2012/3/3
ETSTW-RE 055	SPECTRUM ANALYZER	FSU 26	200074	R&S	2011/5/30	2012/5/29
ETSTW-RE 060	Attenuator 30dB	5015-30	F651012z-01	ATM	2011/3/4	2012/3/3
ETSTW-RE 061	Amplifier Module	CHC 1	None	ETS	2011/5/18	2012/5/17
ETSTW-RE 062	Amplifier Module	CHC 2	None	KMIC	2010/11/30	2011/11/29
ETSTW-RE 064	Bluetooth Test Set	MT8852B-042	6K00005709	Anritsu	Function Test	
ETSTW-RE 065	Amplifier	AMF-6F-18002650-25-10P	941608	MITEQ	2011/4/8	2012/4/7
ETSTW-RE 066	Highpass Filter	H1G013G1	206015	MICROWAVE CIRCUITS, INC.	2011/3/4	2012/3/3
ETSTW-RE 072	CELL SITE TEST SET	8921A	3339A00375	HP	2011/10/3	2012/10/2
ETSTW-RE 073	Power Meter	N1911A	MY45100769	Agilent	2011/1/10	2012/1/9
ETSTW-RE 074	Power Sensor	N1921A	MY45241198	Agilent	2011/1/10	2012/1/9
ETSTW-RE 081	Highpass Filter	H03G13G1	4260-02 DC0428	MICROWAVE CIRCUITS, INC.	2011/3/4	2012/3/3
ETSTW-RE 096	SIGNAL GENERATOR	SMIQ 03B	102274	R&S	2011/5/31	2012/5/30
ETSTW-RE 099	DC Block	50DB-007-1	None	JFW	2011/3/10	2012/3/9
ETSTW-RE 105	2.4GHz Notch Filter	NO124411	39555	MICROWAVE CIRCUITS, INC.	2011/3/11	2012/3/10
ETSTW-RE 106	Humidity Temperature Meter	TES-1366	091011113	TES	2011/3/24	2012/3/23
ETSTW-RE 111	Log-Periodic Dipole Array Antenna	VULB 9160	9160-3309	Schwarz beck	2010/12/17	2011/12/16
ETSTW-RE 112	AC POWER SOURCE	TFC-1005	None	T-Power	Function test	
ETSTW-RE 114	2.4GHz Notch Filter	N0124411	473873	MICROWAVE CIRCUITS	2011/1/13	2012/1/12
ETSTW-RE 120	RF Player	MP9200	MP9210-111022	ADIVIC	Function test	
ETSTW-RE 121	SPECTRUM ANALYZER	FSU43	100013	R&S	2011/6/23	2012/6/22
ETSTW-RE 122	SIGNAL GENERATOR	SMF100A	102149	R&S	2011/7/4	2012/7/3
ETSTW-RE 125	5GHz Notch filter	5NSL11-5200/E221.3-O/O	1	K&L Microwave	2011/8/19	2012/8/18
ETSTW-RE 126	5GHz Notch filter	5NSL11-5800/E221.3-O/O	1	K&L Microwave	2011/8/19	2012/8/18
ETSTW-EMI 001	HARMONICS 1000	HAR1000-1P	093	EMC-PARTNER	2011/9/1	2012/8/31
ETSTW-EMS 001	BASELSTRASSE 160 CH-4242 LAUFEN	CN-EFT1000	354	EMC-PARTNER	Function Test	
ETSTW-EMS 002	Frequency Converter	YF-6020	0308014	None	Function Test	
ETSTW-EMS 003	EMC Immunity Test System	TRA2000IN6	579	EMC-PARTNER	2010/11/3	2011/11/2
ETSTW-EMS 009	Magnetic Field Antenna	MF1000-1	104	EMC-PARTNER	Function Test	
ETSTW-EMS 012	EM Injection Clamp	F-203I-23MM	476	FCC	2011/6/1	2012/5/31
ETSTW-EMS 015	HVAC Trms Power Clamp	3079K	070800649	TES	2011/10/3	2012/10/2

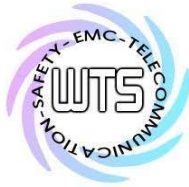

Worldwide Testing Services(Taiwan) Co., Ltd.

Registration number: W6M21108-11777-C-1

FCC ID: M5X-ACT8HA

	Meter					
ETSTW-EMS 016	EMF Tester	1390	071208732	TES	2011/10/3	2012/10/2
ETSTW-EMS 017	Multimeter	DM-1220	518614	HOLA	2011/8/11	2012/8/10
ETSTW-EMS 019	Electrostatic Discharge Simulator	ESS-2002	ESS06Y6300	NoiseKen	2010/11/25	2011/11/24
ETSTW-EMS 020	Humidity Temperature Meter	TES-1366	091011116	TES	2011/3/24	2012/3/23
ETSTW-RS 003	RF Power Amplifier	30S1G3	306933	AR	Function Test	
ETSTW-RS 004	RF Power Amplifier	150W1000	307009	AR	Function Test	
ETSTW-RS 006	SIGNAL GENERATOR	SML03	101551	R&S	2011/3/7	2012/3/6
ETSTW-RS 007	14" COLOR VIDEO MONITOR	HS-CM145A	0512011548	None	Function Test	
ETSTW-RS 009	SIGNAL GENERATOR	8648C	3642U01656	HP	2011/2/23	2012/2/22
ETSTW-RS 010	Broadband Field Meter	NBM-520	C-0195	Narda	2011/9/8	2012/9/7
ETSTW-GSM 002	Universal Radio Communication Tester	CMU 200	109439	R&S	2011/10/3	2012/10/2
ETSTW-GSM 019	Band Reject Filter	WRCTF824/849-822/851-40 /12+9SS	3	WI	2011/1/14	2012/1/13
ETSTW-GSM 020	Band Reject Filter	WRCD1747/1748-1743/1752-32/5SS	1	WI	2011/1/14	2012/1/13
ETSTW-GSM 021	Band Reject Filter	WRCD1879.5/1880.5-1875.5/1884.5-32/5SS	3	WI	2011/1/14	2012/1/13
ETSTW-GSM 022	Band Reject Filter	WRCT901.9/903.1-904.25-50/8SS	1	WI	2011/1/14	2012/1/13
ETSTW-GSM 023	Power Divider	4901.19.A	None	SUHNER	2011/9/19	2012/9/18
ETSTW-Cable 002	Microwave Cable	SUCOFLEX 104 (S_Cable 7)	238093	HUBER+SUHNER	2011/5/18	2012/5/17
ETSTW-Cable 003	Microwave Cable	SUCOFLEX 104 (S_Cable 11)	209953	HUBER+SUHNER	2011/5/18	2012/5/17
ETSTW-Cable 010	BNC Cable	5 M BNC Cable	None	JYE BAO CO.,LTD.	2011/3/8	2012/3/7
ETSTW-Cable 011	BNC Cable	BNC Cable 1	None	JYE BAO CO.,LTD.	Pre-test Use NCR	
ETSTW-Cable 012	BNC Cable	BNC Cable 2	None	JYE BAO CO.,LTD.	2011/3/8	2012/3/7
ETSTW-Cable 013	Microwave Cable	SUCOFLEX 104 (S_Cable 5)	232345	HUBER+SUHNER	Function Test	
ETSTW-Cable 016	BNC Cable	Switch Box	B Cable 1	Schwarz beck	2011/3/4	2012/3/3
ETSTW-Cable 017	BNC Cable	X Cable	B Cable 2	Schwarz beck	2011/3/4	2012/3/3
ETSTW-Cable 018	BNC Cable	Y Cable	B Cable 3	Schwarz beck	2011/3/4	2012/3/3
ETSTW-Cable 019	BNC Cable	Z Cable	B Cable 4	Schwarz beck	2011/3/4	2012/3/3
ETSTW-Cable 022	N TYPE Cable	OATS Cable 3	0002	JYE BAO CO.,LTD.	2011/3/4	2012/3/3
ETSTW-Cable 026	Microwave Cable	SUCOFLEX 104	279075	HUBER+SUHNER	2011/3/10	2012/3/9
ETSTW-Cable 027	Microwave Cable	SUCOFLEX 104	279083	HUBER+SUHNER	2011/3/10	2012/3/9
ETSTW-Cable 028	Microwave Cable	FA147A0015M2020	30064-2	UTIFLEX	2011/4/26	2012/4/25
ETSTW-Cable 029	Microwave Cable	FA147A0015M2020	30064-3	UTIFLEX	2011/4/26	2012/4/25
ETSTW-Cable 030	Microwave Cable	SUCOFLEX 104 (S_Cable 9)	279067	SPECTRUM	2011/3/10	2012/3/9
ETSTW-Cable 031	Microwave Cable	SUCOFLEX 104 (S_Cable 10)	238092	HUBER+SUHNER	2010/11/30	2011/11/29
ETSTW-Cable 039	Microwave Cable	SUCOFLEX 104 (S_Cable 19)	316739	HUBER+SUHNER	2011/5/18	2012/5/17

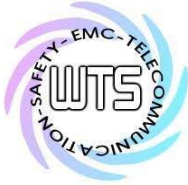

Worldwide Testing Services(Taiwan) Co., Ltd.

Registration number: W6M21108-11777-C-1

FCC ID: M5X-ACT8HA

ETSTW-Cable 040	Microwave Cable	SUCOFLEX 104 (S_Cable 20)	316738	HUBER+SUHNER	Function Test	
ETSTW-Cable 043	Microwave Cable	SUCOFLEX 104	317576	HUBER+SUHNER	2010/11/30	2011/11/29
ETSTW-Cable 047	Microwave Cable	SUCOFLEX 104	325518	HUBER+SUHNER	2010/11/30	2011/11/29
ETSTW-Cable 051	BNC Cable	BNC Cable 6	None	JYE BAO CO.,LTD.	2011/3/31	2012/3/30
ETSTW-Cable 052	BNC Cable	Clamp Cable	None	Schwarz beck	2011/3/31	2012/3/30
ETSTW-Cable 053	N TYPE To SMA Cable	OATS Cable 4	None	JYE BAO CO.,LTD.	2011/3/4	2012/3/3
ETSTW-Cable 054	BNC To SMA Cable	OATS Cable 5	None	JYE BAO CO.,LTD.	2011/3/4	2012/3/3
ETSTW-Cable 055	Microwave Cable	SUCOFLEX 104	None	HUBER+SUHNER	Function Test	
ETSTW-Cable 056	N TYPE Cable	N30N30-JBY240-80CM	20110621-1.0	JYE BAO CO.,LTD.	Function Test	
ETSTW-Cable 057	N TYPE Cable	N30N30-JBY240-80CM	20110621-1.1	JYE BAO CO.,LTD.	Function Test	
WTSTW-SW 001	EMI TEST SOFTWARE	Harmonics-1000	None	EMC PARTNER	HARCS Version 4.16 Firmware Version 2.18	
WTSTW-SW 002	EMI TEST SOFTWARE	EZ EMC	None	Farad	Version ETS-03A1	
WTSTW-SW 003	EMS TEST SOFTWARE	i2	None	AUDIX	Version 3.2007-8-17b	
WTSTW-SW 005	GSM Fading Level Correction	GSMFadLevCor	None	R&S	Version 1.66	



Registration number: W6M21108-11777-C-1
FCC ID: M5X-ACT8HA

2.4 General Test Procedure

POWER LINE CONDUCTED INTERFERENCE: The procedure used was ANSI STANDARD C63.4-2009 5.2 using a 50 μ H LISN (if necessary). Both lines were observed. The bandwidth of the spectrum analyzer was 10 kHz with an appropriate sweep speed.

RADIATION INTERFERENCE: The test procedure used was according to ANSI STANDARD C63.4-2009 6.4 employing a spectrum analyzer. For investigated frequency is equal to or below 1GHz, the RBW and VBW of the spectrum analyzer were 100 kHz and 100 kHz respectively with an appropriate sweep speed. For investigated frequency is above 1GHz, both of RBW and VBW of the spectrum analyzer were 1 MHz with an appropriate sweep speed. The analyzer was calibrated in dB above a microvolt at the output of the antenna. The ambient temperature of the UUT was 23°C with a humidity of 40 %.

The table used for radiated measurements is capable of continuous rotation. The spectrum was scanned from 30 MHz to the frequency specified as follows:

- (1) If the intentional radiator operates below 10 GHz: to the tenth harmonic of the highest fundamental frequency or to 40 GHz, whichever is lower.
- (2) If the intentional radiator operates at or above 10 GHz and below 30 GHz: to the fifth harmonic of the highest fundamental frequency or to 100 GHz, whichever is lower.
- (3) If the intentional radiator operates at or above 30 GHz: to the fifth harmonic of the highest fundamental frequency or to 200 GHz, whichever is lower, unless specified otherwise elsewhere in the rules.
- (4) If the intentional radiator contains a digital device, regardless of whether this digital device controls the functions of the intentional radiator or the digital device is used for additional control or function purposes other than to enable the operation of the intentional radiator, the frequency range shall be investigated up to the range specified in paragraphs (a)(1)-(a)(3) of this section or the range applicable to the digital device, as shown in paragraph (b)(1) of this Section, whichever is the higher frequency range of investigation.

For hand-held devices, a exploratory test was performed with three (3) orthogonal planes to determine the highest emissions.

Measurements were made by at the registered open field test site located at The Registration Number: When an emission was found, the table was rotated to produce the maximum signal strength. At this point, the antenna was raised and lowered from 1m to 4m. The antenna was placed in both the horizontal and vertical planes.

ANSI STANDARD C63.4-2009 10.2.7: Any measurements that utilize special test software shall be indicated and referenced in the test report. During testing, test software 'EZ EMC' was used for setting up different operation modes.

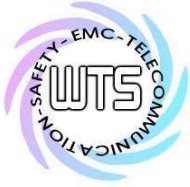

Registration number: W6M21108-11777-C-1
 FCC ID: M5X-ACT8HA

3 Test results (enclosure)

Test case	Para. Number	Required	Test passed	Test failed
RF Power Output	2.1046 (a); 74.861 (e)(1)	<input checked="" type="checkbox"/>	<input checked="" type="checkbox"/>	<input type="checkbox"/>
Modulation Deviation	2.1047 (b); 74.861 (e)(2)	<input type="checkbox"/>	<input type="checkbox"/>	<input type="checkbox"/>
Audio Frequency Response	2.1047 (a)	<input type="checkbox"/>	<input type="checkbox"/>	<input type="checkbox"/>
Occupied Bandwidth / Emission Mask	2.1049 (c)(1); 74.861 (e)(5)	<input checked="" type="checkbox"/>	<input checked="" type="checkbox"/>	<input type="checkbox"/>
Spurious Emissions at Antenna Terminals	2.1051 74.861(e)(6)	<input type="checkbox"/>	<input type="checkbox"/>	<input type="checkbox"/>
Radiated Spurious Emission	2.1053 74.861(e)(6)	<input checked="" type="checkbox"/>	<input checked="" type="checkbox"/>	<input type="checkbox"/>
Line Conducted Emissions	15.207	<input checked="" type="checkbox"/>	<input checked="" type="checkbox"/>	<input type="checkbox"/>
Frequency Stability vs. Temperature	2.1055 (b); 74.861(e)(4)	<input checked="" type="checkbox"/>	<input checked="" type="checkbox"/>	<input type="checkbox"/>
Frequency Stability vs. Voltage	2.1055 (a)(1); 74.861 (e)(4)	<input checked="" type="checkbox"/>	<input checked="" type="checkbox"/>	<input type="checkbox"/>

The follows is intended to leave blank.



Registration number: W6M21108-11777-C-1
 FCC ID: M5X-ACT8HA

4 RF Power Output (conducted) , FCC 2.1046 (a) ; 74.861 (e)

4.1 Test procedure

This transmitter output was connected to a calibrated coaxial attenuator, the other end of which was connected to a spectrum analyzer. Transmitter output was derived with the spectrum analyzer in dBm. The power output at the transmitter antenna port was determined by assign the value of the attenuator to the spectrum analyzer reading.

An HP power meter was also used to measure the RF power.

Tests were performed with an un-modulated carrier at three frequencies (low , middle and high channels) and on all power levels , which can be set-up on the transmitters.

4.2 Test Results

Frequency Channel	Peak Output Power (dBm)
-- MHz	--
-- MHz	--
-- MHz	--

Limits:

LPAS operating in TV bands	
Frequency [MHz]	Conducted output power [mW]
54 – 72 76 – 88 174 - 216	50 (17 dBm)
470 – 608 614 – 698	250 (24 dBm)

LPAS operating in other than TV bands	
Conducted power [W]	1

Test equipment used: ETSTW-RE 055

Explanation :This test is not required.



Registration number: W6M21108-11777-C-1
FCC ID: M5X-ACT8HA

5 Radiated Power

5.1 Test Procedure

The EUT was positioned on a non-conductive turntable, 0.8m above the ground on an open test site. The radiated emission at the fundamental frequency was measured at 3m distance with a test antenna and spectrum analyzer.

Worst case emission was recorded with the rotation of the turntable and the raising and lowering of the test antenna.

Substitution RF power Measurement at WTS

General :

The applied substitution method follows ANSI/TIA/EIA-603,ANSI/TIA/EIA-102.CAAA or the appropriate ETSI rules respectively.

The actual signal generated by the EUT can be determined by means of a substitution measurement in which a known signal source replaces the device to be measured.

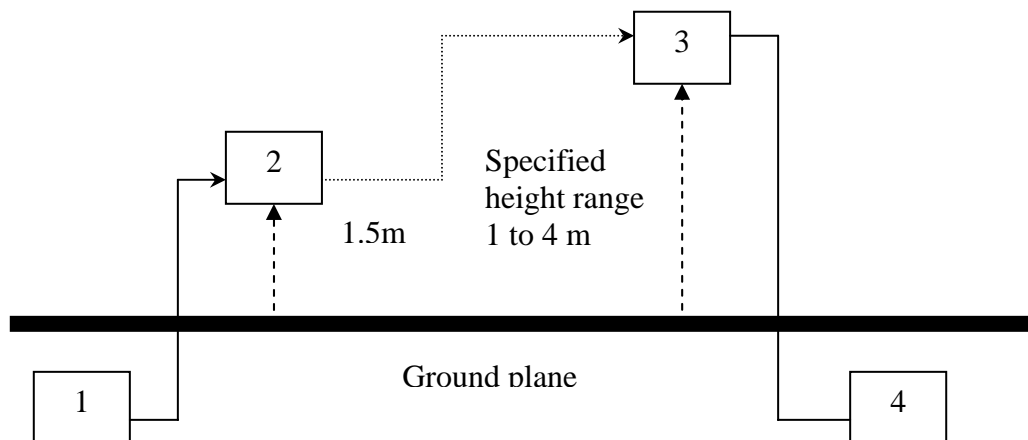

- 1) Signal generator ;
- 2) Substitution antenna ;
- 3) Test antenna ;
- 4) Spectrum analyzer or selective voltmeter.

The substitution antenna replaces the transmitter antenna at the same position and in vertical polarization. The frequency of the signal generator shall be adjusted to the measurement frequency.

The test antenna shall be raised or lowered, if necessary, to ensure that the maximum signal is still received. The input signal to the substitution antenna shall be adjusted in level until an equal or a known related level to that detected from the transmitter is obtained in the measurement receiver.

If a fully anechoic chamber is used as test site in order to provide free space conditions there is no need to change the height of the antenna.

The measurement will be repeated in horizontal position.

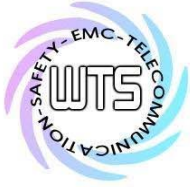

Registration number: W6M21108-11777-C-1
FCC ID: M5X-ACT8HA

Calibration :

In order to make this kind of measurement more effective and to avoid subjective measurement faults WTS has installed automatic computer controlled measurement procedures.

With the above described substitution method a test site is calibrated over the full frequency range which is used in suitable frequency steps. For a certain power level on the substitution antenna the received power over the whole frequency range is documented. All necessary antenna gains, cable losses, filter losses and amplifications of preamplifiers are taken in consideration. The summary of this calibration measurement performs a transducer factor that is related to the considered test site and a certain measurement distance. Differences of the radiated power levels of different test samples are determined by internal attenuation of measurement receiver . The proper function of such test site will be maintained by short term plausibility checks and periodical re-calibration.

Testing :

Now the test sample will be putted on the table at the defined position and the radiated power will be receiver and documented by the measurement receiver.

On test sites with ground plane the measurement antenna will be lowered and raised to maximum values at significant frequencies.

For peak power measurements the sample is turned by the turntable over 360 degree in order to find the direction with the maximum radiation or to document the max reading with the MAXHOLD function during the rotation.



Registration number: W6M21108-11777-C-1

FCC ID: M5X-ACT8HA

5.2 Test results

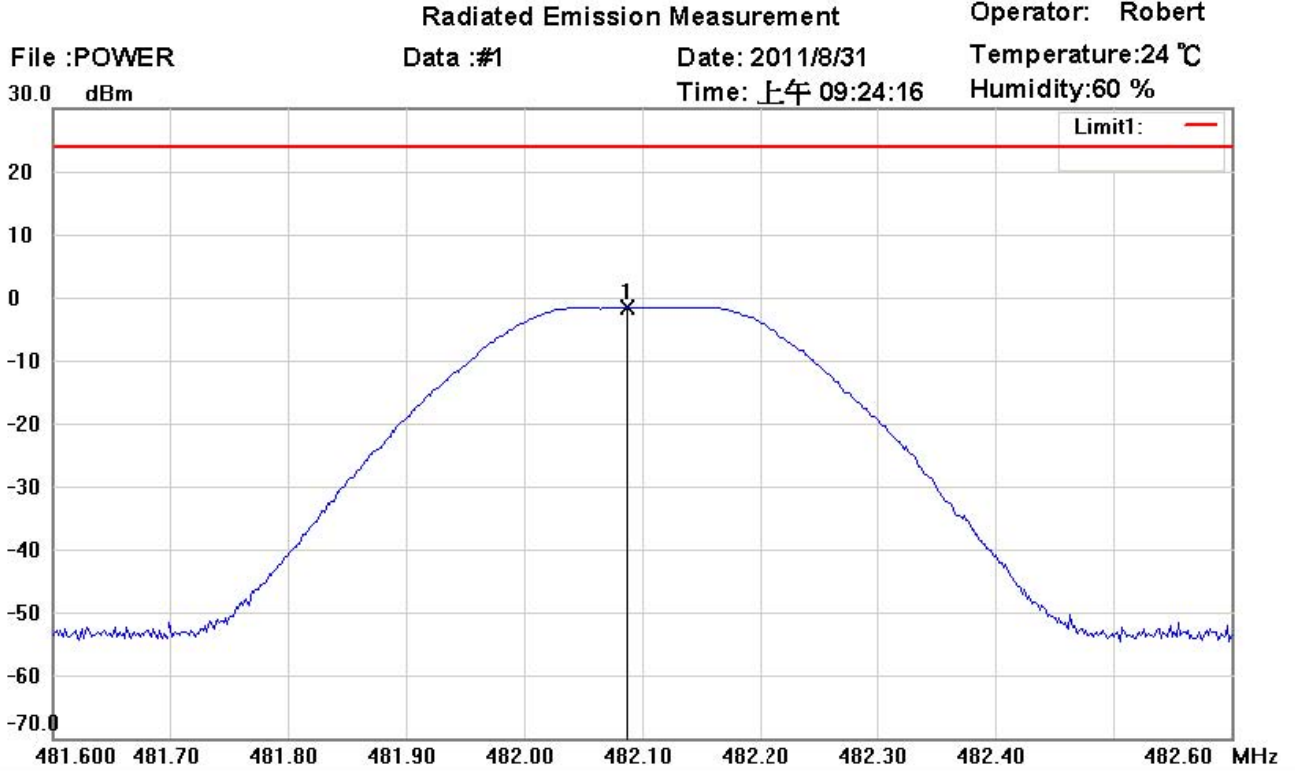

Site : Chamber

Condition : FCC 74.861 power(470-608 and 614-806)

Polarization: *Horizontal*

EUT : W6M21108-11777

Power : 7.4VDC

M/N: ACT-8Ha

Distance: 3m

Test Mode : 482.1MHz

Note :

Mk.	Frequency (MHz)	Reading (dBm)	Detector	Corrected factor(dB)	Result (dBm)	Limit (dBm)	Ant.Pos (cm)	Tab.Pos (deg.)	Margin (dB)	Comment
*	482.0872	-28.78	peak	27.21	-1.57	24.00	150	90	-25.57	



Worldwide Testing Services(Taiwan) Co., Ltd.

Registration number: W6M21108-11777-C-1
 FCC ID: M5X-ACT8HA

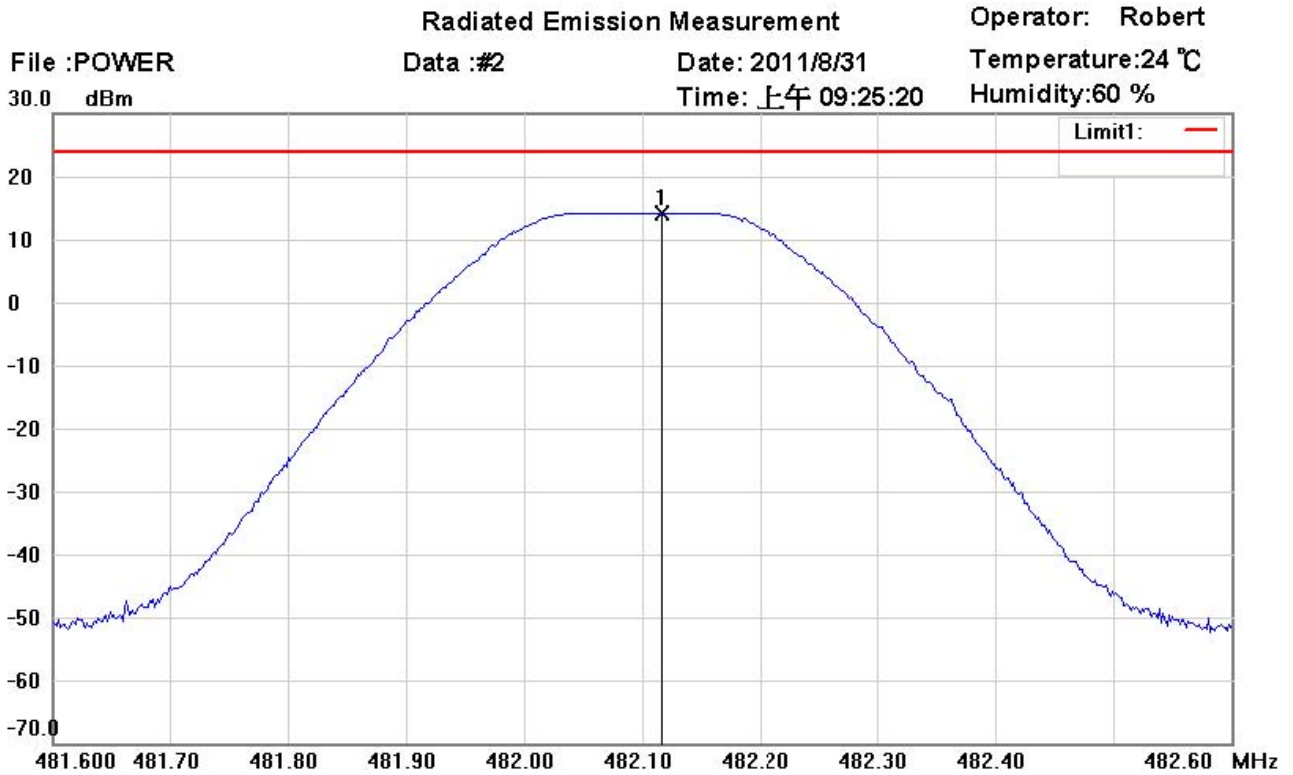

Site : Chamber
 Condition : FCC 74.861 power(470-608 and 614-806) Polarization: *Vertical*
 EUT : W6M21108-11777 Power : 7.4VDC
 M/N: ACT-8Ha Distance: 3m
 Test Mode : 482.1MHz
 Note :

Mk.	Frequency (MHz)	Reading (dBm)	Detector	Corrected factor(dB)	Result (dBm)	Limit (dBm)	Ant.Pos (cm)	Tab.Pos (deg)	Margin (dB)	Comment
*	482.1160	-13.65	peak	27.88	14.23	24.00	150	90	-9.77	



Worldwide Testing Services(Taiwan) Co., Ltd.

Registration number: W6M21108-11777-C-1
 FCC ID: M5X-ACT8HA

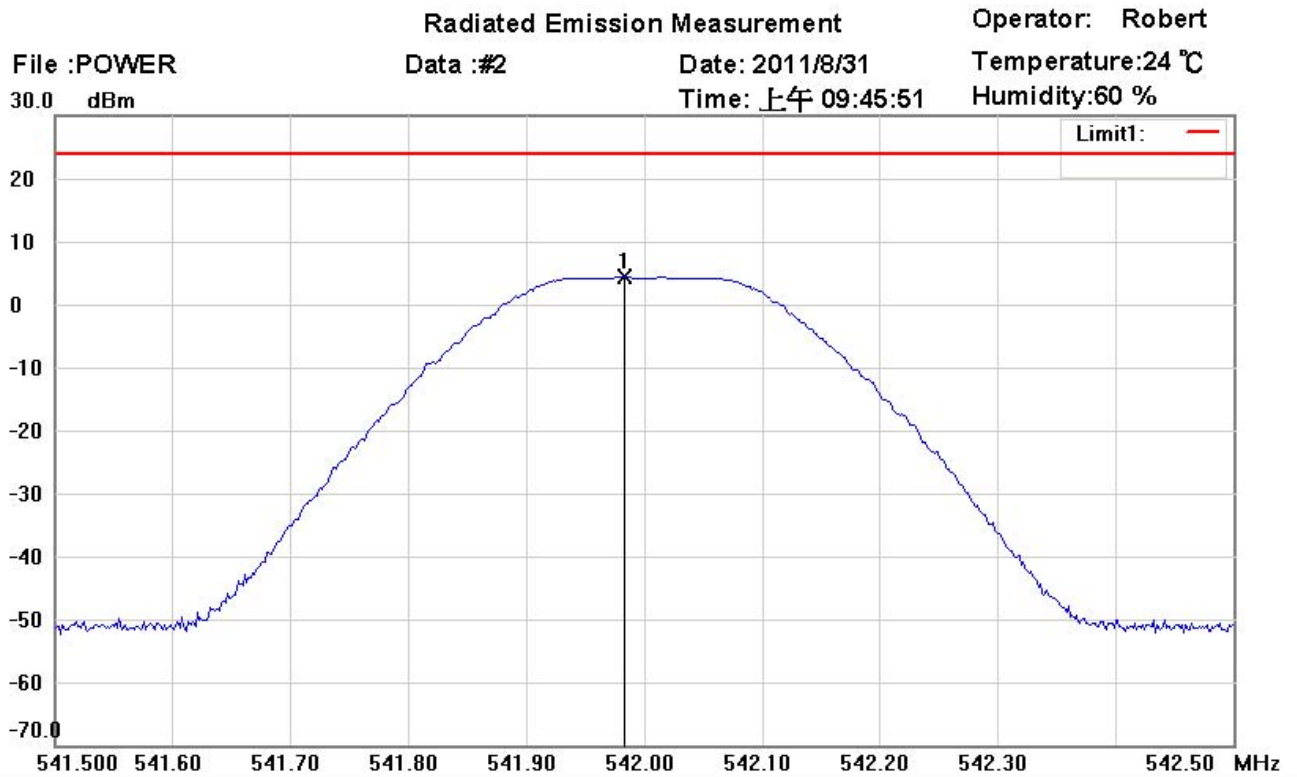

Site : Chamber
 Condition : FCC 74.861 power(470-608 and 614-806) Polarization: *Horizontal*
 EUT : W6M21108-11777 Power : 7.4VDC
 M/N: ACT-8Ha Distance: 3m
 Test Mode : 542MHz
 Note :

Mk.	Frequency (MHz)	Reading (dBm)	Detector	Corrected factor(dB)	Result (dBm)	Limit (dBm)	Ant.Pos (cm)	Tab.Pos (deg)	Margin (dB)	Comment
*	541.9840	-25.09	peak	29.36	4.27	24.00	150	270	-19.73	

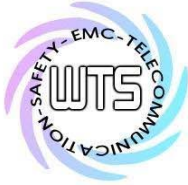

Worldwide Testing Services(Taiwan) Co., Ltd.

Registration number: W6M21108-11777-C-1
 FCC ID: M5X-ACT8HA

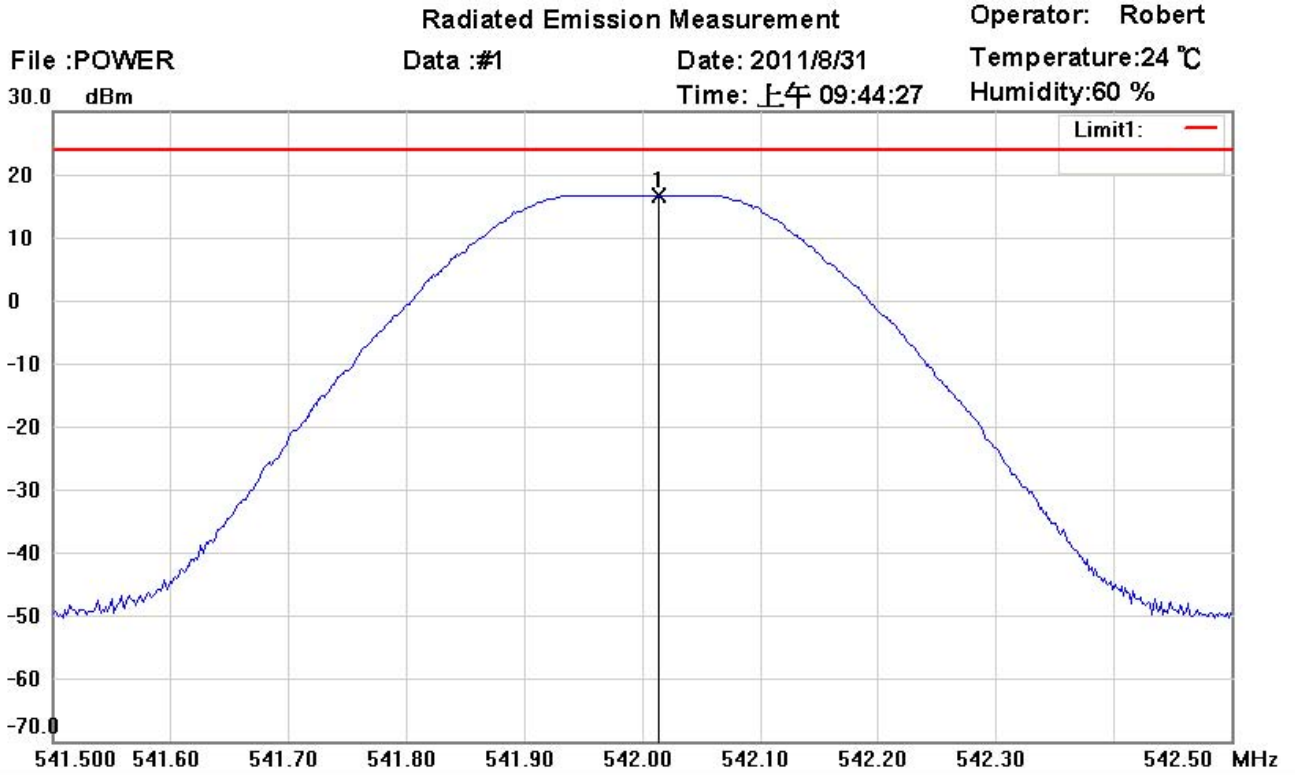

Site : Chamber
 Condition : FCC 74.861 power(470-608 and 614-806) Polarization: *Vertical*
 EUT : W6M21108-11777 Power : 7.4VDC
 M/N: ACT-8Ha Distance: 3m
 Test Mode : 542MHz
 Note :

Mk.	Frequency (MHz)	Reading (dBm)	Detector	Corrected factor(dB)	Result (dBm)	Limit (dBm)	Ant.Pos (cm)	Tab.Pos (deg)	Margin (dB)	Comment
*	542.0144	-12.79	peak	29.48	16.69	24.00	150	90	-7.31	

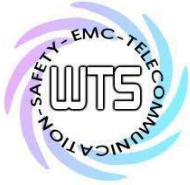

Worldwide Testing Services(Taiwan) Co., Ltd.

Registration number: W6M21108-11777-C-1
 FCC ID: M5X-ACT8HA

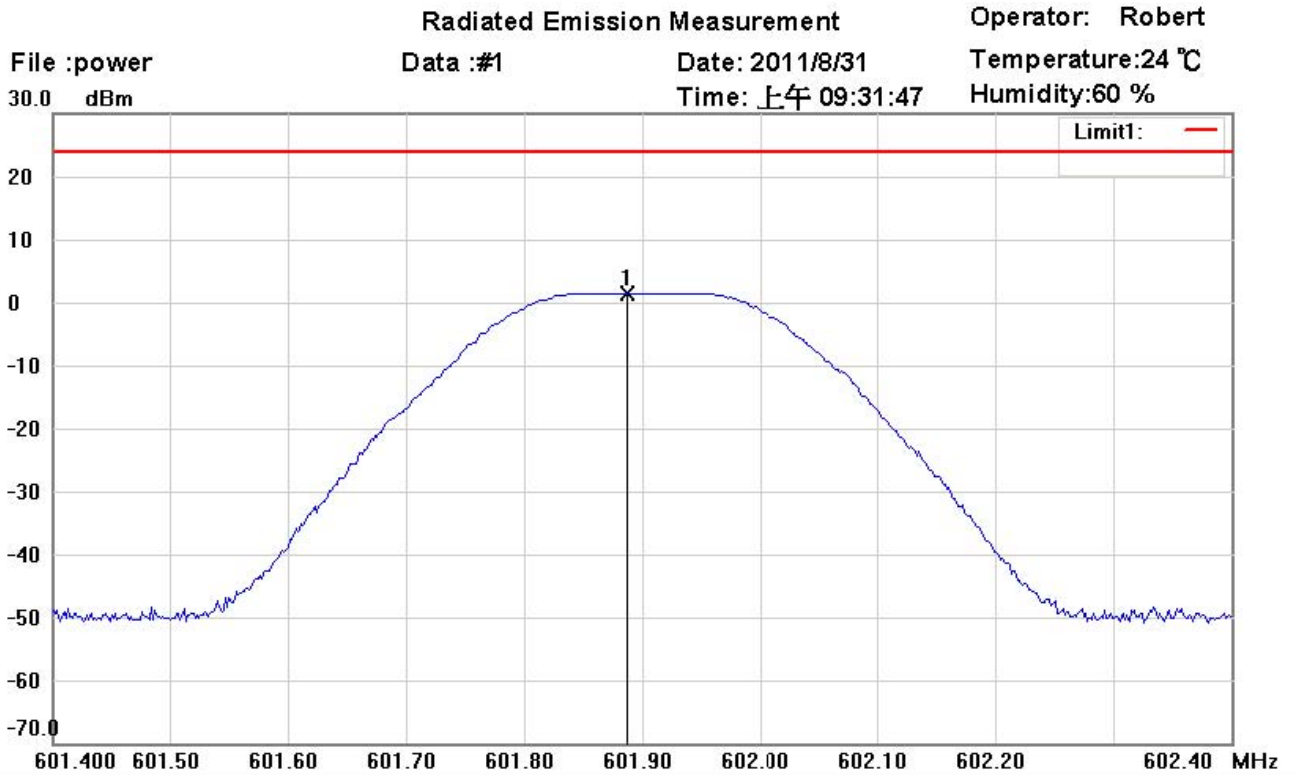

Site : Chamber
 Condition : FCC 74.861 power(470-608 and 614-806) Polarization: *Horizontal*
 EUT : W6M21108-11777 Power : 7.4VDC
 M/N: ACT-8Ha Distance: 3m
 Test Mode : 601.9MHz
 Note :

Mk.	Frequency (MHz)	Reading (dBm)	Detector	Corrected factor(dB)	Result (dBm)	Limit (dBm)	Ant.Pos (cm)	Tab.Pos (deg)	Margin (dB)	Comment
*	601.8872	-29.35	peak	30.78	1.43	24.00	150	270	-22.57	



Worldwide Testing Services(Taiwan) Co., Ltd.

Registration number: W6M21108-11777-C-1
 FCC ID: M5X-ACT8HA

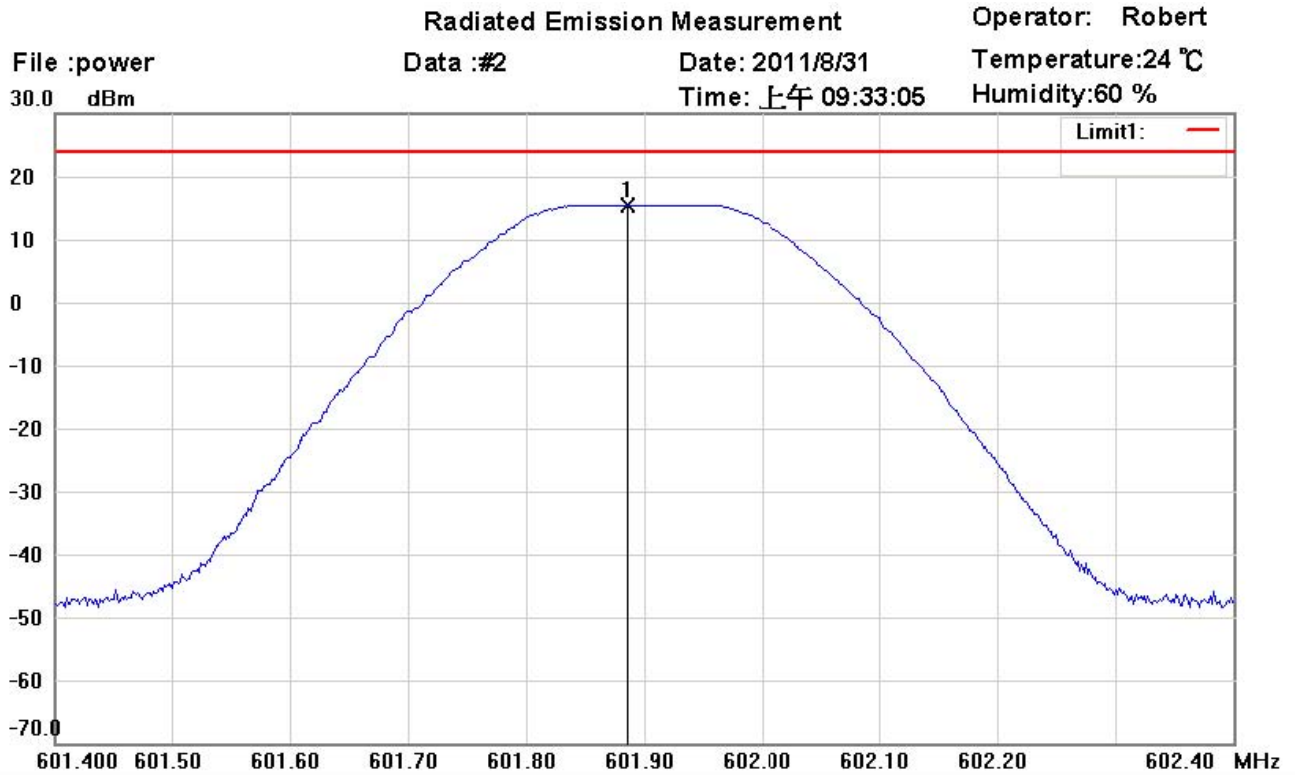

Site : Chamber
 Condition : FCC 74.861 power(470-608 and 614-806) Polarization: *Vertical*
 EUT : W6M21108-11777 Power : 7.4VDC
 M/N: ACT-8Ha Distance: 3m
 Test Mode : 601.9MHz
 Note :

Mk.	Frequency (MHz)	Reading (dBm)	Detector	Corrected factor(dB)	Result (dBm)	Limit (dBm)	Ant.Pos (cm)	Tab.Pos (deg)	Margin (dB)	Comment
*	601.8956	-16.67	peak	32.11	15.44	24.00	150	90	-8.56	

Test equipment used: ETSTW-RE 003, ETSTW-RE 004, ETSTW-RE 021, ETSTW-RE 042, ETSTW-RE 043



Registration number: W6M21108-11777-C-1

FCC ID: M5X-ACT8HA

6 Modulation Deviation , FCC 2.1047 (b) ; 74.861(e)

6.1 Test procedure

Modulation limiting is the transmitter circuit's ability to limit the transmitter from producing deviations in excess of rated system deviation.

The audio signal generator is connected to the audio input of the EUT with its full rating.

The modulation response is measured at certain modulation frequencies, related to 1000Hz reference signal. Tests are performed for positive and negative modulation.

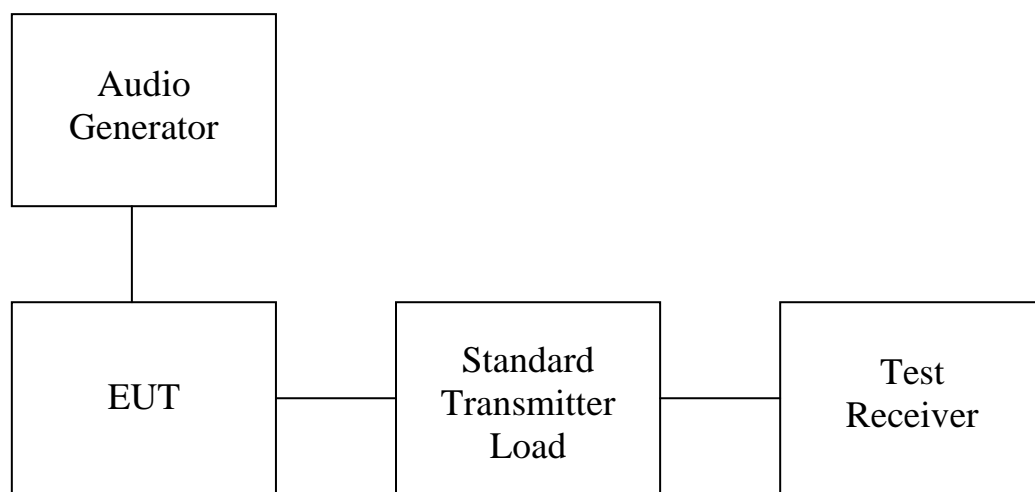

6.2 Test results

Explanation: This test is not required because the EUT is digital device.

Limits : ± 75 kHz

Test equipment used: ETSTW-RE 002, ETSTW-RE 055

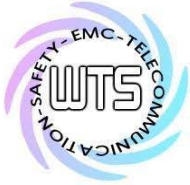

Registration number: W6M21108-11777-C-1

FCC ID: M5X-ACT8HA

7 Audio frequency response , FCC 2.1047 (a)

7.1 Test procedure

The audio frequency response is the degree of closeness to which the frequency deviation of the transmitter follows a prescribed characteristic.

The frequency response of the audio modulation part is measured over a frequency range of 100 Hz to 5000 Hz.

For 1000 Hz tone reference signal the audio generator level is adjusted to get 20% of the rated system deviation.

The deviations obtained over the frequency range from 100 Hz to 5000 Hz are recorded and compared with the reference deviation as follows :

$$\text{Audio Frequency Response} = 20 \log [\text{DEV}_{\text{Freq}} / \text{DEV}_{\text{ref}}].$$

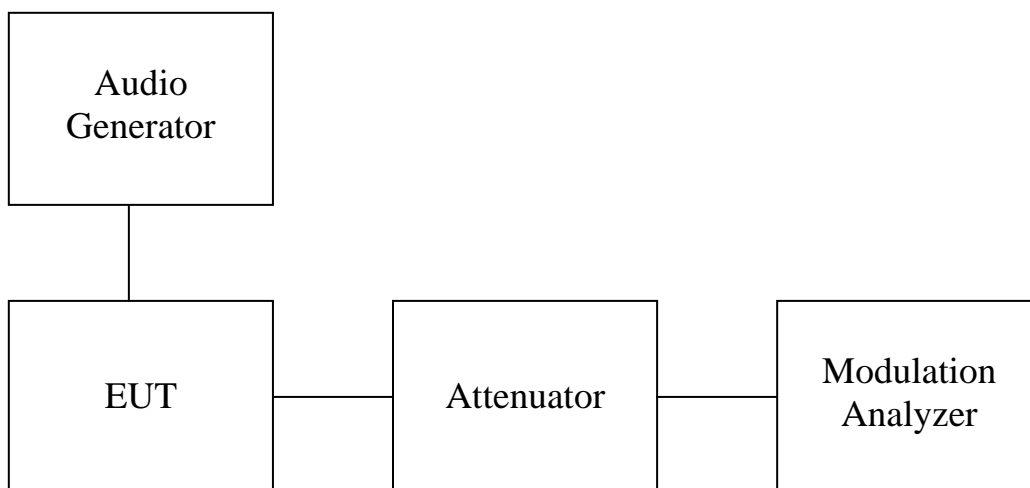

7.2 Test results

Explanation: This test is not required because the EUT is digital device.

Test equipment used: ETSTW-RE 002

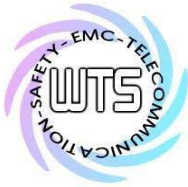

Registration number: W6M21108-11777-C-1

FCC ID: M5X-ACT8HA

8 Occupied Bandwidth/Emission Mask, FCC 2.1049 (c) ; 74.861 (e)(5)

The occupied bandwidth, that is the frequency bandwidth such that, below its lower and above its upper frequency limits, the mean powers radiated are each equal to 0.5 percent of the total mean power. Near the carrier an Emission Mask is defined by the standard.

8.1 Test procedure

The RF output of the transceiver was connected to the input of the spectrum analyzer through sufficient attenuation.

Occupied Bandwidth was measured with a occupied bandwidth function of the analyzer.

The near the carrier emissions are measured by normal power measurement function of the analyzer.

8.2 Test Results

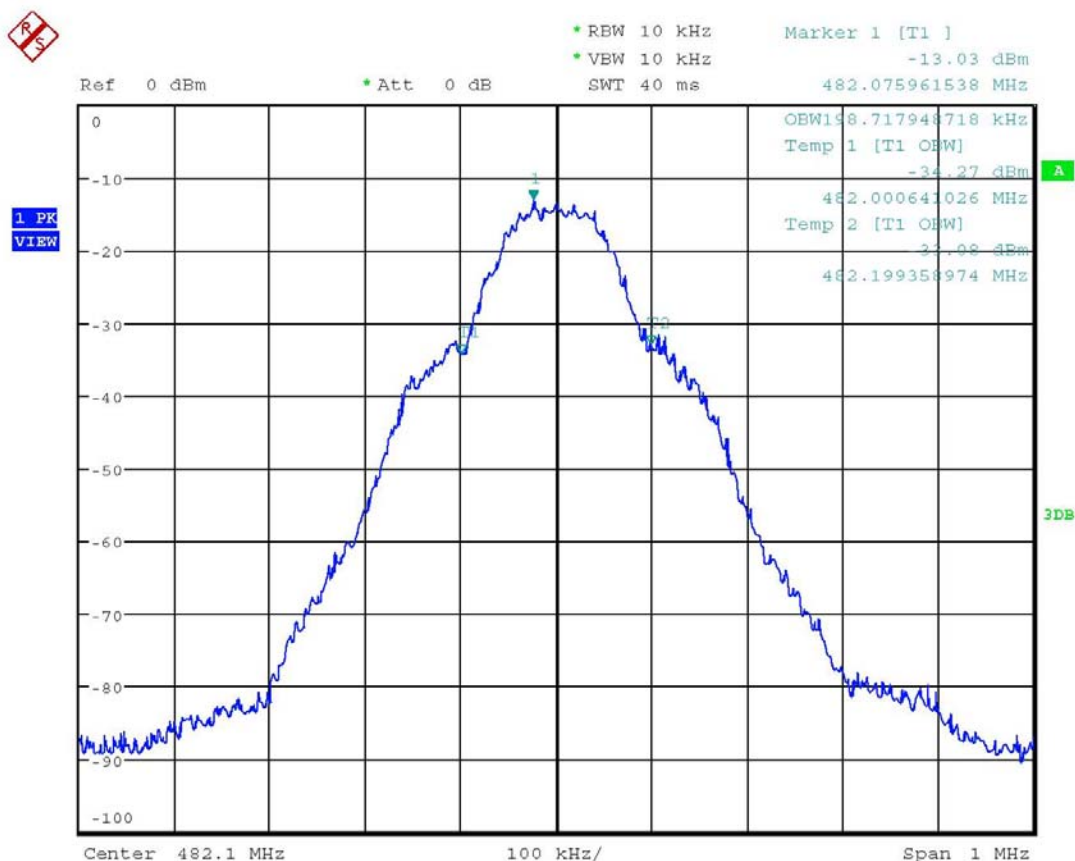

OCCUPIED BANDWIDTH 482.1MHz

Date: 13.OCT.2011 05:39:03

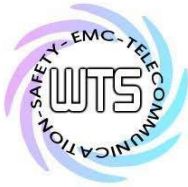

Worldwide Testing Services(Taiwan) Co., Ltd.

Registration number: W6M21108-11777-C-1

FCC ID: M5X-ACT8HA

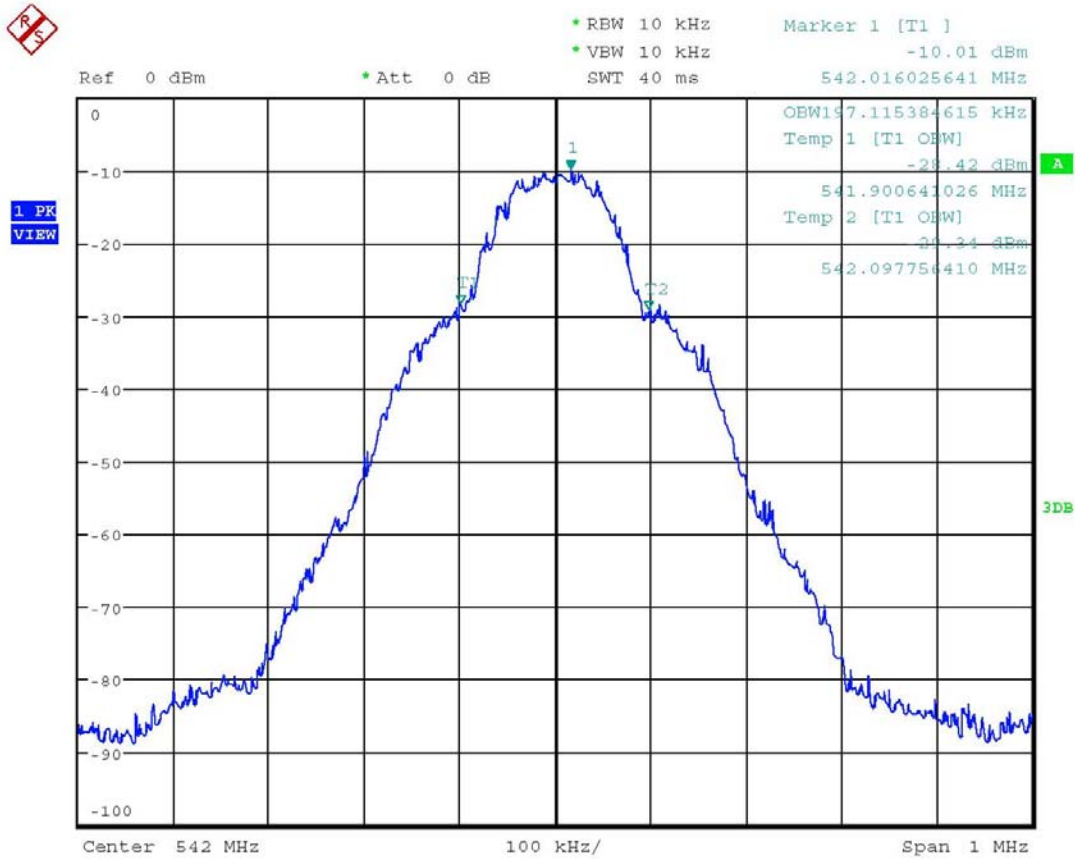

OCCUPIED BANDWIDTH 542MHz
Date: 12.OCT.2011 14:02:11

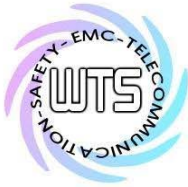

Registration number: W6M21108-11777-C-1

FCC ID: M5X-ACT8HA

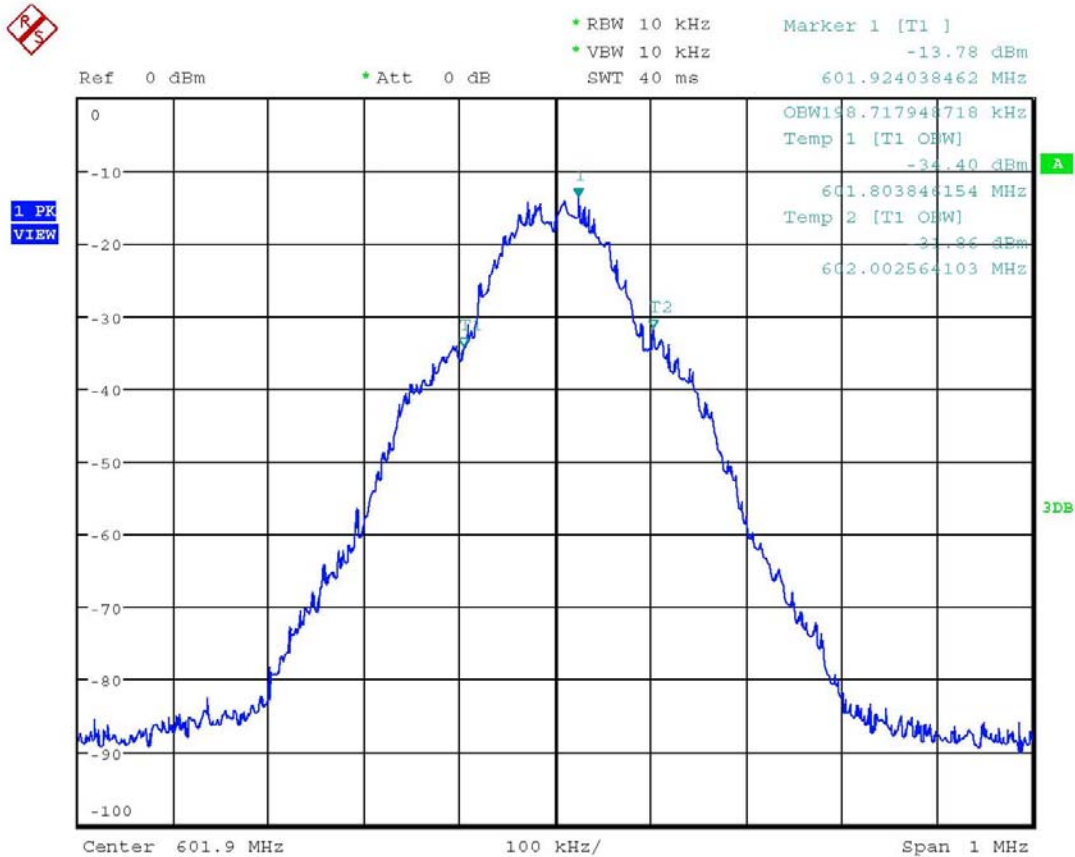

OCCUPIED BANDWIDTH 601.9MHz

Date: 13.OCT.2011 05:41:34

8.3 Limit

The operating bandwidth shall not exceed 200 kHz.

Test equipment used: ETSTW-RE 055



Registration number: W6M21108-11777-C-1

FCC ID: M5X-ACT8HA

9 Spurious Emissions at Antenna Terminals FCC2.1051 ; 74.861 (e)

9.1 Test procedure

This transmitter output was connected to a calibrated coaxial attenuator, the other end of which was connected to a spectrum analyzer. Transmitter output was derived with the spectrum analyzer in dBm.

The Spurious Emissions at Antenna Terminals was measured by the spectrum analyzer with a suitable notch filter and high-pass filter.

Tests were performed with an un-modulated carrier at three frequencies (low , middle and high channels) and on all power levels , which can be set-up on the transmitters.

9.2 Test Results

Summary table with conducted data of the test plots for Carrier Test Frequency

Frequency Marker Indication [MHz]	Indication Power Level [dBm]	Compliance Limit [dBm]	Margin
--	--	--	--
--	--	--	--

9.3 Limit

Compliance with § 74.861 requires that any emission be attenuated below the transmitter power at least $43 + 10 \log_{10} P$ (P = transmitter power in Watts).

The compliance limit was calculated as an example per the following table :

Maximum transmitter output power	16.69 dBm
Required attenuation	$43 + 10 \log_{10} 0.04667W = 29.69 \text{ dB}$
Maximum transmitter output power <u>Required attenuation</u>	16.69 dBm <u>29.69 dB</u>
Compliance limit	-13 dBm

Test equipment used: ETSTW-RE 055

Explanation : This test is not applicable.



Registration number: W6M21108-11777-C-1

FCC ID: M5X-ACT8HA

10 Radiated Spurious Emission , FCC 2.1053 ; 74.861 (e)

10.1 Test procedure

The EUT was positioned on a non-conductive turntable , 0.8m above the ground plane.

The radiated emission at the fundamental frequency was measured at 3 m distance with a test antenna and spectrum analyzer.

Worst case emission was recorded with the rotation of the turntable and the raising and lowering of the test antenna.

ERP was measured using a substitution method. The EUT was replaced by reference antenna connected to a signal generator.

The test of spurious radiated emission have been carried out with the ESK-Software from Rode & Schwarz. The measurements below 1GHz were performed with a measurement bandwidth of 100kHz, above 1GHz with a bandwidth of 1 MHz.

Spurious emission limits near the carrier are defined by a emission mask. This measurements are done in conducted mode.

10.2 Test Results

The measurements of the spurious emission at the upper , center and lower channel.

The measurement diagrams show that all significant spurs are well below the limit line.

Model: ACT-8Ha Date: 2011/8/31
 Mode: 482.1 MHz Temperature: 24 °C Engineer: Robert
 Polarization: Horizontal Humidity: 60 %

Frequency (MHz)	Reading (dBm) Peak	Factor (dB) Corr.	Result (dBm)	Limit (dBm)	Margin (dB)	Table Degree (Deg.)	Ant. High (cm)
79.5833	-94.53	22.04	-72.49	-13.00	-59.49	200	150
702.5641	-98.99	34.44	-64.55	-13.00	-51.55	160	150
1446.3000	-61.97	2.94	-59.03	-13.00	-46.03	230	150
1928.4000	-62.26	3.29	-58.97	-13.00	-45.97	250	150
2410.5000	-62.48	6.71	-55.77	-13.00	-42.77	140	150
2892.6000	-61.02	7.11	-53.91	-13.00	-40.91	200	150

Polarization: Vertical

Frequency (MHz)	Reading (dBm) Peak	Factor (dB) Corr.	Result (dBm)	Limit (dBm)	Margin (dB)	Table Degree (Deg.)	Ant. High (cm)
88.3013	-86.40	21.43	-64.97	-13.00	-51.97	110	150
592.3076	-88.03	31.90	-56.13	-13.00	-43.13	200	150
1446.3000	-60.44	2.17	-58.27	-13.00	-45.27	100	150
1928.4000	-61.73	5.19	-56.54	-13.00	-43.54	200	150
2410.5000	-61.49	8.84	-52.65	-13.00	-39.65	140	150
2892.6000	-62.48	8.05	-54.43	-13.00	-41.43	260	150



Worldwide Testing Services(Taiwan) Co., Ltd.

Registration number: W6M21108-11777-C-1

FCC ID: M5X-ACT8HA

Mode: 542 MHz

Polarization: Horizontal

Frequency (MHz)	Reading (dBm) Peak	Factor (dB) Corr.	Result (dBm)	Limit (dBm)	Margin (dB)	Table Degree (Deg.)	Ant. High (cm)
83.9423	-95.95	21.55	-74.40	-13.00	-61.40	130	150
687.1795	-98.70	33.87	-64.83	-13.00	-51.83	100	150
1084.0000	-62.78	6.12	-56.66	-13.00	-43.66	280	150
1626.0000	-62.04	3.69	-58.35	-13.00	-45.35	140	150
2168.0000	-61.85	5.77	-56.08	-13.00	-43.08	130	150
2710.0000	-62.79	11.45	-51.34	-13.00	-38.34	200	150

Polarization: Vertical

Frequency (MHz)	Reading (dBm) Peak	Factor (dB) Corr.	Result (dBm)	Limit (dBm)	Margin (dB)	Table Degree (Deg.)	Ant. High (cm)
85.5770	-88.33	21.64	-66.69	-13.00	-53.69	140	150
592.3076	-87.40	31.90	-55.50	-13.00	-42.50	170	150
1081.7310	-58.28	3.72	-54.56	-13.00	-41.56	250	150
1625.0000	-57.37	3.42	-53.95	-13.00	-40.95	140	150
2168.0000	-60.53	6.86	-53.67	-13.00	-40.67	130	150
2711.5390	-58.86	10.00	-48.86	-13.00	-35.86	250	150

Mode: 601.9MHz

Polarization: Horizontal

Frequency (MHz)	Reading (dBm) Peak	Factor (dB) Corr.	Result (dBm)	Limit (dBm)	Margin (dB)	Table Degree (Deg.)	Ant. High (cm)
80.4006	-95.02	22.04	-72.98	-13.00	-59.98	200	150
535.8973	-96.47	29.20	-67.27	-13.00	-54.27	200	150
1203.8000	-62.78	1.54	-61.24	-13.00	-48.24	140	150
1805.7000	-62.05	2.30	-59.75	-13.00	-46.75	250	150
2407.6000	-62.47	6.70	-55.77	-13.00	-42.77	140	150
3009.5000	-63.26	9.09	-54.17	-13.00	-41.17	200	150

Polarization: Vertical

Frequency (MHz)	Reading (dBm) Peak	Factor (dB) Corr.	Result (dBm)	Limit (dBm)	Margin (dB)	Table Degree (Deg.)	Ant. High (cm)
83.9423	-88.52	21.77	-66.75	-13.00	-53.75	200	150
592.3076	-88.50	31.90	-56.60	-13.00	-43.60	200	150
1203.8000	-62.15	1.74	-60.41	-13.00	-47.41	230	150
1805.7000	-62.21	2.94	-59.27	-13.00	-46.27	290	150
2407.6000	-61.41	8.93	-52.48	-13.00	-39.48	140	150
3009.5000	-60.50	8.41	-52.09	-13.00	-39.09	200	150

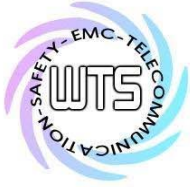

Registration number: W6M21108-11777-C-1
FCC ID: M5X-ACT8HA

- Note:**
1. Correction Factor = Antenna Gain + Cable Loss + Amplifier Gain
 2. The formula of measured value as: Test Result = Reading + Correction Factor
 3. Detector function in the form : PK = Peak, AV = Average
 4. All not in the table noted test results are more than 20 dB below the relevant limits.
 5. See the attached diagram as appendix.

10.3 Explanation of test result

The measurements of the spurious emissions at the equipment output terminals were performed pursuant to the test procedure above in order to verify that any emissions are below the limits given by § 74.861 (6).

Calculation of test results :

Such factors like antenna correction , cable loss , external attenuation etc. are already included in the provided measurement results. This is done by using validated test software and calibrated test system according the accreditation requirements.

In the Table being listed the critical peak and average value an exhibit the compliance with the above calculated Limits.

10.4 Limits

Compliance with § 74.861 requires that any emission be attenuated below the transmitter power at least $43 + 10 \log_{10} P$ (P = transmitter power in Watts).

The compliance limit was calculated as an example per the following table :

Maximum transmitter output power	16.69 dBm
Required attenuation	$43 + 10 \log_{10} 0.04667W = 29.69 \text{ dB}$
Maximum transmitter output power	16.69 dBm
<u>Required attenuation</u>	<u>29.69 dB</u>
Compliance limit	-13 dBm

Test equipment used: ETSTW-RE 003, ETSTW-RE 004, ETSTW-RE 021, ETSTW-RE 042, ETSTW-RE 043, ETSTW-RE 030, ETSTW-RE 044

Explanation : See attached diagrams in appendix.



Registration number: W6M21108-11777-C-1

FCC ID: M5X-ACT8HA

11 Line Conducted Emission , FCC 15.207

11.1 Test procedure

For an intentional radiator which is designed to be connected to the public utility (AC) power line, the radio frequency voltage that is conducted back onto the AC line on any frequency or frequencies within the band 150 kHz to 30 MHz shall not exceed the limits in the table bellows with this provision shall be based on the measurement of the radio frequency voltage between each power line and ground at the power terminals.

This measurement was transact first with instrumentation using an average and peak detector and a 10 kHz bandwidth. If the peak detector achieves a calculated level, the measurement is repeated by an instrumentation using a quasi-peak detector.

11.2 Test Results

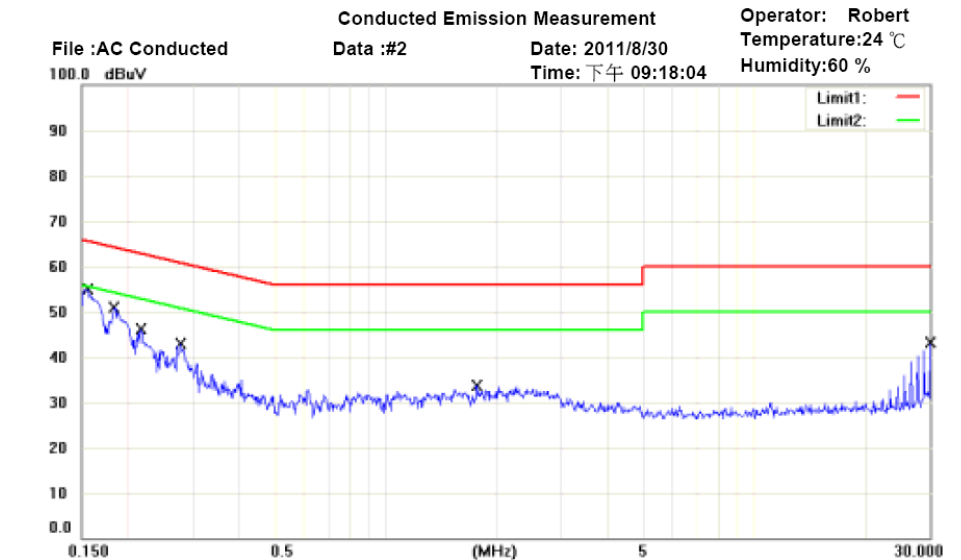

Site : Chamber_03

Condition : FCC Part 15 Class B Conduction (QP)

EUT : W6M21108-11777

M/N: ACT-8Ha

Test Mode :

Note :

Phase: N

Power : 110V

Mk.	Frequency (MHz)	Reading (dBuV)	Detector	Corrected factor(dB)	Result (dBuV)	Limit (dBuV)	Margin (dB)	Comment
*	0.1553	42.22	QP	9.93	52.15	65.71	-13.56	
	0.1553	23.70	AVG	9.93	33.63	55.71	-22.08	
	0.1831	38.88	QP	9.91	48.79	64.34	-15.55	
	0.1831	19.27	AVG	9.91	29.18	54.34	-25.16	
	0.2170	31.42	QP	9.89	41.31	62.93	-21.62	
	0.2170	14.61	AVG	9.89	24.50	52.93	-28.43	
	0.2774	28.73	QP	9.91	38.64	60.89	-22.25	
	0.2774	15.67	AVG	9.91	25.58	50.89	-25.31	
	1.7645	9.03	QP	9.99	19.02	56.00	-36.98	
	1.7645	-0.42	AVG	9.99	9.57	46.00	-36.43	
	30.0000	11.74	QP	11.40	23.14	60.00	-36.86	
	30.0000	4.88	AVG	11.40	16.28	50.00	-33.72	

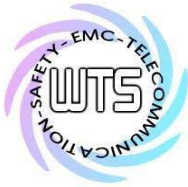

Worldwide Testing Services(Taiwan) Co., Ltd.

Registration number: W6M21108-11777-C-1
 FCC ID: M5X-ACT8HA

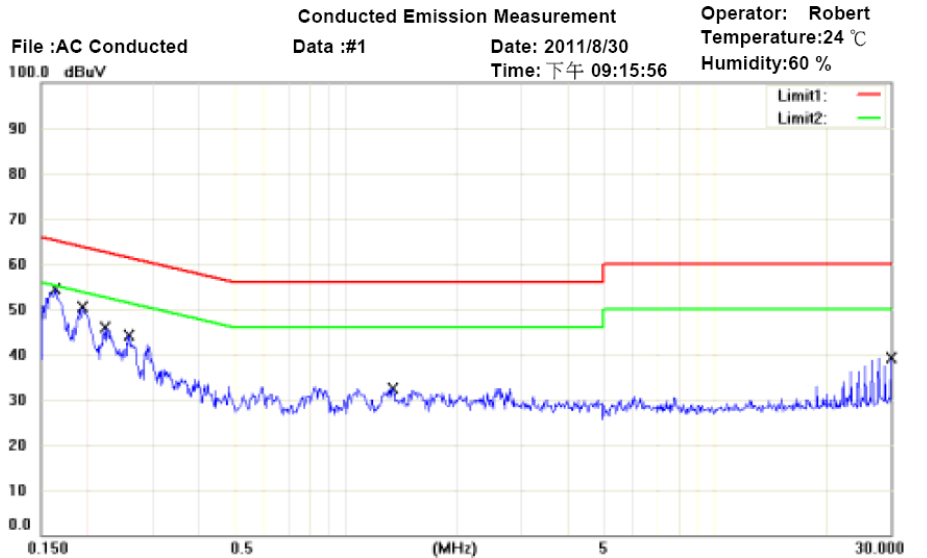

Site : Chamber_03
 Condition : FCC Part 15 Class B Conduction (QP) Phase: L1
 EUT : W6M21108-11777 Power : 110V
 M/N : ACT-8Ha
 Test Mode :
 Note :

Mk.	Frequency (MHz)	Reading (dBuV)	Detector	Corrected factor(dB)	Result (dBuV)	Limit (dBuV)	Margin (dB)	Comment
*	0.1626	42.41	QP	9.98	52.39	65.33	-12.94	
	0.1626	26.94	AVG	9.98	36.92	55.33	-18.41	
	0.1935	38.00	QP	9.95	47.95	63.88	-15.93	
	0.1935	22.44	AVG	9.95	32.39	53.88	-21.49	
	0.2230	31.86	QP	9.95	41.81	62.71	-20.90	
	0.2230	14.59	AVG	9.95	24.54	52.71	-28.17	
	0.2581	29.03	QP	9.96	38.99	61.49	-22.50	
	0.2581	17.41	AVG	9.96	27.37	51.49	-24.12	
	1.3393	17.10	QP	10.04	27.14	56.00	-28.86	
	1.3393	6.93	AVG	10.04	16.97	46.00	-29.03	
	30.0000	7.10	QP	11.62	18.72	60.00	-41.28	
	30.0000	0.99	AVG	11.62	12.61	50.00	-37.39	

- Note**
1. The formula of measured value as: Test Result = Reading + Correction Factor
 2. The Correction Factor = Cable Loss + LISN Insertion Loss + Pulse Limit Loss
 3. Detector function in the form : PK = Peak, QP = Quasi Peak, AV = Average
 4. All not in the table noted test results are more than 20 dB below the relevant limits.
 5. Measurement uncertainty = ±1.30dB; Reported uncertainties represent expanded uncertainties expressed at approximately the 95% confidence level using a coverage factor of k = 2.
 6. Up Line: QP Limit Line, Down Line: Ave Limit Line.

Limits:

Frequency of Emission (MHz)	Conducted Limit (dBuV)	
	Quasi Peak	Average
0.15-0.5	66 to 56	56 to 46
0.5-5	56	46
5-30	60	50

Test equipment used: ETSTW-CE 001, ETSTW-CE 004, ETSTW-CE 006



Registration number: W6M21108-11777-C-1

FCC ID: M5X-ACT8HA

12 Frequency Stability vs. Temperature , FCC 2.1055 , 74.861 (e)

12.1 Test procedure

The equipment under test was connected to an external DC power supply and the RF output was connected to a frequency counter via feed through attenuators. The EUT was placed inside the temperature chamber. The DC leads and RF output cable, exited the chamber through an opening made for that purpose.

After the temperature stabilized the frequency output was recorded from the counter.

12.2 Test Results

482.1 MHz

°C	Frequency Error (kHz)	Frequency Error (ppm)
-30	-7.258	-15.056
-20	-5.848	-12.131
-10	5.161	10.706
0	5.161	10.706
10	0.754	1.565
20	-0.448	-0.928
30	-2.050	-4.253
40	-2.050	-4.253
50	-1.249	-2.590

25°C: 482.098845 MHz

Limit: 24.105 kHz(±0.005%)

542 MHz

°C	Frequency Error (kHz)	Frequency Error (ppm)
-30	2.997	5.529
-20	2.808	5.180
-10	1.587	2.927
0	2.003	3.696
10	2.104	3.882
20	-0.980	-1.809
30	-2.599	-4.796
40	-2.441	-4.503
50	-2.120	-3.912

25°C: 542 MHz

Limit: 27.1 kHz(±0.005%)



Worldwide Testing Services(Taiwan) Co., Ltd.

Registration number: W6M21108-11777-C-1

FCC ID: M5X-ACT8HA

601.9 MHz

°C	Frequency Error (kHz)	Frequency Error (ppm)
-30	-3.771	-6.265
-20	-3.088	-5.130
-10	-2.715	-4.511
0	-1.342	-2.230
10	-1.342	-2.230
20	-0.823	-1.367
30	0.205	0.341
40	0.912	1.515
50	1.404	2.333

25°C: 697.901666 MHz

Limit: 30.095 kHz(±0.005%)

Test equipment used: ETSTW-RE 055, ETSTW-CE 009

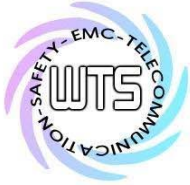

Registration number: W6M21108-11777-C-1

FCC ID: M5X-ACT8HA

13 Frequency Stability vs. Voltage , FCC 2.1055 (d) ; 74.861 (e)

13.1 Test procedure

An external variable DC power supply was connected to the battery terminals of the equipment under test.

For hand carried , battery powered equipment primary supply voltage was reduced to the battery operating end point as specified by the manufacturer. The output frequency was recorded for each battery voltage.

13.2 Test Results

Test voltage: 6.29 VDC

Frequency in Normal Condition (MHz)	Frequency in battery operating end point (MHz)	Frequency Error (kHz)	Frequency Error (ppm)
482.098845	482.098812	-0.033	-0.068
542.000000	542.001026	1.026	1.892
601.900342	601.898450	-1.892	-3.143

Limit : $\pm 0.005\%$

Test equipment used: ETSTW-RE 055

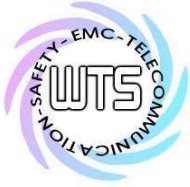

Appendix

A. Measurement diagrams

1. Emission Mask
2. Radiation Spurious Emission

B. Photos

1. External Photos
2. Internal Photos
3. Set Up Photo of Radiated Emission
4. Set Up Photo of Conducted Emission



Worldwide Testing Services(Taiwan) Co., Ltd.

Registration number: W6M21108-11777-C-1

FCC ID: M5X-ACT8HA

Emission Mask

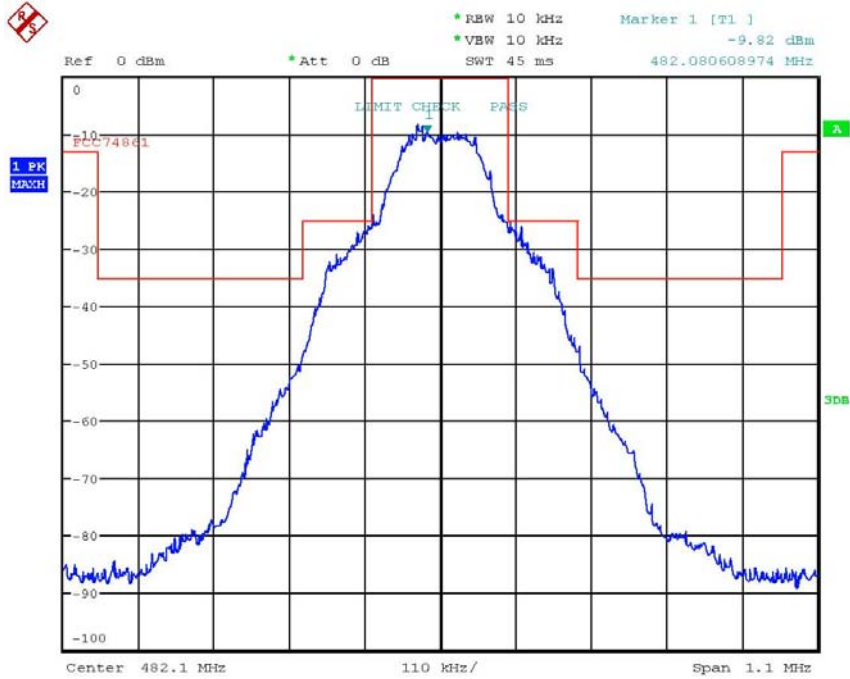

EMISSION MASK 482.1MHz
Date: 1.SEP.2011 10:27:46

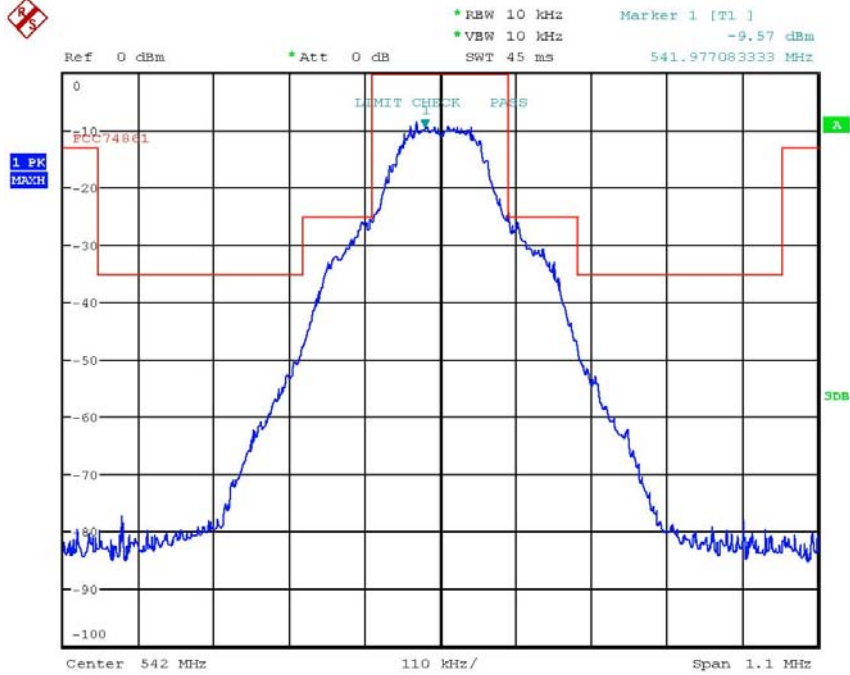

EMISSION MASK 542MHz
Date: 1.SEP.2011 10:23:55



Worldwide Testing Services(Taiwan) Co., Ltd.

Registration number: W6M21108-11777-C-1

FCC ID: M5X-ACT8HA

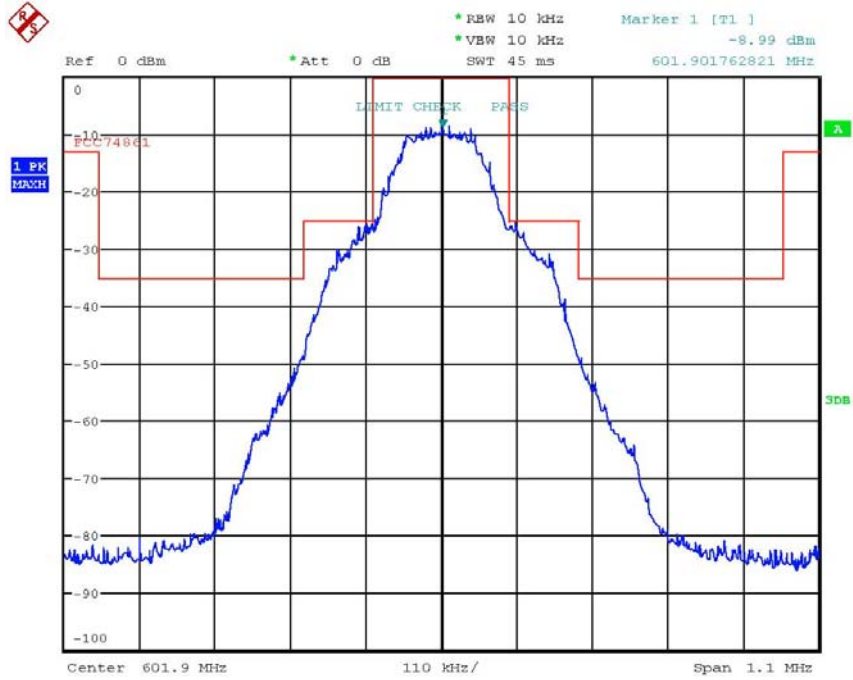

EMISSION MASK 601.9MHz

Date: 1.SEP.2011 10:19:42

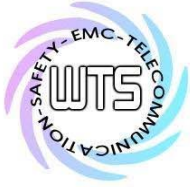

Registration number: W6M21108-11777-C-1

FCC ID: M5X-ACT8HA

Radiation Spurious Emission

482.1 MHz

Antenna Polarization H

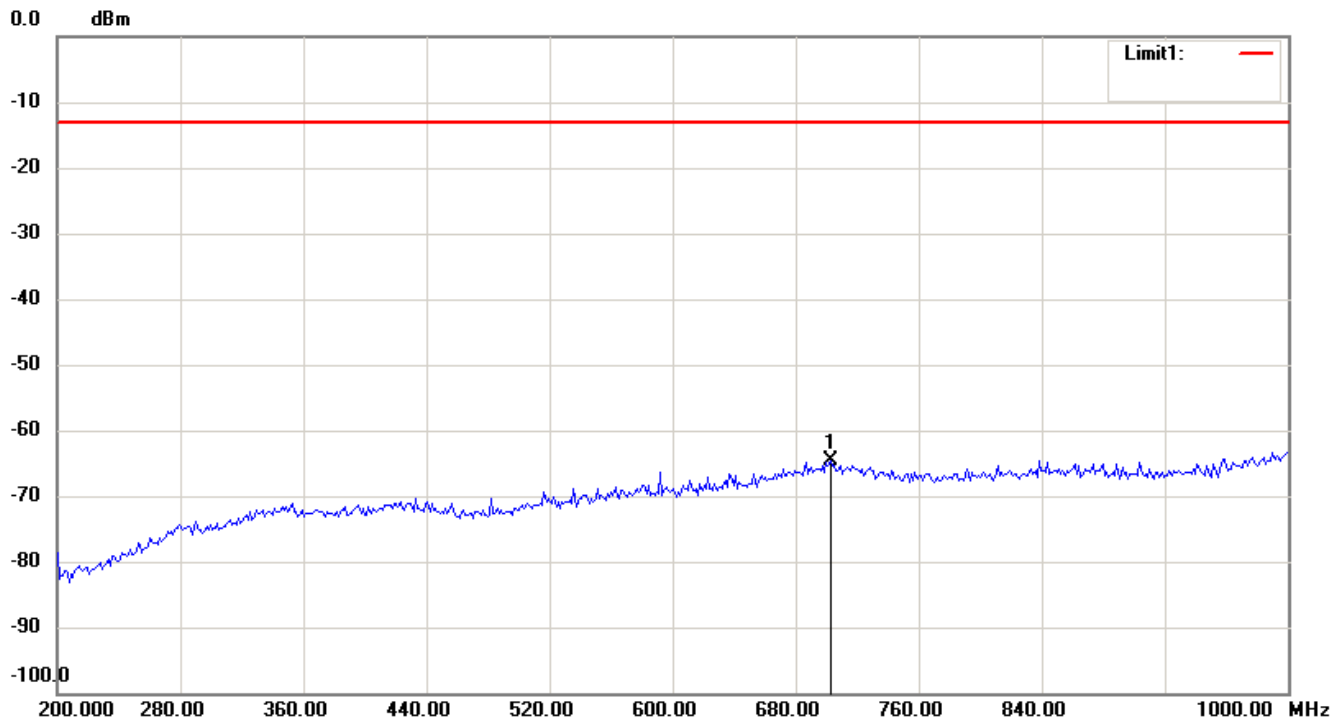
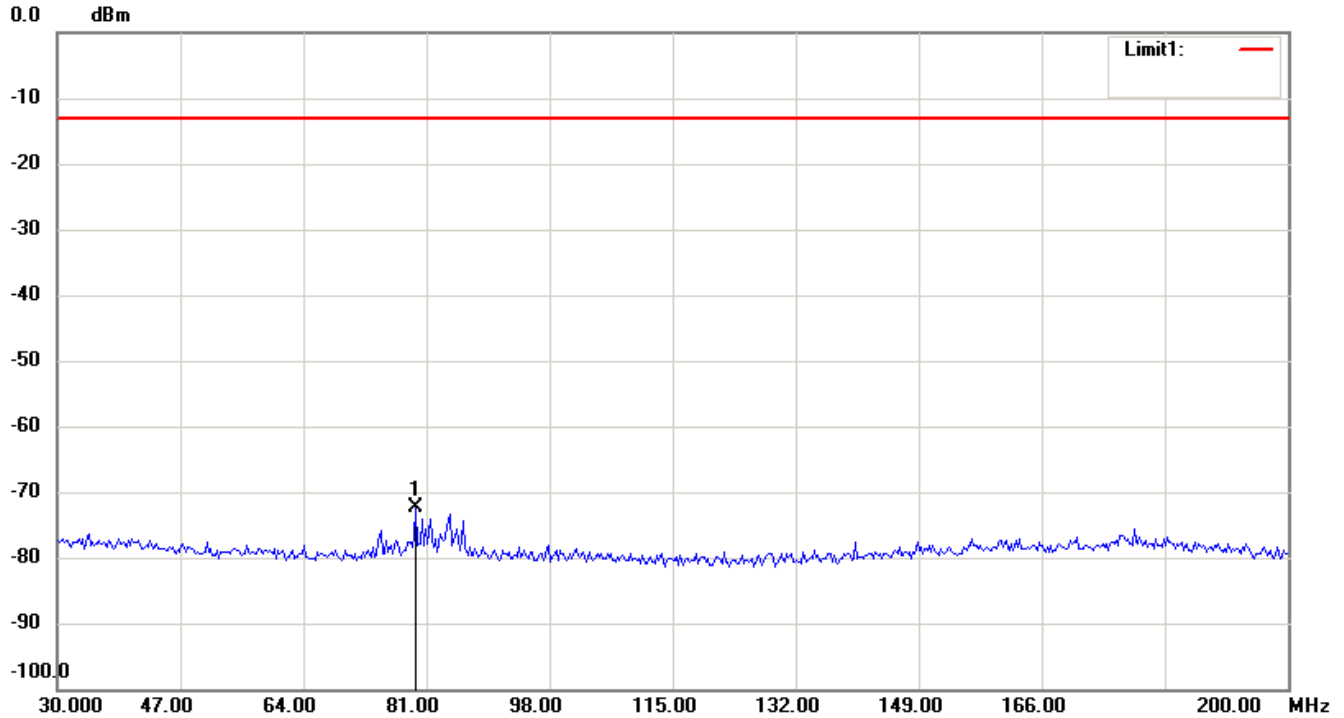

Note:

1. The attached measurement plots are preliminarily pre-scanned with peak detector for determining the final checking frequencies and are for reference only.
2. The some frequencies may exceed the limit line without the specified detectors, but that cannot present the results are failed to the specification of test standard.
3. For corrected test results are listed in the relevant table of radiated test data of this test report.



Worldwide Testing Services(Taiwan) Co., Ltd.

Registration number: W6M21108-11777-C-1

FCC ID: M5X-ACT8HA

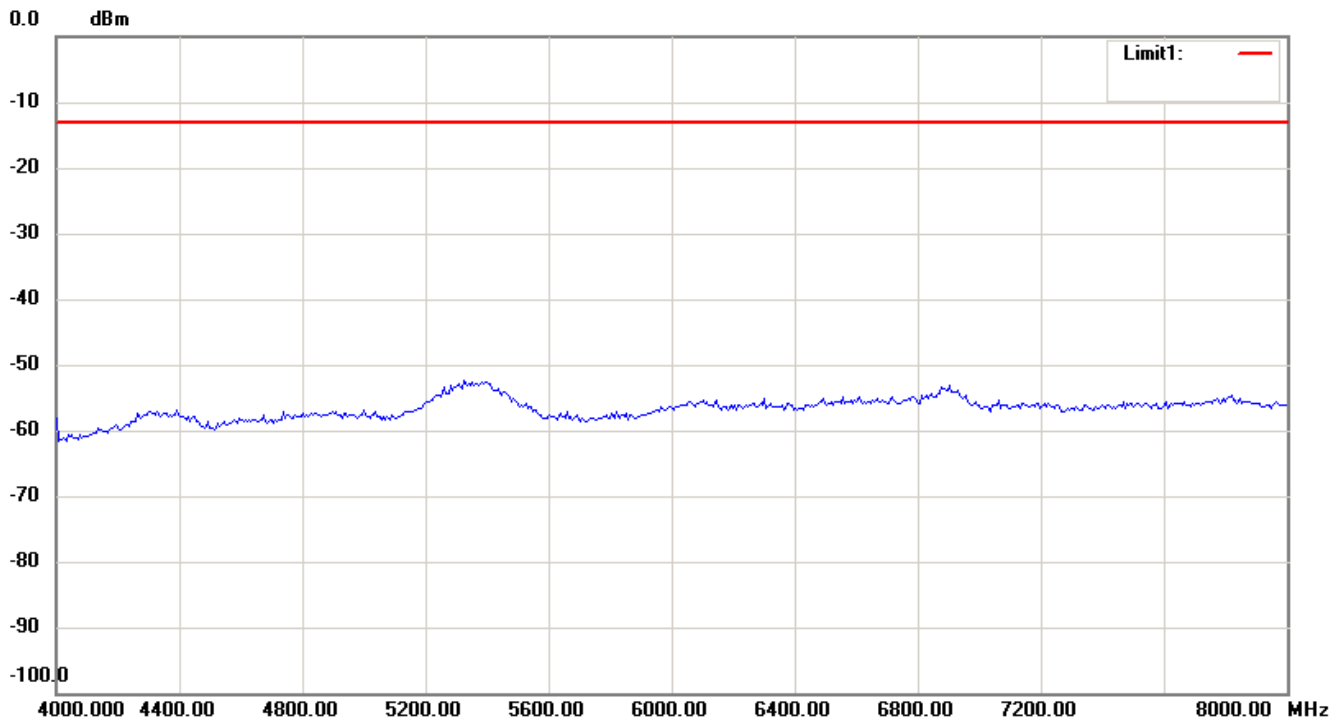
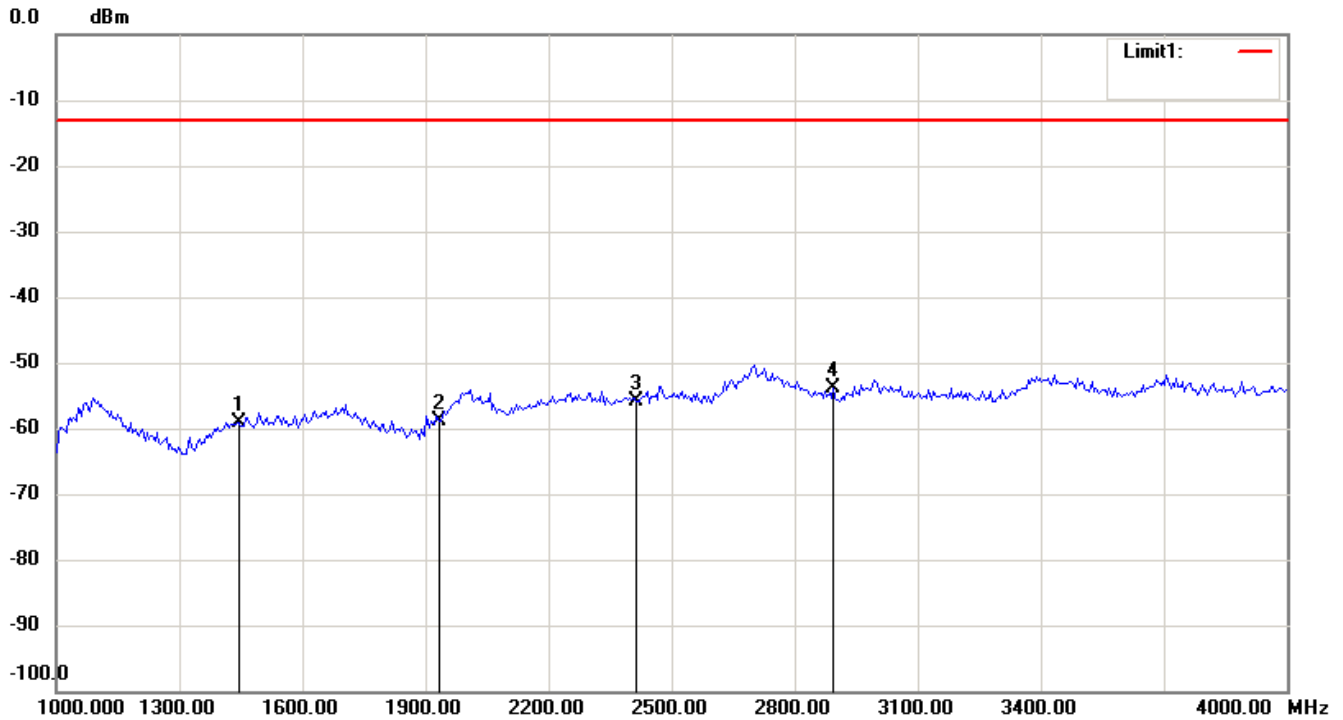

Note:

1. The attached measurement plots are preliminarily pre-scanned with peak detector for determining the final checking frequencies and are for reference only.
2. The some frequencies may exceed the limit line without the specified detectors, but that cannot present the results are failed to the specification of test standard.
3. For corrected test results are listed in the relevant table of radiated test data of this test report.



Registration number: W6M21108-11777-C-1

FCC ID: M5X-ACT8HA

Antenna Polarization V

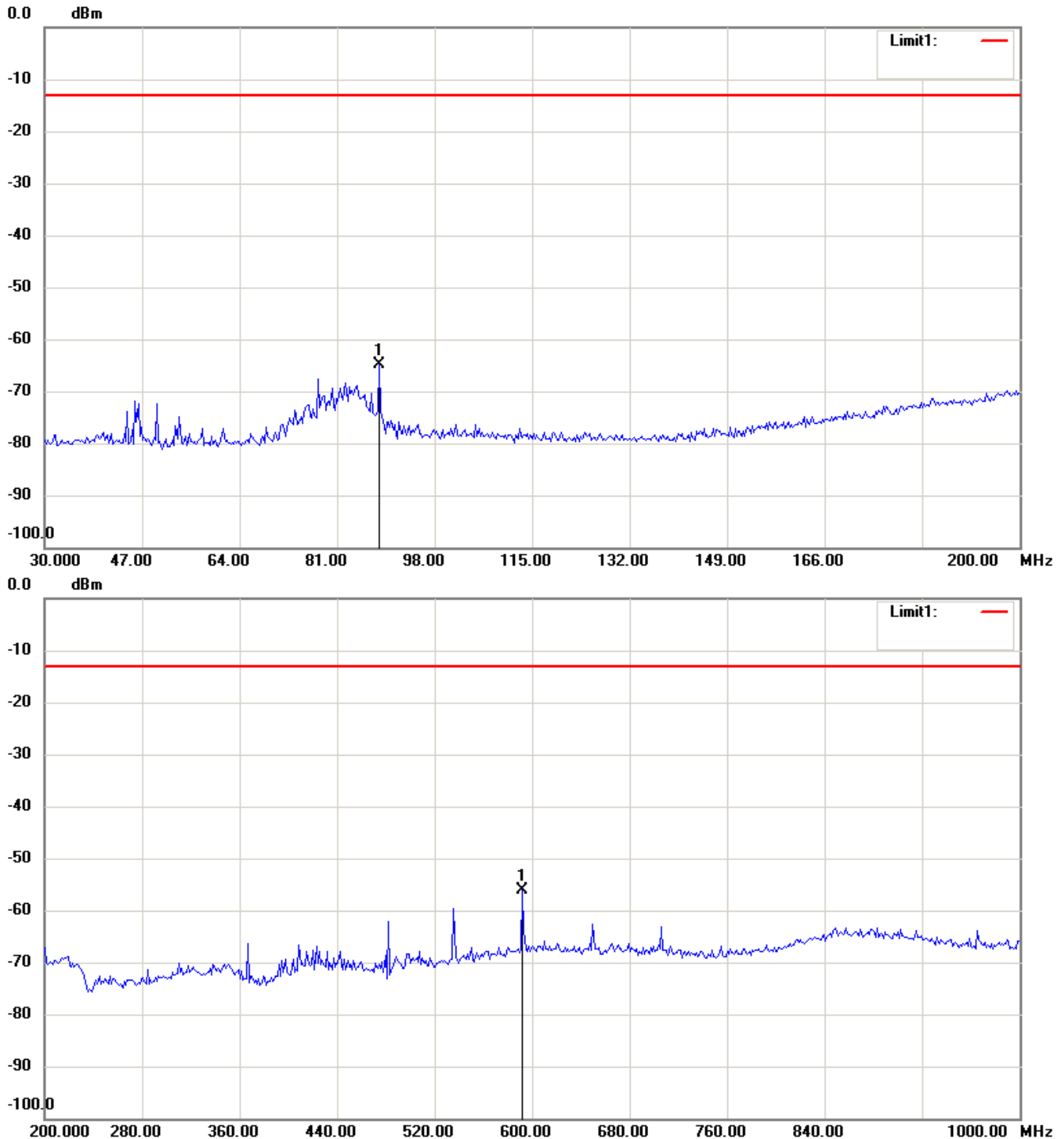

Note:

1. The attached measurement plots are preliminarily pre-scanned with peak detector for determining the final checking frequencies and are for reference only.
2. The some frequencies may exceed the limit line without the specified detectors, but that cannot present the results are failed to the specification of test standard.
3. For corrected test results are listed in the relevant table of radiated test data of this test report.



Worldwide Testing Services(Taiwan) Co., Ltd.

Registration number: W6M21108-11777-C-1

FCC ID: M5X-ACT8HA

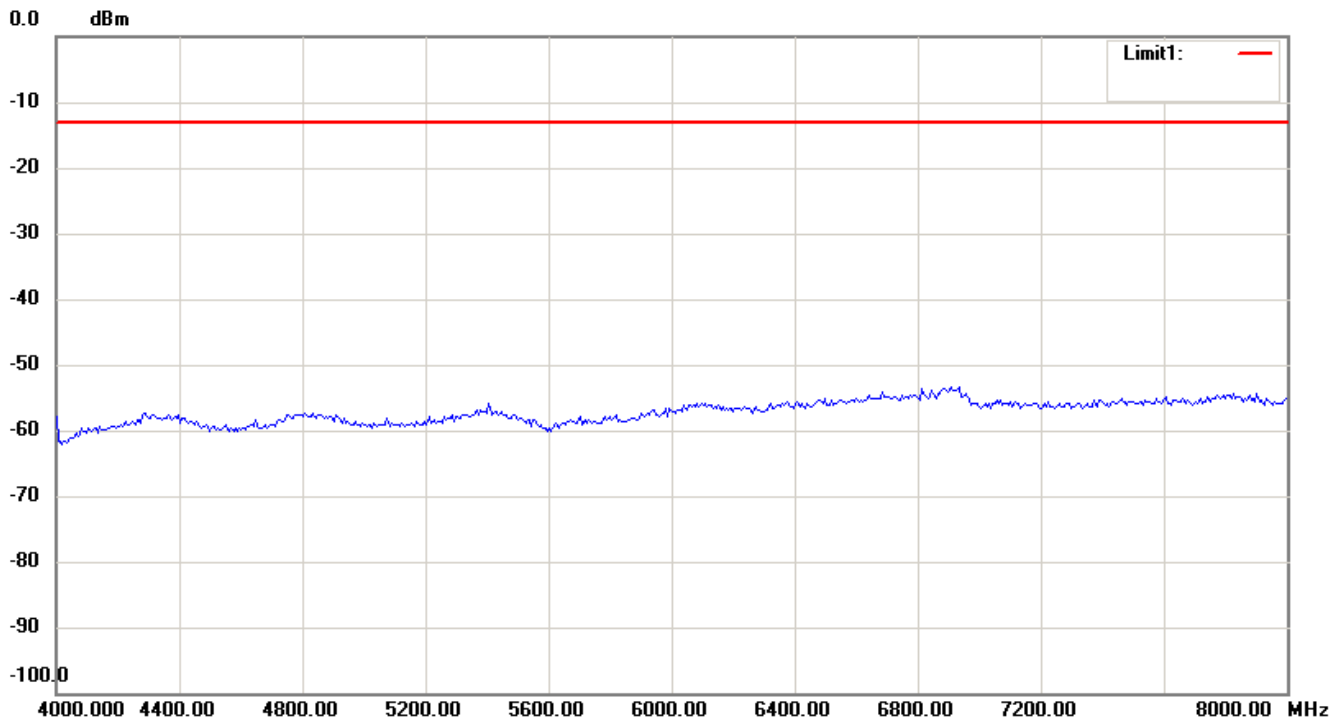
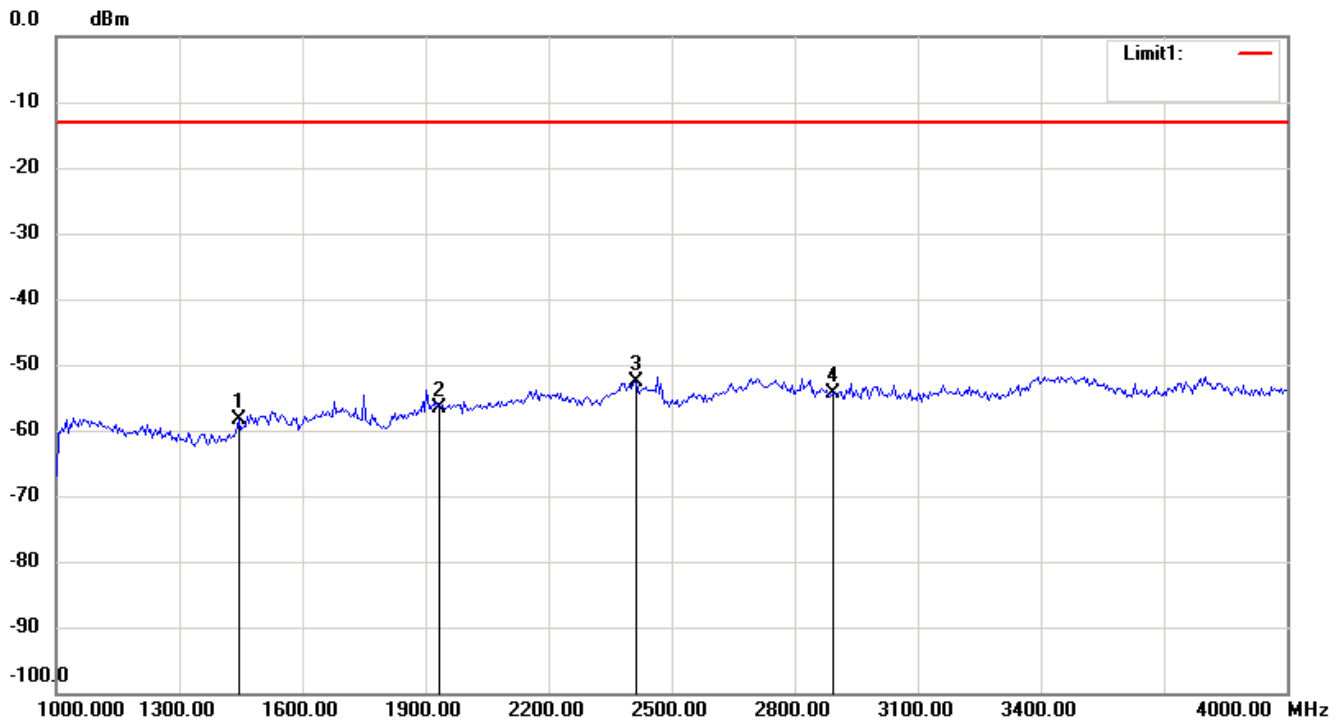

Note:

1. The attached measurement plots are preliminarily pre-scanned with peak detector for determining the final checking frequencies and are for reference only.
2. The some frequencies may exceed the limit line without the specified detectors, but that cannot present the results are failed to the specification of test standard.
3. For corrected test results are listed in the relevant table of radiated test data of this test report.

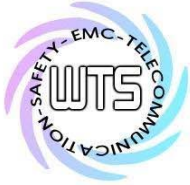

Registration number: W6M21108-11777-C-1

FCC ID: M5X-ACT8HA

542 MHz

Antenna Polarization H

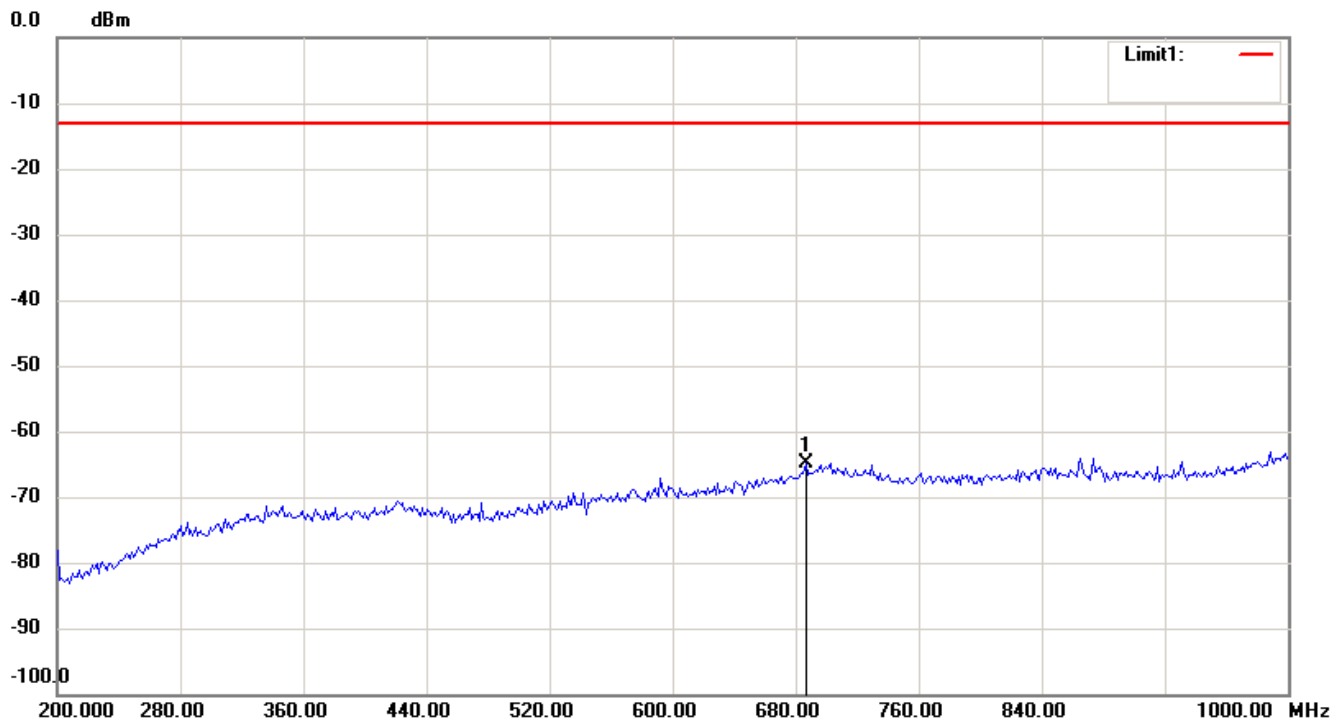
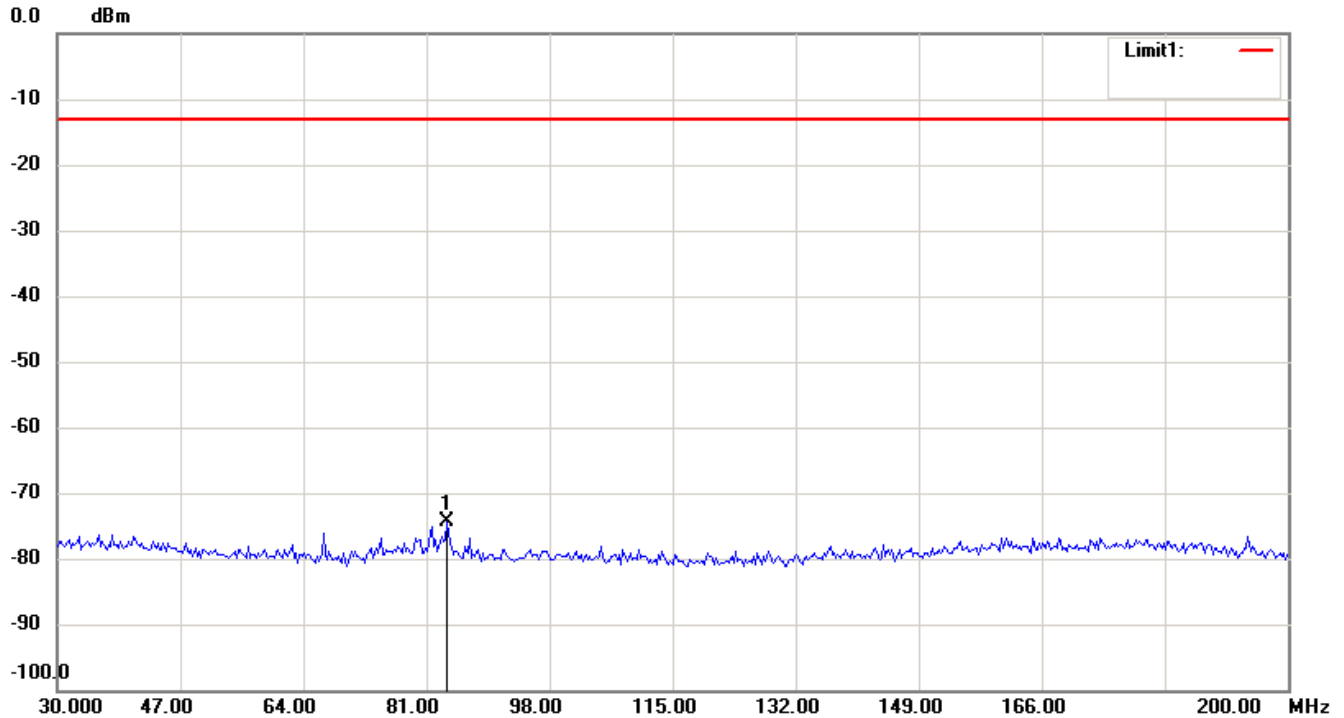

Note:

1. The attached measurement plots are preliminarily pre-scanned with peak detector for determining the final checking frequencies and are for reference only.
2. The some frequencies may exceed the limit line without the specified detectors, but that cannot present the results are failed to the specification of test standard.
3. For corrected test results are listed in the relevant table of radiated test data of this test report.

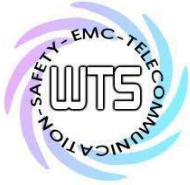

Worldwide Testing Services(Taiwan) Co., Ltd.

Registration number: W6M21108-11777-C-1

FCC ID: M5X-ACT8HA

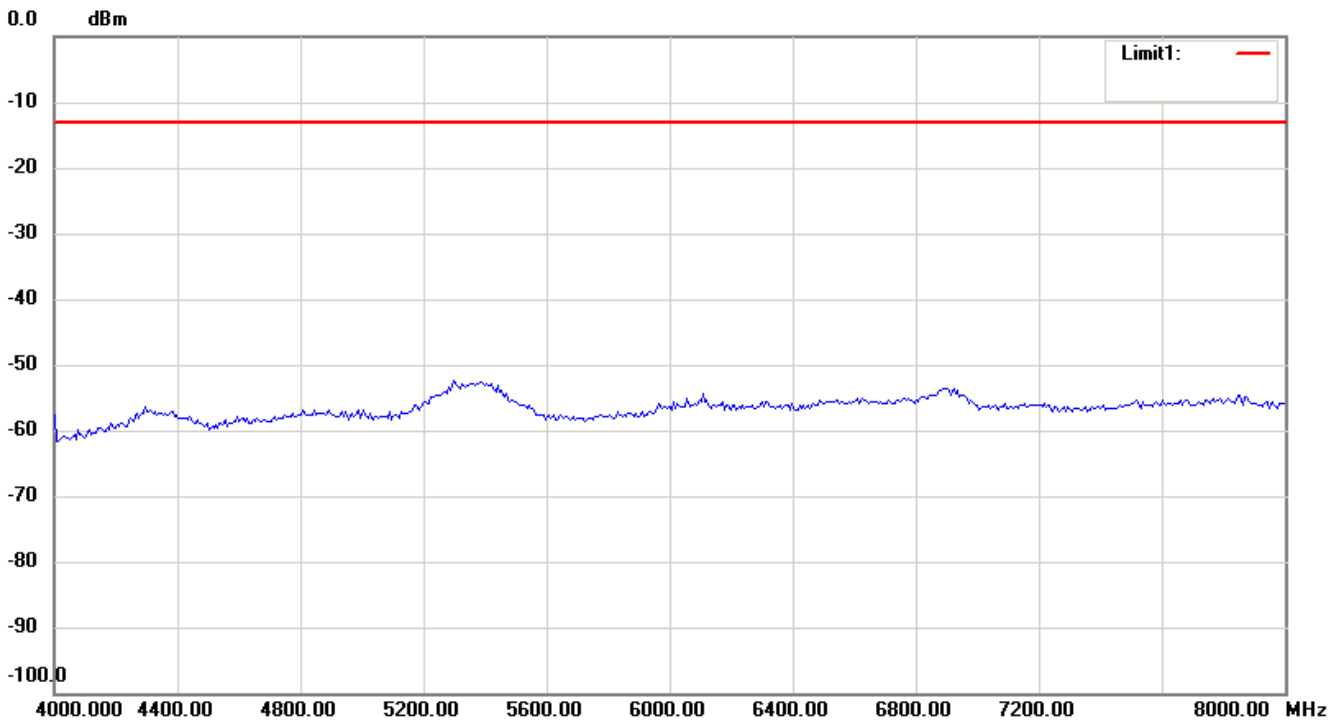
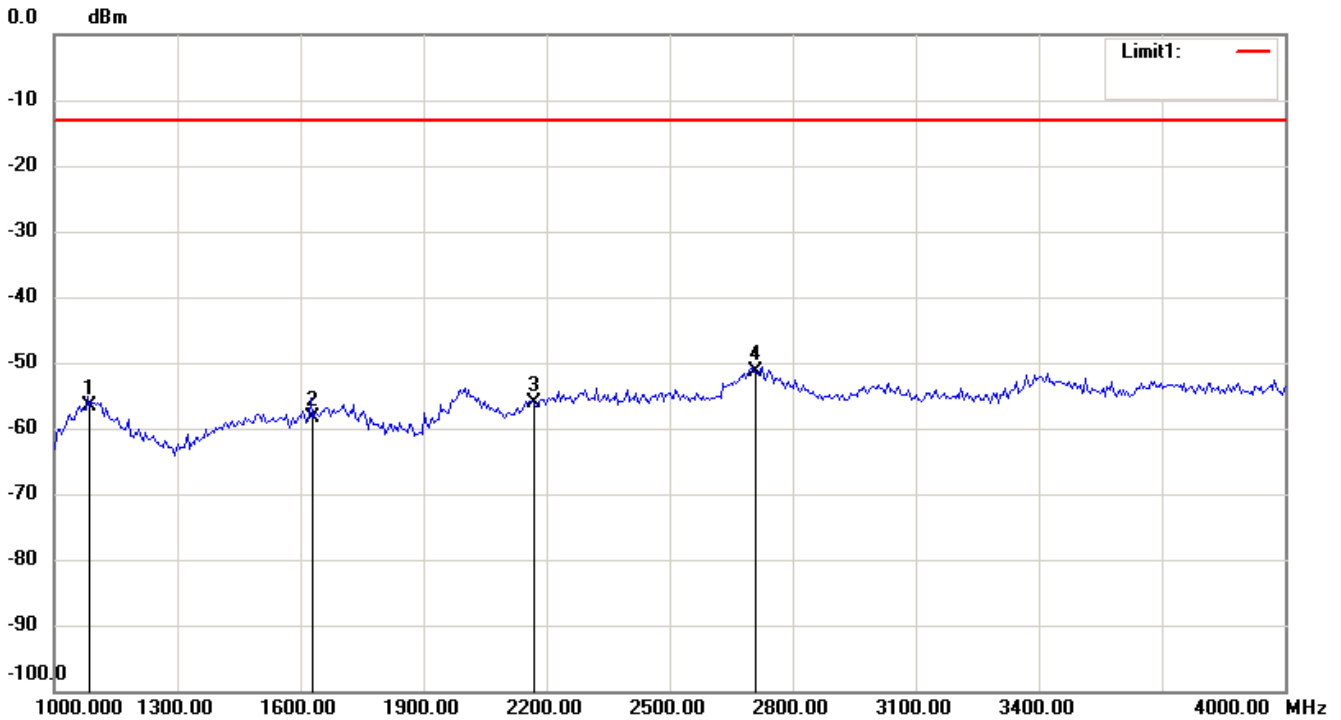

Note:

1. The attached measurement plots are preliminarily pre-scanned with peak detector for determining the final checking frequencies and are for reference only.
2. The some frequencies may exceed the limit line without the specified detectors, but that cannot present the results are failed to the specification of test standard.
3. For corrected test results are listed in the relevant table of radiated test data of this test report.

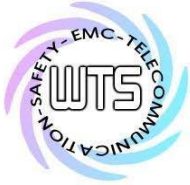

Registration number: W6M21108-11777-C-1

FCC ID: M5X-ACT8HA

Antenna Polarization V

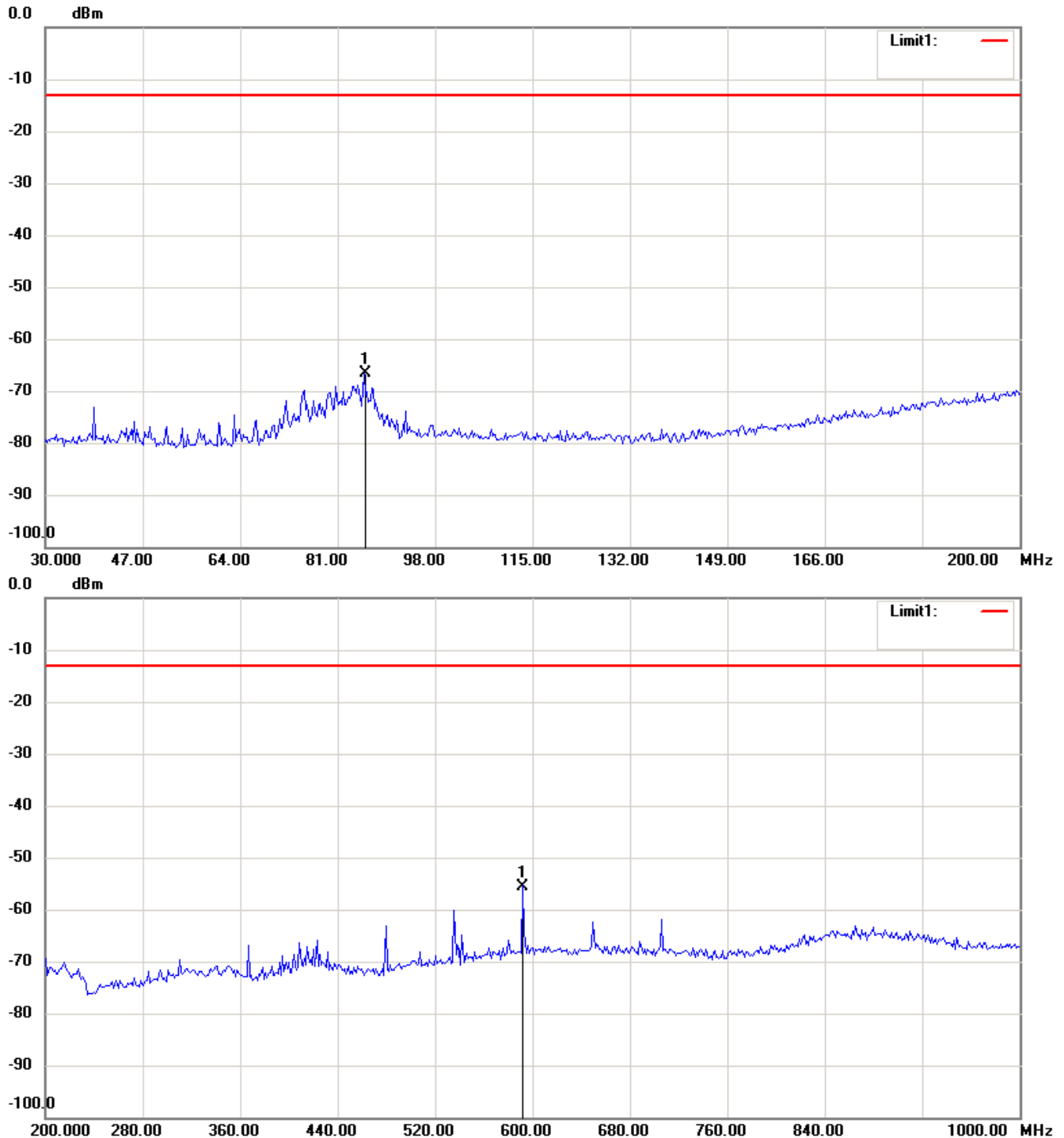

Note:

1. The attached measurement plots are preliminarily pre-scanned with peak detector for determining the final checking frequencies and are for reference only.
2. The some frequencies may exceed the limit line without the specified detectors, but that cannot present the results are failed to the specification of test standard.
3. For corrected test results are listed in the relevant table of radiated test data of this test report.



Registration number: W6M21108-11777-C-1

FCC ID: M5X-ACT8HA

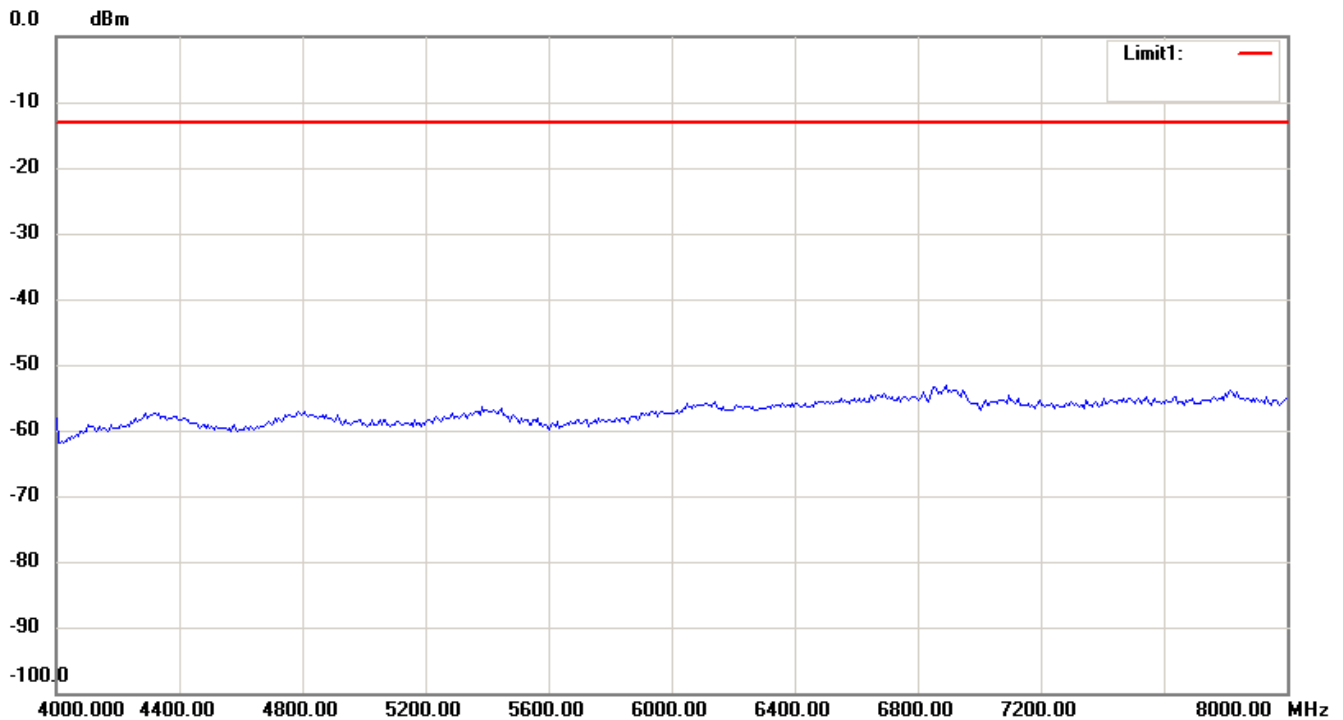
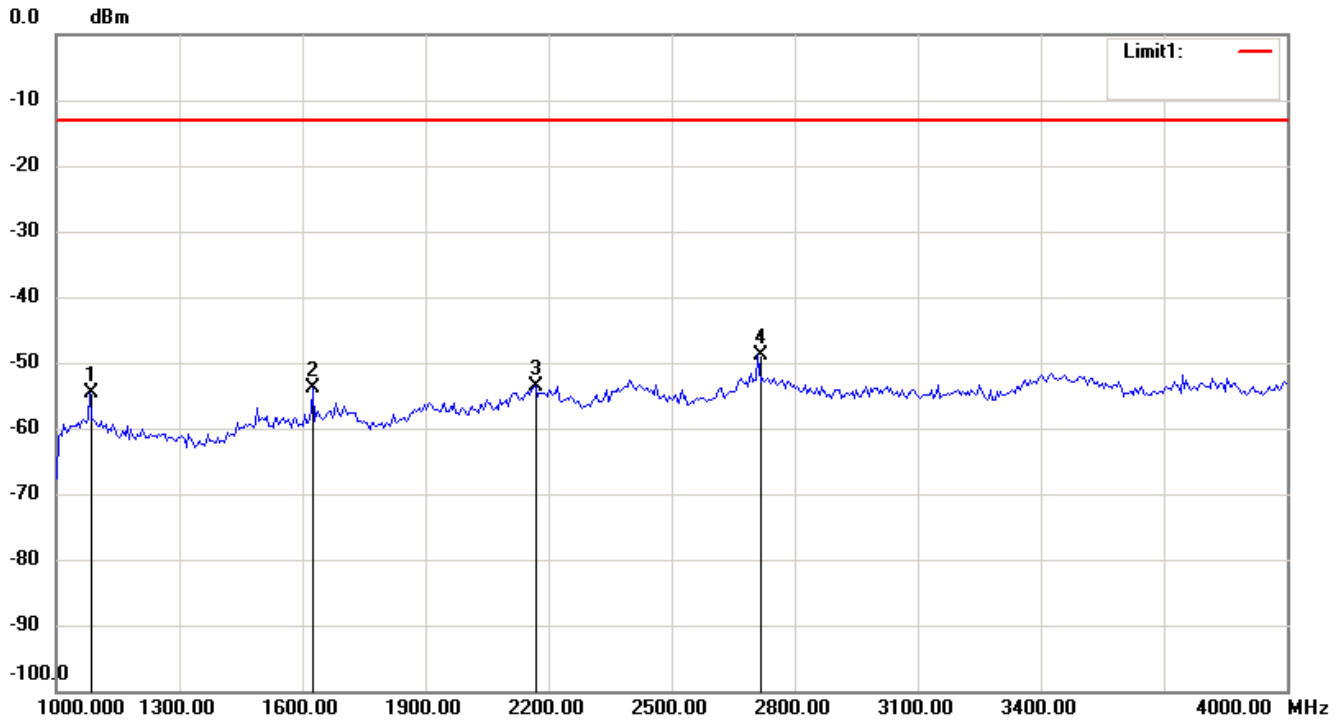

Note:

1. The attached measurement plots are preliminarily pre-scanned with peak detector for determining the final checking frequencies and are for reference only.
2. The some frequencies may exceed the limit line without the specified detectors, but that cannot present the results are failed to the specification of test standard.
3. For corrected test results are listed in the relevant table of radiated test data of this test report.



Registration number: W6M21108-11777-C-1

FCC ID: M5X-ACT8HA

601.9 MHz

Antenna Polarization H

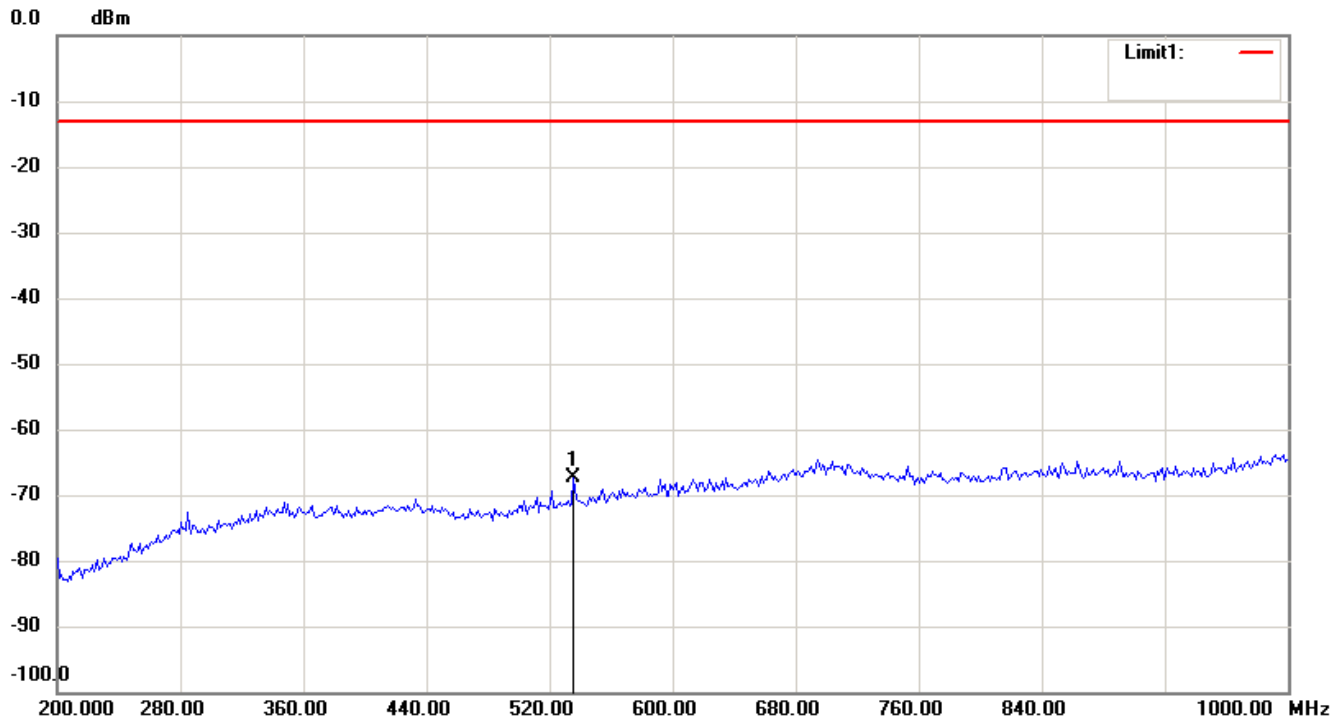
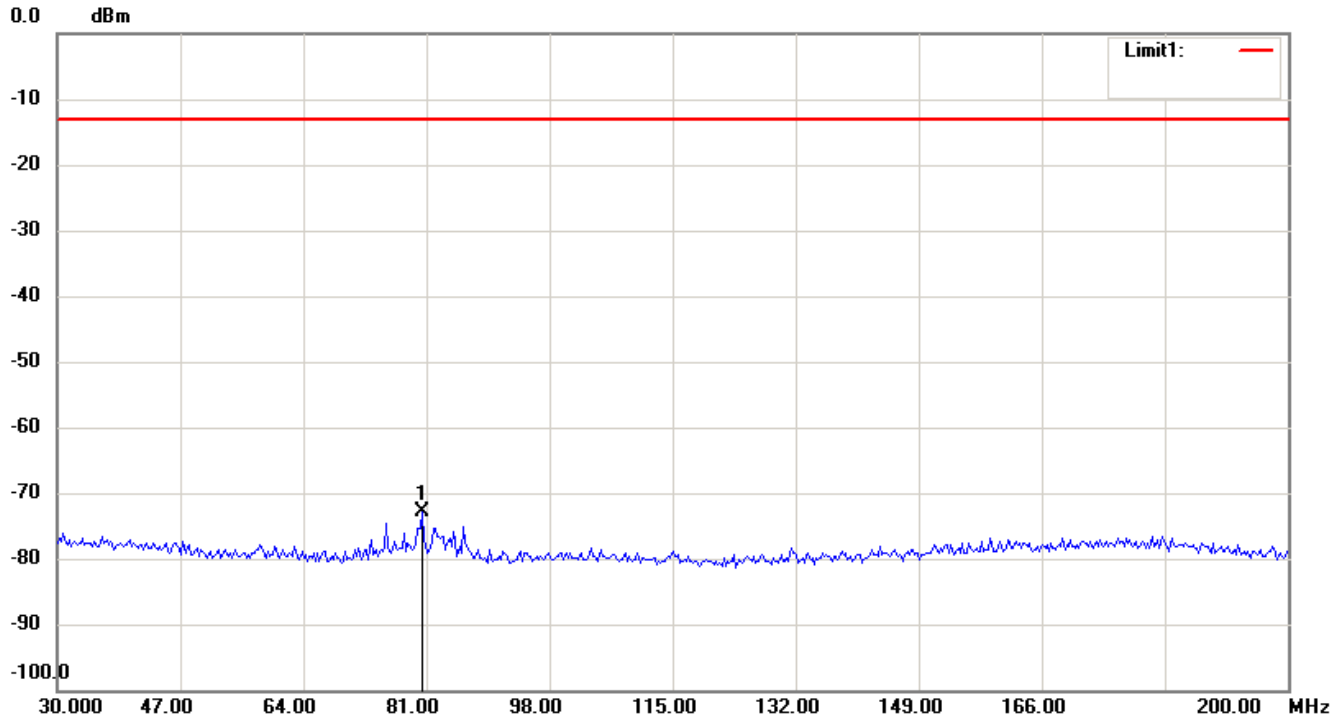

Note:

1. The attached measurement plots are preliminarily pre-scanned with peak detector for determining the final checking frequencies and are for reference only.
2. The some frequencies may exceed the limit line without the specified detectors, but that cannot present the results are failed to the specification of test standard.
3. For corrected test results are listed in the relevant table of radiated test data of this test report.



Worldwide Testing Services(Taiwan) Co., Ltd.

Registration number: W6M21108-11777-C-1

FCC ID: M5X-ACT8HA

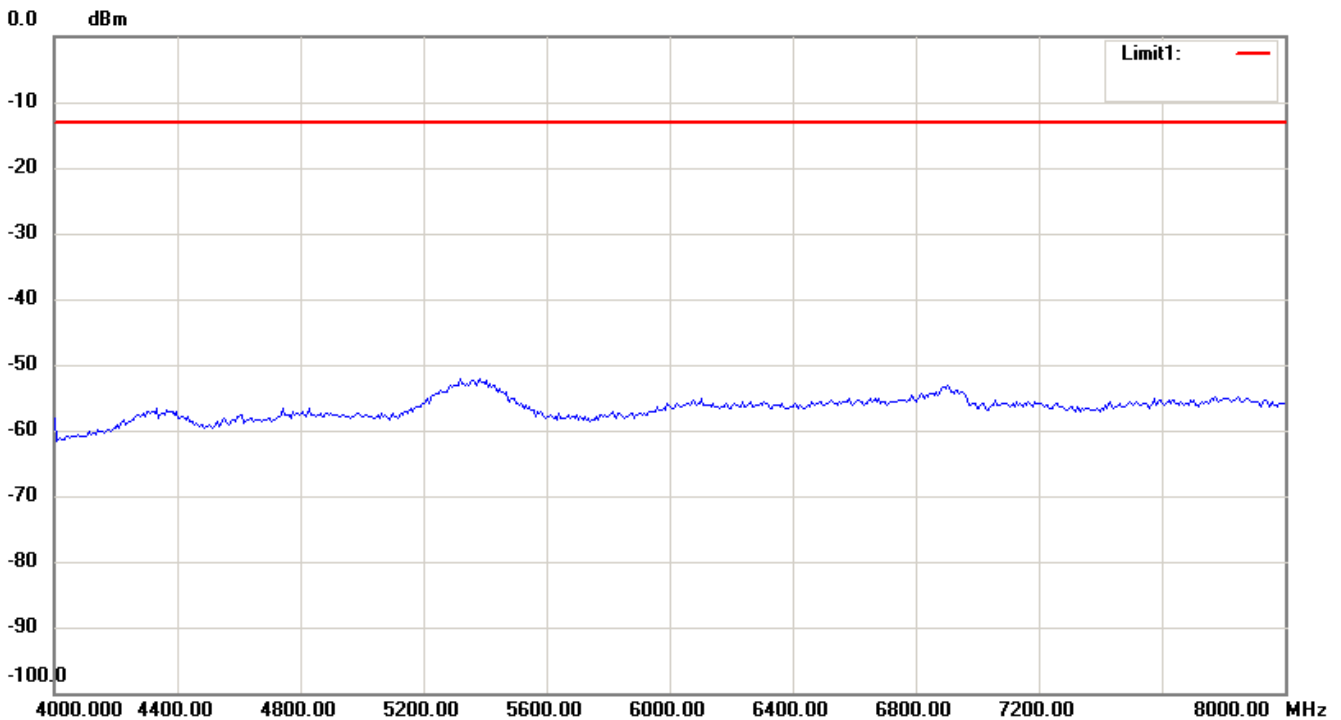
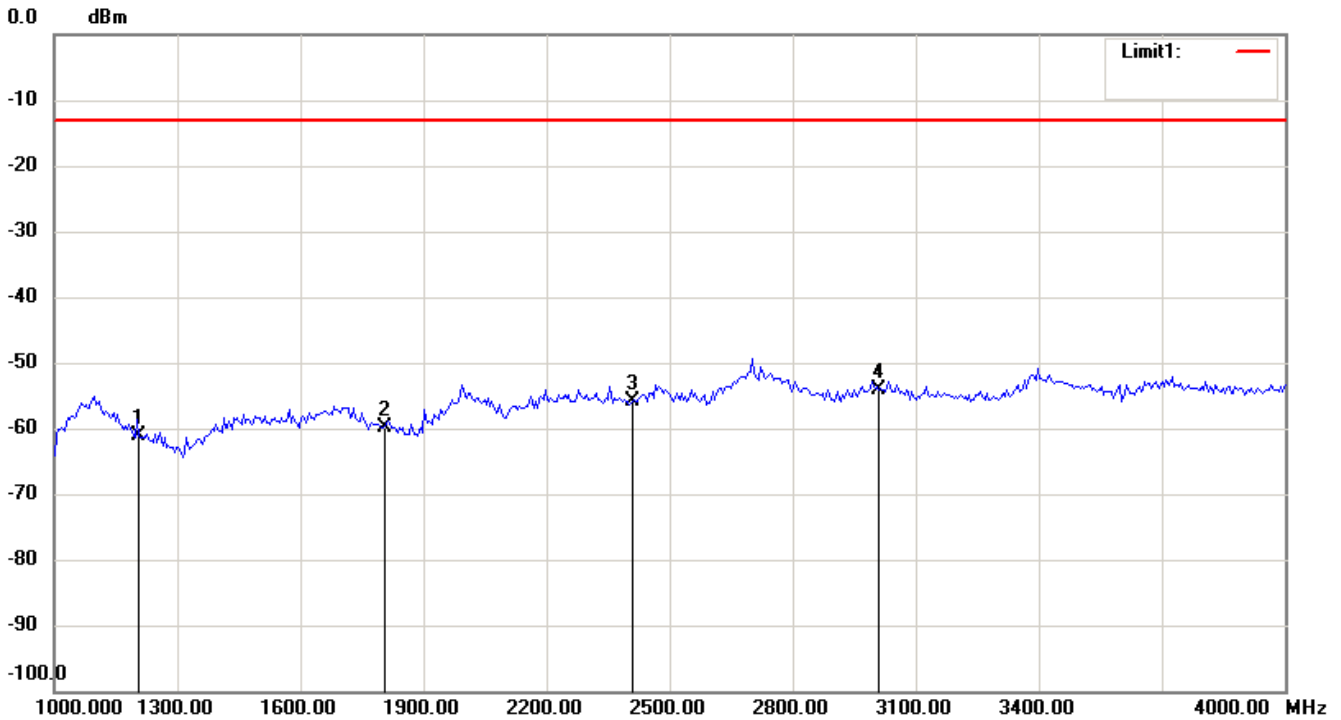

Note:

1. The attached measurement plots are preliminarily pre-scanned with peak detector for determining the final checking frequencies and are for reference only.
2. The some frequencies may exceed the limit line without the specified detectors, but that cannot present the results are failed to the specification of test standard.
3. For corrected test results are listed in the relevant table of radiated test data of this test report.



Registration number: W6M21108-11777-C-1

FCC ID: M5X-ACT8HA

Antenna Polarization V

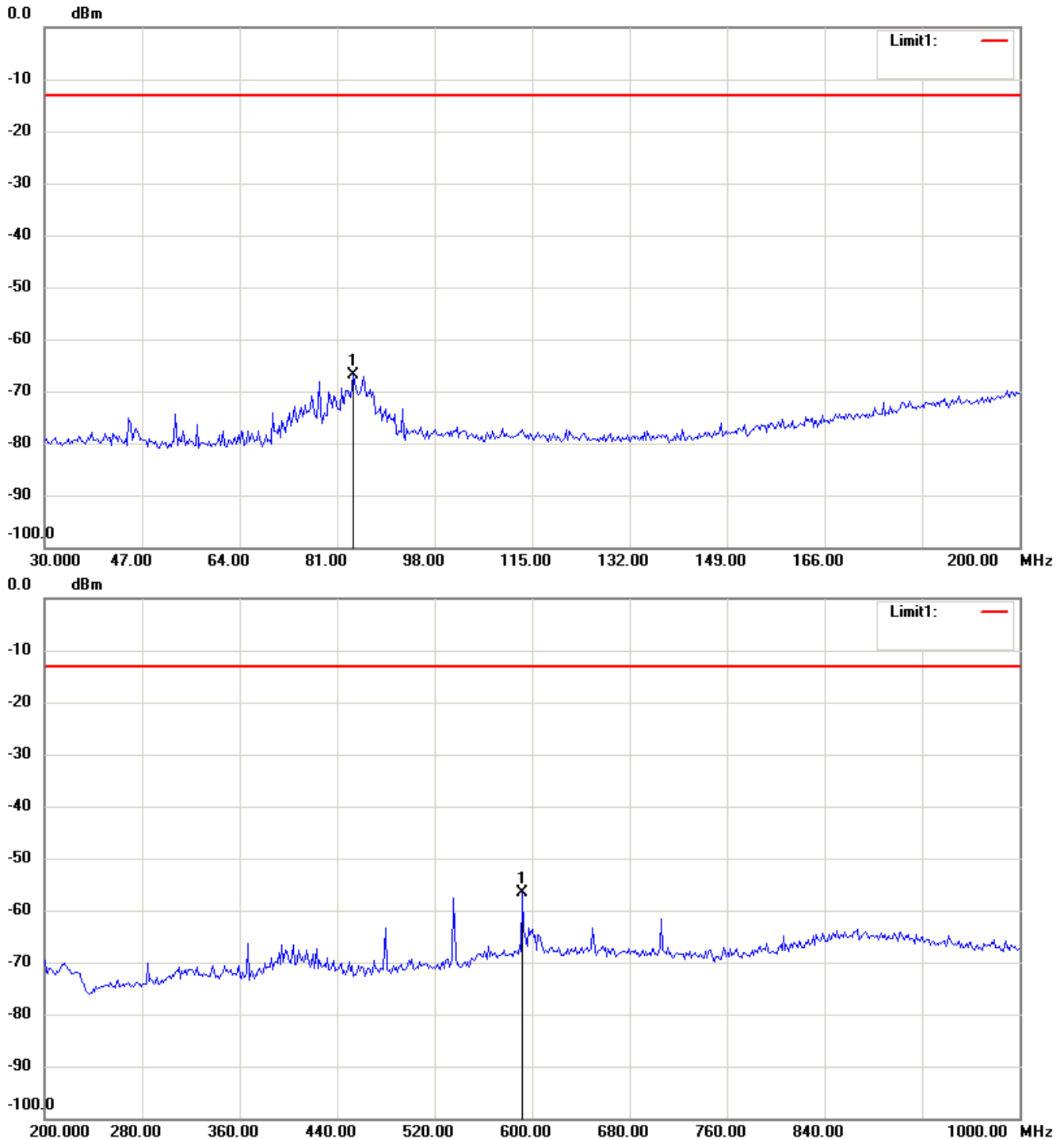

Note:

1. The attached measurement plots are preliminarily pre-scanned with peak detector for determining the final checking frequencies and are for reference only.
2. The some frequencies may exceed the limit line without the specified detectors, but that cannot present the results are failed to the specification of test standard.
3. For corrected test results are listed in the relevant table of radiated test data of this test report.



Worldwide Testing Services(Taiwan) Co., Ltd.

Registration number: W6M21108-11777-C-1

FCC ID: M5X-ACT8HA

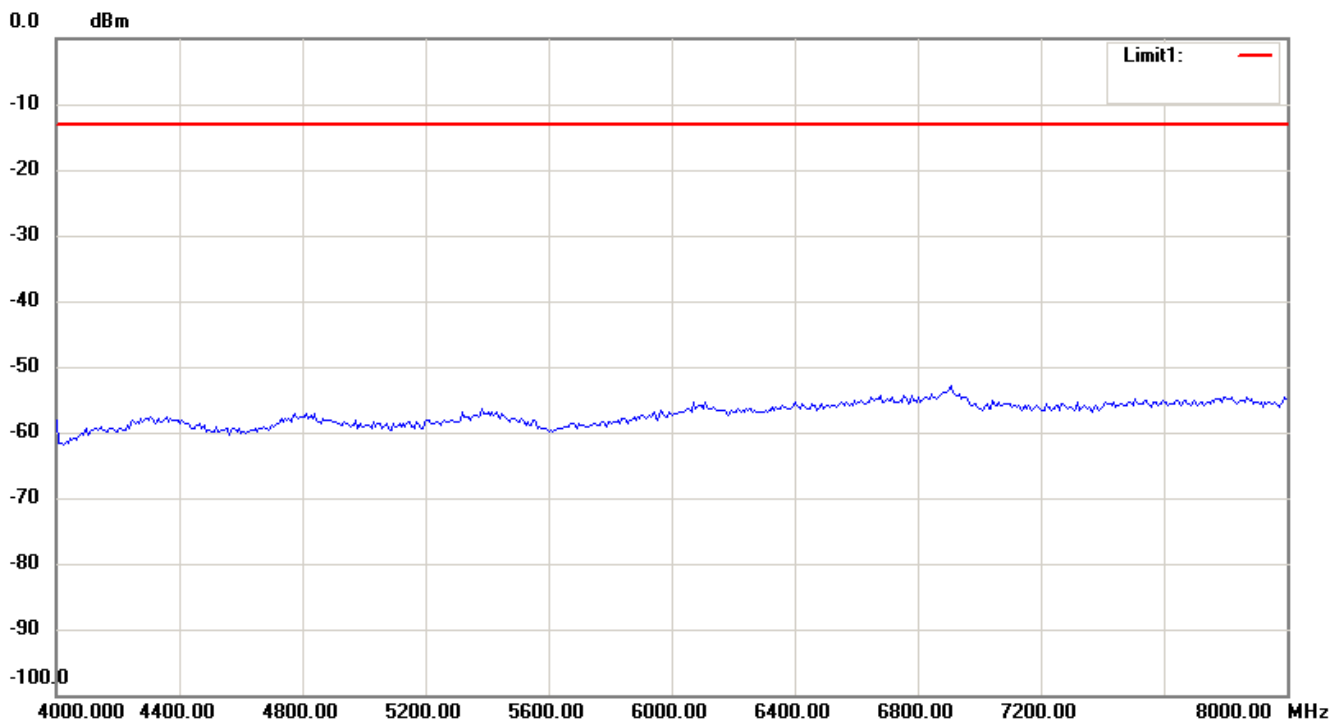
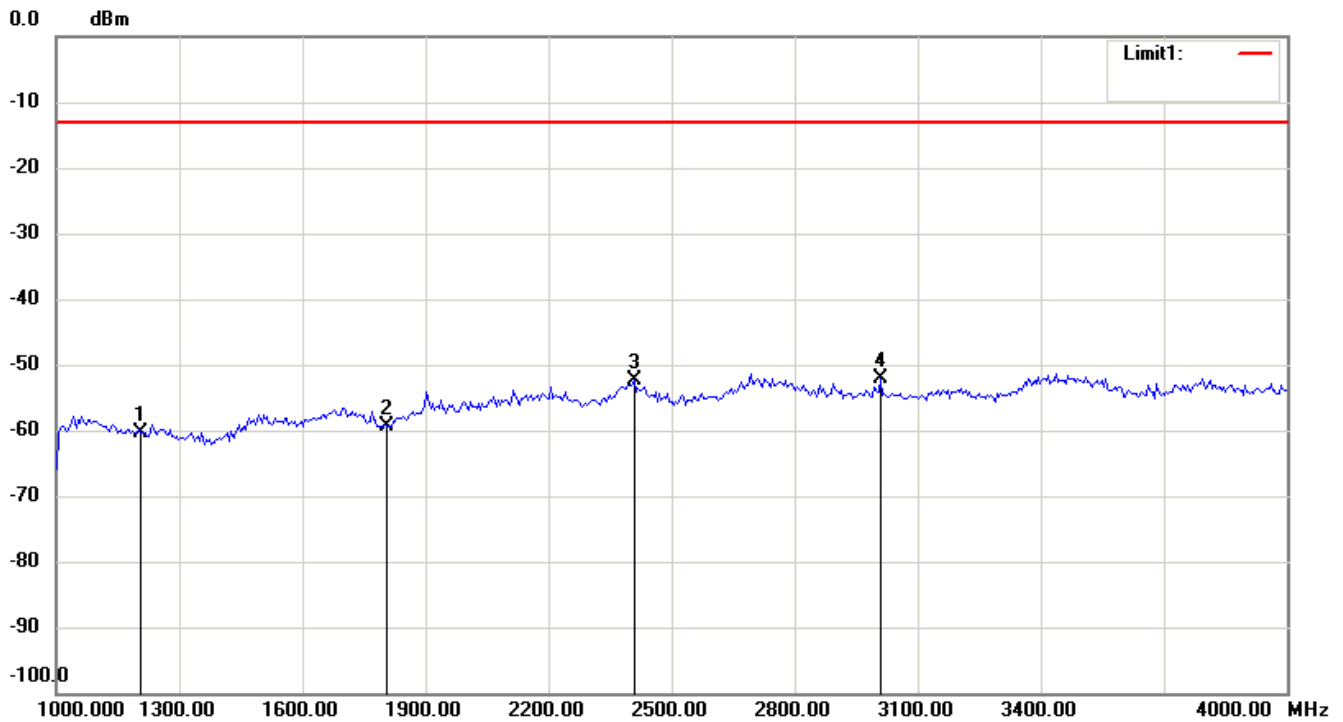

Note:

1. The attached measurement plots are preliminarily pre-scanned with peak detector for determining the final checking frequencies and are for reference only.
2. The some frequencies may exceed the limit line without the specified detectors, but that cannot present the results are failed to the specification of test standard.
3. For corrected test results are listed in the relevant table of radiated test data of this test report.



Worldwide Testing Services(Taiwan) Co., Ltd.

Registration number: W6M21108-11777-C-1

FCC ID: M5X-ACT8HA

External Photos





Worldwide Testing Services(Taiwan) Co., Ltd.

Registration number: W6M21108-11777-C-1
FCC ID: M5X-ACT8HA





Worldwide Testing Services(Taiwan) Co., Ltd.

Registration number: W6M21108-11777-C-1
FCC ID: M5X-ACT8HA





Worldwide Testing Services(Taiwan) Co., Ltd.

Registration number: W6M21108-11777-C-1
FCC ID: M5X-ACT8HA



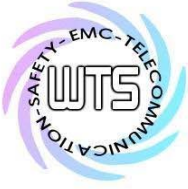

Worldwide Testing Services(Taiwan) Co., Ltd.

Registration number: W6M21108-11777-C-1
FCC ID: M5X-ACT8HA



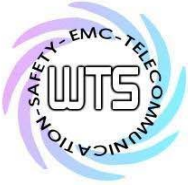

Worldwide Testing Services(Taiwan) Co., Ltd.

Registration number: W6M21108-11777-C-1
FCC ID: M5X-ACT8HA





Worldwide Testing Services(Taiwan) Co., Ltd.

Registration number: W6M21108-11777-C-1
FCC ID: M5X-ACT8HA





Registration number: W6M21108-11777-C-1
FCC ID: M5X-ACT8HA



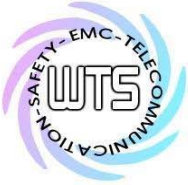

Worldwide Testing Services(Taiwan) Co., Ltd.

Registration number: W6M21108-11777-C-1

FCC ID: M5X-ACT8HA





Registration number: W6M21108-11777-C-1

FCC ID: M5X-ACT8HA

Internal Photos





Registration number: W6M21108-11777-C-1
FCC ID: M5X-ACT8HA



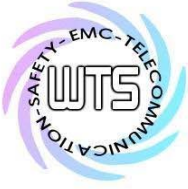

Registration number: W6M21108-11777-C-1
FCC ID: M5X-ACT8HA



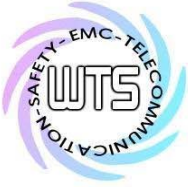

Worldwide Testing Services(Taiwan) Co., Ltd.

Registration number: W6M21108-11777-C-1

FCC ID: M5X-ACT8HA





Worldwide Testing Services(Taiwan) Co., Ltd.

Registration number: W6M21108-11777-C-1
FCC ID: M5X-ACT8HA

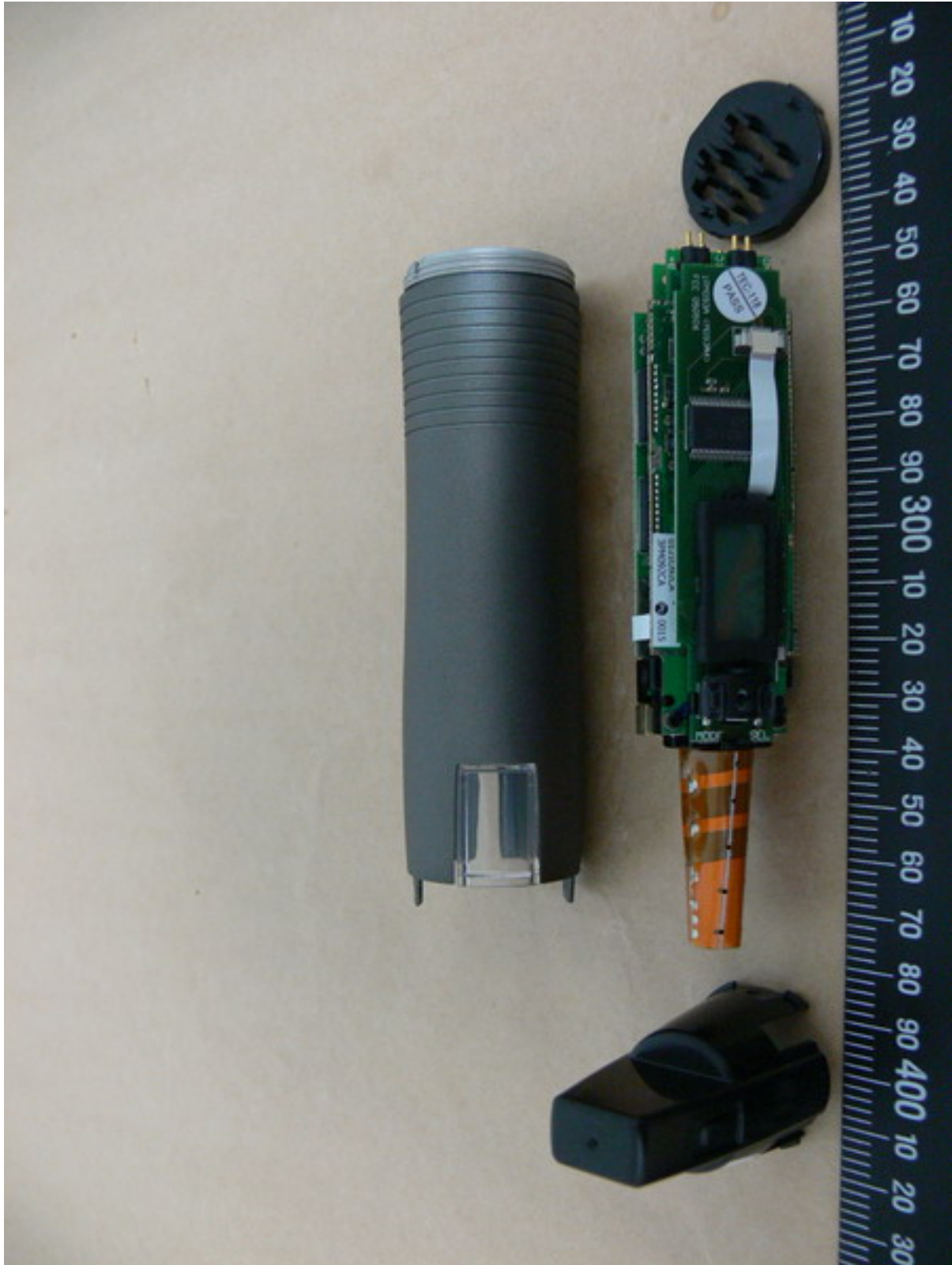

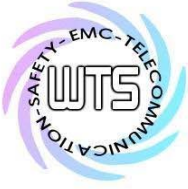

Registration number: W6M21108-11777-C-1
FCC ID: M5X-ACT8HA

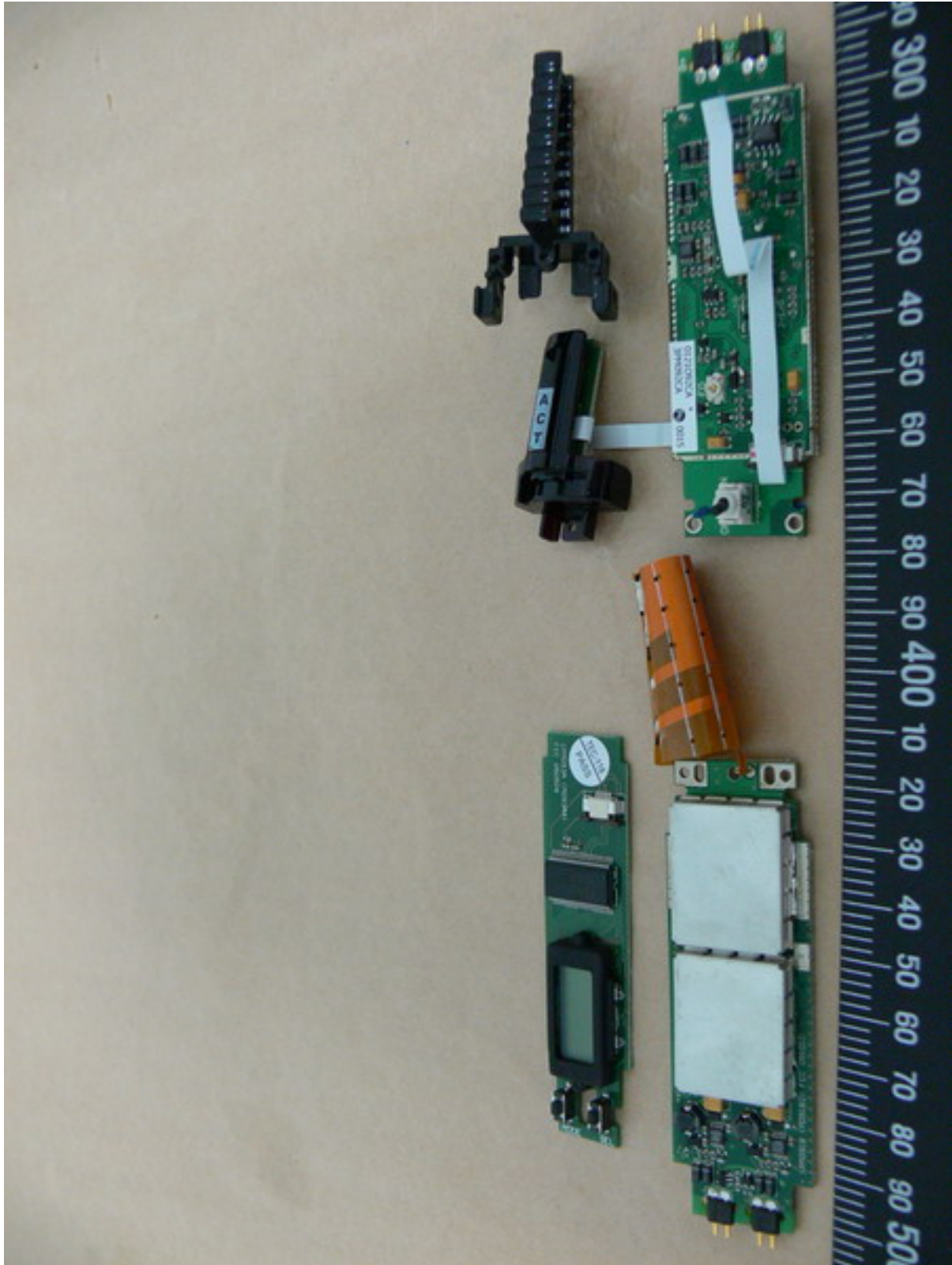



Registration number: W6M21108-11777-C-1
FCC ID: M5X-ACT8HA

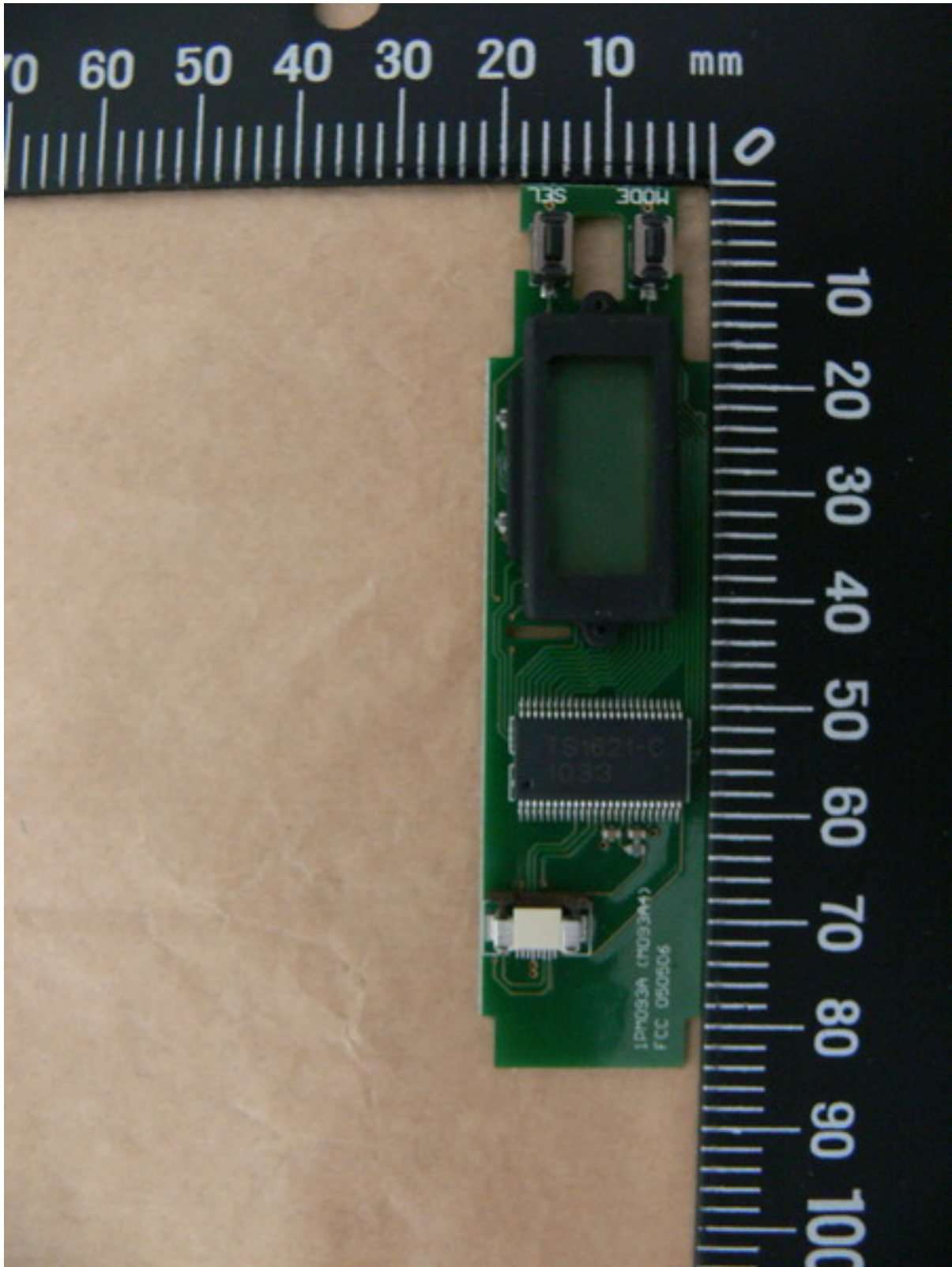

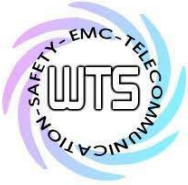

Registration number: W6M21108-11777-C-1
FCC ID: M5X-ACT8HA

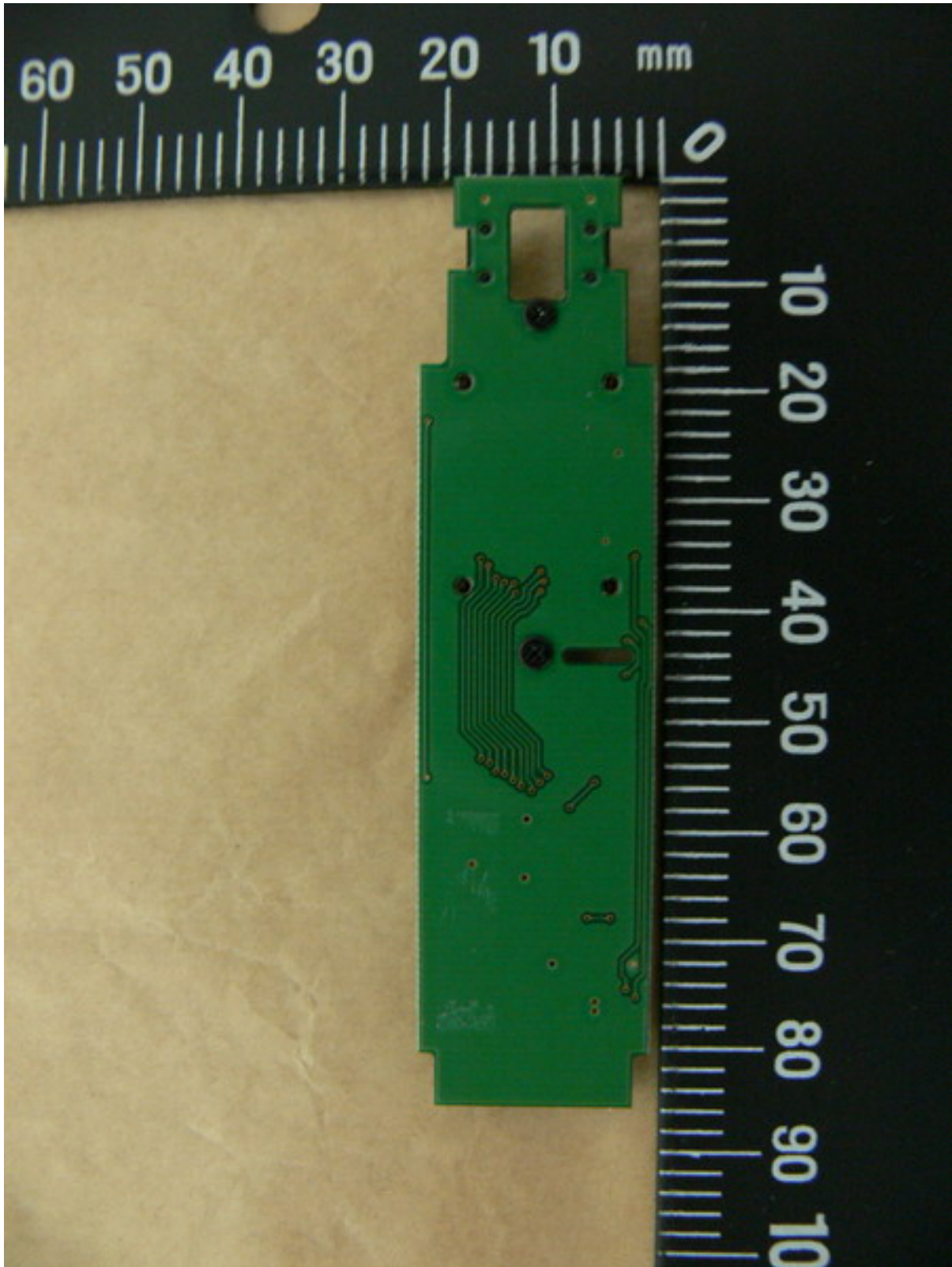

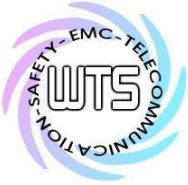

Registration number: W6M21108-11777-C-1
FCC ID: M5X-ACT8HA

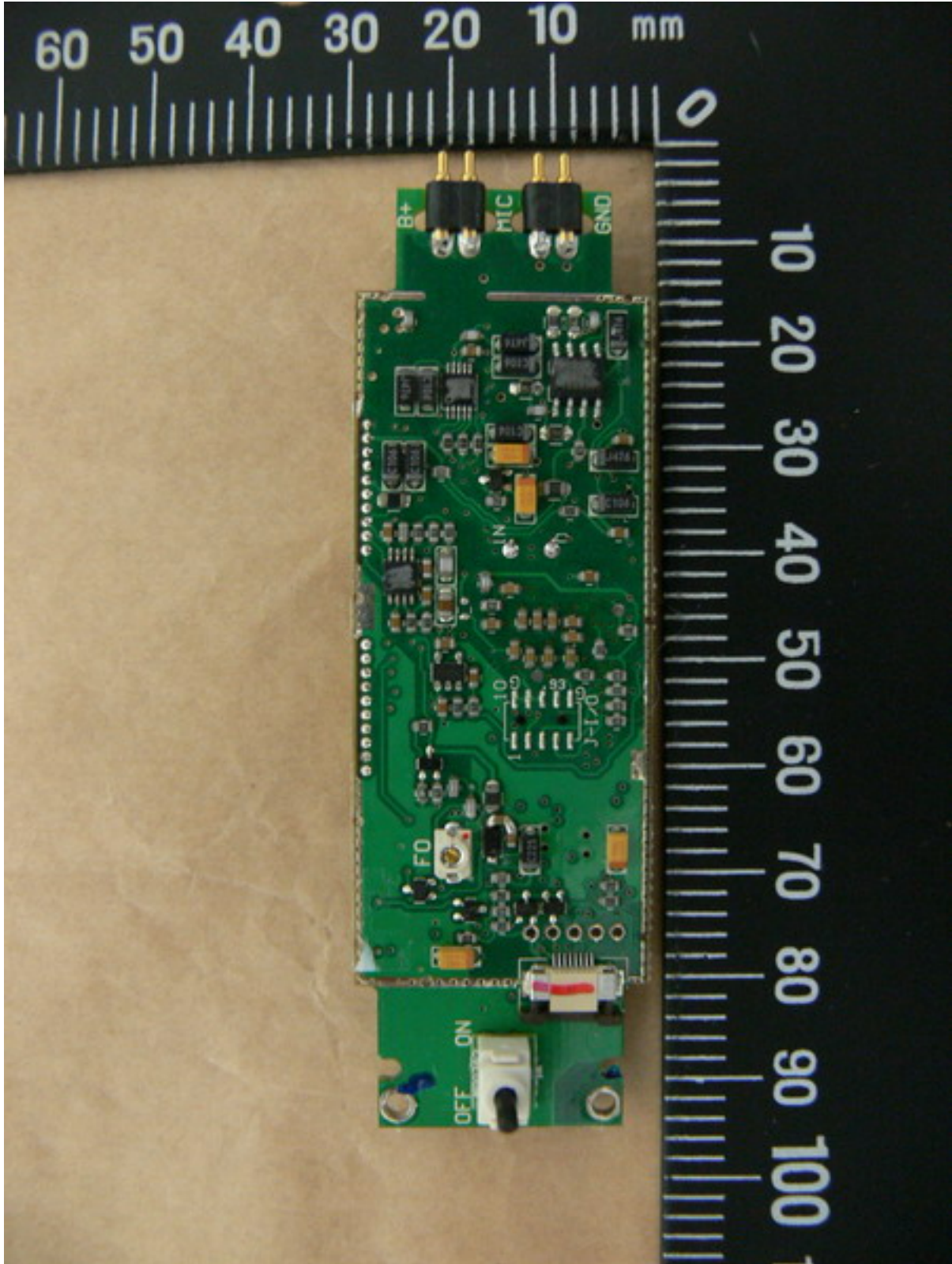



Registration number: W6M21108-11777-C-1

FCC ID: M5X-ACT8HA

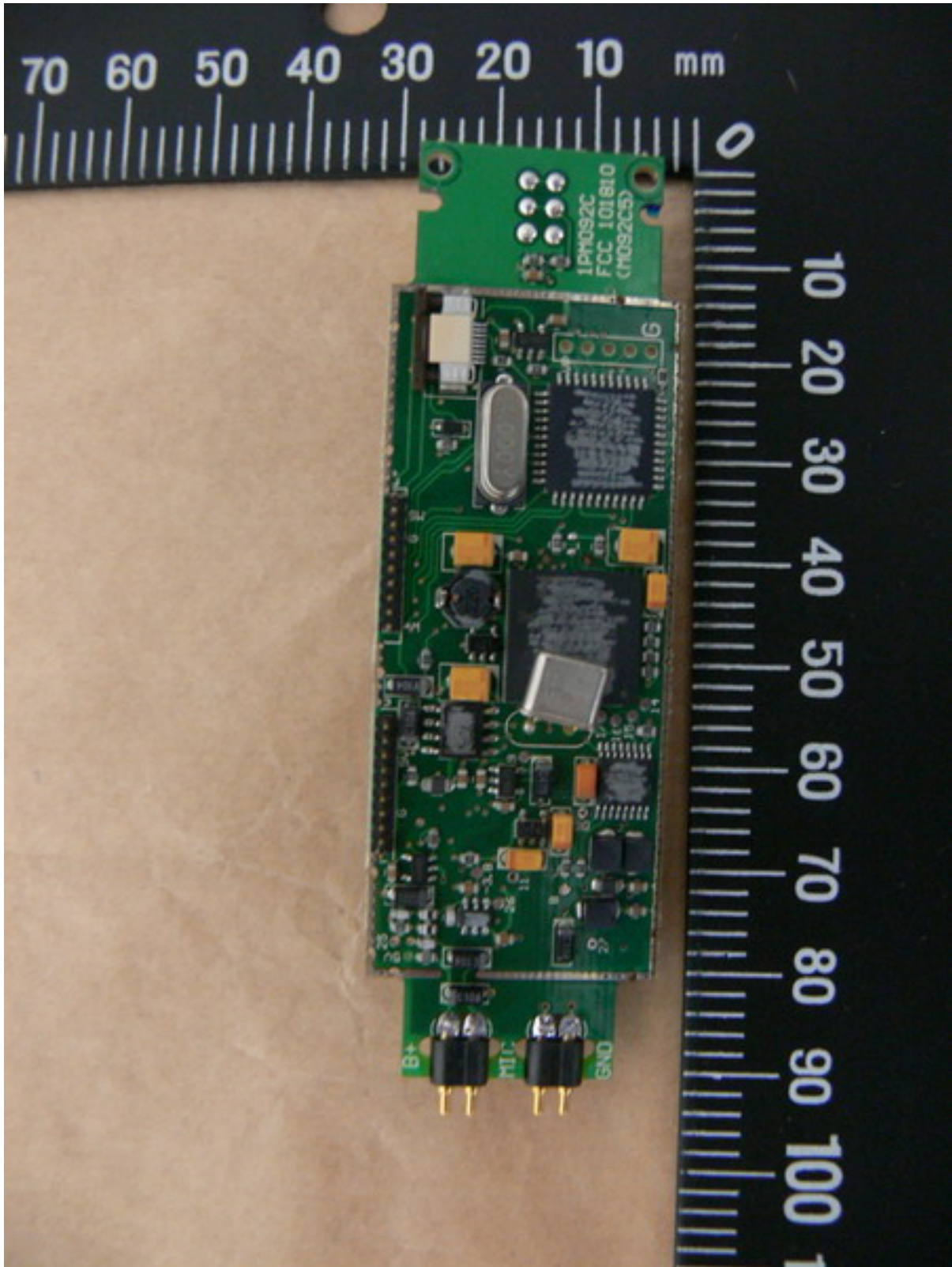

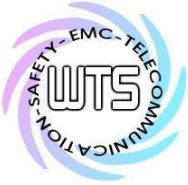

Worldwide Testing Services(Taiwan) Co., Ltd.

Registration number: W6M21108-11777-C-1
FCC ID: M5X-ACT8HA

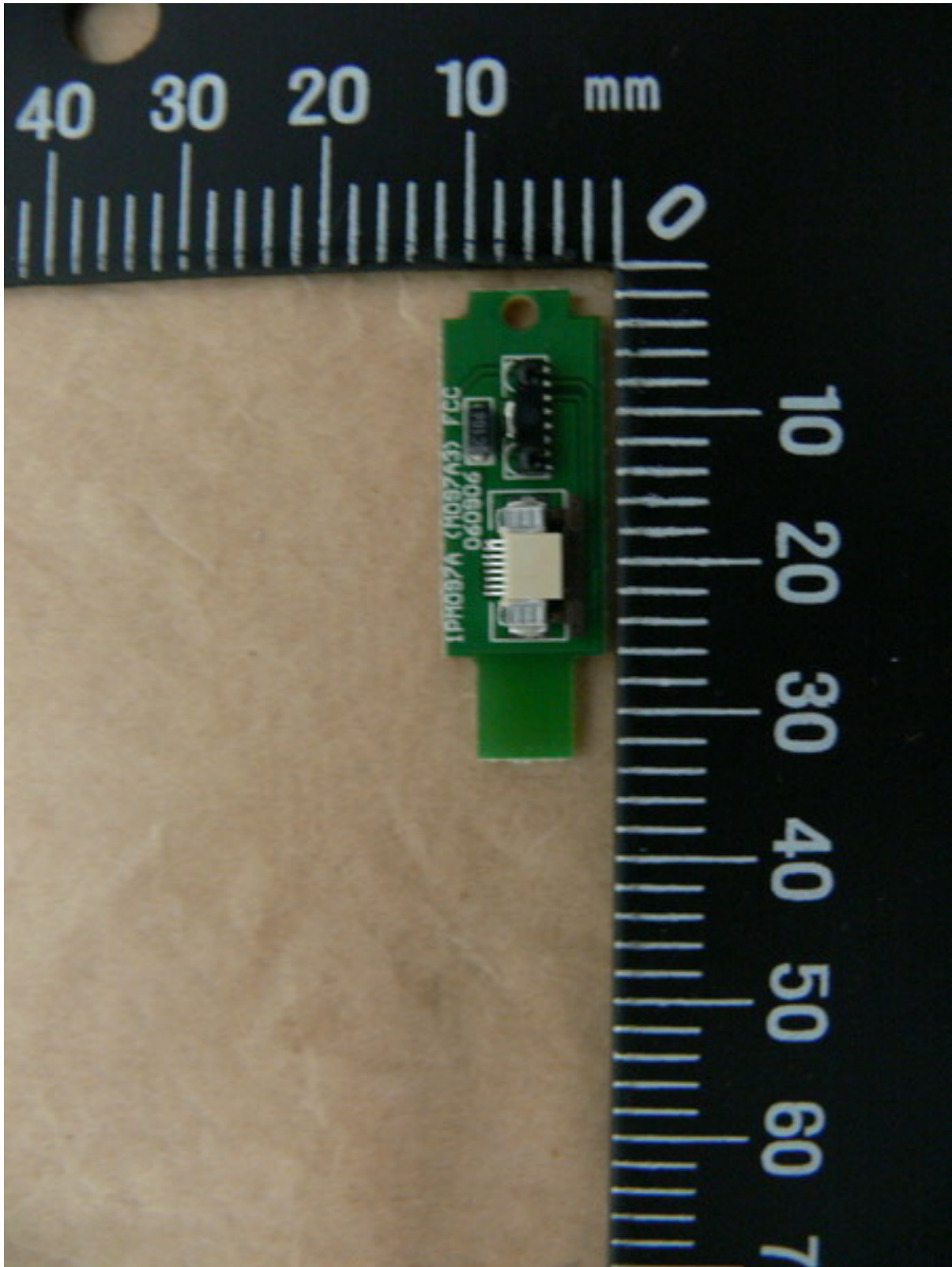



Registration number: W6M21108-11777-C-1
FCC ID: M5X-ACT8HA

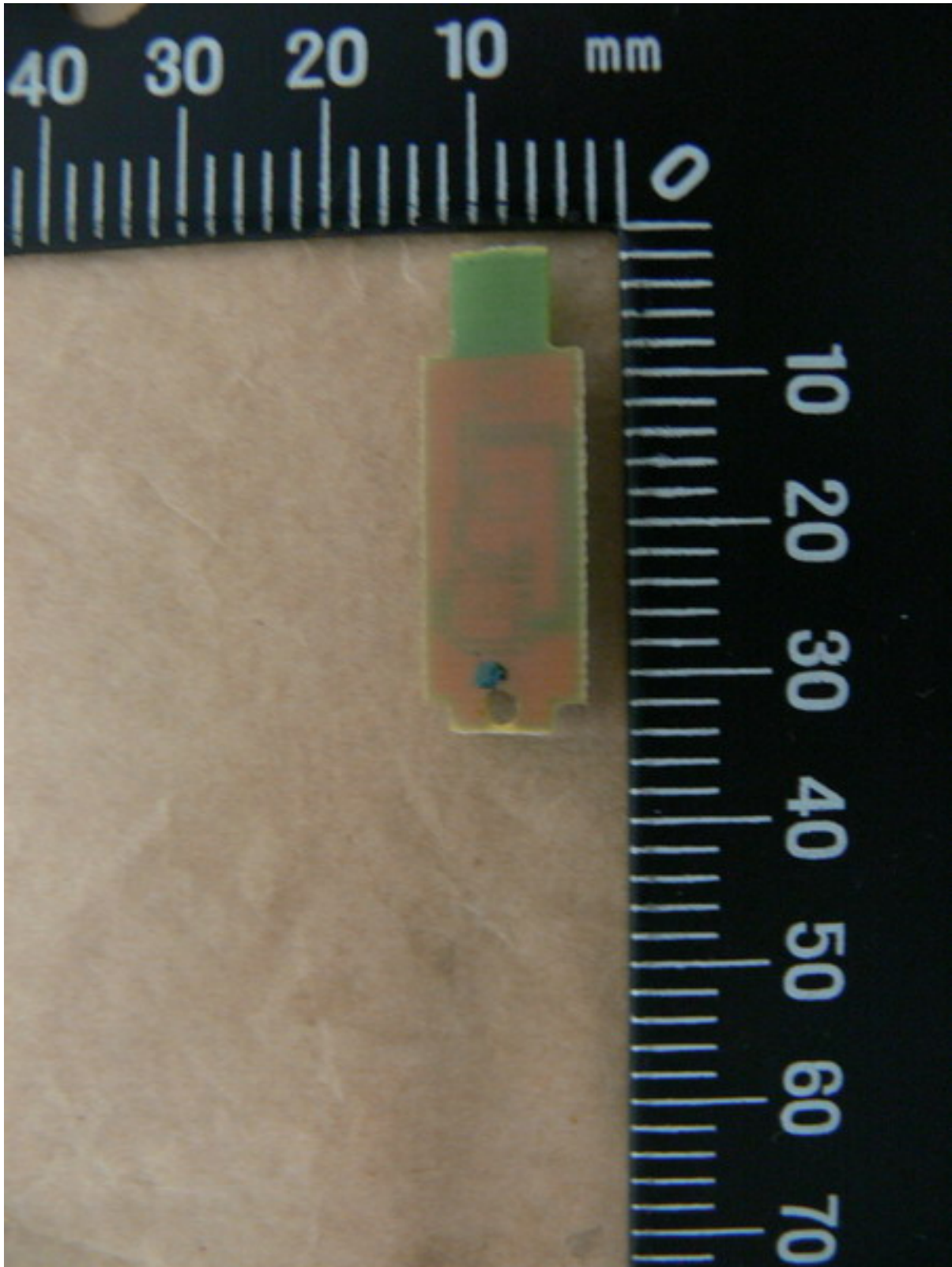



Registration number: W6M21108-11777-C-1
FCC ID: M5X-ACT8HA

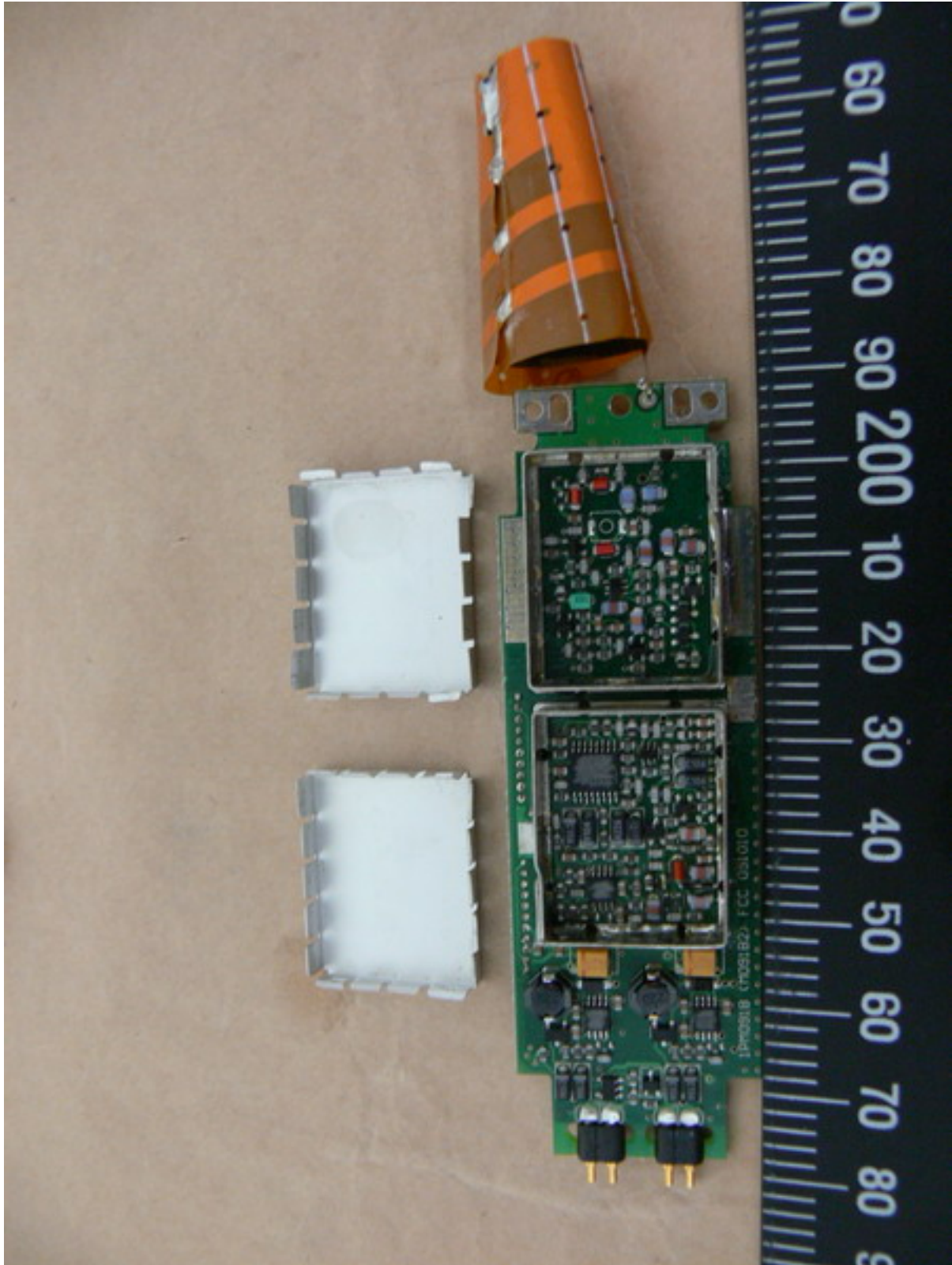

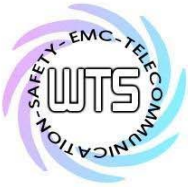

Registration number: W6M21108-11777-C-1

FCC ID: M5X-ACT8HA

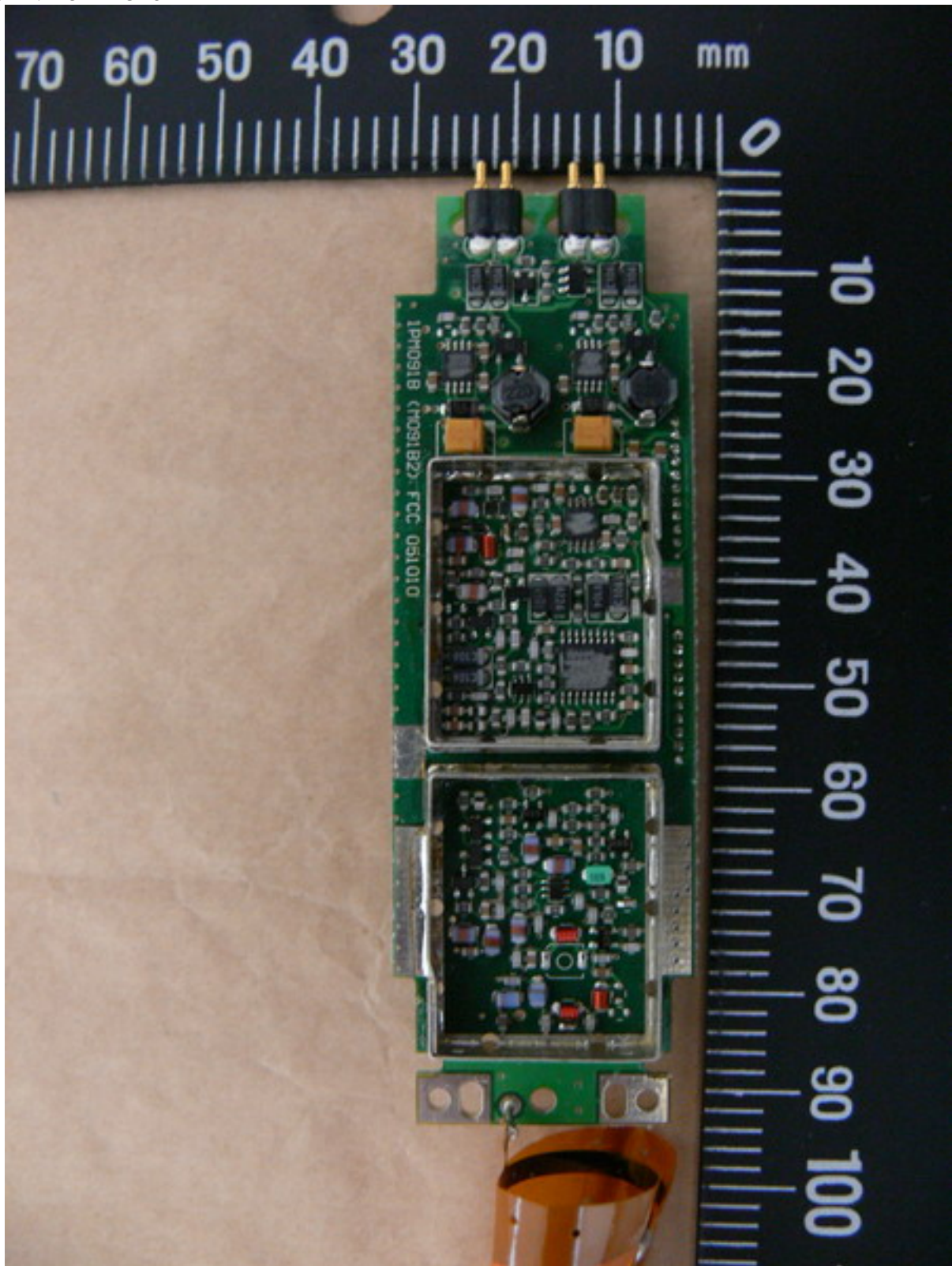



Registration number: W6M21108-11777-C-1

FCC ID: M5X-ACT8HA

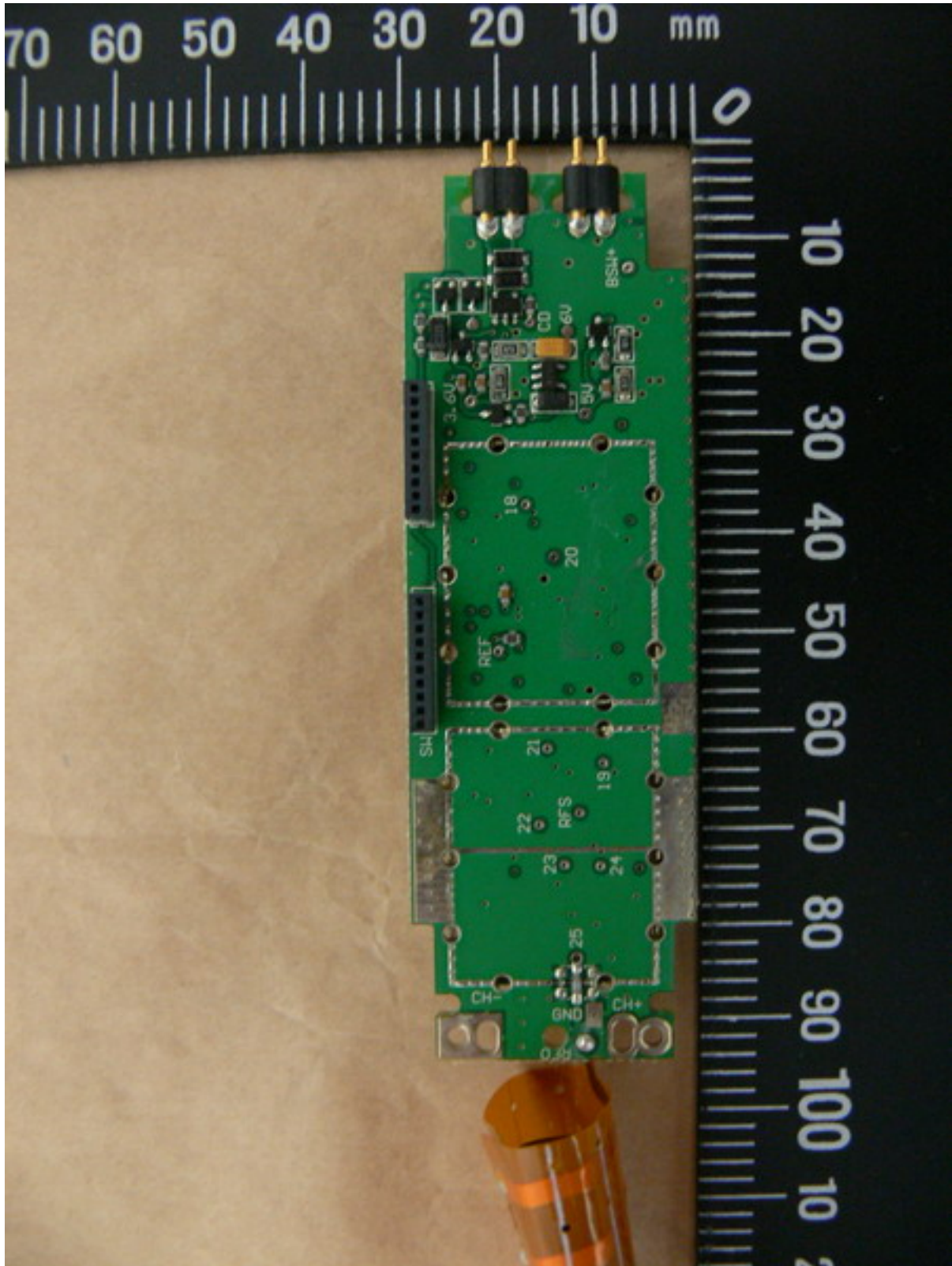

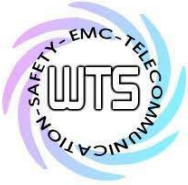

Worldwide Testing Services(Taiwan) Co., Ltd.

Registration number: W6M21108-11777-C-1
FCC ID: M5X-ACT8HA

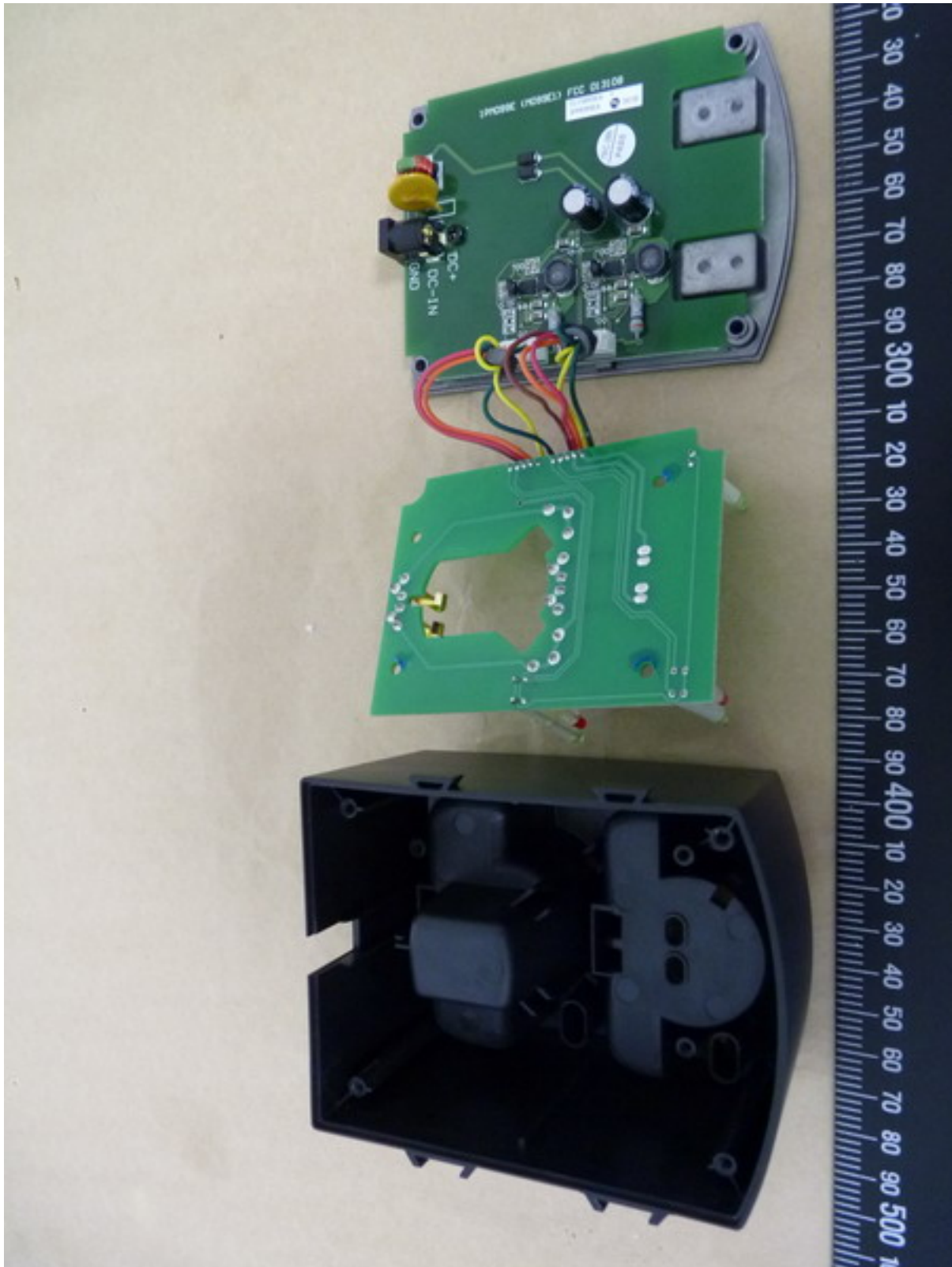



Registration number: W6M21108-11777-C-1
FCC ID: M5X-ACT8HA

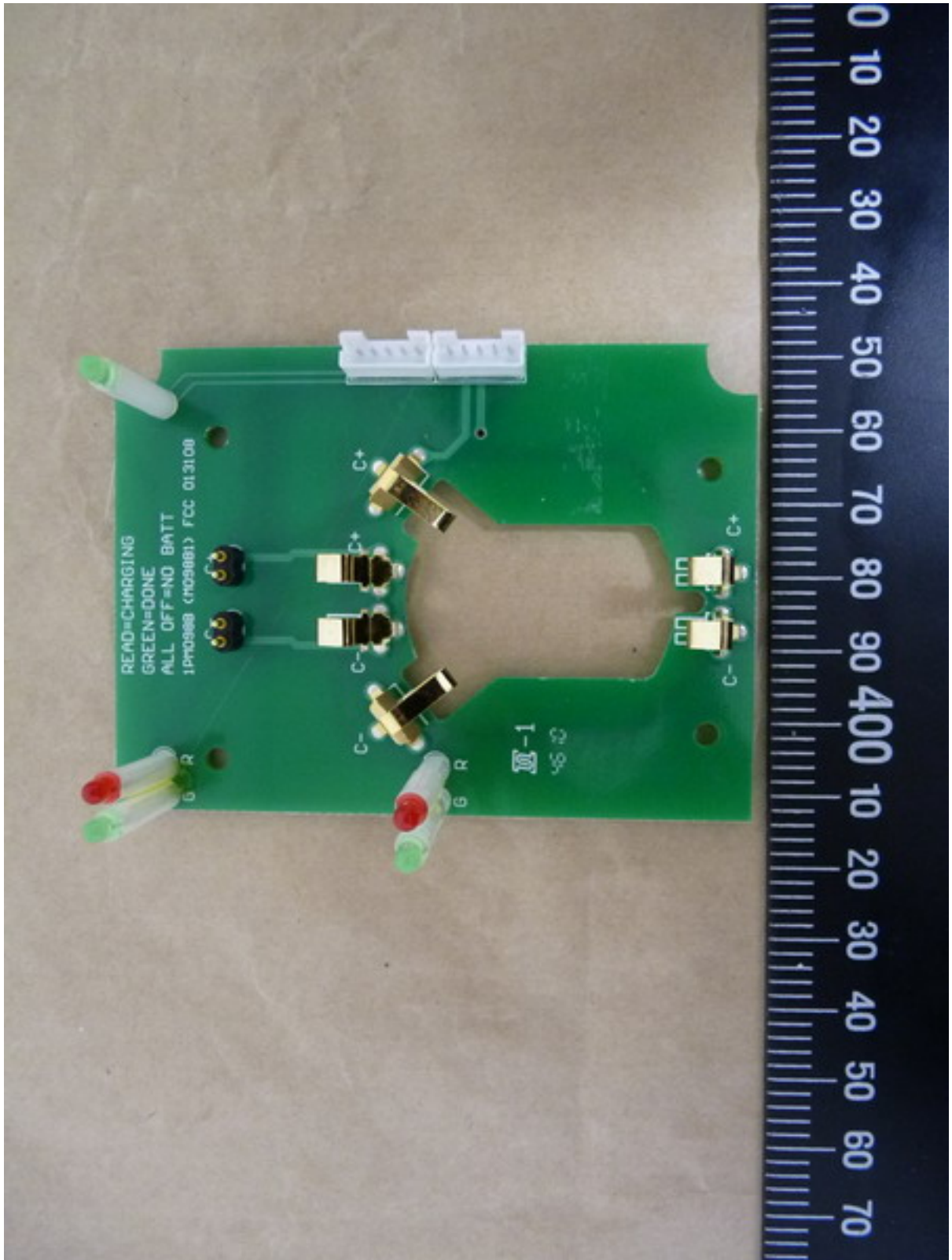



Worldwide Testing Services(Taiwan) Co., Ltd.

Registration number: W6M21108-11777-C-1

FCC ID: M5X-ACT8HA

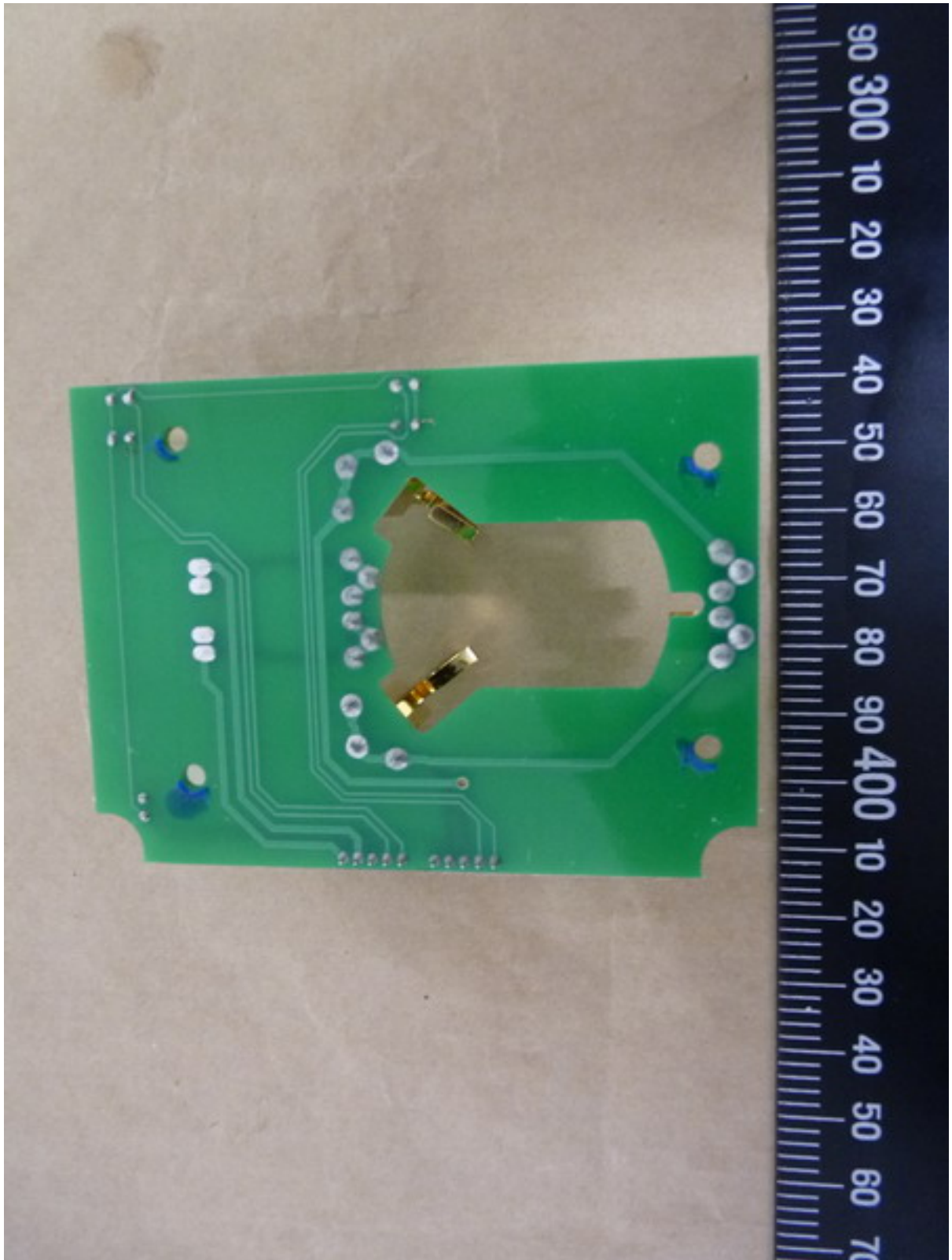

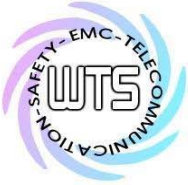

Registration number: W6M21108-11777-C-1
FCC ID: M5X-ACT8HA

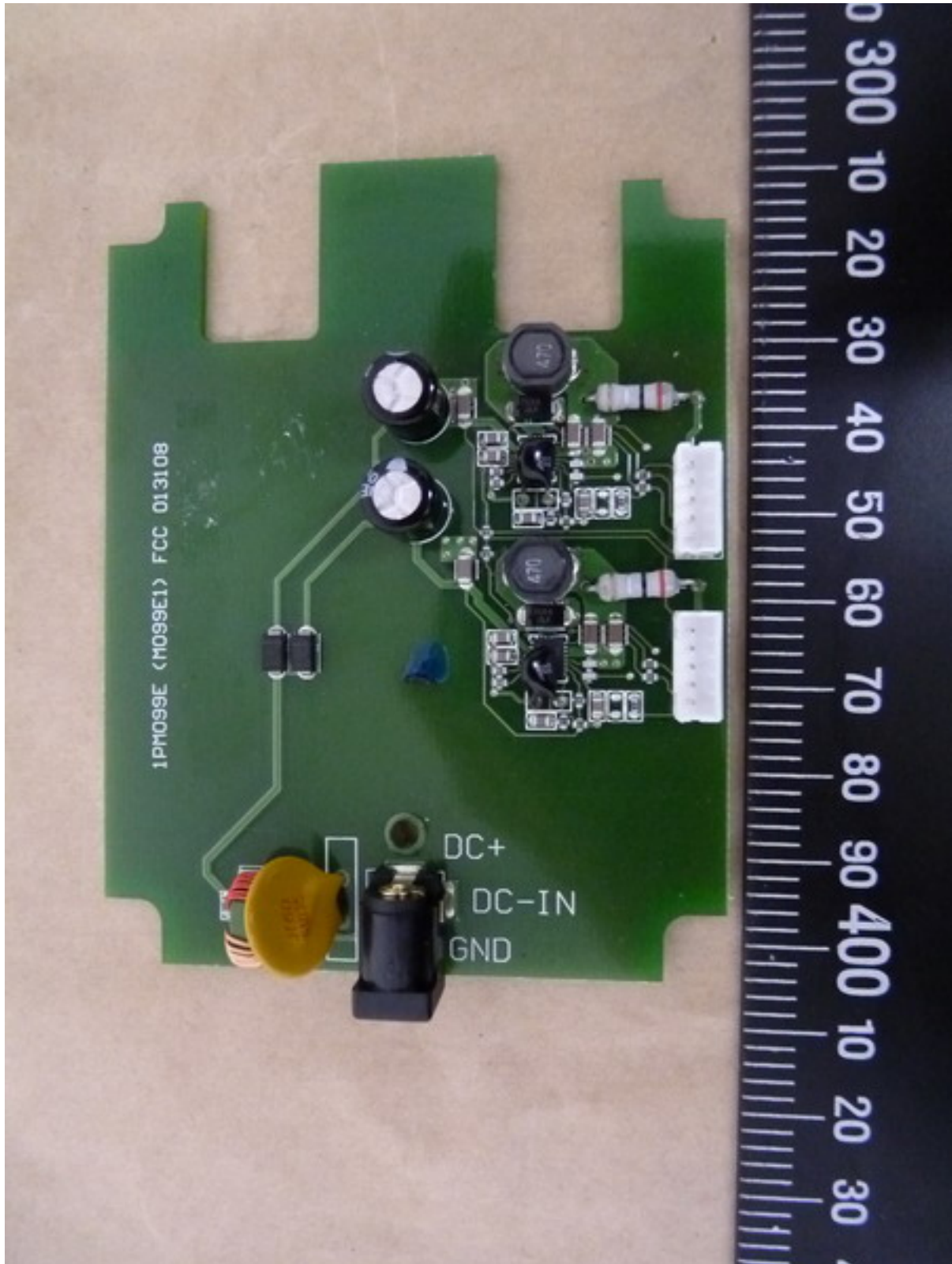

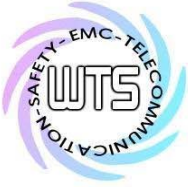

Worldwide Testing Services(Taiwan) Co., Ltd.

Registration number: W6M21108-11777-C-1
FCC ID: M5X-ACT8HA

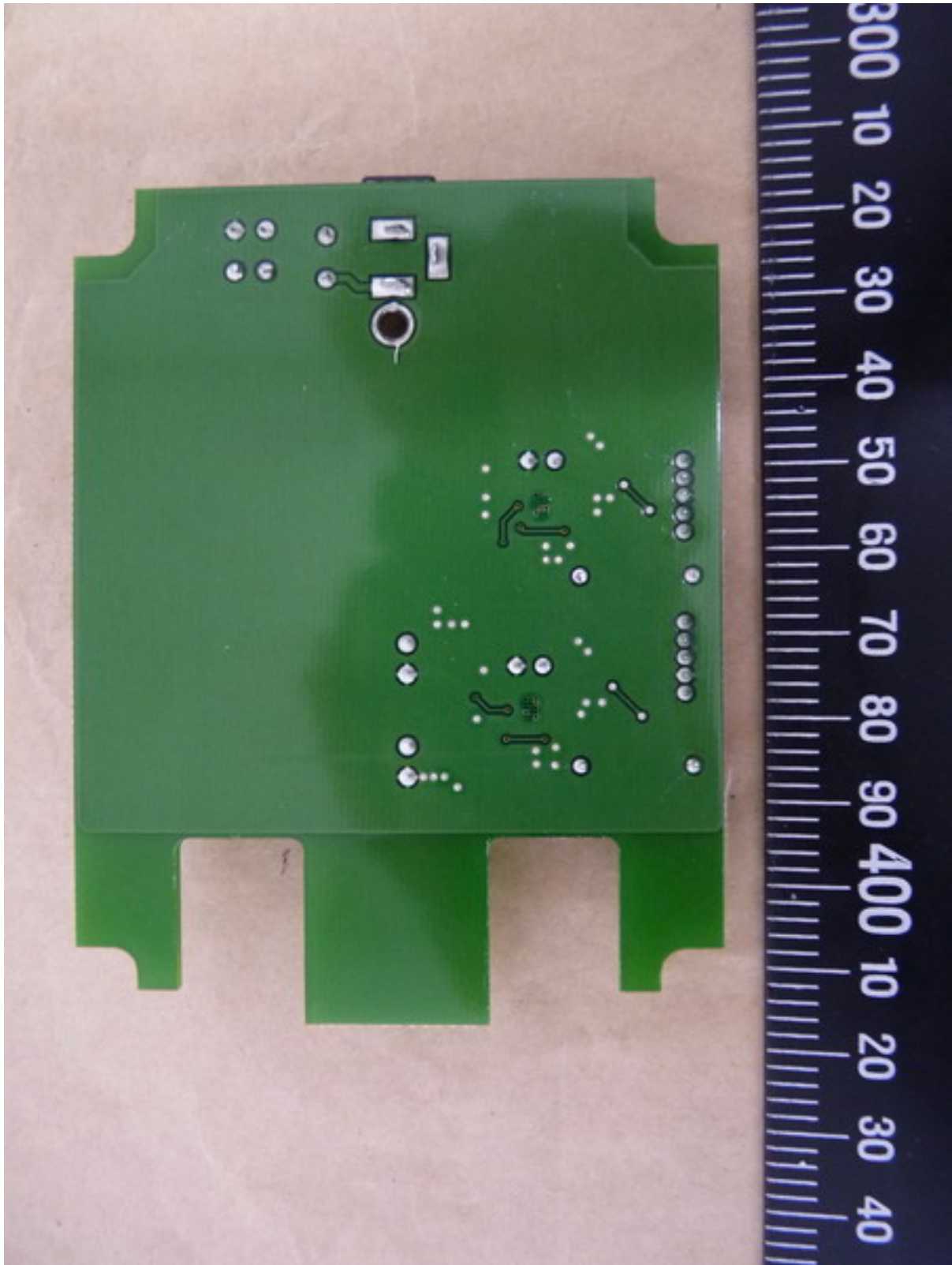



Registration number: W6M21108-11777-C-1

FCC ID: M5X-ACT8HA

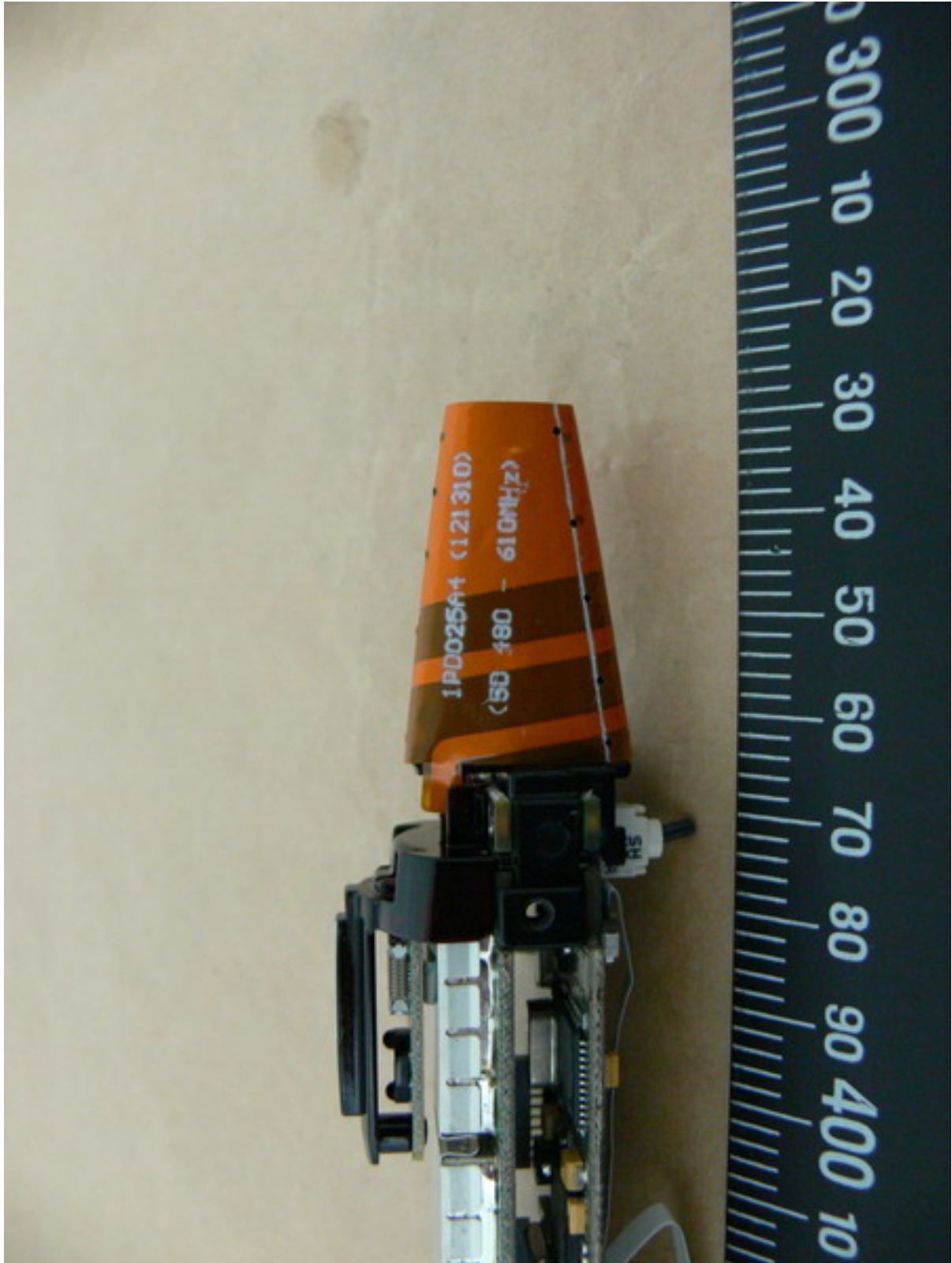

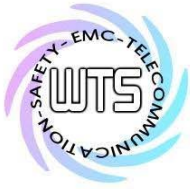

Registration number: W6M21108-11777-C-1

FCC ID: M5X-ACT8HA

Set Up Photo of Radiated Emission





Registration number: W6M21108-11777-C-1

FCC ID: M5X-ACT8HA

Set Up Photo of Conducted Emission

