



FCC LISTED, REGISTRATION
 NUMBER: 2764.01

ISED LISTED REGISTRATION
 NUMBER: 23595-1

Test report No:
 2370ERM.003A1

Test report

REFERENCE STANDARD:
 USA FCC Part 24
 CANADA ISED RSS-133

Identification of item tested	Module
Trademark	Continental Automotive Systems, Inc.
Model and /or type reference	WT50NA02
Other identification of the product	FCC ID: LHJ-WT50NA02 IC: 2807E-WT50NA02
Features	Module supporting LTE, WCDMA and GSM Cellular Technologies
Manufacturer	Continental Automotive Systems, Inc. 21440 W. Lake Cook Rd, Deer Park, IL 60010, U.S.A.
Test method requested, standard	USA FCC Part 24 10-1-18 Edition CANADA IC RSS-133 Issue 6, Jan. 2013 (Amendment January 2018); Measurement Guidance 971168 D01 v02r02 for certification of Licensed Digital Transmitters. ANSI C63.26 – 2015.
Summary	IN COMPLIANCE
Approved by (name / position & signature)	Domingo Galvez EMC&RF Lab Manager
Date of issue	08-26-2019
Report template No	FDT08_21

Index

Competences and guarantees	3
General conditions	3
Uncertainty	3
Data provided by the client.....	4
Usage of samples	4
Test sample description	5
Identification of the client.....	5
Testing period and place.....	6
Document history	6
Environmental conditions	7
Remarks and comments	8
Testing verdicts.....	8
Summary	8
List of equipment used during the test.....	9
Appendix A: Test Results for 2G	78
Appendix B: Test Results for 3G	46
Appendix C: Test Results for LTE	78

Competences and guarantees

DEKRA Certification Inc. is a testing laboratory accredited by A2LA (The American Association for Laboratory Accreditation), to perform the tests indicated in the Certificate 2764.01.

DEKRA Certification Inc. is a testing laboratory competent to carry out the tests described in this report.

In order to assure the traceability to other national and international laboratories, DEKRA Certification Inc. has a calibration and maintenance program for its measurement equipment.

DEKRA Certification Inc. guarantees the reliability of the data presented in this report, which is the result of the measurements and the tests performed to the item under test on the date and under the conditions stated on the report and, it is based on the knowledge and technical facilities available at DEKRA Certification at the time of performance of the test.

DEKRA Certification Inc. is liable to the client for the maintenance of the confidentiality of all information related to the item under test and the results of the test.

The results presented in this Test Report apply only to the item under test established in this document.

IMPORTANT: No parts of this report may be reproduced or quoted out of context, in any form or by any means, except in full, without the previous written permission of DEKRA Certification Inc.

General conditions

1. This report is only referred to the item that has undergone the test.
2. This report does not constitute or imply on its own an approval of the product by the Certification Bodies or competent Authorities.
3. This document is only valid if complete; no partial reproduction can be made without previous written permission of DEKRA Certification Inc.
4. This test report cannot be used partially or in full for publicity and/or promotional purposes without previous written permission of DEKRA Certification Inc. and the Accreditation Bodies.

Uncertainty

Uncertainty (factor $k=2$) was calculated according to the DEKRA Certification internal document PODT000.

Frequency (MHz)	U(k=2)	Units
30-180	3.82	dB
180-1000	2.61	dB
1000-18000	2.92	dB
18000-40000	2.15	dB

Data provided by the client

Module supporting LTE, WCDMA and GSM Cellular Technologies.

DEKRA declines any responsibility with respect to the information provided by the client and that may affect the validity of results.

Usage of samples

Samples undergoing test have been selected by: The client.

Sample S/01 is composed of the following elements:

Control N°	Description	Model	Serial N°	Date of reception
2370.07	CAT 11 Module Designation NA	WT50NA02	015433000004487	5/21/2019
2370.03	Antenna_LTE dipole	SPDA24700/2700	-	5/08/2019
2370.04	Antenna_LTE dipole	SPDA24700/2700	-	5/08/2019
2370.05	Power cable	-	-	5/08/2019

1. Sample S/01 was used for the following test(s):

All conducted and radiated tests indicated in appendix A.

Test sample description

Ports..... :	Port name and description		Cable				
			Specified length [m]	Attached during test	Shielded		
	No Data Provided			<input type="checkbox"/>	<input type="checkbox"/>		
				<input type="checkbox"/>	<input type="checkbox"/>		
				<input type="checkbox"/>	<input type="checkbox"/>		
				<input type="checkbox"/>	<input type="checkbox"/>		
Supplementary information to the ports..... :	No Data Provided						
Rated power supply	Voltage and Frequency		Reference poles				
			L1	L2	L3	N	PE
	<input type="checkbox"/>	AC: 230Vac / 50Hz.	<input type="checkbox"/>	<input type="checkbox"/>	<input type="checkbox"/>	<input type="checkbox"/>	<input type="checkbox"/>
	<input type="checkbox"/>	AC:	<input type="checkbox"/>	<input type="checkbox"/>	<input type="checkbox"/>	<input type="checkbox"/>	<input type="checkbox"/>
	<input checked="" type="checkbox"/>	DC: 13.4 V					
<input type="checkbox"/>	DC:						
Rated Power	No Data Provided						
Clock frequencies	No Data Provided						
Other parameters..... :	No Data Provided						
Software version	OTP_2.48						
Hardware version..... :	P3						
Dimensions in cm (L x W x D)	No Data Provided						
Mounting position..... :	<input type="checkbox"/>	Table top equipment					
	<input type="checkbox"/>	Wall/Ceiling mounted equipment					
	<input type="checkbox"/>	Floor standing equipment					
	<input type="checkbox"/>	Hand-held equipment					
	<input type="checkbox"/>	Other:					
Modules/parts	Module/parts of test item		Type		Manufacturer		
	No Data provided						

Accessories (not part of the test item)	Description	Type	Manufacturer
Documents as provided by the applicant.....	Description	File name	Issue date
	Equipment declaration data	FDT30_15_Declaration_Equipment_Data_Continental_WT50NA02_signed	2019-06-17

Copy of marking plate:



Identification of the client

Continental Automotive Systems, Inc.

21440 W. Lake Cook Rd, Deer Park, IL 60010, U.S.A.

Testing period and place

Test Location	DEKRA Certification, Inc.
Date (start)	05-22-2019
Date (finish)	06-06-2019

Document history

Report number	Date	Description
2370ERM.003	06-20-2019	First release
2370ERM.003A1	08-26-2019	Second release

Modifications to the reference test report

It was introduced the following modifications in respect to the test report number 2370ERM.003A1 related with the same samples, in the next clauses and sub-clauses:

Clauses/ Sub-Clauses	Modification	Justification
----------------------	--------------	---------------

Description of Test conditions/ Page 13

GPRS nominal bandwidth specified was changed from 300KHz to 200KHz

To represent nominal channel bandwidth properly

Environmental conditions

In the control chamber, the following limits were not exceeded during the test:

Temperature	Min. = 15 °C Max. = 35 °C
Relative humidity	Min. = 30 % Max. = 75 %
Air pressure	Min. = 860 mbar Max. = 1060 mbar

In the semi anechoic chamber, the following limits were not exceeded during the test.

Temperature	Min. = 15 °C Max. = 35 °C
Relative humidity	Min. = 30 % Max. = 75 %
Air pressure	Min. = 860 mbar Max. = 1060 mbar

In the chamber for conducted measurements, the following limits were not exceeded during the test:

Temperature	Min. = 15 °C Max. = 35 °C
Relative humidity	Min. = 30 % Max. = 60 %
Air pressure	Min. = 860 mbar Max. = 1060 mbar

Remarks and comments

The tests have been performed by the technical personnel: Sravani Gollamudi and Koji Nishimoto.

Testing verdicts

Not applicable :	N/A
Pass :	P
Fail :	F
Not measured :	N/M

Summary

FCC PART 24 /IC RSS-133 PARAGRAPH					
Report Section	FCC 24 Spec Clause	RSS Spec Clause	Test Description	Verdict	Remark
A.1	§2.1046 and §24.232	RSS-133 Clause 6.4	RF Output power	P	N/A
A.2	§2.1047	RSS-133 Clause 6.2	Modulation characteristics	P	N/A
A.3	§2.1055 and § 24.235	RSS-133 Clause 6.3	Frequency stability	P	N/A
A.4	§ 2.1049	RSS-133 Clause 2.3	Occupied Bandwidth	P	N/A
A.5	§2.1051 and §24.238	RSS-133 Clause 6.5	Spurious emissions at antenna terminals	P	N/A
A.6	§24.238	RSS-133 Clause 6.5	Spurious emissions at antenna terminals at Block edges	P	N/A
A.7	§2.1053 and §24.238	RSS-133 Clause 6.5	Radiated emissions	P	N/A
<u>Supplementary information and remarks:</u>					
N/A					

List of equipment used during the test

Conducted Measurements

CONTROL NUMBER	DESCRIPTION	LAST CALIBRATION	NEXT CALIBRATION
1039	Signal analyzer Rohde & Schwarz FSV40	2018/03	2020/03
1149	Wideband Radio Communication Tester Rohde & Schwarz CMW 500	2018/07	2020/07
1041	EMI Test Receiver Rohde & Schwarz ESR 7	2017/04	2019/03
101	Climatic chamber Espec	2019/10	2020/10

Radiated Measurements

CONTROL NUMBER	DESCRIPTION	LAST CALIBRATION	NEXT CALIBRATION
1179	Semi anechoic Absorber Lined Chamber Frankonia SAC 3 plus "L"	N/A	N/A
1064	BiconicalLog antenna ETS LINDGREN 3142E	2017/03	2020/03
1057	Double-ridge Waveguide Horn antenna 1-18 GHz	2017/03	2020/03
1012	Spectrum analyzer Rohde & Schwarz ESR26	2018/09	2020/09
1014	Spectrum analyzer Rohde & Schwarz FSV40	2017/03	2019/03
1015,1017, 1019, 1020	Rohde & Schwarz EMC32 software	N/A	N/A

Appendix A: Test Results for 2G

Appendix A Content

PRODUCT INFORMATION	12
DESCRIPTION OF TEST CONDITIONS	13
TEST A.1: RF OUTPUT POWER.....	14
TEST A.2: MODULATION CHARACTERISTICS	19
TEST A.3: FREQUENCY STABILITY	21
TEST A.4: OCCUPIED BANDWIDTH	23
TEST A.5: SPURIOUS EMISSIONS AT ANTENNA TERMINALS.....	30
TEST A.6: SPURIOUS EMISSIONS AT ANTENNA TERMINALS AT BLOCK EDGES.....	34
TEST A.7: RADIATED EMISSIONS.....	38

PRODUCT INFORMATION

The following information is provided by the client

Information	Description
Modulation	2G: GPRS, EDGE
Maximum RF Output Power	30 dBm
Operation mode:	
- Operating Frequency Range	Band 1900: 1850-1910 MHz
- Nominal Channel Bandwidth	Band 1900: 200 KHz
Extreme operating conditions	
- Temperature range	T _{nom} = +15 to + 35 T _{min} = -30 T _{max} = +50
Antenna type	External Antenna.
Antenna gain	2 dBi
Nominal Voltage	
- Supply Voltage	12 Vdc
- Type of power source	DC voltage from power supply.

DESCRIPTION OF TEST CONDITIONS

The worst case was found when positioned as the table below. Following channel(s) was (were) selected for the final test as listed below:

TEST CONDITIONS	DESCRIPTION										
TC#01 Band 1900	<p>Power supply (V): $V_{\text{nominal}} = 12 \text{ Vdc}$</p> <p><u>Test Frequencies for Conducted tests:</u></p> <ul style="list-style-type: none"> -Lowest Channel: 512 (1850.2 MHz) -Middle Channel: 662 (1880.2 MHz) -Highest Channel: 810 (1909.8 MHz) <p><u>Test Frequencies for Radiated tests:</u></p> <table border="1" data-bbox="413 1057 1224 1341"> <thead> <tr> <th data-bbox="413 1057 727 1158">Available Frequencies</th> <th data-bbox="727 1057 908 1158">Tested Frequency</th> <th data-bbox="908 1057 1066 1158">Channel Bandwidth</th> <th data-bbox="1066 1057 1224 1158">Modulation</th> </tr> </thead> <tbody> <tr> <td data-bbox="413 1158 727 1341" rowspan="3" style="text-align: center;">1850 to 1910 MHz</td> <td data-bbox="727 1158 908 1196" style="text-align: center;">1850.2 MHz</td> <td data-bbox="908 1158 1066 1341" rowspan="3" style="text-align: center;">200 KHz</td> <td data-bbox="1066 1158 1224 1341" rowspan="3" style="text-align: center;">GPRS</td> </tr> <tr> <td data-bbox="727 1196 908 1234" style="text-align: center;">1880.2 MHz</td> </tr> <tr> <td data-bbox="727 1234 908 1341" style="text-align: center;">1909.8 MHz</td> </tr> </tbody> </table> <p>Note: This device was tested under all channels and modulations. The worst case found in GPRS modulation.</p>	Available Frequencies	Tested Frequency	Channel Bandwidth	Modulation	1850 to 1910 MHz	1850.2 MHz	200 KHz	GPRS	1880.2 MHz	1909.8 MHz
Available Frequencies	Tested Frequency	Channel Bandwidth	Modulation								
1850 to 1910 MHz	1850.2 MHz	200 KHz	GPRS								
	1880.2 MHz										
	1909.8 MHz										

TEST A.1: RF OUTPUT POWER

LIMITS:	Product standard:	FCC Part 24 / IC RSS-133
	Test standard:	FCC §2.1046 and §24.232 / RSS-133 Clause 6.4

LIMITS

Fixed, mobile, and portable (hand-held) stations are limited to 2-watt EIRP (30 dBm). Fixed stations are limited to a maximum antenna height of 10 meters above ground. Mobile and portable stations operating in these bands must employ a means for limiting power to the minimum necessary for successful communications. The peak-to-average ratio (PAR) of the transmission shall not exceed 13 dB.

RSS-133 Clause 6.4

The equivalent isotropically radiated power (e.i.r.p.) for transmitters shall not exceed the limits given in SRSP-510. Moreover, base station transmitters operating in the band 1930-1995 MHz shall not have output power exceeding 100 watts.

In addition, the transmitter's peak-to-average power ratio (PAPR) shall not exceed 13 dB for more than 0.1% of the time using a signal corresponding to the highest PAPR during periods of continuous transmission.

TEST SETUP

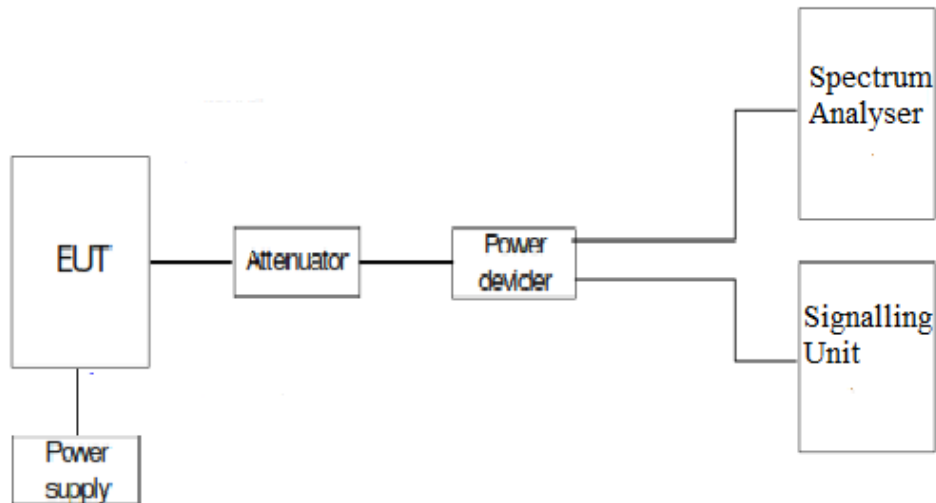

TESTED SAMPLES:	S/01
TESTED CONDITIONS MODES:	TC#01
TEST RESULTS:	PASS

GPRS Modulation:

Channel	Average power at antenna port (dBm)	Maximum declared antenna gain (dBi)	Maximum E.I.R.P. average power (dBm)	PAPR (dB)
Lowest	30.15	2.0	32.15	11.07
Middle	30.15	2.0	32.15	8.81
Highest	30.25	2.0	32.25	10.61
Measurement uncertainty (dB)			<±0.95	

Edge Modulation:

Channel	Average power at antenna port (dBm)	Maximum declared antenna gain (dBi)	Maximum E.I.R.P. average power (dBm)	PAPR (dB)
Lowest	22.13	2.0	24.13	7.51
Middle	21.57	2.0	23.57	9.10
Highest	22.53	2.0	24.53	9.45
Measurement uncertainty (dB)			<±0.95	

TEST RESULTS (Cont):

GPRS:

Lowest channel

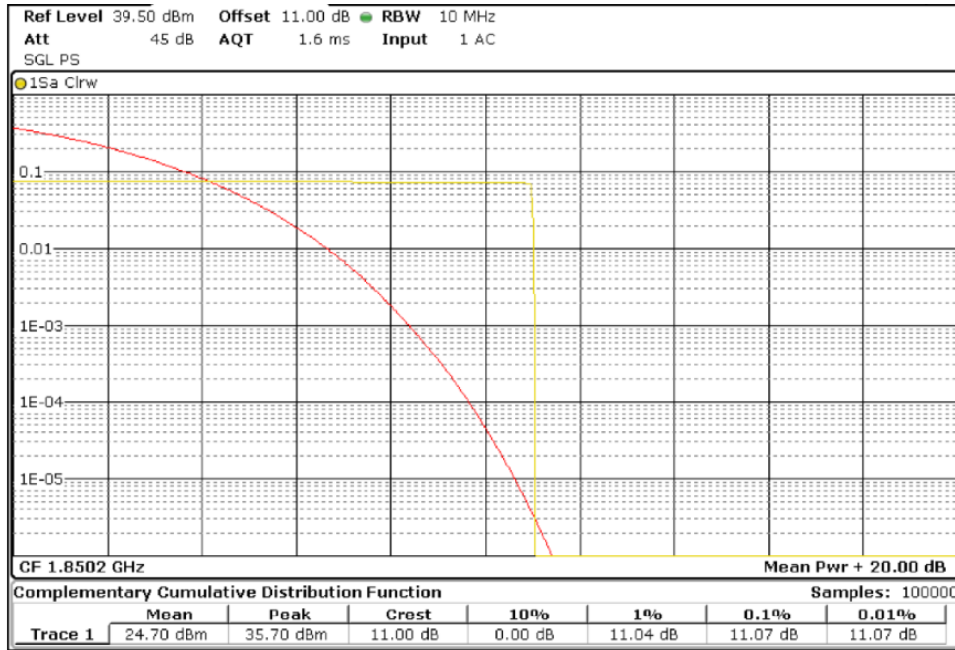

Middle channel

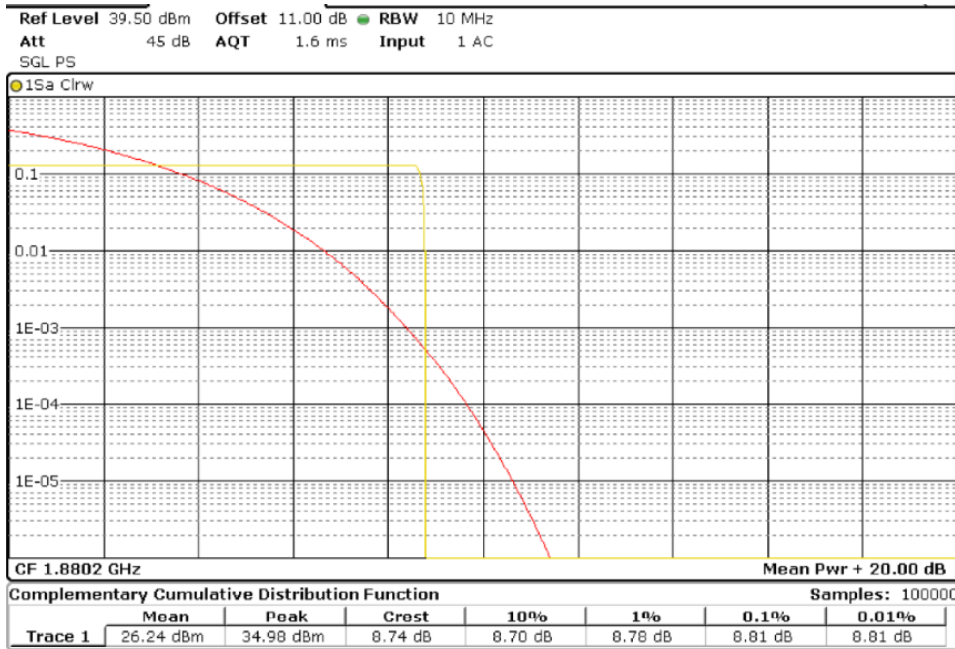

TEST RESULTS (Cont):

Highest channel

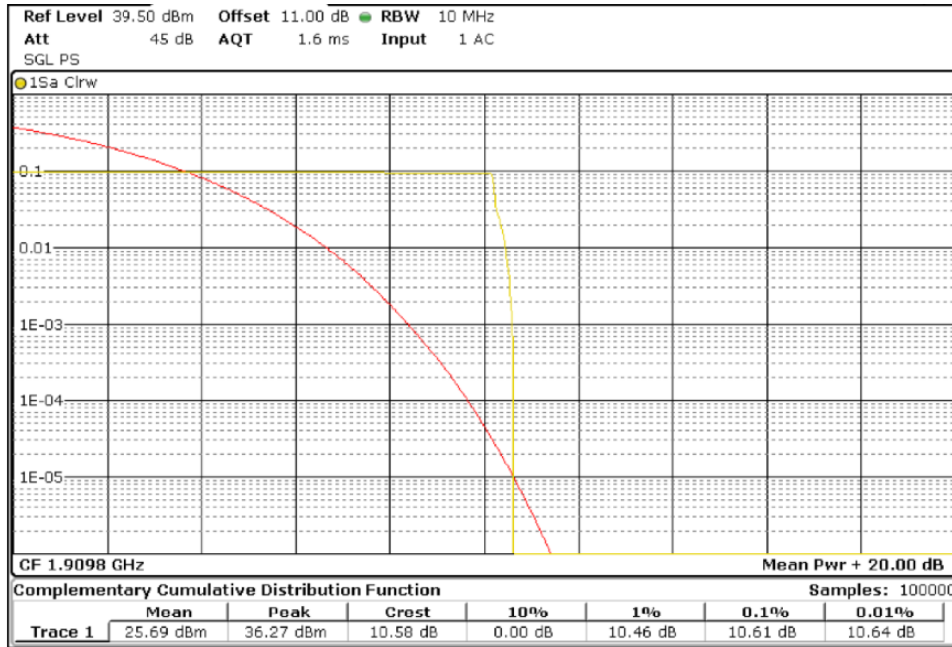

EDGE:

Lowest channel

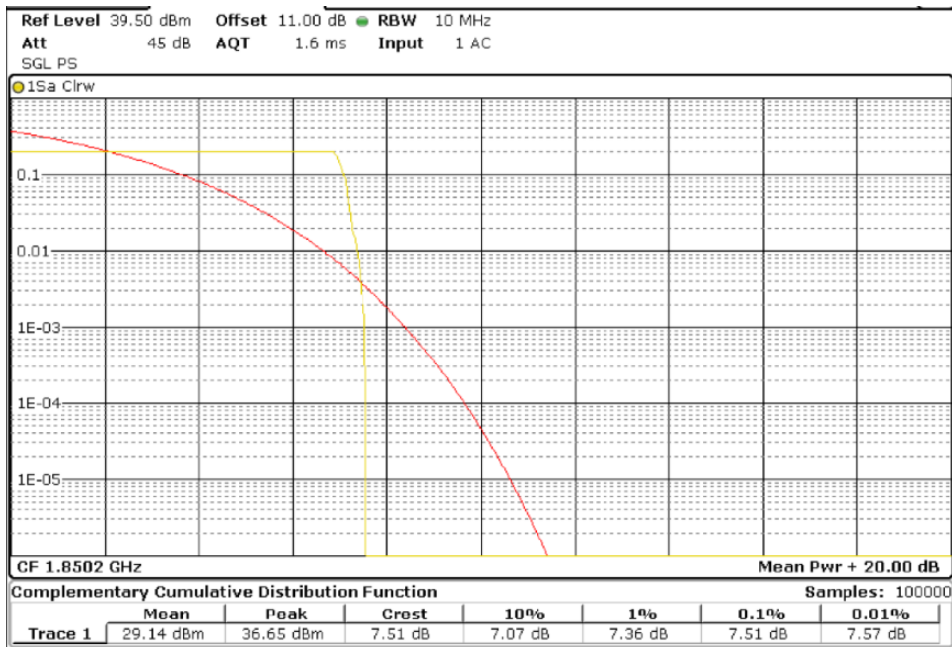

TEST RESULTS (Cont):

Middle channel

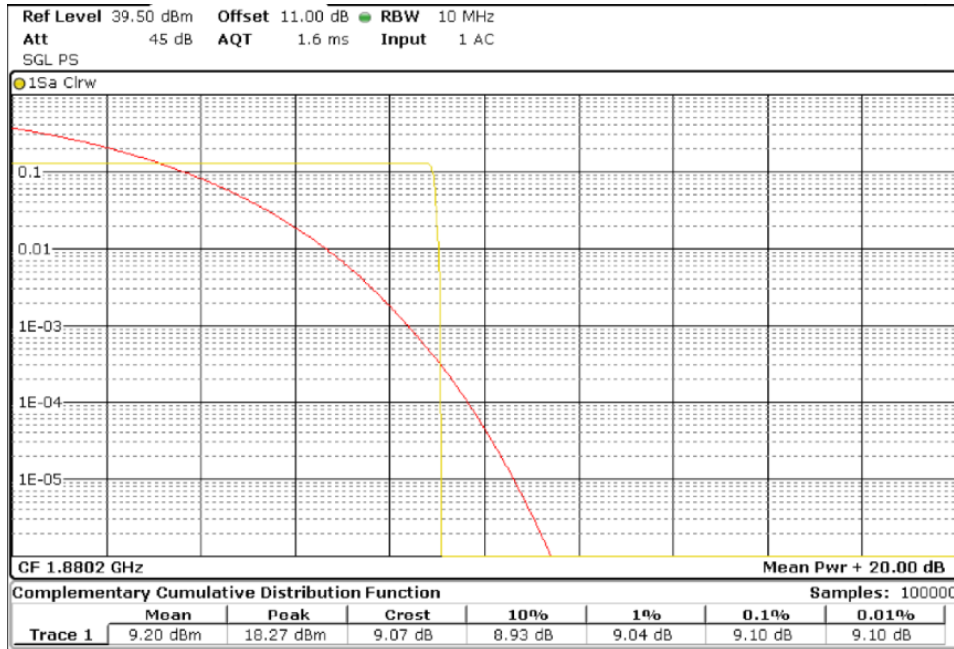

Highest channel

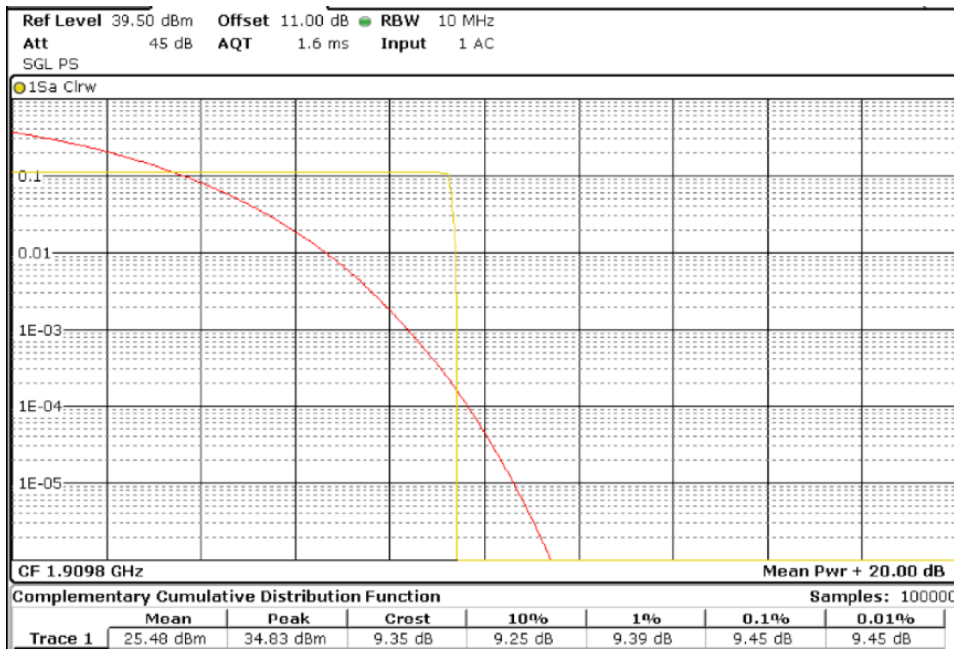

TEST A.2: MODULATION CHARACTERISTICS

LIMITS:	Product standard:	FCC Part 24 / IC RSS-133
	Test standard:	FCC §2.1047 / RSS-133 Clause 6.3

LIMITS

A curve or equivalent data which shows that the equipment will meet the modulation requirements of the rules under which the equipment is to be licensed.

The devices shall employ digital modulation techniques.

TEST SETUP

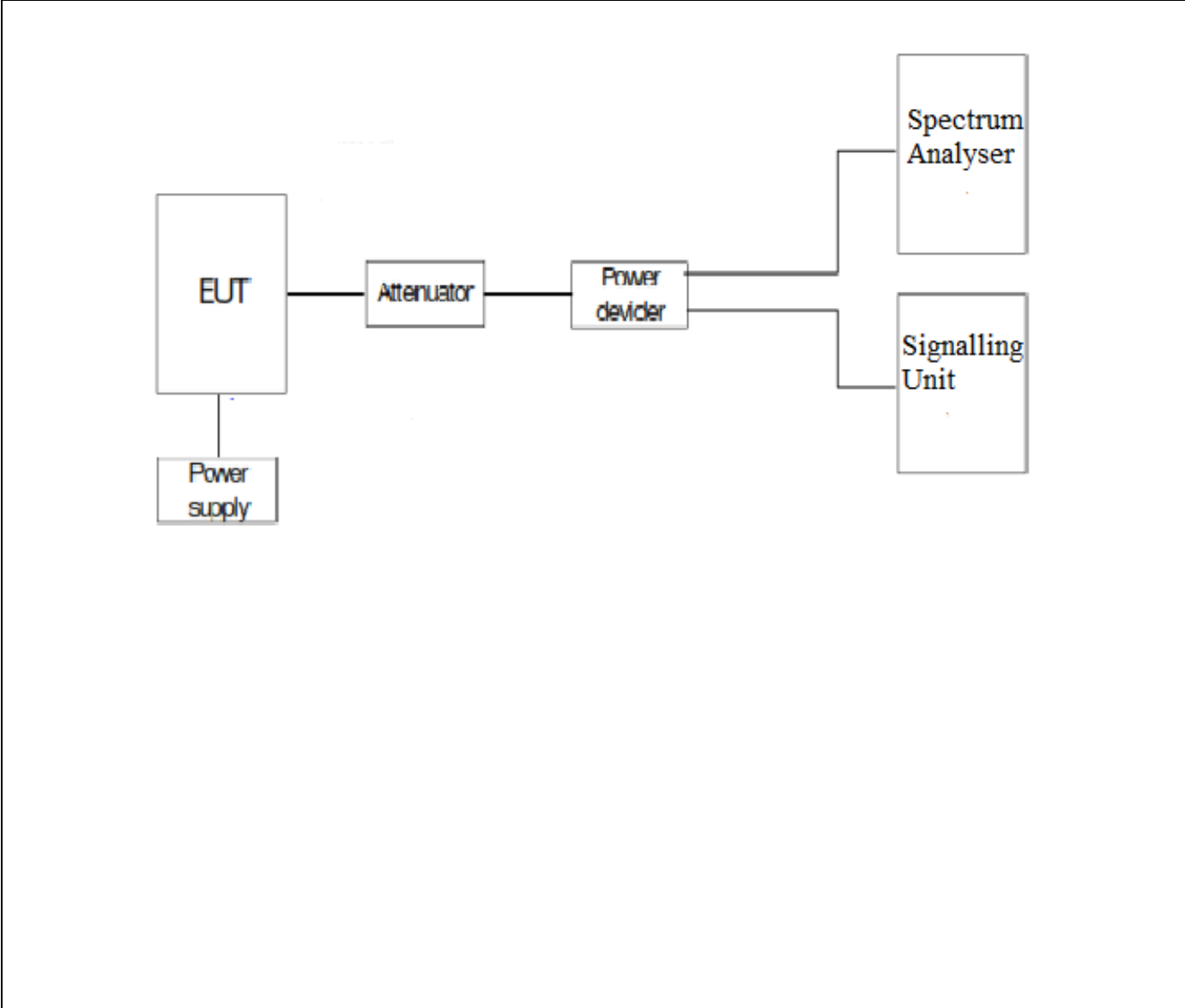

TESTED SAMPLES:	S/01
TESTED CONDITIONS MODES:	TC#01
TEST RESULTS:	PASS

GPRS Modulation

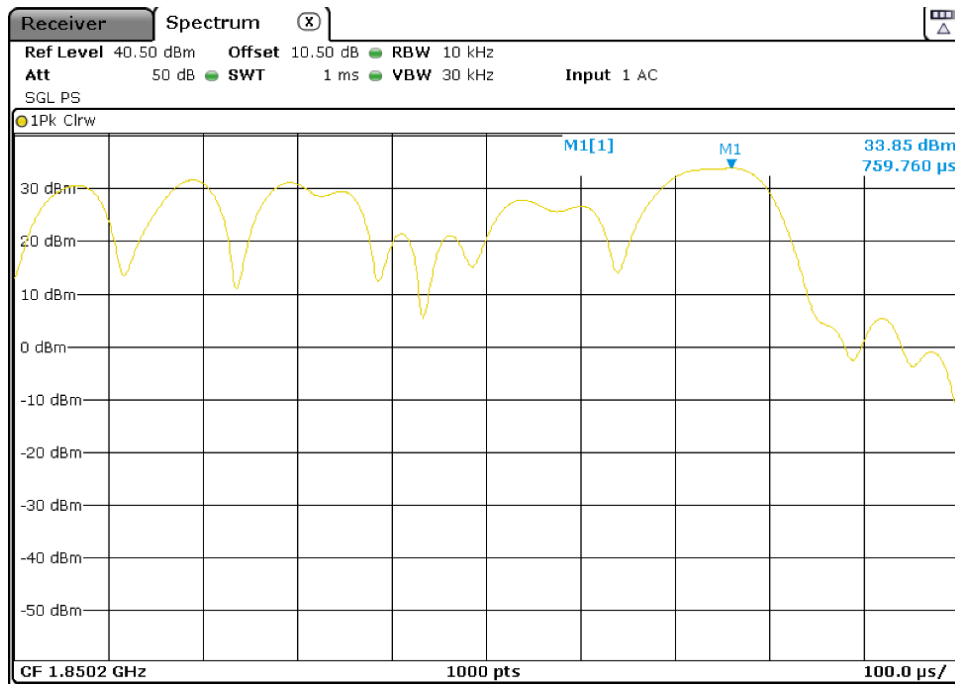

Edge Modulation

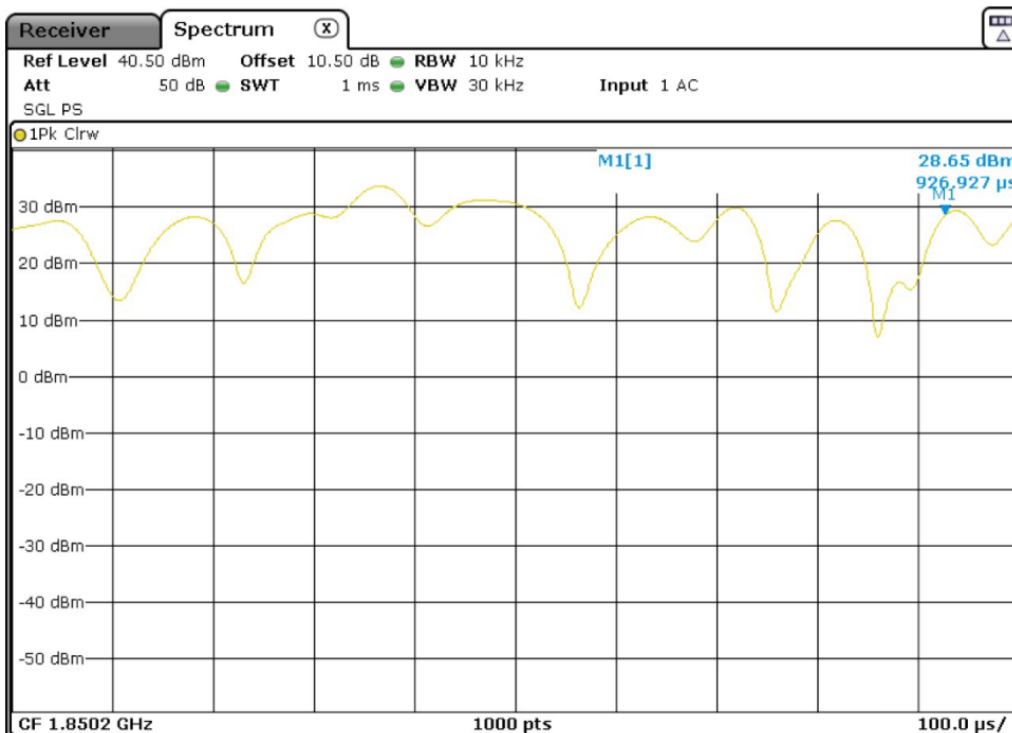

TEST A.3: FREQUENCY STABILITY

LIMITS:	Product standard:	FCC Part 24 / IC RSS-133
	Test standard:	FCC §2.1055 and § 24.235 / RSS-133 Clause 6.3

LIMITS

The frequency stability shall be enough to ensure that the fundamental emissions stay within the authorized bands of operation.

TEST SETUP

The frequency tolerance measurements over temperature variations were made over the temperature range of -30°C to $+50^{\circ}\text{C}$. The EUT was placed inside a climatic chamber and the temperature was raised hourly in 10°C steps from -30°C up to $+50^{\circ}\text{C}$.

The supply voltage was varied between 85% and 115% of nominal voltage.

The EUT was set in "call mode" in the middle channel using the Universal Radio Communication tester R&S CMW500 and the maximum frequency error was measured using the built-in calibrated frequency meter.

For LTE mode the QPSK modulation was used for the test as it is the worst case for conducted power.

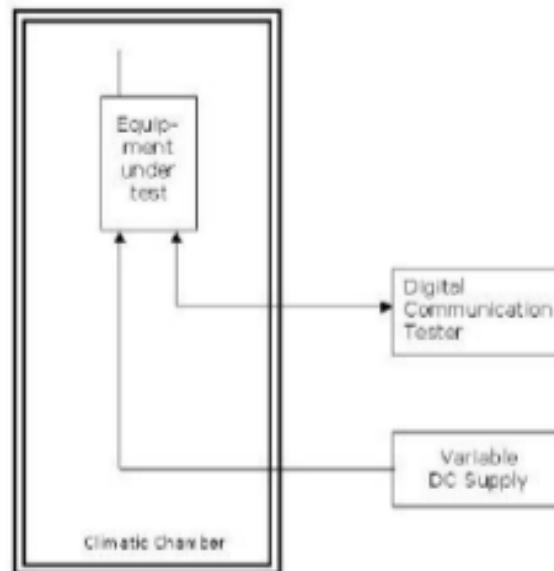

TESTED SAMPLES:	S/01
TESTED CONDITIONS MODES:	TC#01
TEST RESULTS:	PASS

GPRS MODULATION.

Frequency stability over temperature variations

Temperature (°C)	Frequency Error (Hz)	Frequency Error (ppm)	Frequency Error (%)
50	18.08	0.0096	0.00000096
40	25.7	0.0137	0.00000137
30	11.75	0.0062	0.00000062
20	19.76	0.0105	0.00000105
10	6.62	0.0035	0.00000035
0	30.06	0.0160	0.00000160
-10	46.85	0.0249	0.00000249
-20	25.18	0.0134	0.00000134
-30	41.36	0.0220	0.00000220

Frequency stability over voltage variations

Battery Supply voltage	Voltage (V)	Frequency Error (Hz)	Frequency Error (ppm)	Frequency Error (%)
Vmax	13.8	14.53	0.0077	0.00000077
Vmin	10.2	10.88	0.0058	0.00000058

TEST A.4: OCCUPIED BANDWIDTH

LIMITS:	Product standard:	FCC Part 24 / IC RSS-133
	Test standard:	FCC § 2.1049 / RSS-133 Clause 2.3

LIMITS

Reference only.

TEST SETUP

The occupied bandwidth measurement was performed at the output terminals of the EUT using an attenuator, power splitter and spectrum analyzer. The EUT was controlled via the Universal Radio Communication tester R&S CMW500 selecting maximum transmission power of the EUT and different modes of modulation. The 99% occupied bandwidth and the -26 dBc bandwidth were measured directly using the built-in bandwidth measuring option of spectrum analyzer.

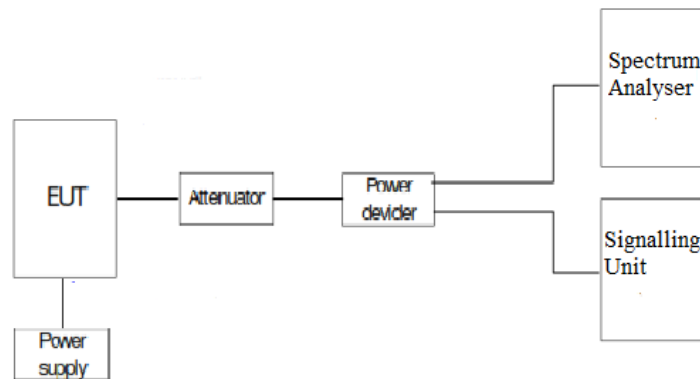

TESTED SAMPLES:	S/01
TESTED CONDITIONS MODES:	TC#01
TEST RESULTS:	PASS

GPRS MODULATION.

Channel	Lowest	Middle	Highest
99% Occupied bandwidth (kHz)	246.67	246.67	245.00
-26 dBc bandwidth (kHz)	318.40	322.70	319.80

EDGE MODULATION.

Channel	Lowest	Middle	Highest
99% Occupied bandwidth (kHz)	243.33	241.67	245.00
-26 dBc bandwidth (kHz)	318.40	322.70	316.90

TEST RESULTS (Cont):

GPRS MODULATION.

Lowest Channel 99% Occupied Bandwidth

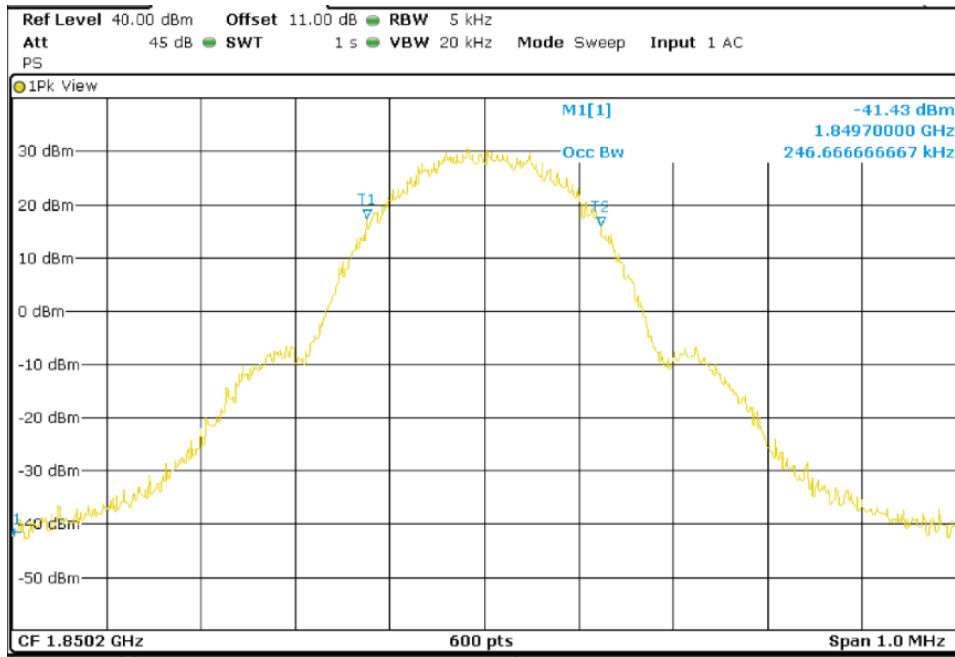

Lowest Channel -26dBc Bandwidth kHz

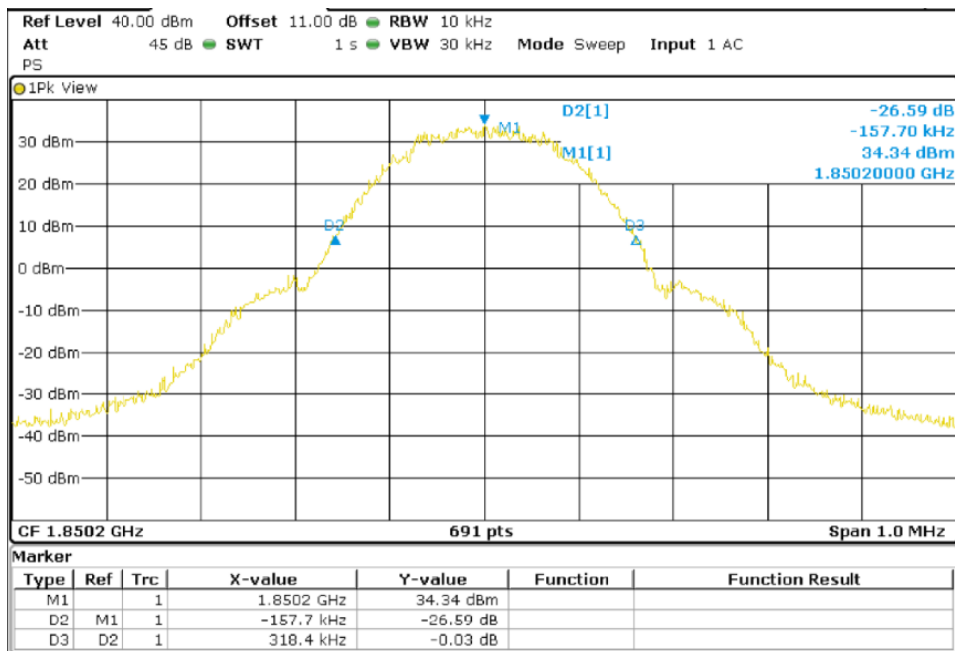

TEST RESULTS (Cont):

Middle Channel 99% Occupied Bandwidth

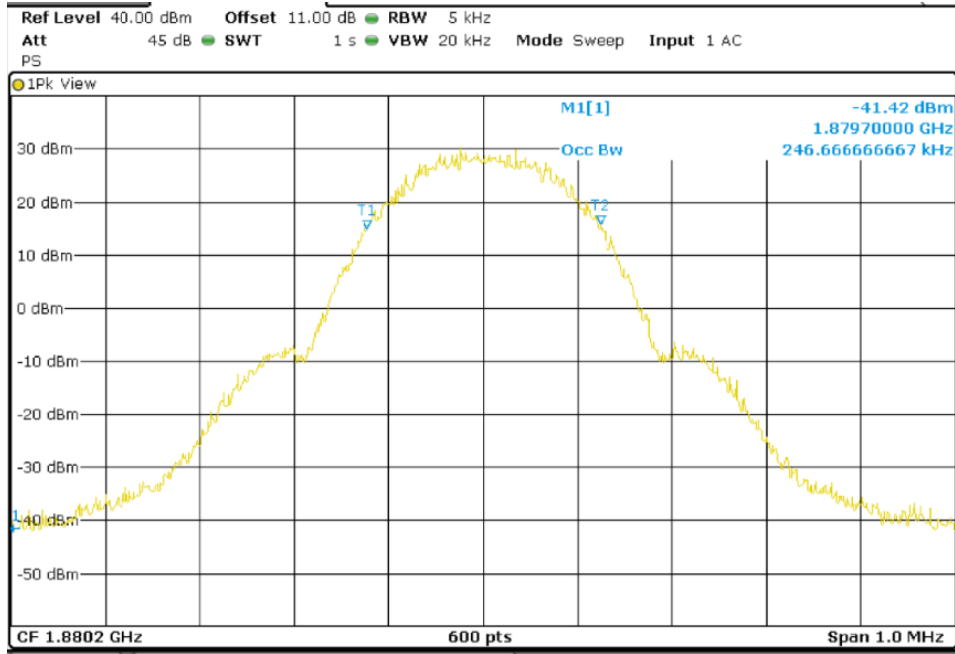

Middle Channel 26dBc Bandwidth kHz

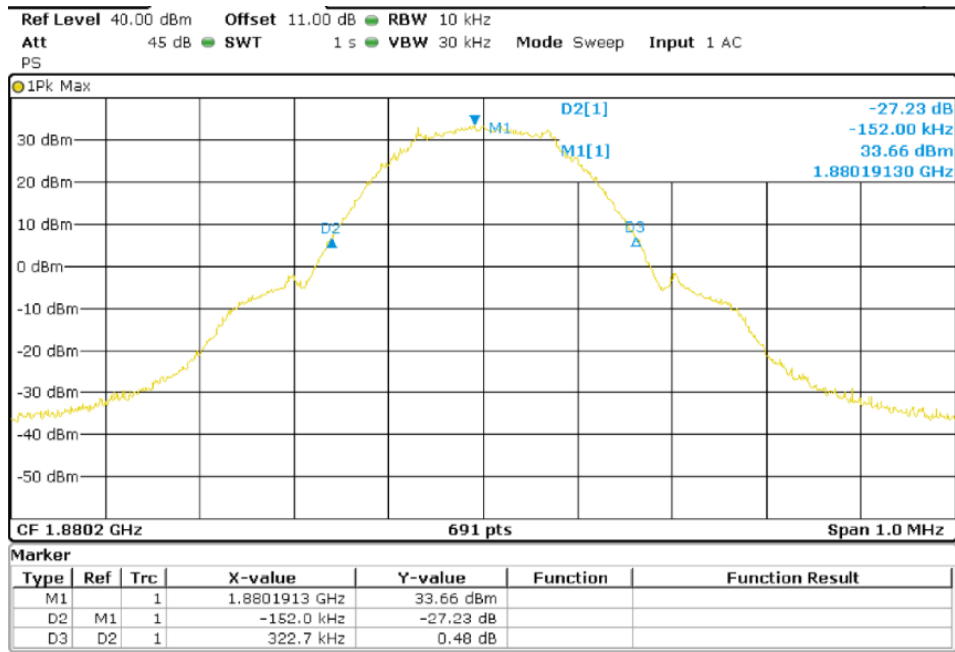

TEST RESULTS (Cont):

Highest Channel 99% Occupied Bandwidth

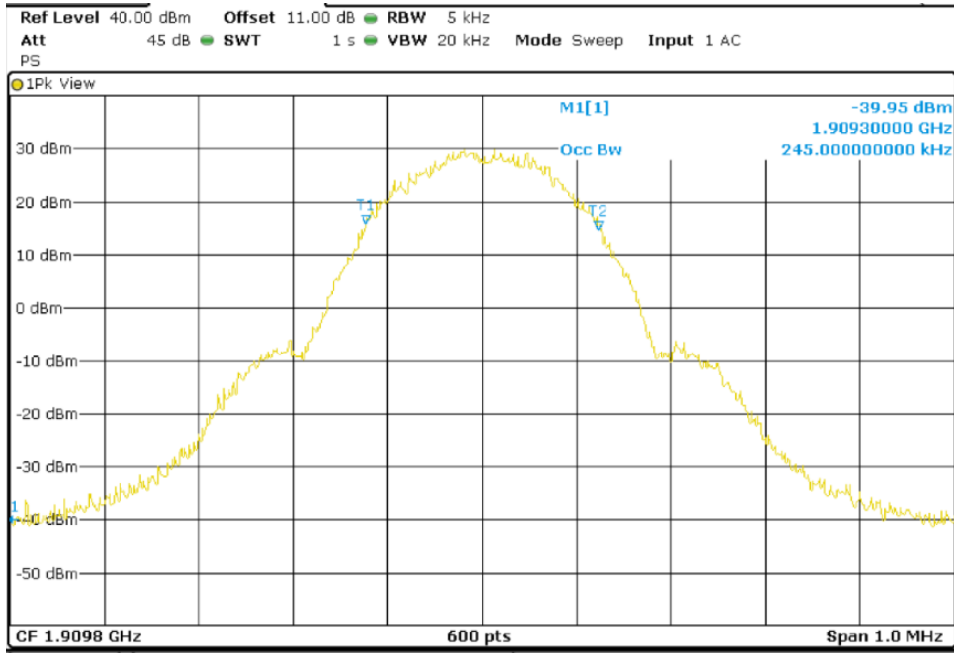

Highest Channel 26dBc Bandwidth kHz

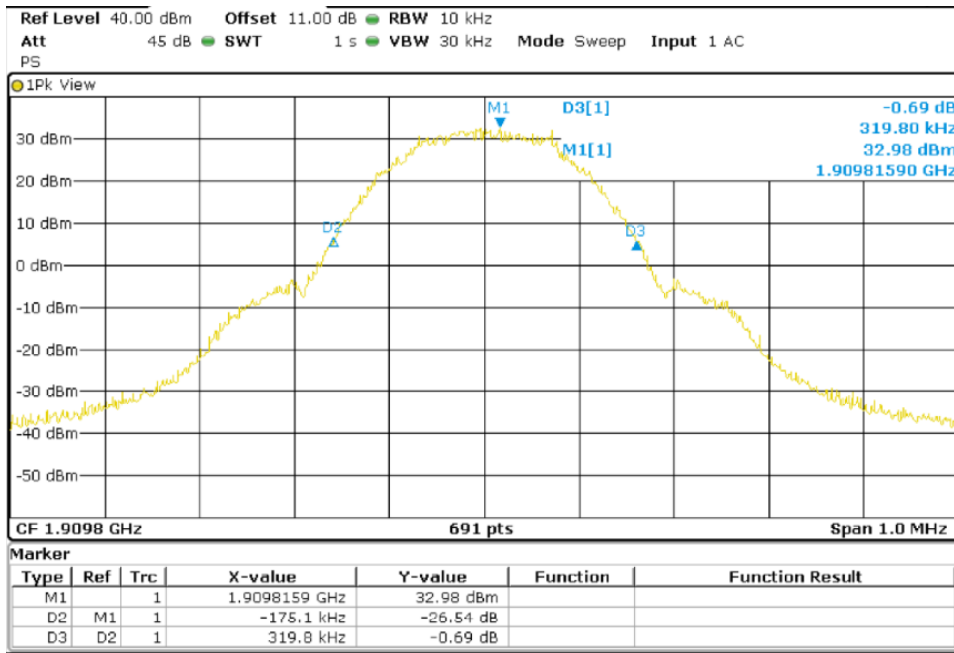

TEST RESULTS (Cont):

EDGE MODULATION.

Lowest Channel 99% Occupied Bandwidth

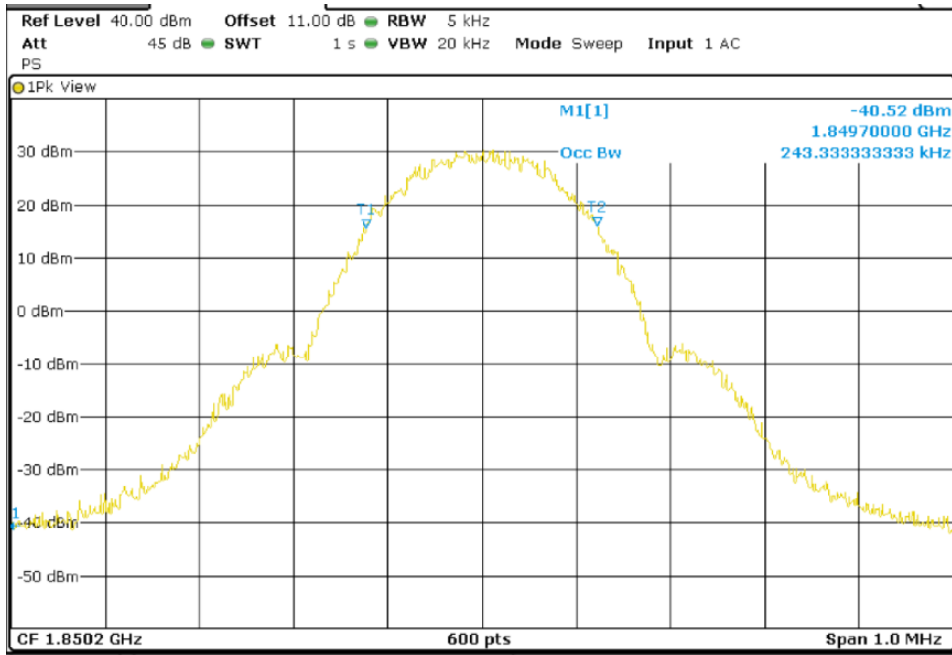

Lowest Channel -26dBc Bandwidth kHz

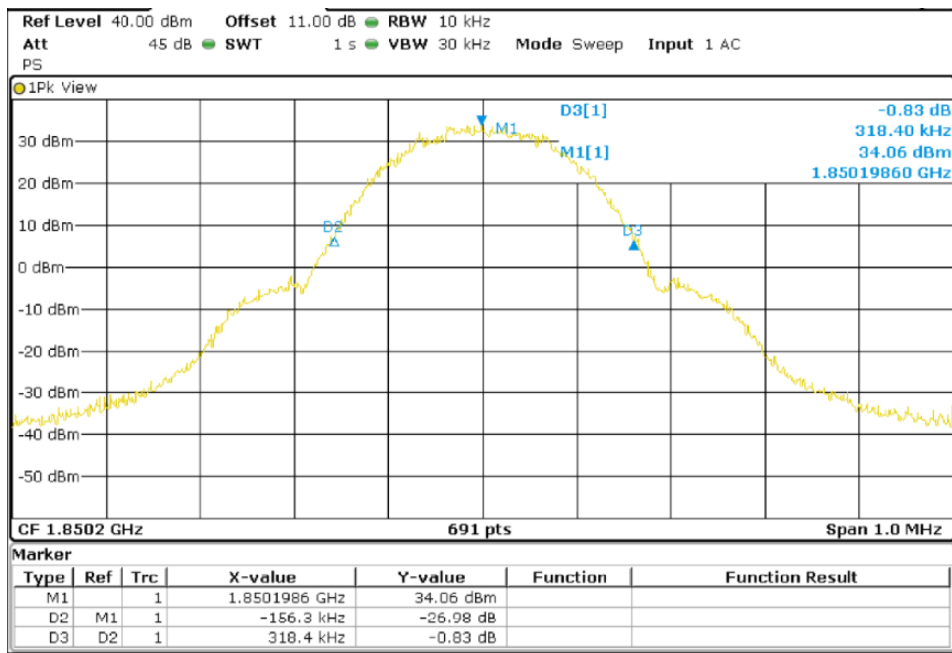

TEST RESULTS (Cont):

Middle Channel 99% Occupied Bandwidth

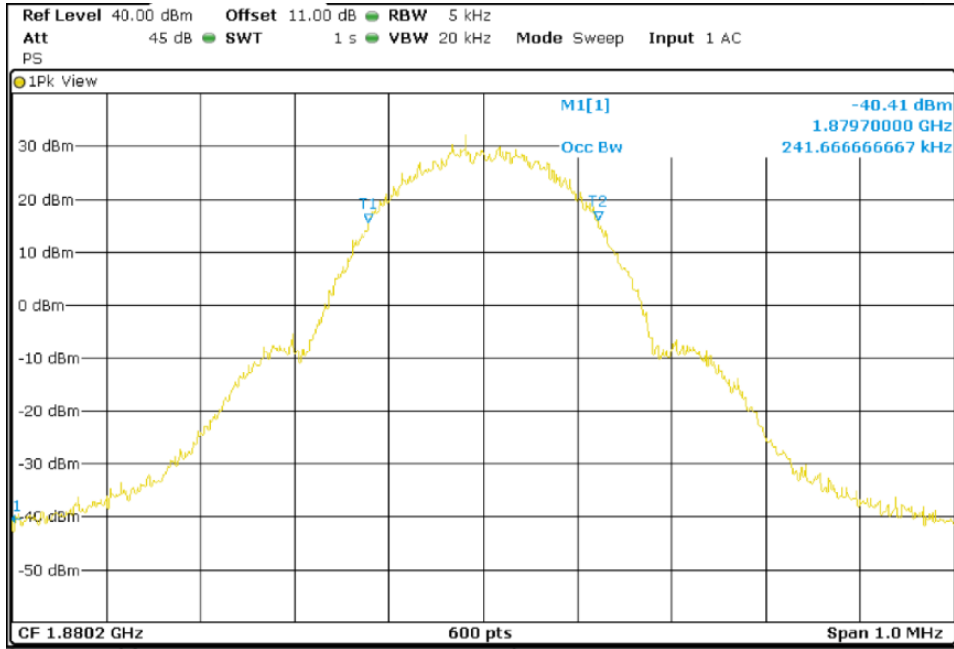

Middle Channel 26dBc Bandwidth kHz

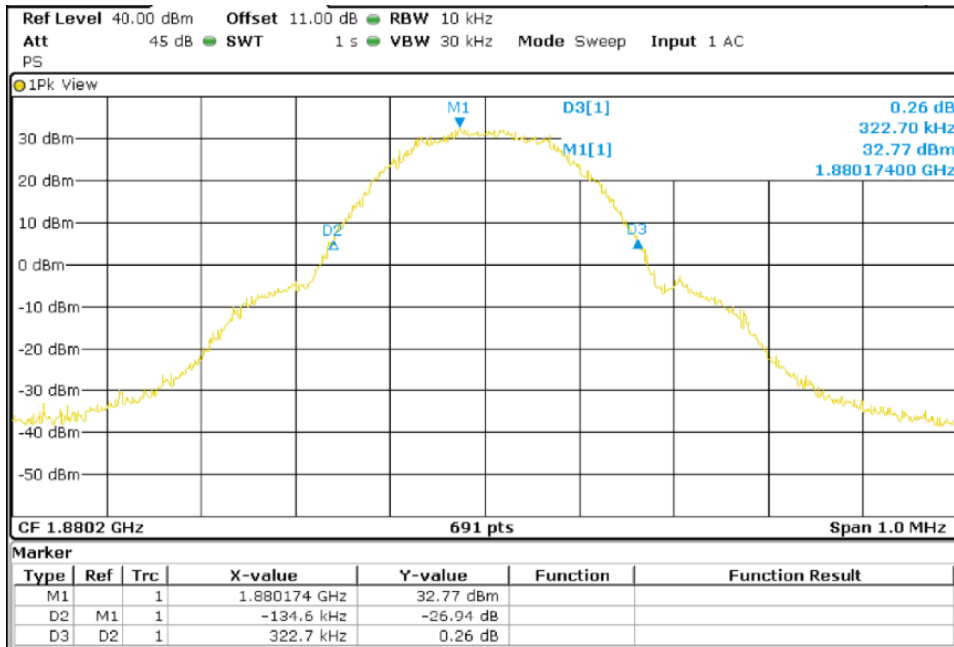

TEST RESULTS (Cont):

Highest Channel 99% Occupied Bandwidth

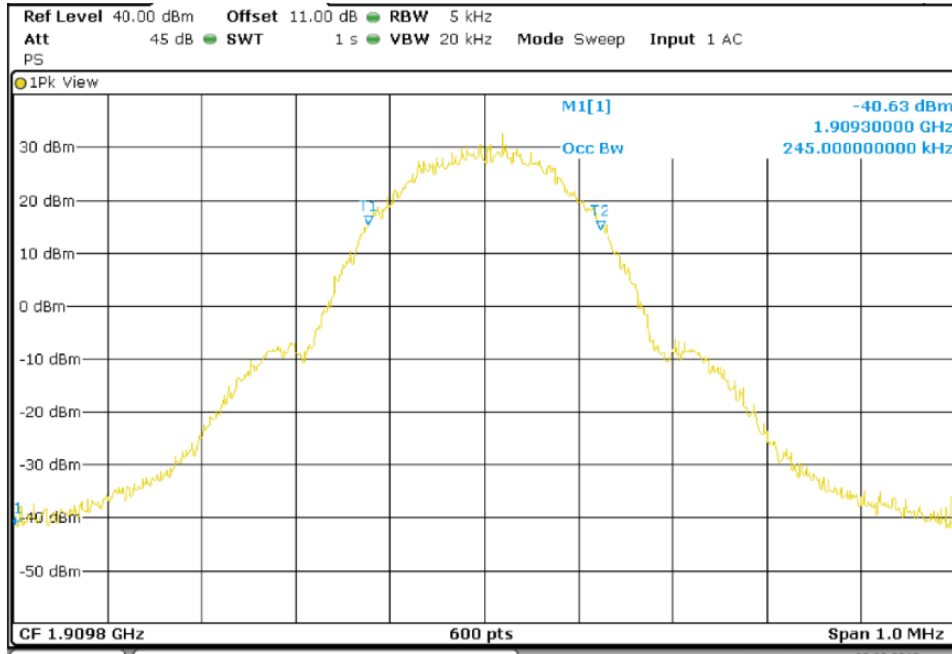

Highest Channel 26dBc Bandwidth kHz

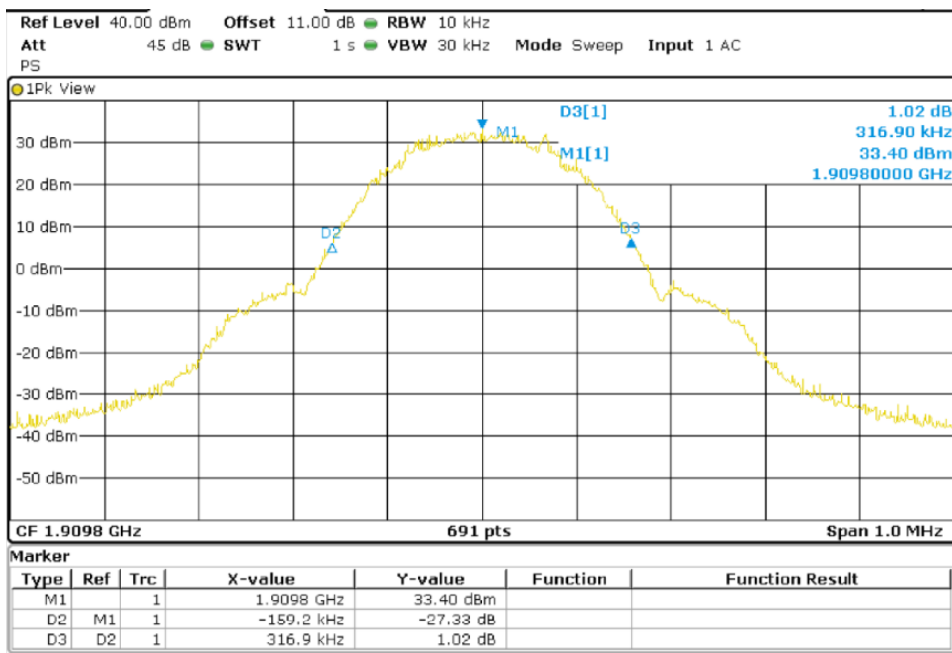

TEST A.5: SPURIOUS EMISSIONS AT ANTENNA TERMINALS

LIMITS:	Product standard:	FCC Part 24 / IC RSS-133
	Test standard:	FCC §2.1051 and § 24.238 / RSS-133 Clause 6.5

LIMITS

According to specification, the power of emissions shall be attenuated below the transmitter power (P) by a factor of at least $43 + 10 \log (P)$ dB. P in watts.

At P_o transmitting power of 2 watts (33 dBm), the specified minimum attenuation becomes $43+10\log (P_o)$. and the level in dBm relative to P_o becomes:

$$P_o \text{ (dBm)} - [43 + 10 \log (P_o \text{ in watts})] = -13 \text{ dBm}$$

TEST SETUP

The EUT RF output connector was connected to a spectrum analyzer and to the Universal Radio Communication Tester R&S CMW500 (selecting maximum transmission power of the EUT and different modes of modulation) using a 50-ohm attenuator and a power splitter.

The reading of the spectrum analyzer is corrected with the attenuation loss of connection between output terminal of EUT and input of the spectrum analyzer.

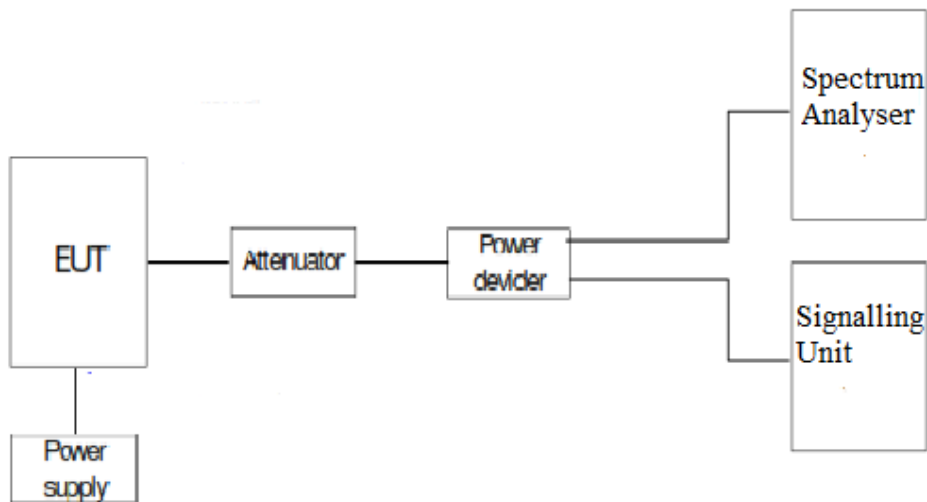

TESTED SAMPLES:	S/01
TESTED CONDITIONS MODES:	TC#01
TEST RESULTS:	PASS

Frequency range 9 KHz – 18 GHz

GPRS MODULATION.

Lowest Channel

No spurious signal was found at less than 10 dB respect to the limit in the frequency range.

Middle Channel

No spurious signal was found at less than 10 dB respect to the limit in the frequency range.

Highest Channel

No spurious signal was found at less than 10 dB respect to the limit in the frequency range.

TEST RESULTS (Cont):

Highest Channel

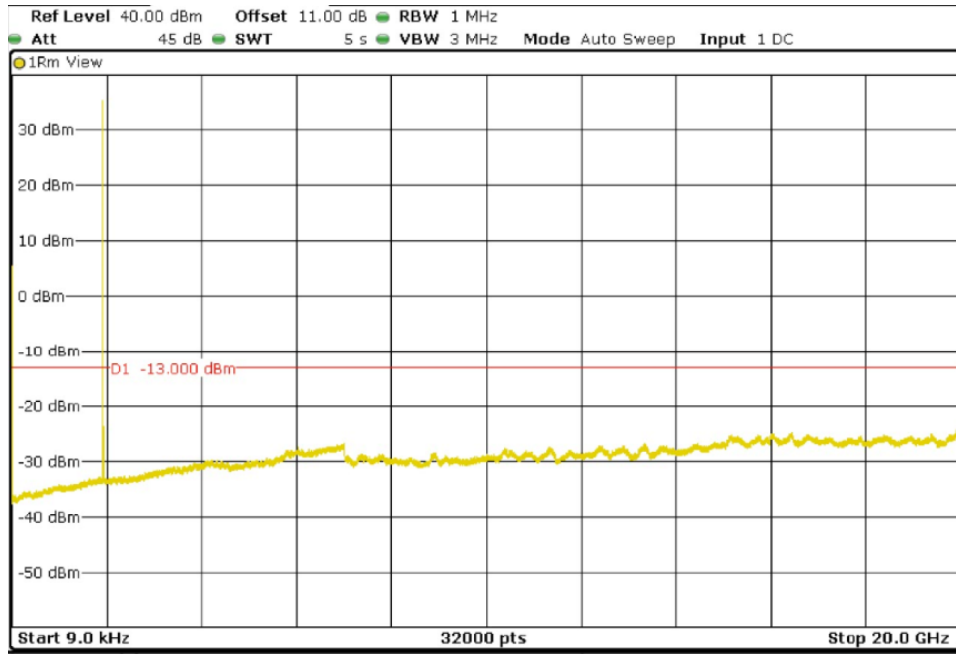

TEST A.6: SPURIOUS EMISSIONS AT ANTENNA TERMINALS AT BLOCK EDGES

LIMITS:	Product standard:	FCC Part 24 / IC RSS-133
	Test standard:	FCC § 24.238 / RSS 133- Clause 6.5

LIMITS

According to specification, the power of emissions shall be attenuated below the transmitter power (P) by a factor of at least $43 + 10 \log (P)$ dB. P in watts.

At P_o transmitting power of 2 watts (33 dBm), the specified minimum attenuation becomes $43+10\log (P_o)$. and the level in dBm relative to P_o becomes:

$$P_o \text{ (dBm)} - [43 + 10 \log (P_o \text{ in watts})] = -13 \text{ dBm}$$

TEST SETUP

The EUT RF output connector was connected to a spectrum analyzer and to the Universal Radio Communication Tester R&S CMW500 (selecting maximum transmission power of the EUT and different modes of modulation) using a 50 ohm attenuator and a power splitter.

The reading of the spectrum analyzer is corrected with the attenuation loss of connection between output terminal of EUT and input of the spectrum analyzer.

For LTE mode the configuration of modulation which is the worst case for conducted power was used.

As indicated in FCC part 24, in the 1 MHz bands immediately outside and adjacent to the licensee's frequency block or band, a resolution bandwidth of at least one percent of the emission bandwidth of the fundamental emission of the transmitter may be employed.

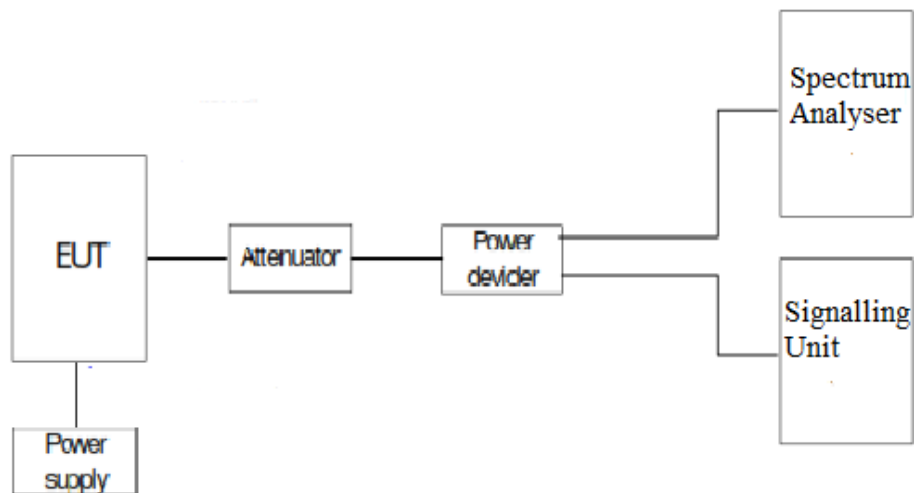

TESTED SAMPLES:	S/01
TESTED CONDITIONS MODES:	TC#01
TEST RESULTS:	PASS

GPRS MODULATION	RB=1 Offset =0 BW = 5 MHz	RB=1 Offset =0 BW = 10 MHz
Maximum measured level at lowest and Highest Block Edge at antenna port (dBm)	-21.93	-20.39

EDGE MODULATION	RB=25 Offset =0 BW = 5 MHz	RB=50 Offset =0 BW = 10 MHz
Maximum measured level at lowest and Highest Block Edge at antenna port (dBm)	-23.32	-24.52

TEST RESULTS (Cont):

GPRS MODULATION.

Lowest Channel

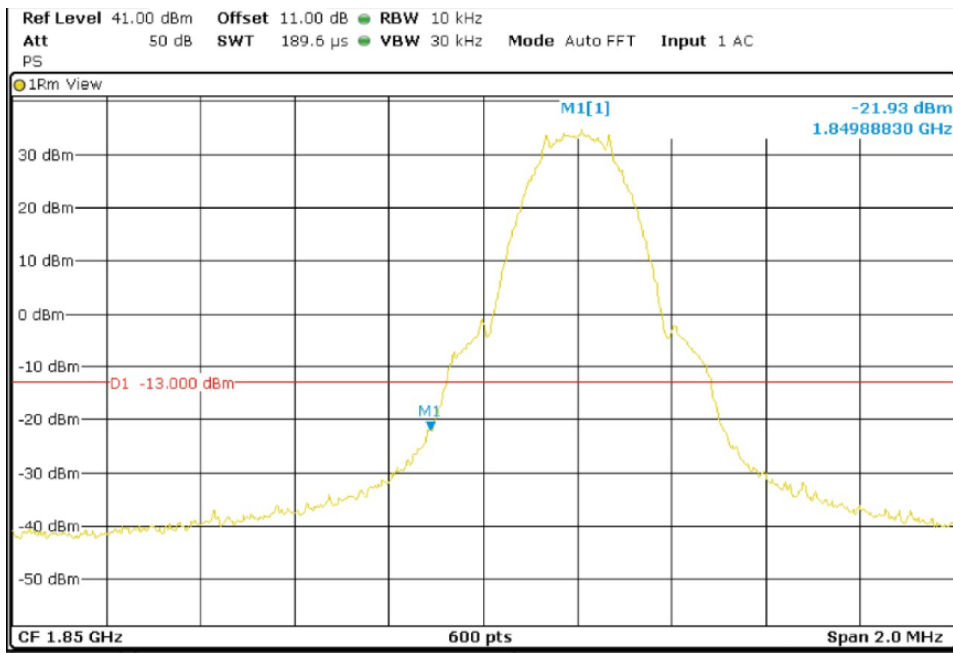

Highest Channel

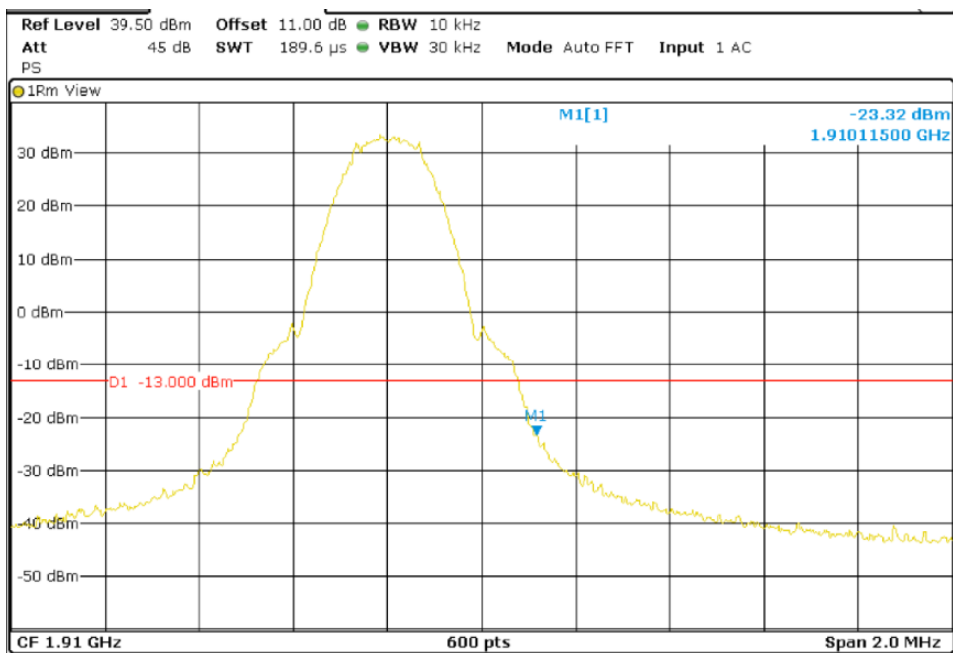

TEST RESULTS (Cont):

EDGE MODULATION.

Lowest Channel

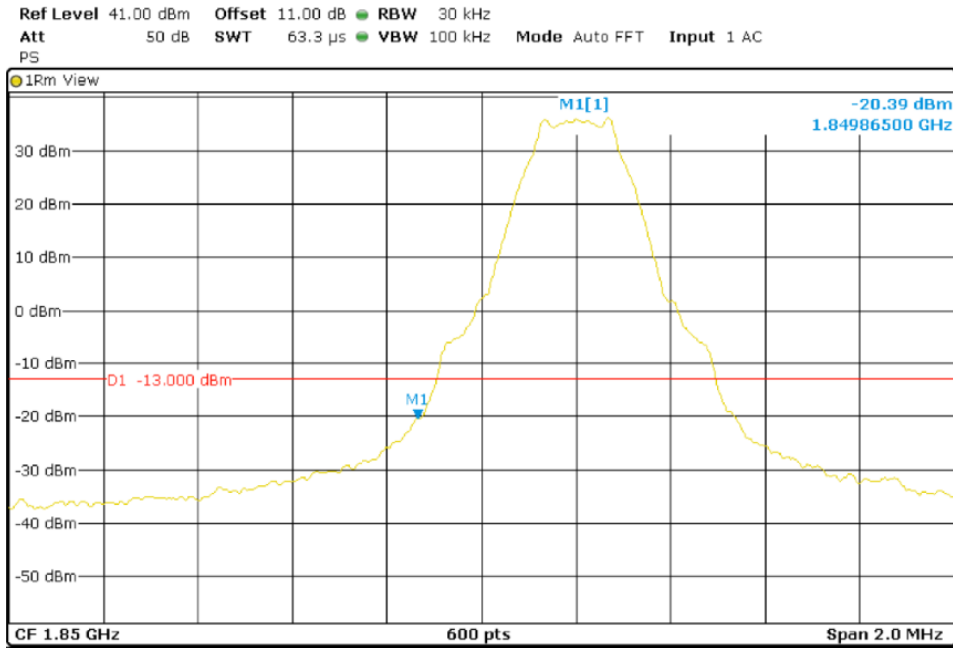

Highest Channel

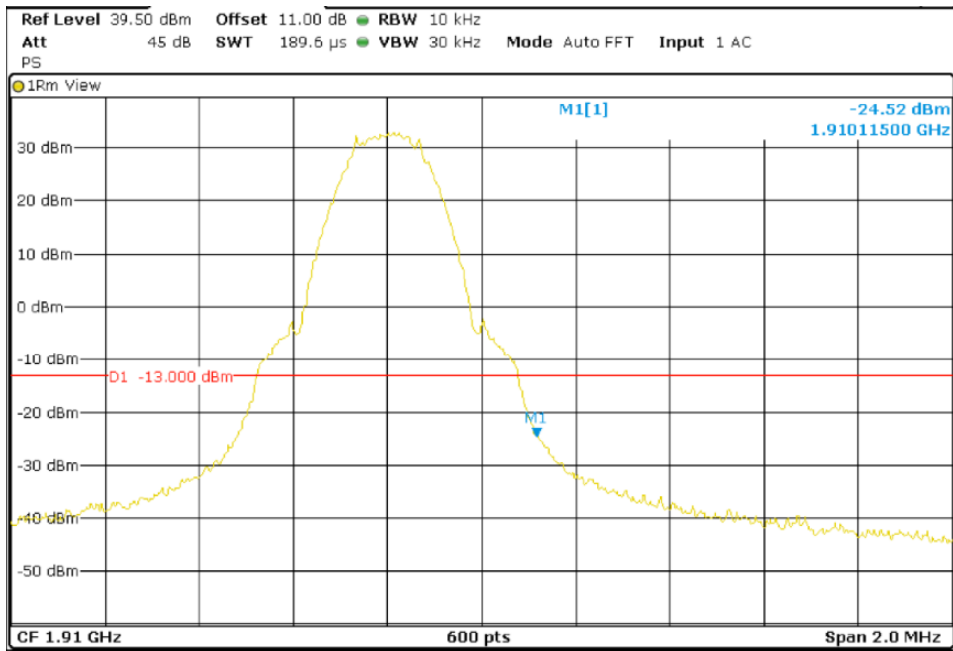

TEST A.7: RADIATED EMISSIONS

LIMITS:	Product standard:	FCC Part 24 / IC RSS-133
	Test standard:	FCC §2.1053 and §24.238 /RSS-133 Clause 6.5

LIMITS

According to specification, the power of emissions shall be attenuated below the transmitter power (P) by a factor of at least $43 + 10 \log (P)$ dB. P in watts.

At P_o transmitting power of 2 watts (33 dBm), the specified minimum attenuation becomes $43+10\log (P_o)$. and the level in dBm relative to P_o becomes:

$$P_o \text{ (dBm)} - [43 + 10 \log (P_o \text{ in watts})] = -13 \text{ dBm}$$

TEST SETUP

The measurement was performed with the EUT inside an anechoic chamber. The spectrum was scanned from 30 MHz to at least the 10th harmonic of the highest frequency generated within the equipment.

The EUT was placed on a non-conductive stand at a 3-meter distance from the measuring antenna for measurements below 1 GHz and at 1-meter distance for measurements above 1 GHz.

Detected emissions were maximized at each frequency by rotating the EUT and adjusting the measuring antenna height and polarization. The maximum reading was recorded.

Radiated measurements < 1GHz

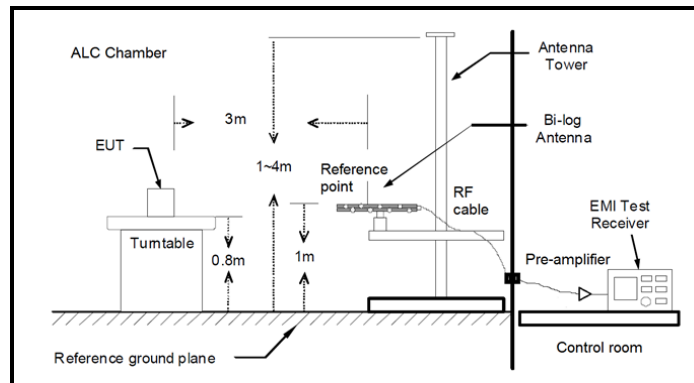

Radiated measurements > 1GHz

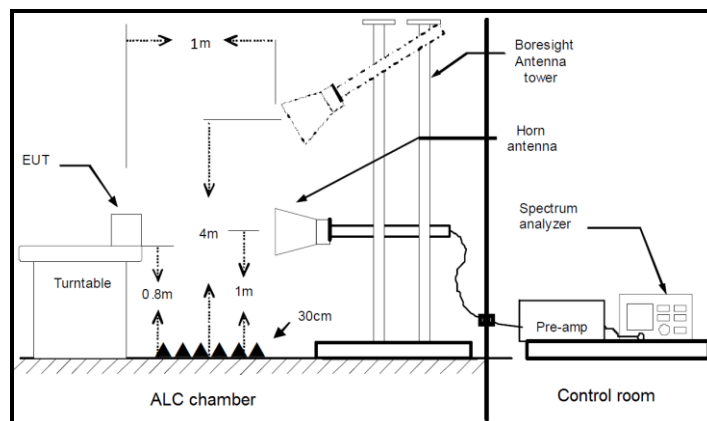

TESTED SAMPLES:	S/01
TESTED CONDITIONS MODES:	TC#01
TEST RESULTS:	PASS

A preliminary scan determined the GPRS Modulation as the worst case.

The following plots show the results for this configuration.

No spurious signal was found at less than 20dB respect to the limit in all the frequency ranges.

TEST RESULTS (Cont):	Low Channel
-----------------------------	-------------

FREQUENCY RANGE: 30-1000 MHz

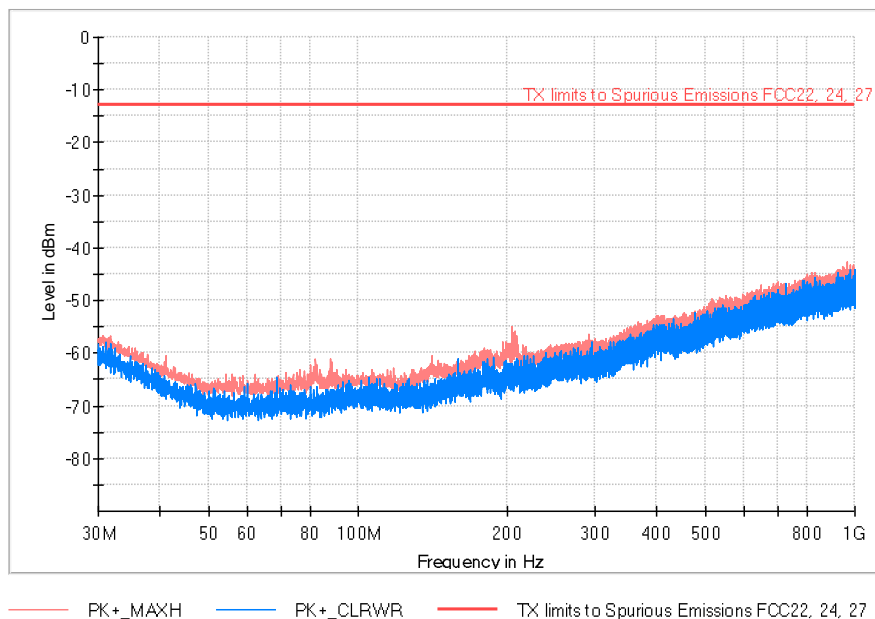

TEST RESULTS (Cont):

Low Channel

FREQUENCY RANGE: 1-18 GHz

Frequency (MHz)	PK+ _CLRWR (dBm)	PK+ _MAXH (dBm)	Comment
1948.000000	-29.58	-27.02	

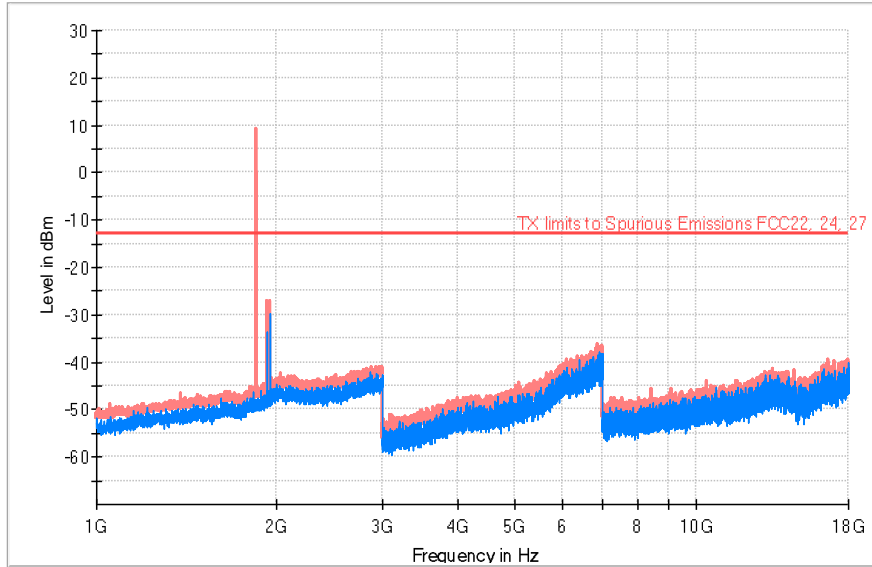

PK+_MAXH PK+_CLRWR TX limits to Spurious Emissions FCC22, 24, 27

FREQUENCY RANGE: 18-20 GHz

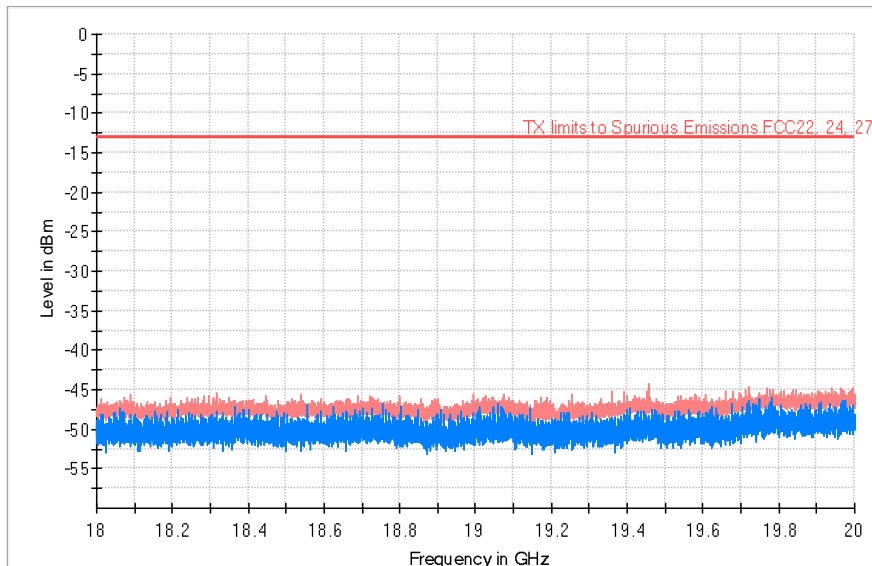

PK+_MAXH PK+_CLRWR TX limits to Spurious Emissions FCC22, 24, 27

TEST RESULTS (Cont):

Mid Channel

FREQUENCY RANGE: 30MHz -1 GHz

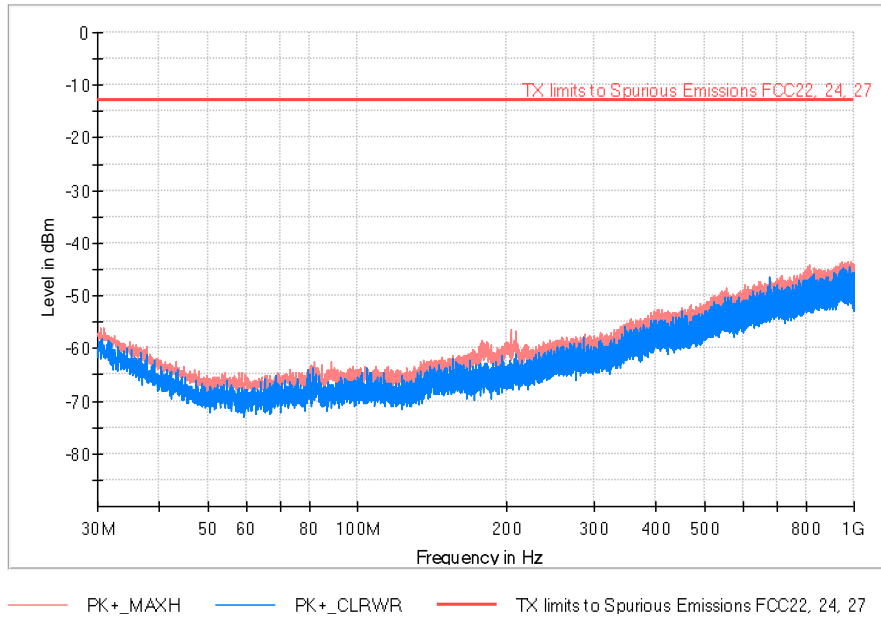

TEST RESULTS (Cont):

Mid Channel

FREQUENCY RANGE: 1-18 GHz

Frequency (MHz)	PK+ _CLRWR (dBm)	PK+ _MAXH (dBm)	Comment
1947.500000	-29.88	-27.45	Fundamental

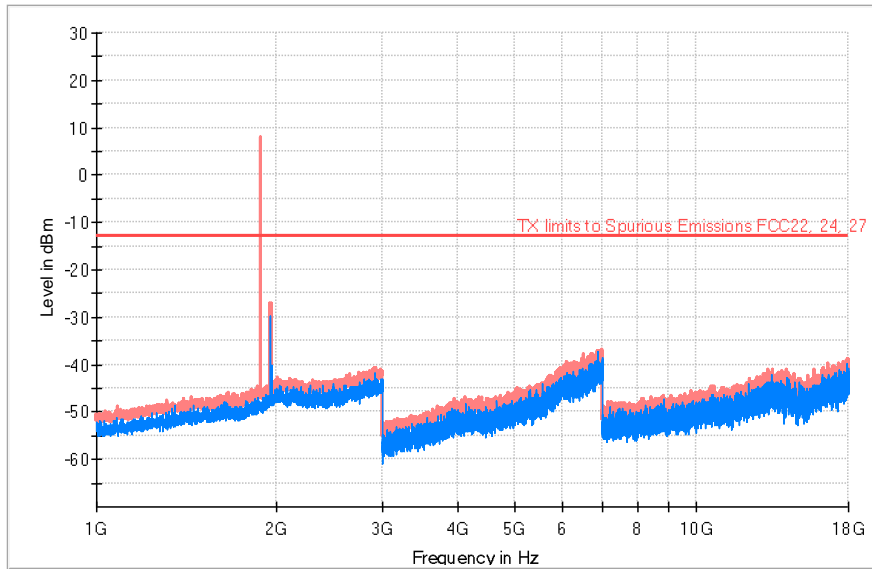

PK+ _MAXH PK+ _CLRWR TX limits to Spurious Emissions FCC22, 24, 27

FREQUENCY RANGE: 18-20 GHz

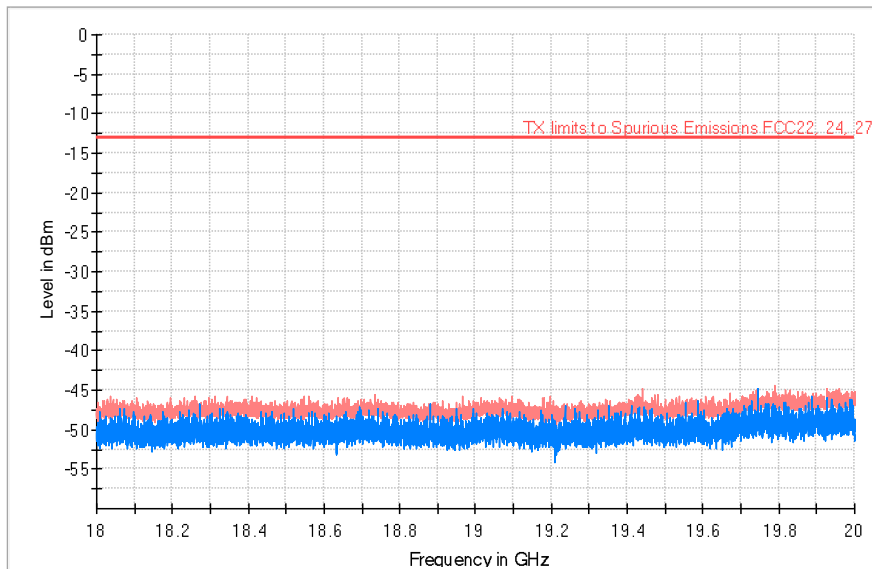

PK+ _MAXH PK+ _CLRWR TX limits to Spurious Emissions FCC22, 24, 27

TEST RESULTS (Cont):

High Channel

FREQUENCY RANGE: 30MHz-1 GHz

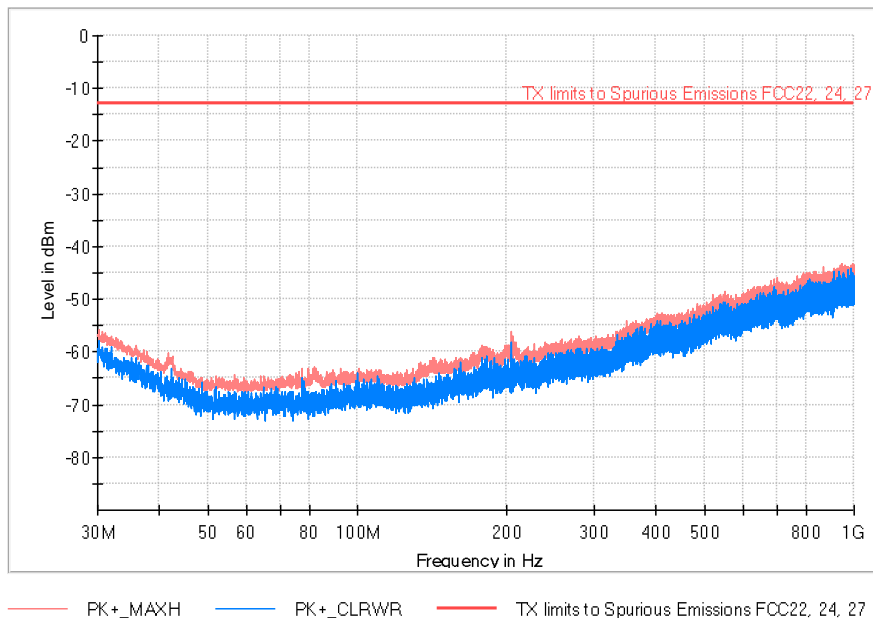

TEST RESULTS(Cont.):	High Channel		
FREQUENCY RANGE: 1-18 GHz			
Frequency (MHz)	PK+_CLRWR (dBm)	PK+_MAXH (dBm)	Comment
1948.000000	-29.04	-27.04	
<p>— PK+_MAXH — PK+_CLRWR — TX limits to Spurious Emissions FCC22, 24, 27</p>			
FREQUENCY RANGE: 18-20 GHz			
<p>— PK+_MAXH — PK+_CLRWR — TX limits to Spurious Emissions FCC22, 24, 27</p>			

Appendix B: Test Results for 3G

Appendix B Content

PRODUCT INFORMATION	47
DESCRIPTION OF TEST CONDITIONS	48
TEST B.1: RF OUTPUT POWER.....	49
TEST B.2: MODULATION CHARACTERISTICS	53
TEST B.3: FREQUENCY STABILITY	55
TEST B.4: OCCUPIED BANDWIDTH	57
TEST B.5: SPURIOUS EMISSIONS AT ANTENNA TERMINALS.....	61
TEST B.6: SPURIOUS EMISSIONS AT ANTENNA TERMINALS AT BLOCK EDGES.....	65
TEST B.7: RADIATED EMISSIONS.....	68