

RTS RIM Testing Services	Document Hearing Aid Compatibility RF Emissions Test Report for BlackBerry® Smartphone Model RBS21CW		Page 1(28)
	Author Data Daoud Attayi	Dates of Test 06 June , 21-22 Aug , 2007	Report No RTS-0736-0708-15 Rev1

Hearing Aid Compatibility RF Emissions Test Report

Testing Lab:

RIM Testing Services (RTS)
305 Phillip Street
Waterloo, Ontario
Canada N2L 3W8
Phone: 519-888-7465
Fax: 519-880-8173

Applicant:

Research In Motion Limited
295 Phillip Street
Waterloo, Ontario
Canada N2L 3W8
Phone: 519-888-7465
Fax: 519-888-6906
Web site: www.rim.com

Statement of Compliance: RIM Testing Services (RTS) declares that the product was tested in accordance with the appropriate measurement standards, guidelines and recommended practices.

This wireless portable device has been shown to be in compliance with FCC 20.19 (10-1-05 Edition), Hearing Aid-Compatible Mobile Handsets and FCC Public Notice DA 06-1215 (June 6, 2005).

Signatures

Date

Tested by:

Shahriar Ninad
Compliance Specialist



22-Aug-2007

Tested and documented by:

Daoud Attayi
Senior Compliance Specialist



20-Sep-2007

Reviewed and approved by:

Paul G. Cardinal, Ph.D.
Director



05-Sep-2007

This Rev1 test report supersedes the previous version RTS-0736-0708-15 dated 27-Aug, 2007

RTS RIM Testing Services	Document Hearing Aid Compatibility RF Emissions Test Report for BlackBerry® Smartphone Model RBS21CW		Page 2(28)
	Author Data Daoud Attayi	Dates of Test 06 June , 21-22 Aug , 2007	Report No RTS-0736-0708-15 Rev1

CONTENTS

1.0 Introduction	<u>3</u>
2.0 Applicable references	<u>4</u>
3.0 Equipment unit tested	<u>4</u>
3.1 Picture of Handheld	<u>5</u>
3.2 Handheld description	<u>5</u>
3.3 Batteries	<u>5</u>
3.4 Antenna description	<u>6</u>
4.0 List of test equipment	<u>6</u>
5.2 Near-Field RF Emission	<u>11</u>
5.3 Wireless Device Audio Band Magnetic Signal Test.....	<u>14</u>
6.0 Summary of results.....	<u>15</u>
6.1 Conclusion	<u>17</u>
7.0 Measurement uncertainty	<u>18</u>
7.1 Site-Specific Uncertainty.....	<u>19</u>

Annex A: Measurement plots and data

A.1 Spectrum analyser plots: CW, 80% AM and CDMA signals

A.2 Dipole validation and probe modulation factor plots

 Justification of step size and interpolation

A.3 RF emission field plots

Annex B: Probe and dipole descriptions and calibration certificates

B.1 Probe and measurement chain descriptions and specifications

B.2 Probe and dipole calibration certificates

Annex C: Test set up photos

RTS RIM Testing Services	Document Hearing Aid Compatibility RF Emissions Test Report for BlackBerry® Smartphone Model RBS21CW		Page 3(28)
	Author Data Daoud Attayi	Dates of Test 06 June , 21-22 Aug , 2007	Report No RTS-0736-0708-15 Rev1

1.0 Introduction

This test report documents the measurement of the near electric and magnetic fields generated by a wireless communication device in the region where a hearing aid would be used. The measurement procedures of ANSI C63.19-2006 were followed along with the guidance provided by the FCC at the May 2005 TCBC workshop with the document "Hearing Aid Compatibility: RF Emissions Measurements TCB Review Guidance, 12 May 2005" and Oct. 2006.

The electric and magnetic fields from a wireless device are scanned using a SPEAG DASY4 automated system with HAC extension and free-space probes (ER3DVx and H3DVx) in a 5cm x 5cm area, 10mm above the wireless device's acoustic output and the nearest point of the probe element. The area is divided into 9 sub-grids and the maximum values of the electrical and a magnetic field scans are evaluated automatically according to the rules defined in the standard and the device is assigned a certain category. Should the wireless device's maximum T-Coil output occur in a location other than the centre of acoustic output, then the RF field scans are repeated with the measurement area centered on the maximum T-Coil output.

The DASY4 HAC Extension consists of the following parts: the Test Arch phantom, three validation dipoles, dipole and DUT holders, magnetic and electric field probes and DASY4 software. The field probes and measurement electronics are described in Annex B.1.

The specially designed Test Arch allows high precision positioning of both the device and any of the validation dipoles. The broadband dipoles are calibrated at a single frequency and are used for system performance checks.

In order to correlate the usability of a hearing aid with a wireless device (WD), the WD's radio frequency (RF) and audio band emissions are measured. ANSI C63.19 requires:

- Radio frequency (RF) measurements of the near-field electric and magnetic fields emitted by a WD in the vicinity of the audio output to categorize these emissions for correlation with the RF immunity of the microphone mode of operation of a hearing aid.
- Audio frequency magnetic field measurements of a WD emitted in the vicinity of the audio output to categorize these emissions for correlation with the T-Coil mode of operation of a hearing aid.

Hence, the following measurements are made for the WDs:

1. RF E-Field emissions.
2. RF H-Field emissions.
3. T-Coil mode, magnetic signal strength in the audio band.
4. T-Coil mode, magnetic signal and noise articulation index.
5. T-Coil mode, magnetic signal frequency response through the audio band.
6. RF T-Coil environment: The worst case M rating from E or H field 5x5 cm area scan centered at the axial T-coil highest peak location.

RTS RIM Testing Services	Document Hearing Aid Compatibility RF Emissions Test Report for BlackBerry® Smartphone Model RBS21CW		Page 4(28)
	Author Data Daoud Attayi	Dates of Test 06 June , 21-22 Aug , 2007	Report No RTS-0736-0708-15 Rev1

2.0 Applicable references

[1] ANSI C63.19-2006, American National Standard for Methods of Measurement of Compatibility between Wireless Communication Devices and Hearing Aids.

[2] FCC 47CFR § 20.19 (10-1-05 Edition), Hearing Aid-Compatible Mobile Handsets.

[3] FCC Public Notice DA 06-1215 (June 6, 2006).

[4] SPEAG DASY4 V4.7 user manual, June 2006.

[5] Hearing Aid Compatibility: RF Emissions Measurements TCB Review Guidance, 12 May 2005.

[6] FCC Hearing Aid Compatibility Guidance, Oct. 2006

RTS RIM Testing Services	Document Hearing Aid Compatibility RF Emissions Test Report for BlackBerry® Smartphone Model RBS21CW		Page 5(28)
	Author Data Daoud Attayi	Dates of Test 06 June , 21-22 Aug , 2007	Report No RTS-0736-0708-15 Rev1

3.0 Equipment unit tested

3.1 Picture of device

Please refer to Annex C.

Figure 1. BlackBerry Smartphone

3.2 Device description

Device Model	RBS21CW		
FCC ID	L6ARBS20CW		
PIN	301A1F2E		
Prototype or Production Unit	Production		
Mode(s) of Operation	CDMA 800	CDMA 1900	* Bluetooth
Maximum conducted RF Output Power	24.50 dBm	23.50 dBm	-4.0 dBm
Tolerance in Power Setting on centre channel	± 0.50 dB	± 0.50 dB	N/A
Duty Cycle	1:1	1:1	1:1
Transmitting Frequency Range (MHz)	824.70-848.31 MHz	1851.25-1908.75 MHz	2402-2483 MHz

Table 1. Test device characterization

* For this product, a headset is the only Bluetooth application. Therefore, HAC RF Emission or Audio Band Magnetic (ABM) T-Coil testing are not applicable to Bluetooth.

RTS RIM Testing Services	Document Hearing Aid Compatibility RF Emissions Test Report for BlackBerry® Smartphone Model RBS21CW		Page 6(28)
	Author Data Daoud Attayi	Dates of Test 06 June , 21-22 Aug , 2007	Report No RTS-0736-0708-15 Rev1

3.3 Antenna description

Type	Internal fixed antenna
Location	Bottom back centre
Configuration	Internal fixed antenna

Table 2. Antenna description

4.0 List of test equipment

Manufacturer	Test Equipment	Model Number	Serial Number	Calibration Due Date
SCHMID & Partner Engineering AG	Data Acquisition Electronics (DAE3)	DAE3 V1	472	03/07/2008
SCHMID & Partner Engineering AG	3-Dimensional E-Field Probe for Near-Field	ER3DV6	2285	03/12/2008
SCHMID & Partner Engineering AG	3-Dimensional H-Field Probe for Near-Field	H3DV6	6105	11/15/2007
Rohde & Schwarz	Wireless Communication Test Set	CMU 200	109747	11/29/2007
Agilent	Spectrum Analyzer	8563E	3745A08112	09/20/2007
SCHMID & Partner Engineering AG	Validation Dipole	CD 835 V3	1011	12/05/2007
SCHMID & Partner Engineering AG	Validation Dipole	CD 1880 V3	1008	12/06/2007
Agilent Technologies	Signal generator	8360B	3844A00927	09/28/2007
Agilent Technologies	Power meter	E4419B	GB40202821	11/27/2007
Agilent Technologies	Power sensor	8481A	MY41095417	09/15/2007
Amplifier Research	Amplifier	5S1G4M3	300986	CNR

Table 3. List of test equipment

RTS RIM Testing Services	Document Hearing Aid Compatibility RF Emissions Test Report for BlackBerry® Smartphone Model RBS21CW		Page 7(28)
	Author Data Daoud Attayi	Dates of Test 06 June , 21-22 Aug , 2007	Report No RTS-0736-0708-15 Rev1

5.0 Measurement procedures

5.1 System Validation

The test setup should be validated when first configured and verified periodically thereafter to ensure proper function. The procedure consists of two parts: dipole validation and determination of probe modulation factor.

5.1.1 Dipole Validation

The HAC validation dipole antenna serves as a known source for an electrical and magnetic RF output. Figure 2 shows the setup used for the dipole validation.

1. The dipole antenna was placed in the position normally occupied by the WD.
2. The dipole was energized with a 20 dBm un-modulated continuous-wave signal.
3. The length of the dipole was scanned with both E-field and H-field probes and the maximum value for each scan was recorded.
4. The readings were compared with the values provided by the probe manufacturer and were found to agree within the allowed tolerance of 10%. Please refer to Annex A.2 for Dipole Validation Plots.

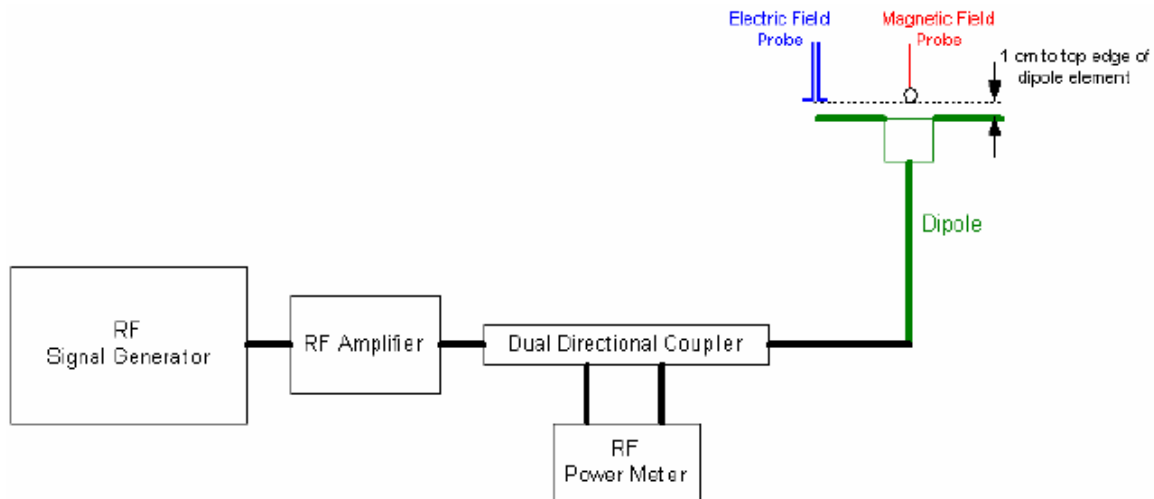

Figure 2: Dipole Validation Procedure

5.1.2 RF Field Probe Modulation Factor

The Probe Modulation Factor (PMF) characterizes the responses of the E-field and H-field probes and their instrumentation chain to a modulated signal. The PMF is the ratio of the responses to fields produced by CW and modulated signals having equal peak amplitude.

Three test cases are recommended. The real or emulated WD (Wireless device) modulated signal, an unmodulated (CW) and an 80% AM RF signal shall be used for each relevant

RTS RIM Testing Services	Document Hearing Aid Compatibility RF Emissions Test Report for BlackBerry® Smartphone Model RBS21CW		Page 8(28)
	Author Data Daoud Attayi	Dates of Test 06 June , 21-22 Aug , 2007	Report No RTS-0736-0708-15 Rev1

frequency band. Each of the test cases below shall be measured with both E_ and H_Field probe.

a) Measurement of real and emulated signal

- Set a WD or emulated signal source to apply full power into the reference dipole.
- Measure both the peak and average input power applied to the antenna and record the values using the following test instructions for measuring the RF interference of a modulated signal. Spectrum analyzer set up:

RBW ≥ emission bandwidth

Video Bandwidth ≥ 20 KHz

Span: Zero

Center Frequency: Nominal center of frequency channel

Amplitude: Linear (logarithmic scale may be used)

Detection: Peak detection

Trigger: Video or IF trigger

Sweep rate: sufficiently rapid to permit the complete pulse to be resolved accurately.

- Using near-field measurement system, scan the antenna over the appropriately sized area and record the greatest average power reading observed.

b) Measurement of CW and AM

- Set the RF signal generator for CW or 80 % AM and set the output power so the peak power applied to the antenna is equal to that recorded for the real or emulated signal using the WD modulation format.
- Measure both the peak and average input power applied to the antenna and record these values. Calculate the peak to average power ratio (PAR). The PAR for the CW signal should be 0.0 dB and 3.9 dB for the AM signal with 80% modulation depth from each other and the peak should be that amount above the target values.

The PMF was calculated for the following signals: 80% AM and the modulated signal produced by the WD. The PMF measurement was performed with the field probe and instrumentation that will be used together during RF emissions measurements. Once calculated, the PMF was entered into the DASY software and applied to the measured modulated fields of the specified type.

ANSI C63.19 outlines the following alternate procedure as one method for determining probe modulation factor:

1. Fix the field probe in a set location relative to a field generating device, such as the reference dipole antenna, as illustrated in Figure 2.
2. Illuminate the probe using the wireless device connected to the reference dipole with a test signal at the intended measurement frequency, Ensure there is sufficient field coupling between the probe and the antenna so the resulting reading is greater than 10 dB above the probe system noise floor but within the systems operating range.
3. Record the amplitude applied to the antenna during transmission and the field strength measured by the E-field probe located near the tip of the dipole antenna.

RTS RIM Testing Services	Document Hearing Aid Compatibility RF Emissions Test Report for BlackBerry® Smartphone Model RBS21CW		Page 9(28)
	Author Data Daoud Attayi	Dates of Test 06 June , 21-22 Aug , 2007	Report No RTS-0736-0708-15 Rev1

4. Replace the wireless device with an RF signal generator producing an unmodulated CW signal and set to the wireless device operating frequency.
5. Set the amplitude of the unmodulated signal to equal that recorded from the wireless device.
6. Record the reading of the probe measurement system of the unmodulated signal.
7. The ratio, in linear units, of the probe reading in step 6 to the reading in step 3 is the E-field modulation factor.
- 8 Repeat the above using the H-field probe, except locate the probe at the center of the dipole.

Please refer to Annex A.1 for 0 Hz-span spectrum analyzer plots. The signal generator was used to generate the CW and AM signals. The WD was used to generate the modulated signal.

Please refer to Annex A.2 for probe modulation factor measurement plots.

RTS RIM Testing Services	Document Hearing Aid Compatibility RF Emissions Test Report for BlackBerry® Smartphone Model RBS21CW		Page 10(28)
	Author Data Daoud Attayi	Dates of Test 06 June , 21-22 Aug , 2007	Report No RTS-0736-0708-15 Rev1

The results of the dipole validation and probe modulation factor measurements are shown in Table 4.

f (MHz)	Signal Type	Peak Envelope Power (dBm)	Measured E-Field (V/m)	Target E-Field (V/m)	Delta (%)	Mod. Factor Ratio
835	CW	20.00	177.3	161.6	+ 9.7	-
835	CW	18.33	139.7	*		-
835	80 % AM	18.33	88.5	*		1.58
835	CDMA (Full Rate)	18.33	141.8	*		0.99
835	CDMA (1/8 Rate)	20.67	65.7	*		2.89
835	CW	20.67	189.9	*		-
1880	CW	20.00	144.1	132.4	+ 8.8	-
1880	CW	17.00	98.3	*		-
1880	80 % AM	17.00	62.4	*		1.58
1880	CDMA (Full Rate)	17.00	101.0	*		0.97
1880	CDMA (1/8 Rate)	17.83	41.2	*		2.74
1880	CW	17.67	112.8	*		-

f (MHz)	Signal Type	Peak Envelope Power (dBm)	Measured H-Field (A/m)	Target H-Field (A/m)	Delta (%)	Mod. Factor Ratio
835	CW	20.00	0.461	0.446	+3.4	-
835	CW	18.33	0.362	*		-
835	80 % AM	18.33	0.207	*		1.75
835	CDMA (Full Rate)	18.33	0.351	*		1.03
835	CDMA (1/8 Rate)	20.67	0.175	*		2.70
835	CW	20.67	0.473	*		-
1880	CW	20.00	0.489	0.454	+7.7	-
1880	CW	17.00	0.336	*		-
1880	80 % AM	17.00	0.215	*		1.56
1880	CDMA (Full Rate)	17.00	0.322	*		1.01
1880	CDMA (1/8 Rate)	17.83	0.145	*		2.67
1880	CW	17.67	0.350	*		-

Table 4: Dipole Validation and Modulation Factors

* Neither ANSI C63.19 nor the probe manufacturer provides target values for AM and WD signals. The only available target values are for 20dBm CW signal.

5.1.3.1 Calculation of the Probe Modulation Factor

Probe Modulation Factor = Measured E or H-Field (CW) / Measured E or H-Field (Modulated)

Example: E-Field Probe Modulation Factor for CDMA 835 (FR) = 139.7 / 141.8 = 0.99

RTS RIM Testing Services	Document Hearing Aid Compatibility RF Emissions Test Report for BlackBerry® Smartphone Model RBS21CW		Page 11(28)
	Author Data Daoud Attayi	Dates of Test 06 June , 21-22 Aug , 2007	Report No RTS-0736-0708-15 Rev1

5.2 Near-Field RF Emission

The following procedure was used to measure RF near E-field and H-field emissions:

1. Proper operation of the field probe, probe measurement system, other instrumentation, and the positioning system was confirmed.
2. The WD was oriented in its intended test position with the reference plane in the horizontal plane (see Figure 4), and was secured in the device holder to maintain position accuracy.
3. A CMU 200 Base Station Simulator was used to place a normal voice call to the WD on the desired channel and to transmit at maximum power. Radio Configuration mode 3 was used. The Base Station Simulator's Power Control was set to "all up bits" to force the WD to transmit at maximum power.
4. The DASY4 system measures power drift as part of each scan. If the power during a scan drifted by more than 0.20 dB, the scan was repeated or compensated for. Power drift measurements for the worst-case scans are included in Annex A.3. A fully charged battery was used for each test.
5. The 5cm x 5cm measurement grid was centered on the center of the acoustic output or the T-Coil output, as appropriate. The field probe was located at the initial position at the center of the measurement grid.
6. A surface verification was performed before each setup change to ensure repeatable spacing and proper maintenance of the measurement plane.
7. The electric field probe, and separately the magnetic field probe, was used to measure the highest field strength in the 5cm x 5cm reference plane.
8. The entire 5cm x 5cm region was scanned with a 5mm step size. The reading was recorded at each measurement location. Justification of the step size and interpolation used is provided at the end of Annex A.2.
9. A 1 cm separation distance is maintained between the center of the probe sensor and the highest surface of wireless device.
10. Around the center sub-grid, five contiguous sub-grids were identified with the lowest maximum field strength readings. Please note that a maximum of five sub-grids can be excluded for both E- and H-field measurements.
11. The highest field reading was identified within the non-excluded sub-grids
12. The highest field reading was converted from average to peak V/m or A/m, as appropriate. This conversion was done by the DASY4 SEMCAD processor after entering correct PMF.
13. Once the worst-case configuration was determined, the WD was tested with second source battery and 1/8 gating mode (12.5% data rate). Results are shown in Tables 8 and 9.
14. In the worst-case configuration, the probe was rotated 360° about the azimuth axis at the location of the highest field strength in the included blocks. The peak reading from this rotation was recorded and the maximum field was recalculated.
15. The highest peak reading was compared to the categories defined in C63.19 using the appropriate AWF (see Tables 5 and 6 in this report).

- If a WD has more than one antenna position, it is necessary to test the WD only in the condition of maximum antenna efficiency, i.e. antenna extended.
- The WD's backlight shuts off automatically a short time after a call is established.

RTS RIM Testing Services	Document Hearing Aid Compatibility RF Emissions Test Report for BlackBerry® Smartphone Model RBS21CW		Page 12(28)
	Author Data Daoud Attayi	Dates of Test 06 June , 21-22 Aug , 2007	Report No RTS-0736-0708-15 Rev1

5.2.1 FCC 3G certification policy for the Hearing Aid Compatibility

If all operational modes are not tested justification must be made for the modes tested. The justification should be sufficient to assure to a reasonable extent that the device will comply in all untested modes.

Voice modes for at the ear usage modes should be addressed.

Subset testing should be justified as mentioned above. The key parameters to focus on for RF emission testing are peak field, and peak power (defined in C63.19 section 4). Conditions where modulation rates fall into the audio spectrum are of special interest. Sample testing of the various modes can be performed at the worst case probe location for each band and field type (E or H) as part of subset testing justification. Sample testing of conducted RF peak power can also be used to help in the justification.

Many combinations of Service Options and Radio Configurations were tested and results are shown in the Table 7 and 8.

RTS RIM Testing Services	Document Hearing Aid Compatibility RF Emissions Test Report for BlackBerry® Smartphone Model RBS21CW		Page 13(28)
	Author Data Daoud Attayi	Dates of Test 06 June , 21-22 Aug , 2007	Report No RTS-0736-0708-15 Rev1 FCC ID L6ARBS20CW

Category	Telephone RF Parameters < 960 MHz				
	Near Field	AWF	E-Field Emissions		H-Field Emissions
Category M1/T1	0	631.0 to 1122.0	V/m	1.91 to 3.39	A/m
	-5	473.2 to 841.4	V/m	1.43 to 2.54	A/m
Category M2/T2	0	354.8 to 631.0	V/m	1.07 to 1.91	A/m
	-5	266.1 to 473.2	V/m	0.80 to 1.43	A/m
Category M3/T3	0	199.5 to 354.8	V/m	0.60 to 1.07	A/m
	-5	149.6 to 266.1	V/m	0.45 to 0.80	A/m
Category M4/T4	0	< 199.5	V/m	< 0.60	A/m
	-5	< 149.6	V/m	< 0.45	A/m

Category	Telephone RF Parameters > 960 MHz				
	Near Field	AWF	E-Field Emissions		H-Field Emissions
Category M1/T1	0	199.5 to 354.8	V/m	0.60 to 1.07	A/m
	-5	149.6 to 266.1	V/m	0.45 to 0.80	A/m
Category M2/T2	0	112.2 to 199.5	V/m	0.34 to 0.60	A/m
	-5	84.1 to 149.6	V/m	0.25 to 0.45	A/m
Category M3/T3	0	63.1 to 112.2	V/m	0.19 to 0.34	A/m
	-5	47.3 to 84.1	V/m	0.14 to 0.25	A/m
Category M4/T4	0	<63.1	V/m	<0.19	A/m
	-5	<47.3	V/m	<0.14	A/m

Table 5: Wireless Device near-field categories

Standard	Technology	AWF (dB)
TIA/EIA/IS-2000	CDMA	0
TIA/EIA-136	TDMA (50 Hz)	0
J-STD-007	GSM (217)	-5
T1/T1P1/3GPP	UMTS (WCDMA)	0
iDEN™	TDMA (22 and 11 Hz)	0

Table 6: Articulation Weighting Factor (AWF)

RTS RIM Testing Services	Document Hearing Aid Compatibility RF Emissions Test Report for BlackBerry® Smartphone Model RBS21CW		Page 14(28)
	Author Data Daoud Attayi	Dates of Test 06 June , 21-22 Aug , 2007	Report No RTS-0736-0708-15 Rev1

Figures 4 and 5 show the orientation of the WD in the reference plane.

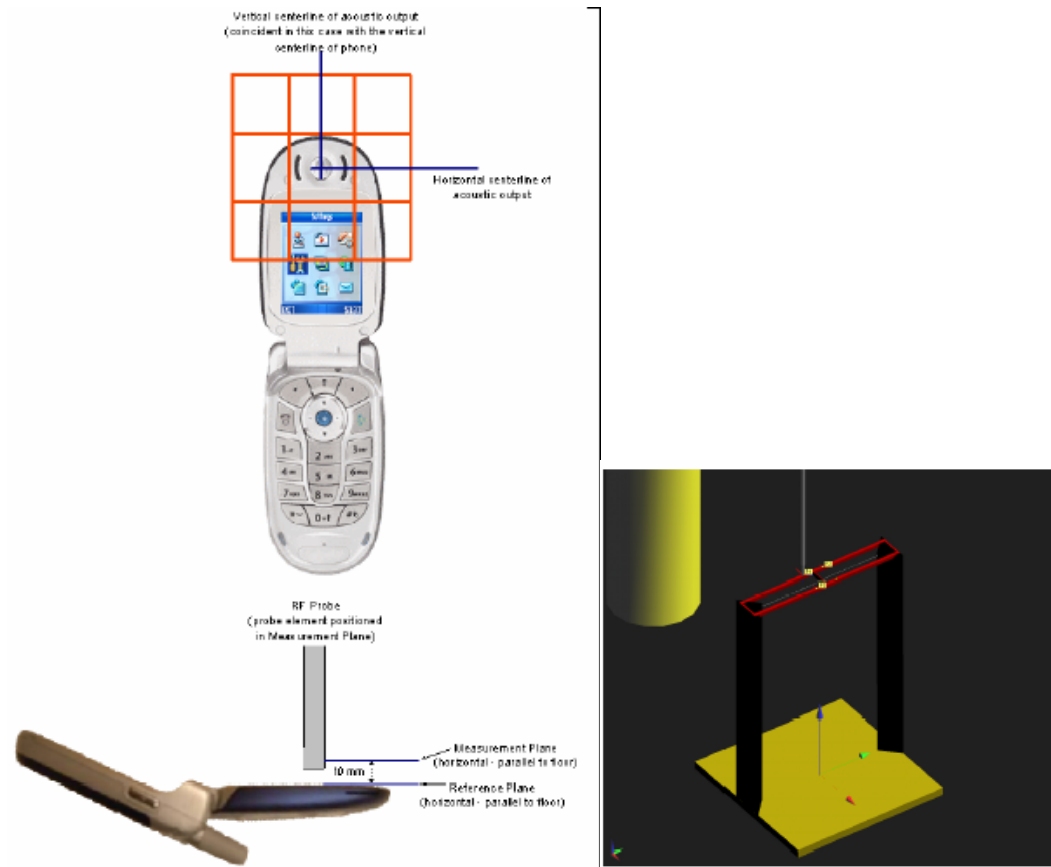

Figure 4: WD reference plane for RF emission measurements Figure 5: HAC Phantom/Test Arch

5.3 Wireless Device Audio Band Magnetic Signal Test

Please refer to the report number RTS-0736-0708-14 for the HAC T-Coil test data and compliance.

RTS RIM Testing Services	Document Hearing Aid Compatibility RF Emissions Test Report for BlackBerry® Smartphone Model RBS21CW		Page 15(28)
	Author Data Daoud Attayi	Dates of Test 06 June , 21-22 Aug , 2007	Report No RTS-0736-0708-15 Rev1

6.0 Summary of results

Wireless Device: BlackBerry Smartphone – Model: RBS21CW							
RF Emissions Test							
Mode	f (MHz)	Cond. Pwr. (dBm)	Peak E-Field (V/m)	Peak E-Field after 360° Rotation * (V/m)	Center at mid Speaker or T-Coil	M-Rating	Config. setting
CDMA 800	824.70	24.25	103.4		Speaker	4	RC3, S02, FR
	836.52	24.24	92.6		Speaker	4	RC3, S02, FR
	848.52	24.06	98.1		Speaker	4	RC3, S02, FR
	824.70		145.0		Speaker	4	RC1, S03 (mute), 1/8
	824.70		138.6		T-Coil	4	RC1, S03 (mute), 1/8
CDMA 1900	1851.25	23.42	64.7		Speaker	3	RC1, S02, FR
	1880.00	23.59	61.9		Speaker	3	RC1, S02, FR
	1908.50	23.84	57.5		Speaker	4	RC1, S02, FR
	1851.25		68.2		Speaker	3	RC1, S03 (mute), 1/8
	1851.25		67.2		Speaker	3	RC3, SO2, FR
	1851.25		64.0		Speaker	3	RC3, SO3, FR
	1851.25		64.6		Speaker	3	RC2, SO9, FR
	1851.25		62.9		T-Coil	3	RC3, SO2, FR
Overall M-Rating:						M3	

Table 7 – E-Field Data Summary

* In accordance with the TCB guidance, the probe was rotated 360° in the worst-case configuration.

RTS RIM Testing Services	Document Hearing Aid Compatibility RF Emissions Test Report for BlackBerry® Smartphone Model RBS21CW		Page 16(28)
	Author Data Daoud Attayi	Dates of Test 06 June , 21-22 Aug , 2007	Report No RTS-0736-0708-15 Rev1

Wireless Device: BlackBerry Smartphone – Model: RBS21CW							
RF Emissions Test							
Mode	f (MHz)	Cond. Power (dBm)	Peak H-Field (A/m)	Peak H-Field after 360° Rotation* (A/m)	Center at mid Speaker or T-Coil	M-Rating	Config. setting
CDMA 800	824.70	24.46	0.20		Speaker	4	RC1, S02, FR
	836.52	24.40	0.19		Speaker	4	RC1, S02, FR
	848.52	24.20	0.20		Speaker	4	RC1, S02, FR
	824.70		0.26		Speaker	4	RC1, SO3, 1/8
	824.70		0.24		T-Coil	4	RC1, SO3, 1/8
CDMA 1900	1851.25	23.42	0.16		Speaker	4	RC1, SO2, FR
	1880.00	23.59	0.15		Speaker	4	RC1, SO2, FR
	1908.50	23.84	0.14		Speaker	4	RC1, SO2, FR
	1851.25		0.14		Speaker	4	RC1, SO3, 1/8
	1851.25		0.15		T-Coil	4	RC1, SO2, FR
	1851.25		0.15		Speaker	4	RC3, SO2, FR
	1851.25		0.15		Speaker	4	RC3, SO3, FR
1851.25		0.15		Speaker	4	RC2, SO9, FR	
Overall M-Rating:						M4	

Table 8 – H-Field Data Summary

* In accordance with the TCB guidance, the probe was rotated 360° in the worst-case configuration.

RTS RIM Testing Services	Document Hearing Aid Compatibility RF Emissions Test Report for BlackBerry® Smartphone Model RBS21CW		Page 17(28)
	Author Data Daoud Attayi	Dates of Test 06 June , 21-22 Aug , 2007	Report No RTS-0736-0708-15 Rev1

6.1 Conclusion

The BlackBerry Smartphone Model Number RBS21CW is categorized to be M3T3 based on RF emission and Audio Band Magnetic (ABM) T-Coil performance in accordance with ANSI C63.19-2006: American National Standard for Methods of Measurement of Compatibility between Wireless Communication Devices and Hearing Aids.

Therefore, the device is found to be in compliance with the requirements of FCC 20.19 (10-1-05 Edition) Hearing Aid-Compatible Mobile Handsets as modified by FCC Public Notice DA 06-1215 (Released: June 6, 2006).

RTS RIM Testing Services	Document Hearing Aid Compatibility RF Emissions Test Report for BlackBerry® Smartphone Model RBS21CW		Page 18(28)
	Author Data Daoud Attayi	Dates of Test 06 June , 21-22 Aug , 2007	Report No RTS-0736-0708-15 Rev1

7.0 Measurement uncertainty

Table 10 outlines the measurement uncertainty for the SPEAG DASY4 measurement system.

HAC Uncertainty Budget According to ANSI C63.19 [1]							
Error Description	Uncertainty value	Prob. Dist.	Div.	(c_1) E	(c_1) H	Std. Unc. E	Std. Unc. H
Measurement System							
Probe Calibration	±5.1 %	N	1	1	1	±5.1 %	±5.1 %
Axial Isotropy	±4.7 %	R	$\sqrt{3}$	1	1	±2.7 %	±2.7 %
Sensor Displacement	±16.5 %	R	$\sqrt{3}$	1	0.145	±9.5 %	±1.4 %
Boundary Effects	±2.4 %	R	$\sqrt{3}$	1	1	±1.4 %	±1.4 %
Linearity	±4.7 %	R	$\sqrt{3}$	1	1	±2.7 %	±2.7 %
Scaling to Peak Envelope Power	±2.0 %	R	$\sqrt{3}$	1	1	±1.2 %	±1.2 %
System Detection Limit	±1.0 %	R	$\sqrt{3}$	1	1	±0.6 %	±0.6 %
Readout Electronics	±0.3 %	N	1	1	1	±0.3 %	±0.3 %
Response Time	±0.8 %	R	$\sqrt{3}$	1	1	±0.5 %	±0.5 %
Integration Time	±2.6 %	R	$\sqrt{3}$	1	1	±1.5 %	±1.5 %
RF Ambient Conditions	±3.0 %	R	$\sqrt{3}$	1	1	±1.7 %	±1.7 %
RF Reflections	±12.0 %	R	$\sqrt{3}$	1	1	±6.9 %	±6.9 %
Probe Positioner	±1.2 %	R	$\sqrt{3}$	1	0.67	±0.7 %	±0.5 %
Probe Positioning	±4.7 %	R	$\sqrt{3}$	1	0.67	±2.7 %	±1.8 %
Extrap. and Interpolation	±1.0 %	R	$\sqrt{3}$	1	1	±0.6 %	±0.6 %
Test Sample Related							
Device Positioning Vertical	±4.7 %	R	$\sqrt{3}$	1	0.67	±2.7 %	±1.8 %
Device Positioning Lateral	±1.0 %	R	$\sqrt{3}$	1	1	±0.6 %	±0.6 %
Device Holder and Phantom	±2.4 %	R	$\sqrt{3}$	1	1	±1.4 %	±1.4 %
Power Drift	±5.0 %	R	$\sqrt{3}$	1	1	±2.9 %	±2.9 %
Phantom and Setup Related							
Phantom Thickness	±2.4 %	R	$\sqrt{3}$	1	0.67	±1.4 %	±0.9 %
Combined Std. Uncertainty						±14.7 %	±10.9 %
Expanded Std. Uncertainty on Power						±29.4 %	±21.8 %
Expanded Std. Uncertainty on Field						±14.7 %	±10.9 %

Table 10. Worst-Case uncertainty budget for HAC free field assessment according to ANSI C63.19.

[1] The budget is valid for the frequency range 800 MHz - 3 GHz and represents a worst-case analysis.

RTS RIM Testing Services	Document Hearing Aid Compatibility RF Emissions Test Report for BlackBerry® Smartphone Model RBS21CW		Page 19(28)
	Author Data Daoud Attayi	Dates of Test 06 June , 21-22 Aug , 2007	Report No RTS-0736-0708-15 Rev1

7.1 Site-Specific Uncertainty

RF Reflections

Section 4.2 of ANSI C63.19 requires that any RF reflecting objects are a minimum distance of 2 wavelengths away from the WD under test. For this WD, the longest wavelength occurs when the WD is transmitting at 824.7MHz. The wavelength is:

$$\lambda = \frac{c}{f} = \frac{3 \cdot 10^8 \text{ m/s}}{824.7 \text{ MHz}} = 0.364 \text{ m}$$

Therefore, 2 wavelengths result in a distance of 0.73m. Tests are performed in an RF shielded chamber. The distance to the nearest wall is >1m and the distance to the robot's safety guardrail is ~1.0m, both satisfying the requirement. In addition, RF absorbing cones are placed at the base of the robot to further reduce reflections. The HAC phantom arch is made of low dielectric constant plastic and should not be a source of reflections.

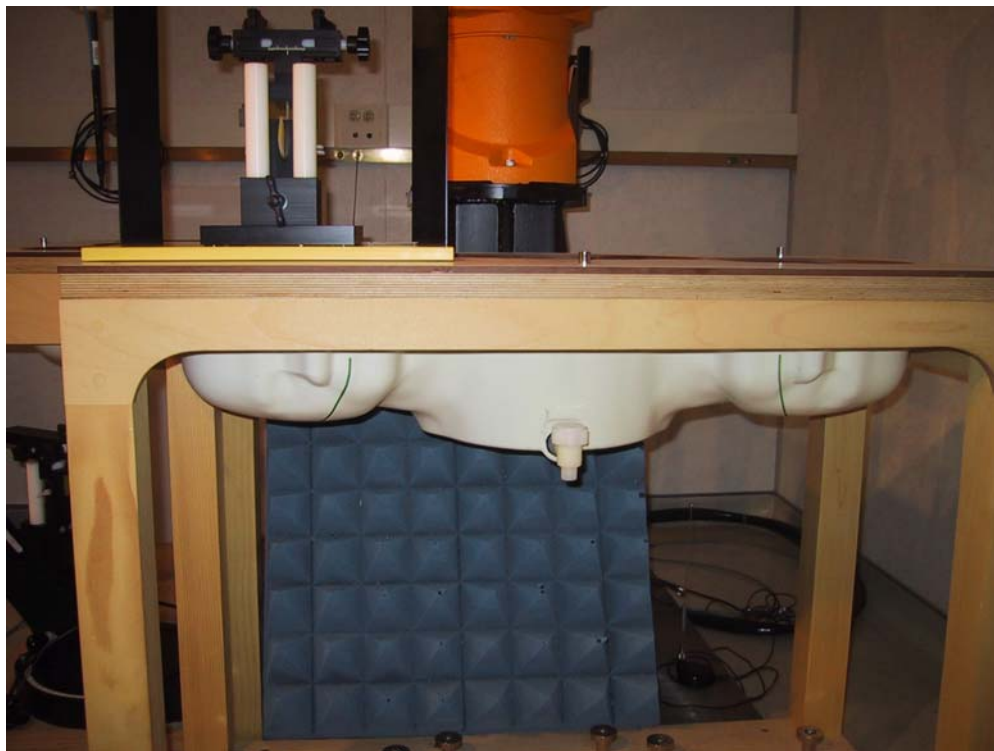

Figure 8: DASY4 system with absorbing material

RTS RIM Testing Services	Document Hearing Aid Compatibility RF Emissions Test Report for BlackBerry® Smartphone Model RBS21CW		Page 20(28)
	Author Data Daoud Attayi	Dates of Test 06 June , 21-22 Aug , 2007	Report No RTS-0736-0708-15 Rev1

Environmental Conditions

During measurements, the temperature of the test lab was kept between 21°C and 25°C and relative humidity was maintained between 20% and 55%.

Ambient Noise

ANSI C63.19 standard requires ambient noise to be at least 20dB below the measurement level. Scans of ambient fields were performed for verification. The ambient E-Field level was determined to be 2.75V/m and H-field level of 0.01A/m at 1900 MHz. The ambient noise was determined to be ~25 or 27 dB below the lowest measured value in 1900 MHz band.

In addition, the ambient noise was measured at 835 MHz and the plots are as follow:

RTS RIM Testing Services	Document Hearing Aid Compatibility RF Emissions Test Report for BlackBerry® Smartphone Model RBS21CW		Page 21(28)
	Author Data Daoud Attayi	Dates of Test 06 June , 21-22 Aug , 2007	Report No RTS-0736-0708-15 Rev1

Date/Time: 04/06/2007 10:08:44 AM

Test Laboratory: RTS

HAC_E_RF_Ambient_1900MHz

DUT: N/A; Type: Sample ; Serial: Not Specified

Communication System: CW; Frequency: 1900 MHz; Duty Cycle: 1:1

Medium parameters used: $\sigma = 0$ mho/m, $\epsilon_r = 1$; $\rho = 1000$ kg/m³

Phantom section: E Device Section

DASY4 Configuration:

- Probe: ER3DV6 - SN2286; ConvF(1, 1, 1); Calibrated: 10/01/2007
- Sensor-Surface: 0mm (Fix Surface) Sensor-Surface: (Fix Surface)
- Electronics: DAE3 Sn472; Calibrated: 07/03/2007
- Phantom: HAC Test Arch; Type: SD HAC P01 BA;
- Measurement SW: DASY4, V4.7 Build 53; Postprocessing SW: SEMCAD, V1.8 Build 172

E Scan - ER probe tip 10mm above Device Reference/Hearing Aid Compatibility Test

(11x11x1): Measurement grid: dx=5mm, dy=5mm

Probe Modulation Factor = 1.00

Reference Value = 1.13 V/m; Power Drift = 0.943 dB

Maximum value of Total (measured) = 1.50 V/m

E Scan - ER probe tip 10mm above Device Reference/Hearing Aid Compatibility Test

(101x101x1): Measurement grid: dx=5mm, dy=5mm

Maximum value of peak Total field = 2.45 V/m

Probe Modulation Factor = 1.00

Reference Value = 1.13 V/m; Power Drift = 0.943 dB

Hearing Aid Near-Field Category: M4 (AWF 0 dB)

Peak E-field in V/m

Grid	Grid	Grid
2.22	2.75	2.33
Grid	Grid	Grid
1.92	2.36	2.13
Grid	Grid	Grid

RTS RIM Testing Services	Document Hearing Aid Compatibility RF Emissions Test Report for BlackBerry® Smartphone Model RBS21CW		Page 22(28)
	Author Data Daoud Attayi	Dates of Test 06 June , 21-22 Aug , 2007	Report No RTS-0736-0708-15 Rev1

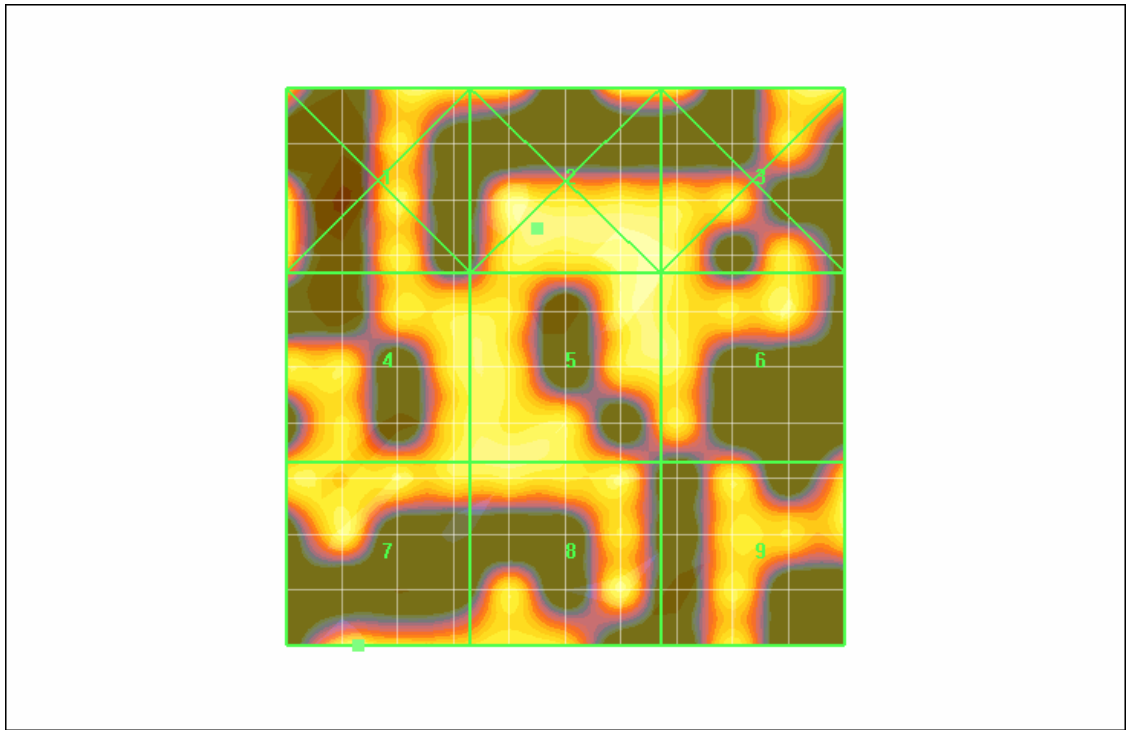
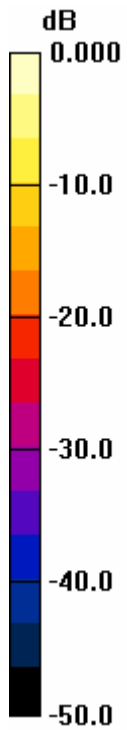

0 dB = 2.75V/m

RTS RIM Testing Services	Document Hearing Aid Compatibility RF Emissions Test Report for BlackBerry® Smartphone Model RBS21CW		Page 23(28)
	Author Data Daoud Attayi	Dates of Test 06 June , 21-22 Aug , 2007	Report No RTS-0736-0708-15 Rev1

Date/Time: 04/06/2007 8:55:55 AM

Test Laboratory: RTS

HAC_H_RF_Ambient_1900MHz

DUT: N/A; Type: Sample ; Serial: Not Specified

Communication System: CW; Frequency: 1900 MHz; Duty Cycle: 1:1

Medium parameters used: $\sigma = 0$ mho/m, $\epsilon_r = 1$; $\rho = 1$ kg/m³

Phantom section: H Dipole Section

DASY4 Configuration:

- Probe: H3DV6 - SN6105; ; Calibrated: 15/11/2006
- Sensor-Surface: 0mm (Fix Surface)Sensor-Surface: (Fix Surface)
- Electronics: DAE3 Sn472; Calibrated: 07/03/2007
- Phantom: HAC Test Arch; Type: SD HAC P01 BA;
- Measurement SW: DASY4, V4.7 Build 53; Postprocessing SW: SEMCAD, V1.8 Build 172

H Scan - H3DV6 probe tip 10mm above Device Reference/Hearing Aid Compatibility Test

(11x11x1): Measurement grid: dx=5mm, dy=5mm

Probe Modulation Factor = 1.00

Reference Value = 0.001 A/m; Power Drift = 1.51 dB

Maximum value of Total (measured) = 0.003 A/m

H Scan - H3DV6 probe tip 10mm above Device Reference/Hearing Aid Compatibility Test

(101x101x1): Measurement grid: dx=5mm, dy=5mm

Maximum value of peak Total field = 0.005 A/m

Probe Modulation Factor = 1.00

Reference Value = 0.001 A/m; Power Drift = 1.51 dB

Hearing Aid Near-Field Category: M4 (AWF 0 dB)

Peak H-field in A/m

Grid	Grid	Grid
0.003	0.005	0.004
Grid	Grid	Grid
0.003	0.004	0.004
Grid	Grid	Grid

RTS RIM Testing Services	Document Hearing Aid Compatibility RF Emissions Test Report for BlackBerry® Smartphone Model RBS21CW		Page 24(28)
	Author Data Daoud Attayi	Dates of Test 06 June , 21-22 Aug , 2007	Report No RTS-0736-0708-15 Rev1

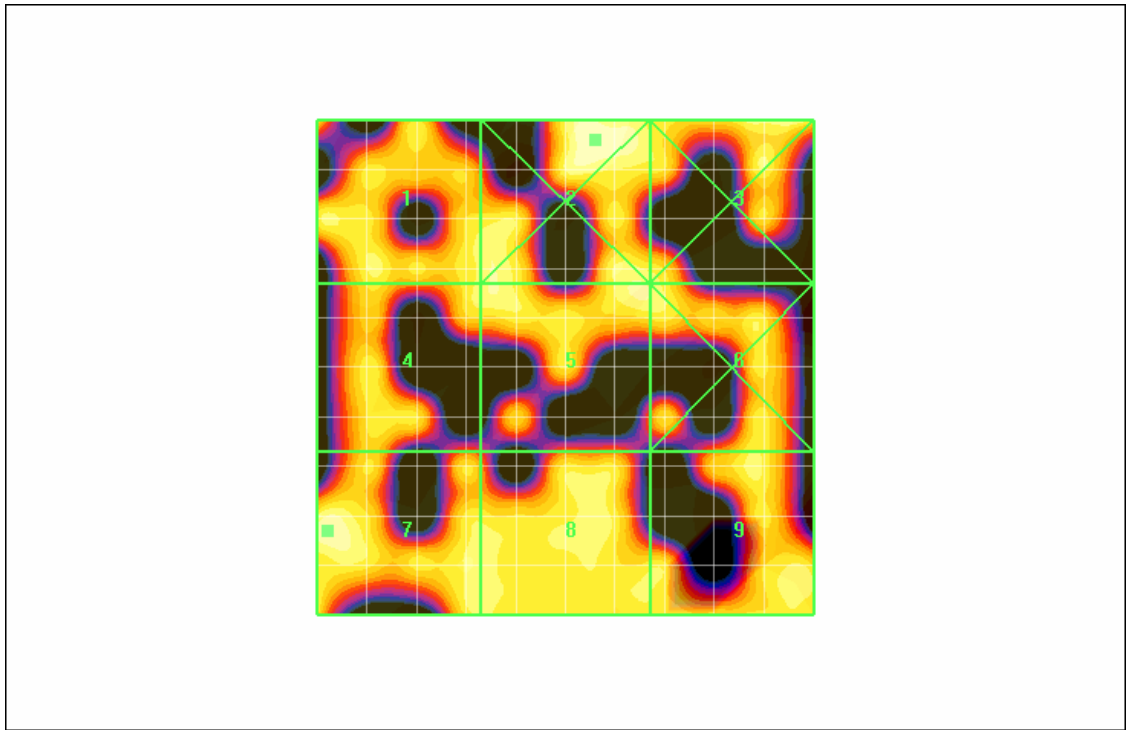
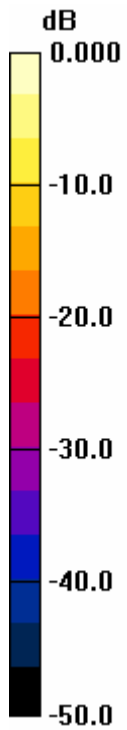

0 dB = 0.005A/m

RTS RIM Testing Services	Document Hearing Aid Compatibility RF Emissions Test Report for BlackBerry® Smartphone Model RBS21CW		Page 25(28)
	Author Data Daoud Attayi	Dates of Test 06 June , 21-22 Aug , 2007	Report No RTS-0736-0708-15 Rev1

Date/Time: 04/06/2007 10:16:29 AM

Test Laboratory: RTS

HAC_E_RF_Ambient_835MHz

DUT: N/A; Type: Sample ; Serial: Not Specified

Communication System: CW; Frequency: 835 MHz; Duty Cycle: 1:1

Medium parameters used: $\sigma = 0$ mho/m, $\epsilon_r = 1$; $\rho = 1000$ kg/m³

Phantom section: E Device Section

DASY4 Configuration:

- Probe: ER3DV6 - SN2286; ConvF(1, 1, 1); Calibrated: 10/01/2007
- Sensor-Surface: 0mm (Fix Surface) Sensor-Surface: (Fix Surface)
- Electronics: DAE3 Sn472; Calibrated: 07/03/2007
- Phantom: HAC Test Arch; Type: SD HAC P01 BA;
- Measurement SW: DASY4, V4.7 Build 53; Postprocessing SW: SEMCAD, V1.8 Build 172

E Scan - ER probe tip 10mm above Device Reference/Hearing Aid Compatibility Test

(11x11x1): Measurement grid: dx=5mm, dy=5mm

Probe Modulation Factor = 1.00

Reference Value = 0.941 V/m; Power Drift = 0.390 dB

Maximum value of Total (measured) = 1.91 V/m

E Scan - ER probe tip 10mm above Device Reference/Hearing Aid Compatibility Test

(101x101x1): Measurement grid: dx=5mm, dy=5mm

Maximum value of peak Total field = 3.24 V/m

Probe Modulation Factor = 1.00

Reference Value = 0.941 V/m; Power Drift = 0.390 dB

Hearing Aid Near-Field Category: M4 (AWF 0 dB)

Peak E-field in V/m

Grid	Grid	Grid
2.10	1.87	1.96
Grid	Grid	Grid
2.61	1.45	1.92
Grid	Grid	Grid

RTS RIM Testing Services	Document Hearing Aid Compatibility RF Emissions Test Report for BlackBerry® Smartphone Model RBS21CW		Page 26(28)
	Author Data Daoud Attayi	Dates of Test 06 June , 21-22 Aug , 2007	Report No RTS-0736-0708-15 Rev1

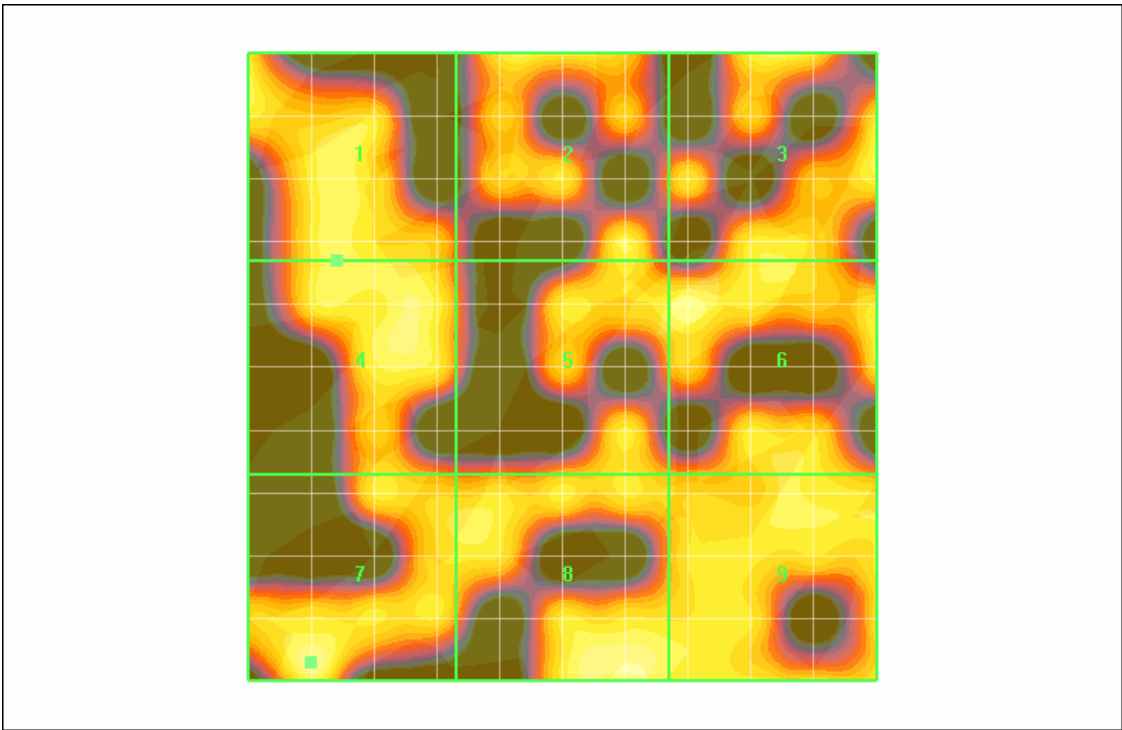
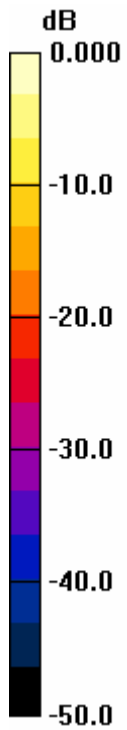

0 dB = 3.24V/m

RTS RIM Testing Services	Document Hearing Aid Compatibility RF Emissions Test Report for BlackBerry® Smartphone Model RBS21CW		Page 27(28)
	Author Data Daoud Attayi	Dates of Test 06 June , 21-22 Aug , 2007	Report No RTS-0736-0708-15 Rev1

Date/Time: 04/06/2007 9:02:37 AM

Test Laboratory: RTS

HAC_H_RF_Ambient_835MHz

DUT: N/A; Type: Sample ; Serial: Not Specified

Communication System: CW; Frequency: 835 MHz;Duty Cycle: 1:1

Medium parameters used: $\sigma = 0$ mho/m, $\epsilon_r = 1$; $\rho = 1$ kg/m³

Phantom section: H Dipole Section

DASY4 Configuration:

- Probe: H3DV6 - SN6105; ; Calibrated: 15/11/2006
- Sensor-Surface: 0mm (Fix Surface)Sensor-Surface: (Fix Surface)
- Electronics: DAE3 Sn472; Calibrated: 07/03/2007
- Phantom: HAC Test Arch; Type: SD HAC P01 BA;
- Measurement SW: DASY4, V4.7 Build 53; Postprocessing SW: SEMCAD, V1.8 Build 172

H Scan - H3DV6 probe tip 10mm above Device Reference/Hearing Aid Compatibility Test

(11x11x1): Measurement grid: dx=5mm, dy=5mm

Probe Modulation Factor = 1.00

Reference Value = 0.004 A/m; Power Drift = -0.942 dB

Maximum value of Total (measured) = 0.006 A/m

H Scan - H3DV6 probe tip 10mm above Device Reference/Hearing Aid Compatibility Test

(101x101x1): Measurement grid: dx=5mm, dy=5mm

Maximum value of peak Total field = 0.017 A/m

Probe Modulation Factor = 1.00

Reference Value = 0.004 A/m; Power Drift = -0.942 dB

Hearing Aid Near-Field Category: M4 (AWF 0 dB)

Peak H-field in A/m

Grid	Grid	Grid
0.008	0.007	0.007
Grid	Grid	Grid
0.009	0.009	0.008
Grid	Grid	Grid

RTS RIM Testing Services	Document Hearing Aid Compatibility RF Emissions Test Report for BlackBerry® Smartphone Model RBS21CW		Page 28(28)
	Author Data Daoud Attayi	Dates of Test 06 June , 21-22 Aug , 2007	Report No RTS-0736-0708-15 Rev1

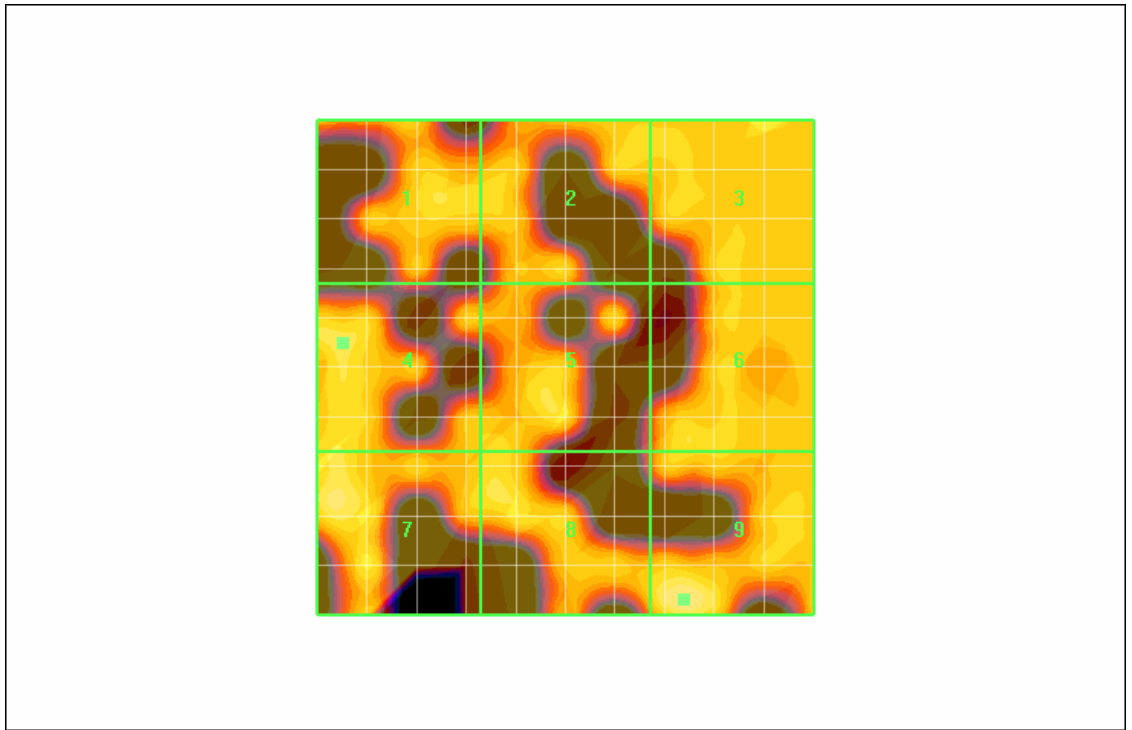
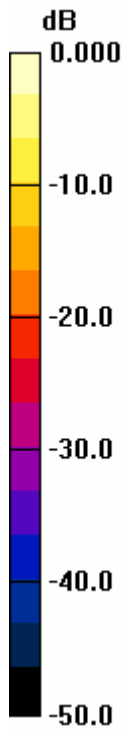

0 dB = 0.017A/m