



**BLACKBERRY RADAR R2**

**ITE100 – 1**

**May 2020**

Chassis (Beta)

# Installation Guide

## Table of contents

1	Overview.....	3
2	Get ready for installation .....	4
3	Installing BlackBerry Radar R2 modules.....	5
3.1	Prepare to install.....	5
3.2	Installation tools.....	7
3.3	Matching a module identifier to an asset identifier .....	8
3.4	Module installation.....	10
3.4.1	Prepare module for installation--Battery connection.....	11
3.4.2	Installing module on an asset.....	13
3.4.3	Chassis installation procedure .....	14
4	Removing BlackBerry Radar R2 modules.....	23
4.1	Removal tools .....	23
4.2	Module removal .....	24
4.3	Battery removal and replacement.....	24
5	Support .....	28
	Legal notice .....	29

## 1 Overview

This guide provides detailed instructions for installing and activating new BlackBerry Radar R2 modules. It includes three main tasks:

Task 1: Get ready for installation (see Section 2)

Task 2: Install a BlackBerry Radar R2 module (see Section 3)

- Match the module identifier with the asset identifier on the installation worksheet.
- Install the module onto the asset.

Task 3: Uninstall a module (see Section 4)

- Remove the module from the asset.
- Remove/replace the battery and prepare the device for shipping.

Complete BlackBerry Radar documentation is available online when you log in to BlackBerry Radar Dashboard. For instructions on how to configure the BlackBerry Radar Dashboard or how to activate newly installed devices, see the online documentation.

## 2 Get ready for installation

To get ready for installation, you need to obtain a worksheet where you can record the pairing of each BlackBerry R2 module to its companion BlackBerry Radar H2 module and its asset (that is, the trailer/container that the modules will be installed on).

For detailed instructions, log in to the BlackBerry Radar Dashboard and access documentation from the main menu.

### 3 Installing BlackBerry Radar R2 modules





You may have a large number of BlackBerry Radar R2 modules to install. Follow the instructions in this section to:

- Match each module identifier to its asset identifier
- Install the module to the asset you wish to track.

#### 3.1 Prepare to install

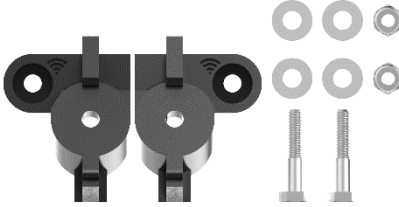

To complete the installation of the module to your assets, you will need the following components. The following components are contained in the module packaging.

#### Radar R2 Module Package Contents

<p>Radar R2 Module</p> 	<p>Drill Template (Template not required for Chassis Brackets)</p> 	
<p>Lithium Metal Battery</p> 	<p>Radar R2 Chassis Brackets and Fasteners. (2 brackets per device)</p> 	<p>Fastener Bag (4 screws per device)</p> 



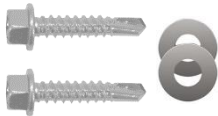
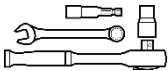
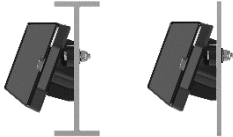
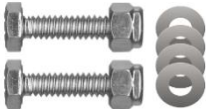
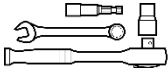

If you are missing any of the above components in your package, contact your BlackBerry Sales Representative.

To attach the module to the asset you wish to track, you must supply your own fasteners. Depending on the construction of your mounting location, you may wish to use the following types of fasteners. Please Note: Your choice of fastener will influence the size of the tools required to create the mounting holes (i.e. drill bits) and install or remove the fasteners (i.e. wrenches/sockets/drivers). An example of this is provided below. The actual length of the fasteners will be determined by the thickness of your mounting surface.



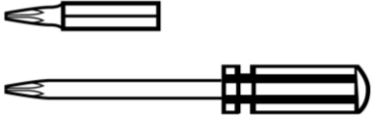
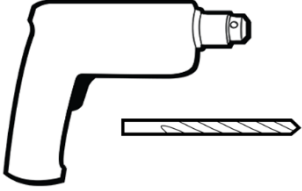

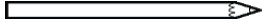
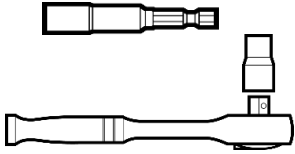
<p><b>IMPORTANT:</b> The maximum fastener thread diameter supported by this product is 1/4" or M6 (6 mm). For most secure fastening, we do not recommend using fasteners with a diameter less than that of a 1/4" or M6 fastener.</p>		
<p><b>Box Section</b> (+3mm wall thickness)</p> 	<p><b>2 self-tapping screws and washers</b> (3/8" head, 1/4"-14 thread, 1-1/2" length)</p> 	<p><b>Drill Bit</b> 3/16" (5mm)</p> <p><b>Nut Driver/Socket/Wrench</b> 3/8" (10mm)</p> 
<p><b>I-Beam/Panel Section</b> (with rear access)</p> 	<p><b>2 hex bolts, nuts, and 4 washers</b> (7/16" head, 1/4"-20 thread, 1-1/4" length, 1/4"-20 nut) (11mm head, M6 thread, 50mm length, M6 nut)</p> 	<p><b>Drill Bit</b> 1/4" (6mm)</p> <p><b>Nut Driver/Socket/Wrench</b> 7/16" (11mm)</p> 

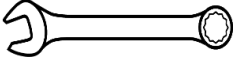
### 3.2 Installation tools

Required tools to complete the installation:

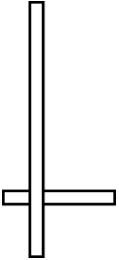
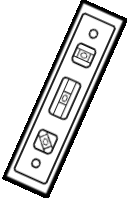
<p><b>Phillips (PH2) Screwdriver or Bit</b></p> 	<p><b>Drill and Drill Bits</b></p> 	<p><b>Tape</b></p>  <p><b>Pencil or Non-Permanent Marker</b></p> 
<p><b>Nut Driver or Socket Wrench with Socket*</b></p>  <p>*Nut Driver + Drill offers fastest installation. If no Nut Driver is available, a socket wrench and socket may be used as a substitute.</p>	<p><b>Safety Glasses</b></p> 	<p><b>Tape Measure</b></p>  <p><b>Wrench</b></p>  <p>*Required only if nuts and bolts are used.</p>

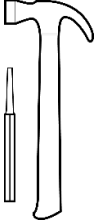
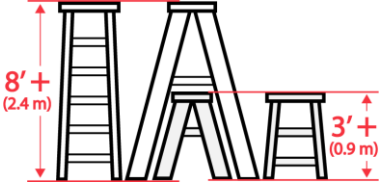
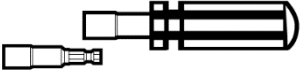
Recommended tools to complete the installation:

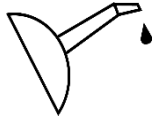
<p><b>T-Square</b></p> 	<p><b>Pocket Level</b></p> 	<p><b>Towel</b></p> 	<p><b>Hammer and Punch</b></p> 	<p><b>Ladders*</b></p>  <p>*Tall ladder for installation on taller vehicles and containers. Small ladder for installation inside of containers or the exterior of smaller vehicles.</p>
<p><b>Torque Screwdriver with Socket*</b>              (scale range of 0.4 N-m to 4.5 N-m, 4 in-lb to 40 in-lb)</p>  <p>*To check compliance with torque specifications for fasteners.</p>		<p><b>File</b></p> 	<p><b>Cutting Lubricant* (Recommended)</b></p>  <p>*Recommended for faster drilling speed on thicker metals and longer drill bit life.</p>	

### 3.3 Matching a module identifier to an asset identifier

In order to track an asset, the BlackBerry Radar R2 module that is installed on the asset must be associated with the asset in the BlackBerry Radar Dashboard. It is, therefore, very important to keep a clear record of which BlackBerry Radar R2 module is installed on which asset.

The Dashboard application tracks modules and assets using 'identifiers'. The asset identifier is the name or number of the asset you wish to track. The asset identifiers are entered into the application when you add the assets and will be listed on your installation worksheet. The identifier for each Radar R2 module is printed on three labels—two labels attached to the front surface of the outer housing and the other label inside the battery compartment. The module identifier also serves as the serial number (S/N) for the module.

To match a module identifier with an asset identifier:

1. Locate the module identifier for your device. The module identifier is shown in two places.
  1. Externally—temporary S/N label and permanent exterior S/N label, attached to the front of the outer housing,
  2. Internally—permanent main product label, in the battery compartment.

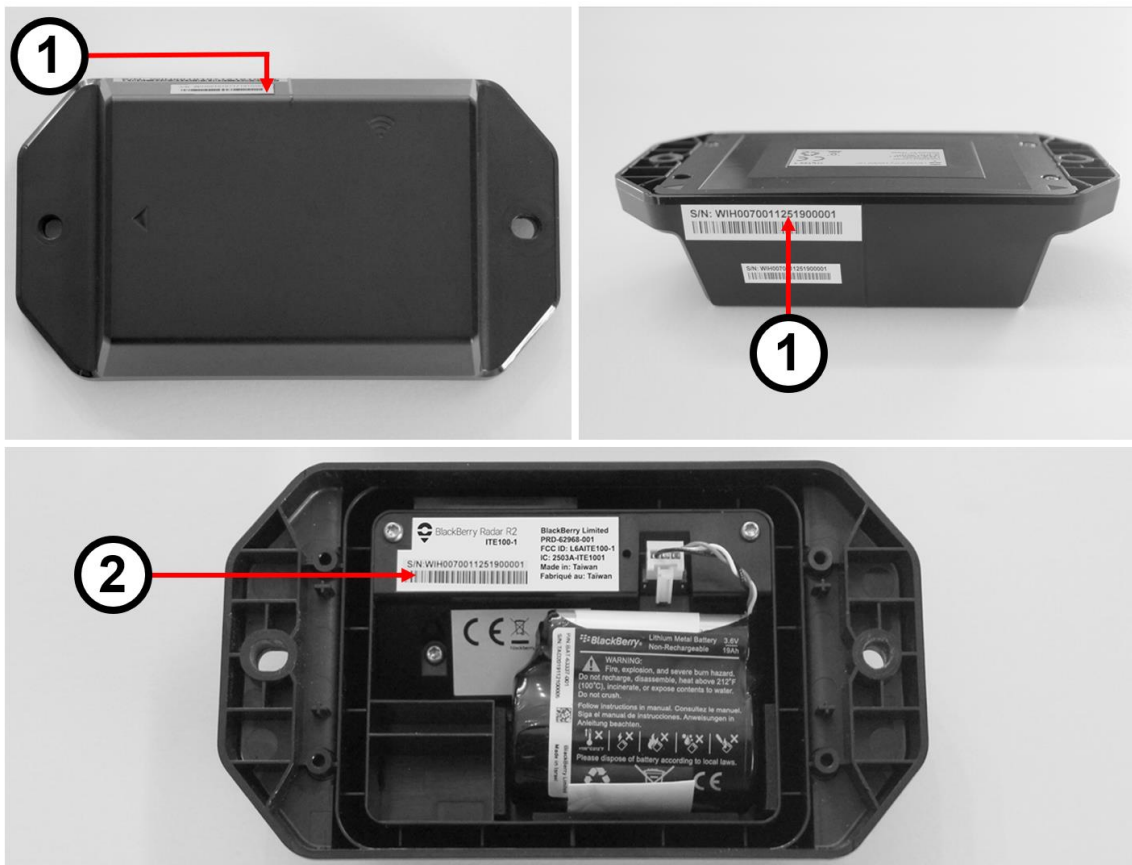



- Once you are ready to install the BlackBerry Radar R2 module to the asset, remove the partially attached label from the front surface of the outer housing and place it on your worksheet, on the row with asset the BlackBerry Radar R2 will track and the BlackBerry Radar H2 module identifier the BlackBerry Radar R2 will be paired with.

**BlackBerry Radar Installation Worksheet**  
 Date: November 22, 2020  
 Installer: ccorley@blackberry.com

Asset ID	Module ID Sticker	Accessory ID Sticker	Mileage (Optional)
ZG7419	S/N: WZS000010831180001	S/N: WIH001010712191006F	
New Asset again			
Completely New Asset			
KR8369			
COMpletely New			

**Radars**

Module ID Sticker	Accessory ID Sticker	Mileage (Optional)
S/N: WZS000010831180001	S/N: WIH001010712191006F	

**Worksheet with Annotations:**

Date: November 22, 2020  
 Installer: ccorley@blackberry.com

Asset ID	Module ID Sticker	Accessory ID Sticker	Mileage (Optional)
ZG7419	S/N: WZS000010831180001	S/N: WIH001010712191006F	

Annotations: Radar H2 Column (points to Module ID Sticker), Radar R2 Column (points to Accessory ID Sticker)

### 3.4 Module installation

You may install the module on any flat, vertical that offers enough mounting area for the module. When selecting a mounting location, carefully consider how the asset will be used during its normal, day-to-day operation.

Do not place the module in a location where it is susceptible to damage from:

- Normal usage activities, such as loading or unloading cargo.
- Moving parts of the asset.
- Road debris.

**IMPORTANT:** For accurate monitoring, orientation matters.

1. You must install the device install the Radar R2 module horizontally.
2. To monitor the presence or absence of a container on the chassis, when installing the Radar R2 module, always ensure the signal icon is pointed towards the sky.

This diagram illustrates the supported installation orientations for the BlackBerry Radar R2 module.

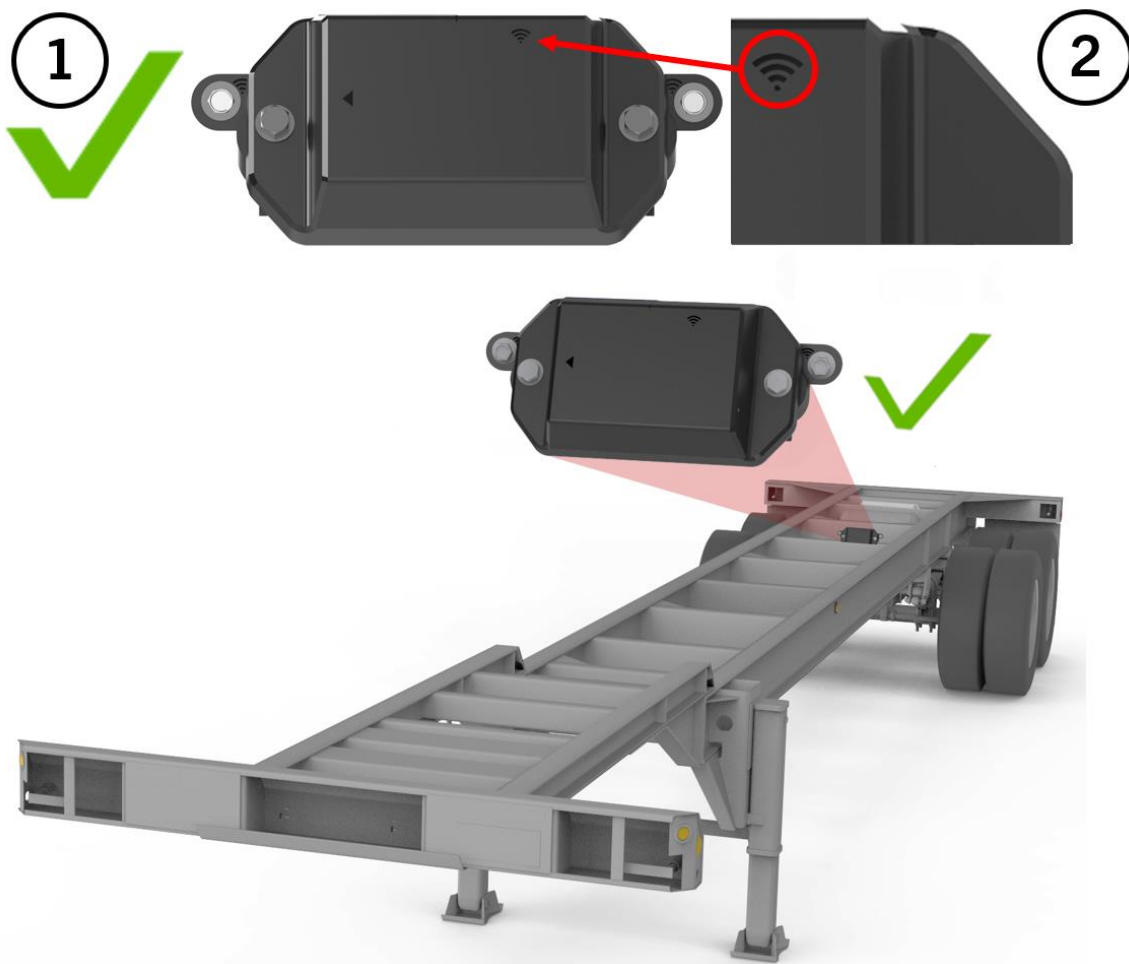

### 3.4.1 Prepare module for installation—Battery connection

**IMPORTANT:** Please do not perform the battery connection process until you are ready to install and associate the BlackBerry Radar modules on your asset. Once the battery is connected, please complete the module installation and association, as soon as you can, to conserve battery life.

1. Remove the battery from the housing to reveal the battery cable connector. Return the battery to the housing and connect the battery cable to the battery connector. The LED will blink to indicate the module is active. **NOTE:** It can take up to 5 seconds for the blink sequence to begin. Please be patient. Once you see the LED blink, you may continue to the next step.

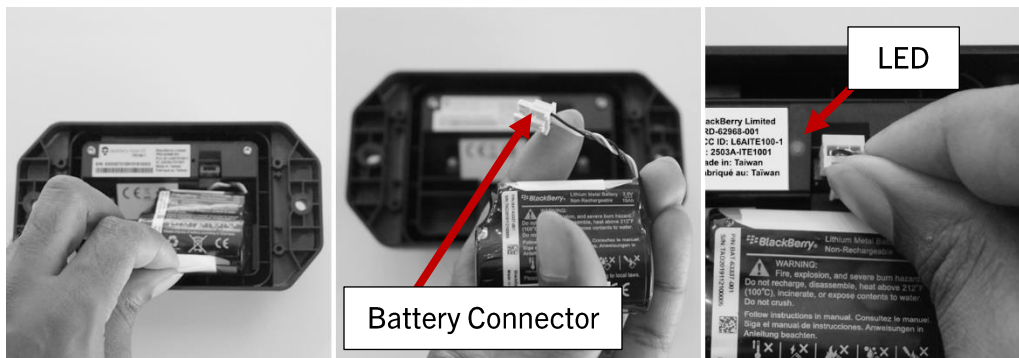

2. Fully install the battery door. Locate the Fastener Bag and remove the four screws. Using a Phillips (PH2) screwdriver, install the screws to secure the battery door.



3. Locate the Radar R2 Chassis Brackets and Fasteners.

- Place the brackets on the rear of the Radar R2 module, ensuring the holes on the R2 Chassis Bracket Accessory are aligned with the holes on the Radar R2 module and the bracket's guide tabs are seated within the rear openings of the module.
- Secure the brackets to the module with the supplied fasteners.

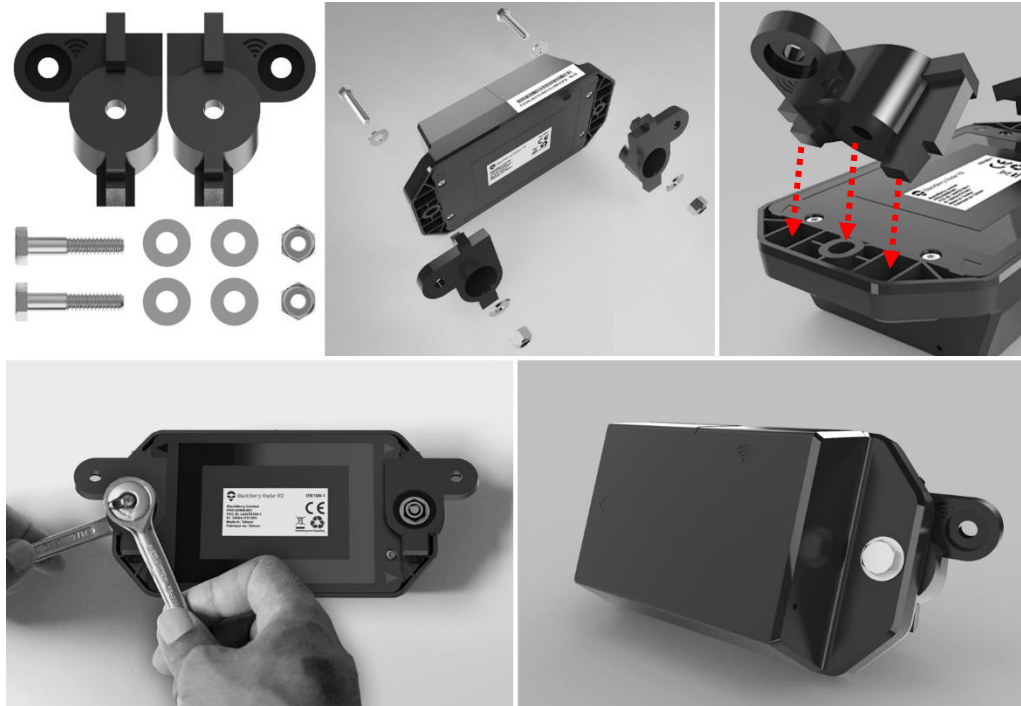

**IMPORTANT:** Ensure the signal icon on each Radar R2 Chassis Bracket is placed in the same orientation as the signal icon on the Radar R2 module.

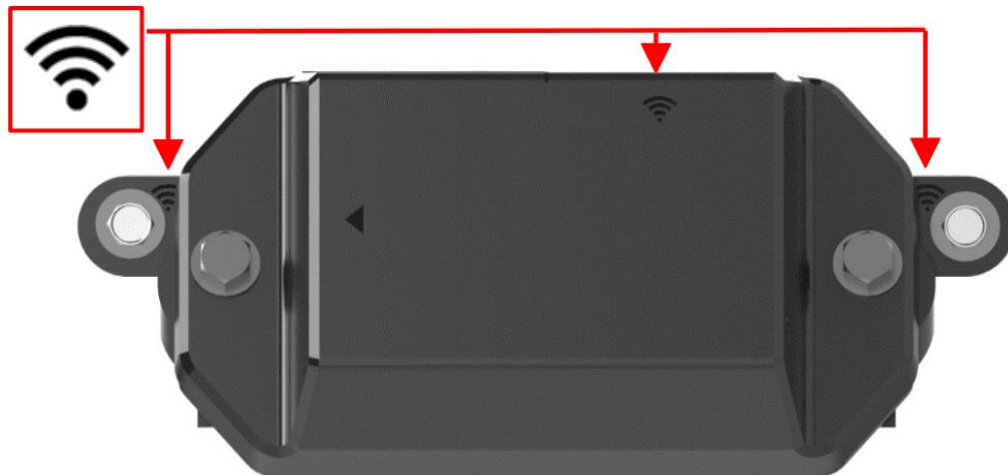

The module is prepared for installation on the asset.

### 3.4.2 Installing the module on an asset

1. As indicated in Section 3.3 of this guide, record the module identifier and the asset identifier the module will be paired with. For your convenience, you may quickly create a record of the module and asset pairings by removing the partially attached label from the front of the module and placing it on the installation worksheet, next to the asset that will be tracked by the module.



**Tip:** For modules that have previously been transferred to new assets, the temporary S/N label may no longer be in place. If this is the case, you will need to write the module identifier (S/N) for each module on the installation worksheet.

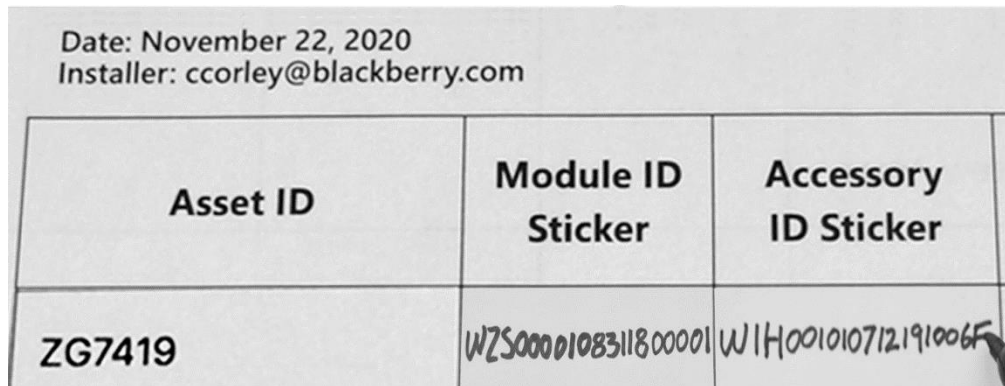

The following sections of this guide will illustrate recommended installation methods for various asset scenarios.



### 3.4.3 Chassis installation procedure—Container On/Off detection

If you are using BlackBerry Radar R2 to monitor a chassis trailer, you may mount the module on any flat, vertical surface that offers enough mounting area for the module. When selecting a mounting location, carefully consider how the asset will be used in its normal, day-to-day operation.

Do not place the assembly in a location where it is susceptible to damage from:

- Normal usage activities, such as loading or unloading cargo.
- Moving parts of the asset.
- Road debris.

When mounting under a vehicle or piece of equipment, you must exercise a high degree of caution to avoid serious damage to yourself or your equipment:

- Do not install near exhaust sources, ignition sources, or fuel tanks.
- Be careful when installing near pneumatic, hydraulic, and electrical lines to prevent damage to these components during the installation process.

When mounted on a chassis trailer, the BlackBerry Radar R2 can perform two functions—(1) Container On/Off Detection and (2) Weight Detection. Each function has its own specific set of installation instructions. In this section, we will cover the installation instructions for the Container On/Off Detection use case.

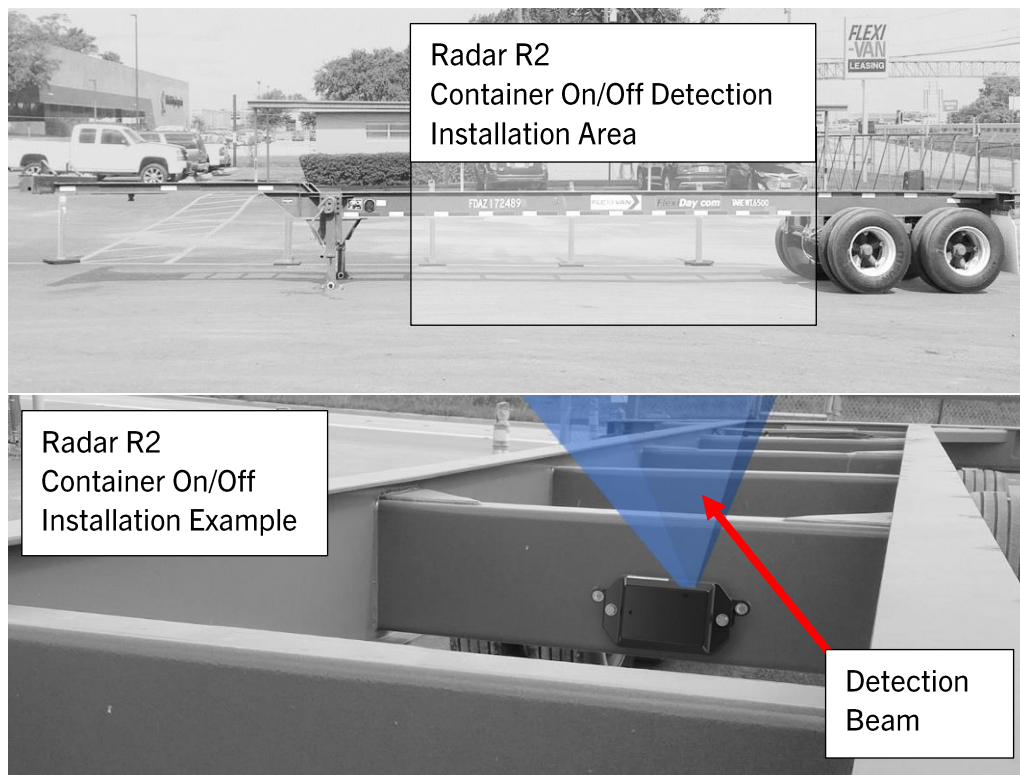

### BlackBerry Radar H2 + BlackBerry Radar R2 Relationship

To use your BlackBerry Radar R2, it must be paired with a BlackBerry Radar H2. For detailed Radar H2 Chassis Installation Instructions, please review the BlackBerry Radar H2 Chassis Installation Guide, located at [docs.radar.blackberry.com](https://docs.radar.blackberry.com).

To aid in your installation, your R2 and H2 modules have been pre-paired. The module pairings are indicated by numbers, marked on the devices. Ensure you install the Radar R2 and H2 modules, with matching numbers, on the same asset.

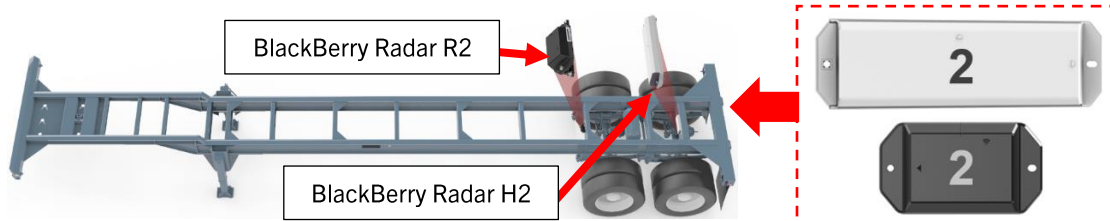

### Module Placement

When looking for an installation location on the chassis, it is important to choose an installation location that will provide an unobstructed view of the area, directly above the BlackBerry Radar R2 module. This unobstructed viewing area, above the module, will allow your BlackBerry Radar R2 to accurately detect the presence or absence of a container on the chassis, by sensing the container's underside.

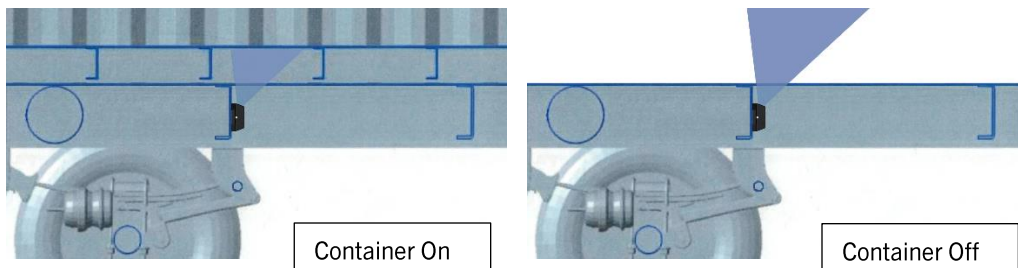

### Crossmember Profiles

- **C-Channel:** For chassis trailers with “C-channel” crossmembers, mount the module on the side of the crossmember without overhang to avoid blockage of the sensing area by the chassis crossmember overhang above the module.
- **I-Beam:** If all the crossmembers of your chassis have overhangs above the module that will obstruct the module’s sensing area (i.e., “I-Beam”), you will need to create a spacer that will place the rear surface of the device, flush with the forward edge of the overhangs. This will overcome the obstructions created by the overhangs.

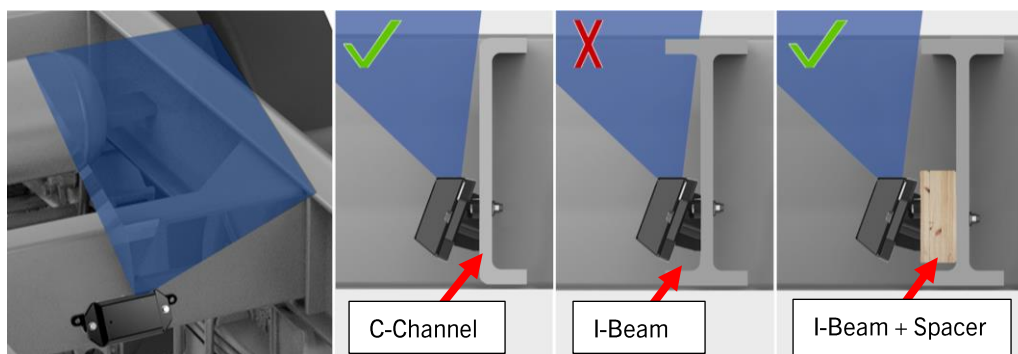

### Extendable Chassis/Multiple Container Installations

If you are installing on an extendable chassis or a chassis that can simultaneously support multiple containers, be sure to install your BlackBerry Radar R2 module in an area of the chassis that will be covered by the containers, when the containers are present.

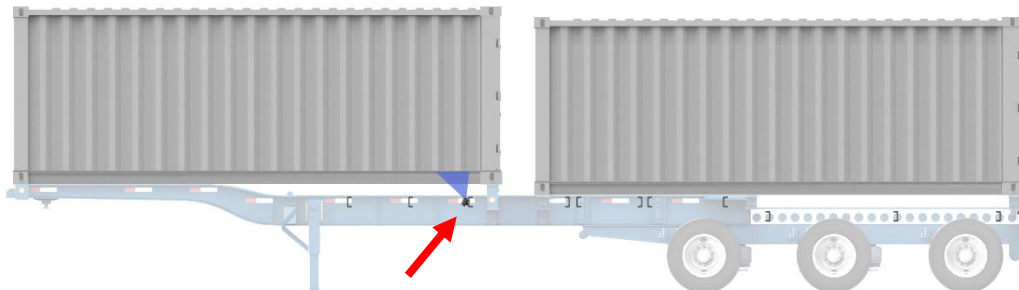
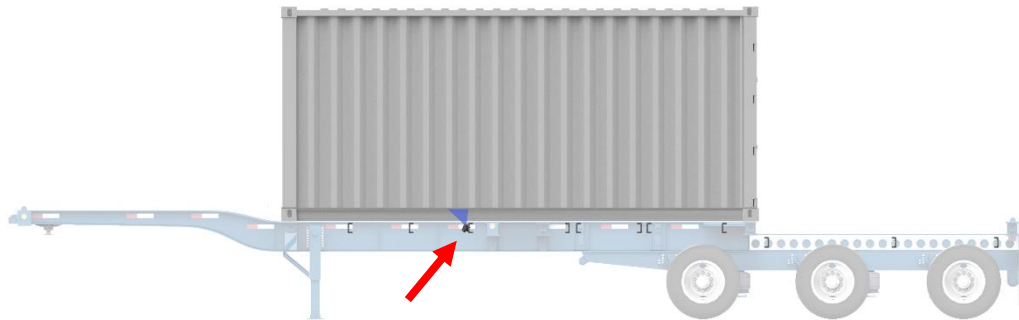
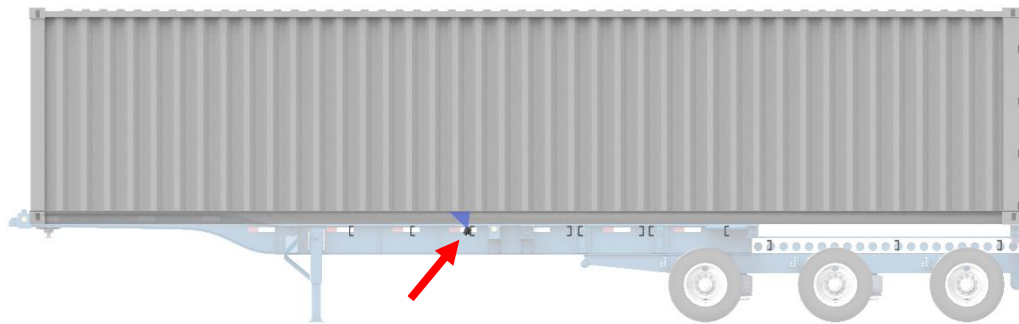
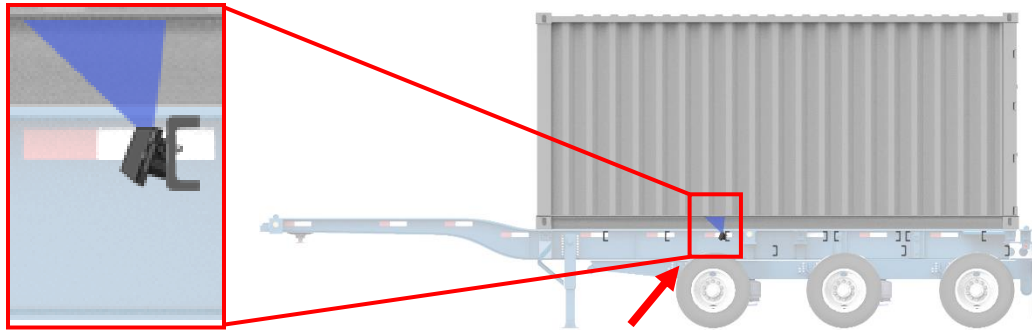



### Distance Above the Module

Once you have identified a suitable mounting area on the chassis, ensure there is a **minimum 6" (15 cm)** clearance between the top surface of the module and the surface that will support the corner fitting of the container. Depending on the chassis construction, this could be the top surface of the main frame rail or the twist lock surface.

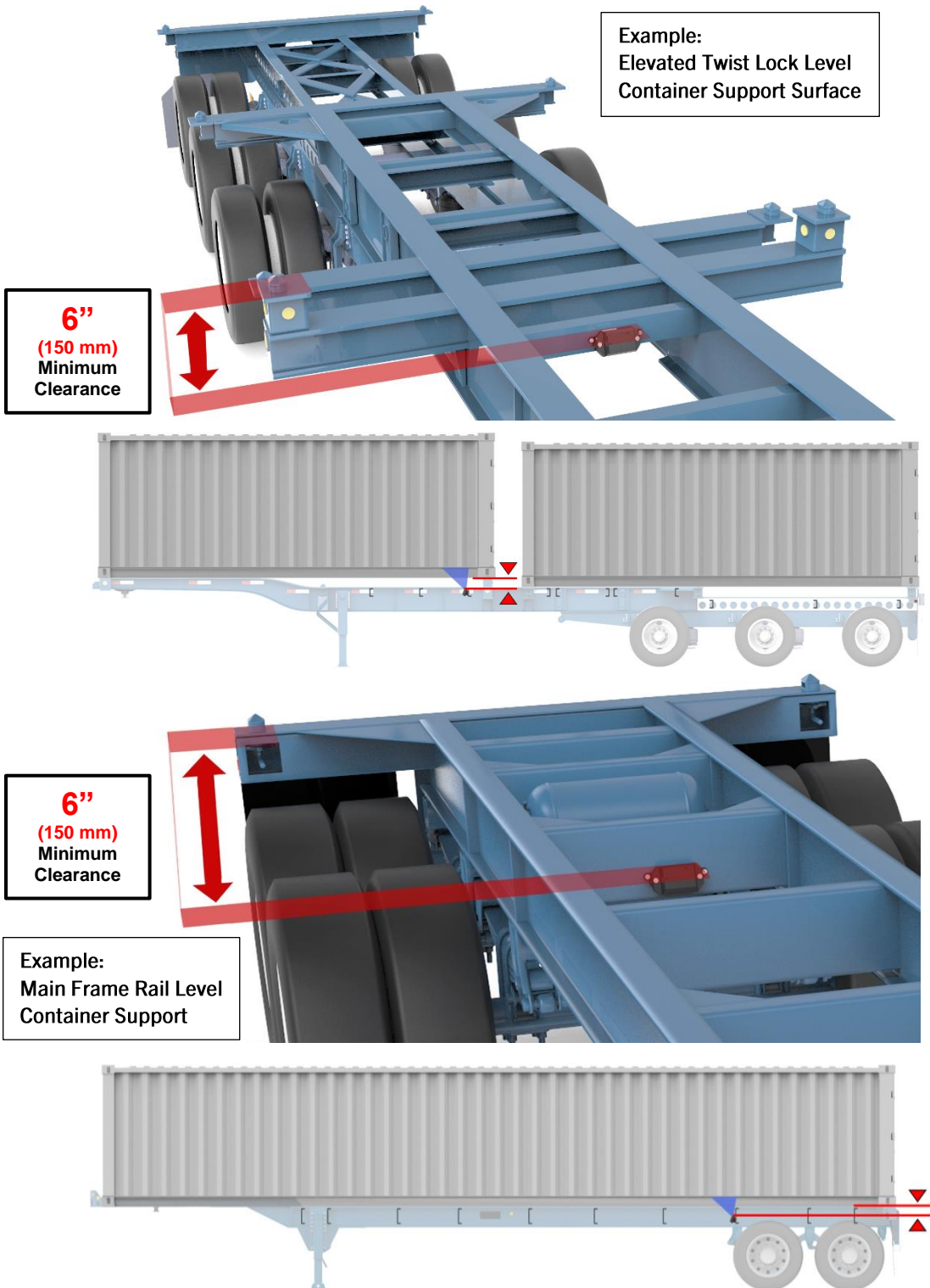

To achieve this minimum clearance, try to position the device as low on the chassis crossmember as you can, without extending the bottom of the module beyond the bottom edge of the crossmember. Extending the bottom edge of module beyond the bottom edge of the crossmember can expose the module to potential damage.



**IMPORTANT:** To accurately detect the presence of a container on the chassis, it is important to ensure there is a minimum clearance of 6" (15 cm) between the top surface of the device and the top surface of the main frame rail.

Maintaining this clearance will ensure there is adequate distance between the Radar R2 module and the container's floor to detect the presence of the container.

**Tip:** If the height of your chassis crossmember is too short to support the 6" (15 cm) clearance requirement without extending the bottom of the module beyond the bottom edge of the crossmember, search the chassis for a taller crossmember that could support the clearance requirement without overhanging the bottom edge of the crossmember. Some chassis have crossmembers of different heights.

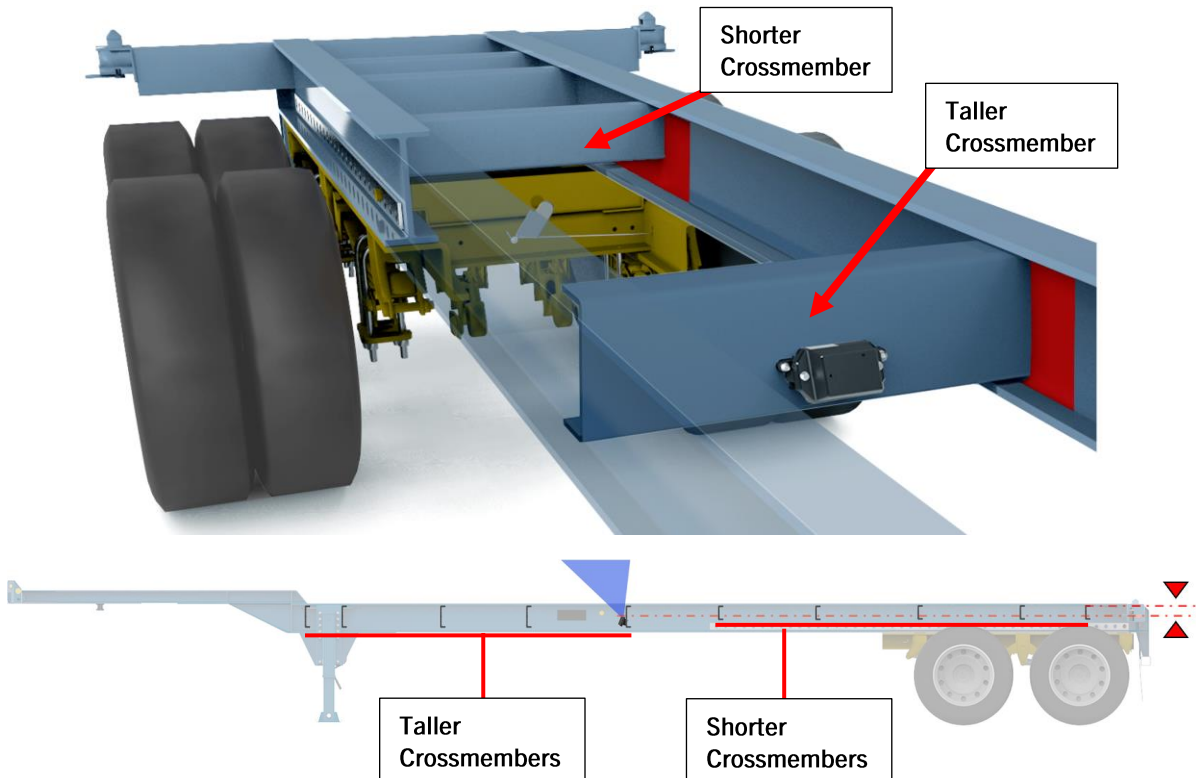

1. As indicated in Section 3.3 of this guide, record the module identifier and the asset identifier the module will be paired with. For your convenience, you may quickly create a record of the module and asset identifier pairings by removing the partially attached label from the inner housing of the module and placing it on the installation worksheet, next to the asset that will be tracked by this module.



2. After selecting the best installation location for your device, place the module and bracket in your desired installation location. Ensure the device is level. Use a pencil or marker to mark the holes in the bracket for drilling.

**IMPORTANT:** When mounting under a vehicle, or a piece of equipment, you must exercise a high degree of caution to avoid serious damage to yourself, the module, or your equipment:

- Do not install near exhaust sources, ignition sources, or fuel tanks.
- Use caution when installing near pneumatic, hydraulic, and electrical lines to avoid damage to these systems during installation.

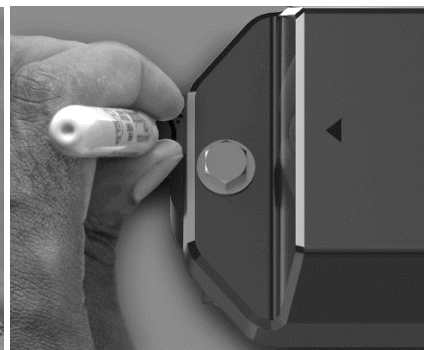

- Using a drill bit, drill a hole through each of the marked holes. This will create two holes you will use to mount the brackets to the container. If there are any burrs around the holes after the drilling process, remove them. Also, remove any dust or debris left over from the drilling or de-burring operations.

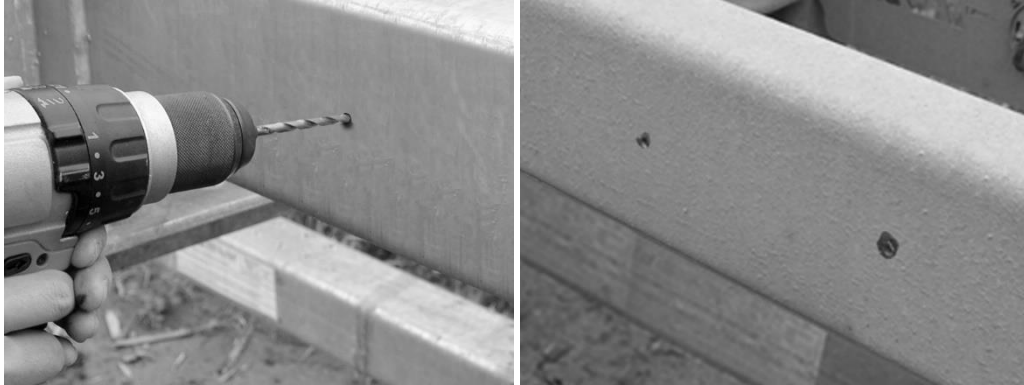

#### Drilling tips for chassis and frame installations

Due to the thicker, harder steel used on chassis and trailer frames, you may wish to follow these suggestions.

**Tip 1:** To shorten drilling time and prolong the life of your drill bit, you may wish to use cutting tool lubricant during the drilling process.

**Tip 2:** For most precise hole drilling, before drilling your hole, you may wish to use a punch and hammer to help place the drill bit. This will prevent the bit from “walking” during the drilling operation.

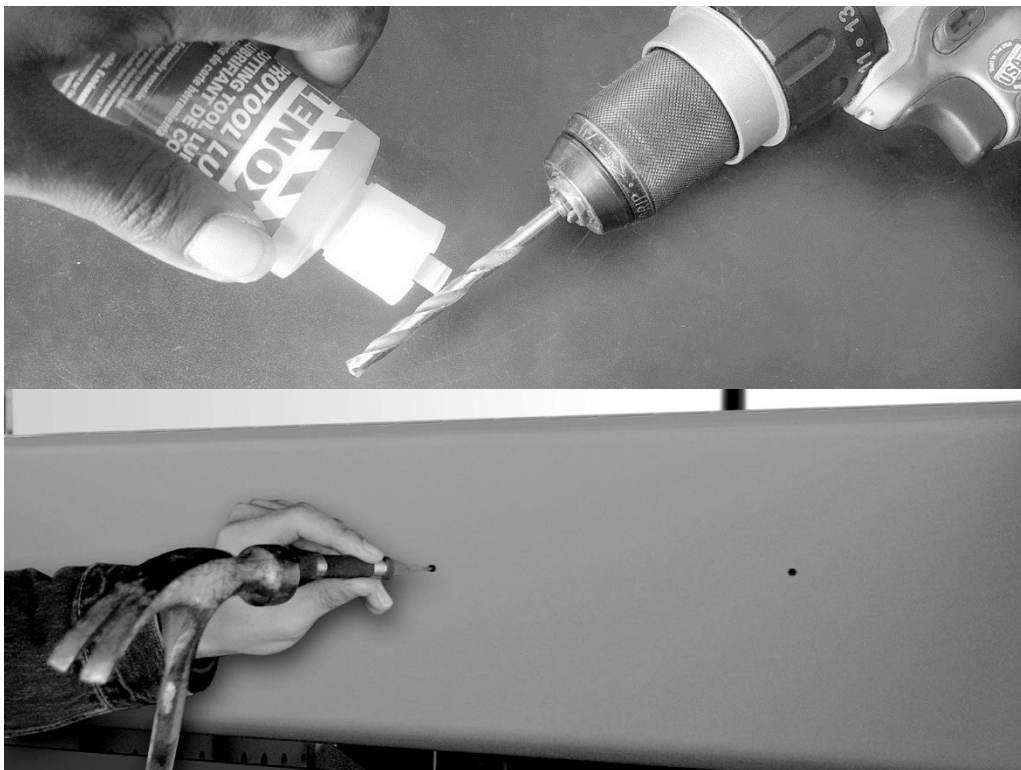



4. Place the module on the chassis, aligning the holes on the module with the holes you drilled into the chassis.



Insert your fastener of choice into the holes and use the appropriate tools to secure the module to the asset. Do not tighten fastener beyond 35 in-lb. (4 N-m).



**Tip:** If you choose to use a self-drilling screw on an installation surface whose construction leaves the sharp point of the screw exposed, you may wish to remove the pointed end of the screw after the module is mounted to the chassis. This can prevent possible injury, or damage, from the exposed screw ends.

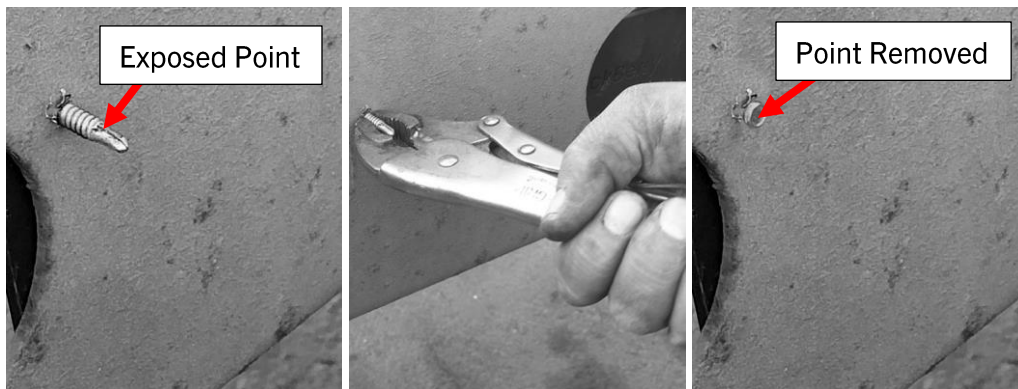

5. Installation is complete.



## 4 Removing BlackBerry Radar R2 modules

Use this procedure if you need to remove your BlackBerry Radar R2 module for servicing or recycling.

For more information on obtaining service for your devices, or recycling and safe disposal of your devices and batteries, contact your BlackBerry representative, or visit the following:





**blackberry.com/RadarSupport**--for information on service and the recycling and safe disposal of your device and battery.

**Note:** If you plan to ship your Radar R2 module, or Radar R2 battery, please be aware that the ***battery, and the module when shipped along with the battery***, is considered Fully Regulated Class 9 Dangerous Goods in all modes of transportation (Air, Ocean, and Ground) and must only be shipped in special UN certified Dangerous Goods packaging. If you are returning the battery, or battery with module to BlackBerry, you may request this UN-certified packaging from BlackBerry. The Radar R2 module, when shipped ***without*** the battery, is not considered Dangerous Goods and can be shipped in any package.

Also, any person who handles, offers for transport, or transports Dangerous Goods must be adequately trained and hold a training certificate; or perform those activities in the presence and under the direct supervision of a person who is adequately trained and who holds a training certificate.

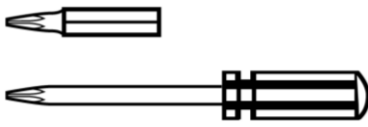
Products that are considered Dangerous Goods can only move on carrier accounts that are approved for Dangerous Goods and are subject to Dangerous Goods surcharges. The Radar R2 module, when shipped without the battery, are not subject to these surcharges.

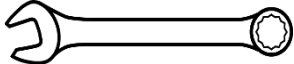
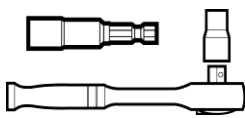
### 4.1 Removal Tools

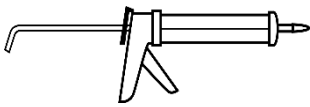
<p><b>Phillips (PH2) Screwdriver or Bit</b></p> 	<p><b>Drill</b></p> 	<p><b>Wrench</b></p>  <p>*Required only if nuts and bolts are used.</p>
<p><b>Nut Driver or Socket Wrench with Socket*</b></p>  <p>*Nut Driver + Drill offers fastest removal. If Nut Driver is un available, a socket wrench and socket may be used.</p>	<p><b>Safety Glasses</b></p> 	<p><b>Caulking Gun and Polyurethane Sealant</b></p>  <p>*Recommended for sealing holes.</p>

## 4.2 Module removal

1. Remove the module from the asset by removing the two fasteners from the ends of the module and remove the module.



## 4.3 Battery removal and replacement

### Battery removal

1. Remove the fasteners from the bracket. Remove the bracket from the module.

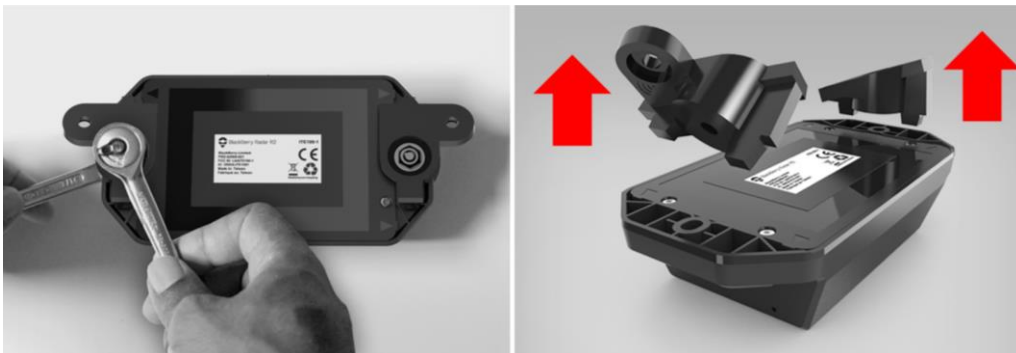



2. Remove the four screws from the back of the product and separate the inner housing from the outer housing to access the battery. Retain the screws as all screws will be required to re-secure the inner housing to the outer housing



3. Disconnect the battery cable from the battery connector.

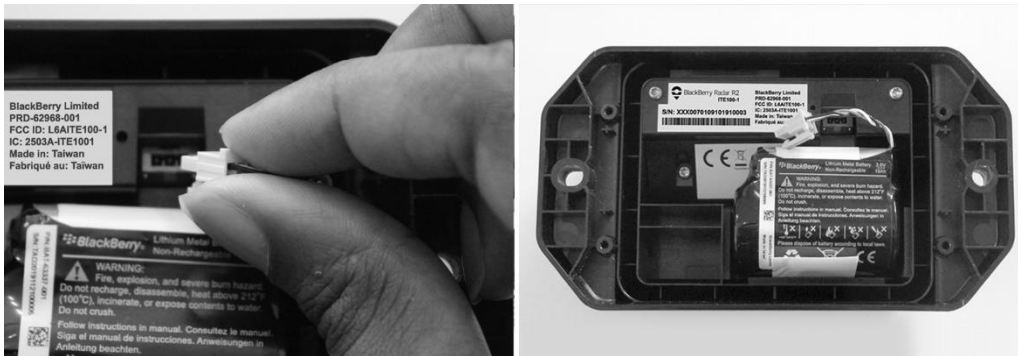

4. Remove the battery from the battery compartment by grasping the pull tab and lifting the battery out of the compartment.



## Battery replacement

1. Place the battery into the battery compartment.



2. Connect the battery cable to the battery connector. The LED will blink to indicate the module is active. **NOTE:** It can take up to 5 seconds for the blink sequence to begin. Please be patient. Once you see the LED blink, continue to the next step.

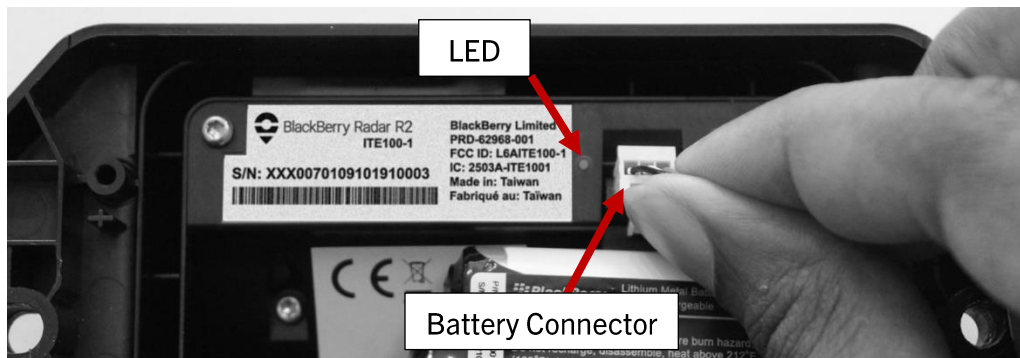

3. Fully install the battery door. Locate the four battery door screws. Using a Phillips PH2 screwdriver, install the screws to secure the battery door.

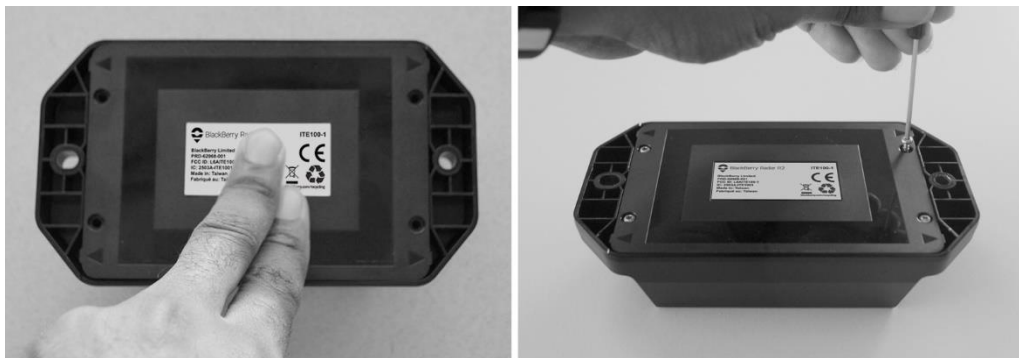

## Preparing battery for shipment

If you do need to ship the battery, along with the module, please follow this procedure.

**IMPORTANT:** Never ship the module with the battery cable connected. Battery must be shipped inside the module with battery cable disconnected and the battery connector placed under the battery.

1. Remove the four screws from the battery door. Insert a tool at the arrows and lift upward to remove the battery door. Retain the screws as they will be required to re-secure the battery door to the rear housing.

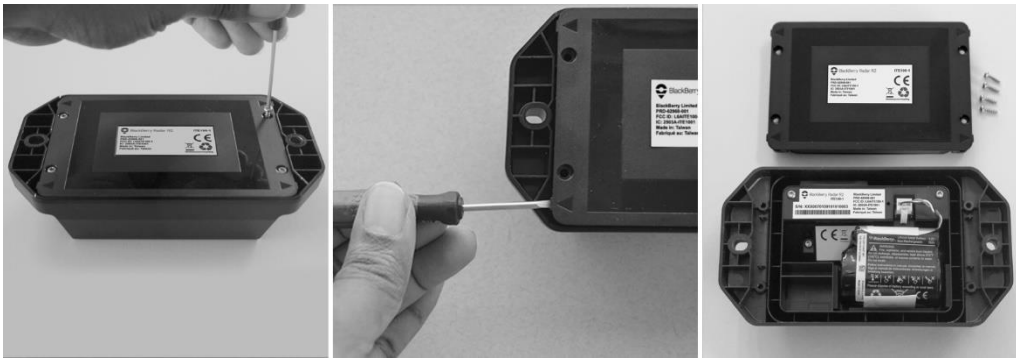

2. Ensure the battery cable is disconnected from the battery connector. Lift the battery and tuck the connector under the battery. Return the battery to the battery nest.

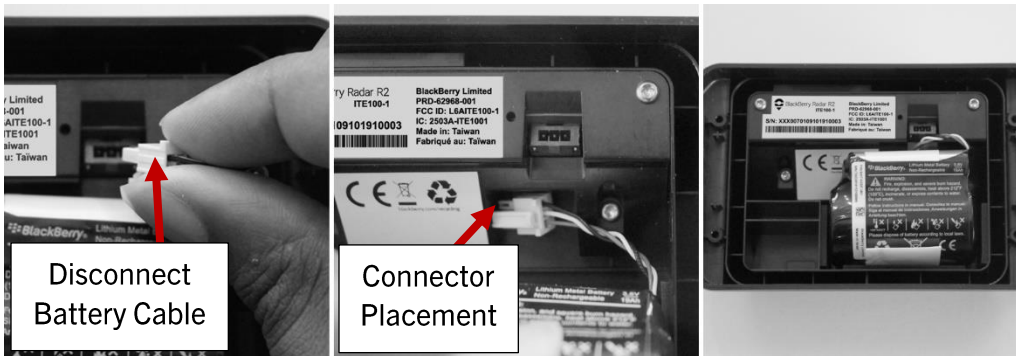

3. Place the battery cover onto the module and install the screws. Module is now ready to be placed in the UN certified Dangerous Goods packaging.

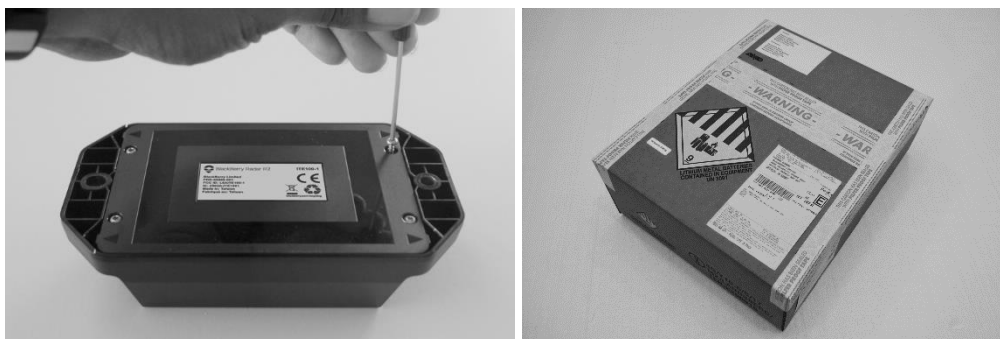

## 5 Support

If you run into any problem during the installation process, contact the BlackBerry Radar support team at 1-844-RADAR-BB.

## Legal notice

©2020 BlackBerry. All rights reserved. BlackBerry® and related trademarks, names, and logos are the property of BlackBerry Limited and are registered and/or used in the U.S. and countries around the world. All other trademarks are the property of their respective owners.

This documentation, including any references to third-party sources of information, hardware or software, products or services (“Third Party Products and Service”), is provided or made accessible "AS IS" and "AS AVAILABLE" and without condition, endorsement, guarantee, representation, or warranty of any kind by BlackBerry Limited and its affiliated companies ("BlackBerry"). BlackBerry assumes no responsibility for any typographical, technical, or other inaccuracies, errors, or omissions in this documentation and reserves the right to periodically change information that is contained in this documentation.

The terms of use of this documentation and any BlackBerry product or service are set out in a separate license or other agreement with BlackBerry applicable thereto. Certain features outlined in this documentation may require Third Party Products and Services and your use of Third Party Products and Services shall be governed by and subject to you agreeing to the terms of separate agreements applicable thereto with third parties.

BlackBerry Limited  
2200 University Avenue East  
Waterloo, Ontario  
Canada N2K 0A7

Published in Canada