

TEST REPORT FOR CERTIFICATION
On Behalf of
Chungear Industrial Co., Ltd
Ceiling Fan Remote Controller (Transmitter)
Model No.: TR82E
FCC ID: KIJCE10005

Prepared for : Chungear Industrial Co., Ltd
106 Kanho Rd., Taichung, Taiwan

Prepared By : AUDIX Technology Corporation
EMC Department
No. 53-11, Dingfu, Linkou Dist.,
New Taipei City 244, Taiwan, R.O.C.

Tel : (02) 2609-9301, 2609-2133
Fax : (02) 2609-9303

File Number : C1M1110236
Report Number : EM-F1001037
Date of Test : Nov. 30 ~ Dec. 12, 2011
Date of Report : Dec. 13, 2011

TABLE OF CONTENTS

Description	
Page	
TEST REPORT CERTIFICATION	3
1. GENERAL INFORMATION	4
1.1. Description of Device (EUT)	4
1.2. Tested Supporting System Details	5
1.3. Description of Test Facility	5
1.4. Measurement Uncertainty	6
2. CONDUCTED EMISSION MEASUREMENT	7
2.1. Test Equipment	7
2.2. Block Diagram of Test Setup	7
2.3. Conducted Emission Limits (§15.207)	7
2.4. Operating Condition of EUT	8
2.5. Test Procedure	8
2.6. Conducted Emission Measurement Results	8
3. RADIATED EMISSION MEASUREMENT	11
3.1. Test Equipment	11
3.2. Test Setup	11
3.3. Radiation Emission Limits (§15.209)	13
3.4. Operating Condition of EUT	13
3.5. Test Procedure	14
3.6. Radiated Emission Noise Measurement Results	15
4. FUNDAMENTAL MEASUREMENT	17
4.1. Test Equipment	17
4.2. Test Setup	17
4.3. Radiation Emission Limits (15.231)	18
4.4. Operating Condition of EUT	18
4.5. Test Procedure	18
4.6. Fundamental Measurement Results	19
5. EMISSION BANDWIDTH MEASUREMENT	20
5.1. Test Equipment	20
5.2. Block Diagram of Test Setup	20
5.3. Specification Limits (§15.231-(c))	20
5.4. Emission Bandwidth Measurement Results	20
6. PERIODIC OPERATED MEASUREMENT	22
6.1. Test Equipment	22
6.2. Block Diagram of Test Setup	22
6.3. Specification Limits [§15.231-(a)-(1)]	22
6.4. Periodic Operated Measurement Results	22
7. DEVIATION TO TEST SPECIFICATIONS	24
8. PHOTOGRAPHS	25
8.1. Photos of Conducted Emission Measurement	25
8.2. Photos of Radiated Measurement at Semi-Anechoic Chamber (30~1000MHz)	25
8.3. Photos of Radiated Measurement at Semi-Anechoic Chamber (Above 1GHz)	26
8.4. Photo of Section RF Conducted Measurement	26

TEST REPORT CERTIFICATION

Applicant : Chungear Industrial Co., Ltd
 Manufacturer #1 : Chungear Industrial Co., Ltd
 Manufacturer #2 : Satellite Electronic (Zhongshan) Ltd.
 Manufacturer #3 : Zhongshan Amity Electronic Ltd.
 Manufacturer #4 : ZHONGSHAN KONG LUEN WAH HOI ELECTRICAL
 APPLIANCE CO LTD
 EUT Description : Ceiling Fan Remote Controller (Transmitter)
 FCC ID : KIJCE10005
 (A) Model No. : TR82E
 (B) Serial No. : N/A
 (C) Power Supply : AC 120V/60Hz
 (D) Test Voltage : AC 120V/60Hz

Measurement Procedure Used:

FCC RULES AND REGULATIONS PART 15 SUBPART C, October 2010
 AND ANSI C63.4/2003

(FCC CFR 47 Part 15C, §15.207, §15.209 and §15.231)

The device described above was tested by AUDIX Technology Corporation to determine the maximum emission levels emanating from the device. The maximum emission levels were compared to the FCC Part 15 subpart C limits both radiated and conducted emissions.

The measurement results are contained in this test report and AUDIX Technology Corporation is assumed full responsibility for the accuracy and completeness of these measurements. Also, this report shows that the EUT to be technically compliant with the FCC official limits.

This report applies to above tested sample only. This report shall not be reproduced in part without written approval of AUDIX Technology Corporation.

Date of Test : Nov. 30 ~ Dec. 12, 2011 Date of Report : Dec. 13, 2011

Producer : 
 (Fyfy Lin/Assistant Administrator)

Signatory: 
 (Ben Cheng/Manager)

1. GENERAL INFORMATION

1.1. Description of Device (EUT)

Description	:	Ceiling Fan Remote Controller (Transmitter)
Model Number	:	TR82E
FCC ID	:	KUJCE10005
Applicant	:	Chungear Industrial Co., Ltd 106 Kanho Rd., Taichung, Taiwan
Manufacturer #1	:	Chungear Industrial Co., Ltd. 106 Kanho Rd., Taichung, Taiwan
Manufacturer #2	:	Satellite Electronic (Zhongshan), Ltd No.15, Torch Hi-Tech Industrial Development Zone, Zhong Shan City Guangdong Province China
Manufacturer #3	:	Zhongshan Amity Electronic Ltd. No. 16 Torch Hi-Tech Industrial Development Zone, Zhong Shan City Guangdong Province China.
Manufacturer #4	:	ZHONGSHAN KONG LUEN WAH HOI ELECTRICAL APPLIANCE CO LTD SCIENCE & TECHNOLOGY DEVELOPMENT ZONE LANG WANG TOWN ZHONGSHAN GUANGDONG CHINA
Fundamental Frequency	:	304MHz
Power Supply	:	AC 120V/60Hz
DC Power Cord	:	Shielded, Undetachable, 0.15m
AC Power Cord	:	Shielded, Undetachable, 0.15m
Date of Receipt of Sample	:	Oct. 25, 2011
Date of Test	:	Dec. 08 ~ 12, 2011

* Ceiling Fan Remote Controller (Transmitter) - Receiver

- (1)Model No.: JY199, FCC by DoC
- (2)Model No.: JY326B, FCC by DoC
- (3)Model No.: JY326D, FCC by DoC
- (4)Model No.: MR36T, FCC by DoC
- (5)Model No.: MR36R, FCC by DoC
- (6)Model No.: MR58A, FCC by DoC
- (7)Model No.: MR56E, FCC by DoC

Remark:

Antenna requirement: This EUT's transmitter antenna is designed to be soldered on a printed circuit board, comply with §15.203 and inform to user that any change and modify is prohibited.

1.2. Tested Supporting System Details

1.2.1. LIGHT BULB

Watt : 60W

1.3. Description of Test Facility

Name of Firm : **AUDIX Technology Corporation**
EMC Department
 No. 53-11, Dingfu, Linkou Dist.,
 New Taipei City 244, Taiwan, R.O.C

Test Site : **No. 3 Shielded Room**
 (C3/Semi-AC) No. 67-4, Dingfu, Linkou Dist.,
 New Taipei City 244, Taiwan, R.O.C.

Semi-Anechoic Chamber
 No. 53-11, Dingfu, Linkou Dist.,
 New Taipei City 244, Taiwan, R.O.C.
 Federal Communication Commission
 Registration Number: 90993
 Date of Renewal: May 14, 2009

NVLAP Lab. Code : 200077-0

TAF Accreditation No : 1724

1.4. Measurement Uncertainty

Test Item	Frequency Range	Uncertainty (dB)
Conduction Test	150kHz~30MHz	±1.73dB
Radiation Test (Distance: 3m)	30MHz~300MHz	± 2.91dB
	300MHz~1000MHz	± 2.94dB
	Above 1GHz	± 4.35dB

Remark : Uncertainty = $ku_c(y)$

Test Item	Uncertainty
Emission Bandwidth (20dB)	± 0.2kHz
Periodic Operated	± 0.05s

2. CONDUCTED EMISSION MEASUREMENT

2.1. Test Equipment

The following test equipment was used during the conducted emission measurement :
(No. 4 Shielded Room)

Item	Type	Manufacturer	Model No.	Serial No.	Last Cal.	Next Cal.
1.	Test Receiver	R&S	ESCS30	100339	Mar. 08, 11'	Mar. 07, 12'
2.	A.M.N.	R&S	ENV4200	825358/003	Dec. 30, 10'	Dec. 29, 11'
3.	L.I.S.N.	Kyoritsu	KNW-407	8-1430-5	Sep. 08, 11'	Sep. 07, 12'

2.2. Block Diagram of Test Setup

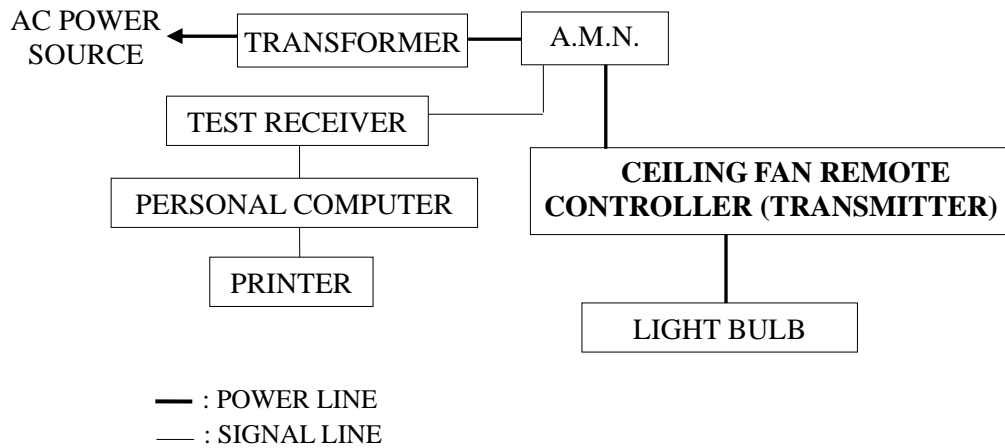

2.3. Conducted Emission Limits (§15.207)

Frequency	Maximum RF Line Voltage	
	Quasi-Peak Level	Average Level
150kHz ~ 500kHz	66 ~ 56 dB μ V	56 ~ 46 dB μ V
500kHz ~ 5MHz	56 dB μ V	46 dB μ V
5MHz ~ 30MHz	60 dB μ V	50 dB μ V

Remark 1.: If the average limit is met when using a Quasi-Peak detector, the EUT shall be deemed to meet both limits and measurement with the average detector is unnecessary.

2.: The lower limit applies at the band edges.

2.4. Operating Condition of EUT

- 2.4.1. Set up the EUT and simulator as shown on 2.2.
- 2.4.2. Turn on the power of all equipment.
- 2.4.3. The EUT was linked to the light bulb and on normal function during all testing.

2.5. Test Procedure

The EUT was put on table which was above the ground by 80cm and its AC adapter's power cord connected to the AC mains through an Artificial Mains Network (A.M.N.). The other peripheral devices power cord connected to the power mains through a line impedance stabilization network (L.I.S.N.). This provided a 50 ohm coupling impedance for the measuring equipment. (Please refer to the block diagram of the test setup and photographs.)

Both sides of A.C. line were checked for maximum conducted interference. In order to find the maximum emission, the relative positions simulators of the interface cables should be manipulated according to ANSI C63.4-2003, RSS-Gen and RSS-210 regulation during conducted measurement.

The bandwidth of the R&S Test Receiver ESCS30 was set at 9kHz.

The frequency range from 150kHz to 30MHz was checked.

All the final readings from Test Receiver were measured with the Quasi-Peak detector and Average detector. Remark: If the Average limit is met when using a Quasi-Peak detector, the Average detector is unnecessary)

2.6. Conducted Emission Measurement Results

PASSED.

(All the emissions not reported below are too low against the prescribed limits.)

The EUT was performed during this section testing and all the test results are attached in next pages.

EUT : Ceiling Fan Remote Controller (Transmitter)

M/N : TR82E

Test Date : Nov 30, 2011 Temperature : 27

Humidity : 60%

Reference Test Data : Neutral # 6; Line # 5



AUDIX TECHNOLOGY Corp. EMC Laboratory
 No.53-11, Tin-fu Tsun, Lin-kou Hsiang, Taipei
 County, Taiwan R.O.C. Post Code:24443
 Tel:+886-2-26092133 Fax:+886-2-26099303
 Email:ttemc@ttemc.com.tw

Data: 6 File: D:\Test&Photo\2011 DATA\C1M1110236\C1M1110236-C-D\C1M1110236-C-D.EMI (6)

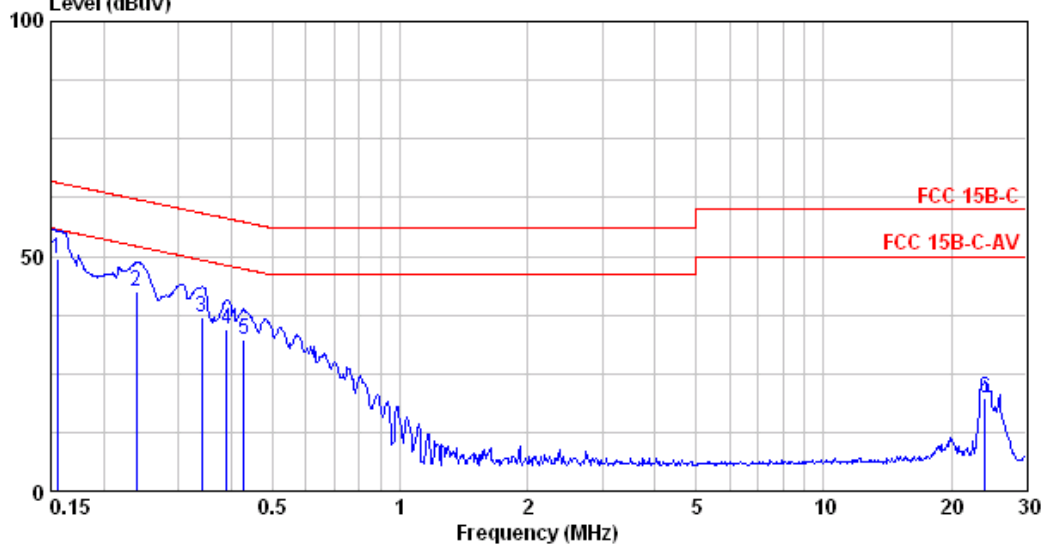

Site : NO.4 Shielded Room Data : 6
 Condition : ESH2-25 Phase : NEUTRAL
 Limit : FCC 15B-C
 Env. / Ins. : 27°C/60% ESCS 30 (339) Engineer: Ken-Yang
 EUT : TR82E
 Power Rating : 120Vac / 60Hz
 Test Mode : Operating

	Freq. (MHz)	LISN Factor (dB)	Cable Loss (dB)	Reading (dBµV)	Emission Level (dBµV)	Limits (dBµV)	Margin (dB)	Remark
1	0.156	0.22	0.24	49.14	49.60	65.69	16.09	QP
2	0.239	0.24	0.28	42.12	42.63	62.13	19.49	QP
3	0.341	0.25	0.31	36.50	37.06	59.18	22.12	QP
4	0.389	0.26	0.32	33.68	34.26	58.08	23.82	QP
5	0.428	0.26	0.33	31.68	32.27	57.29	25.02	QP
6	24.015	1.00	0.70	17.96	19.66	60.00	40.34	QP

Remarks: 1.Emission Level= LISN Factor + Cable Loss + Reading.
 2.If the average limit is met when using a quasi-peak detector ,the EUT shall be deemed to meet both limits and measurement with average detector is unnecessary.



AUDIX TECHNOLOGY Corp. EMC Laboratory
 No.53-11, Tin-fu Tsun, Lin-kou Hsiang, Taipei
 County, Taiwan R.O.C. Post Code:24443
 Tel:+886-2-26092133 Fax:+886-2-26099303
 Email:ttemc@ttemc.com.tw

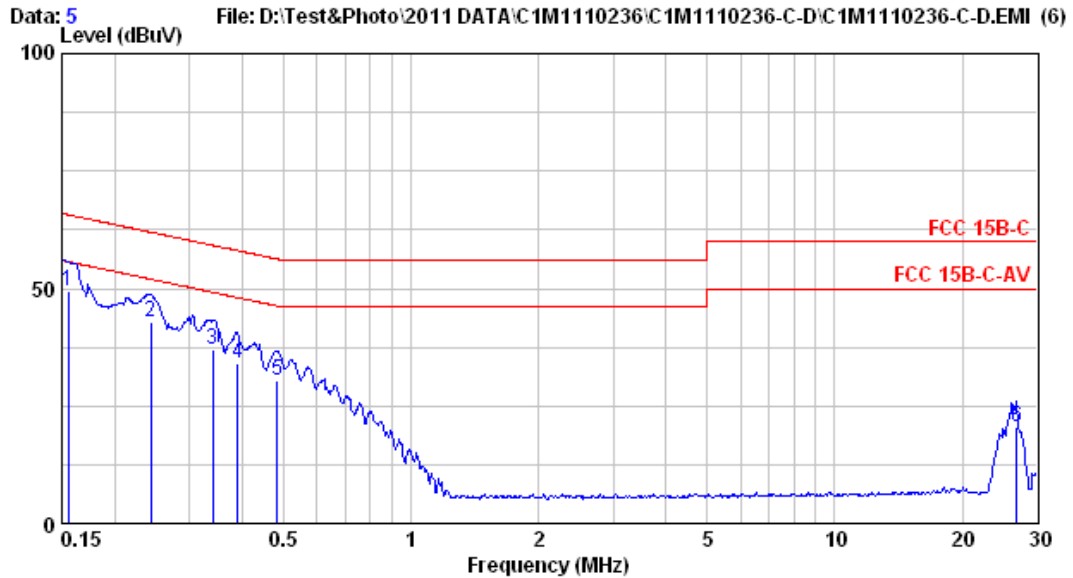

Site : NO.4 Shielded Room Data : 5
 Condition : ESH2-25 Phase : LINE
 Limit : FCC 15B-C
 Env. / Ins. : 27°C/60% ESCS 30 (339) Engineer: Ken-Yang
 EUT : TR82E
 Power Rating : 120Vac / 60Hz
 Test Mode : Operating

	Freq. (MHz)	LISN Factor (dB)	Cable Loss (dB)	Reading (dBµV)	Emission Level (dBµV)	Limits (dBµV)	Margin (dB)	Remark
1	0.156	0.22	0.24	49.14	49.60	65.69	16.09	QP
2	0.243	0.24	0.28	42.30	42.82	62.00	19.18	QP
3	0.341	0.25	0.31	36.50	37.06	59.18	22.12	QP
4	0.389	0.26	0.32	33.66	34.24	58.08	23.84	QP
5	0.484	0.27	0.34	29.98	30.58	56.27	25.69	QP
6	26.841	1.00	0.70	18.88	20.58	60.00	39.42	QP

Remarks: 1.Emission Level= LISN Factor + Cable Loss + Reading.
 2.If the average limit is met when using a quasi-peak detector ,the EUT shall be deemed to meet both limits and measurement with average detector is unnecessary.

3. RADIATED EMISSION MEASUREMENT

3.1. Test Equipment

The following test equipment was used during the radiated emission test:

3.1.1. For Frequency Range 30MHz~1000MHz (Semi-Anechoic Chamber)

Item	Type	Manufacturer	Model No.	Serial No.	Last Cal.	Next Cal.
1.	Spectrum Analyzer	Agilent	E4446A	US44300366	Aug. 04, 11'	Aug. 03, 12'
2.	Test Receiver	R & S	ESCS30	100338	Jul. 12, 11'	Jul. 11, 12'
3.	Amplifier	HP	8447D	2944A06305	Feb. 10, 11'	Feb. 09, 12'
4.	Log Periodic Antenna	Schwarzbeck	UHALP 9108-A	0810	Mar. 08, 11'	Mar. 07, 12'
5.	Biconical Antenna	CHASE	VBA6106A	1264	Mar. 08, 11'	Mar. 07, 12'
6.	Coaxial Switch	Anritsu	MP59B	6100226512	Feb. 01, 11'	Mar. 31, 12'

3.1.2. For Frequency Range above 1GHz (Semi-Anechoic Chamber)

Item	Type	Manufacturer	Model No.	Serial No.	Last Cal.	Next Cal.
1.	Spectrum Analyzer	Agilent	E4446A	US44300366	Aug. 04, 11'	Aug. 03, 12'
2.	Amplifier	HP	8449B	3008A00529	Dec. 10, 10'	Dec. 09, 11'
3.	Horn Antenna	EMCO	3115	9112-3775	May 09, 11'	May 08, 12'

3.2. Test Setup

3.2.1. Block Diagram of connection between EUT and simulators

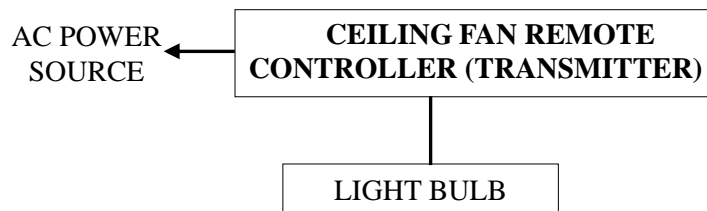

3.2.2. Semi-Anechoic Chamber (3m) Setup Diagram for 30-1000MHz

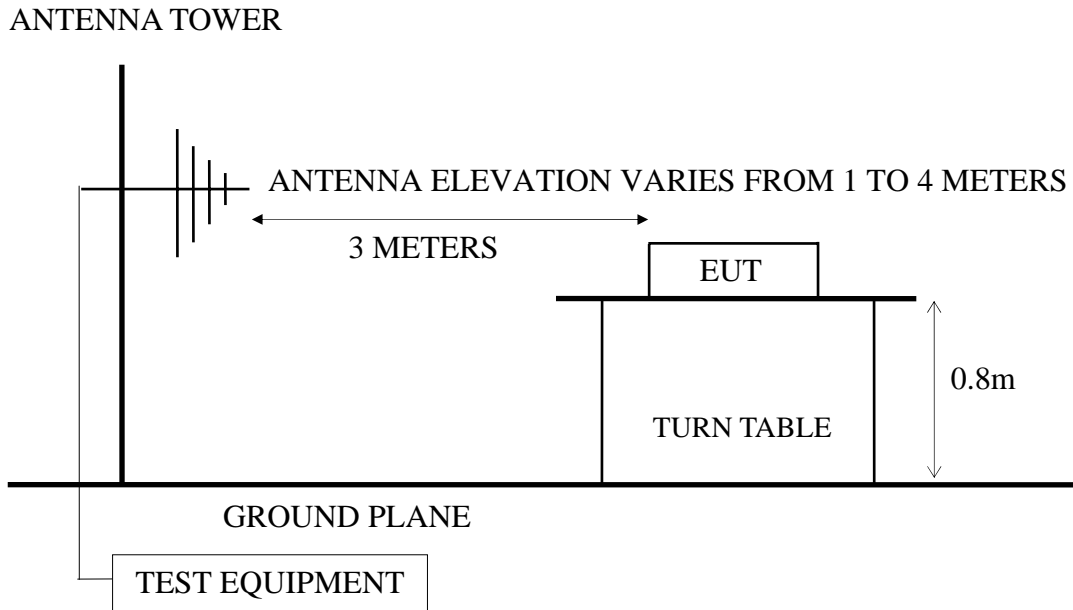

3.2.3. Semi-Anechoic Chamber (3m) Setup Diagram for above 1GHz

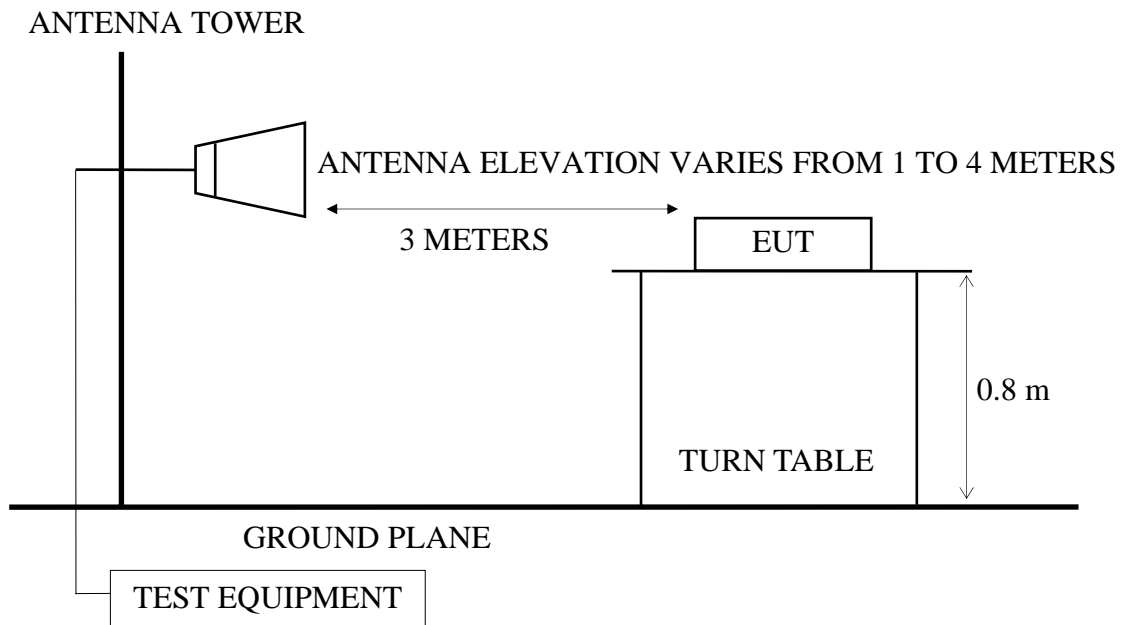

3.3. Radiation Emission Limits (§15.209)

3.3.1. Spurious Emission Limit (§15.209)

FREQUENCY MHz	DISTANCE Meters	FIELD STRENGTHS LIMITS	
		$\mu\text{V/m}$	$\text{dB}\mu\text{V/m}$
30 - 88	3	100	40.00
88 - 216	3	150	43.50
216 - 960	3	200	46.00
Above 960	3	500	54.00

- Remarks :
- (1) Emission level ($\text{dB}\mu\text{V/m}$) = $20 \log$ Emission level ($\mu\text{V/m}$)
 - (2) The tighter limit applies at the edge between two frequency bands.
 - (3) Distance refers to the distance in meters between the measuring instrument antenna and the closed point of any part of the device or system.

3.4. Operating Condition of EUT

- 3.4.1. Set up the **EUT {Ceiling Fan Remote Controller (Transmitter)}** and simulator as shown on 3.2.
- 3.4.2. Turn on the power.
- 3.4.3. The **EUT {Ceiling Fan Remote Controller (Transmitter)}** was operated on maximum transmitting status during all testing.

3.5. Test Procedure

The EUT and was placed on a turn table which was 0.8 meter above the ground. The turn table rotated 360 degrees to determine the position of the maximum emission level. EUT was set to 3 meters away from the receiving antenna which was mounted on an antenna tower. The antenna moved up and down between 1 to 4 meters to find out the maximum emission level. Broadband antenna such as calibrated biconical and log- periodical antenna or horn antenna were used as a receiving antenna. Both horizontal and vertical polarization of the antenna were set on measurement. In order to find the maximum emission, all of the interface cables were manipulated according to FCC ANSI C63.4-2003 regulation.

The bandwidth of test receiver was set at 120kHz for frequencies below 1GHz and resolution bandwidth of spectrum analyzer was set at 1MHz for frequencies above 1GHz.

The frequency range from 30MHz to 1000MHz was measured with Quasi-Peak detector.

The frequency range from 1GHz to up to 10th harmonics was pre-scanned with Peak detector.

EUT was tested during radiated measurement and all the test results are listed in section 3.6.

3.6. Radiated Emission Noise Measurement Results

3.6.1. Frequency Range 30MHz to 1GHz Measurement Results: PASSED.

All the emissions not reported below are too low against the FCC part 15 Subpart C limit.

Date of Test : Dec. 12, 2011 Temperature : 24
 EUT : Ceiling Fan Remote Controller (Transmitter) Humidity : 54%
 Test Mode : Operating

Emission Frequency MHz	Antenna Factor dB/m	Cable Loss dB	Meter Reading Horizontal dBμV	Emission Level Horizontal dBμV/m	Limits dBμV/m	Margin dB

Spurious / Harmonic Freq. (Quasi-Peak Value)						
75.090	12.72	1.80	10.16	24.68	40.00	15.32
102.090	17.29	2.10	2.99	22.38	43.50	21.12
249.240	23.74	3.50	1.22	28.45	46.00	17.55
609.400	21.45	6.20	16.43	44.09	46.00	1.91
911.800	24.99	7.40	9.20	41.59	46.00	4.41
964.300	26.80	7.60	0.26	34.66	54.00	19.34

Emission Frequency MHz	Antenna Factor dB/m	Cable Loss dB	Meter Reading Vertical dBμV	Emission Level Vertical dBμV/m	Limits dBμV/m	Margin dB

Spurious / Harmonic Freq. (Quasi-Peak Value)						
59.430	13.16	1.60	5.39	20.15	40.00	19.85
249.240	23.74	3.50	0.93	28.16	46.00	17.84
609.400	21.45	6.20	14.04	41.70	46.00	4.30
911.800	24.99	7.40	6.26	38.65	46.00	7.35

- Remarks : 1. Emission Level = Antenna Factor + Cable Loss + Meter Reading.
 2. Measurement was up to 10th harmonics (~4GHz), but the emission levels were too low against the official limit and not report.

3.6.2. Frequency Range 1GHz to up to 10th harmonics Measurement Results:
PASSED.

There is no emission be found from 1GHz to up to 10th harmonics.

4. FUNDAMENTAL MEASUREMENT

4.1. Test Equipment

The following test equipment was used during the radiated emission test:

Item	Type	Manufacturer	Model No.	Serial No.	Last Cal.	Next Cal.
1.	Spectrum Analyzer	Agilent	E4446A	US44300366	Aug. 04, 11'	Aug. 03, 12'
2.	Test Receiver	R & S	ESCS30	100338	Jul. 12, 11'	Jul. 11, 12'
3.	Amplifier	HP	8447D	2944A06305	Feb. 10, 11'	Feb. 09, 12'
4.	Log Periodic Antenna	Schwarzbeck	UHALP 9108-A	0810	Mar. 08, 11'	Mar. 07, 12'
5.	Biconical Antenna	CHASE	VBA6106A	1264	Mar. 08, 11'	Mar. 07, 12'
6.	Coaxial Switch	Anritsu	MP59B	6100226512	Feb. 01, 11'	Mar. 31, 12'

4.2. Test Setup

4.2.1. Block Diagram of connection between EUT and simulators

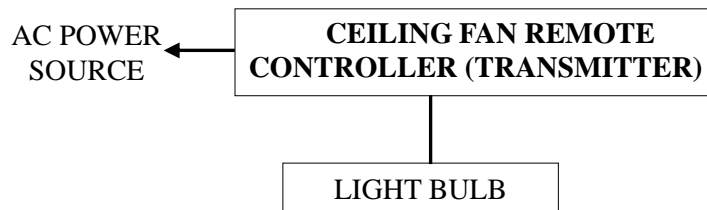

4.2.2. Semi-Anechoic Chamber (3m) Setup Diagram

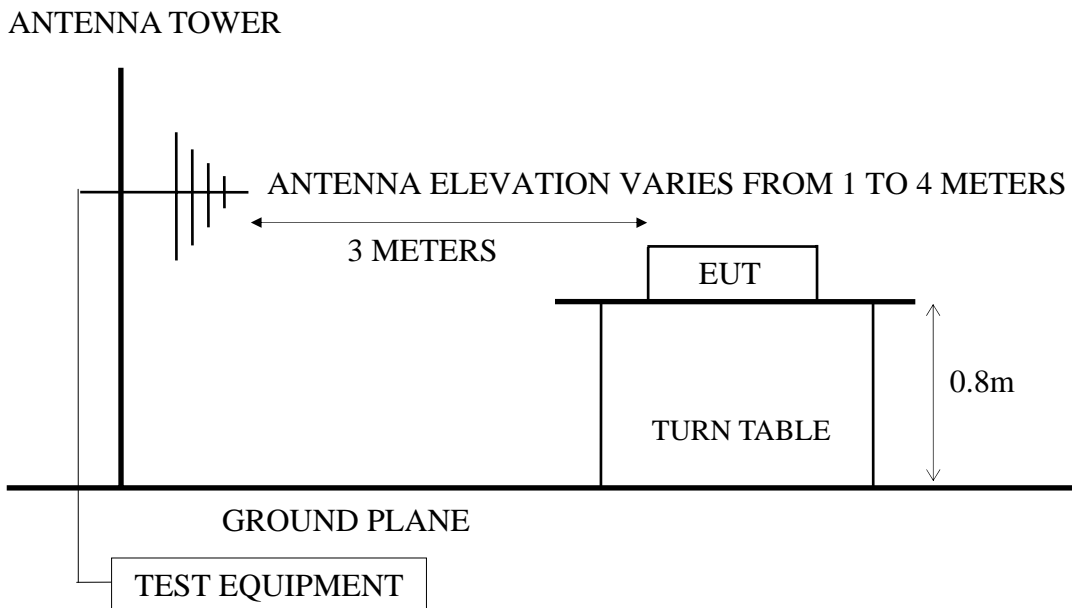

4.3. Radiation Emission Limits (15.231)

4.3.1. Fundamental Frequency Emission Limit (§15.231)

FREQUENCY MHz	DISTANCE Meters	FIELD STRENGTHS LIMITS	
		$\mu\text{V/m}$	$\text{dB}\mu\text{V/m}$
Fundamental Frequency	3	5583.3435	74.93 (Quasi-Peak)
Harmonic	3	558.468	54.93 (Quasi-Peak)

- Remarks :
- (1) Emission level ($\text{dB}\mu\text{V/m}$) = $20 \log$ Emission level ($\mu\text{V/m}$)
 - (2) The tighter limit applies at the edge between two frequency bands.
 - (3) Distance refers to the distance in meters between the measuring instrument antenna and the closed point of any part of the device or system.
 - (4) Where limit of Fundamental Freq. is calculated by: $41.6667 \times 304 - 7083.3333 = 5583.3435 \mu\text{V/m} = 74.93 \text{dB}\mu\text{V/m}$
 - (5) The limits in this table are based on CFR 47 Part 15.231(b).

4.4. Operating Condition of EUT

- 4.4.1. Set up the **EUT {Ceiling Fan Remote Controller (Transmitter)}** and simulator as shown on 4.2.
- 4.4.2. Turn on the power.
- 4.4.3. The **EUT {Ceiling Fan Remote Controller (Transmitter)}** was operated on maximum transmitting status during all testing.

4.5. Test Procedure

The EUT and was placed on a turn table which was 0.8 meter above the ground. The turn table rotated 360 degrees to determine the position of the maximum emission level. EUT was set to 3 meters away from the receiving antenna which was mounted on an antenna tower. The antenna moved up and down between 1 to 4 meters to find out the maximum emission level. Broadband antenna such as calibrated biconical and log- periodical antenna or horn antenna is used as a receiving antenna. Both polarizations horizontal and vertical are set on measurement. In order to find the maximum emission, all of the interface cables were manipulated according to FCC ANSI C63.4-2003 regulation.

EUT was tested during radiated measurement and all the test results are listed in section 4.6.

4.6. Fundamental Measurement Results



AUDIX TECHNOLOGY Corp. EMC Laboratory
 No.53-11, Tin-fu Tsun, Lin-kou Hsiang, Taipei
 County, Taiwan R.O.C. Post Code:24443
 Tel:+886-2-26092133 Fax:+886-2-26099303
 Email:ttemc@ttemc.com.tw

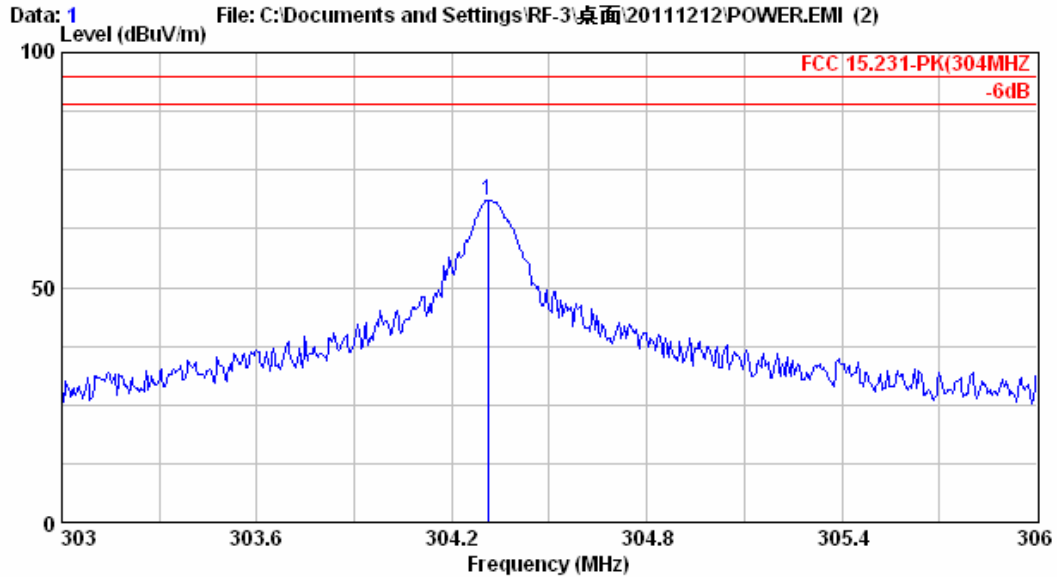

Site no. : A/C Chamber Data no. : 1
 Dis. / Ant. : 3m VBA6106A/UHALP9108A Ant. pol. : HORIZONTAL
 Limit : FCC 15.231-PK(304MHZ
 Env. / Ins. : E4446A 24°C/54% □Jarwei Wang
 EUT : TR82E
 Power Rating : 120Vac / 60HZ
 Test Mode : POWER

	Ant. Factor	Cable Loss	Reading	Emission Level	
Freq. (MHz)	(dB/m)	(dB)	(dBμV)	(dBμV/m)	
1 304.311	14.87	3.90	49.88	68.65	QP

Remarks: 1. Emission Level= Antenna Factor + Cable Loss + Reading.
 2. The emission levels that are 20dB below the official limit are not reported.

Horizontal is the strongest polarization and QP value has complied with limit, so vertical won't be listed in test report.

Because RBW of spectrum is larger than PRF, thus PDCF is no need for finding true peak level.

5. EMISSION BANDWIDTH MEASUREMENT

5.1. Test Equipment

The following test equipment was used during the Emission Bandwidth Test :

Item	Type	Manufacturer	Model No.	Serial No.	Last Cal.	Next Cal.
1.	Spectrum Analyzer	Agilent	N9010A-507	MY49061167	Feb. 24, 11'	Feb. 23, 12'
2.	Wide Band Antenna	Diamond	RH799	2944A06305	N/A	N/A

5.2. Block Diagram of Test Setup

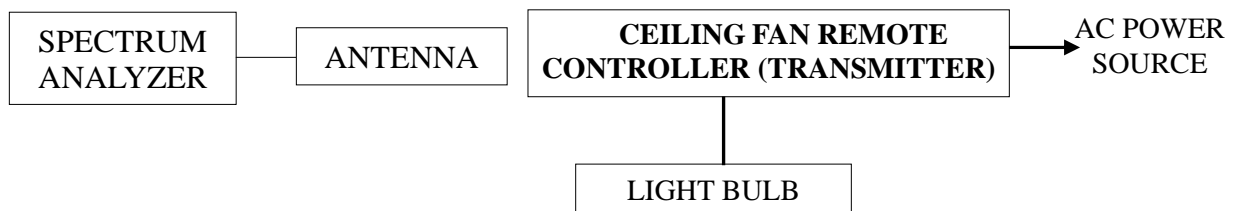

5.3. Specification Limits (§15.231-(c))

The bandwidth of emission shall be no wider than 0.25% of the center frequency for device operating above 70MHz and below 900MHz. Bandwidth is determined at the points 20dB down from the modulated carrier.

5.4. Emission Bandwidth Measurement Results

PASS.

Fundamental Frequency: 304MHz

Test Date: Dec. 12, 2011 Temperature: 24 Humidity: 54%

No.	Center Frequency	Bandwidth	Tolerance (%)
1.	304.000MHz	36kHz	0.01184%

The bandwidth of emission was measured at the point 20dB down from the center frequency of modulated carrier.

Graph of Bandwidth Measurement

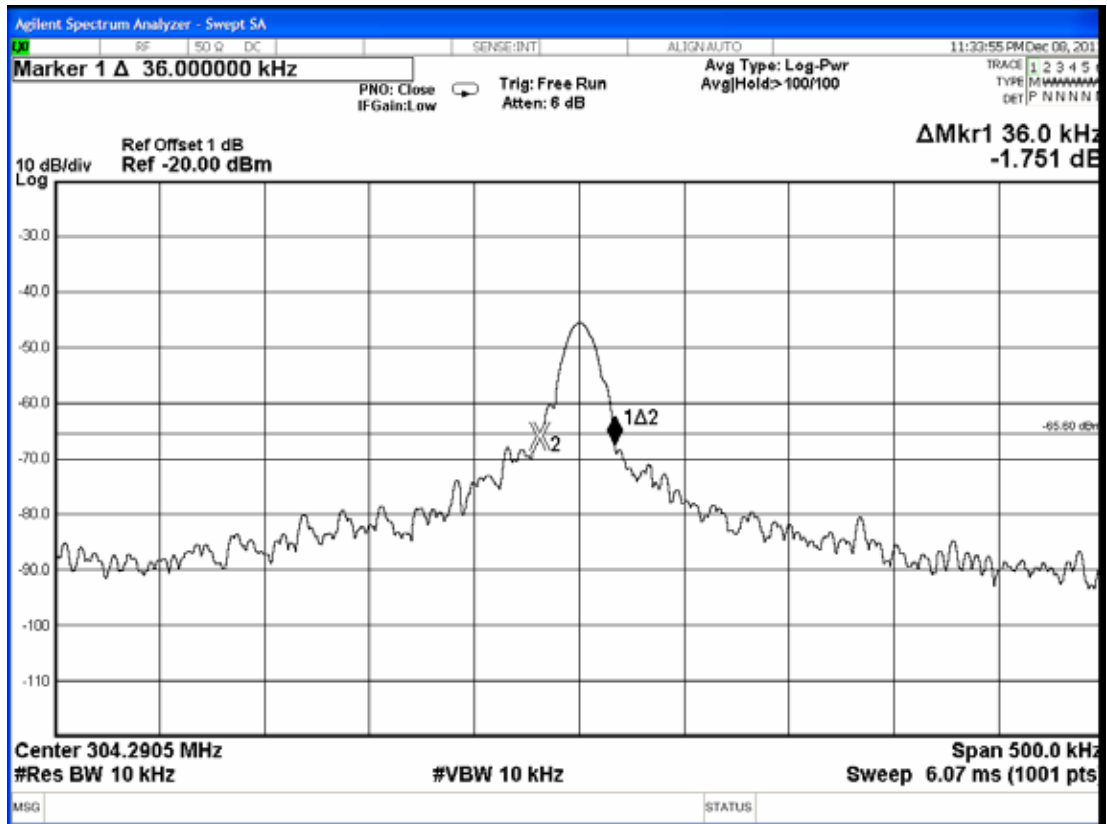

Note: “◇” The line is 20dB from the modulated carrier.

6. PERIODIC OPERATED MEASUREMENT

6.1. Test Equipment

The following test equipment was used during the periodic operated test :

Item	Type	Manufacturer	Model No.	Serial No.	Last Cal.	Next Cal.
1.	Spectrum Analyzer	Agilent	N9010A-507	MY49061167	Feb. 24, 11'	Feb. 23, 12'
2.	Wide Band Antenna	Diamond	RH799	2944A06305	N/A	N/A

6.2. Block Diagram of Test Setup

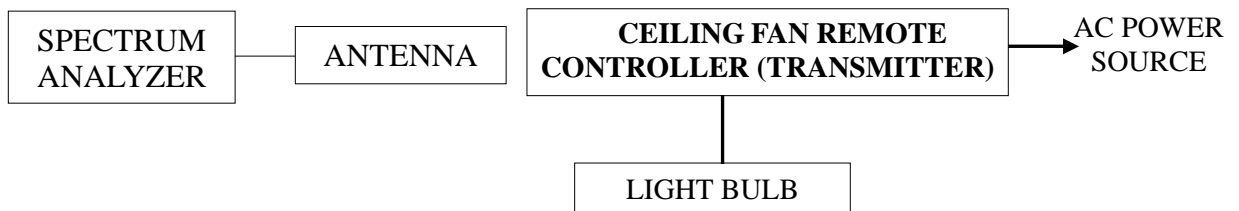

6.3. Specification Limits [§15.231-(a)-(1)]

The operation of this device is manually operated transmitter that is automatically deactivated the transmitter within not more than 5 seconds of being released, Compliance with §15.231 (a)- (1).

6.4. Periodic Operated Measurement Results

PASS. T = 0.63s. (< 5sec.)

Fundamental Frequency: 304MHz

Test Date: Dec. 12, 2011 Temperature: 24 Humidity: 54%

The graph of testing is attached in next page.

Graph of Periodic Operated Measurement

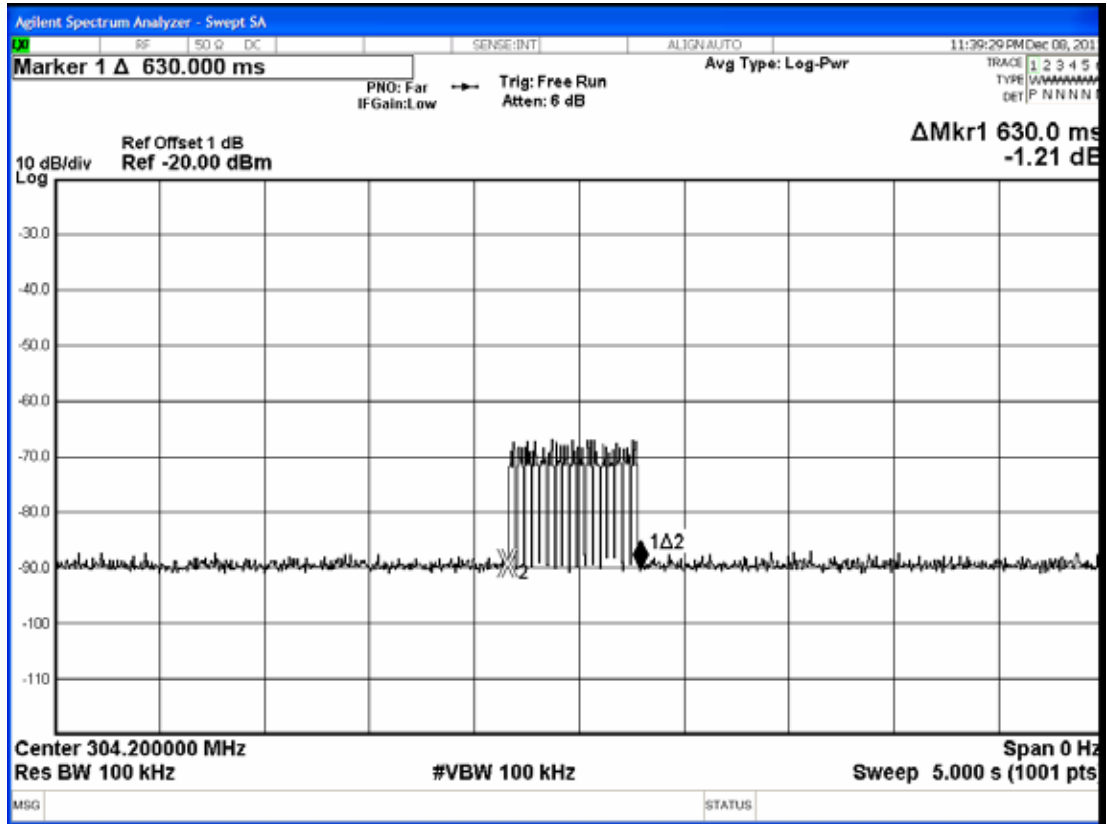

7. DEVIATION TO TEST SPECIFICATIONS

【NONE】