



# ***Gobi™2000 Module FCC Part 22 & 24 Conducted Test Report***

**80-VN379-203 Rev. A**

**December 19, 2008**

---

**Submit technical questions to:  
regulatory.support@qualcomm.com**

QUALCOMM is a registered trademark of QUALCOMM Incorporated in the United States and may be registered in other countries. Other product and brand names may be trademarks or registered trademarks of their respective owners. CDMA2000 is a registered certification mark of the Telecommunications Industry Association, used under license, ARM is a registered trademark of ARM Limited. QDSP is a registered trademark of QUALCOMM Incorporated in the United States and other countries.

This technical data may be subject to U.S. and international export, re-export, or transfer (“export”) laws. Diversion contrary to U.S. and international law is strictly prohibited.

QUALCOMM Incorporated  
5775 Morehouse Drive  
San Diego, CA 92121-1714  
U.S.A.

Copyright © 2008 QUALCOMM Incorporated.  
All rights reserved.

## Terms and Conditions of Usage

This document may refer to or describe parts whose manufacture, use, sale, offer for sale, or importation into the United States are limited or prohibited by one or more U.S. Federal Court injunctions against QUALCOMM Incorporated. This document is not to be construed as an offer to sell such parts for use or importation into the U.S., nor should it be construed as assistance in making, using, selling, offering to sell, or the importation of any product in the U.S. containing such parts. This document is intended solely to provide information for those products that are outside the scope of the injunction. Recipient's download and/or use of the information in this document constitutes agreement with these terms

December 19, 2008

Gobi™2000 Module FCC Part 22 & 24 Conducted Test Report  
80-VN379-203 Rev. A

# ***Gobi™2000 Module FCC Part 22 & 24 Conducted Test Report***

<b>FCC Part 22 &amp; 24 Certification</b>	
<b>FCC ID:</b>	<b>J9CGOBI2000</b>
<b>Model:</b>	<b>Gobi2000</b>

<b>STATEMENT OF CERTIFICATION</b>	
<i>The data, data evaluation and equipment configuration represented herein are a true and accurate representation of the measurements of the sample's radio frequency interference emissions characteristics as of the dates and at the times of the test under the conditions herein specified.</i>	
Test performed by:	QUALCOMM Incorporated 5775 Morehouse Drive San Diego, CA 92121-1714
Report Prepared by:	QUALCOMM Incorporated 5775 Morehouse Drive San Diego, CA 92121-1714
Tests that required an OATS site were performed by Nemko Product Services.	



**Table of Contents**

**1. Introduction and Purpose ..... 5**

**2. Description of Device Under Test ..... 5**

**3. Test Summary ..... 5**

**4. RF Power Output Verification ..... 5**

1. Base Station Emulator Settings and Measurement Procedures .....5

2. For CDMA2000 1xEV-DO .....6

3. For WCDMA/HSDPA/HSUPA .....9

4. For GSM/GPRS/EDGE.....12

5. Test Results .....12

**5. Occupied Bandwidth ..... 14**

6. Test Procedures .....14

7. Test Results .....15

8. Plots.....19

**6. Block Edge Compliance ..... 30**

9. Test Procedures .....30

10. Test Results .....31

11. Plots.....33

**7. Out of Band Emission at Antenna Terminals ..... 41**

12. Test Procedure.....41

13. Test Results .....42

14. Plots.....44

**8. Frequency Stability..... 69**

15. Test Procedure.....69

16. Test Results .....70

**9. Test Equipment and Firmware..... 78**

## 1. Introduction and Purpose

This document provides FCC test data for Qualcomm’s Gobi™2000 wireless embedded modem. The test results included in this report are limited to conducted test results. Radiated testing was performed at Nemko USA, Inc. in San Diego, CA, and the test results are contained in the Gobi2000 Module FCC Part 22 & 24 Radiated Test Report.

## 2. Description of Device Under Test

The product consists of a universal embedded-data-connectivity modem in the form of a PCI Express mini-card and the associated software suite for the notebook PC application. The Gobi2000 Module has the features of CDMA2000/1xEVDO data at 850 MHz and 1900 MHz with diversity support for both bands; UMTS/HSDPA/HSUPA data at 850 MHz, Japan800 MHz, 900 MHz, 1900 MHz, and 2100 MHz with diversity support for all three bands; GSM/GPRS/EDGE data at 850 MHz, 900 MHz, 1800 MHz and 1900 MHz; and GPS.

In the US and Canada, only 850 MHz (Cellular) and 1900 MHz (PCS) bands are used for CDMA2000, UMTS/HSPA and GSM/GPRS/EDGE operation. The Gobi2000 Module was only tested in those two bands for FCC application. The DUT is a pre-production sample.

## 3. Test Summary

FCC/IC Rule	Description of Test	Result	Page
§2.1046	RF Power Output	Complies	12
§2.1049	Occupied Bandwidth	Complies	14
§22.359, 24.238	Block Edge Requirement	Complies	29
§2.1051, 22.917, 24.238(a)	Out of Band Emission at Antenna Terminals	Complies	41
§2.1055, 22.355, 24.235	Frequency Stability vs. Temperature vs. Voltage	Complies	57
§1.1310, 2.1091	RF Exposure	Complies	See MPE Report
§2.1053, 22.917, 24.238(a)	Field Strength of Spurious Radiation	Complies	See Radiated Test Report

## 4. RF Power Output Verification

<b>FCC:</b>	§ 2.1046
<b>Limit:</b>	n/a
<b>DUT SN</b>	G2-P2B-119

### 1. Base Station Emulator Settings and Measurement Procedures

As shown in the figure below, connect the transmitter output of the Gobi2000 Module to the communication test set (8820B or 8960) and configure it to operate at maximum power in a call. Measure the power at three equally spaced operating frequencies for each band.

Use the build-in power measurement capability in the 8960 box to measure CDMA 1x/1xEVDO conducted power outputs, and 8820B to measure UMTS conducted power outputs.

The relevant cable loss is measured for the specific frequencies under test and added as a correction factor for all the tests.

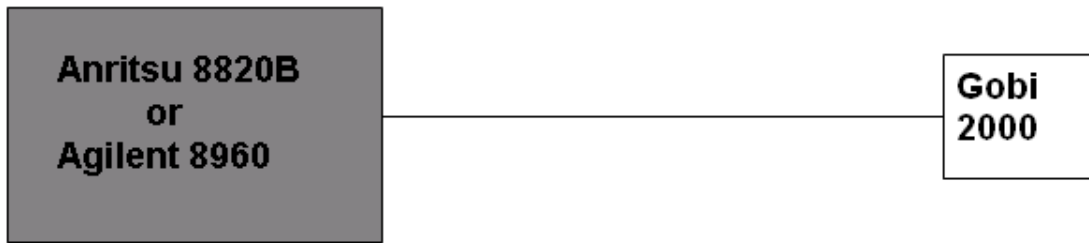

## 2. For CDMA2000 1xEV-DO

Measure the power at Ch1013, 384 and 777 for US cell; Ch25, 600 and 1175 for US PCS band.

### 1xRTT

Use CDMA2000 Rev 6 protocol in the call box 8960.

- 1) Test for Reverse/Forward TCH RC1, Reverse/Forward TCH RC2, and RC3 Reverse FCH and demodulation of RC 3, 4 and 5.
  - a. Set up a call using Fundamental Channel Test Mode 1 (RC1, SO 2) with 9600 bps data rate only.
  - b. As per C.S0011 or TIA/EIA-98-F Table 4.4.5.2-1, set the test parameters as shown in Table 4-1.
  - c. Send continuously '0' power control bits to the Gobi2000 Module.
  - d. Measure the output power at Gobi2000 Module antenna connector as recorded on the power meter with values corrected for cables losses.
  - e. Repeat step b through d for Fundamental Channel Test Mode:
    - i. RC1, SO55
    - ii. RC2, SO9
    - iii. RC2, SO55
    - iv. RC3, SO55
- 2) Test for RC 3 Reverse FCH, RC3 Reverse SCH0 and demodulation of RC 3, 4 and 5.
  - a. Set up a call using Supplemental Channel Test Mode 3 (RC 3, SO 32) with 9600 bps Fundamental Channel and 9600 bps SCH0 data rate.
  - b. As per C.S0011 or TIA/EIA-98-F Table 4.4.5.2-2, set the test parameters as shown in Table 4-2.
  - c. Send alternating '0' and '1' power control bit to the Gobi2000 Module

- d. Determine the active channel configuration. If the desired channel configuration is not the active channel configuration, increase  $\hat{I}_{or}$  by 1 dB and repeat the verification. Repeat this step until the desired channel configuration becomes active.
- e. Measure the output power at the Gobi2000 Module antenna connector.
- f. Decrease  $\hat{I}_{or}$  by 0.5 dB.
- g. Determine the active channel configuration. If the active channel configuration is the desired channel configuration, measure the output power at the Gobi2000 Module antenna connector.
- h. Repeat step f and g until the output power no longer increases or the desired channel configuration is no longer active. Record the highest output power achieved with the desired channel configuration active.
- i. Repeat step a through h ten times and average the result.

**Table 4-1 Parameters for Max. Power with a single traffic code channel, SR1**

Parameter	Units	Value
$\hat{I}_{or}$	dBm/1.23 MHz	-104
$\frac{\text{Pilot } E_c}{I_{or}}$	dB	-7
$\frac{\text{Traffic } E_c}{I_{or}}$	dB	-7.4

**Table 4-2 Parameters for Max. Power with multiple traffic code channel, SR1**

Parameter	Units	Value
$\frac{\text{Pilot } E_c}{I_{or}}$	dB	-7
$\frac{\text{Traffic } E_c}{I_{or}}$	dB	-7.4

1xEV-DO

- 1) Use 1xEV-DO Rel 0 protocol in the call box 8960.
  - a. FTAP
    - Select Test Application Protocol to FTAP
    - Set FTAP Rate to 307.2 kbps (2 Slot, QPSK)

- Generator Info -> Termination Parameters -> Max Forward Packet Duration -> 16 Slots
- Set  $\hat{I}$ or to -60 dBm/1.23 MHz
- Send continuously '0' power control bits
- Measure the power at Gobi2000 Module antenna connector

b. RTAP

- Select Test Application Protocol to RTAP
- Set RTAP Rate to 9.6 kbps
- Generator Info -> Termination Parameters -> Max Forward Packet Duration -> 16 Slots
- Set  $\hat{I}$ or to -60 dBm/1.23 MHz
- Send continuously '0' power control bits
- Measure the power at Gobi2000 Module antenna connector
- Repeat above steps for RTAP Rate = 19.2 kbps, 38.4 kbps, 76.8 kbps and 153.6 kbps respectively

2) Use 1xEV-DO Rev A protocol in the call box 8960

a. FETAP

- Select Test Application Protocol to FETAP
- Set FETAP Rate to 307.2 kbps (2 Slot, QPSK)
- Generator Info -> Termination Parameters -> Max Forward Packet Duration -> 16 Slots
- Set  $\hat{I}$ or to -60 dBm/1.23 MHz
- Send continuously '0' power control bits
- Measure the power at Gobi2000 Module antenna connector

b. RETAP

- Select Test Application Protocol to RETAP
- F-Traffic Format -> 4 (1024, 2, 128) Canonical (307.2k, QPSK)
- Set R-Data Pkt Size to 128
- Protocol Subtype Config -> Release A Physical Layer Subtype -> Subtype 2  
->PL Subtype 2 Access Channel MAC Subtype -> Default (Subtype 0)
- Generator Info -> Termination Parameters -> Max Forward Packet Duration -> 16 Slots  
->ACK R-Data After -> Subpacket 0 (All ACK)
- Set  $\hat{I}$ or to -60 dBm/1.23 MHz
- Send continuously '0' power control bits



- Measure the power at Gobi2000 Module antenna connector
- Repeat above steps for R-Data Pkt Size = 256, 512, 768, 1024, 1536, 2048, 3072, 4096, 6144, 8192, 12288 respectively.

### 3. For WCDMA/HSDPA/HSUPA

Configure the call box 8820B to support all WCDMA tests in respect to the 3GPP 34.121 (listed in Table 4-3). Measure the power at Ch4132, 4182 and 4233 for US cell; Ch9262, 9400 and 9538 for US PCS band.

#### For Rel99

- Set a Test Mode 1 loop back with a 12.2kbps Reference Measurement Channel (RMC)
- Set and send continuously Up power control commands to the GOBI2000
- Measure the power at the Gobi2000 Module antenna connector using the power meter with average detector

#### For HSDPA Rel 6

- Establish a Test Mode 1 loop back with both 1 12.2kbps RMC channel and a H-Set1 Fixed Reference Channel (FRC). With the 8820 this is accomplished by setting the signal Channel Coding to “Fixed Reference Channel” and configuring for HSET-1 QKSP.
- Set beta values and HSDPA settings for HSDPA Subtest1 according to Table 4-3
- Send continuously Up power control commands to the GOBI2000
- Measure the power at the Gobi2000 Module antenna connector using the power meter with modulated average detector
- Repeat the measurement for the HSDPA Subtest2, 3 and 4 as given in Table 4-3

#### For HSUPA Rel 6

- Use UL RMC 12.2kbps and FRC H-Set1 QPSK, Test Mode 1 loop back. With the 8820 this is accomplished by setting the signal Channel Coding to “E-DCH Test Channel” and configuring the equipment category to Cat5\_10ms.
- Set the Absolute Grant for HSUPA Subtest1 according to Table 4-3
- Set the UNDP power to be at least 5dB lower than the Maximum output power
- Send power control bits to give one TPC\_cmd = +1 command to the UNDP. If UNDP doesn't send any E-DPCH data with decreased E-TFCI within 500ms, then repeat this process until the decreased E-TFCI is reported.
- Confirm that the E-TFCI transmitted by the UNDP is equal to the target E-TFCI in Table 4-3. If the E-TFCI transmitted by the UNDP is not equal to the target E-TFCI, then send power control bits to give one TPC\_cmd = -1 command to the UE. If UE sends any E-DPCH data with decreased E-TFCI within 500 ms, send new power control bits to give one TPC\_cmd = -1 command to the UE. Then confirm that the E-TFCI transmitted by the UE is equal to the target E-TFCI in Table 4-3. If the E-TFCI transmitted by the UE is not equal to the target E-TFCI, then fail the UE
- Measure the power using the power meter with modulated average detector
- Repeat the measurement for the HSUPA Subtest2, 3, 4 and 5 as given in Table 4-3

This page intentionally left blank.

Table 4-3 3GPP Rel99/HSPA Subtest Settings

Subtest	Mode	Loopback Mode	Rel99 RMC	HSDPA FRC	HSUPA Test	Common Settings		CM	MPR	Power Class 3 limit	HSDPA Specific Settings						HSUPA Specific Settings			HSUPA Additional Info				
						$\beta_c$	$\beta_d$				$\Delta ACK$	$\Delta NAK$	$\Delta CQI$	Ack-Nack repetition factor	CQI Feedback [Table 5.2B.4]	CQI Repetition Factor [Table 5.2B.4]	Ahs = $\beta_{hs}/\beta_c$	$\Delta E-DPCCH$	$\Delta HARQ$	AG Index	ETFCI (from 34.121 Table C.11.1.3)	Associated Max UL Data Rate kbps		
1	Rel99	Test Mode1	12.2kbps	-	-			-		24 (+1.7/-3.7 dB)														
1	Rel6 HSDPA	Test Mode1	12.2kbps	H-Set1	-	2/15	15/15	0	0	24 (+1.7/-3.7 dB)	8	8	8	3	4ms	2	30/15							-
2	Rel6 HSDPA	Test Mode1	12.2kbps	H-Set1	-	12/15	15/15	1	0	24 (+1.7/-3.7 dB)	8	8	8	3	4ms	2	30/15							-
3	Rel6 HSDPA	Test Mode1	12.2kbps	H-Set1	-	15/15	8/15	1.5	0.5	23.5 (+2.2/-3.7 dB)	8	8	8	3	4ms	2	30/15							-
4	Rel6 HSDPA	Test Mode1	12.2kbps	H-Set1	-	15/15	4/15	1.5	0.5	23.5 (+2.2/-3.7 dB)	8	8	8	3	4ms	2	30/15							-
1	Rel6 HSUPA	Test Mode1	12.2kbps	H-Set1	HSUPA Loopback	11/15	15/15	1	0	24 (+1.7/-3.7 dB)	8	8	8	3	4ms	2	30/15	6	0	20	75		242.1	
2	Rel6 HSUPA	Test Mode1	12.2kbps	H-Set1	HSUPA Loopback	6/15	15/15	3	2	22 (+3.7/-3.7 dB)	8	8	8	3	4ms	2	30/15	8	0	12	67		174.9	
3	Rel6 HSUPA	Test Mode1	12.2kbps	H-Set1	HSUPA Loopback	15/15	9/15	2	1	23 (+2.7/-3.7 dB)	8	8	8	3	4ms	2	30/15	8	0	15	92		482.8	
4	Rel6 HSUPA	Test Mode1	12.2kbps	H-Set1	HSUPA Loopback	2/15	15/15	3	2	22 (+3.7/-3.7 dB)	8	8	8	3	4ms	2	30/15	5	0	17	71		205.8	
5	Rel6 HSUPA	Test Mode1	12.2kbps	H-Set1	HSUPA Loopback	15/15	15/15	1	0	24 (+1.7/-3.7 dB)	8	8	8	3	4ms	2	30/15	7	0	21	81		308.9	

HSUPA Subtest 1,2,4,5

- Reference E-TFCIs	5 E-TFCIs
- Reference E-TFCI	11
- Reference E-TFCI PO	4
- Reference E-TFCI	67
- Reference E-TFCI PO	18
- Reference E-TFCI	71
- Reference E-TFCI PO	23
- Reference E-TFCI	75
- Reference E-TFCI PO	26
- Reference E-TFCI	81
- Reference E-TFCI PO	27

HSUPA Subtest 3

- Reference E-TFCIs	2 E-TFCIs
- Reference E-TFCI	11
- Reference E-TFCI PO	4
- Reference E-TFCI	92
- Reference E-TFCI PO	18

#### 4. For GSM/GPRS/EDGE

Configure the 8820B box to support GMSK and 8PSK call respectively, and set one timeslot transmission for GMSK GSM/GPRS and 8PSK EDGE. Measure and record power outputs for both modulations.

#### 5. Test Results

##### CDMA2000 1xEV-DO

Mode	Test Case			BC0 (850MHz) Channel Power (dBm)			BC1 (1900MHz) Channel (dBm)		
	#	FWD RC/TAP	REV RC/TAP	1013	384	777	25	600	1175
1x	1	RC1	RC1 (SO2)	24.46	24.46	24.29	24.52	24.44	24.32
	2	RC1	RC1 (SO55)	24.52	24.49	24.34	24.48	24.48	24.43
	3	RC2	RC2 (SO9)	24.55	24.37	24.26	24.51	24.33	24.46
	4	RC2	RC2 (SO55)	24.57	24.57	24.35	24.30	24.38	24.49
	5	RC3	RC3 (SO55)	<b>24.56</b>	<b>24.62</b>	<b>24.57</b>	<b>24.64</b>	<b>24.57</b>	<b>24.52</b>
	6	RC3	RC3 (SO32)	24.22	24.35	24.45	24.40	24.36	24.48
1xEVDO Rel0	7a	FTAP Rate = 307kbps (2 slot, QPSK)	RTAP rate = 9.6kbps	24.44	24.29	24.22	24.46	24.29	24.47
	7b		RTAP rate = 19.2kbps	24.43	24.43	24.19	24.39	24.44	24.49
	7c		RTAP rate = 38.4kbps	24.38	24.46	24.29	24.36	24.27	24.38
	7d		RTAP rate = 76.8kbps	<b>24.46</b>	<b>24.29</b>	<b>24.22</b>	<b>24.41</b>	<b>24.11</b>	<b>24.32</b>
	7e		RTAP rate = 153.6kbps	24.49	24.54	24.59	24.48	24.37	24.46
1xEVDO RevA	8a	FETAP rate = 307kbps (2 slot, ACK channel is transmitte d at all the slots)	RETAP - payload size = 128	24.34	24.51	24.36	24.37	24.42	24.31
	8b		RETAP - payload size = 256	24.46	24.51	24.38	24.41	24.47	24.54
	8c		RETAP - payload size = 512	24.33	24.48	24.36	24.37	24.38	24.29
	8d		RETAP - payload size = 768	24.42	24.49	24.39	24.37	24.41	24.44
	8e		RETAP - payload size = 1024	24.29	24.35	24.28	24.44	24.41	24.27
	8f		RETAP - payload size = 1536	24.36	24.37	24.47	24.45	24.31	24.27
	8g		RETAP - payload size = 2048	24.48	24.52	24.51	24.47	24.53	24.34
	8h		RETAP - payload size = 3072	24.39	24.45	24.44	24.39	24.48	24.28
	8i		RETAP - payload size = 4096	<b>24.54</b>	<b>24.47</b>	<b>24.42</b>	<b>24.44</b>	<b>24.39</b>	<b>24.27</b>
	8j		RETAP - payload size = 6144	24.46	24.43	24.39	24.52	24.42	24.25
	8k		RETAP - payload size = 8192	24.45	24.48	24.39	24.36	24.46	24.24
	8l		RETAP - payload size = 12288	24.37	24.49	24.36	24.47	24.51	24.22

Note: All measurements are based on an average detector

WCDMA/HSDPA/HSUPA

Mode	3GPP Subtest	Band V (800 MHz) Channel Power (dBm)			Band II (1900MHz) Channel Power (dBm)			MPR
		4132	4182	4233	9262	9400	9538	
Rel99	1	24.18	24.03	24.15	24.09	23.95	23.85	
Rel6 HSDPA	1	24.01	23.94	24.05	24.04	23.83	23.78	0
	2	23.52	23.25	23.47	23.49	23.26	23.35	0
	3	23.5	23.27	23.42	23.51	23.3	23.31	0.5
	4	22.98	22.81	23.02	23.12	23.01	23.04	0.5
Rel6 HSUPA	1	23.77	23.71	23.36	23.55	23.4	23.11	0
	2	21.52	21.48	21.53	21.32	21.44	21.35	2
	3	22.4	22.38	22.41	22.31	22.5	22.33	1
	4	22.04	21.92	21.98	21.81	21.88	21.78	2
	5	23.85	23.53	23.37	23.61	23.65	23.68	0

Note: All measurements are based on an average detector

Note: The MPR has been implemented into the Gobi2000 Module per the 3GPP standard.

GSM/GPRS/EDGE

Mode	GSM850 Channel Peak Power (dBm)			GSM1900 Channel Peak Power (dBm)			Modulation
	128	190	251	512	661	810	
GPRS (1 UL slot)	32.83	32.53	32.56	29.14	29.42	29.25	GMSK
EGPRS	27.40	27.44	27.26	25.57	25.98	25.82	8PSK

Note: All measurements are based on a peak detector

## 5. Occupied Bandwidth

<b>FCC:</b>	§2.1049		
<b>Limit:</b>	n/a		
<b>DUT SN</b>	G2-P2B-117		
<b>Modes Tested</b>	<b>CDMA 1x / 1x-EVDO</b>	<b>WCDMA/HSPA</b>	<b>GSM/GPRS/EDGE</b>
	<ul style="list-style-type: none"> <li>▪ RC3 SO55</li> <li>▪ Rel 0, RTAP rate = 153.6kbps</li> <li>▪ Rev A, RETAP payload = 4096</li> </ul>	<ul style="list-style-type: none"> <li>▪ Rel 99</li> <li>▪ Rel 6 HSUPA, Subtest 5</li> </ul>	<ul style="list-style-type: none"> <li>▪ GSM</li> <li>▪ EDGE</li> </ul>

## 6. Test Procedures

As Figure below indicates, connected the transmitter output to a calibrated coaxial cable and coupler. The other end of coupler was connected to the spectrum analyzer. Measured the occupied bandwidth (defined as the 99% power bandwidth) with the appropriate personality features integrated in the PSA.

Used 8960 call box for CDMA 1x/1x-EVDO measurement, and 8820B for UMTS testing.

### 7. Test Results

The occupied bandwidth was measured at low, mid and high channel in each band.

Mode		Frequency (MHz)	Channel	99% Occupied Bandwidth (kHz)	Corresponding Plot number
GSM/ GPRS/ EDGE	GMSK	824.2	128	244.7	Plot 5.2 - 1
		836.6	190	244.8	Plot 5.2 - 2
		848.8	251	244.1	Plot 5.2 - 3
		1850.2	512	245.2	Plot 5.2 - 4
		1880	661	247.3	Plot 5.2 - 5
		1909.8	810	246.4	Plot 5.2 - 6
	8PSK	824.2	128	236.4	Plot 5.2 - 7
		836.6	190	239.6	Plot 5.2 - 8
		848.8	251	242.9	Plot 5.2 - 9
		1850.2	512	250.0	Plot 5.2 - 10
		1880	661	247.6	Plot 5.2 - 11
		1909.8	810	245.2	Plot 5.2 - 12

Mode		Frequency (MHz)	Channel	99% Occupied Bandwidth (MHz)	Plot number
WCDMA/ HSDPA/ HSUPA	Rel 99	826.4	4132	4.1625	Plot 5.2 - 13
		836.4	4182	4.1510	Plot 5.2 - 14
		846.6	4233	4.1619	Plot 5.2 - 15
		1852.4	9262	4.1632	Plot 5.2 - 16
		1880	9400	4.1628	Plot 5.2 - 17
		1907.5	9538	4.1475	Plot 5.2 - 18
	HSUPA Rel 6 Subtest 5	826.4	4132	4.1767	Plot 5.2 - 19
		836.4	4182	4.1689	Plot 5.2 - 20
		846.6	4233	4.1547	Plot 5.2 - 21
		1852.4	9262	4.1783	Plot 5.2 - 22
		1880	9400	4.1930	Plot 5.2 - 23
		1907.5	9538	4.1765	Plot 5.2 - 24



Mode		Frequency (MHz)	Channel	99% Occupied Bandwidth (MHz)	Plot number
CDMA1x/ 1x-EVDO	RC3 SO55	824.7	1013	1.2798	Plot 5.2 - 25
		836.52	384	1.2805	Plot 5.2 - 26
		848.31	777	1.2766	Plot 5.2 - 27
		1851.25	25	1.2763	Plot 5.2 - 28
		1880	600	1.2798	Plot 5.2 - 29
		1908.75	1175	1.2730	Plot 5.2 - 30
	Rel 0 RTAP rate = 153.6kbps	824.7	1013	1.2767	Plot 5.2 - 31
		836.52	384	1.2725	Plot 5.2 - 32
		848.31	777	1.2811	Plot 5.2 - 33
		1851.25	25	1.2777	Plot 5.2 - 34
		1880	600	1.2714	Plot 5.2 - 35
		1908.75	1175	1.2791	Plot 5.2 - 36
	Rev A RETAP Payload size = 4096	824.7	1013	1.2751	Plot 5.2 - 37
		836.52	384	1.2680	Plot 5.2 - 38
		848.31	777	1.2757	Plot 5.2 - 39
		1851.25	25	1.2739	Plot 5.2 - 40
		1880	600	1.2800	Plot 5.2 - 41
		1908.75	1175	1.2747	Plot 5.2 - 42

This page intentionally left blank.

### 8. Plots

Plot 5.2 -1 ( Ch128, GSM GMSK)

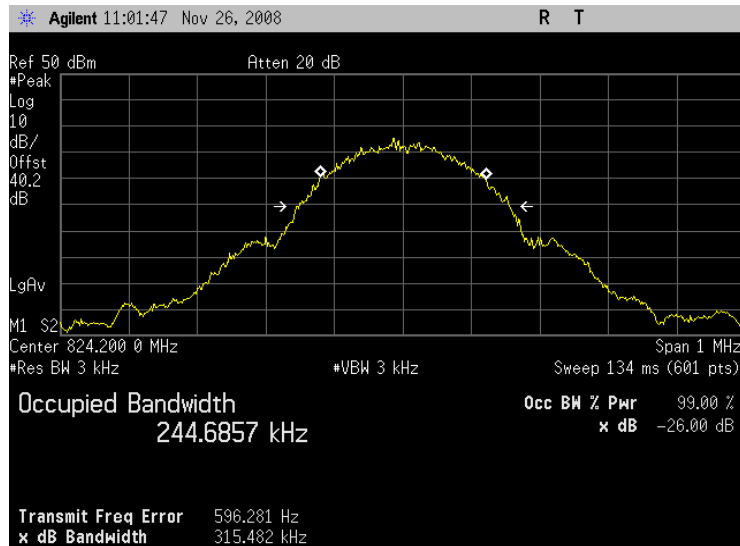

Plot 5.2 -2 (Ch190, GSM GMSK)

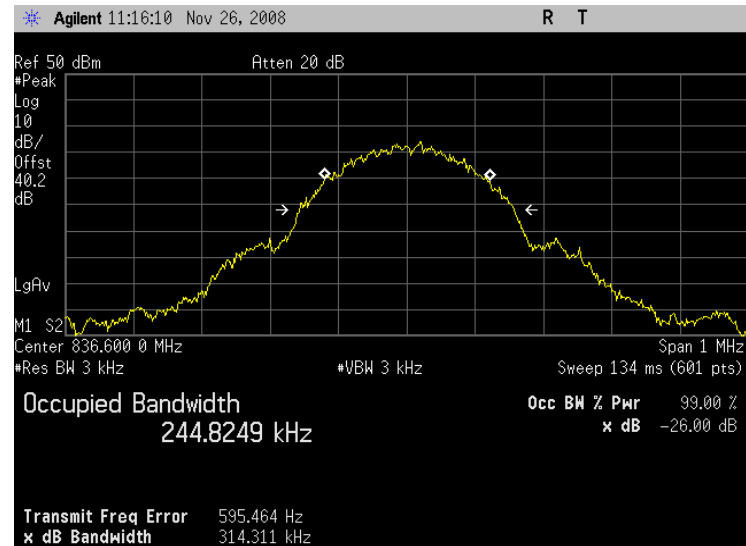

Plot 5.2 -3 (CH251, GSM GMSK)

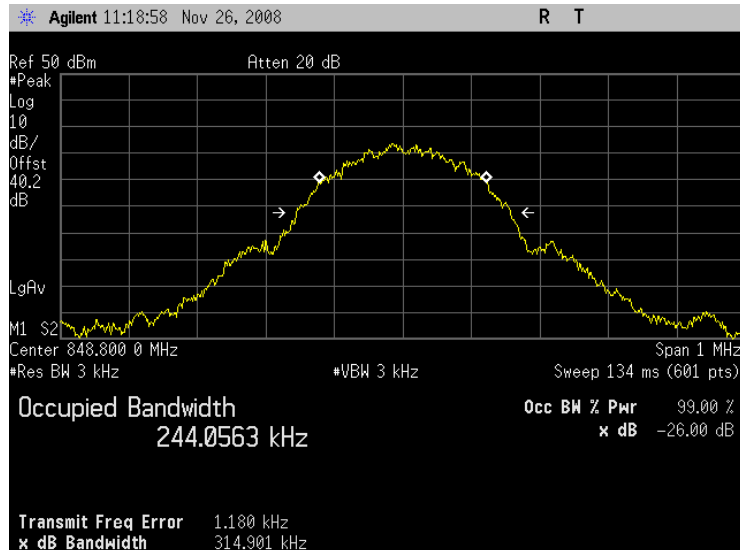

Plot 5.2 -4 (Ch512, GSM GMSK)

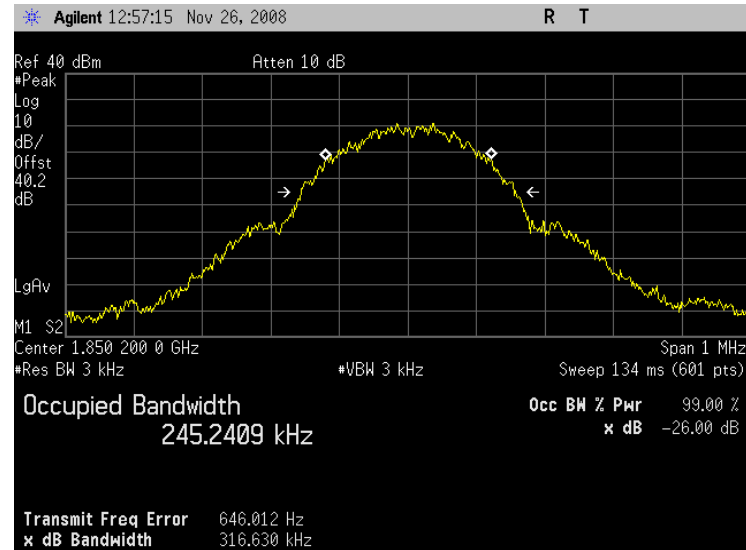

Plot 5.2 - 5 (Ch661, GSM GMSK)

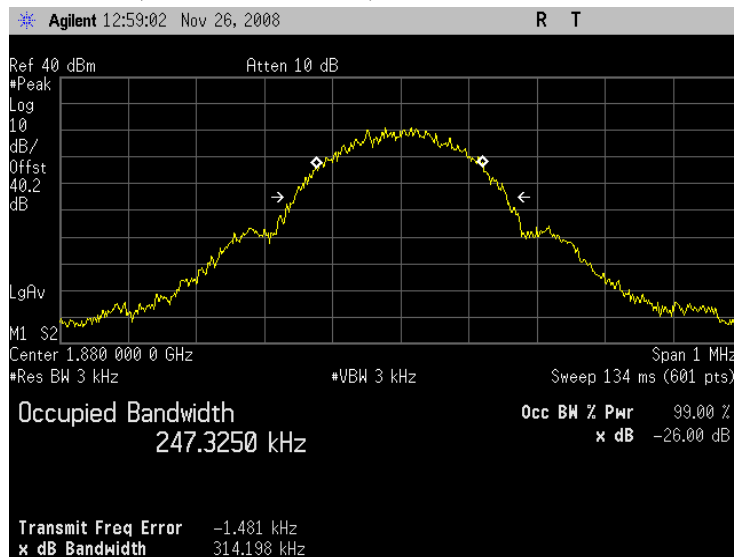

Plot 5.2 - 6 (Ch810, GSM GMSK)

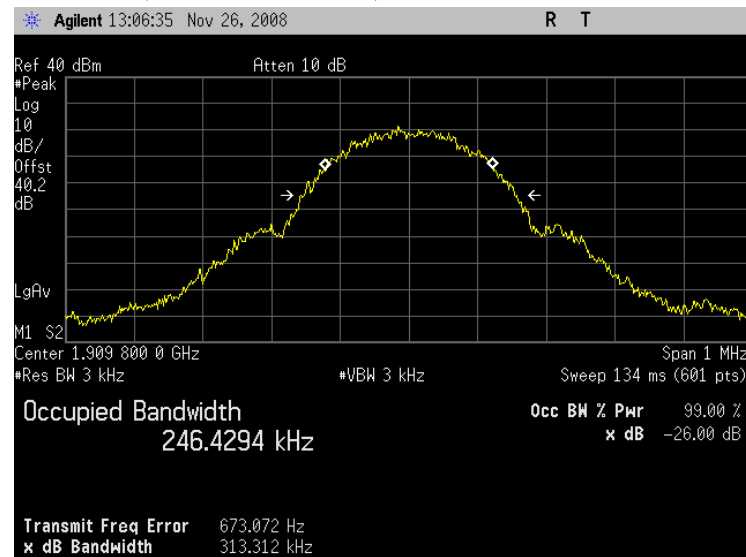

Plot 5.2 - 7 (Ch128, 8PSK)

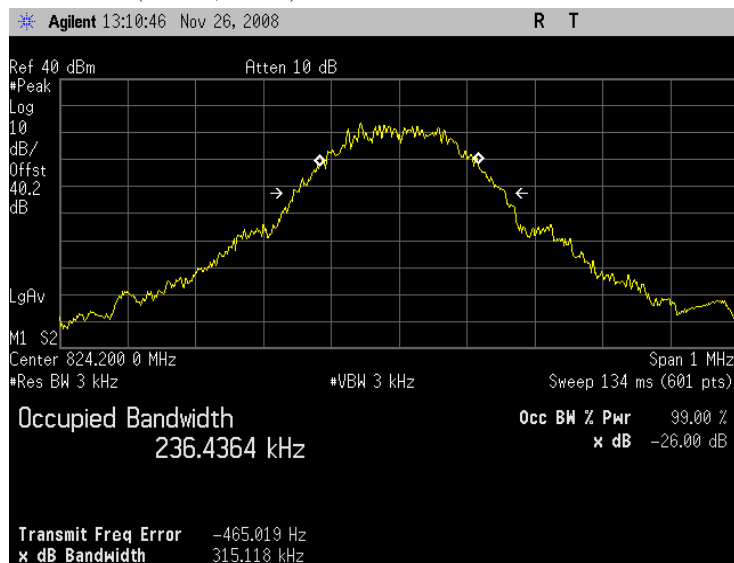

Plot 5.2 - 8 (Ch190, 8PSK)

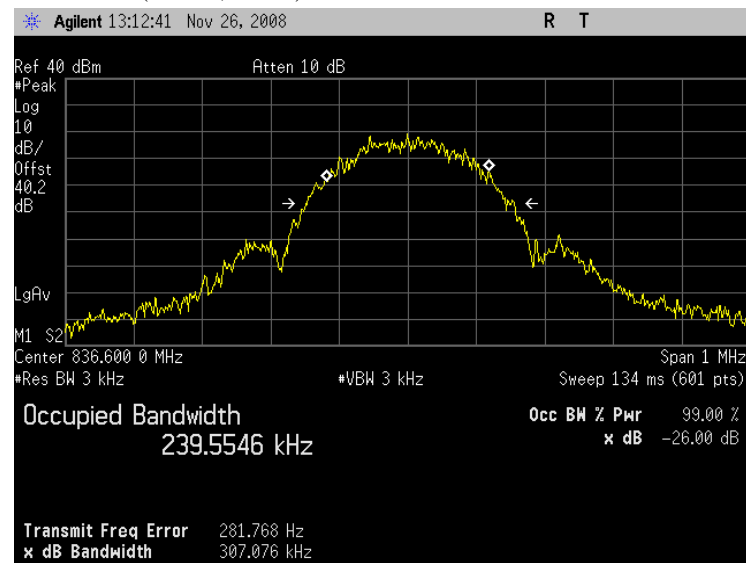

Plot 5.2 - 9 (Ch251, 8PSK)

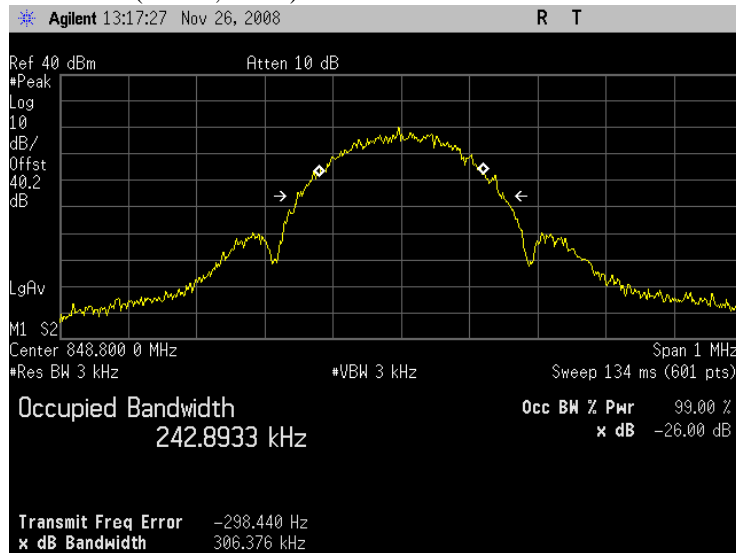

Plot 5.2 - 10 (Ch512, 8PSK)

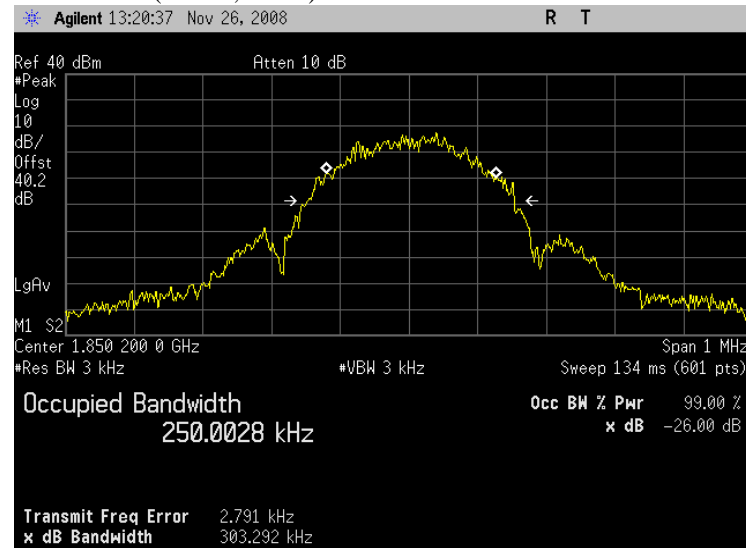

Plot 5.2 - 11 (Ch661, 8PSK)

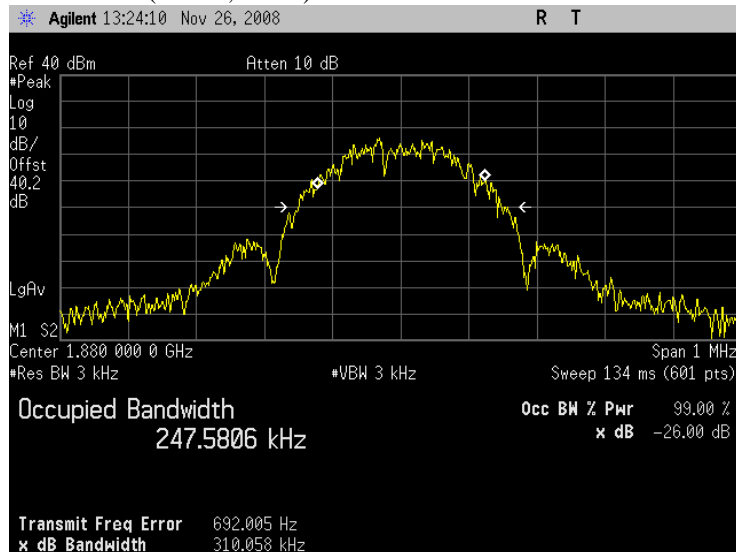

Plot 5.2 - 12 (Ch810, 8PSK)

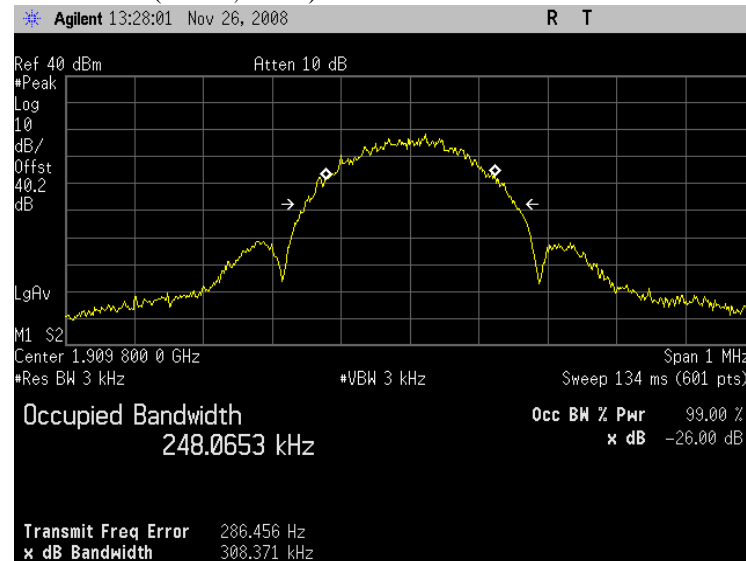

Plot 5.2 - 13 (Ch4132, Rel 99)

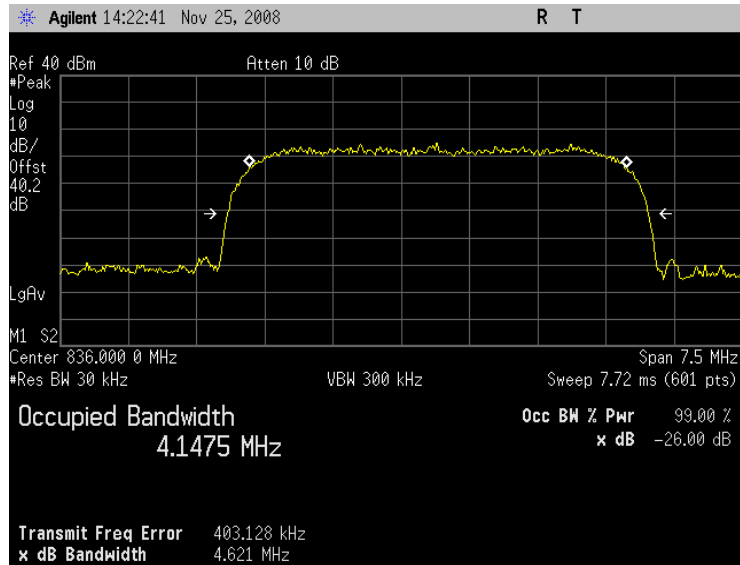

Plot 5.2 - 14 (Ch4182, Rel 99)

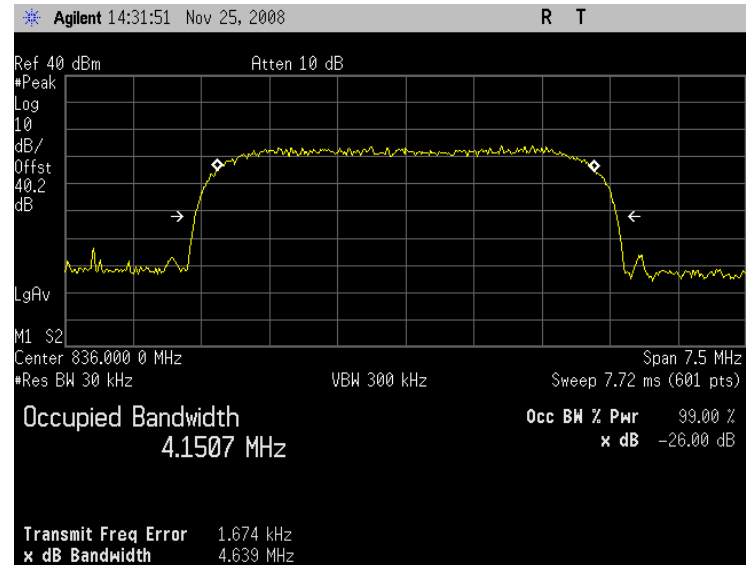

Plot 5.2 - 15 (Ch4233, Rel 99)

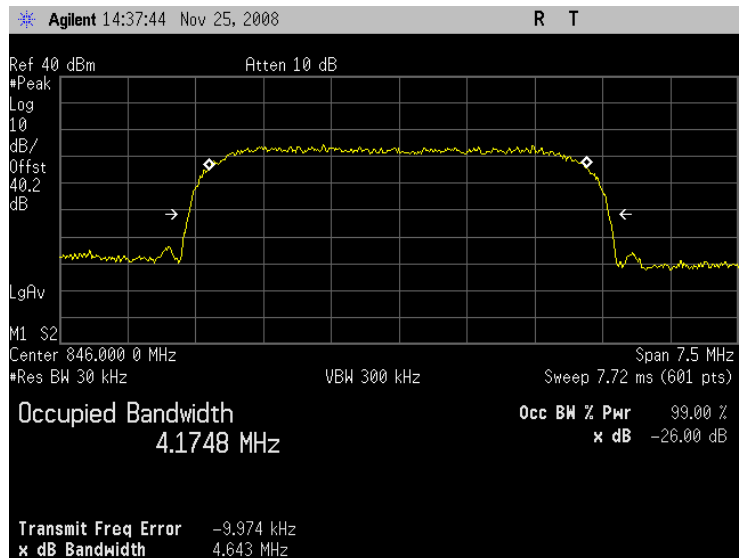

Plot 5.2 - 16 (Ch9262, Rel 99)

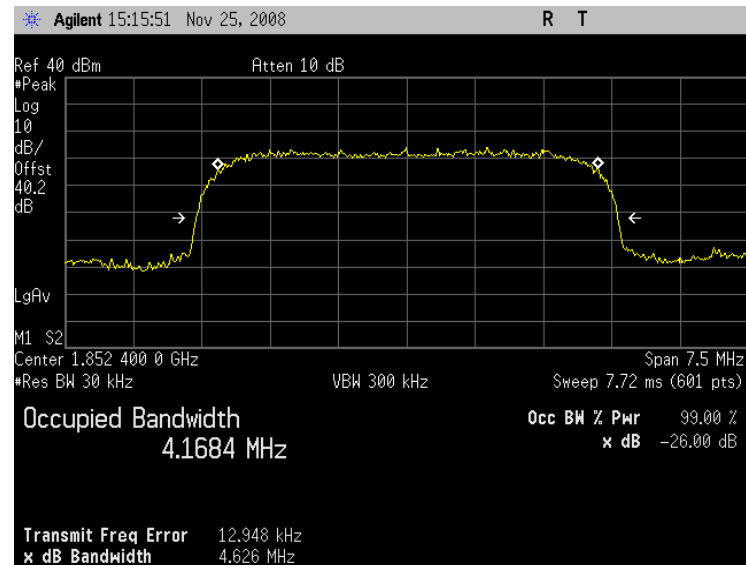

Plot 5.2 - 17 (Ch9400, Rel 99)

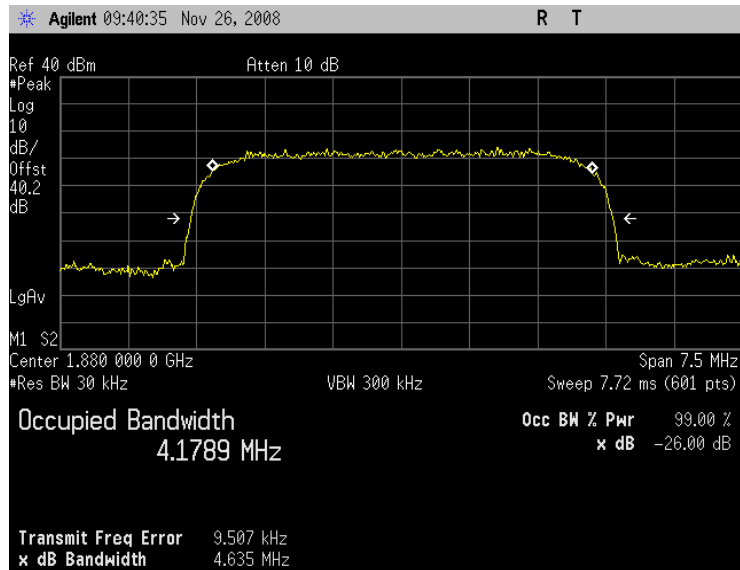

Plot 5.2 - 18 (Ch9538, Rel 99)

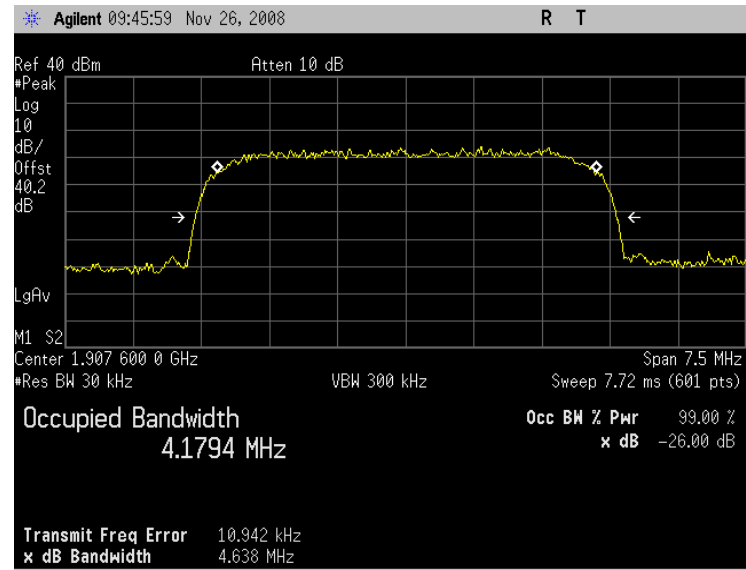

Plot 5.2 - 19 (Ch4132, HSUPA Subtest 5)

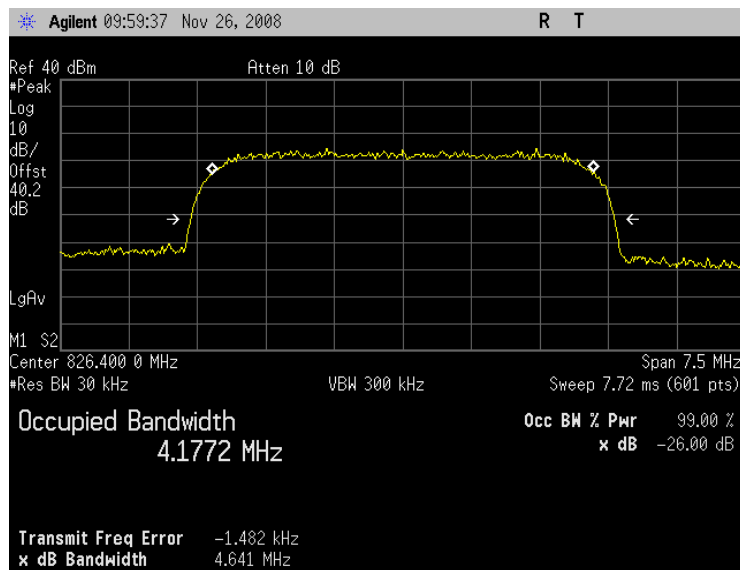

Plot 5.2 - 20 (Ch4182, HSUPA Subtest 5)

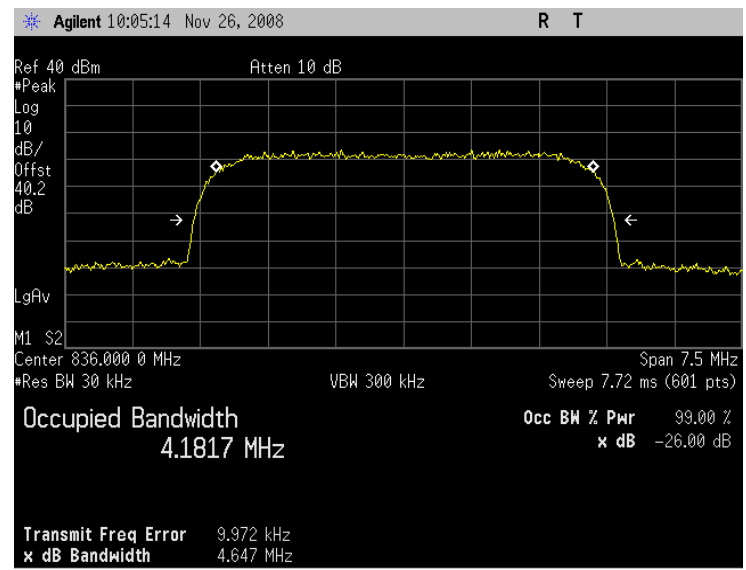

Plot 5.2 - 21 (Ch4233, HSUPA Subtest 5)

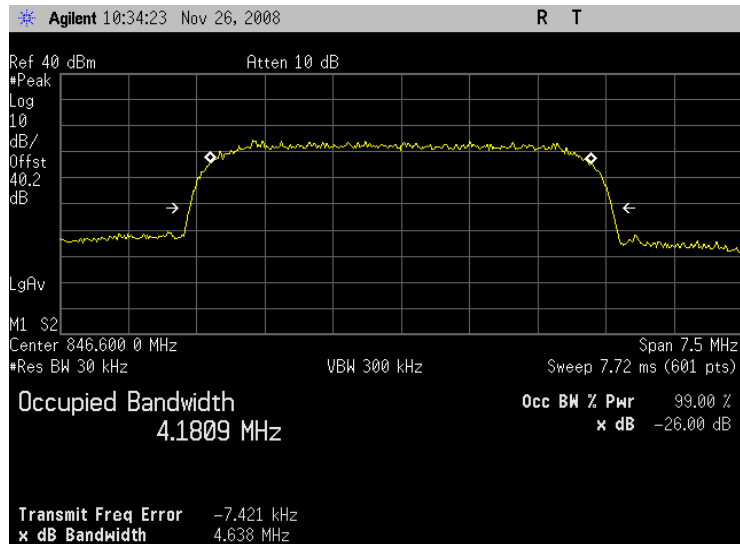

Plot 5.2 - 22 (Ch9262, HSUPA Subtest 5)

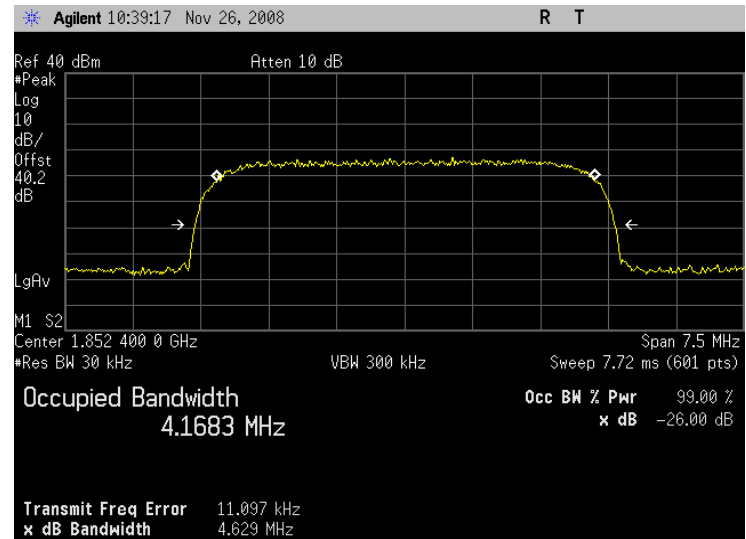

Plot 5.2 - 23 (Ch9400, HSUPA Subtest 5)

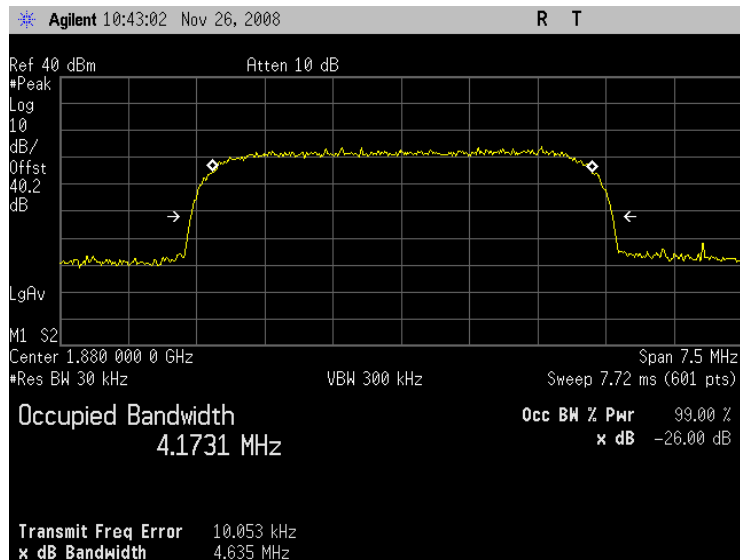

Plot 5.2 - 24 (Ch9538, HSUPA Subtest 5)

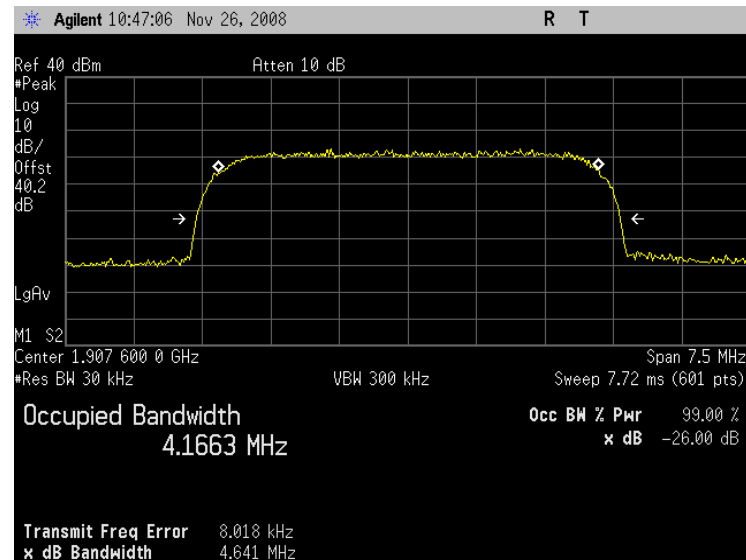



Plot 5.2 - 25 (Ch1013, RC3 SO55)

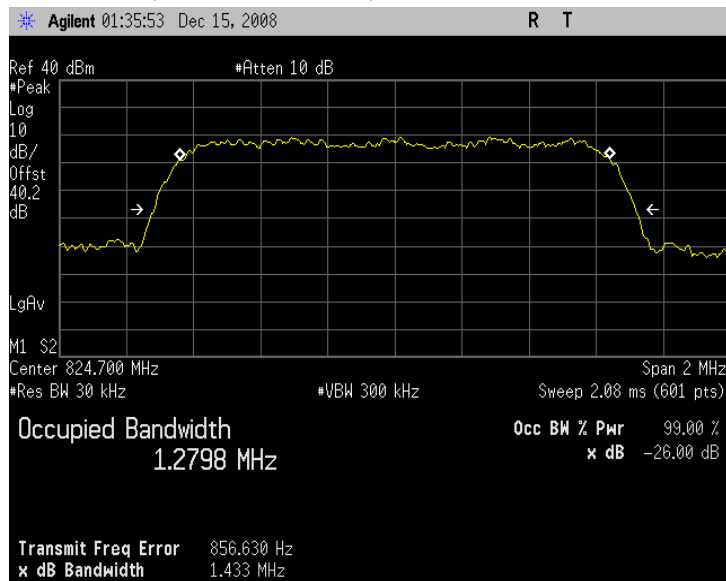

Plot 5.2 - 26 (Ch384, RC3 SO55)

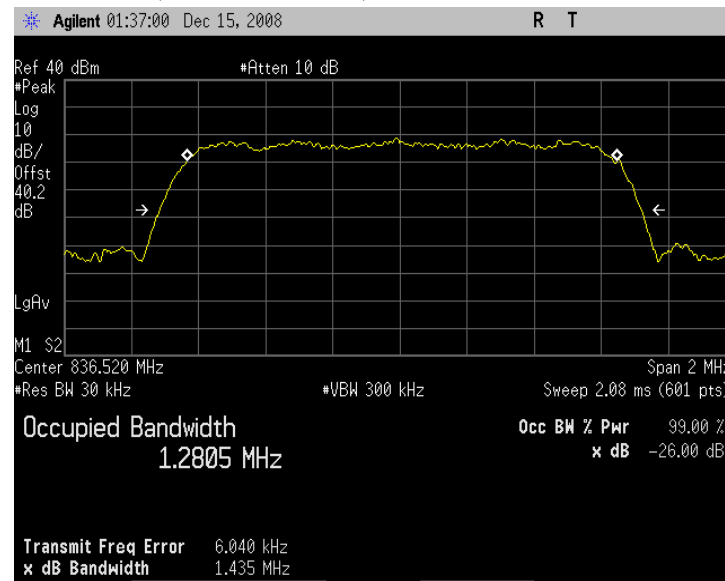

Plot 5.2 - 27 (Ch777, RC3 SO55)

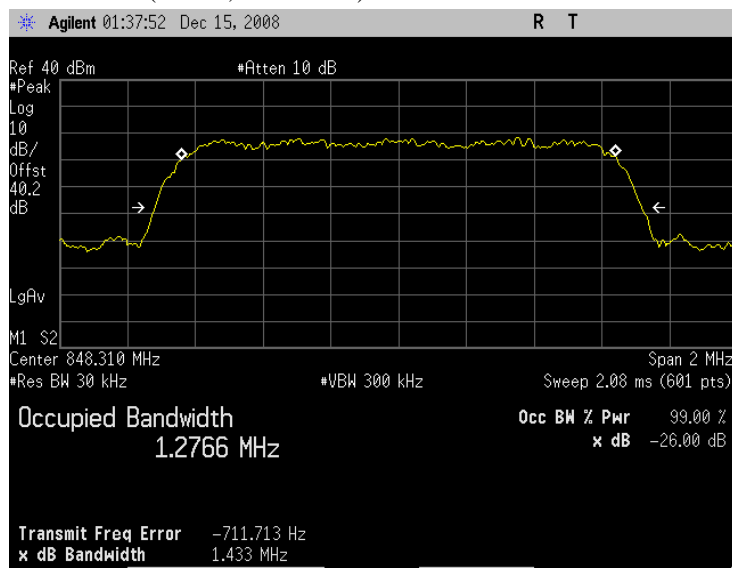

Plot 5.2 - 28 (Ch25, RC3 SO55)

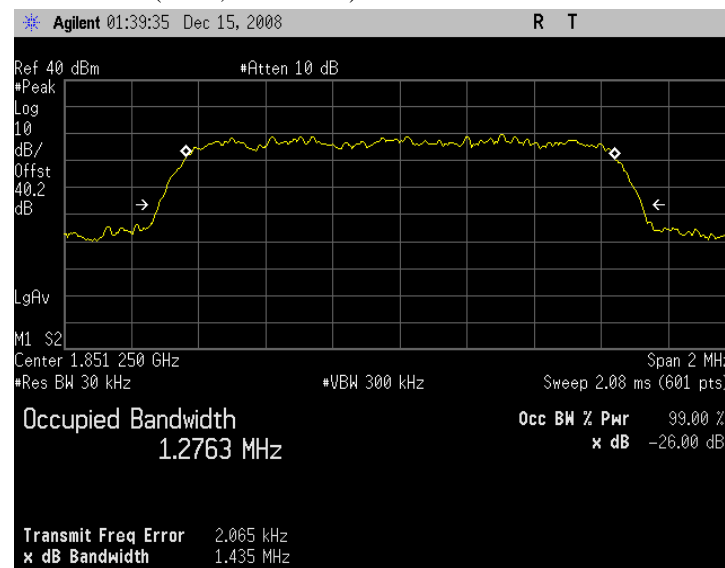

Plot 5.2 - 29 (Ch600, RC3 SO55)

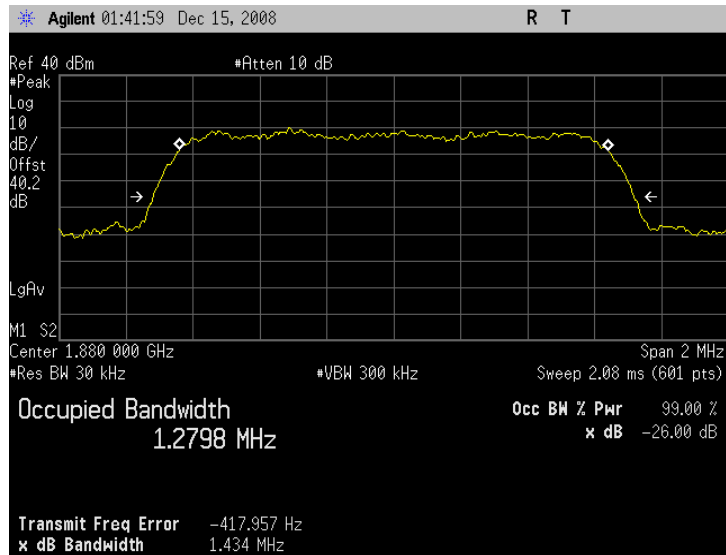

Plot 5.2 - 30 (Ch1175, RC3 SO55)

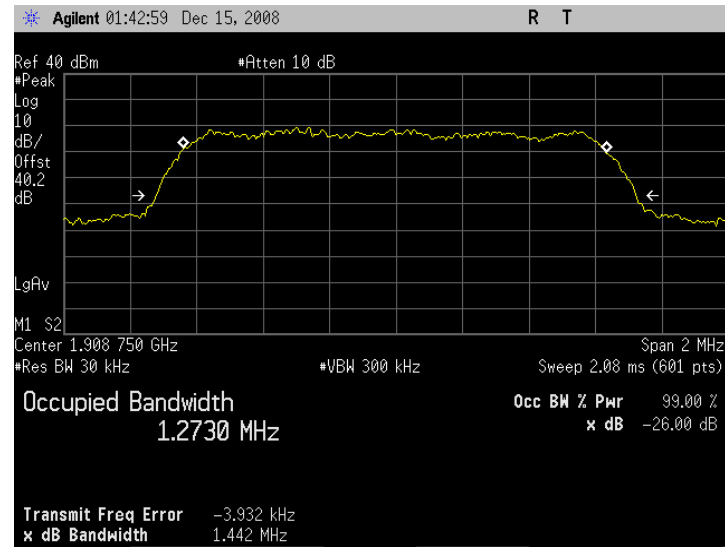

Plot 5.2 - 31 (Ch1013, Rel 0, 153.6kbps)

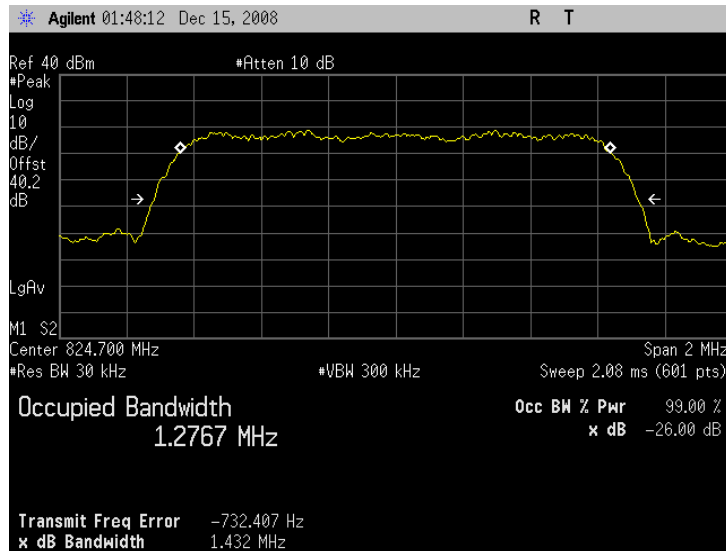

Plot 5.2 - 32 (Ch384, Rel 0, 153.6kbps)

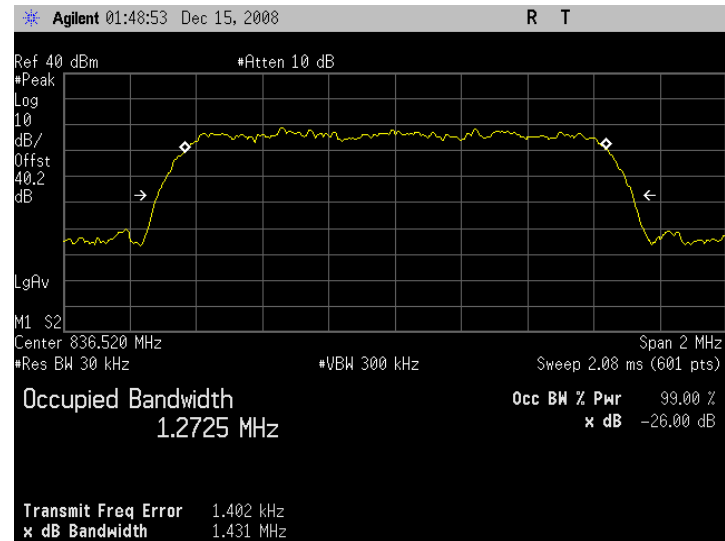

Plot 5.2 - 33 (Ch777, Rel 0, 153.6kbps)

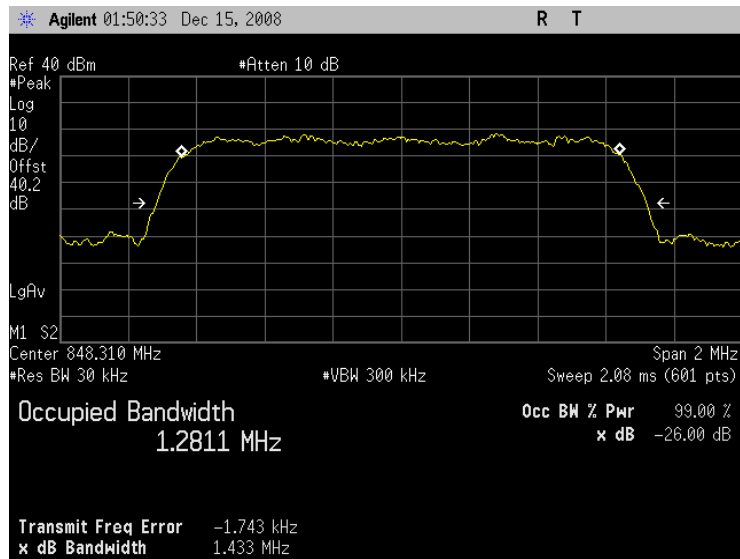

Plot 5.2 - 34 (Ch25, Rel 0, 153.6kbps)

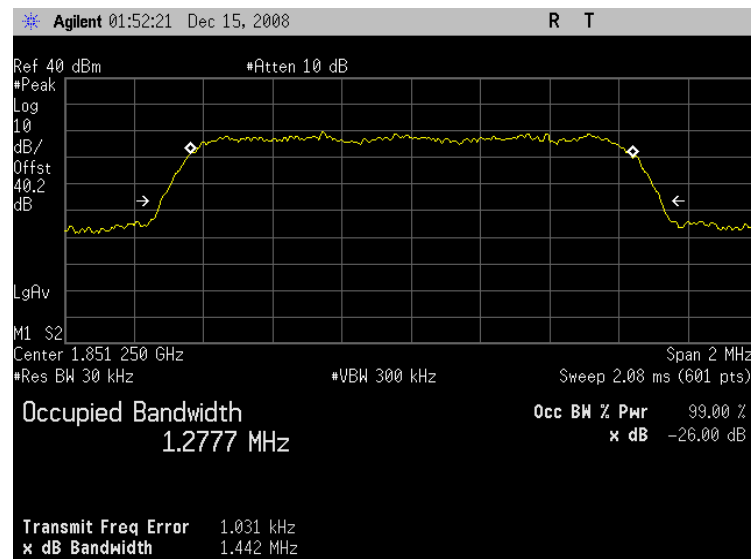

Plot 5.2 - 35 (Ch600, Rel 0, 153.6kbps)

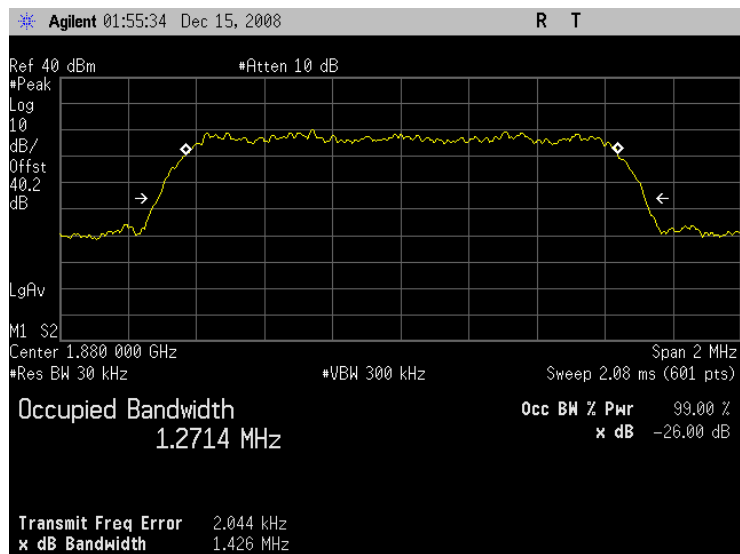

Plot 5.2 - 36 (Ch1175, Rel 0, 153.6kbps)

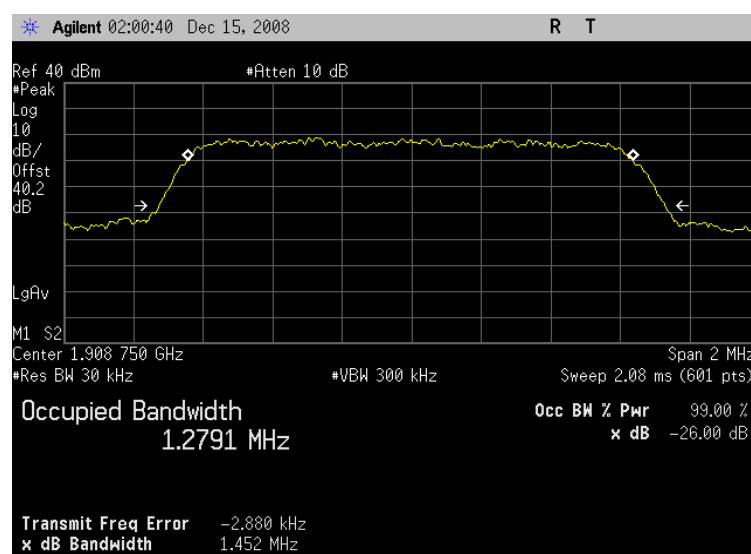

Plot 5.2 - 37 (Ch1013, Rel A, 4096 payload size)

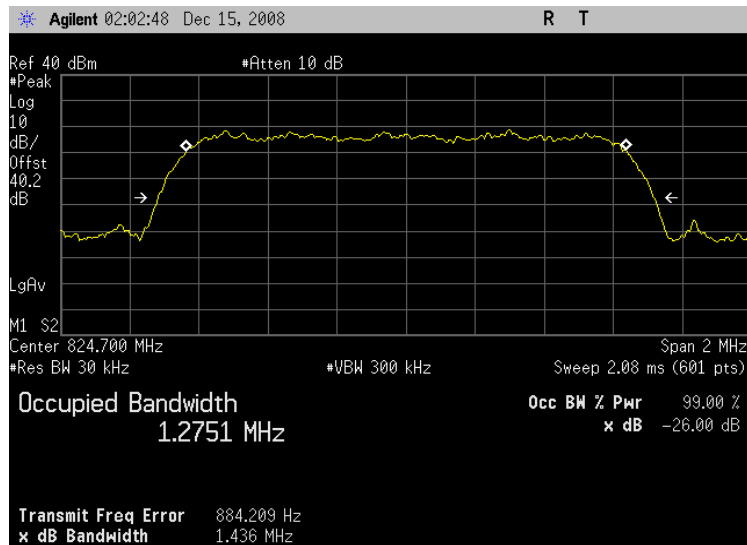

Plot 5.2 - 38 (Ch384, Rel A, 4096 payload size)

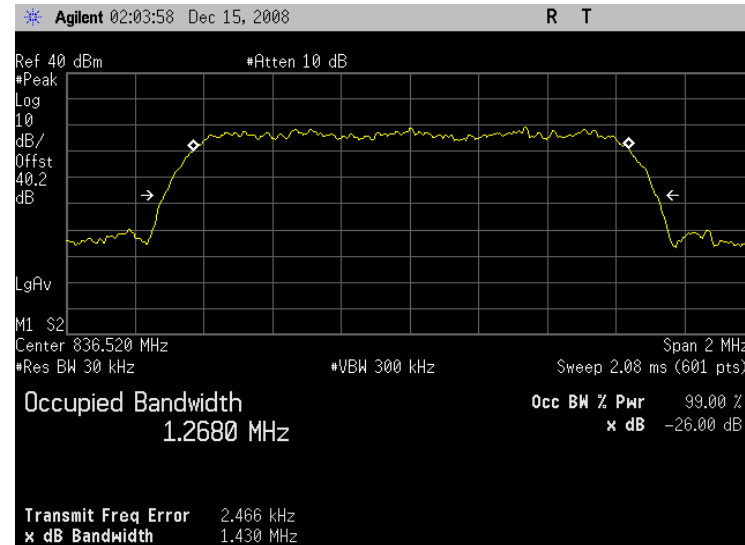

Plot 5.2 - 39 (Ch777, Rel A, 4096 payload size)

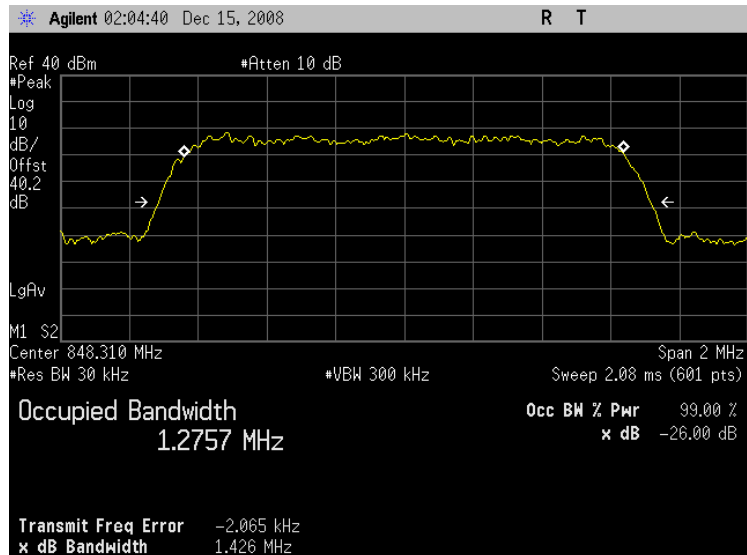

Plot 5.2 - 40 (Ch25, Rel A, 4096 payload size)

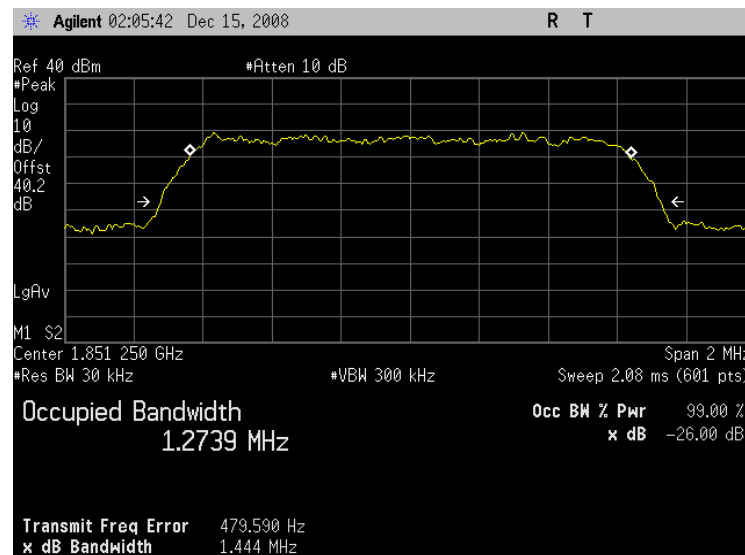

Plot 5.2 - 41 (Ch600, Rel A, 4096 payload size)

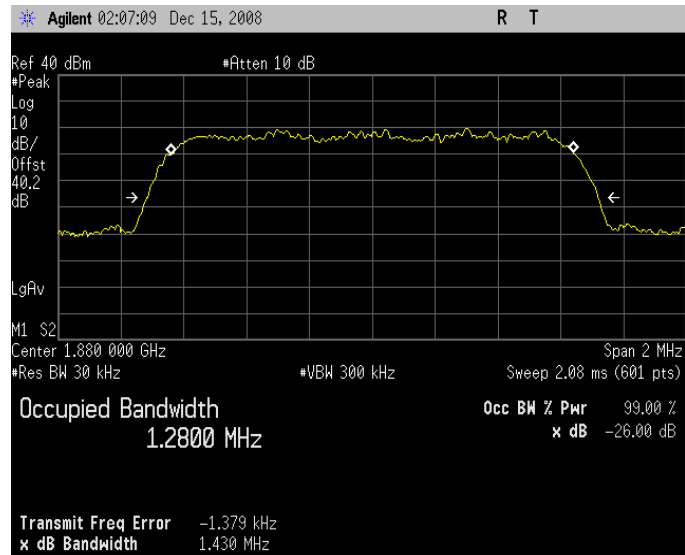

Plot 5.2 - 42 (Ch1175, Rel A, 4096 payload size)

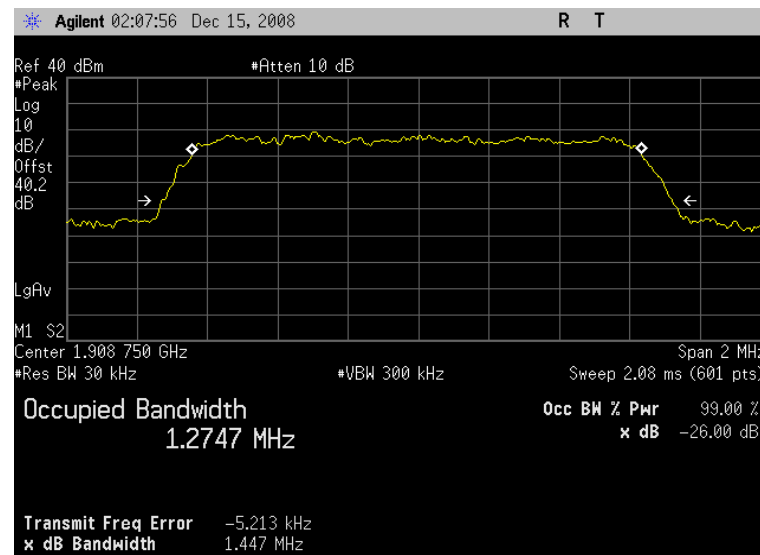

## 6. Block Edge Compliance

<b>FCC:</b>	§22.359, 24.238		
<b>Limit:</b>	-13dBm		
<b>DUT SN</b>	N10DGGVRD		
<b>Modes Tested</b>	CDMA 1x / 1x-EVDO	WCDMA/HSPA	GSM/GPRS/EDGE
	RC3 SO55	Rel 99	GSM
	Rel 0, RTAP rate = 153.6kbps	Rel 6 HSUPA, Subtest 5	EDGE
	Rev A, RETAP payload = 4096		

### 9. Test Procedures

As shown in Figure below, connected the RF output to 8960 or 8820B, configured the UPDP-1 to operate at maximum power. Measured the block edge emissions at the required operating frequencies in each band on the spectrum analyzer.

For Each block edge measurement:

- Set the spectrum analyzer span to include the block edge frequency (824, 848, 1850, 1910MHz)
- Set a marker to point the corresponding block edge frequency in each test case
- Set display line at -13dBm
- Set resolution bandwidth to at least 1% of emission BW
- For CDMA/WCDMA measurement, set video averaging to 10 samples

Used 8960 call box for CDMA 1x/1x-EVDO measurement, and 8820B for UMTS testing.

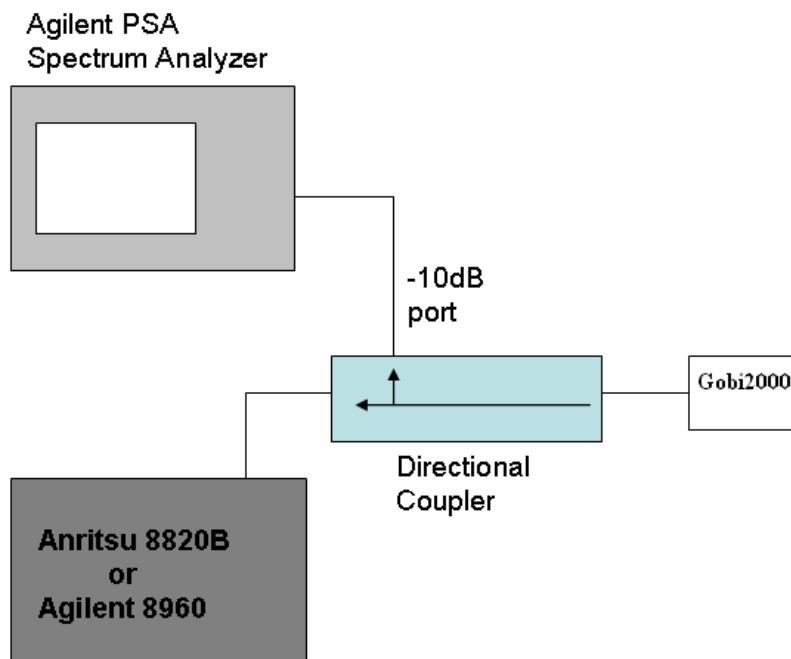

### 10. Test Results

The test was conducted at block edges in each band.

Mode		Frequency (MHz)	Channel Tested	Corresponding Plot number	Test Result
GSM/ GPRS/ EDGE	GMSK	824	128	Plot 6.2 - 1	Complies
		849	251	Plot 6.2 - 2	Complies
		1850	512	Plot 6.2 - 3	Complies
		1910	810	Plot 6.2 - 4	Complies
	8PSK	824	128	Plot 6.2 - 5	Complies
		849	251	Plot 6.2 - 6	Complies
		1850	512	Plot 6.2 - 7	Complies
		1910	810	Plot 6.2 - 8	Complies

Mode		Frequency (MHz)	Channel Tested	Corresponding Plot number	Test Result
WCDMA/ HSDPA/ HSUPA	Rel 99	824	4132	Plot 6.2 - 9	Complies
		849	4233	Plot 6.2 - 10	Complies
		1850	9262	Plot 6.2 - 11	Complies
		1910	9538	Plot 6.2 - 12	Complies
	HSUPA Rel 6 Subtest 5	824	4132	Plot 6.2 - 13	Complies
		849	4233	Plot 6.2 - 14	Complies
		1850	9262	Plot 6.2 - 15	Complies
		1910	9538	Plot 6.2 - 16	Complies

Mode		Frequency (MHz)	Channel Tested	Corresponding Plot number	Test Result
CDMA1x/ 1x-EVDO	RC3 SO55	824	1013	Plot 6.2 - 17	Complies
		849	777	Plot 6.2 - 18	Complies
		1850	25	Plot 6.2 - 19	Complies
		1910	1175	Plot 6.2 - 20	Complies
	Rel 0 RTAP rate = 153.6kbps	824	1013	Plot 6.2 - 21	Complies
		849	777	Plot 6.2 - 22	Complies
		1850	25	Plot 6.2 - 23	Complies
		1910	1175	Plot 6.2 - 24	Complies
	Rev A RETAP Payload size = 4096	824	1013	Plot 6.2 - 25	Complies
		849	777	Plot 6.2 - 26	Complies
		1850	25	Plot 6.2 - 27	Complies
		1910	1175	Plot 6.2 - 28	Complies



### 11. Plots

Plot 6.2 - 1 (Ch128, GMSK)

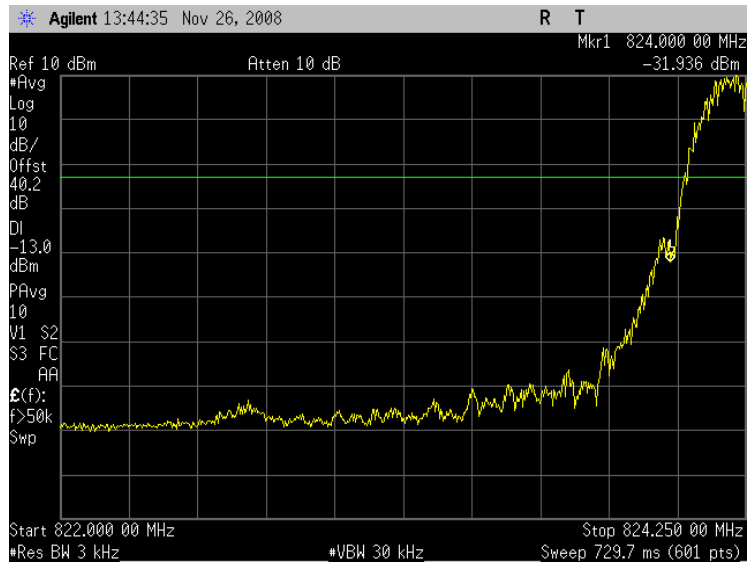

Plot 6.2 - 2 (Ch251, GMSK)

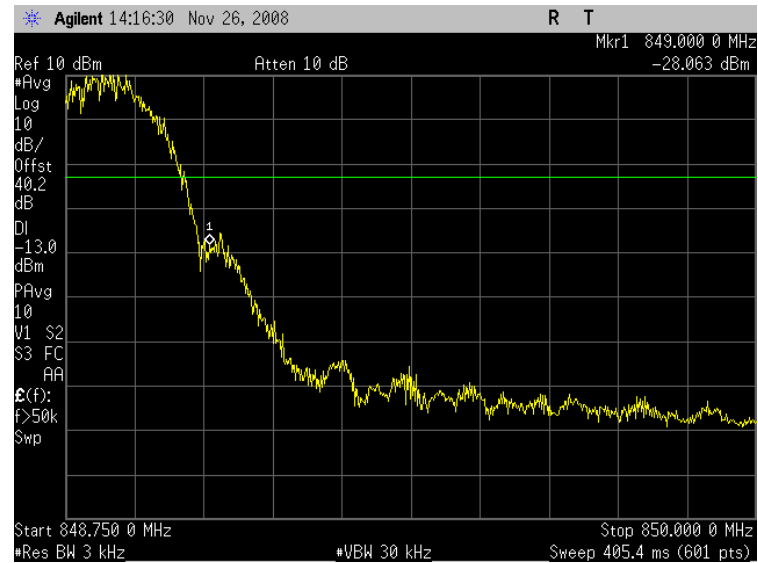

Plot 6.2 - 3 (Ch512, GMSK)



Plot 6.2 - 4 (Ch810, GSM1900)



Plot 6.2 - 5 (Ch128, 8PSK)



Plot 6.2 - 6 (Ch251, 8PSK)

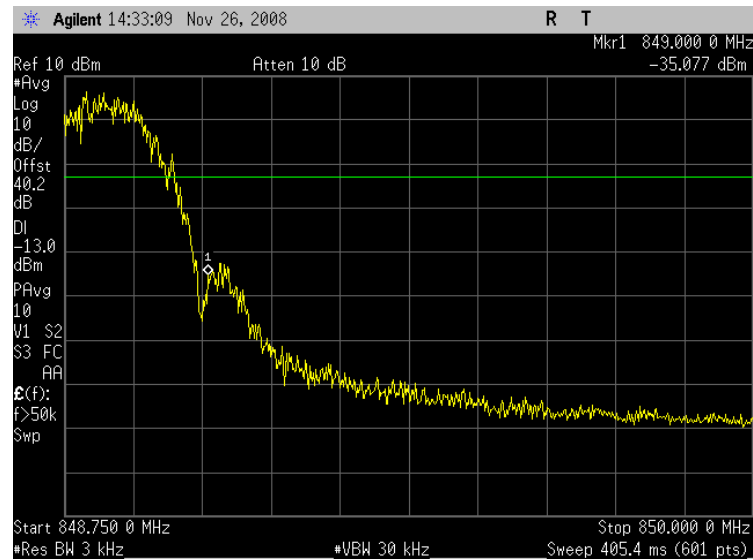

Plot 6.2 - 7 (Ch512, 8PSK)

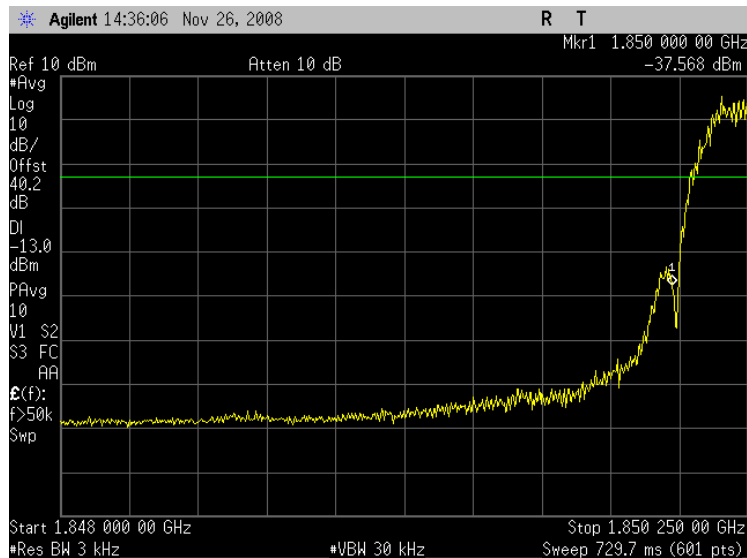

Plot 6.2 - 8 (Ch810, 8PSK)

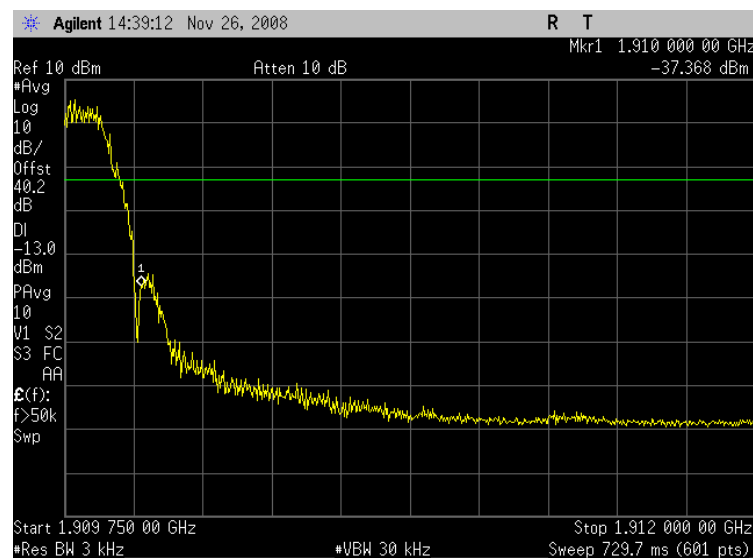

Plot 6.2 - 9 (Ch4132, WCDMA Rel 99)

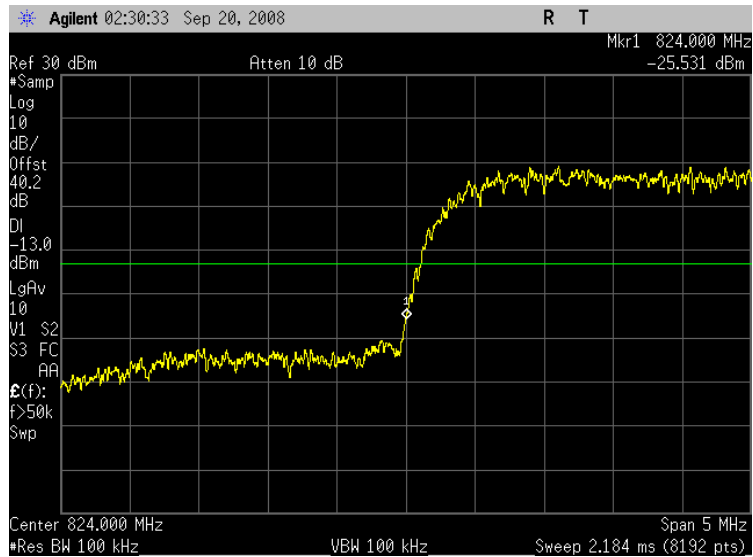

Plot 6.2 - 10 (Ch4233, WCDMA Rel 99)

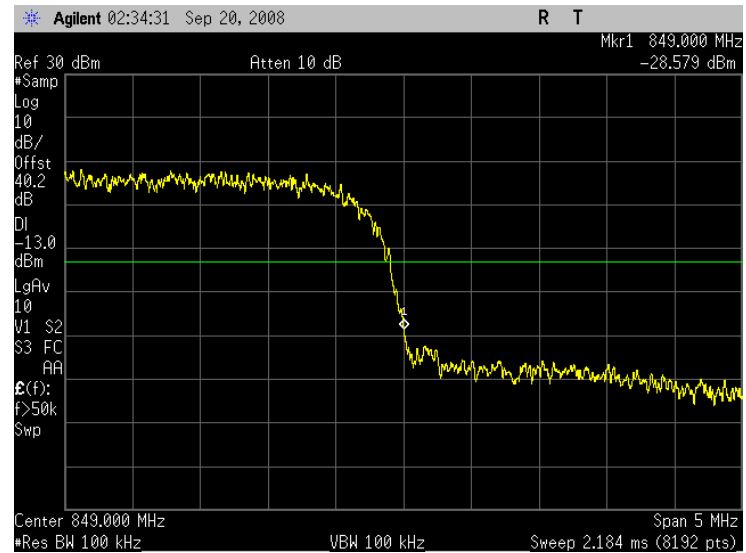

Plot 6.2 - 11 (Ch9262, WCDMA Rel 99)

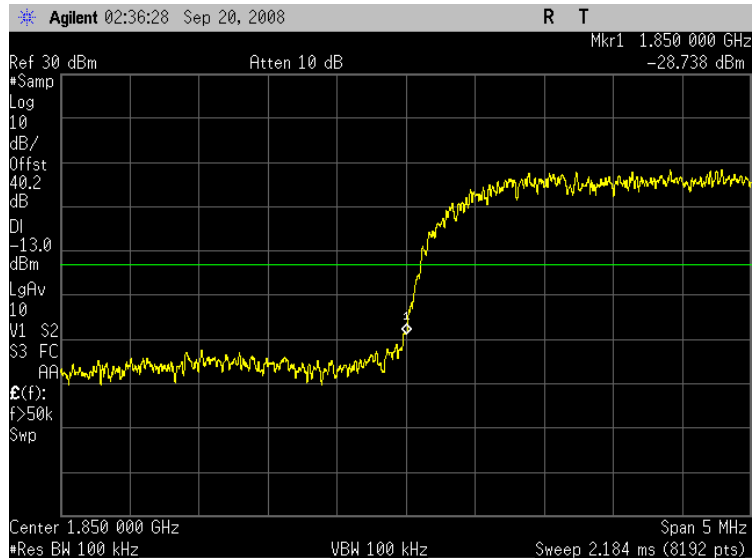

Plot 6.2 - 12 (Ch9538, WCDMA Rel 99)

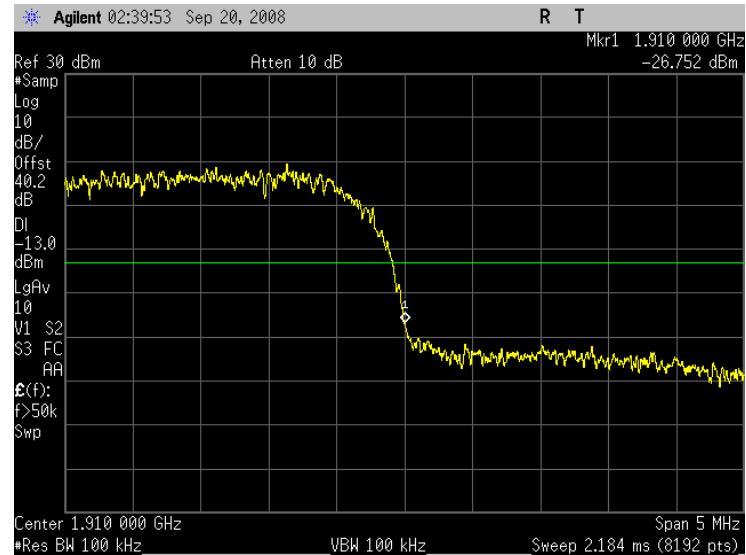

Plot 6.2 - 13 (Ch4132, HSUPA Subtest 5)

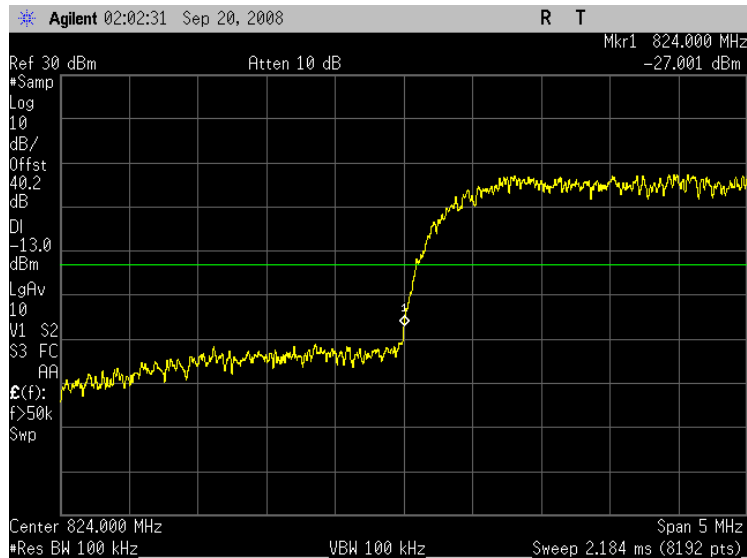

Plot 6.2 - 14 (Ch4233, HSUPA Subtest 5)

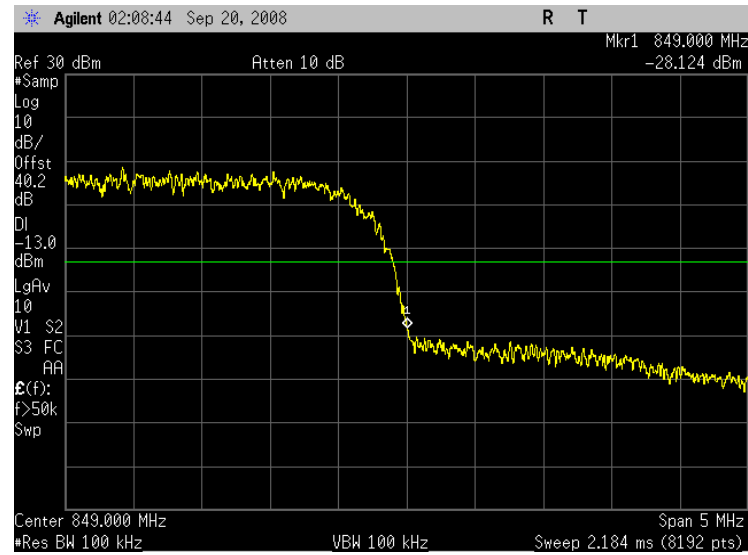

Plot 6.2 - 15 (Ch9262, HSUPA Subtest 5)

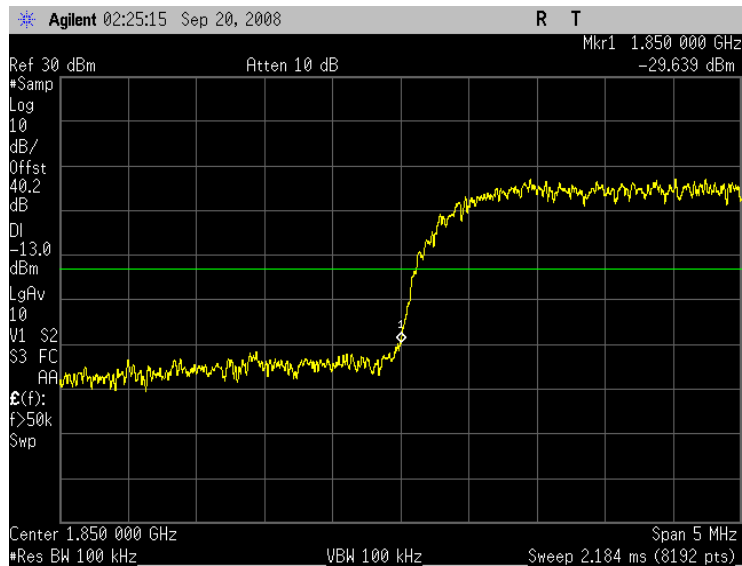

Plot 6.2 - 16 (Ch9538, HSUPA Subtest 5)

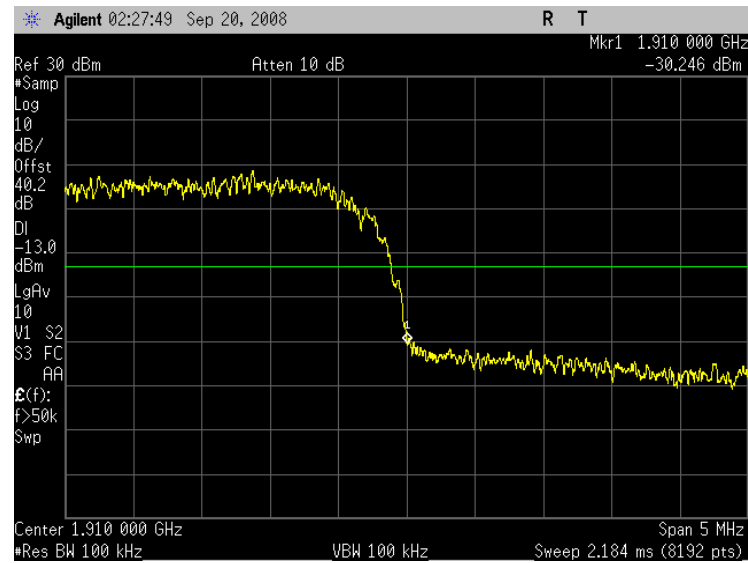

Plot 6.2 - 17 (Ch1013, 1x RC3 SO55)

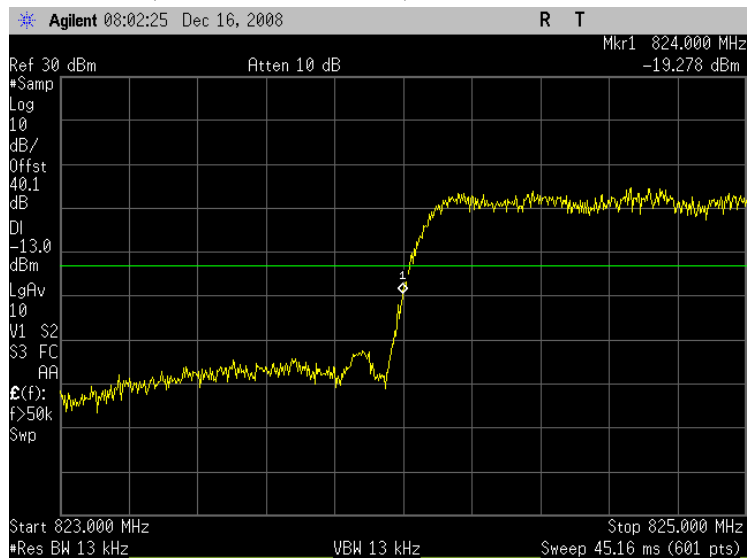

Plot 6.2 - 18 (Ch777, 1x RC3 SO55)

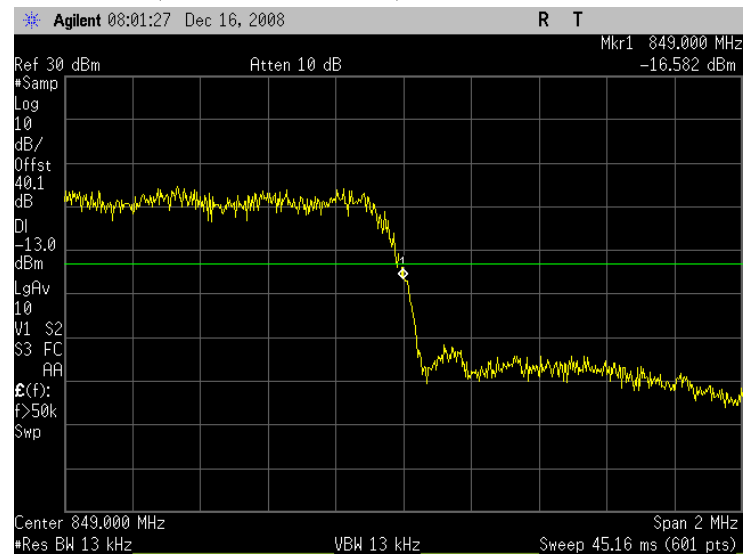

Plot 6.2 - 19 (Ch25, 1x RC3 SO55)

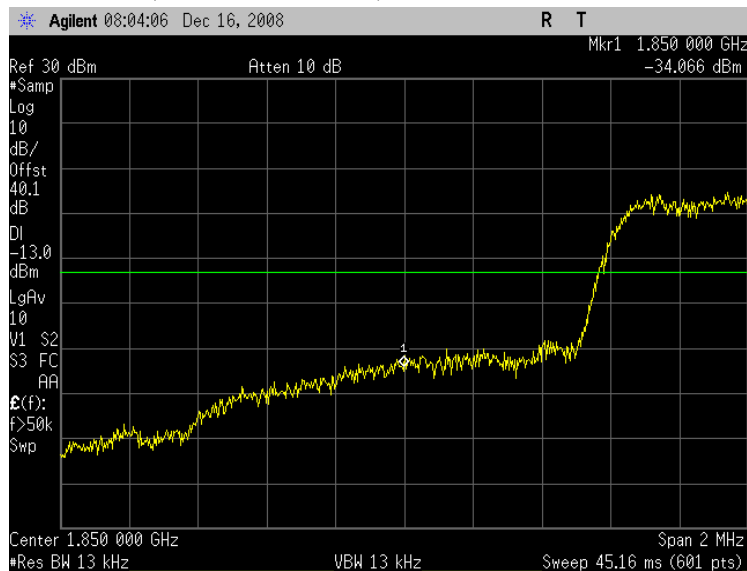

Plot 6.2 - 20 (Ch1175, 1x RC3 SO55)

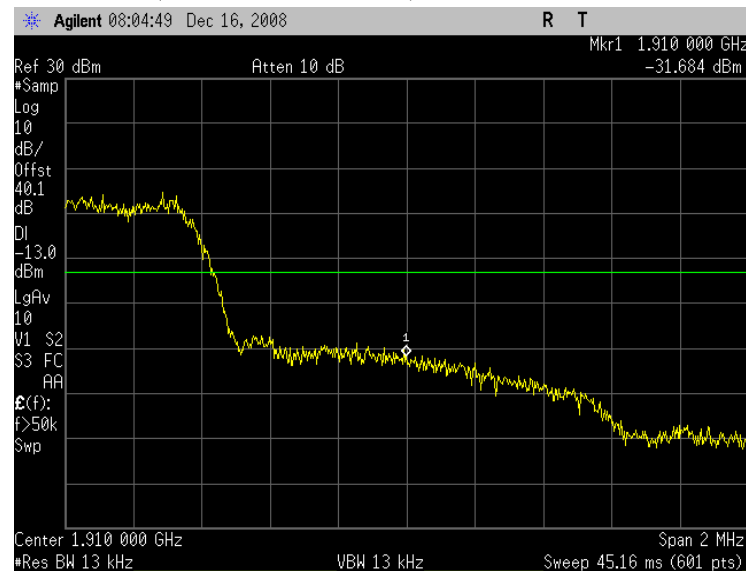

Plot 6.2 - 21 (Ch1013, 1xEVDO Rel 0, 153.6kbps)

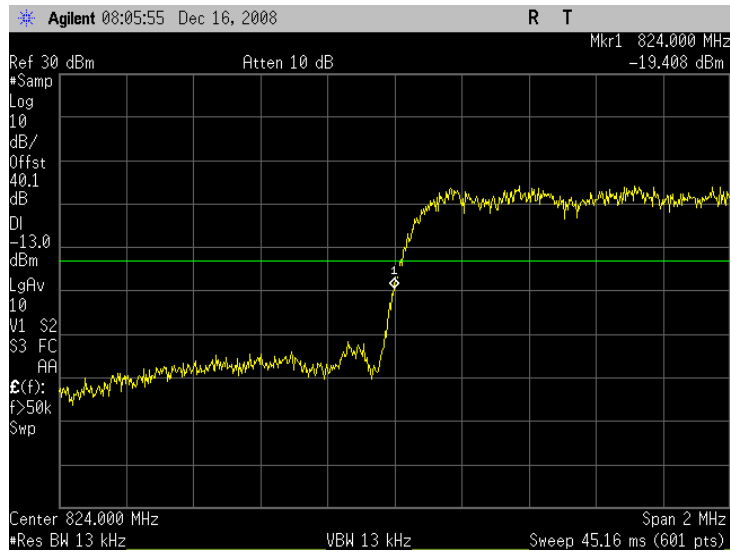

Plot 6.2 - 22 (Ch777, 1xEVDO Rel 0, 153.6kbps)

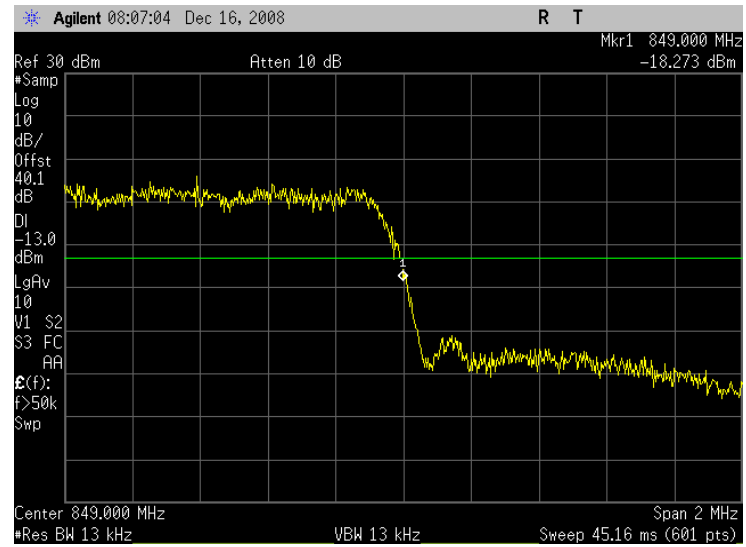

Plot 6.2 - 23 (Ch25, 1xEVDO Rel 0, 153.6kbps)

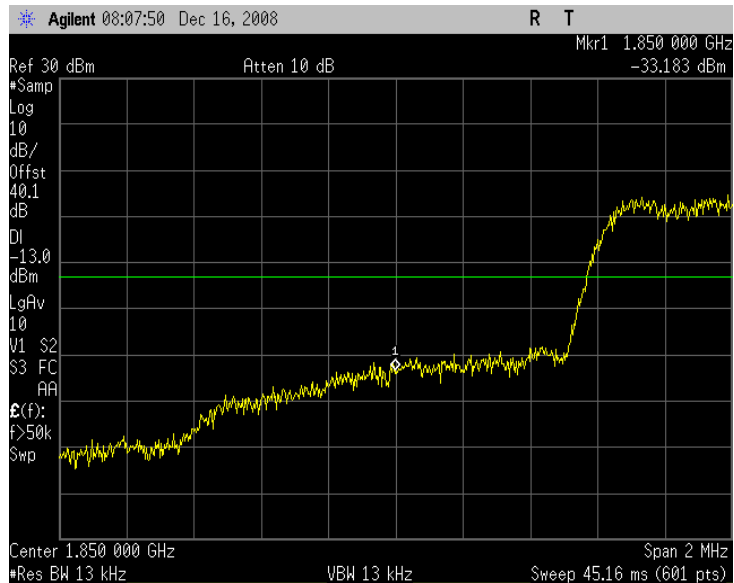

Plot 6.2 - 24 (Ch1175, 1xEVDO Rel 0, 153.6kbps)

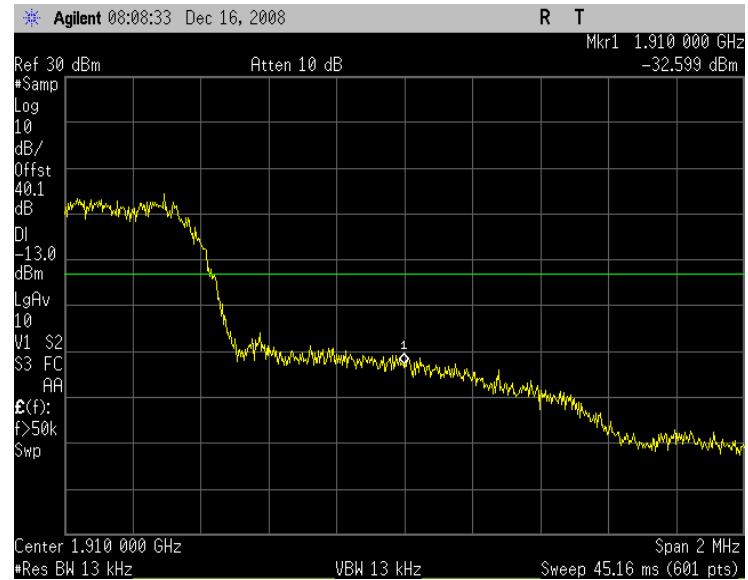

Plot 6.2 - 25 (Ch1013, 1xEVDO Rev A, 4096 payload)

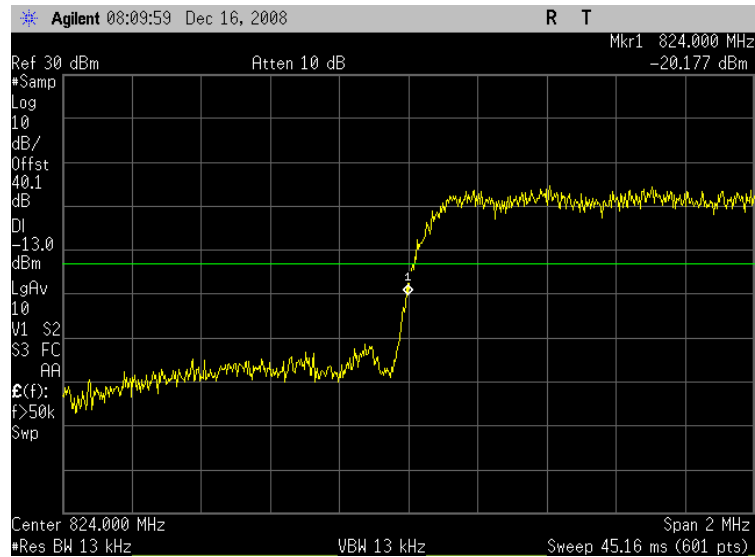

Plot 6.2 - 26 (Ch777, 1xEVDO Rev A, 4096 payload)

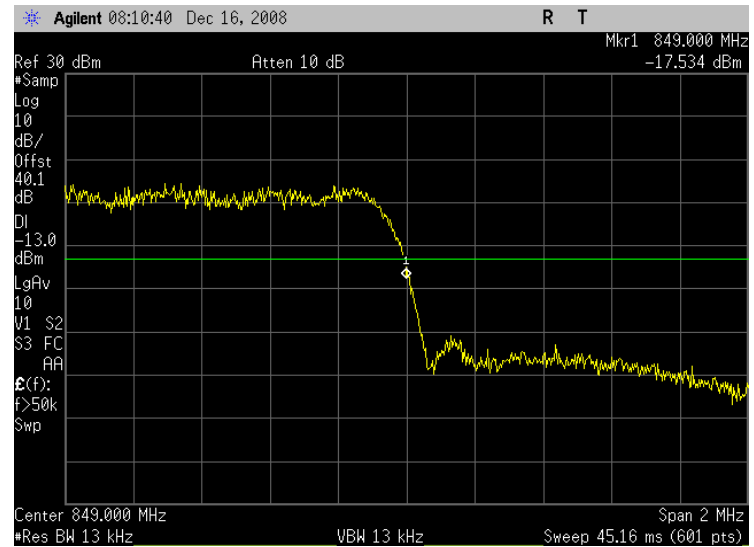

Plot 6.2 - 27 (Ch25, 1xEVDO Rev A, 4096 payload)

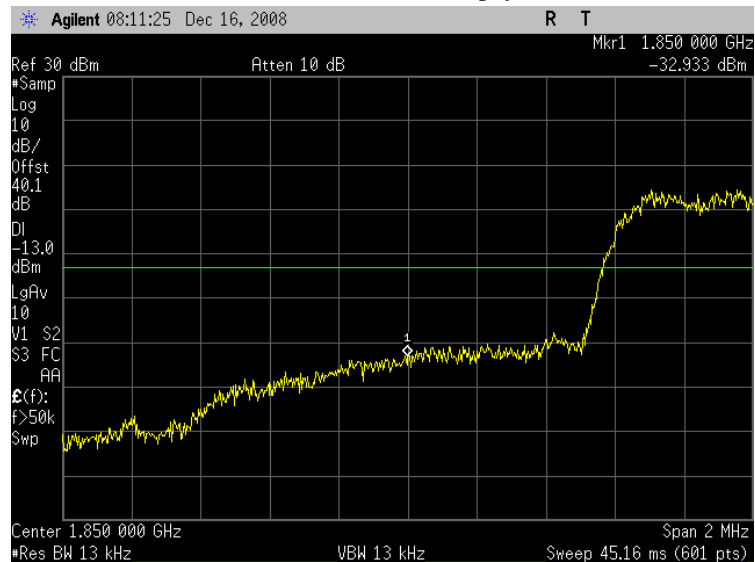

Plot 6.2 - 28 (Ch1175, 1xEVDO Rev A, 4096 payload)

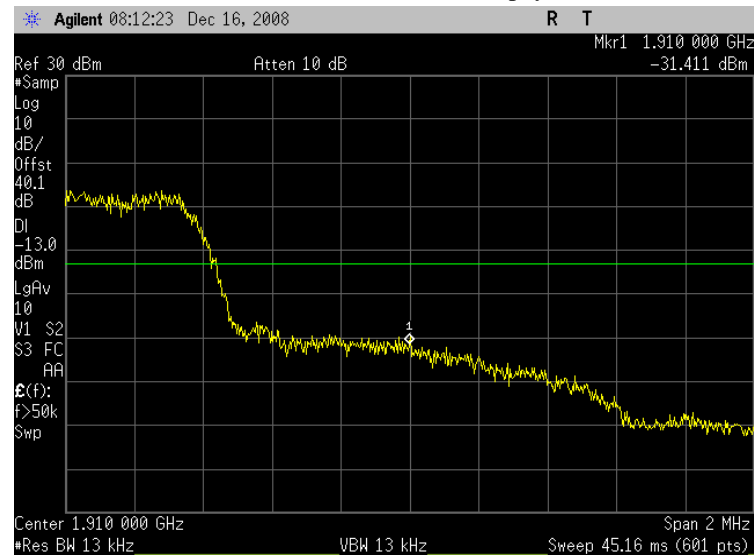

This page intentionally left blank.



## 7. Out of Band Emission at Antenna Terminals

<b>FCC:</b>	§22.901(d), 22.917, 24.238 (a)		
<b>Limit:</b>	-13dBm		
<b>DUT SN</b>	N10DGGVRD		
<b>Modes Tested</b>	CDMA 1x / 1x-EVDO	WCDMA/HSPA	GSM/GPRS/EDGE
	Rel 0, RTAP rate = 153.6kbps	Rel 99	GSM EDGE

### 12. Test Procedure

As Figure below indicates, connected the RF output to the spectrum analyzer through a calibrated coaxial cable. Scan the out-of-band emission up to 10<sup>th</sup> harmonics. Set RBW and VBW as 100kHz for the measurement below 1GHz, and 1MHz for testing above 1GHz. Recorded multiple sweeps in maximum hold mode using a peak detector to ensure that the worst case emission was caught.

Used 8960 call box for CDMA 1x/1x-EVDO measurement, and 8820B for UMTS testing.

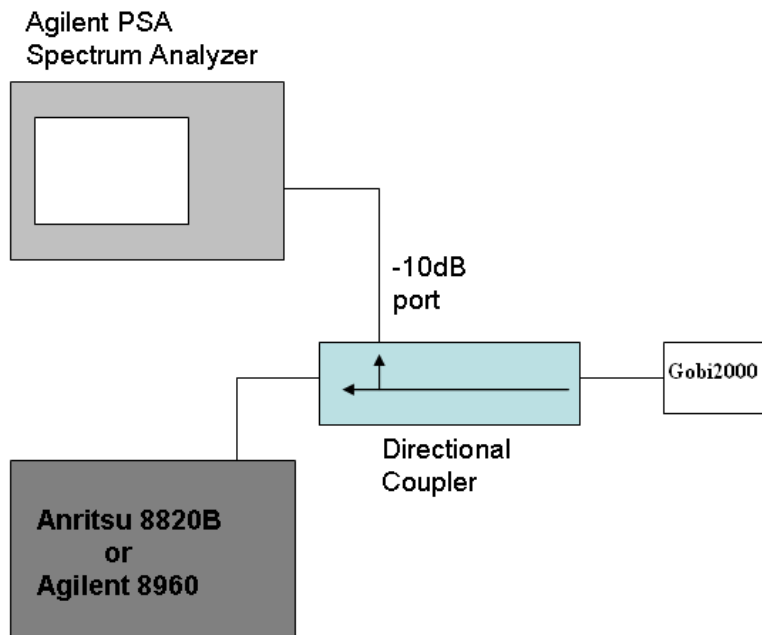

### 13. Test Results

The test was conducted at low, mid and high channel in each band.

Mode		Frequency Range Tested	Tx Channel	Corresponding Plot number	Test Result
GSM/ GPRS/ EDGE	GMSK	0 ~ 20 GHz	128	Plot 7.2 - 1, 2	Complies
		0 ~ 20 GHz	190	Plot 7.2 - 3, 4	Complies
		0 ~ 20 GHz	251	Plot 7.2 - 5, 6	Complies
		0 ~ 20 GHz	512	Plot 7.2 - 7, 8	Complies
		0 ~ 20 GHz	661	Plot 7.2 - 9, 10	Complies
		0 ~ 20 GHz	810	Plot 7.2 - 11, 12	Complies
	8PSK	0 ~ 20 GHz	128	Plot 7.2 - 13, 14	Complies
		0 ~ 20 GHz	190	Plot 7.2 - 15, 16	Complies
		0 ~ 20 GHz	251	Plot 7.2 - 17, 18	Complies
		0 ~ 20 GHz	512	Plot 7.2 - 19, 20	Complies
		0 ~ 20 GHz	661	Plot 7.2 - 21, 22	Complies
		0 ~ 20 GHz	810	Plot 7.2 - 23, 24	Complies

Mode		Frequency Range Tested	Tx Channel	Corresponding Plot number	Test Result
WCDMA/ HSDPA/ HSUPA	Rel 99	0 ~ 20 GHz	4132	Plot 7.2 - 25, 26	Complies
		0 ~ 20 GHz	4182	Plot 7.2 - 27, 28	Complies
		0 ~ 20 GHz	4233	Plot 7.2 - 29, 30	Complies
		0 ~ 20 GHz	9262	Plot 7.2 - 31, 32	Complies
		0 ~ 20 GHz	9400	Plot 7.2 - 33, 34	Complies
		0 ~ 20 GHz	9538	Plot 7.2 - 35, 36	Complies

Mode		Frequency (MHz)	Channel Tested	Corresponding Plot number	Test Result
CDMA1x/ 1x-EVDO	Rel 0 RTAP rate = 153.6kbps	0 ~ 20 GHz	1013	Plot 7.2 - 37, 38	Complies
		0 ~ 20 GHz	384	Plot 7.2 - 39, 40	Complies
		0 ~ 20 GHz	777	Plot 7.2 - 41, 42	Complies
		0 ~ 20 GHz	25	Plot 7.2 - 43, 44	Complies
		0 ~ 20 GHz	600	Plot 7.2 - 45, 46	Complies
		0 ~ 20 GHz	1175	Plot 7.2 - 47, 48	Complies

### 14. Plots

Plot 7.2 - 1 (GMSK Ch128)

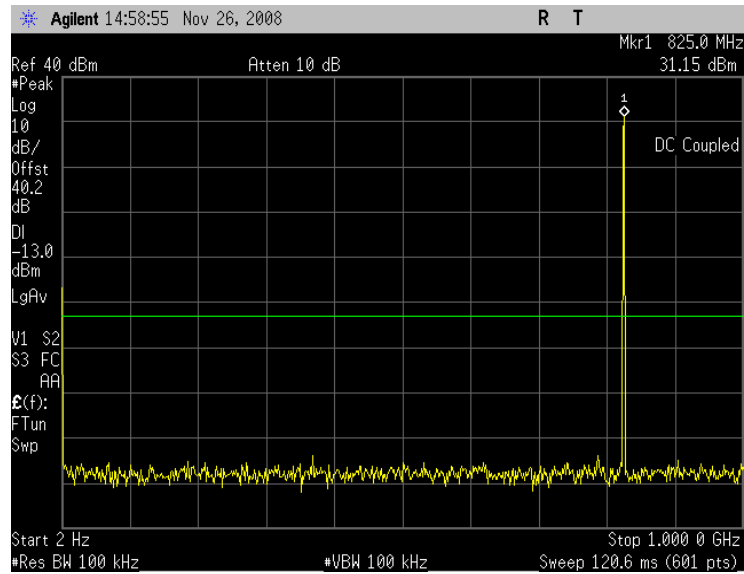

Plot 7.2 - 2 (GMSK Ch128)

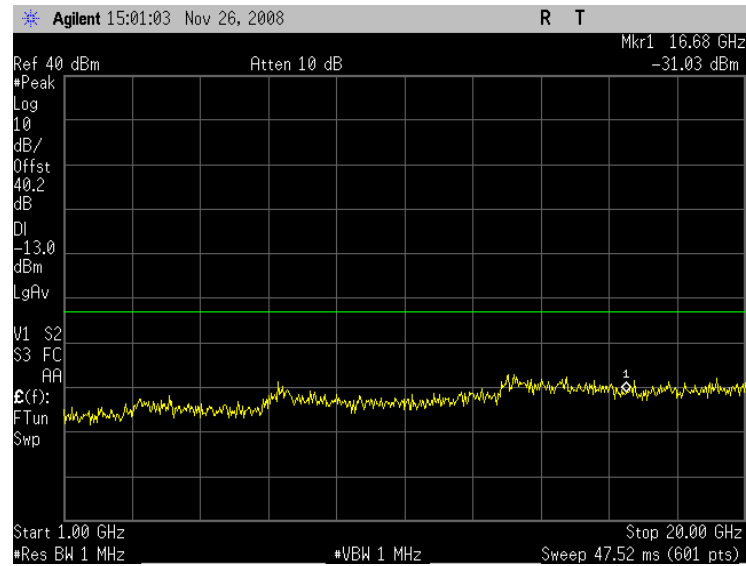

Plot 7.2 - 3 (GMSK Ch190)

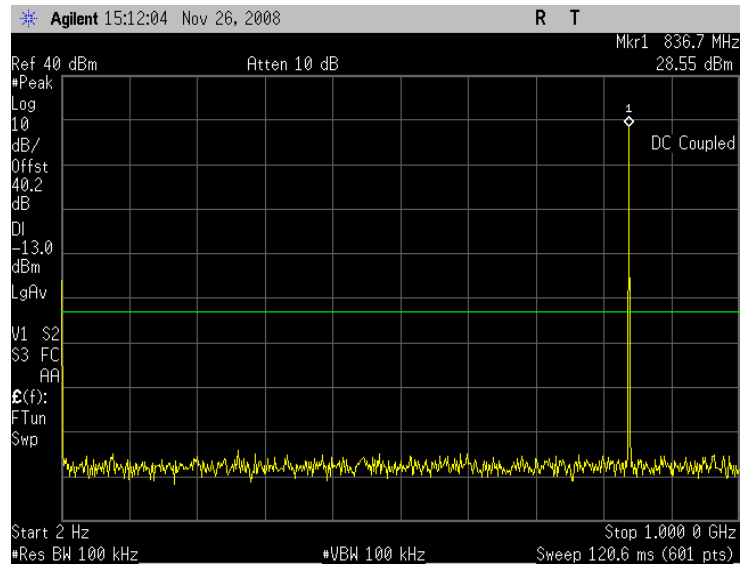

Plot 7.2 - 4 (GMSK Ch190)

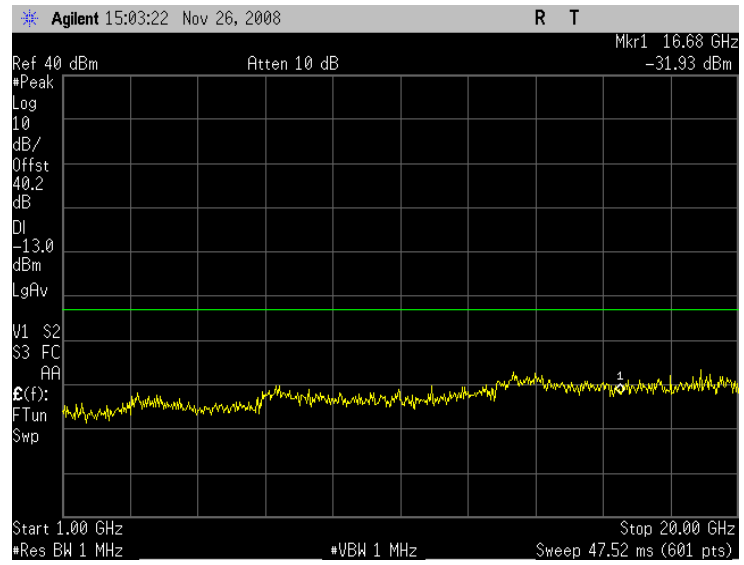

Plot 7.2 - 5 (GMSK Ch251)

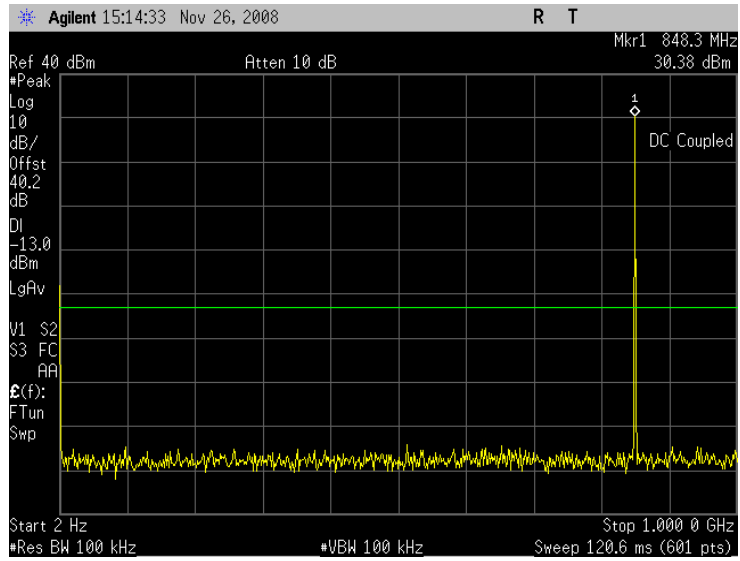

Plot 7.2 - 6 (GMSK Ch251)

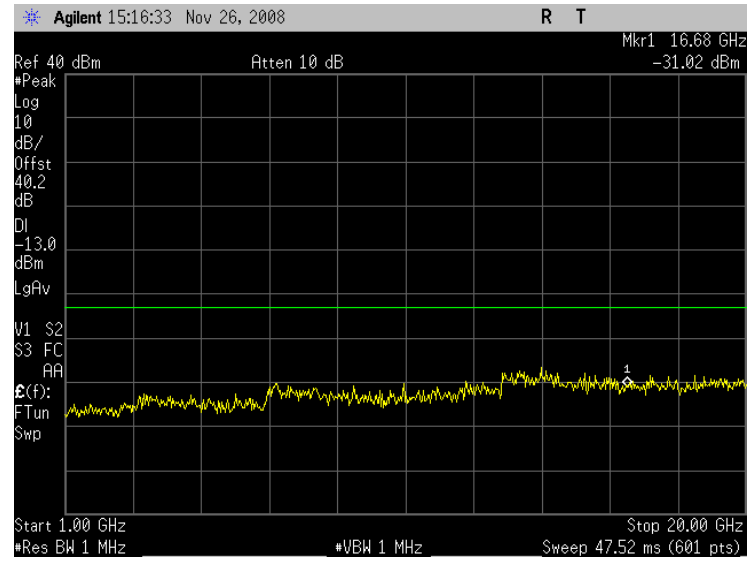

Plot 7.2 - 7 (GMSK Ch512)

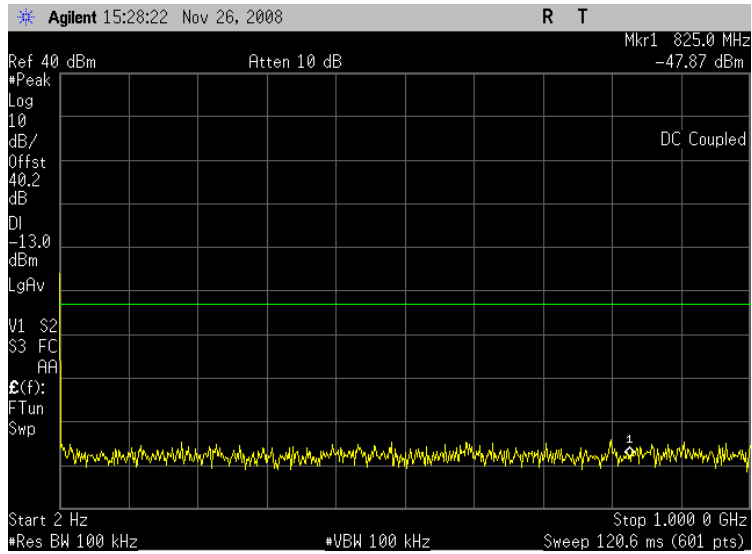

Plot 7.2 - 8 (GMSK Ch512)

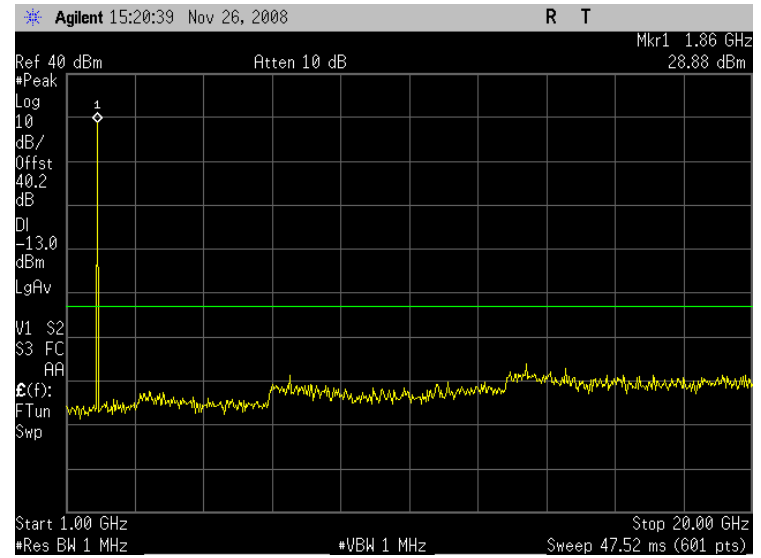

Plot 7.2 - 9 (GMSK Ch661)

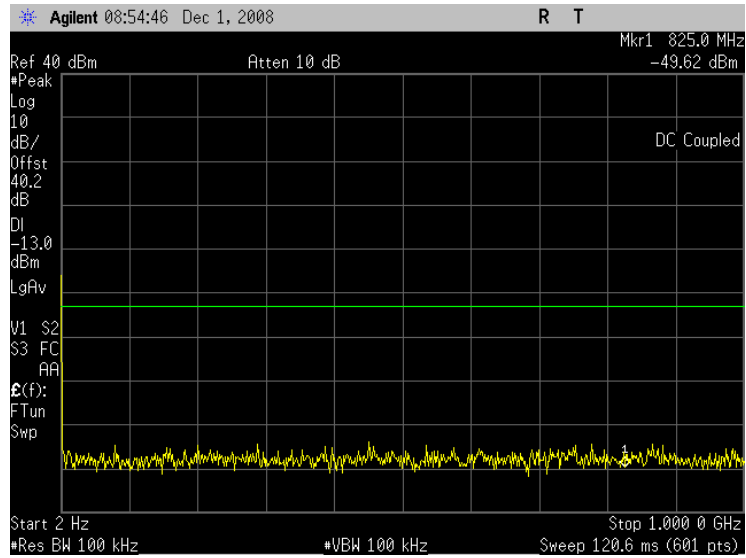

Plot 7.2 - 10 (GMSK Ch661)

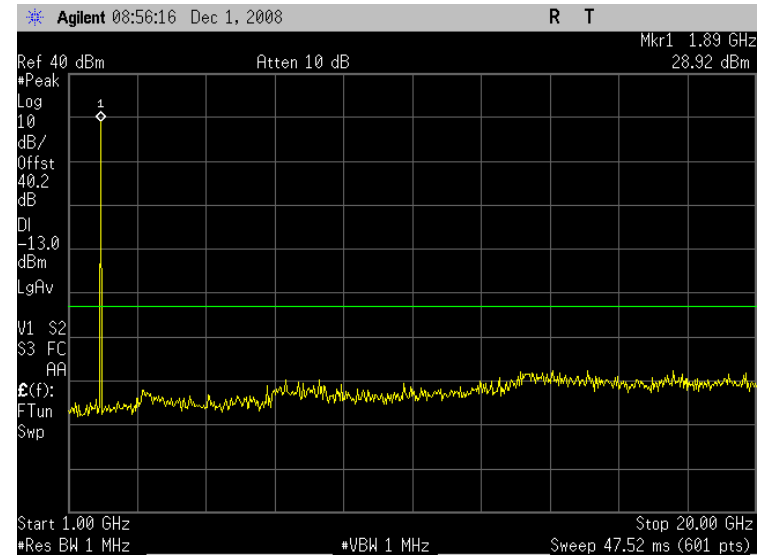



Plot 7.2 - 11 (GMSK Ch810)

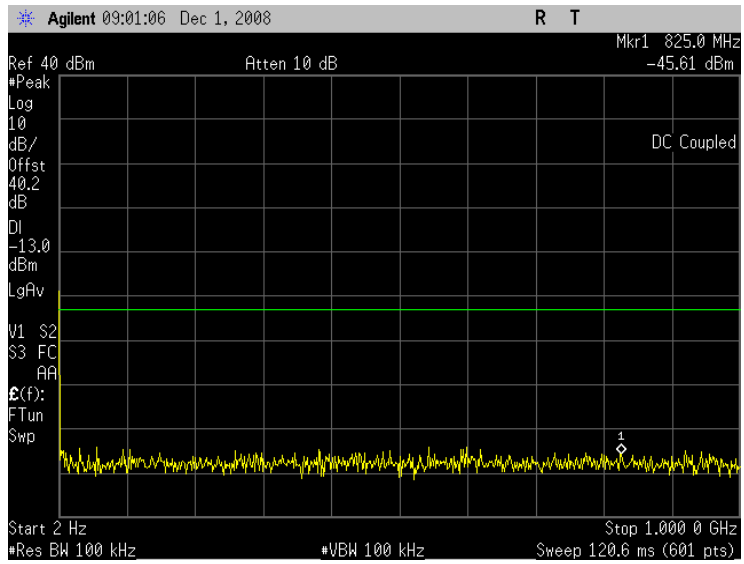

Plot 7.2 - 12 (GMSK Ch810)

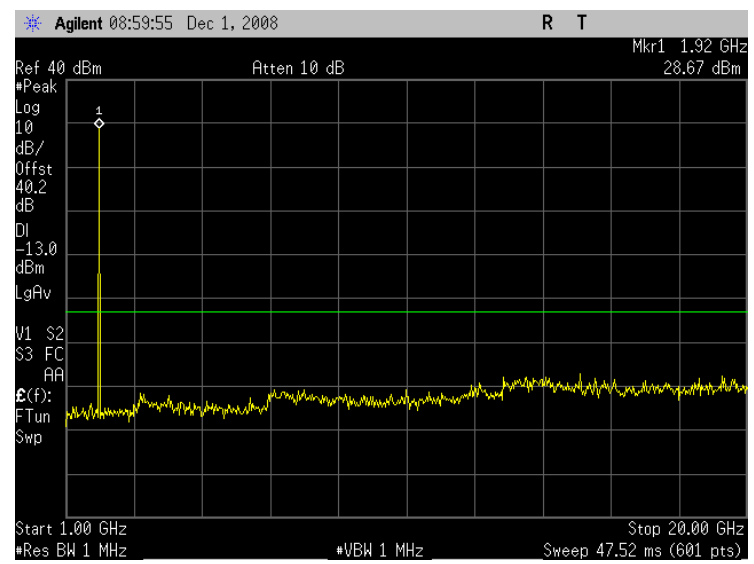

Plot 7.2 - 13 (8PSK Ch128)

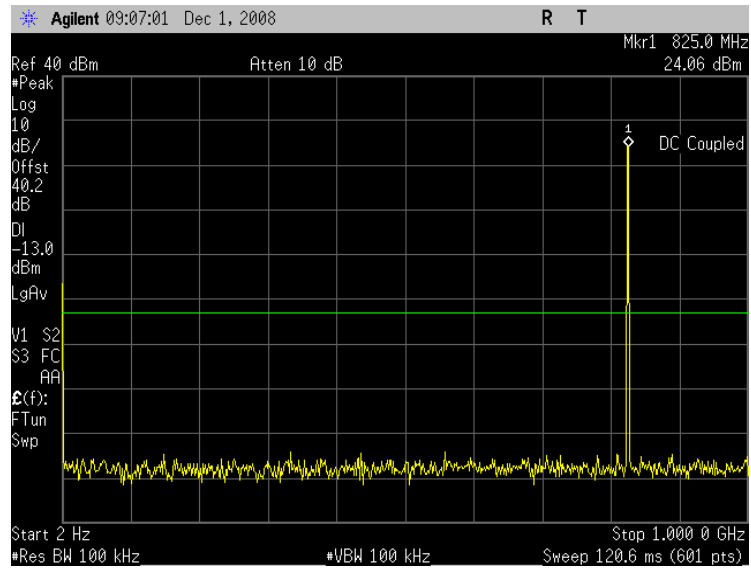

Plot 7.2 - 14 (8PSK Ch128)

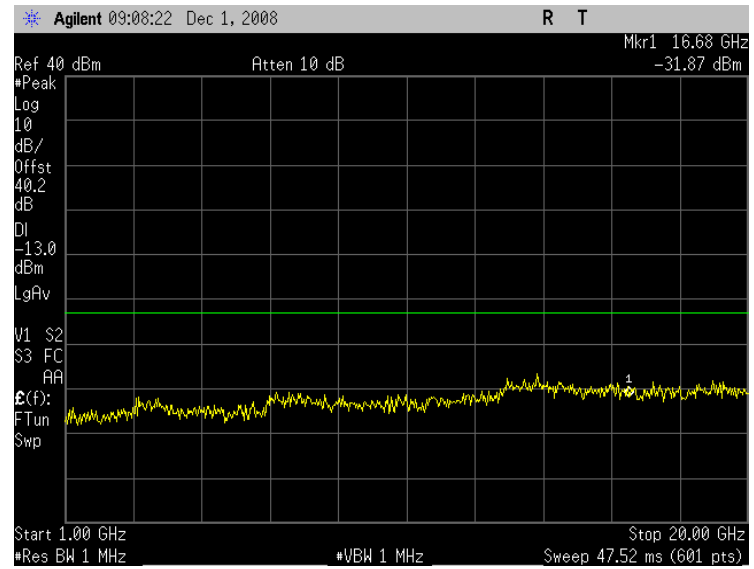

Plot 7.2 - 15 (8PSK Ch190)

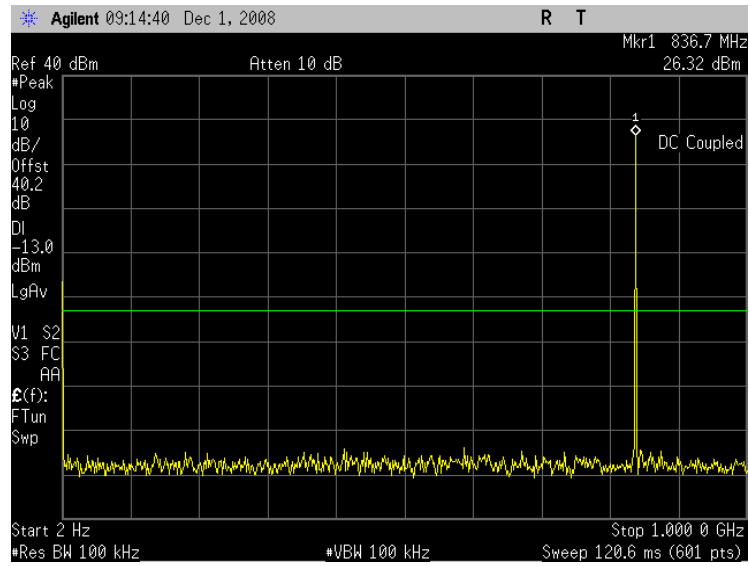

Plot 7.2 - 16 (8PSK Ch190)

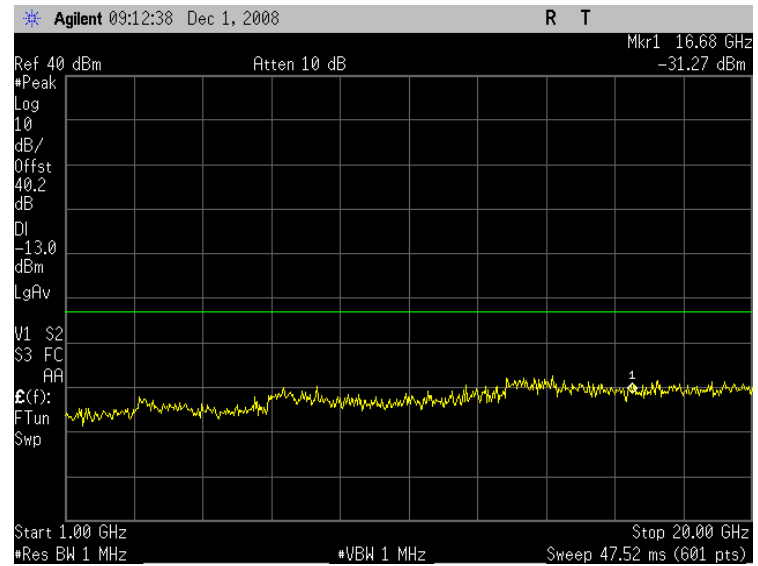

Plot 7.2 - 17 (8PSK Ch251)

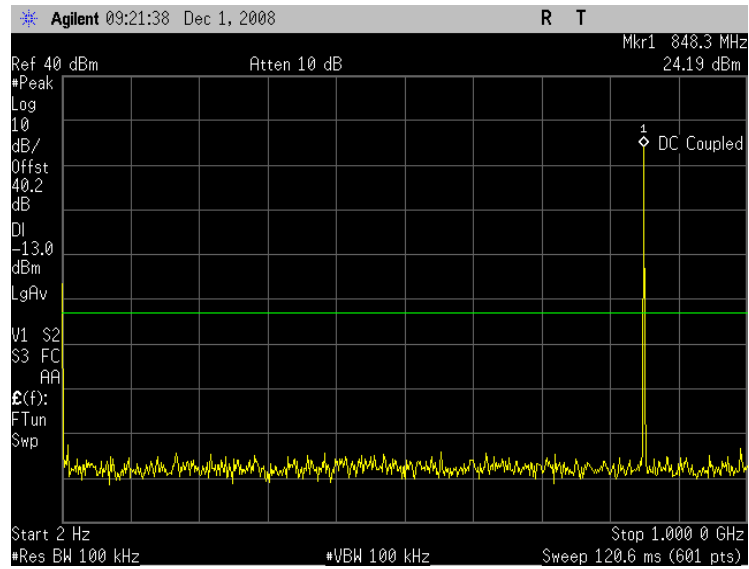

Plot 7.2 - 18 (8PSK Ch251)

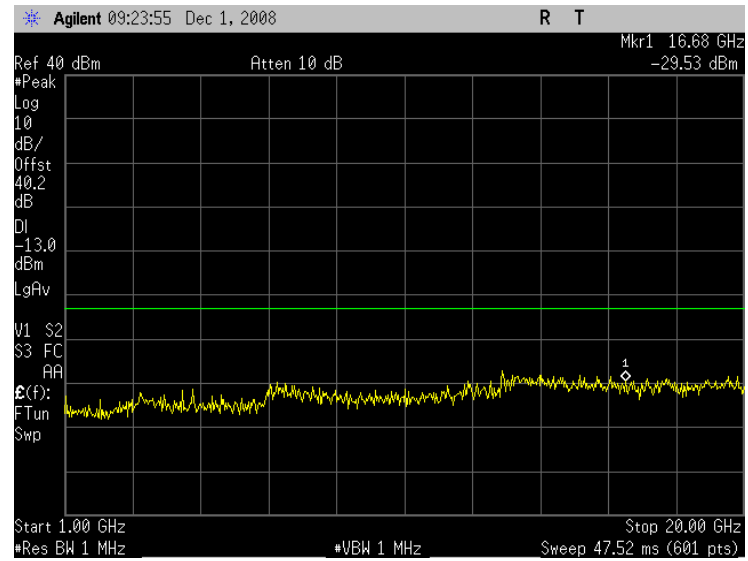

Plot 7.2 - 19 (8PSK Ch512)

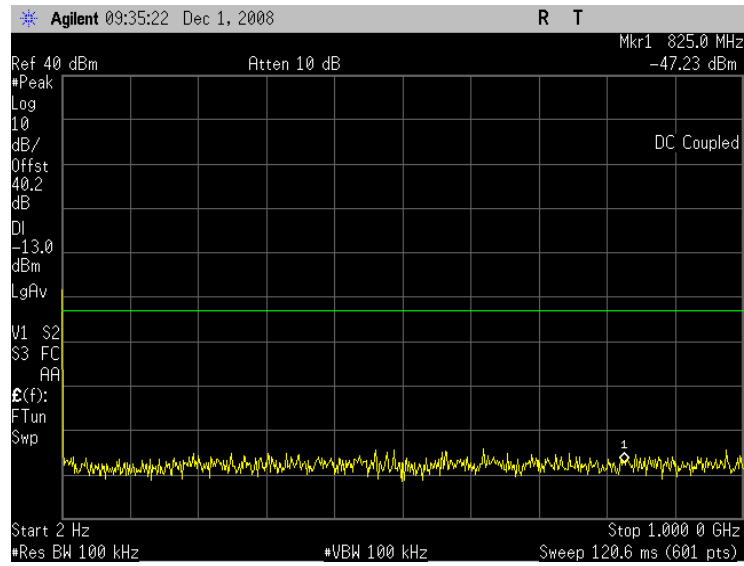

Plot 7.2 - 20 (8PSK Ch512)

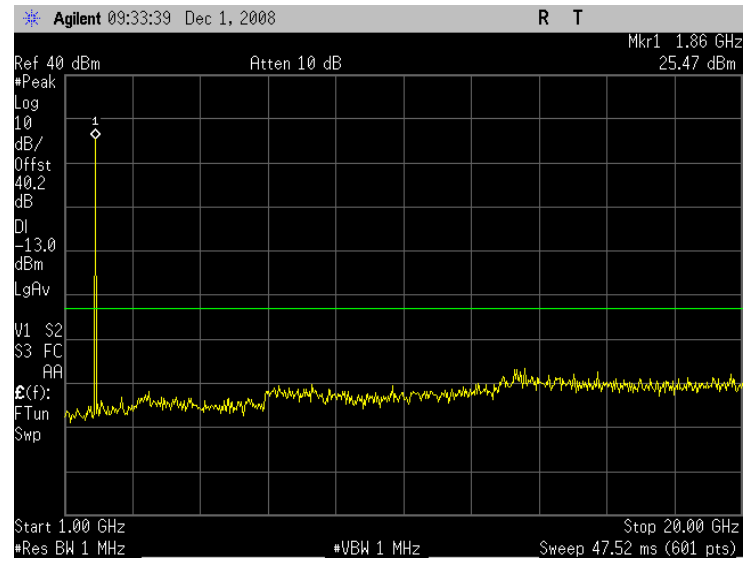

Plot 7.2 - 21 (8PSK Ch661)

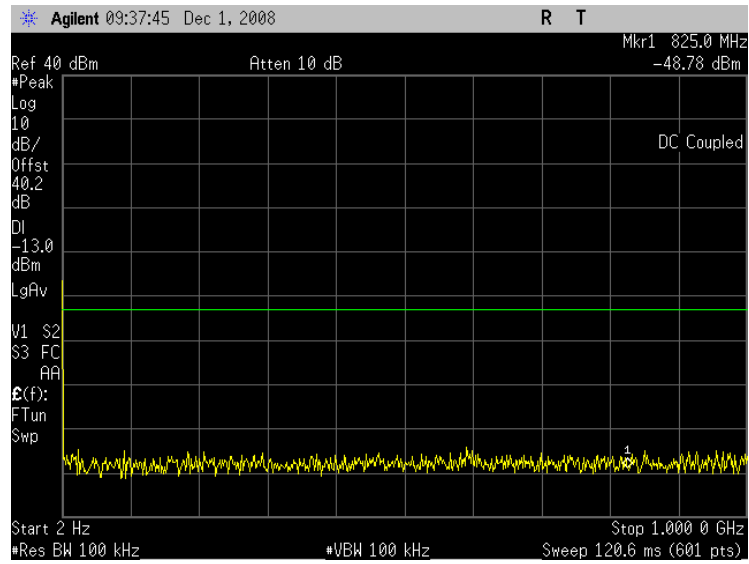

Plot 7.2 - 22 (8PSK Ch661)

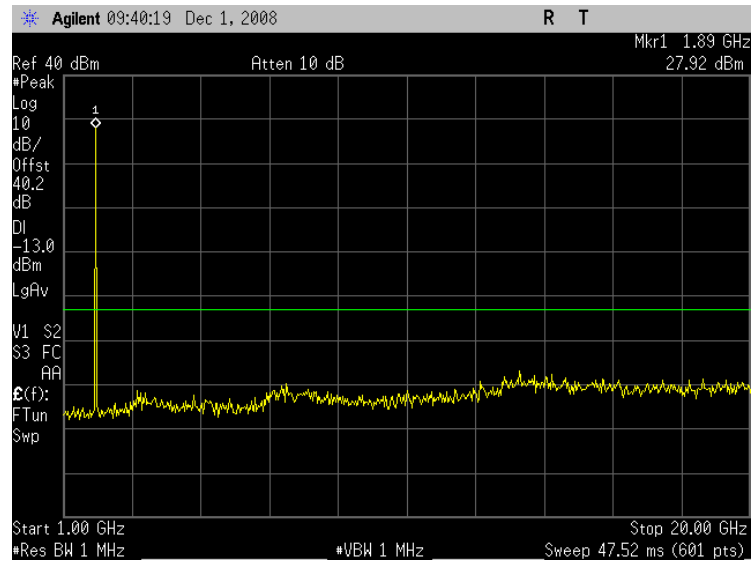

Plot 7.2 - 23 (8PSK Ch810)

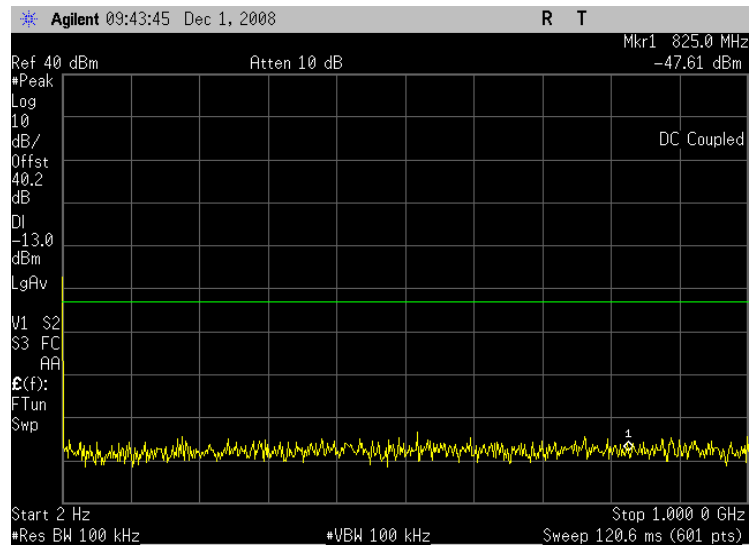

Plot 7.2 - 24 (8PSK Ch810)

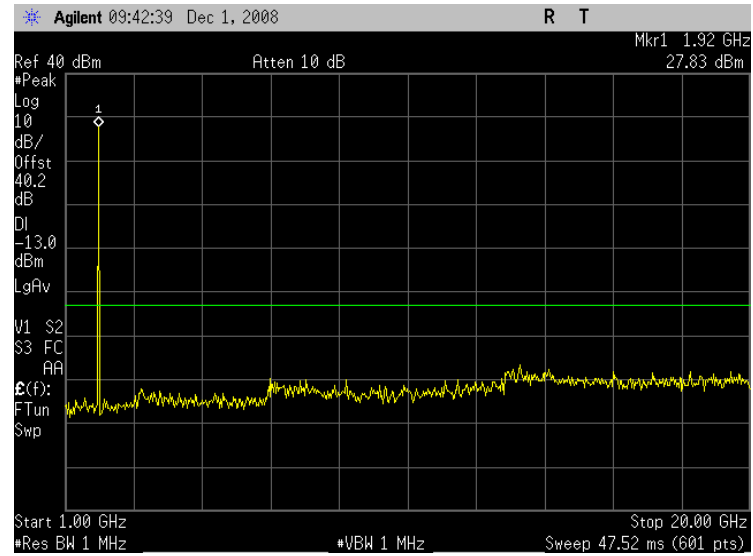

Plot 7.2 - 25 (WCDMA, Rel99, Ch4132)

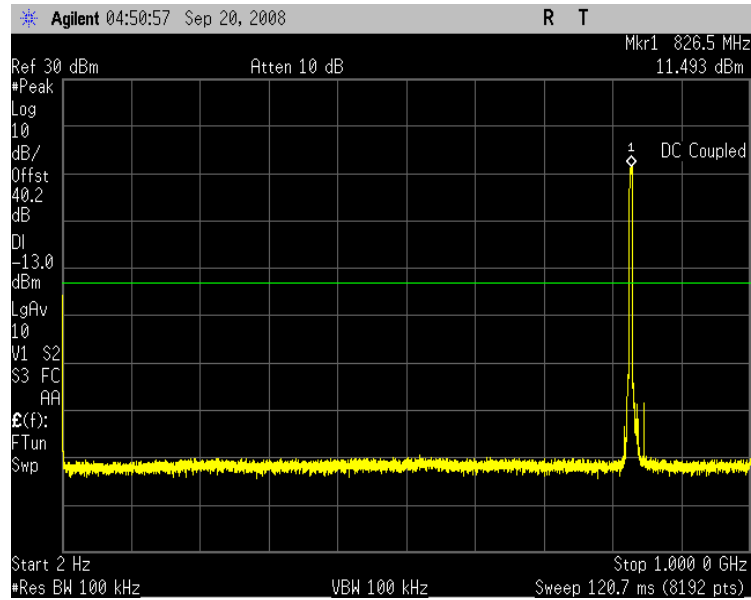

Plot 7.2 - 26 (WCDMA, Rel99, Ch4132)

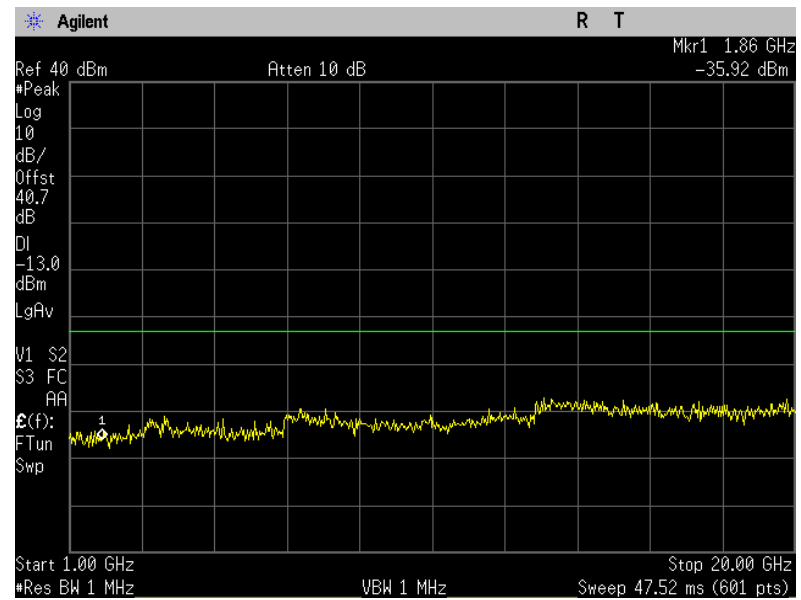



Plot 7.2 - 27 (WCDMA, Rel99, Ch4182)

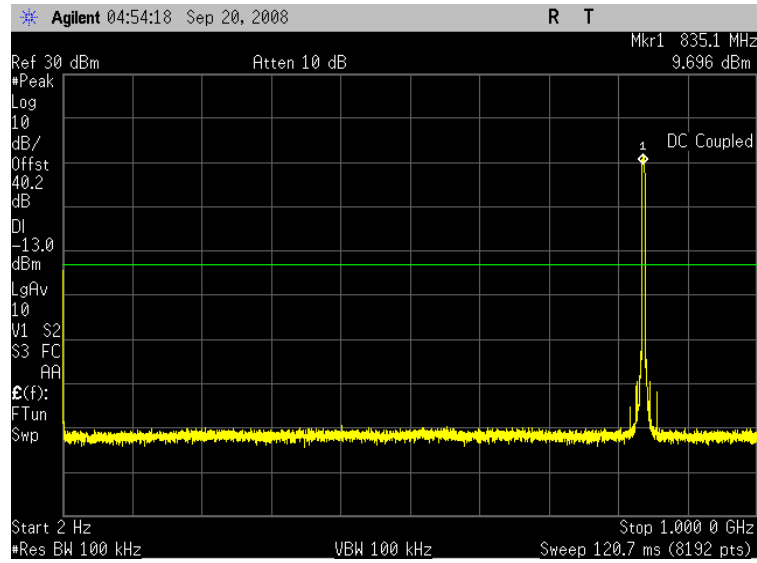

Plot 7.2 - 28 (WCDMA, Rel99, Ch4182)

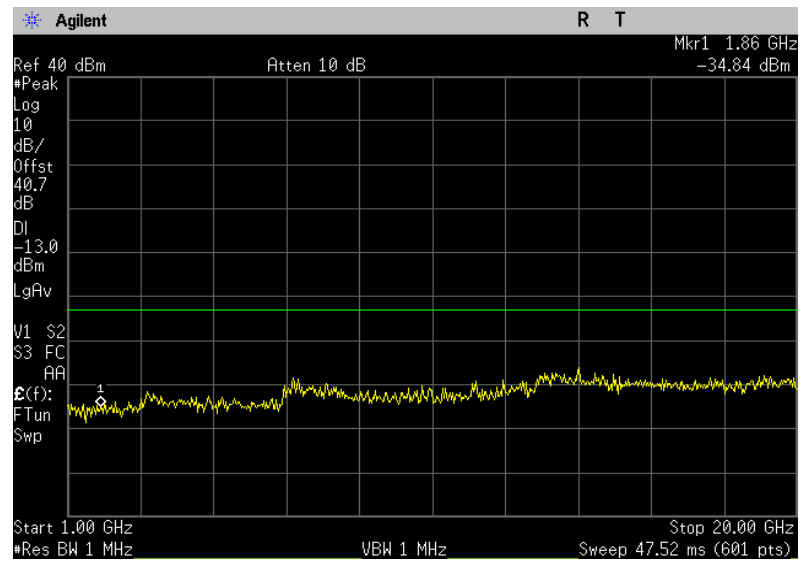

Plot 7.2 - 29(WCDMA, Rel99, Ch4233)

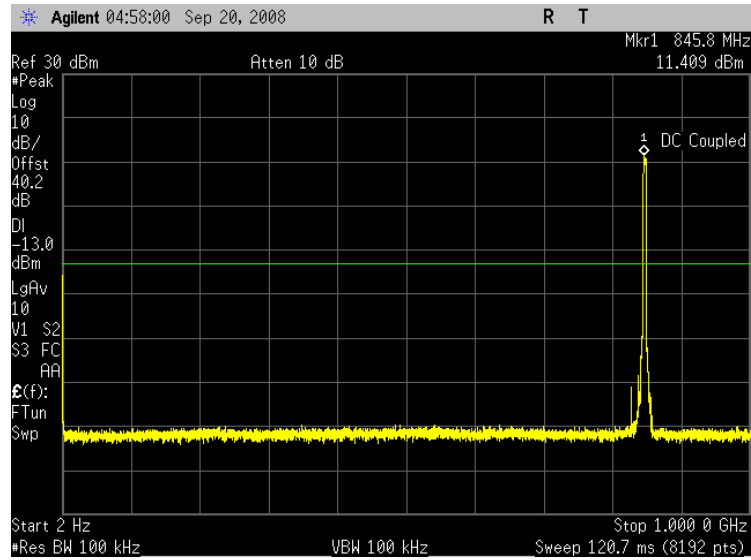

Plot 7.2 - 30 (WCDMA, Rel99, Ch4233)

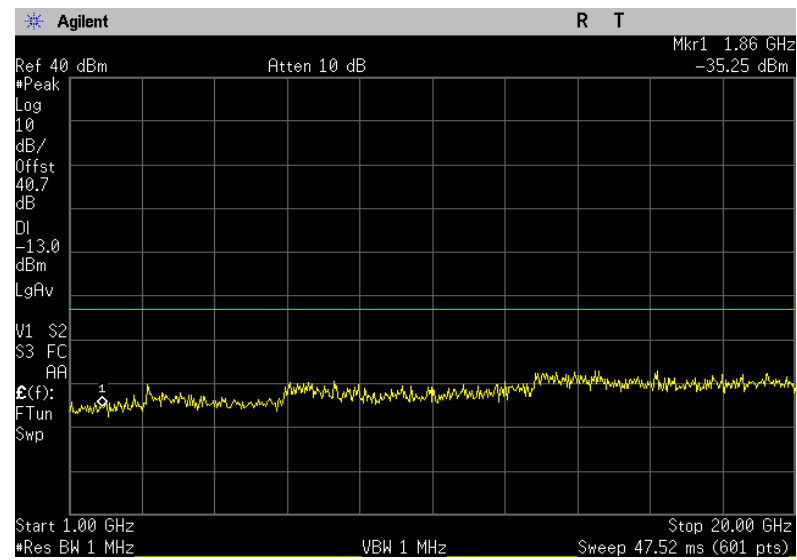

Plot 7.2 - 31 (WCDMA, Rel99, Ch9262)

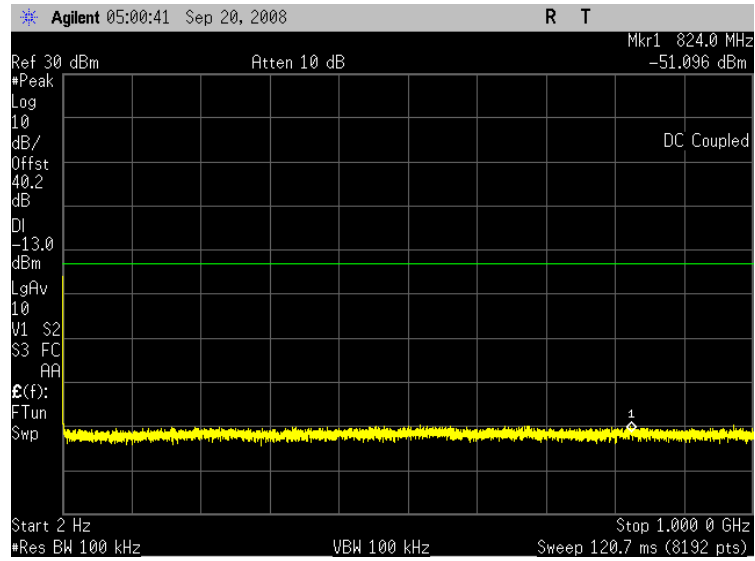

Plot 7.2 - 32 (WCDMA, Rel99, Ch9262)

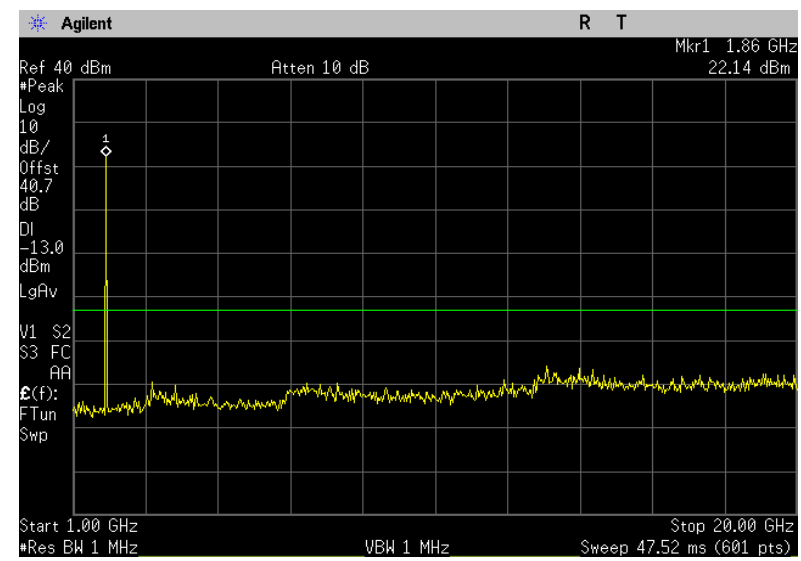

Plot 7.2 - 33 (WCDMA, Rel99, Ch9400)

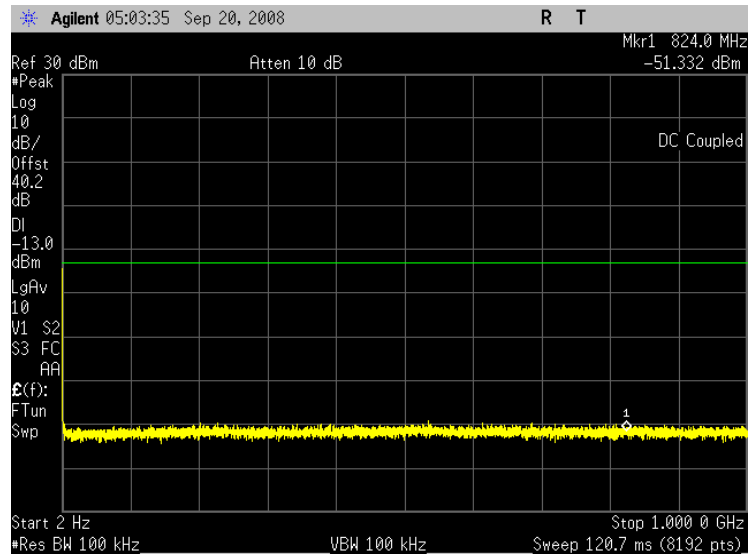

Plot 7.2 - 34 (WCDMA, Rel99, Ch9400)

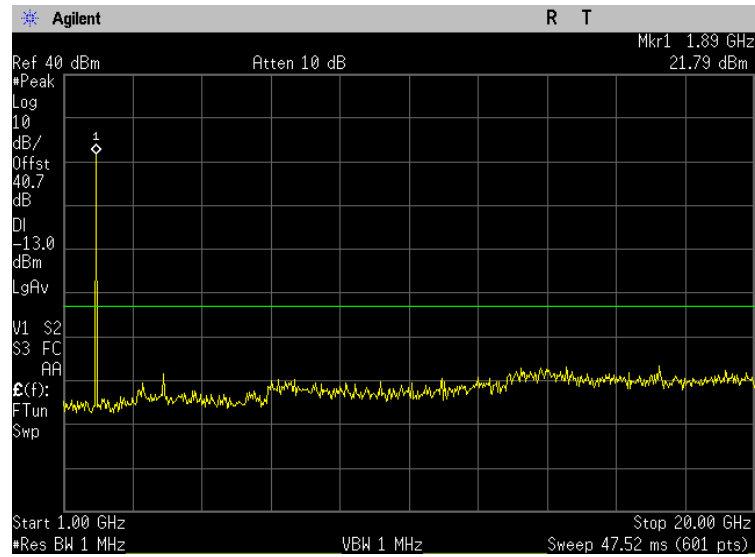

Plot 7.2 - 35 (WCDMA, Rel99, Ch9538)

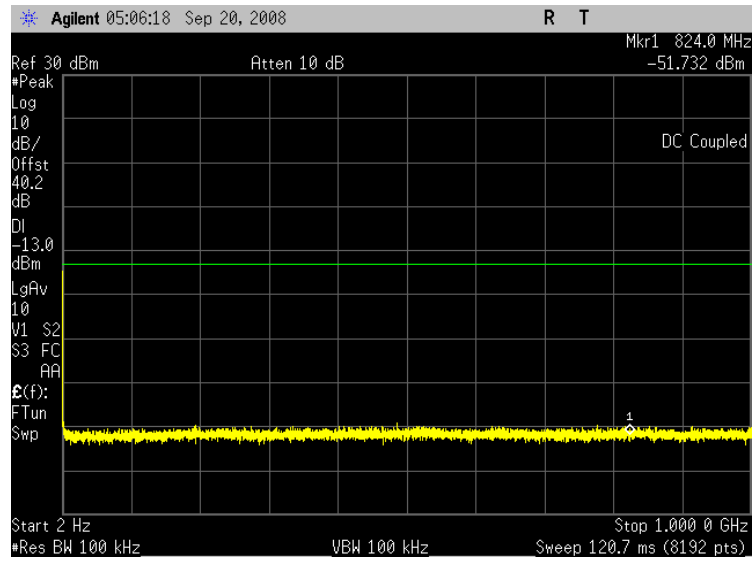

Plot 7.2 - 36 (WCDMA, Rel99, Ch9538)

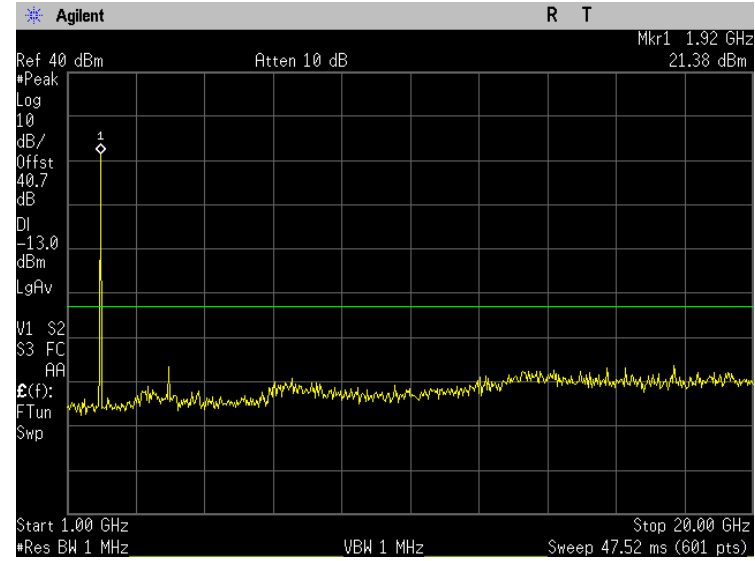

Plot 7.2 - 37 (EVDO, Rel0, 153.6kbps, Ch1013)

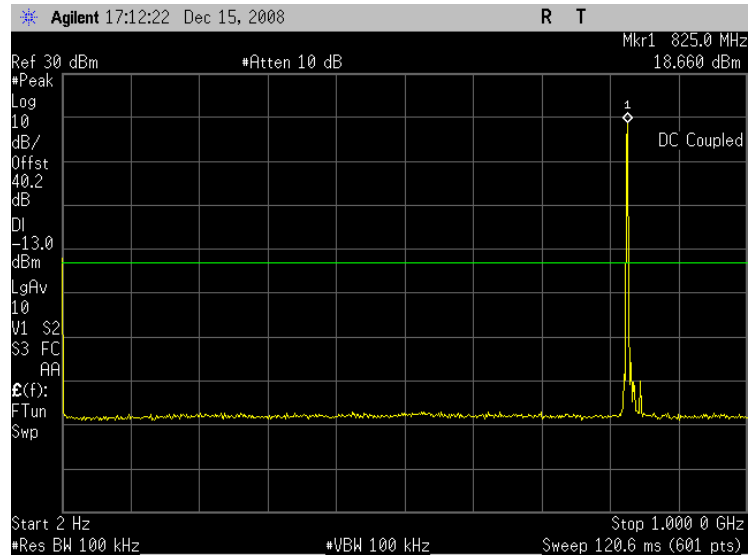

Plot 7.2 - 38 (EVDO, Rel0, 153.6kbps, Ch1013)

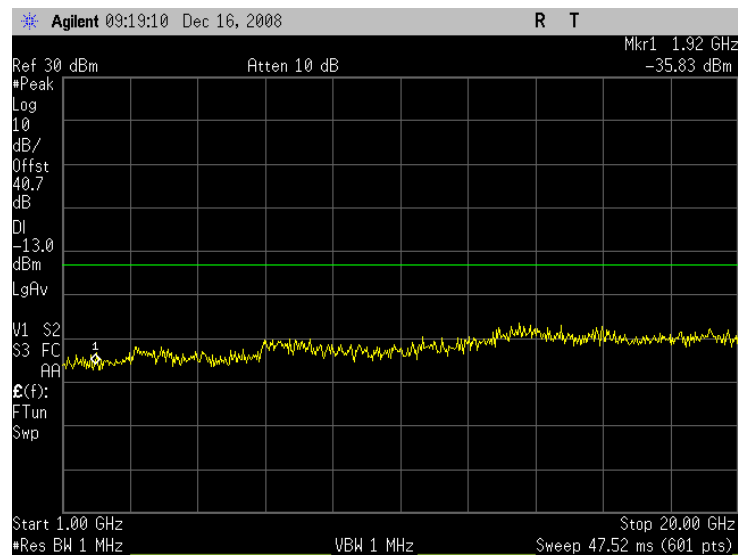

Plot 7.2 - 39 (EVDO, Rel0, 153.6kbps, Ch384)

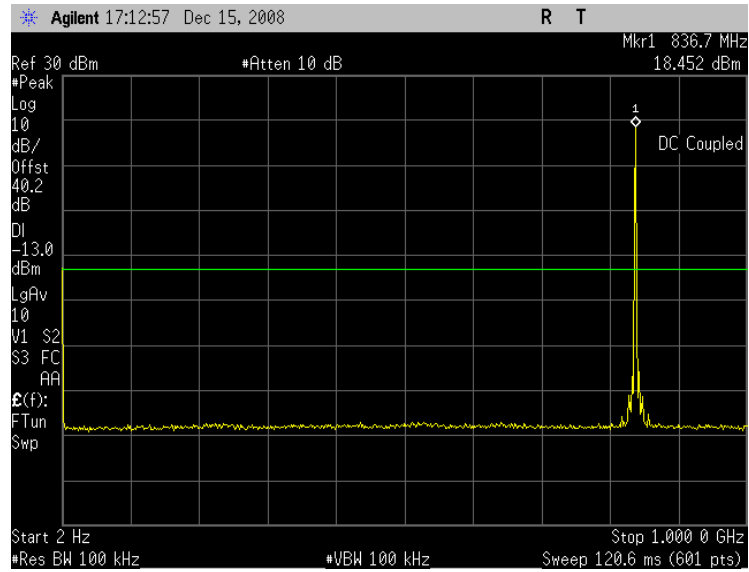

Plot 7.2 - 40 (EVDO, Rel0, 153.6kbps, Ch384)

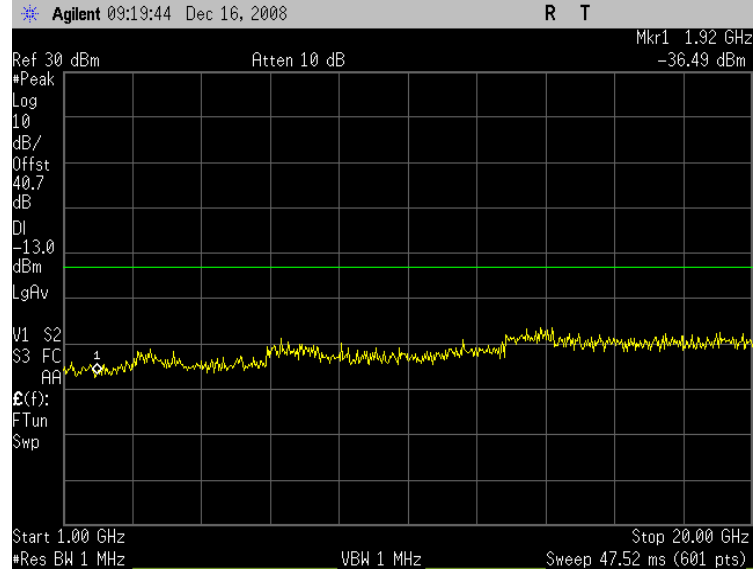

Plot 7.2 - 41 (EVDO, Rel0, 153.6kbps, Ch777)

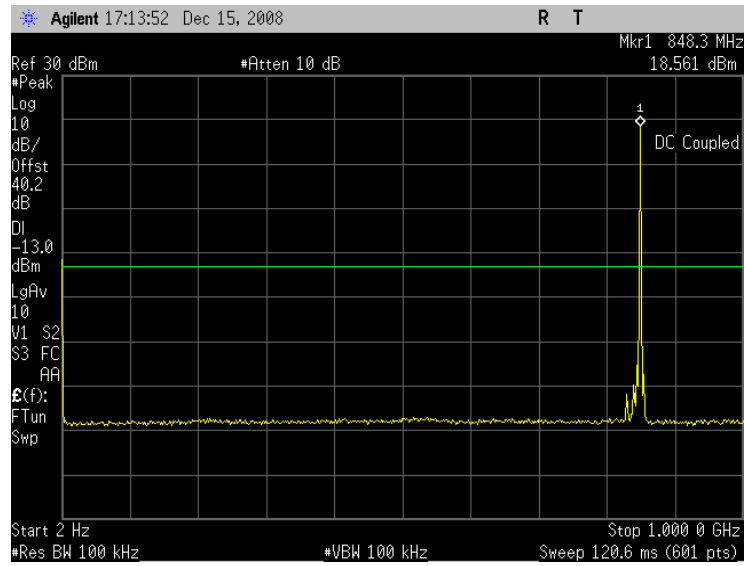

Plot 7.2 - 42 (EVDO, Rel0, 153.6kbps, Ch777)

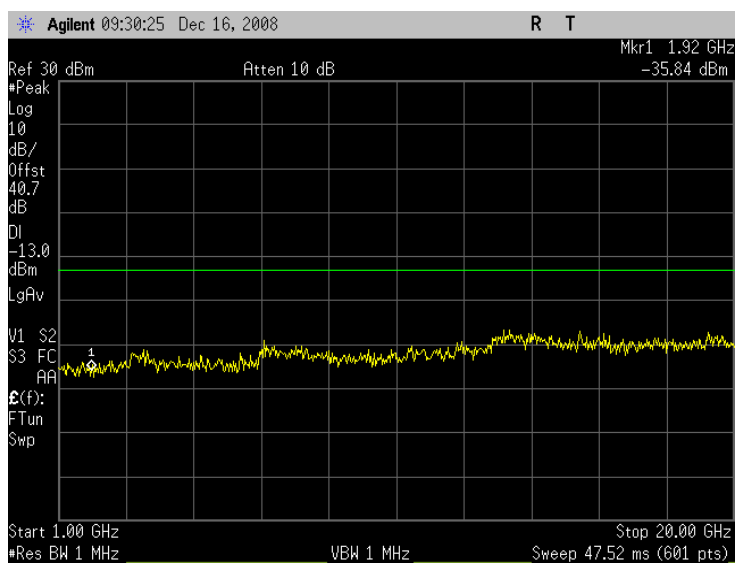



Plot 7.2 - 43 (EVDO, Rel0, 153.6kbps, Ch25)

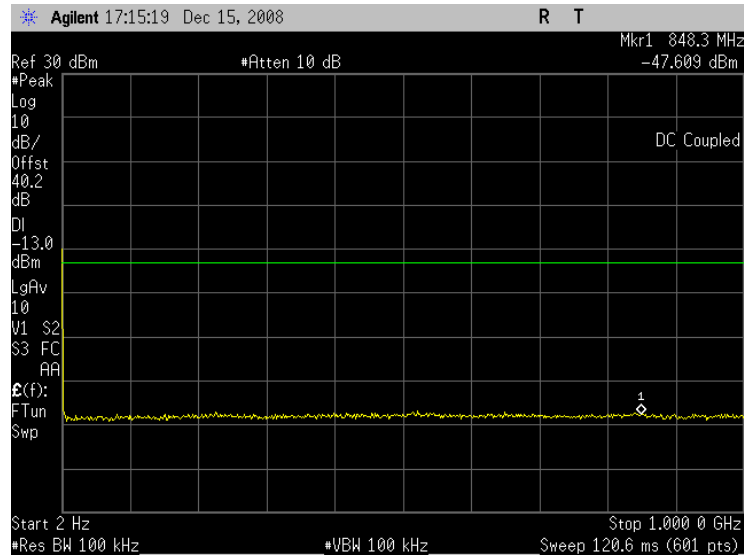

Plot 7.2 - 44 (EVDO, Rel0, 153.6kbps, Ch25)

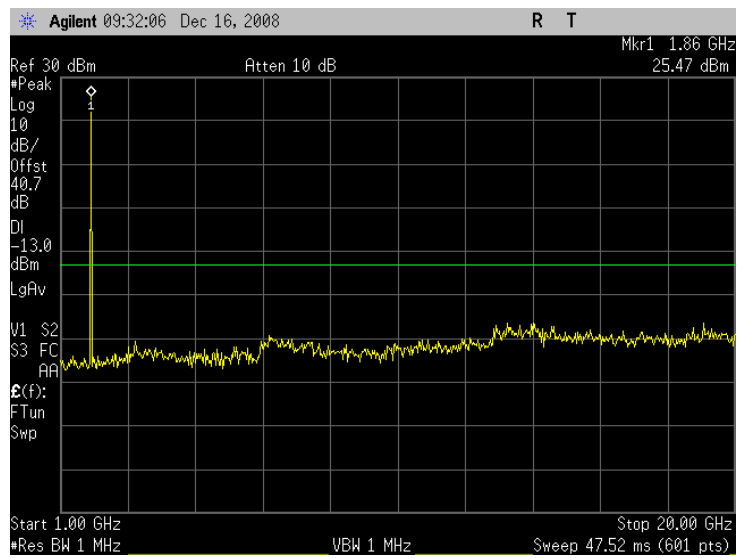

Plot 7.2 - 45 (EVDO, Rel0, 153.6kbps, Ch600)

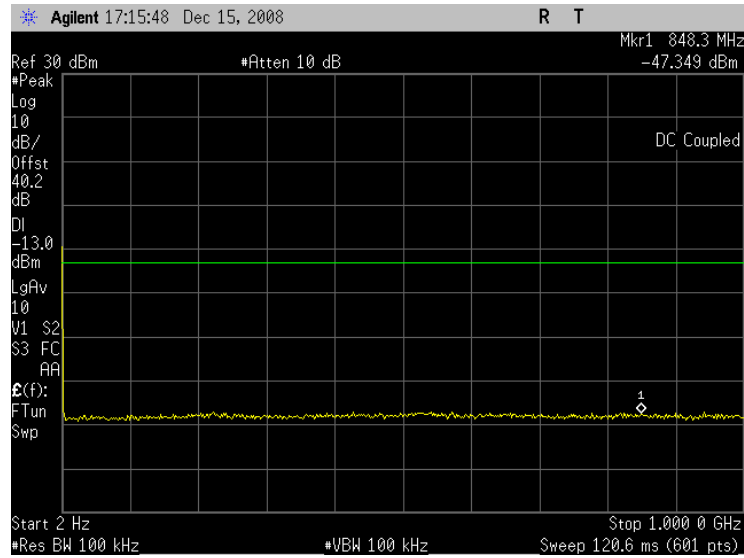

Plot 7.2 - 46 (EVDO, Rel0, 153.6kbps, Ch600)

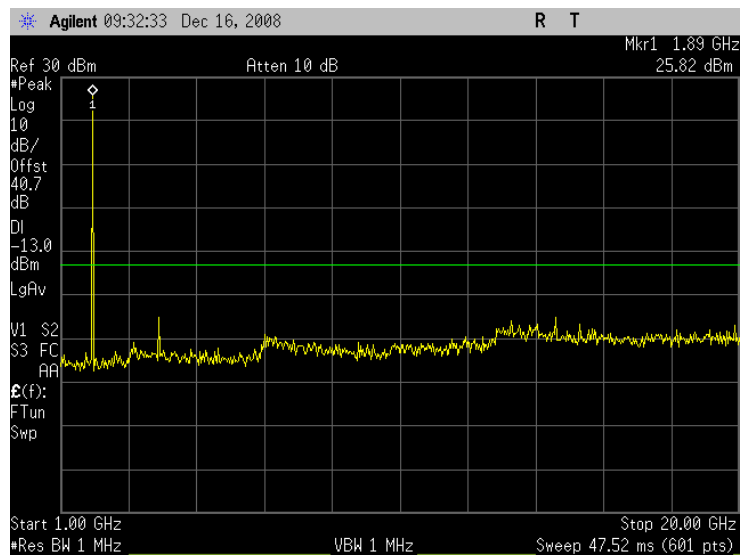

Plot 7.2 - 47 (EVDO, Rel0, 153.6kbps, Ch1175)

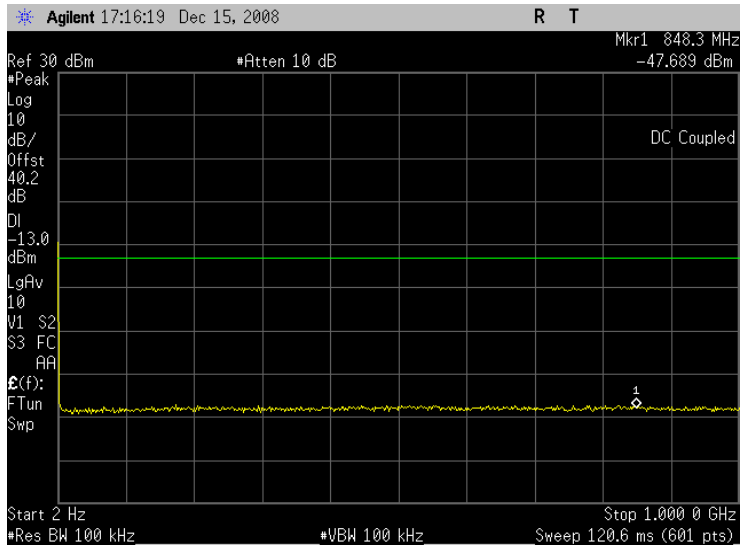

Plot 7.2 - 48 (EVDO, Rel0, 153.6kbps, Ch1175)

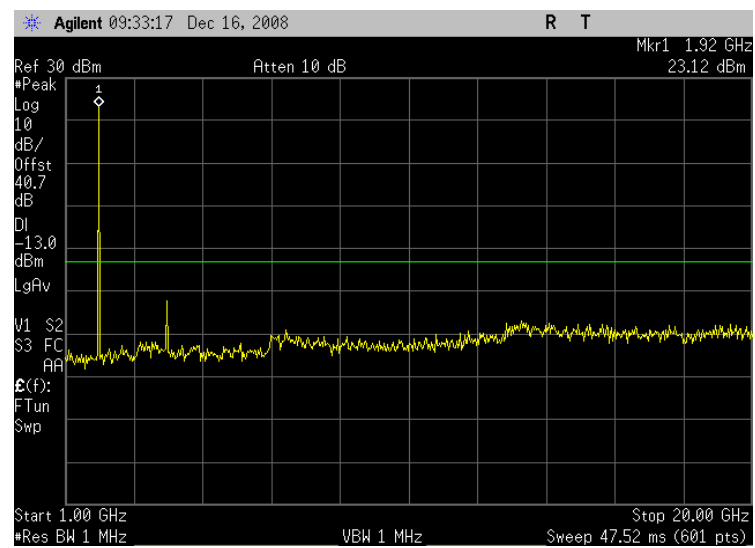

This page intentionally left blank.

## 8. Frequency Stability

<b>FCC:</b>	§2.1055, 22.355, 24.235		
<b>Limit:</b>	±2.5ppm		
<b>DUT SN</b>	N10DG52R3		
<b>Modes Tested</b>	CDMA 1x / 1x-EVDO	WCDMA/HSPA	GSM/GPRS/EDGE
	Rel 0, RTAP rate = 153.6kbps	Rel 99	GSM EDGE

### 15. Test Procedure

As the test setup indicates, placed the Gobi2000 inside the temperature chamber. Measured the transmitting frequency error at 20 degrees C with DC voltage varying from 3.0 volts to 3.6 volts, and then set the temperature to -30 degrees C and allow it to stabilize. After 1 hour soak time, take the measurement on transmitting frequency error at -30 degrees in the same manner. As an incremental of 10 degrees C, repeat the same process until +60 degrees C is completed.

Used 8960 call box for CDMA 1x/1x-EVDO measurement, and 8820B for UMTS testing.

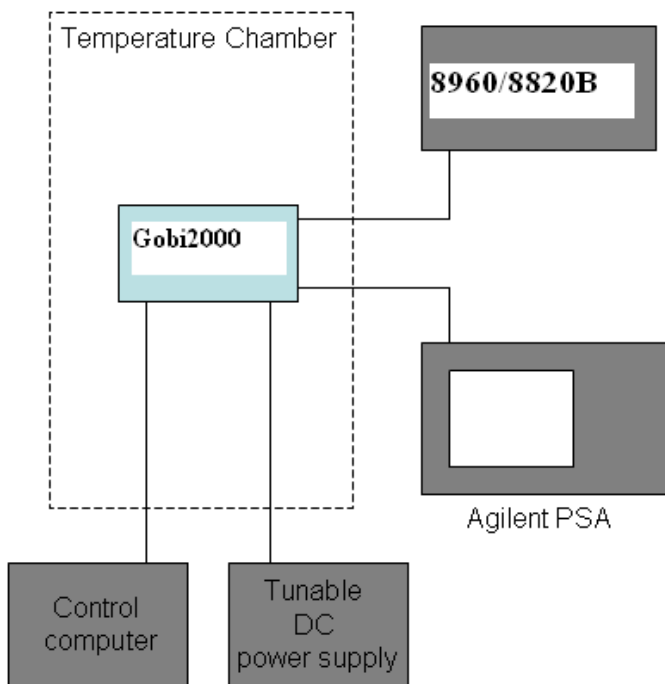

### 16. Test Results

The test was conducted at mid channel in each band.

<b>Operation Mode:</b>	GMSK	<b>Channel:</b>	190
<b>Tx Frequency:</b>	836.6MHz	<b>Voltage:</b>	3.3v (3.0v ~ 3.6v)
<b>Limit:</b>	±2.5ppm (±2091Hz)		

Temperature (°C)	Deviation of Carrier (Hz)			Specification (Hz)	
	3.0V	3.3V	3.6V	Lower limit	Upper limit
-30	-37.8	-27.7	-23.8	-2091	2091
-20	-56.7	24.7	19.8	-2091	2091
-10	-52.4	20.5	1.9	-2091	2091
0	-35.2	-28.6	-7.6	-2091	2091
10	-41.1	17.3	-1.0	-2091	2091
20	-45.7	-28.0	-25.5	-2091	2091
30	-5.9	5.2	-3.8	-2091	2091
40	-12	-13.3	-28.9	-2091	2091
50	-7.9	6.6	-5.8	-2091	2091
60	-38.2	14.9	13.2	-2091	2091

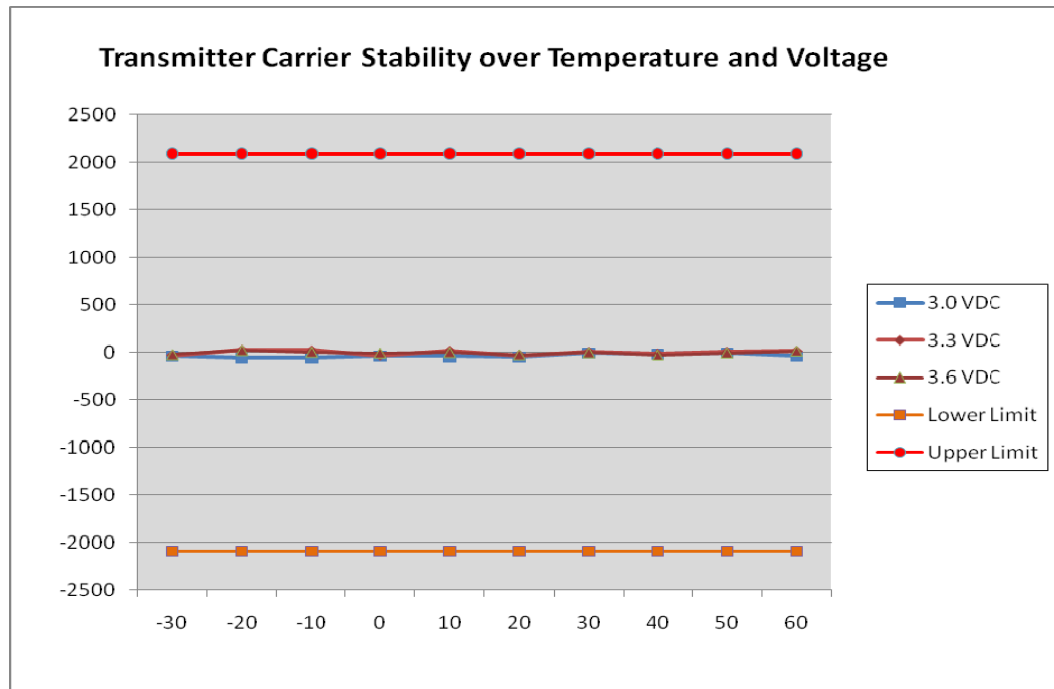

<b>Operation Mode:</b>	GMSK	<b>Channel:</b>	661
<b>Tx Frequency:</b>	1880MHz	<b>Voltage:</b>	3.3v (3.0v ~ 3.6v)
<b>Limit:</b>	±2.5ppm (±4700Hz)		

Temperature (°C)	Deviation of Carrier (Hz)			Specification (Hz)	
	3.0V	3.3V	3.6V	Lower limit	Upper limit
-30	12.7	-4.2	11.7	-4700	4700
-20	-7.5	4.7	8.4	-4700	4700
-10	6.5	-28.6	-14.3	-4700	4700
0	-17	-43.8	9.3	-4700	4700
10	23.7	21.8	-29	-4700	4700
20	-47.7	0.6	-2.9	-4700	4700
30	-44.2	11.0	17.6	-4700	4700
40	-57	11.3	1.4	-4700	4700
50	17.8	15.6	-44.4	-4700	4700
60	-21.1	5.0	-65.2	-4700	4700

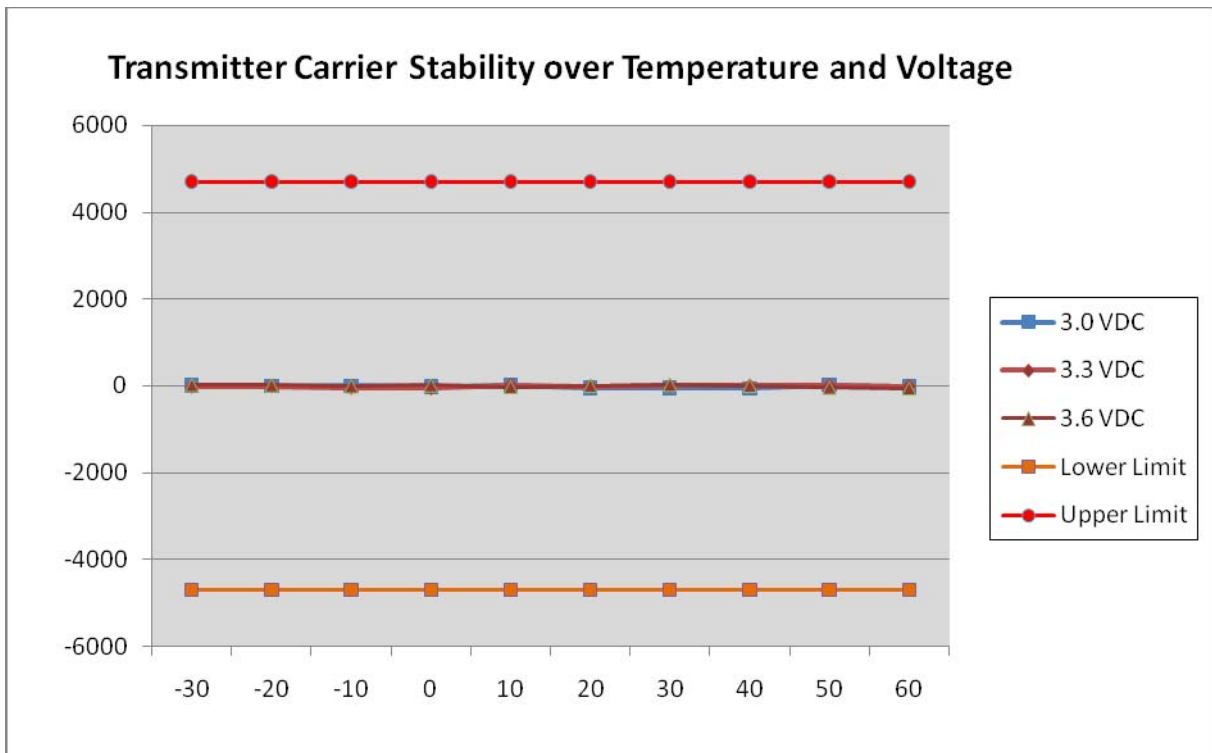

<b>Operation Mode:</b>	8PSK	<b>Channel:</b>	190
<b>Tx Frequency:</b>	836.6MHz	<b>Voltage:</b>	3.3v (3.0v ~ 3.6v)
<b>Limit:</b>	±2.5ppm (±2091Hz)		

Temperature (°C)	Deviation of Carrier (Hz)			Specification (Hz)	
	3.0V	3.3V	3.6V	Lower limit	Upper limit
-30	-89.3	-21.4	-25.9	-2091	2091
-20	-6.6	-1.6	24.0	-2091	2091
-10	-19.7	-18.7	33.9	-2091	2091
0	-15.0	-11.4	-44.4	-2091	2091
10	-23.7	-29.0	-40.6	-2091	2091
20	-25.4	-3.6	25.3	-2091	2091
30	-5.9	-4.5	-8.7	-2091	2091
40	-17.1	17.1	-14.6	-2091	2091
50	-36.6	-42.8	-33.3	-2091	2091
60	-22.9	21.4	1.7	-2091	2091

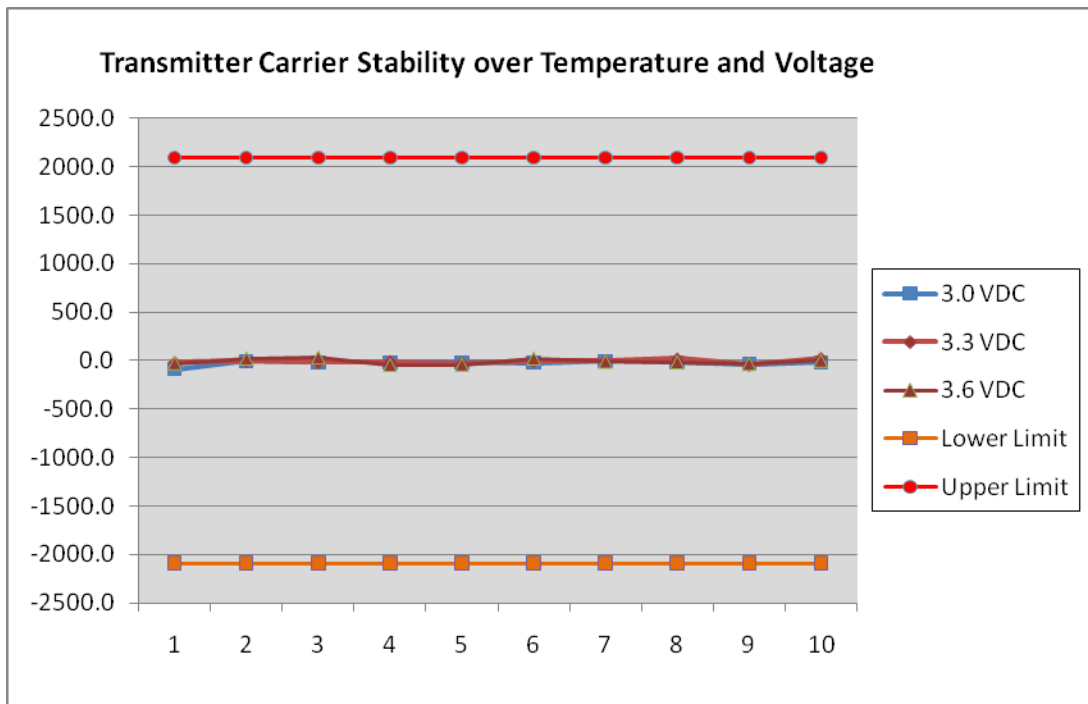



<b>Operation Mode:</b>	8PSK	<b>Channel:</b>	661
<b>Tx Frequency:</b>	1880MHz	<b>Voltage:</b>	3.3v (3.0v ~ 3.6v)
<b>Limit:</b>	±2.5ppm (±4700Hz)		

Temperature (°C)	Deviation of Carrier (Hz)			Specification (Hz)	
	3.0V	3.3V	3.6V	Lower limit	Upper limit
-30	-7.8	-11.7	5.3	-4700	4700
-20	37.2	6.4	30.8	-4700	4700
-10	24.9	8.7	20.4	-4700	4700
0	24.8	5.0	-26.9	-4700	4700
10	8.8	-36.6	29.3	-4700	4700
20	-9.2	1.9	3.7	-4700	4700
30	2.9	3.8	-64.1	-4700	4700
40	5.0	14.2	-41.6	-4700	4700
50	-32.1	-4.5	-17.5	-4700	4700
60	-19.2	19.4	6.5	-4700	4700

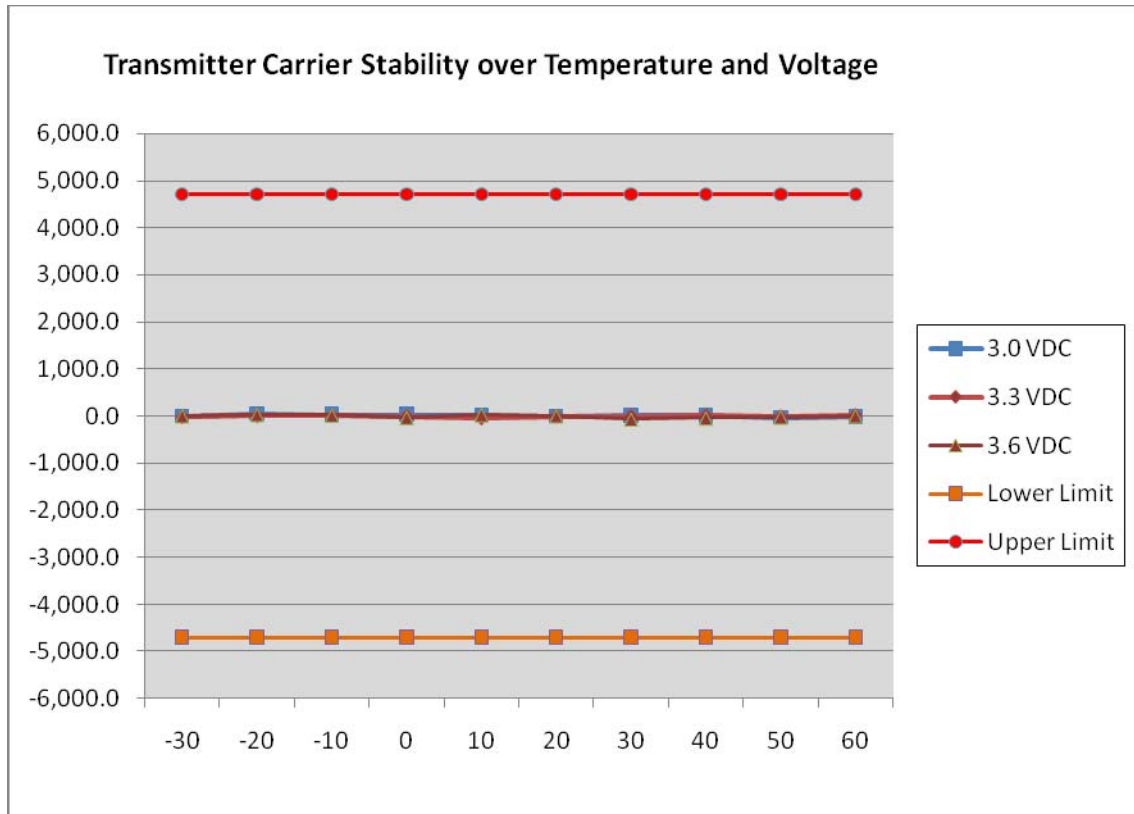

<b>Operation Mode:</b>	WCDMA Rel 99	<b>Channel:</b>	4182
<b>Tx Frequency:</b>	836.4MHz	<b>Voltage:</b>	3.3v (3.0v ~ 3.6v)
<b>Limit:</b>	±2.5ppm (±2091Hz)		

Temperature (°C)	Deviation of Carrier (Hz)			Specification (Hz)	
	3.0V	3.3V	3.6V	Lower limit	Upper limit
-30	-19.6	-4.2	-5.0	-2091	2091
-20	0.7	2.2	-6.8	-2091	2091
-10	-1.8	1.8	3.7	-2091	2091
0	0.1	-2.1	7.8	-2091	2091
10	-4.4	-6.0	-0.9	-2091	2091
20	-4.5	0.9	-3.7	-2091	2091
30	6.5	-0.3	3.5	-2091	2091
40	4.4	-2.4	2.1	-2091	2091
50	-5.7	3.2	-6.1	-2091	2091
60	11.7	-2.0	3.1	-2091	2091

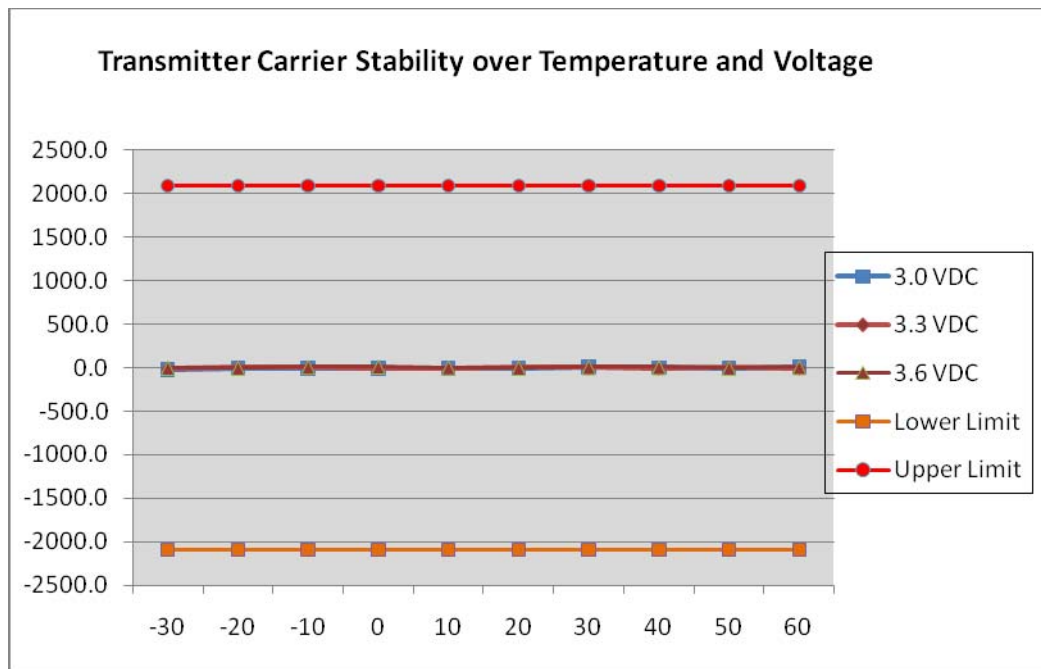

<b>Operation Mode:</b>	WCDMA Rel 99	<b>Channel:</b>	9400
<b>Tx Frequency:</b>	1880MHz	<b>Voltage:</b>	3.3v (3.0v ~ 3.6v)
<b>Limit:</b>	±2.5ppm (±4700Hz)		

Temperature (°C)	Deviation of Carrier (Hz)			Specification (Hz)	
	3.0V	3.3V	3.6V	Lower limit	Upper limit
-30	-15.3	-5.9	8.9	-4700	4700
-20	3.3	1.3	1.4	-4700	4700
-10	-0.8	-9.2	4.8	-4700	4700
0	-28.1	-0.3	9.0	-4700	4700
10	-6.6	-1.9	-0.5	-4700	4700
20	-34.2	13.3	-9.9	-4700	4700
30	15.6	-10.7	-17.8	-4700	4700
40	-10.3	-8.8	-3.2	-4700	4700
50	-2.5	-2.9	3.1	-4700	4700
60	-14.8	4.6	-14.1	-4700	4700

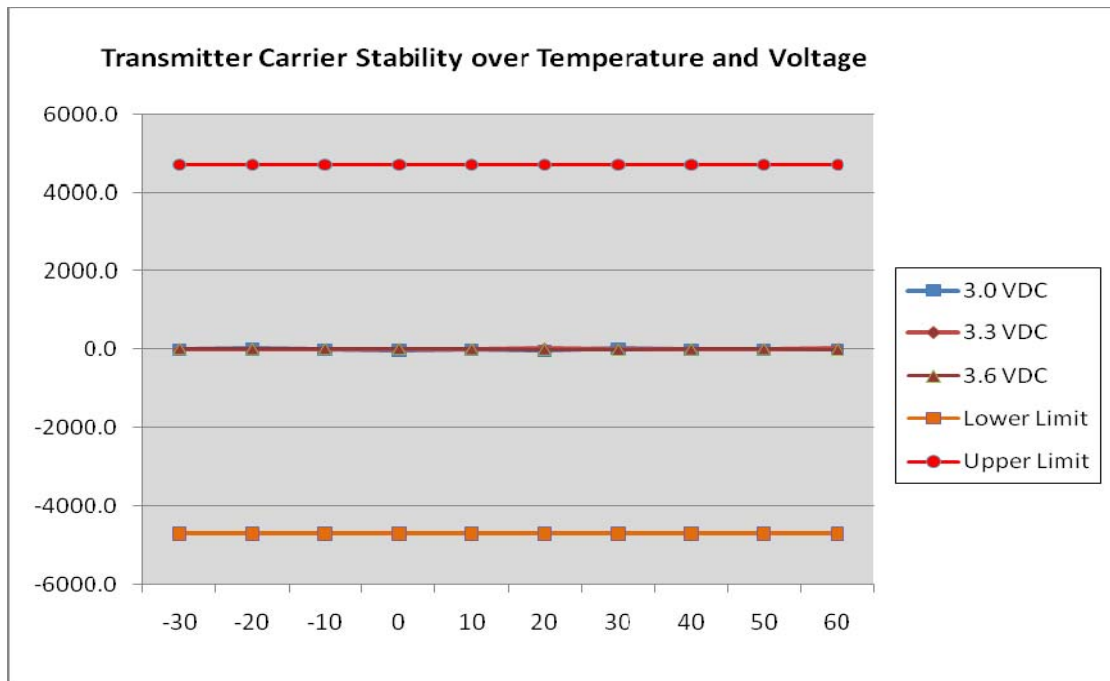

<b>Operation Mode:</b>	EVDO, Rel 0, RTAP rate = 153.6kbps	<b>Channel:</b>	384
<b>Tx Frequency:</b>	836.52MHz	<b>Voltage:</b>	3.3v (3.0v ~ 3.6v)
<b>Limit:</b>	±2.5ppm (±2091Hz)		

Temperature (°C)	Deviation of Carrier (Hz)			Specification (Hz)	
	3.0V	3.3V	3.6V	Lower limit	Upper limit
-30	4.2	-17.6	-25.4	-2091	2091
-20	-10.3	-1.4	-5.2	-2091	2091
-10	-3.2	-2	-0.9	-2091	2091
0	-22	6.6	1.4	-2091	2091
10	-53.4	12.8	0.8	-2091	2091
20	-2.7	-0.8	9.0	-2091	2091
30	-5.1	-1.1	-0.2	-2091	2091
40	1.4	-1.4	2.8	-2091	2091
50	3.2	1.8	4.9	-2091	2091
60	-10.7	-2.2	-4.9	-2091	2091

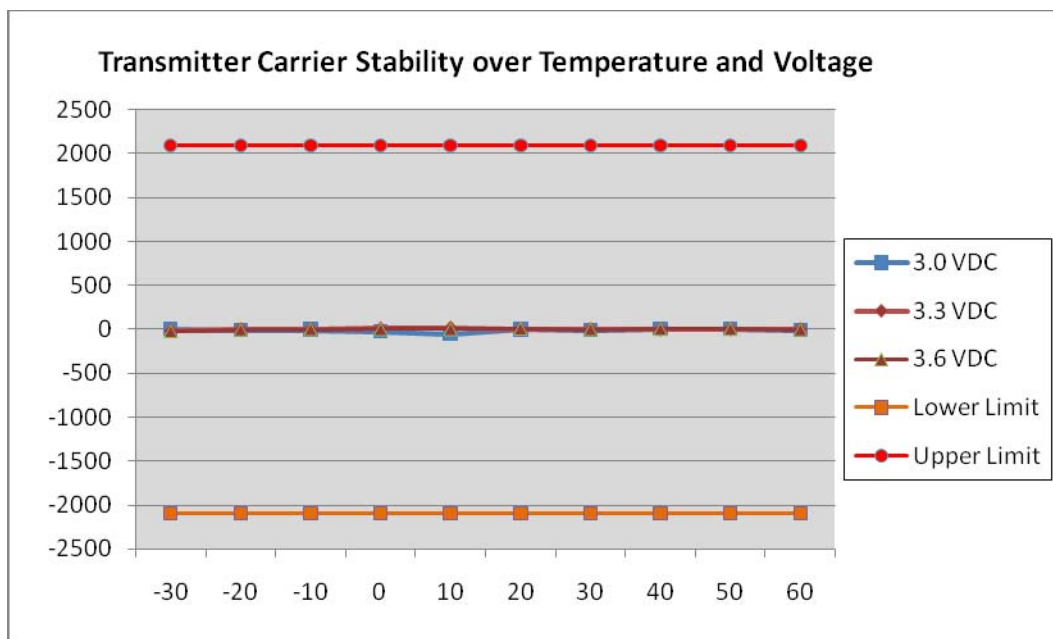

<b>Operation Mode:</b>	EVDO, Rel 0, RTAP rate = 153.6kbps	<b>Channel:</b>	600
<b>Tx Frequency:</b>	1880MHz	<b>Voltage:</b>	3.3v (3.0v ~ 3.6v)
<b>Limit:</b>	±2.5ppm (±4700Hz)		

Temperature (°C)	Deviation of Carrier (Hz)			Specification (Hz)	
	3.0V	3.3V	3.6V	Lower limit	Upper limit
-30	161.5	26.4	4.6	-4700	4700
-20	0.3	-5.0	12.3	-4700	4700
-10	123.2	31.2	4.9	-4700	4700
0	31.6	-19.6	-9.6	-4700	4700
10	10.3	-6.5	-17.1	-4700	4700
20	12.6	9.6	8.0	-4700	4700
30	-5.1	-4.4	-4.6	-4700	4700
40	3.3	5.0	10.3	-4700	4700
50	1.7	8.4	8.4	-4700	4700
60	-22.7	-1.8	-3.2	-4700	4700

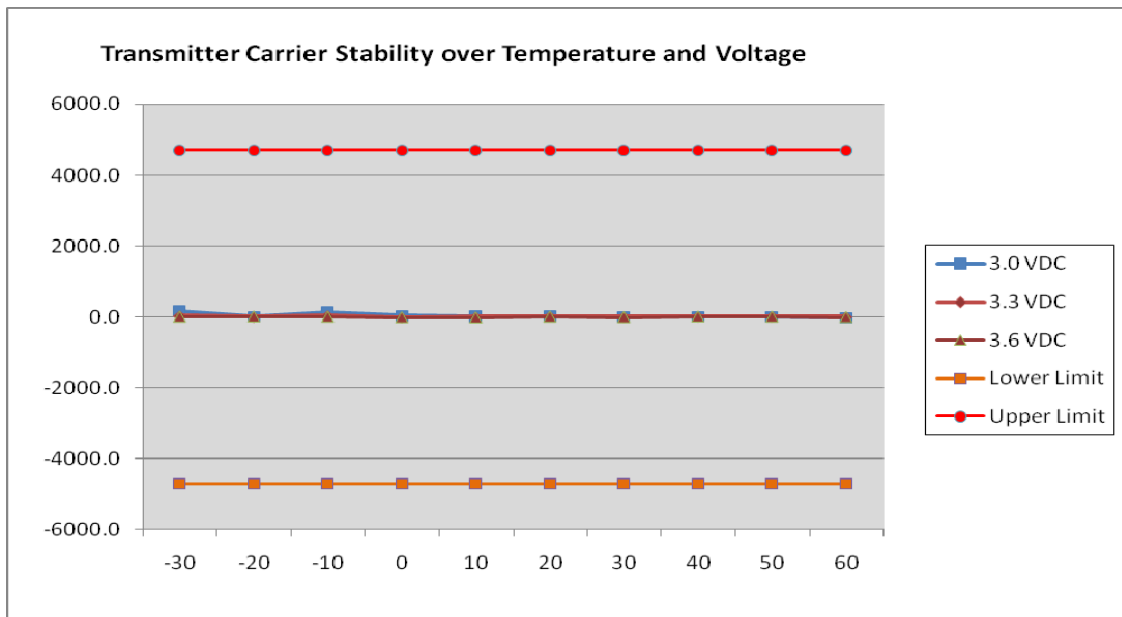

## **9. Test Equipment and Firmware**

The following test equipments were used.

<b>Model</b>	<b>Manufacturer</b>	<b>Description</b>	<b>S/N</b>	<b>Cal Date</b>	<b>Cal Due Date</b>
MT8820B	Anritsu	Radio communication Analyzer	K108664	2/12/2008	2/12/2009
8960 Series 10 E5515C	Agilent	Wireless Communication Set	K119302	9/15/2008	09/15/2009
E4440A PSA Series	Agilent	Spectrum Analyzer	K159342	9/15/2008	9/15/2009
Compaq 6910p	Hewlett Packard	Notebook Computer	P116464	N/R	N/R
Model 105	TestEquity	Temperature Chamber	K131567	05/22/2008	05/22/2009
50-VD628-1 Rev A/A	Qualcomm	Module Fixture	U2-069	N/R	N/R

The firmwares built in the 8960 and 8820B are as follows, and have been validated to support the testing for all technologies implemented in GOBI2000.

<b>Call Box</b>	<b>Technology</b>	<b>Firmware Rev</b>
8960	EVDO	A.07.21
	1x	B.12.21
8820B	UMTS	10.11 #001