

# TEST REPORT

FCC ID: KA2WR932WB1

Product: 4G LTE AX300 Wi-Fi 6 MOBILE HOTSPOT

Model No.: DWR-932W, DWR-932W/X, DWR-932W/XX, DWR-932W/XXX (X CAN BE 0-9, A-Z)

Trade Mark: D-Link

Report No.: WSCT-ANAB-R&E250400022A-RF

Issued Date: 06 May 2025

Issued for:

D-Link Corporation

14420 Myford Road Suite 100, Irvine, California 92606, United States

Issued By:

World Standardization Certification & Testing Group (Shenzhen) Co., Ltd.  
Building A-B, Baoli'an Industrial Park, No. 58 Tangtou Avenue, Shiyuan Street,  
Bao'an District, Shenzhen, Guangdong, China

TEL: +86-755-26996192

FAX: +86-755-86376605



**Note:** This report shall not be reproduced except in full, without the written approval of World Standardization Certification & Testing Group (Shenzhen) Co., Ltd. This document may be altered or revised by World Standardization Certification & Testing Group (Shenzhen) Co., Ltd. personnel only, and shall be noted in the revision section of the document. The test results in the report only apply to the tested sample.



## TABLE OF CONTENTS

<b>1. GENERAL INFORMATION</b> .....	<b>3</b>
<b>2. GENERAL DESCRIPTION OF EUT</b> .....	<b>4</b>
<b>3. FACILITIES AND ACCREDITATIONS</b> .....	<b>6</b>
3.1. FACILITIES .....	6
3.2. ACCREDITATIONS .....	6
3.3. EUT SYSTEM CONFIGURATION .....	7
3.4. DESCRIPTION OF TEST CHANNELS AND TEST MODES .....	8
3.5. EQUIPMENT MODIFICATIONS .....	11
<b>4. SUMMARY OF TEST REQUIREMENTS AND RESULTS</b> .....	<b>12</b>
<b>5. MEASUREMENT INSTRUMENTS</b> .....	<b>13</b>
<b>6. Transmitter Radiated Power (EIRP/ERP)</b> .....	<b>14</b>
<b>7. Peak to Average Ratio</b> .....	<b>19</b>
7.2. TEST RESULT .....	21
<b>8. SPURIOUS EMISSION (Conducted and Radiated)</b> .....	<b>31</b>
8.1. MEASUREMENT RESULT (PRE-MEASUREMENT).....	31
<b>9. OCCUPIED BANDWIDTH&amp; EMISSION BANDWIDTH</b> .....	<b>59</b>
9.1. MEASUREMENT RESULT .....	61
<b>10. BAND EDGE</b> .....	<b>67</b>
10.1. MEASUREMENT RESULT .....	68
<b>11. SPURIOUS EMISSION (Conducted and Radiated)</b> .....	<b>71</b>
11.1. MEASUREMENT RESULT (PRE-MEASUREMENT).....	71
<b>12. FREQUENCY STABILITY</b> .....	<b>83</b>
12.1. MEASUREMENT RESULT (WORST).....	84
<b>13. Test Setup Photographs</b> .....	<b>86</b>

Report No.: WSCT-ANAB-R&E250400022A-RF

### 1. GENERAL INFORMATION

**Product:** 4G LTE AX300 Wi-Fi 6 MOBILE HOTSPOT

**Model No.:** DWR-932W, DWR-932W/X, DWR-932W/XX, DWR-932W/XXX (X CAN BE 0-9, A-Z)

**Additional Model:** D-Link

**Applicant:** **D-Link Corporation**  
14420 Myford Road Suite 100, Irvine, California 92606, United States

**Manufacturer:** **D-LINK CORPORATION**  
14420 Myford Road Suite 100, Irvine, California 92606, United States

**Date of receipt:** 04 March 2025

**Date of Test:** 05 March 2025 to 10 April 2025

**Applicable Standards:** FCC CFR Title 47 Part 2, 22, 24 ,27, 90  
ANSI C63.26-2015

The above equipment has been tested by World Standardization Certification & Testing Group (Shenzhen) Co., Ltd. And found compliance with the requirements set forth in the technical standards mentioned above. The results of testing in this report apply only to the product system, which was tested. Other similar equipment will not necessarily produce the same results due to production tolerance and measurement uncertainties.

**Tested By:** Wang Xiang  
( Wang Xiang)

**Checked By:** Qin Shuiquan  
( Qin Shuiquan)

**Approved By:** Li Huaibi  
(Li Huaibi)

**Date:** 06 May 2025



Report No.: WSCT-ANAB-R&amp;E250400022A-RF

## 2. GENERAL DESCRIPTION OF EUT

<b>Equipment Type:</b>	4G LTE AX300 Wi-Fi 6 MOBILE HOTSPOT
<b>Model</b>	DWR-932W, DWR-932W/X, DWR-932W/XX, DWR-932W/XXX (X CAN BE 0-9, A-Z)
<b>Trade Mark</b>	D-Link
<b>Operating Bands</b>	WCDMA/HSDPA/HSUPA Band 2/4/5 FDD LTE Band 2/4/5/7/12 TDD LTE Band 41
<b>Antenna Type:</b>	FPC Antenna
<b>Antenna gain:</b>	WCDMA B5/LTE B5: -0.61dbi WCDMA B2/LTE B2: 2.59dbi WCDMA B4/LTE B4: 1.62dbi LTE B7/ LTE B41: 3.88dbi LTE B12: -1.06dbi
<b>Radiated Power (EIRP/ERP) Limit</b>	WCDMA B5/LTE B5: 7.00W(38.45dBm) WCDMA B2/LTE B2:2.00W(33.01dBm) WCDMA B4/LTE B4: 1.00W(30.00dBm) LTE B7/ LTE B41: 2.00W(33.01dBm) LTE B12/B17: 3.00W(34.77dBm)
<b>Operation Frequency Range:</b>	WCDMA Band2: 1850-1910MHz (TX), 1930-1990MHz (RX); WCDMA Band4: 1710-1755MHz (TX), 2110-2155MHz (RX); WCDMA Band5: 824-849MHz (TX), 869-894MHz (RX); LTE Band2: 1850-1910MHz (TX), 1930-1990MHz (RX); LTE Band4: 1710-1755MHz (TX), 2110-2155MHz (RX); LTE Band5: 824-849MHz (TX), 869-894MHz (RX); LTE Band7: 2500-2570MHz (TX), 2620-2690MHz (RX); LTE Band12: 699-716MHz (TX), 729-746MHz (RX); LTE Band41: 2535-2655 MHz(TX), 2535-2655 MHz(RX);
<b>Modulation Type</b>	WCDMA: QPSK HSDPA/HSUPA: QPSK /16QAM LTE: QPSK/16QAM
<b>Operating Voltage</b>	Rechargeable Li-ion Polymer Battery: 675465ART Rated Voltage: 3.7V Limited charge voltage:4.2V Rated Capacity: 3000mAh/11.1Wh
<b>Max power:</b>	See Table 2.1
<b>Remark:</b>	N/A.

- Note:
1. The antenna gain provided by the applicant, and the laboratory will not be responsible for the accumulated calculation results which covers the information provided by the applicant.
  2. N/A stands for no applicable.
  3. Antenna gain provided by the customer.

Report No.: WSCT-ANAB-R&E250400022A-RF

**Table 2.1 Maximum power in the operating frequency band.**

Operation Band (s)	Power Class	Modulation Type	Maximum conducted output power (dBm)	ERP/EIRP (dBm)
WCDMA Band 2	Class 3	QPSK	23.23	25.82
WCDMA Band 4	Class 3	QPSK	24.08	25.7
WCDMA Band 5	Class 3	QPSK	23.33	20.57
E-UTRA Band 2	Class 3	QPSK	23.62	26.21
E-UTRA Band 2	Class 3	16QAM	23.60	26.19
E-UTRA Band 4	Class 3	QPSK	23.94	25.56
E-UTRA Band 4	Class 3	16QAM	23.75	25.37
E-UTRA Band 5	Class 3	QPSK	24.00	21.24
E-UTRA Band 5	Class 3	16QAM	24.10	21.34
E-UTRA Band 7	Class 3	QPSK	23.17	26.13
E-UTRA Band 7	Class 3	16QAM	22.57	25.53
E-UTRA Band 12	Class 3	QPSK	23.84	20.63
E-UTRA Band 12	Class 3	16QAM	23.84	20.63
E-UTRA Band 41 (2535-2655 MHz)	Class 3	QPSK	22.87	26.75
E-UTRA Band 41 (2535-2655 MHz)	Class 3	16QAM	22.29	26.17



Report No.: WSCT-ANAB-R&amp;E250400022A-RF

### 3. FACILITIES AND ACCREDITATIONS

#### 3.1. Facilities

All measurement facilities used to collect the measurement data are located at **Building A-B, Baoli'an Industrial Park, No. 58 Tangtou Avenue, Shiyan Street, Bao'an District, Shenzhen, Guangdong, China of the World Standardization Certification & Testing Group (Shenzhen) Co., Ltd.**

The sites are constructed in conformance with the requirements of ANSI C63.4 and CISPR Publication 22. All receiving equipment conforms to CISPR Publication 16-1, "Radio Interference Measuring Apparatus and Measurement Methods."

#### 3.2. ACCREDITATIONS

**ANAB - Certificate Number: AT-3951**

The EMC Laboratory has been accredited by the American Association for Laboratory Accreditation (ANAB). Certification Number: AT-3951



Report No.: WSCT-ANAB-R&E250400022A-RF

### 3.3. EUT System Configuration

The EUT configuration for testing is installed on RF field strength measurement to meet the Commission’s requirement and operating in a manner which intends to maximize its emission characteristics in a continuous normal application.

**Fig. 3.2-1 Configuration of EUT System**

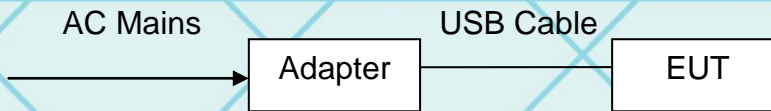

(EUT: 4G LTE AX300 Wi-Fi 6 MOBILE HOTSPOT)

**Table 3.2-1 Equipment Used in EUT System**

Item	Equipment	Model No.	ID or Specification	Note
1	Adapter	-	-	Accessories

\*\*\*Note: All the accessories have been used during the test. The following “EUT” in setup diagram means EUT system.

Report No.: WSCT-ANAB-R&E250400022A-RF

### 3.4. Description Of Test Channels And Test Modes

#### Test channels:

Test Mode	UL Channel	UL Channel No.	UL Frequency (MHz)
WCDMA Band 2	Low Channel	9262	1850.1
	Middle Channel	9400	1879.1
	High Channel	9538	1905.1
WCDMA Band 4	Low Channel	1312	1710.0
	Middle Channel	1412	1731.7
	High Channel	1513	1750.2
WCDMA Band 5	Low Channel	4132	825.5
	Middle Channel	4182	835.5
	High Channel	4233	845.7

LTE Band2			
Test Channel	BW(MHz)	UL Channel	Frequency(MHz)
Low Range	1.4	18607	1850.7
	3	18615	1851.5
	5	18625	1852.5
	10	18650	1855
	15	18675	1857.5
	20	18700	1860
Mid Range	1.4/3/5/10/15/20	18900	1880
High Range	1.4	19193	1909.3
	3	19185	1908.5
	5	19175	1907.5
	10	19150	1905
	15	19125	1902.5
	20	19100	1900



Report No.: WSCT-ANAB-R&amp;E250400022A-RF

LTE Band4			
Test Channel	BW(MHz)	UL Channel	Frequency(MHz)
Low Range	1.4	19957	1710.7
	3	19965	1711.5
	5	19975	1712.5
	10	20000	1715
	15	20025	1717.5
	20	20050	1720
Mid Range	1.4/3/5/10/15/20	20175	1732.5
High Range	1.4	20393	1754.3
	3	20385	1753.5
	5	20375	1752.5
	10	20350	1750
	15	20325	1747.5
	20	20300	1745

LTE Band 5			
Test Channel	BW(MHz)	UL Channel	Frequency(MHz)
Low Range	1.4	20407	824.7
	3	20415	825.5
	5	20425	826.5
	10	20450	829
Mid Range	1.4/3/5/10	20525	836.5
High Range	1.4	20643	848.3
	3	20635	847.5
	5	20625	846.5
	10	20600	844



Report No.: WSCT-ANAB-R&amp;E250400022A-RF

LTE Band 7			
Test Channel	BW(MHz)	UL Channel	Frequency(MHz)
Low Range	5	20775	2502.5
	10	20800	2505
	15	20825	2507.5
	20	20850	2510
Mid Range	5/10/15/20	21100	2535
High Range	5	21425	2567.5
	10	21400	2565
	15	21375	2562.5
	20	21350	2560

LTE Band 12			
Test Channel	BW(MHz)	UL Channel	Frequency(MHz)
Low Range	1.4	23017	699.7
	3	23025	700.5
	5	23035	701.5
	10	23060	704
Mid Range	1.4/3/5/10	23095	707.5
High Range	1.4	23173	715.3
	3	23165	714.5
	5	23155	713.5
	10	23130	711.5

LTE Band 41			
Test Channel	BW(MHz)	UL Channel	Frequency(MHz)
Low Range	5	39675	2498.5
	10	39700	2501
	15	39725	2503.5
	20	39750	2506
Mid Range	5/10/15/20	40620	2593
High Range	5	41565	2687.5
	10	41540	2685
	15	41515	2682.5
	20	41490	2680

Note 1: BPSK&QPSK&16QAM&QAM64&QAM256 modulation has been measured;  
 Note 2: The worst condition was recorded in the test report if no other modes test data.



Report No.: WSCT-ANAB-R&E250400022A-RF

### 3.5. Equipment Modifications

Not available for this EUT intended for grant.



Report No.: WSCT-ANAB-R&E250400022A-RF

#### 4. SUMMARY OF TEST REQUIREMENTS AND RESULTS

No.	Description	FCC Part No.	Test Verdict	Remark
1	Conducted RF Output Power	2.1046	Pass	--
2	Effective (Isotropic) Radiated Power	2.1046 22.913(a) 24.232(c) 27.50 90.635(b) 90.542(a) §90.1321(a)	Pass	--
3	Peak to Average Ratio	2.1046 22.913(d) 24.232(d) 27.50(d)	Pass	--
4	Occupied Bandwidth	2.1049 22.917(b) 24.238(b) 27.53 90.209	Pass	--
5	Frequency Stability	2.1055 22.355 24.235 27.54 90.213	Pass	--
6	Spurious Emission at Antenna Terminals	2.1051 22.917 24.238 27.53 90.691 90.543	Pass	--
7	Band Edge	2.1051 22.917 24.238 27.53 90.691 90.543	Pass	--
8	Field Strength of Spurious Radiation	2.1053 22.917 24.238 27.53 90.691 90.543	Pass	--



Report No.: WSCT-ANAB-R&amp;E250400022A-RF

## 5. MEASUREMENT INSTRUMENTS

NAME OF EQUIPMENT	MANUFACTURER	MODEL	SERIAL NUMBER	Calibration Date	Calibration Due.
EMI Test Receiver	R&S	ESCI	100005	11/05/2024	11/04/2025
LISN	AFJ	LS16	16010222119	11/05/2024	11/04/2025
LISN(EUT)	Mestec	AN3016	04/10040	11/05/2024	11/04/2025
Universal Radio Communication Tester	R&S	CMU 200	1100.0008.02	11/05/2024	11/04/2025
Coaxial cable	Megalon	LMR400	N/A	11/05/2024	11/04/2025
GPIB cable	Megalon	GPIB	N/A	11/05/2024	11/04/2025
Spectrum Analyzer	R&S	FSU	100114	11/05/2024	11/04/2025
Pre Amplifier	H.P.	HP8447E	2945A02715	11/05/2024	11/04/2025
Pre-Amplifier	CDSI	PAP-1G18-38	--	11/05/2024	11/04/2025
Loop Antenna	R&S	HFH2-Z2	100296	11/05/2024	11/04/2025
Bi-log Antenna	SCHWARZBECK	VULB9168	01488	7/29/2024	7/28/2025
9*6*6 Anechoic	--	--	--	11/05/2024	11/04/2025
Horn Antenna	COMPLIANCE ENGINEERING	CE18000	--	11/05/2024	11/04/2025
Horn Antenna	SCHWARZBECK	BBHA9120D	9120D-631	11/05/2024	11/04/2025
Power meter	Anritsu	ML2487A	6K00003613	11/05/2024	11/04/2025
Power meter	Anritsu	MA2491A	32263	11/05/2024	11/04/2025
Cable	TIME MICROWAVE	LMR-400	N-TYPE04	11/05/2024	11/04/2025
System-Controller	CCS	N/A	N/A	N.C.R	N.C.R
Turn Table	CCS	N/A	N/A	N.C.R	N.C.R
Antenna Tower	CCS	N/A	N/A	N.C.R	N.C.R
RF cable	Murata	MXHQ87WA3000	-	11/05/2024	11/04/2025
Loop Antenna	EMCO	6502	00042960	11/05/2024	11/04/2025
Wideband Radio Communication Tester	R&S	CMW 500	103974	11/05/2024	11/04/2025
Horn Antenna	SCHWARZBECK	BBHA 9170	1123	11/05/2024	11/04/2025
H & T Chamber	Guangzhou gongwen	GDJS-500-40	0329	11/05/2024	11/04/2025
UXM 5G Wireless Test Platform	KEYSIGHT	E7515B	MY60192341	11/05/2024	11/04/2025
Anechoic chamber	SAEMC	966	-	11/05/2024	11/04/2025
Spectrum Analyzer	KEYSIGHT	N9010B	MY60241089	11/05/2024	11/04/2025

Report No.: WSCT-ANAB-R&amp;E250400022A-RF

## 6. Transmitter Radiated Power (EIRP/ERP)

### Test limit:

FCC § 2.1046 & 22.913(a) & 24.232(c) & 27.50(a) & 27.50(b) & 27.50(c) & 27.50(d) & 27.50(h) & 27.50(j) & 27.50(k) & 90.635(b) & 90.542(a)

According to FCC section 22.913(a) (5), the Effective Radiated Power (ERP) of mobile transmitters and auxiliary test transmitters must not exceed 7 watts.

According to FCC section 24.232(c), mobile and portable stations are limited to 2 watts EIRP and the equipment must employ a means for limiting power to the minimum necessary for successful communications.

According to FCC section 27.50(a) (3), for mobile and portable stations transmitting in the 2305-2315MHz band or the 2350-2360MHz band, the average EIRP must not exceed 50 mill watts within any 1 megahertz of authorized bandwidth, except that for mobile and portable stations compliant with 3GPP LTE standards. For mobile and portable stations using time division depleting (TDD) technology, the duty cycle must not exceed 38 percent in the 2305-2315 MHz and 2350-2360 MHz bands.

FCC section 27.50(b) (10), portable stations (hand-held devices) transmitting in the 746-757MHz, 776-788MHz, and 805-806MHz bands are limited to 3 watts ERP.

FCC section 27.50(c) (10), portable stations (hand-held devices) in the 600MHz uplink band and the 698-746MHz band, and fixed and mobile stations in the 600MHz uplink band are limited to 3 watts ERP.

FCC section 27.50(d) (4), fixed, mobile, and portable (hand-held) stations operating in the 1710-1755 MHz band and mobile and portable stations operating in the 1695-1710 MHz and 1755-1780 MHz bands are limited to 1 watt EIRP. Fixed stations operating in the 1710-1755 MHz band are limited to a maximum antenna height of 10 meters above ground. Mobile and portable stations operating in these bands must employ a means for limiting power to the minimum necessary for successful communications.

(7) Fixed, mobile, and portable (hand-held) stations operating in the 2000-2020 MHz band are limited to 2 watts EIRP.

And FCC section 27.50(h) (2), for mobile and other user stations, mobile stations are limited to 2.0 watts EIRP. All user stations are limited to 2.0 watts transmitter output power.

FCC section 27.50(j) (3), for mobile, and portable (hand-held) stations operating in the 3700-3980 MHz band are limited to 1 watt EIRP.

FCC section 27.50(k) (3), Mobile devices are limited to 1Watt (30 dBm) EIRP in the 3450-3550 MHz band.

### Test procedure:

#### Description of the Conducted Output Power Measurement

The EUT is coupled to the SS with attenuator through power splitter; the RF load attached to EUT antenna terminal is 50Ohm; the path loss as the factor is calibrated to correct the reading. A system simulator is used to establish communication with the EUT, and its parameters are set to force the EUT transmitting at maximum output power. The measured power in the radio frequency on the transmitter output terminals shall be reported.

The relevant equation for determining the conducted measured value is:

Conducted Output Power Value (dBm) = Measured Value (dBm) + Path Loss (dB)

where:

Conducted Output Power Value = final conducted measured value in the conducted power test, in dBm;  
Measured Value = measured conducted power received by spectrum analyzer or power meter, in dBm;  
Path Loss = signal attenuation in the connecting cable between the transmitter and spectrum analyzer or power meter, including external cable loss, in dB;

During the test, the data of Path Loss (dB) is added in the spectrum analyzer or power meter, so Measured Value (dBm) is the final values which contains the data of Path Loss (dB).

Report No.: WSCT-ANAB-R&amp;E250400022A-RF

**Description of the Transmitter Radiated Power Measurement**

In many cases, the RF output power limits for licensed digital transmission devices is specified in terms of effective radiated power (ERP) or equivalent isotropic radiated power (EIRP). Typically, ERP is specified when the operating frequency is less than or equal to 1 GHz and EIRP is specified when the operating frequency is greater than 1 GHz. Both are determined by adding the transmit antenna gain to the conducted RF output power with the primary difference between the two being that when determining the ERP, the transmit antenna gain is referenced to a dipole antenna (i.e., dBd) whereas when determining the EIRP, the transmit antenna gain is referenced to an isotropic antenna (dBi).

**Final measurement calculation as below**

The relevant equation for determining the ERP or EIRP from the conducted RF output power measured using the guidance provided above is:

$$\text{ERP/EIRP} = P_{\text{Meas}} + \text{GT} - \text{LC}$$

where:

ERP/EIRP = effective or equivalent radiated power, respectively (expressed in the same units as  $P_{\text{Meas}}$ , typically dBW or dBm);

$P_{\text{Meas}}$  = measured transmitter output power or PSD, in dBm or dBW;

GT = gain of the transmitting antenna, in dBd (ERP) or dBi (EIRP);

dBd (ERP) = dBi (EIRP) - 2.15 dB

LC = signal attenuation in the connecting cable between the transmitter and antenna, in dB.

For devices utilizing multiple antennas, KDB 662911 provides guidance for determining the effective array transmit antenna gain term to be used in the above equation.

The relevant equation for determining the ERP/EIRP from the radiated RF output power is:

$$\text{ERP/EIRP (dBm)} = \text{SA Read Value (dBm)} + \text{Correction Factor (dB)}$$

where:

ERP/EIRP = effective or equivalent radiated power, in dBm;

SA Read Value = measured transmitter power received by EMI receiver or spectrum analyzer, in dBm;

Correction Factor = total correction factor including cable loss, in dB;

During the test, the data of Correction Factor (dB) is added in the EMI receiver or spectrum analyzer, so SA Read Value (dBm) is the final values which contains the data of Correction Factor (dB).

Report No.: WSCT-ANAB-R&E250400022A-RF

**Test Result**

WCDMA Mode Test Data:

Band	Mode	Frequency (MHz)	Conducted Output AV Power (dBm)	Antenna Gain (dBi)	EIRP (dBm)	Limit (dBm)	Verdict	
Band 2	RMC 12.2K	1850.1	21.42	2.59	24.01	33.01	Pass	
		1879.1	22.97	2.59	25.56	33.01	Pass	
		1905.1	22.32	2.59	24.91	33.01	Pass	
	HSDPA	1 Tx Slots	1850.1	21.76	2.59	24.35	33.01	Pass
			1879.1	21.97	2.59	24.56	33.01	Pass
			1905.1	22.10	2.59	24.69	33.01	Pass
		2 Tx Slots	1850.1	23.04	2.59	25.63	33.01	Pass
			1879.1	22.65	2.59	25.24	33.01	Pass
			1905.1	20.86	2.59	23.45	33.01	Pass
		3 Tx Slots	1850.1	22.01	2.59	24.6	33.01	Pass
			1879.1	21.77	2.59	24.36	33.01	Pass
			1905.1	21.79	2.59	24.38	33.01	Pass
		4 Tx Slots	1850.1	21.86	2.59	24.45	33.01	Pass
			1879.1	21.07	2.59	23.66	33.01	Pass
			1905.1	21.26	2.59	23.85	33.01	Pass
	HSUPA	1 Tx Slots	1850.1	20.96	2.59	23.55	33.01	Pass
			1879.1	<b>23.23</b>	2.59	<b>25.82</b>	33.01	Pass
			1905.1	22.07	2.59	24.66	33.01	Pass
		2 Tx Slots	1850.1	22.31	2.59	24.9	33.01	Pass
			1879.1	22.13	2.59	24.72	33.01	Pass
			1905.1	22.73	2.59	25.32	33.01	Pass
		3 Tx Slots	1850.1	22.31	2.59	24.9	33.01	Pass
			1879.1	22.50	2.59	25.09	33.01	Pass
			1905.1	22.16	2.59	24.75	33.01	Pass
		4 Tx Slots	1850.1	20.75	2.59	23.34	33.01	Pass
			1879.1	22.28	2.59	24.87	33.01	Pass
			1905.1	21.61	2.59	24.2	33.01	Pass
5 Tx Slots	1850.1	21.41	2.59	24	33.01	Pass		
	1879.1	22.02	2.59	24.61	33.01	Pass		
	1905.1	22.30	2.59	24.89	33.01	Pass		



Report No.: WSCT-ANAB-R&E250400022A-RF

Band	Mode	Frequency (MHz)	Conducted Output AV Power (dBm)	Antenna Gain (dBi)	EIRP (dBm)	Limit (dBm)	Verdict	
Band 4	RMC 12.2K	1710.0	22.52	1.62	24.14	30.00	Pass	
		1731.7	23.04	1.62	24.66	30.00	Pass	
		1750.2	23.52	1.62	25.14	30.00	Pass	
	HSDPA	1 Tx Slots	1710.0	23.72	1.62	25.34	30.00	Pass
			1731.7	23.79	1.62	25.41	30.00	Pass
			1750.2	<b>24.08</b>	1.62	<b>25.7</b>	30.00	Pass
		2 Tx Slots	1710.0	22.74	1.62	24.36	30.00	Pass
			1731.7	23.18	1.62	24.8	30.00	Pass
			1750.2	23.15	1.62	24.77	30.00	Pass
		3 Tx Slots	1710.0	24.00	1.62	25.62	30.00	Pass
			1731.7	22.38	1.62	24	30.00	Pass
			1750.2	23.77	1.62	25.39	30.00	Pass
	4 Tx Slots	1710.0	23.29	1.62	24.91	30.00	Pass	
		1731.7	22.41	1.62	24.03	30.00	Pass	
		1750.2	23.63	1.62	25.25	30.00	Pass	
	HSUPA	1 Tx Slots	1710.0	23.37	1.62	24.99	30.00	Pass
			1731.7	22.80	1.62	24.42	30.00	Pass
			1750.2	22.36	1.62	23.98	30.00	Pass
		2 Tx Slots	1710.0	22.84	1.62	24.46	30.00	Pass
			1731.7	22.97	1.62	24.59	30.00	Pass
			1750.2	22.37	1.62	23.99	30.00	Pass
		3 Tx Slots	1710.0	23.51	1.62	25.13	30.00	Pass
			1731.7	23.04	1.62	24.66	30.00	Pass
			1750.2	21.96	1.62	23.58	30.00	Pass
		4 Tx Slots	1710.0	22.82	1.62	24.44	30.00	Pass
			1731.7	21.77	1.62	23.39	30.00	Pass
			1750.2	22.79	1.62	24.41	30.00	Pass
		5 Tx Slots	1710.0	22.62	1.62	24.24	30.00	Pass
			1731.7	23.35	1.62	24.97	30.00	Pass
			1750.2	22.10	1.62	23.72	30.00	Pass



Report No.: WSCT-ANAB-R&E250400022A-RF

Band	Mode	Frequency (MHz)	Conducted Output AV Power (dBm)	Antenna Gain (dBi)	Antenna Gain (dBd)	ERP (dBm)	Limit (dBm)	Verdict	
Band 5	RMC 12.2K	825.5	22.51	-0.61	-2.76	19.75	38.45	Pass	
		835.5	<b>23.33</b>	-0.61	-2.76	<b>20.57</b>	38.45	Pass	
		845.7	22.75	-0.61	-2.76	19.99	38.45	Pass	
	HSDPA	1 Tx Slots	825.5	22.47	-0.61	-2.76	19.71	38.45	Pass
			835.5	21.97	-0.61	-2.76	19.21	38.45	Pass
			845.7	22.23	-0.61	-2.76	19.47	38.45	Pass
		2 Tx Slots	825.5	22.14	-0.61	-2.76	19.38	38.45	Pass
			835.5	22.57	-0.61	-2.76	19.81	38.45	Pass
			845.7	22.20	-0.61	-2.76	19.44	38.45	Pass
		3 Tx Slots	825.5	22.16	-0.61	-2.76	19.4	38.45	Pass
			835.5	22.52	-0.61	-2.76	19.76	38.45	Pass
			845.7	21.67	-0.61	-2.76	18.91	38.45	Pass
		4 Tx Slots	825.5	22.33	-0.61	-2.76	19.57	38.45	Pass
			835.5	21.80	-0.61	-2.76	19.04	38.45	Pass
			845.7	23.01	-0.61	-2.76	20.25	38.45	Pass
	HSUPA	1 Tx Slots	825.5	22.06	-0.61	-2.76	19.3	38.45	Pass
			835.5	22.18	-0.61	-2.76	19.42	38.45	Pass
			845.7	22.13	-0.61	-2.76	19.37	38.45	Pass
		2 Tx Slots	825.5	21.98	-0.61	-2.76	19.22	38.45	Pass
			835.5	22.82	-0.61	-2.76	20.06	38.45	Pass
			845.7	22.34	-0.61	-2.76	19.58	38.45	Pass
		3 Tx Slots	825.5	22.24	-0.61	-2.76	19.48	38.45	Pass
			835.5	21.40	-0.61	-2.76	18.64	38.45	Pass
			845.7	22.09	-0.61	-2.76	19.33	38.45	Pass
		4 Tx Slots	825.5	23.02	-0.61	-2.76	20.26	38.45	Pass
			835.5	21.54	-0.61	-2.76	18.78	38.45	Pass
			845.7	22.78	-0.61	-2.76	20.02	38.45	Pass
		5 Tx Slots	825.5	22.86	-0.61	-2.76	20.1	38.45	Pass
			835.5	22.68	-0.61	-2.76	19.92	38.45	Pass
			845.7	22.21	-0.61	-2.76	19.45	38.45	Pass

Note 1: For the HSDPA and HSUPA mode, all subtests were tested and just the worst data were recorded in this table.

Note 2:  $ERP/EIRP = P_{Meas} + GT - LC$

ERP/EIRP = effective or equivalent radiated power, respectively (expressed in the same units as P<sub>Meas</sub>, typically dBW or dBm);

P<sub>Meas</sub> = measured transmitter output power or PSD, in dBm or dBW;

GT = gain of the transmitting antenna, in dBd (ERP) or dBi (EIRP);

LC = signal attenuation in the connecting cable between the transmitter and antenna, in dB.

ERP = EIRP - 2.15; where ERP and EIRP are expressed in consistent units.

Note: Please refer to Annex (LTE Chapter 1 Transmitter Radiated Power) for more test data



Report No.: WSCT-ANAB-R&amp;E250400022A-RF

## 7. Peak to Average Ratio

### 7.1.1. Limit

FCC § 2.1046 &amp; 24.232(d) &amp; 27.50(d) &amp; 27.50(j) &amp; 27.50(k)

In addition, when the transmitter power is measured in terms of average value, the peak-to-average power ratio (PAPR) of the transmitter shall not exceed 13 dB for more than 0.1% of the time using a signal corresponding to the highest PAPR during periods of continuous transmission.

According to FCC section 24.232(d), power measurements for transmissions by stations authorized under this section may be made either in accordance with a Commission-approved average power technique or in compliance with 24.232 (e) of this section. In both instances, equipment employed must be authorized in accordance with the provisions of § 24.51. In measuring transmissions in this band using an average power technique, the peak-to-average ratio (PAR) of the transmission may not exceed 13 dB.

FCC section 24.232(e), peak transmit power must be measured over any interval of continuous transmission using instrumentation calibrated in terms of an rms equivalent voltage. The measurement results shall be properly adjusted for any instrument limitations, such as detector response times, limited resolution bandwidth capability when compared to the emission bandwidth, sensitivity, etc., so as to obtain a true peak measurement for the emission in question over the full bandwidth of the channel.

According to FCC section 27.50(d) (5) & 27.50(j) & 27.50(k), in measuring transmissions in this band using an average power technique, the peak-to-average ratio (PAR) of the transmission may not exceed 13dB.

### 7.1.2. Test Procedure

Here the lowest, middle and highest channels are selected to perform testing to verify the peak-to-average ratio.

According to KDB 971168 D01, there is CCDF procedure for PAPR:

- a) Refer to instrument's analyzer instruction manual for details on how to use the power statistics/CCDF function;
- b) Set resolution/measurement bandwidth  $\geq$  signal's occupied bandwidth;
- c) Set the number of counts to a value that stabilizes the measured CCDF curve;
- d) Set the measurement interval as follows:
  - 1) for continuous transmissions, set to 1 ms,

Report No.: WSCT-ANAB-R&E250400022A-RF

2) for burst transmissions, employ an external trigger that is synchronized with the EUT burst timing sequence, or use the internal burst trigger with a trigger level that allows the burst to stabilize and set the measurement interval to a time that is less than or equal to the burst duration.

e) Record the maximum PAPR level associated with a probability of 0.1%.



Report No.: WSCT-ANAB-R&E250400022A-RF

## 7.2. Test Result

Band	Channel	Frequency (MHz)	Result (dB)	high Limit (dB)	Verdict
WCDMA Band2	9262	1852.4	2.96	13	PASS
WCDMA Band2	9400	1880	3.09	13	PASS
WCDMA Band2	9538	1907.6	2.85	13	PASS
WCDMA Band4	1312	1712.4	3.12	13	PASS
WCDMA Band4	1413	1732.6	3.17	13	PASS
WCDMA Band4	1513	1752.6	3.13	13	PASS
WCDMA Band5	4132	826.4	2.78	13	PASS
WCDMA Band5	4182	836.4	2.56	13	PASS
WCDMA Band5	4233	846.6	2.82	13	PASS
WCDMA Band2	9262	1852.4	2.96	13	PASS
WCDMA Band2	9400	1880	3.09	13	PASS
WCDMA Band2	9538	1907.6	2.85	13	PASS
WCDMA Band4	1312	1712.4	3.12	13	PASS
WCDMA Band4	1413	1732.6	3.17	13	PASS
WCDMA Band4	1513	1752.6	3.13	13	PASS
WCDMA Band5	4132	826.4	2.78	13	PASS
WCDMA Band5	4182	836.4	2.56	13	PASS
WCDMA Band5	4233	846.6	2.82	13	PASS



Report No.: WSCT-ANAB-R&E250400022A-RF

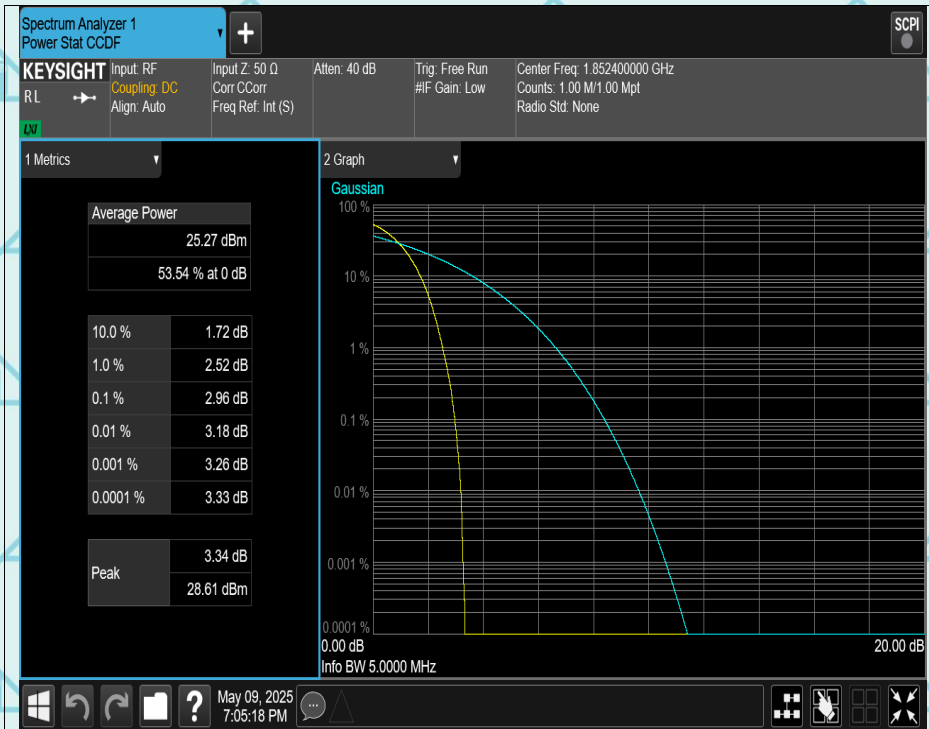

WCDMA Band2 Channel=9262

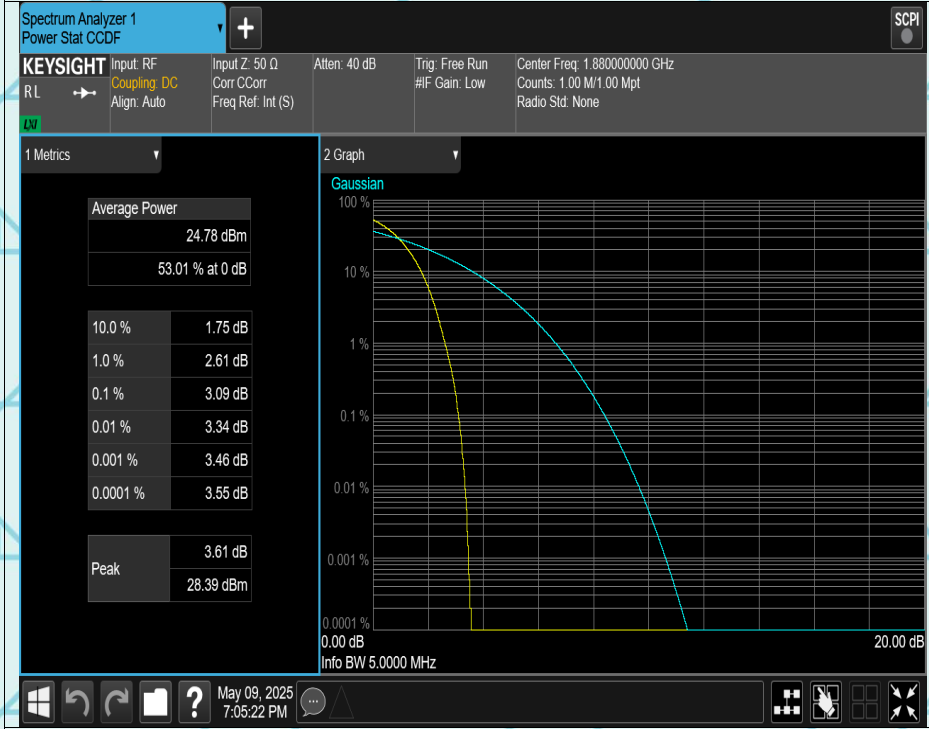

WCDMA Band2 Channel=9400



Report No.: WSCT-ANAB-R&E250400022A-RF

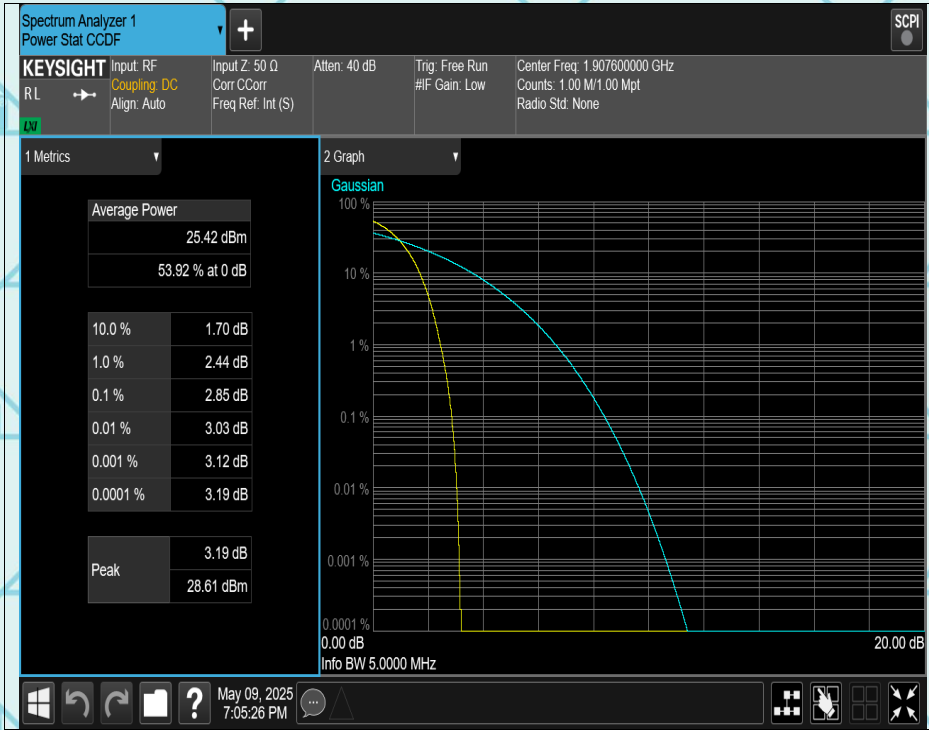

WCDMA Band2 Channel=9538

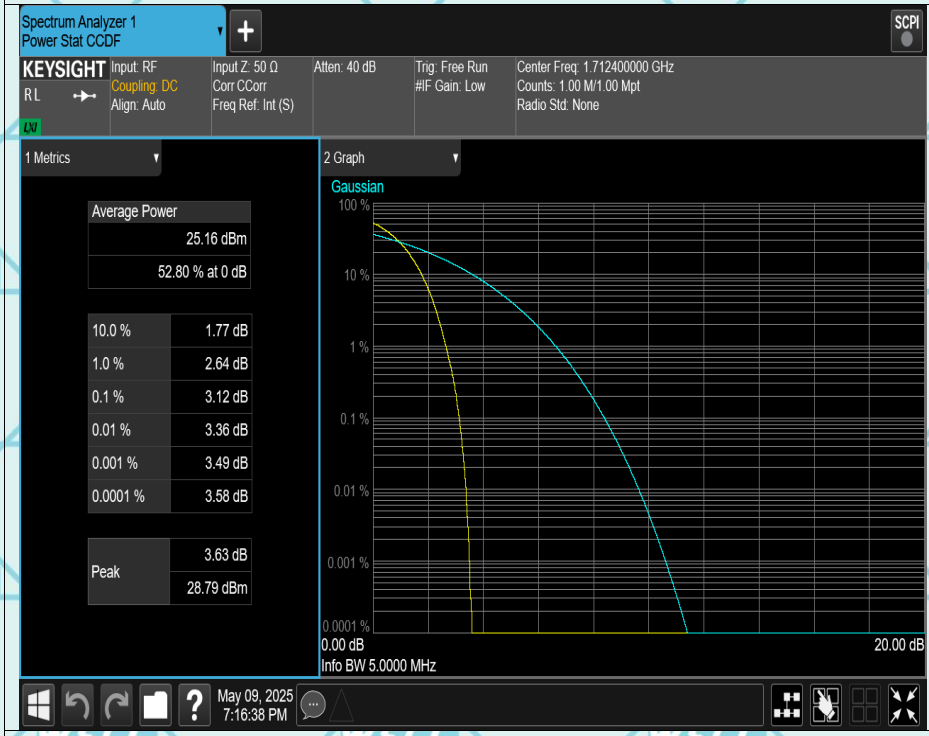

WCDMA Band4 Channel=1312



Report No.: WSCT-ANAB-R&E250400022A-RF

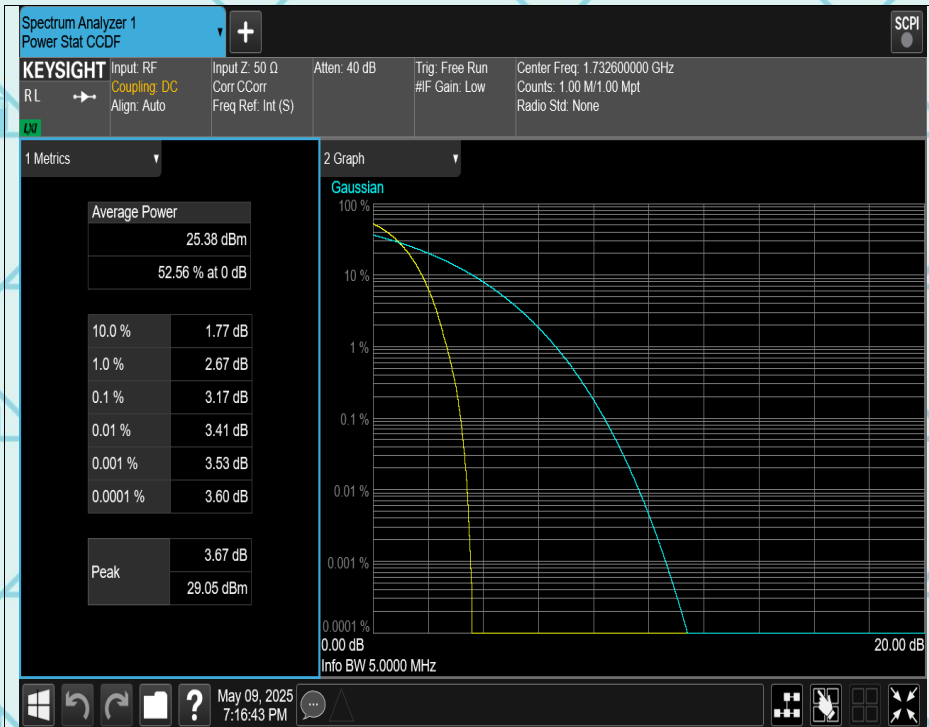

WCDMA Band4 Channel=1413



WCDMA Band4 Channel=1513



Report No.: WSCT-ANAB-R&E250400022A-RF

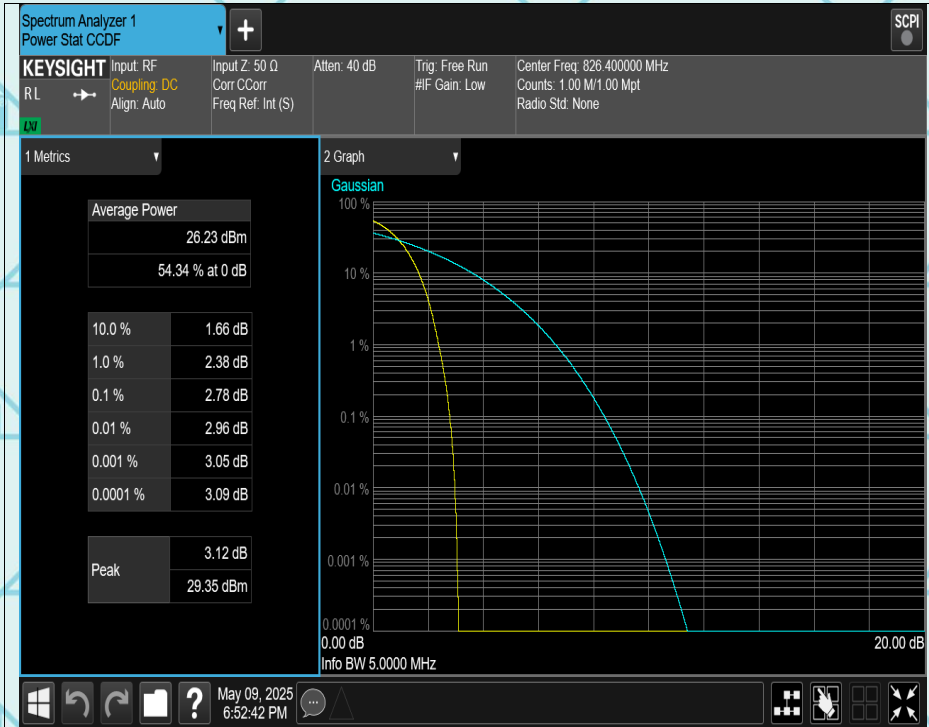

WCDMA Band5 Channel=4132

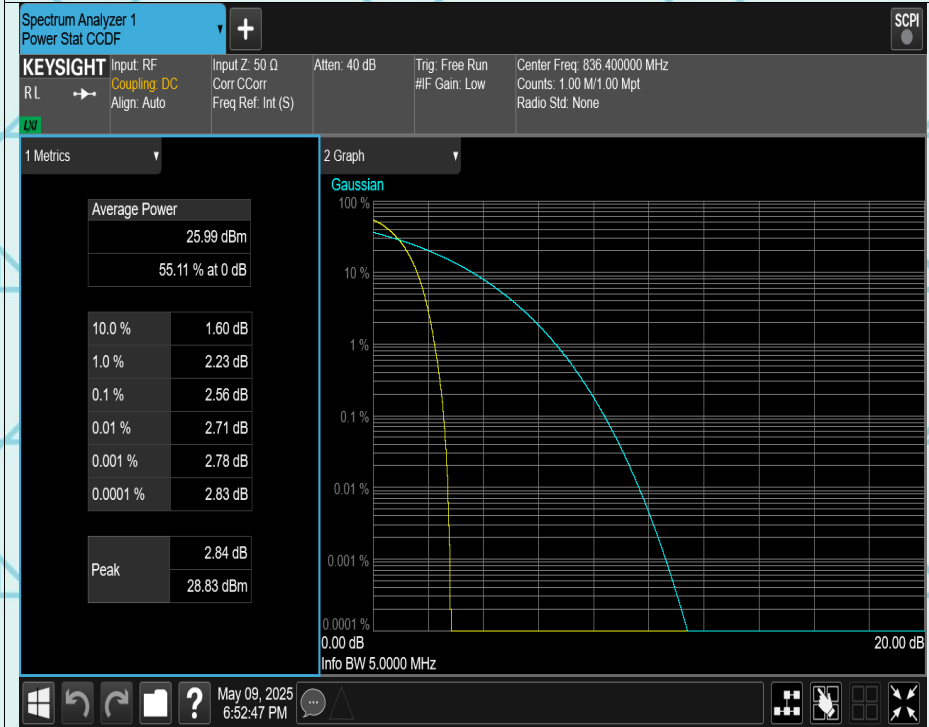

WCDMA Band5 Channel=4182



Report No.: WSCT-ANAB-R&E250400022A-RF

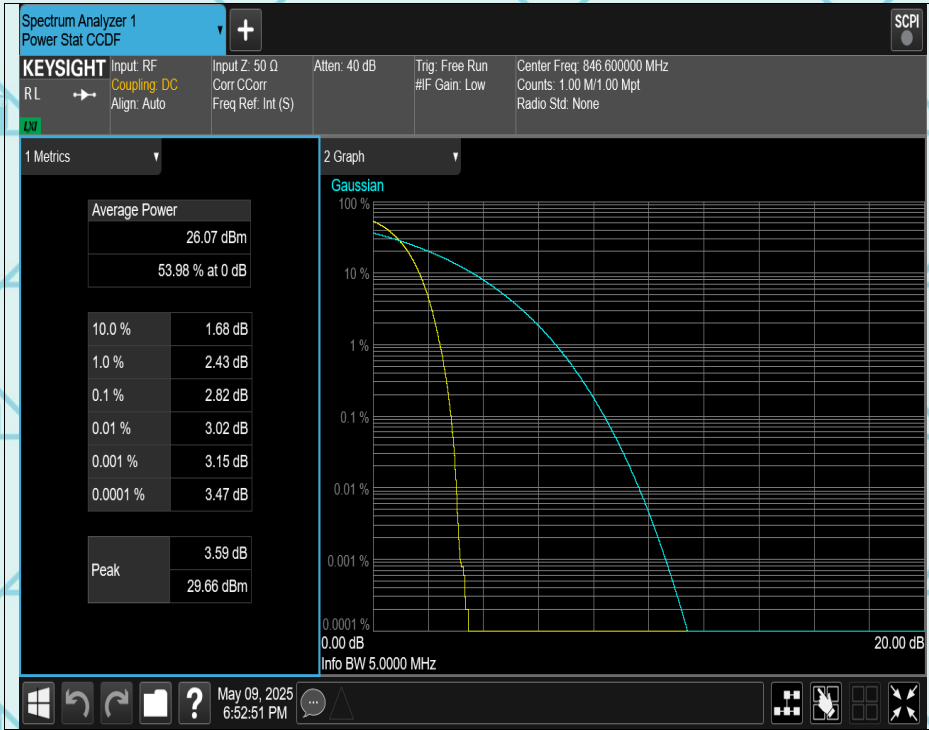

WCDMA Band5 Channel=4233

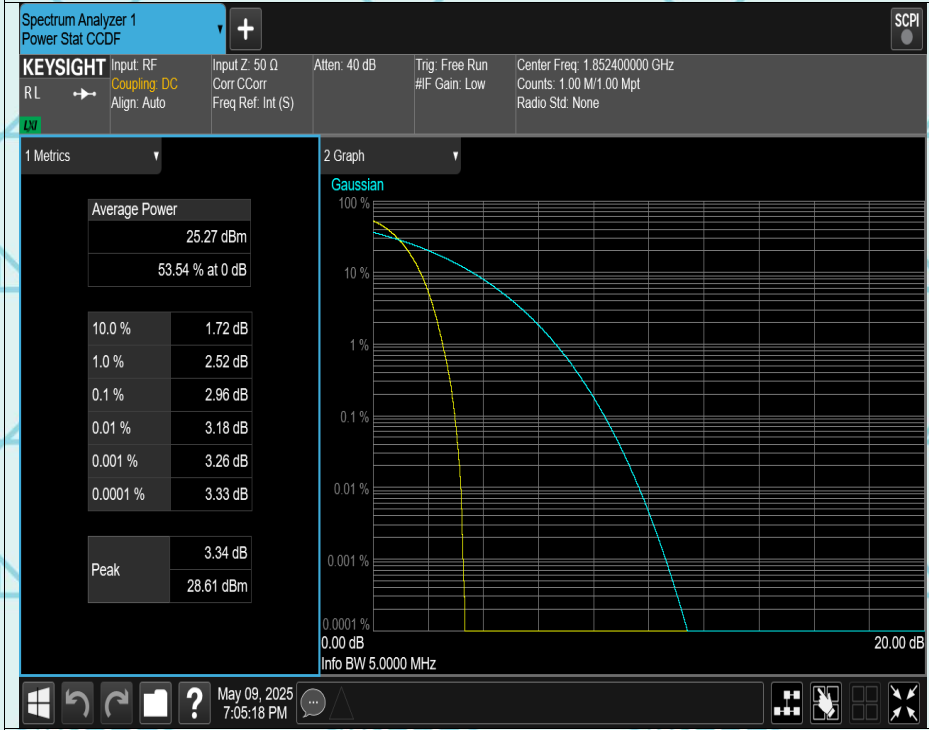

WCDMA Band2 Channel=9262



Report No.: WSCT-ANAB-R&E250400022A-RF

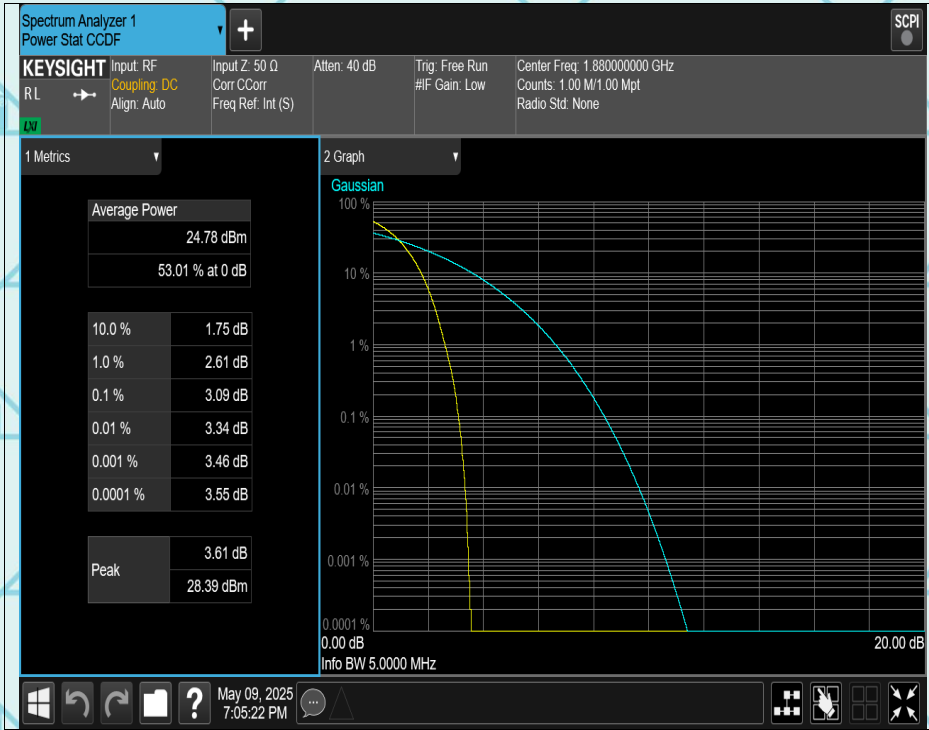

WCDMA Band2 Channel=9400

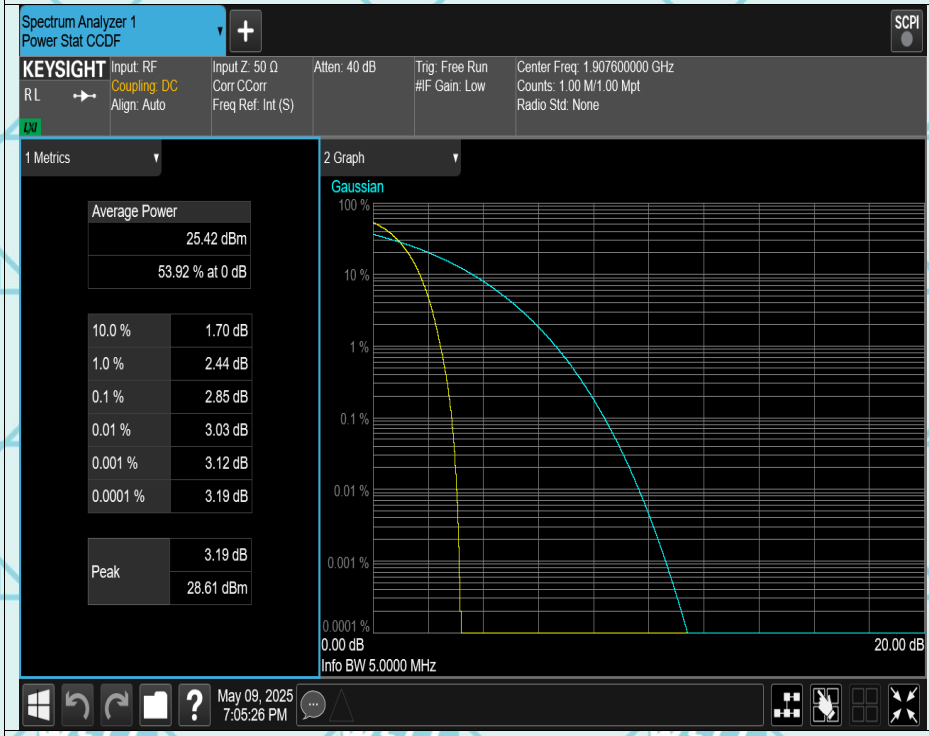

WCDMA Band2 Channel=9538



Report No.: WSCT-ANAB-R&E250400022A-RF

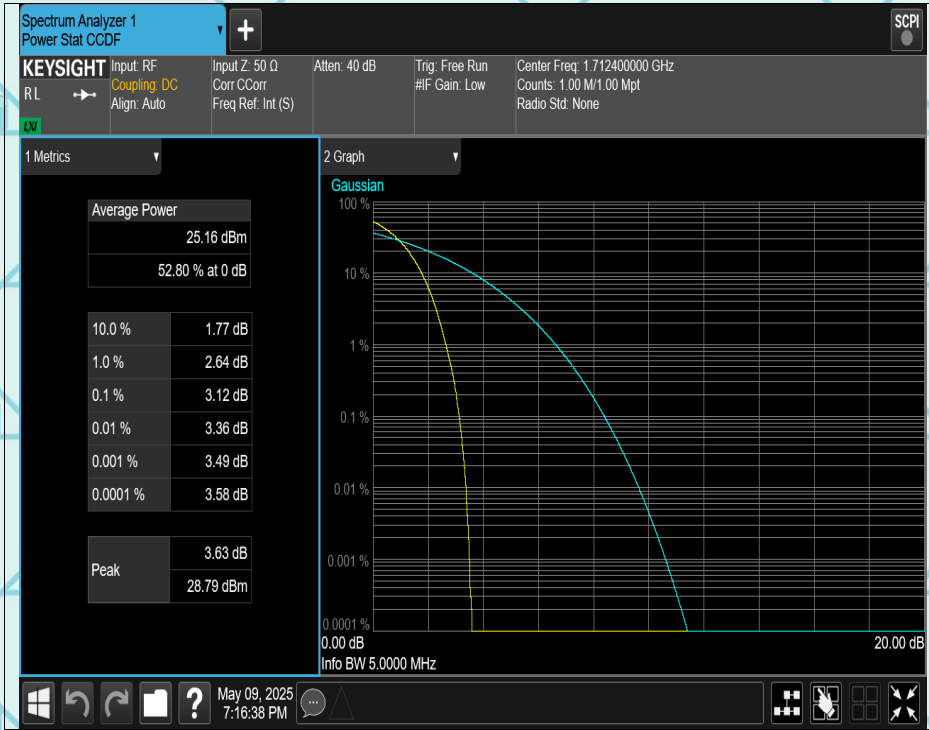

WCDMA Band4 Channel=1312

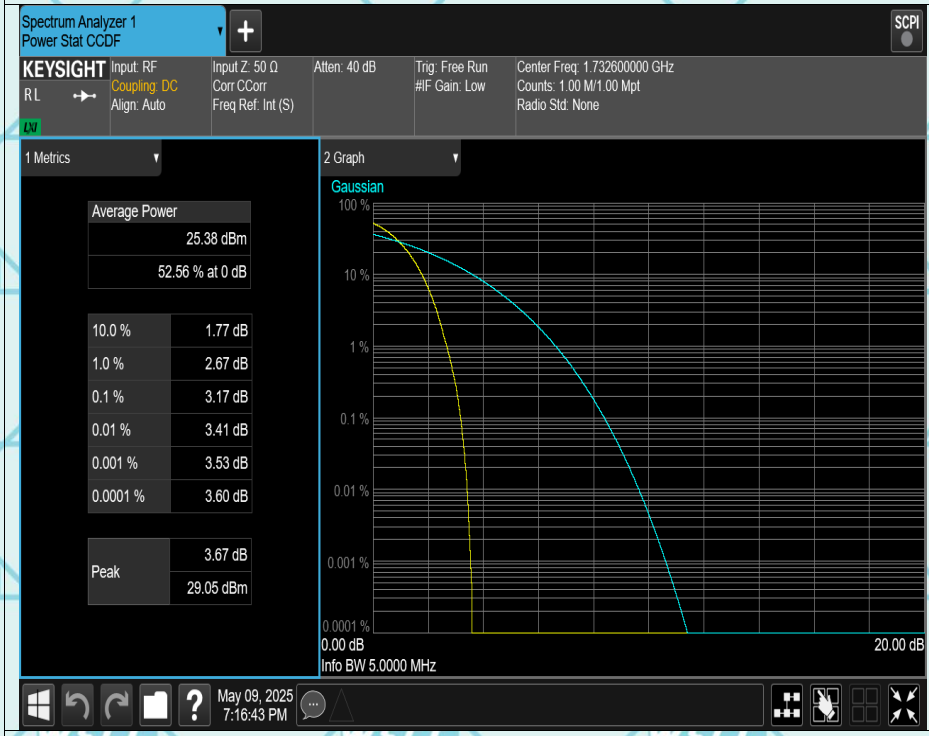

WCDMA Band4 Channel=1413



Report No.: WSCT-ANAB-R&E250400022A-RF

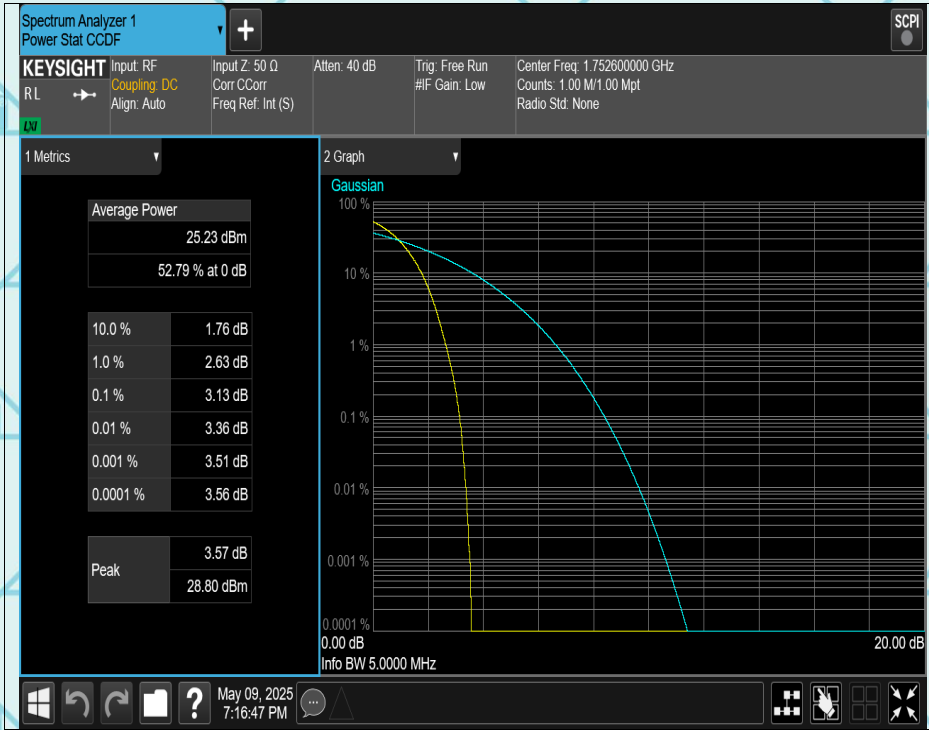

WCDMA Band4 Channel=1513

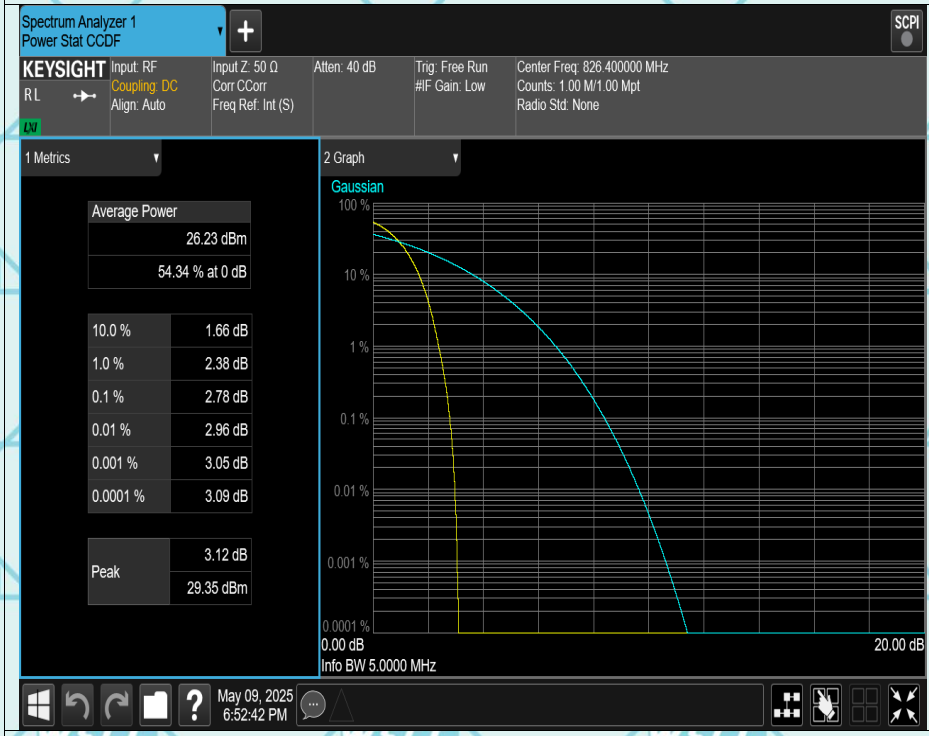

WCDMA Band5 Channel=4132



Report No.: WSCT-ANAB-R&E250400022A-RF

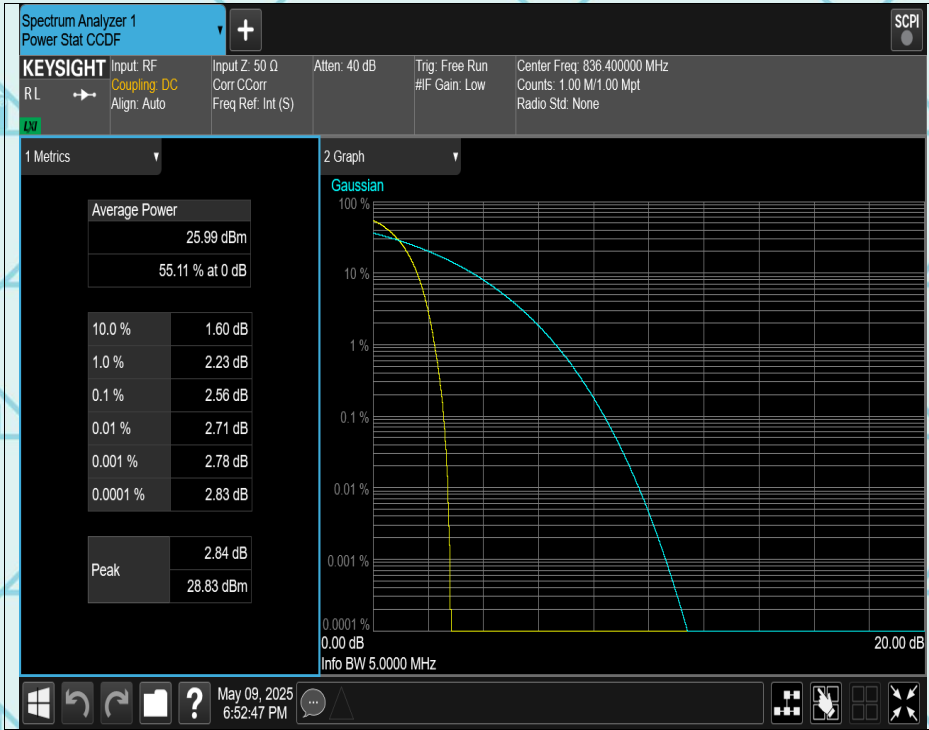

WCDMA Band5 Channel=4182

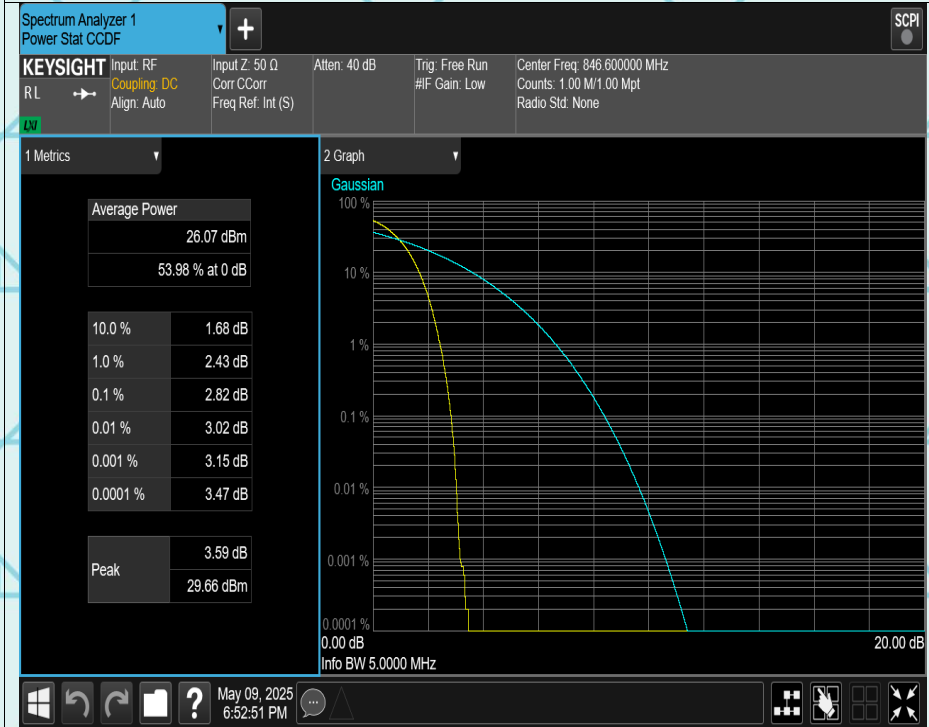

Report No.: WSCT-ANAB-R&E250400022A-RF

## 8. SPURIOUS EMISSION (Conducted and Radiated)

### 8.1. Measurement Result (Pre-measurement)

#### UTRA BANDS

##### Band 2:

Test Channel	BW(MHz)	UL Channel	Frequency(MHz)	Judgment
Low Range	5	9262	1850.1	Pass
Middle Range	5	9400	1879.1	Pass
High Range	5	9538	1905.1	Pass

##### Band 4:

Test Channel	BW(MHz)	UL Channel	Frequency(MHz)	Judgment
Low Range	5	1312	1710.0	Pass
Middle Range	5	1413	1731.7	Pass
High Range	5	1513	1750.2	Pass

##### Band 5:

Test Channel	BW(MHz)	UL Channel	Frequency(MHz)	Judgment
Low Range	5	4132	825.5	Pass
Middle Range	5	4182	835.5	Pass
High Range	5	4233	845.7	Pass

Report No.: WSCT-ANAB-R&E250400022A-RF

### E-UTRA BANDS

#### Band 2:

Bandwidth	UL Channel	Frequency	Modulation	RB Size	RB Offset	Judgment
1.4	18607	1850.7	QPSK	6	LOW	Pass
1.4	18607	1850.7	Q16	6	LOW	Pass
1.4	18900	1880	QPSK	6	LOW	Pass
1.4	18900	1880	Q16	6	LOW	Pass
1.4	19193	1909.3	QPSK	6	LOW	Pass
1.4	19193	1909.3	Q16	6	LOW	Pass
3	18615	1851.5	QPSK	15	LOW	Pass
3	18615	1851.5	Q16	15	LOW	Pass
3	18900	1880	QPSK	15	LOW	Pass
3	18900	1880	Q16	15	LOW	Pass
3	19185	1908.5	QPSK	15	LOW	Pass
3	19185	1908.5	Q16	15	LOW	Pass
5	18625	1852.5	QPSK	25	LOW	Pass
5	18625	1852.5	Q16	25	LOW	Pass
5	18900	1880	QPSK	25	LOW	Pass
5	18900	1880	Q16	25	LOW	Pass
5	19175	1907.5	QPSK	25	LOW	Pass
5	19175	1907.5	Q16	25	LOW	Pass
10	18650	1855	QPSK	50	LOW	Pass
10	18650	1855	Q16	50	LOW	Pass
10	18900	1880	QPSK	50	LOW	Pass
10	18900	1880	Q16	50	LOW	Pass
10	19150	1905	QPSK	50	LOW	Pass
10	19150	1905	Q16	50	LOW	Pass
15	18675	1857.5	QPSK	75	LOW	Pass
15	18675	1857.5	Q16	75	LOW	Pass
15	18900	1880	QPSK	75	LOW	Pass
15	18900	1880	Q16	75	LOW	Pass
15	19125	1902.5	QPSK	75	LOW	Pass
15	19125	1902.5	Q16	75	LOW	Pass
20	18700	1860	QPSK	100	LOW	Pass
20	18700	1860	Q16	100	LOW	Pass
20	18900	1880	QPSK	100	LOW	Pass
20	18900	1880	Q16	100	LOW	Pass
20	19100	1900	QPSK	100	LOW	Pass
20	19100	1900	Q16	100	LOW	Pass

#### Band 4:

Bandwidth	UL Channel	Frequency	Modulation	RB Size	RB Offset	Judgment
1.4	19957	1710.7	QPSK	6	LOW	Pass
1.4	19957	1710.7	Q16	6	LOW	Pass
1.4	20393	1754.3	QPSK	6	LOW	Pass
1.4	20393	1754.3	Q16	6	LOW	Pass
1.4	20175	1732.5	QPSK	6	LOW	Pass
1.4	20175	1732.5	Q16	6	LOW	Pass
3	19965	1711.5	QPSK	15	LOW	Pass
3	19965	1711.5	Q16	15	LOW	Pass



Report No.: WSCT-ANAB-R&E250400022A-RF

Bandwidth	UL Channel	Frequency	Modulation	RB Size	RB Offset	Judgment
3	20385	1753.5	QPSK	15	LOW	Pass
3	20385	1753.5	Q16	15	LOW	Pass
3	20175	1732.5	QPSK	15	LOW	Pass
3	20175	1732.5	Q16	15	LOW	Pass
5	19975	1712.5	QPSK	25	LOW	Pass
5	19975	1712.5	Q16	25	LOW	Pass
5	20375	1752.5	QPSK	25	LOW	Pass
5	20375	1752.5	Q16	25	LOW	Pass
5	20175	1732.5	QPSK	25	LOW	Pass
5	20175	1732.5	Q16	25	LOW	Pass
10	20000	1715	QPSK	50	LOW	Pass
10	20000	1715	Q16	50	LOW	Pass
10	20350	1750	QPSK	50	LOW	Pass
10	20350	1750	Q16	50	LOW	Pass
10	20175	1732.5	QPSK	50	LOW	Pass
10	20175	1732.5	Q16	50	LOW	Pass
15	20025	1717.5	QPSK	75	LOW	Pass
15	20025	1717.5	Q16	75	LOW	Pass
15	20325	1747.5	QPSK	75	LOW	Pass
15	20325	1747.5	Q16	75	LOW	Pass
15	20175	1732.5	QPSK	75	LOW	Pass
15	20175	1732.5	Q16	75	LOW	Pass
20	20050	1720	QPSK	100	LOW	Pass
20	20050	1720	Q16	100	LOW	Pass
20	20300	1745	QPSK	100	LOW	Pass
20	20300	1745	Q16	100	LOW	Pass
20	20175	1732.5	QPSK	100	LOW	Pass
20	20175	1732.5	Q16	100	LOW	Pass

**Band 5:**

Bandwidth	UL Channel	Frequency	Modulation	RB Size	RB Offset	Judgment
1.4	20470	824.7	QPSK	6	LOW	Pass
1.4	20470	824.7	Q16	6	LOW	Pass
1.4	20525	836.5	QPSK	6	LOW	Pass
1.4	20525	836.5	Q16	6	LOW	Pass
1.4	20643	848.3	QPSK	6	LOW	Pass
1.4	20643	848.3	Q16	6	LOW	Pass
3	20415	825.5	QPSK	15	LOW	Pass
3	20415	825.5	Q16	15	LOW	Pass
3	20525	836.5	QPSK	15	LOW	Pass
3	20525	836.5	Q16	15	LOW	Pass
3	20635	847.5	QPSK	15	LOW	Pass
3	20635	847.5	Q16	15	LOW	Pass
5	20425	826.5	QPSK	25	LOW	Pass
5	20425	826.5	Q16	25	LOW	Pass
5	20525	836.5	QPSK	25	LOW	Pass
5	20525	836.5	Q16	25	LOW	Pass
5	20625	846.5	QPSK	25	LOW	Pass
5	20625	846.5	Q16	25	LOW	Pass
10	20450	829	QPSK	50	LOW	Pass



Report No.: WSCT-ANAB-R&E250400022A-RF

Bandwidth	UL Channel	Frequency	Modulation	RB Size	RB Offset	Judgment
10	20450	829	Q16	50	LOW	Pass
10	20525	836.5	QPSK	50	LOW	Pass
10	20525	836.5	Q16	50	LOW	Pass
10	20600	844	QPSK	50	LOW	Pass
10	20600	844	Q16	50	LOW	Pass

**Band 7:**

Bandwidth	UL Channel	Frequency	Modulation	RB Size	RB Offset	Judgment
5	20775	2502.5	QPSK	25	LOW	Pass
5	20775	2502.5	Q16	25	LOW	Pass
5	21425	2567.5	QPSK	25	LOW	Pass
5	21425	2567.5	Q16	25	LOW	Pass
5	21100	2535	QPSK	25	LOW	Pass
5	21100	2535	QPSK	25	LOW	Pass
10	20800	2505	QPSK	50	LOW	Pass
10	20800	2505	Q16	50	LOW	Pass
10	21400	2565	QPSK	50	LOW	Pass
10	21400	2565	Q16	50	LOW	Pass
10	21100	2535	QPSK	50	LOW	Pass
10	21100	2535	Q16	50	LOW	Pass
15	20825	2507.5	QPSK	75	LOW	Pass
15	20825	2507.5	Q16	75	LOW	Pass
15	21375	2562.5	QPSK	75	LOW	Pass
15	21375	2562.5	Q16	75	LOW	Pass
15	21100	2535	QPSK	75	LOW	Pass
15	21100	2535	Q16	75	LOW	Pass
20	20850	2510	QPSK	100	LOW	Pass
20	20850	2510	Q16	100	LOW	Pass
20	21350	2560	QPSK	100	LOW	Pass
20	21350	2560	Q16	100	LOW	Pass
20	21100	2535	QPSK	100	LOW	Pass
20	21100	2535	Q16	100	LOW	Pass

**Band 12:**

Bandwidth	UL Channel	Frequency	Modulation	RB Size	RB Offset	Judgment
1.4	23017	699.7	QPSK	6	LOW	Pass
1.4	23017	699.7	Q16	6	LOW	Pass
1.4	23095	707.5	QPSK	6	LOW	Pass
1.4	23095	707.5	Q16	6	LOW	Pass
1.4	23173	715.3	QPSK	6	LOW	Pass
1.4	23173	715.3	Q16	6	LOW	Pass
3	23025	700.5	QPSK	15	LOW	Pass
3	23025	700.5	Q16	15	LOW	Pass
3	23095	707.5	QPSK	15	LOW	Pass
3	23095	707.5	Q16	15	LOW	Pass
3	23165	714.5	QPSK	15	LOW	Pass
3	23165	714.5	Q16	15	LOW	Pass
5	23035	701.5	QPSK	25	LOW	Pass

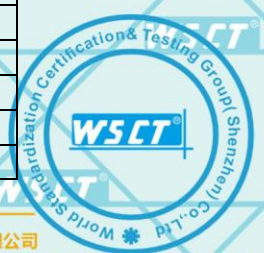

Report No.: WSCT-ANAB-R&E250400022A-RF

Bandwidth	UL Channel	Frequency	Modulation	RB Size	RB Offset	Judgment
5	23035	701.5	Q16	25	LOW	Pass
5	23095	707.5	QPSK	25	LOW	Pass
5	23095	707.5	Q16	25	LOW	Pass
5	23155	713.5	QPSK	25	LOW	Pass
5	23155	713.5	Q16	25	LOW	Pass
10	23060	704	QPSK	50	LOW	Pass
10	23060	704	Q16	50	LOW	Pass
10	23095	707.5	QPSK	50	LOW	Pass
10	23095	707.5	Q16	50	LOW	Pass
10	23130	711	QPSK	50	LOW	Pass
10	23130	711	Q16	50	LOW	Pass

**Band 41: (2535-2655 MHz)**

Bandwidth	UL Channel	Frequency	Modulation	RB Size	RB Offset	Judgment
5	39675	2498.5	QPSK	25	LOW	Pass
5	39675	2498.5	Q16	25	LOW	Pass
5	40620	2593	QPSK	25	LOW	Pass
5	40620	2593	Q16	25	LOW	Pass
5	41565	2687.5	QPSK	25	LOW	Pass
5	41565	2687.5	Q16	25	LOW	Pass
10	39700	2501	QPSK	50	LOW	Pass
10	39700	2501	Q16	50	LOW	Pass
10	40620	2593	QPSK	50	LOW	Pass
10	40620	2593	Q16	50	LOW	Pass
10	41540	2685	QPSK	50	LOW	Pass
10	41540	2685	Q16	50	LOW	Pass
15	39725	2503.5	QPSK	75	LOW	Pass
15	39725	2503.5	Q16	75	LOW	Pass
15	40620	2593	QPSK	75	LOW	Pass
15	40620	2593	Q16	75	LOW	Pass
15	41515	2682.5	QPSK	75	LOW	Pass
15	41515	2682.5	Q16	75	LOW	Pass
20	39750	2506	QPSK	100	LOW	Pass
20	39750	2506	Q16	100	LOW	Pass
20	40620	2593	QPSK	100	LOW	Pass
20	40620	2593	Q16	100	LOW	Pass
20	41490	2680	QPSK	100	LOW	Pass
20	41490	2680	Q16	100	LOW	Pass

Test Plot(s)



Report No.: WSCT-ANAB-R&E250400022A-RF

### Conducted method

#### Test limit:

The spurious (unwanted) emission limits specified in the individual FCC rule parts applicable to licensed digital transmitters (typically referred to under the heading 'emission limits') normally apply to any and all emissions that are present outside of the authorized frequency band/block and apply to emissions in both the out-of-band and spurious domains. In some rule parts, the unwanted emission limits are specified by an emission mask that defines the applicable limit as a function of the frequency range relative to the authorized frequency block.

Typically, unwanted emissions are required by the licensed rule parts to be attenuated below the transmitter power by a factor of at least  $X + 10\log(P)$  dB, where P represents the transmitter power expressed in watts and X is a specified scalar value (e.g., 43). This specification can be interpreted in one of two equivalent ways. First, the required attenuation can be construed to be relative to the mean carrier power, with the resultant of the equation  $X + 10\log(P)$  being expressed in dBc (dB relative to the maximum carrier power). Alternatively, the specification can be interpreted as an absolute limit when the specified attenuation is actually subtracted from the maximum permissible transmitter power [i.e.,  $10\log(P) - \{X + 10\log(P)\}$ ], resulting in an absolute level of -X dBW [or  $(-X + 30)$  dBm]. See section 4.

#### Test procedure:

The RF output of the transceiver was connected to a spectrum analyzer and simulator through appropriate attenuation. The resolution bandwidth of the spectrum analyzer was set at 100 kHz below 1 GHz and 1 MHz above 1 GHz. Sufficient scans were taken to show any out of band emissions up to 10th harmonics.

#### Conducted Emission Test-Up:

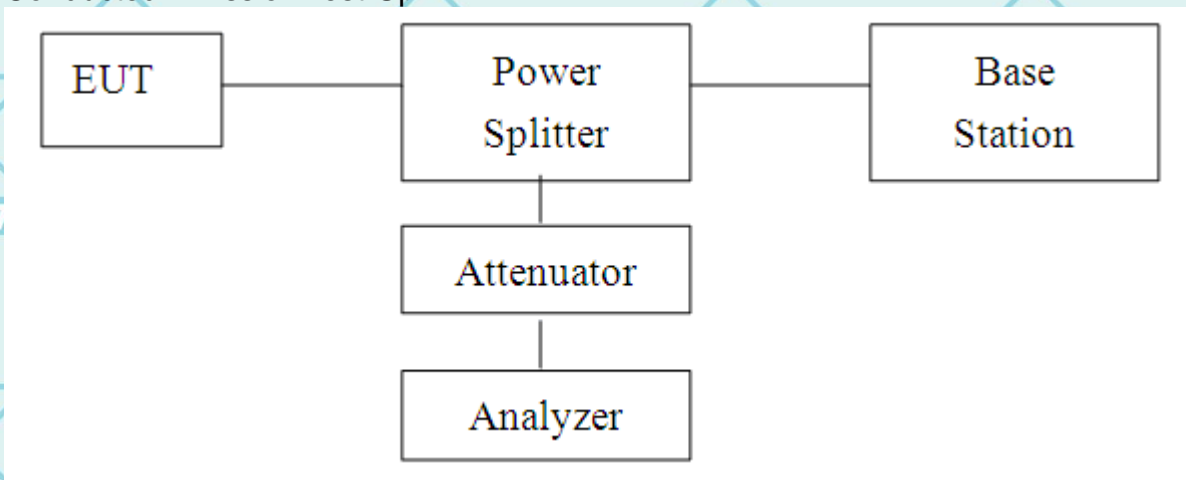

Report No.: WSCT-ANAB-R&E250400022A-RF

### Radiated method

#### Test limit:

The spurious (unwanted) emission limits specified in the individual FCC rule parts applicable to licensed digital transmitters (typically referred to under the heading 'emission limits') normally apply to any and all emissions that are present outside of the authorized frequency band/block and apply to emissions in both the out-of-band and spurious domains. In some rule parts, the unwanted emission limits are specified by an emission mask that defines the applicable limit as a function of the frequency range relative to the authorized frequency block.

Typically, unwanted emissions are required by the licensed rule parts to be attenuated below the transmitter power by a factor of at least  $X + 10\log(P)$  dB, where P represents the transmitter power expressed in watts and X is a specified scalar value (e.g., 43). This specification can be interpreted in one of two equivalent ways. First, the required attenuation can be construed to be relative to the mean carrier power, with the resultant of the equation  $X + 10\log(P)$  being expressed in dBc (dB relative to the maximum carrier power). Alternatively, the specification can be interpreted as an absolute limit when the specified attenuation is actually subtracted from the maximum permissible transmitter power [i.e.,  $10\log(P) - \{X + 10\log(P)\}$ ], resulting in an absolute level of -X dBW [or  $(-X + 30)$  dBm]. See section 4.

#### Test procedure:

The radiated emission tests were performed in the 3m Semi- Anechoic Chamber test site. The resolution bandwidth of the spectrum analyzer was set at 100 kHz below 1 GHz and 1 MHz above 1 GHz. Sufficient scans were taken to show any out of band emissions up to 10th harmonics.

#### Test setup:

##### (A) Radiated Emission Test-Up Frequency 30MHz~1GHz

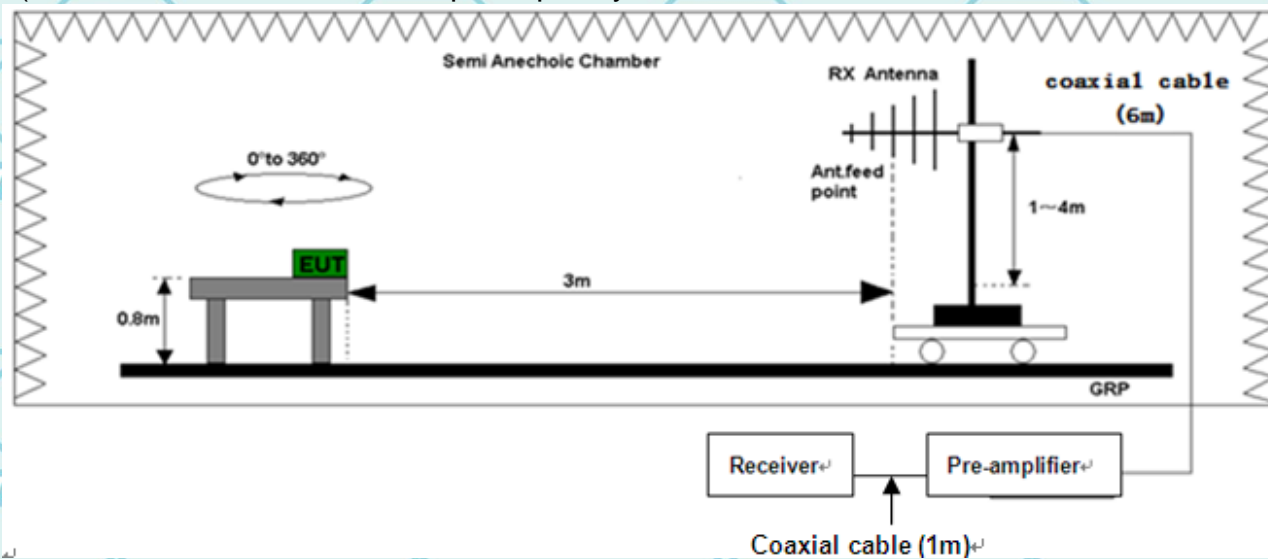

Report No.: WSCT-ANAB-R&E250400022A-RF

(B) Radiated Emission Test-Up Frequency Above 1GHz

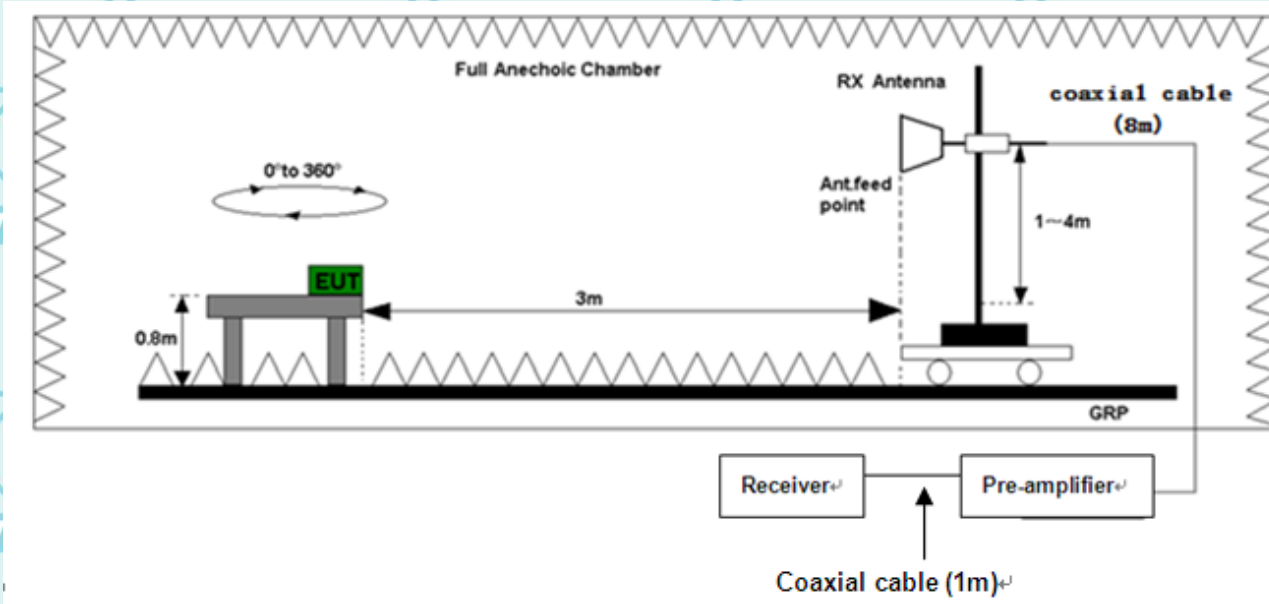

Note:

- 1, Below 30MHz no Spurious found.
- 2, UE is positioned at 3 axis at the pre-scan stage, and only the measurement of the worst case is reported in this part.

Report No.: WSCT-ANAB-R&E250400022A-RF

**List of final test modes:**

**ULTRA BANDS**

**Band 2:**

Channel	UL Channel	Frequency	Judgment
Middle	9400	1880	Pass

**Band 4:**

Channel	UL Channel	Frequency	Judgment
Middle	1413	1732.6	Pass

**Band 5:**

Channel	UL Channel	Frequency	Judgment
Middle	4182	836.4	Pass



Report No.: WSCT-ANAB-R&E250400022A-RF

**E-ULTRA BANDS**

**This is the worst pattern data**

**Band 2:**

Channel	Bandwidth	UL Channel	Frequency	Modulation	RB Size	RB Offset	Judgment
Middle	20	18900	1880	QPSK	100	LOW	Pass

**Band 4:**

Mode	Bandwidth	UL Channel	Frequency	Modulation	RB Size	RB Offset	Judgment
1	20	20300	1745	Q16	100	LOW	Pass

**Band 5:**

Channel	Bandwidth	UL Channel	Frequency	Modulation	RB Size	RB Offset	Judgment
Middle	10	20525	836.5	QPSK	50	LOW	Pass

**Band 7:**

Channel	Bandwidth	UL Channel	Frequency	Modulation	RB Size	RB Offset	Judgment
Middle	20	21350	2560	QPSK	100	LOW	Pass

**Band 12:**

Channel	Bandwidth	UL Channel	Frequency	Modulation	RB Size	RB Offset	Judgment
Middle	10	23095	707.5	QPSK	50	LOW	Pass

**Band 41: (2535-2655 MHz)**

Channel	Bandwidth	UL Channel	Frequency	Modulation	RB Size	RB Offset	Judgment
Middle	20	40620	2593	QPSK	100	LOW	Pass

Test record:

Note:

1. The substitution method is used. Substitution values at each frequency are measured before and saved to the test software. A "reference path loss" is established and the ARpl is the attenuation of "reference path loss", and including the gain of receive antenna, the gain of the preamplifier, the cable loss and the air loss. The measurement results are obtained as described below:

$$\text{Power} = P_{\text{Mea}} + A_{\text{Rpl}}$$

2.  $A_{\text{Rpl}} = \text{Cable loss} + \text{Antenna gain}$



Report No.: WSCT-ANAB-R&E250400022A-RF

UTRA BANDS

Band 2:

Horizontal:

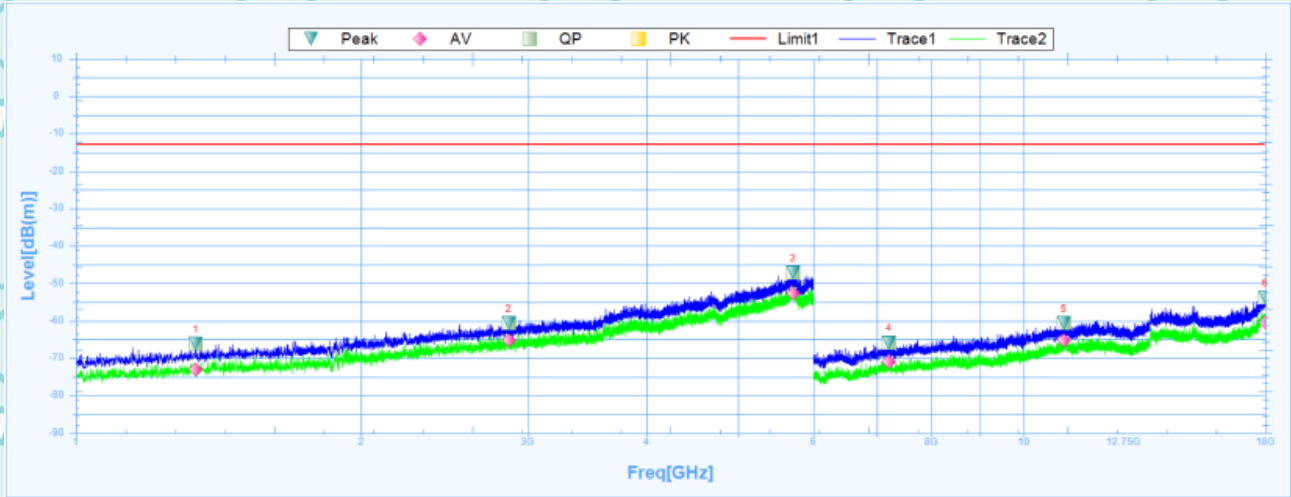

**Susputed Data List**

NO.	Freq. [MHz]	Reading [dB(m)]	Factor [dB]	Level [dB(m)]	Limit [dB]	Margin [dB]	Deg [°]	Polarity	Trace	Verdict
1	1338.1250	-66.21	24.88	-91.09	-13	-53.21	357	Horizontal	PK	Pass
1	1338.1250	-72.88	24.88	-97.76	54	-126.88	357	Horizontal	AV	Pass
2	2862.5000	-60.6	28.04	-88.64	-13	-47.6	69	Horizontal	PK	Pass
2	2862.5000	-65.24	28.04	-93.28	54	-119.24	69	Horizontal	AV	Pass
3	5707.5000	-47.12	32.33	-79.45	-13	-34.12	59.4	Horizontal	PK	Pass
3	5707.5000	-52.72	32.33	-85.05	54	-106.72	59.4	Horizontal	AV	Pass
4	7209.0000	-65.81	6.99	-72.8	-13	-52.81	330.4	Horizontal	PK	Pass
4	7209.0000	-70.97	6.99	-77.96	54	-124.97	330.4	Horizontal	AV	Pass
5	11025.0000	-60.58	15.7	-76.28	-13	-47.58	20.1	Horizontal	PK	Pass
5	11025.0000	-65.24	15.7	-80.94	54	-119.24	20.1	Horizontal	AV	Pass
6	17976.0000	-53.67	23.76	-77.43	-13	-40.67	118.8	Horizontal	PK	Pass
6	17976.0000	-60.4	23.76	-84.16	54	-114.4	118.8	Horizontal	AV	Pass



Report No.: WSCT-ANAB-R&E250400022A-RF

Vertical:

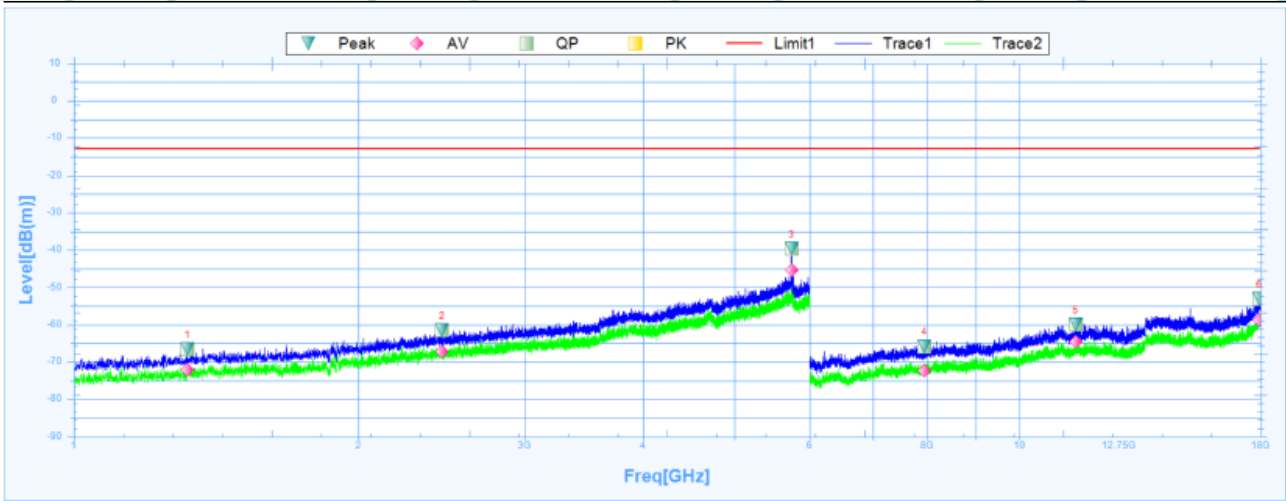

Suspected Data List										
NO.	Freq. [MHz]	Reading [dB(m)]	Factor [dB]	Level [dB(m)]	Limit [dB]	Margin [dB]	Deg [°]	Polarity	Trace	Verdict
1	1318.7500	-66.55	24.82	-91.37	-13	-53.55	359.5	Vertical	PK	Pass
1	1318.7500	-72.11	24.82	-96.93	54	-126.11	359.5	Vertical	AV	Pass
2	2452.5000	-61.46	27.44	-88.9	-13	-48.46	33.4	Vertical	PK	Pass
2	2452.5000	-67.2	27.44	-94.64	54	-121.2	33.4	Vertical	AV	Pass
3	5743.7500	-39.55	32.39	-71.94	-13	-26.55	181.5	Vertical	PK	Pass
3	5743.7500	-45.46	32.39	-77.85	54	-99.46	181.5	Vertical	AV	Pass
4	7939.5000	-65.8	8.1	-73.9	-13	-52.8	50.6	Vertical	PK	Pass
4	7939.5000	-72.27	8.1	-80.37	54	-126.27	50.6	Vertical	AV	Pass
5	11473.5000	-59.94	16.05	-75.99	-13	-46.94	288.6	Vertical	PK	Pass
5	11473.5000	-64.65	16.05	-80.7	54	-118.65	288.6	Vertical	AV	Pass
6	17940.0000	-53.04	23.52	-76.56	-13	-40.04	288.6	Vertical	PK	Pass
6	17940.0000	-58.92	23.52	-82.44	54	-112.92	288.6	Vertical	AV	Pass



Report No.: WSCT-ANAB-R&E250400022A-RF

Band 4:  
Horizontal:

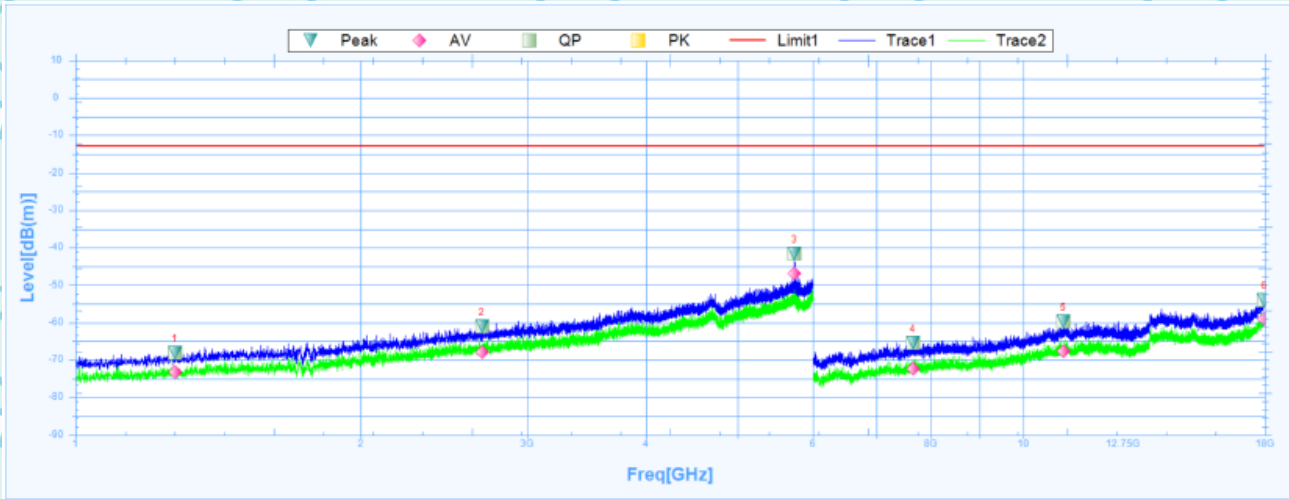

**Susputed Data List**

NO.	Freq. [MHz]	Reading [dB(m)]	Factor [dB]	Level [dB(m)]	Limit [dB]	Margin [dB]	Deg [°]	Polarity	Trace	Verdict
1	1273.1250	-68.09	24.66	-92.75	-13	-55.09	205.4	Horizontal	PK	Pass
1	1273.1250	-73.22	24.66	-97.88	54	-127.22	205.4	Horizontal	AV	Pass
2	2684.3750	-61.14	27.82	-88.96	-13	-48.14	88.3	Horizontal	PK	Pass
2	2684.3750	-67.84	27.82	-95.66	54	-121.84	88.3	Horizontal	AV	Pass
3	5738.7500	-41.64	32.38	-74.02	-13	-28.64	199.4	Horizontal	PK	Pass
3	5738.7500	-46.91	32.38	-79.29	54	-100.91	199.4	Horizontal	AV	Pass
4	7650.0000	-65.51	7.96	-73.47	-13	-52.51	259.8	Horizontal	PK	Pass
4	7650.0000	-72.21	7.96	-80.17	54	-126.21	259.8	Horizontal	AV	Pass
5	11023.5000	-59.81	15.69	-75.5	-13	-46.81	66.2	Horizontal	PK	Pass
5	11023.5000	-67.7	15.69	-83.39	54	-121.7	66.2	Horizontal	AV	Pass
6	17968.5000	-53.97	23.71	-77.68	-13	-40.97	360	Horizontal	PK	Pass
6	17968.5000	-59.06	23.71	-82.77	54	-113.06	360	Horizontal	AV	Pass

Report No.: WSCT-ANAB-R&E250400022A-RF

Vertical:

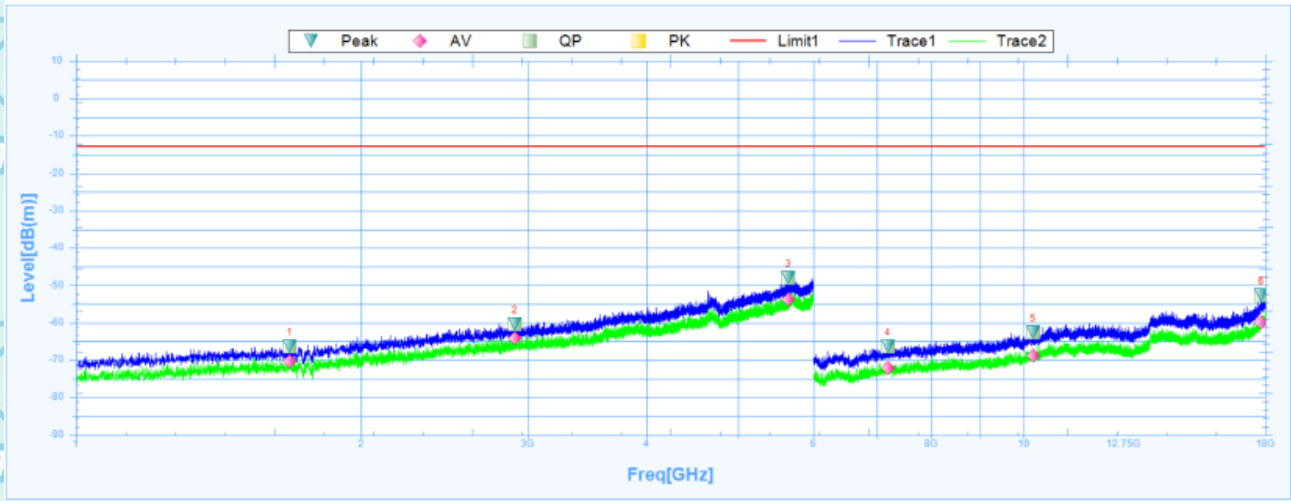

**Susputed Data List**

NO.	Freq. [MHz]	Reading [dB(m)]	Factor [dB]	Level [dB(m)]	Limit [dB]	Margin [dB]	Deg [°]	Polarity	Trace	Verdict
1	1680.6250	-66.42	24.94	-91.36	-13	-53.42	91.8	Vertical	PK	Pass
1	1680.6250	-70.22	24.94	-95.16	54	-124.22	91.8	Vertical	AV	Pass
2	2906.8750	-60.35	28.09	-88.44	-13	-47.35	14.1	Vertical	PK	Pass
2	2906.8750	-64.11	28.09	-92.2	54	-118.11	14.1	Vertical	AV	Pass
3	5646.2500	-48.12	32.23	-80.35	-13	-35.12	319	Vertical	PK	Pass
3	5646.2500	-53.8	32.23	-86.03	54	-107.8	319	Vertical	AV	Pass
4	7189.5000	-66.34	7.02	-73.36	-13	-53.34	261	Vertical	PK	Pass
4	7189.5000	-72.19	7.02	-79.21	54	-126.19	261	Vertical	AV	Pass
5	10237.5000	-62.64	13.09	-75.73	-13	-49.64	86.4	Vertical	PK	Pass
5	10237.5000	-68.8	13.09	-81.89	54	-122.8	86.4	Vertical	AV	Pass
6	17817.0000	-52.6	22.73	-75.33	-13	-39.6	252.6	Vertical	PK	Pass
6	17817.0000	-59.97	22.73	-82.7	54	-113.97	252.6	Vertical	AV	Pass



Report No.: WSCT-ANAB-R&E250400022A-RF  
Band 5:  
Horizontal:

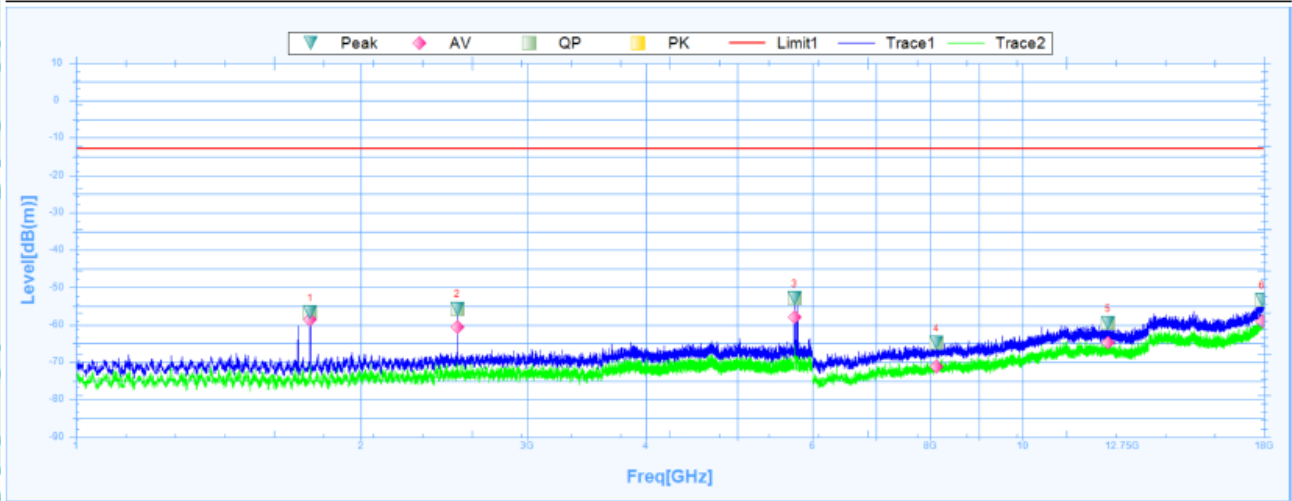

Suspected Data List										
NO.	Freq. [MHz]	Reading [dB(m)]	Factor [dB]	Level [dB(m)]	Limit [dB]	Margin [dB]	Deg [°]	Polarity	Trace	Verdict
1	1768.1250	-56.6	24.98	-81.58	-13	-43.6	304.7	Horizontal	PK	Pass
1	1768.1250	-58.62	24.98	-83.6	54	-112.62	304.7	Horizontal	AV	Pass
2	2528.7500	-55.64	27.63	-83.27	-13	-42.64	36.9	Horizontal	PK	Pass
2	2528.7500	-60.52	27.63	-88.15	54	-114.52	36.9	Horizontal	AV	Pass
3	5743.7500	-52.9	32.39	-85.29	-13	-39.9	182.7	Horizontal	PK	Pass
3	5743.7500	-57.9	32.39	-90.29	54	-111.9	182.7	Horizontal	AV	Pass
4	8115.0000	-64.76	8.53	-73.29	-13	-51.76	261.1	Horizontal	PK	Pass
4	8115.0000	-71.24	8.53	-79.77	54	-125.24	261.1	Horizontal	AV	Pass
5	12315.0000	-59.56	16.47	-76.03	-13	-46.56	312.6	Horizontal	PK	Pass
5	12315.0000	-64.73	16.47	-81.2	54	-118.73	312.6	Horizontal	AV	Pass
6	17908.5000	-53.34	23.32	-76.66	-13	-40.34	360.1	Horizontal	PK	Pass
6	17908.5000	-59.12	23.32	-82.44	54	-113.12	360.1	Horizontal	AV	Pass



Report No.: WSCT-ANAB-R&E250400022A-RF

Vertical:

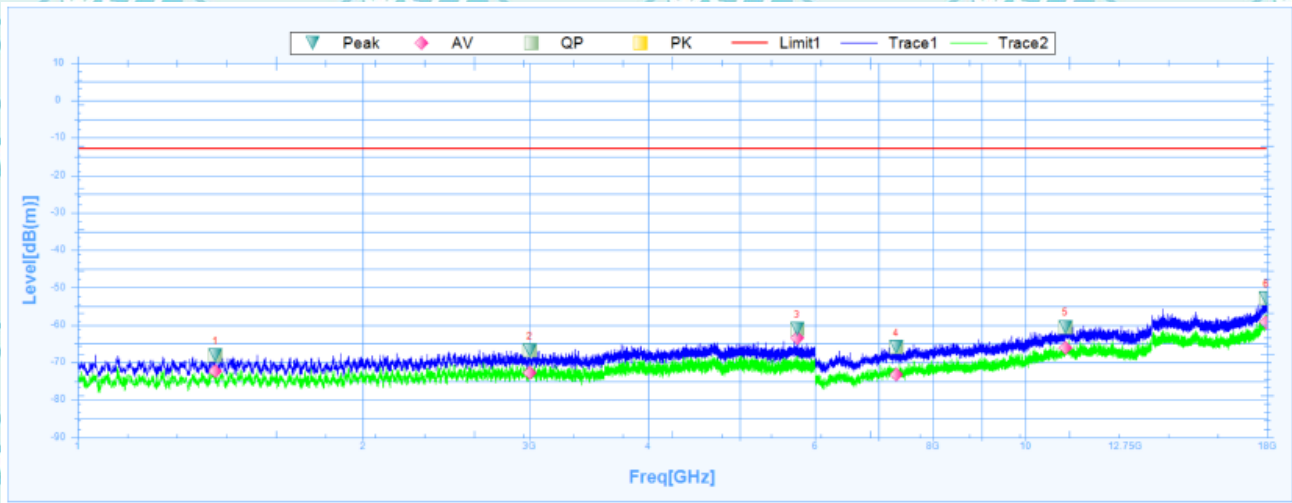

**Suspected Data List**

NO.	Freq. [MHz]	Reading [dB(m)]	Factor [dB]	Level [dB(m)]	Limit [dB]	Margin [dB]	Deg [°]	Polarity	Trace	Verdict
1	1397.5000	-68.2	25.09	-93.29	-13	-55.2	359.4	Vertical	PK	Pass
1	1397.5000	-72.29	25.09	-97.38	54	-126.29	359.4	Vertical	AV	Pass
2	3000.6250	-66.74	28.2	-94.94	-13	-53.74	248.3	Vertical	PK	Pass
2	3000.6250	-72.84	28.2	-101.04	54	-126.84	248.3	Vertical	AV	Pass
3	5744.3750	-61.14	32.39	-93.53	-13	-48.14	35.5	Vertical	PK	Pass
3	5744.3750	-63.55	32.39	-95.94	54	-117.55	35.5	Vertical	AV	Pass
4	7306.5000	-65.84	6.86	-72.7	-13	-52.84	164.3	Vertical	PK	Pass
4	7306.5000	-73.12	6.86	-79.98	54	-127.12	164.3	Vertical	AV	Pass
5	11017.5000	-60.5	15.67	-76.17	-13	-47.5	249.2	Vertical	PK	Pass
5	11017.5000	-66.22	15.67	-81.89	54	-120.22	249.2	Vertical	AV	Pass
6	17952.0000	-52.84	23.59	-76.43	-13	-39.84	351.2	Vertical	PK	Pass
6	17952.0000	-59.31	23.59	-82.9	54	-113.31	351.2	Vertical	AV	Pass



Report No.: WSCT-ANAB-R&E250400022A-RF

**E-UTRA BANDS**

Band 2:

Horizontal:

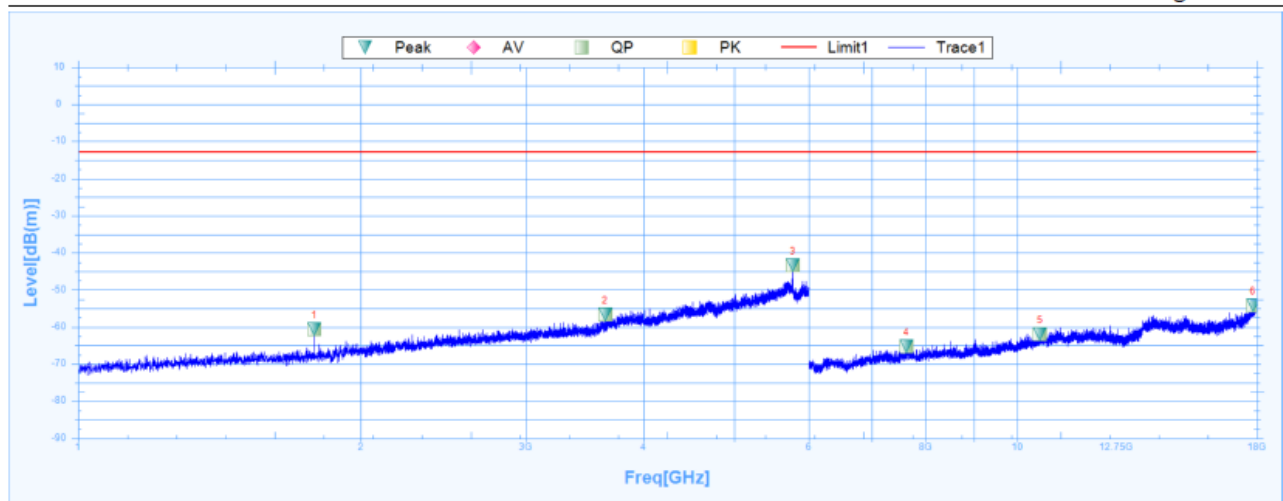

**Susputed Data List**

NO.	Freq. [MHz]	Reading [dB(m)]	Factor [dB]	Level [dB(m)]	Limit [dB]	Margin [dB]	Deg [°]	Polarity	Trace	Verdict
1	1784.3750	-60.61	24.99	-85.6	-13	-47.61	355.8	Horizontal	PK	Pass
1	1784.3750		24.99		54		355.8	Horizontal	AV	Pass
2	3642.5000	-56.68	28.84	-85.52	-13	-43.68	292.6	Horizontal	PK	Pass
2	3642.5000		28.84		54		292.6	Horizontal	AV	Pass
3	5771.2500	-43.36	32.43	-75.79	-13	-30.36	8.9	Horizontal	PK	Pass
3	5771.2500		32.43		54		8.9	Horizontal	AV	Pass
4	7624.5000	-65.24	7.96	-73.2	-13	-52.24	0.6	Horizontal	PK	Pass
4	7624.5000		7.96		54		0.6	Horizontal	AV	Pass
5	10582.5000	-61.86	14.26	-76.12	-13	-48.86	80.6	Horizontal	PK	Pass
5	10582.5000		14.26		54		80.6	Horizontal	AV	Pass
6	17830.5000	-54.25	22.81	-77.06	-13	-41.25	41.1	Horizontal	PK	Pass
6	17830.5000		22.81		54		41.1	Horizontal	AV	Pass



Report No.: WSCT-ANAB-R&E250400022A-RF

Vertical:

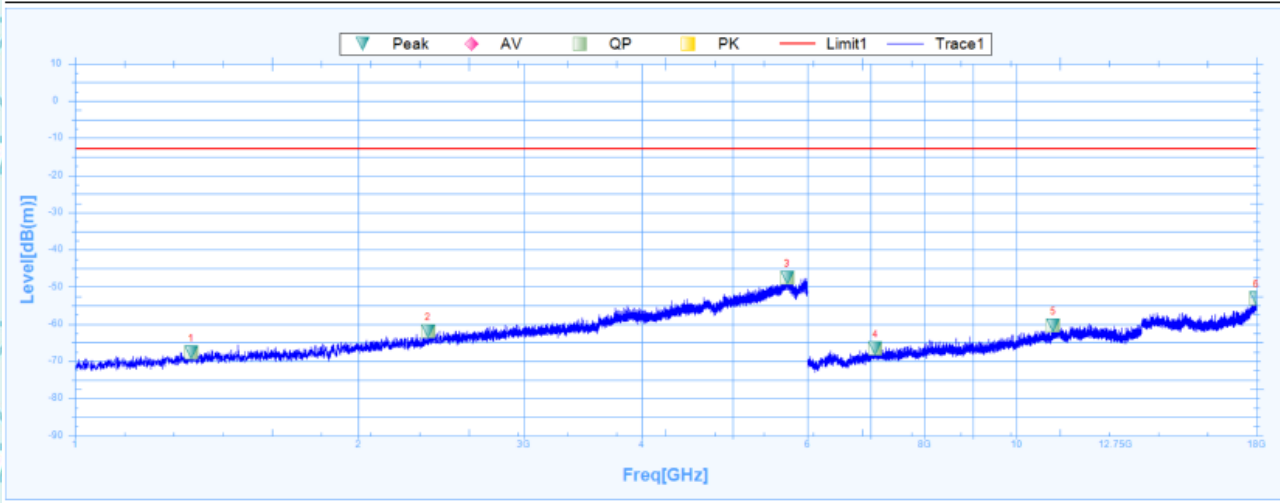

**Suspected Data List**

NO.	Freq. [MHz]	Reading [dB(m)]	Factor [dB]	Level [dB(m)]	Limit [dB]	Margin [dB]	Deg [°]	Polarity	Trace	Verdict
1	1328.1250	-67.67	-0.37	-67.3	-13	-54.67	61.8	Vertical	PK	Pass
1	1328.1250		-0.37		54		61.8	Vertical	AV	Pass
2	2373.1250	-61.95	5.85	-67.8	-13	-48.95	175.5	Vertical	PK	Pass
2	2373.1250		5.85		54		175.5	Vertical	AV	Pass
3	5709.3750	-47.61	23.48	-71.09	-13	-34.61	359	Vertical	PK	Pass
3	5709.3750		23.48		54		359	Vertical	AV	Pass
4	7086.0000	-66.67	35.63	-102.3	-13	-53.67	85.4	Vertical	PK	Pass
4	7086.0000		35.63		54		85.4	Vertical	AV	Pass
5	10948.5000	-60.42	39.43	-99.85	-13	-47.42	332.8	Vertical	PK	Pass
5	10948.5000		39.43		54		332.8	Vertical	AV	Pass
6	17989.5000	-53.16	46.43	-99.59	-13	-40.16	222.8	Vertical	PK	Pass
6	17989.5000		46.43		54		222.8	Vertical	AV	Pass



Report No.: WSCT-ANAB-R&E250400022A-RF  
Band 4:  
Horizontal:

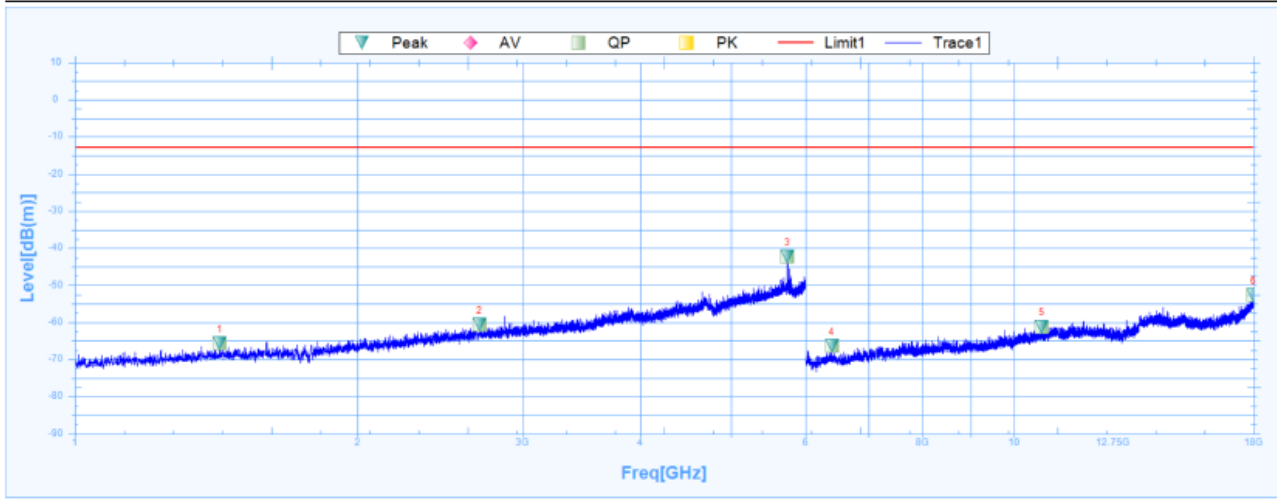

Suspected Data List										
NO.	Freq. [MHz]	Reading [dB(m)]	Factor [dB]	Level [dB(m)]	Limit [dB]	Margin [dB]	Deg [°]	Polarity	Trace	Verdict
1	1426.2500	-65.68	0.17	-65.85	-13	-52.68	329.7	Horizontal	PK	Pass
1	1426.2500		0.17		54		329.7	Horizontal	AV	Pass
2	2697.5000	-60.6	7.41	-68.01	-13	-47.6	94.2	Horizontal	PK	Pass
2	2697.5000		7.41		54		94.2	Horizontal	AV	Pass
3	5740.6250	-42.33	23.09	-65.42	-13	-29.33	23.7	Horizontal	PK	Pass
3	5740.6250		23.09		54		23.7	Horizontal	AV	Pass
4	6399.0000	-66.41	33.88	-100.29	-13	-53.41	40	Horizontal	PK	Pass
4	6399.0000		33.88		54		40	Horizontal	AV	Pass
5	10708.5000	-61.17	39.09	-100.26	-13	-48.17	115.3	Horizontal	PK	Pass
5	10708.5000		39.09		54		115.3	Horizontal	AV	Pass
6	17997.0000	-52.75	46.48	-99.23	-13	-39.75	345.9	Horizontal	PK	Pass
6	17997.0000		46.48		54		345.9	Horizontal	AV	Pass



Report No.: WSCT-ANAB-R&E250400022A-RF  
Vertical:

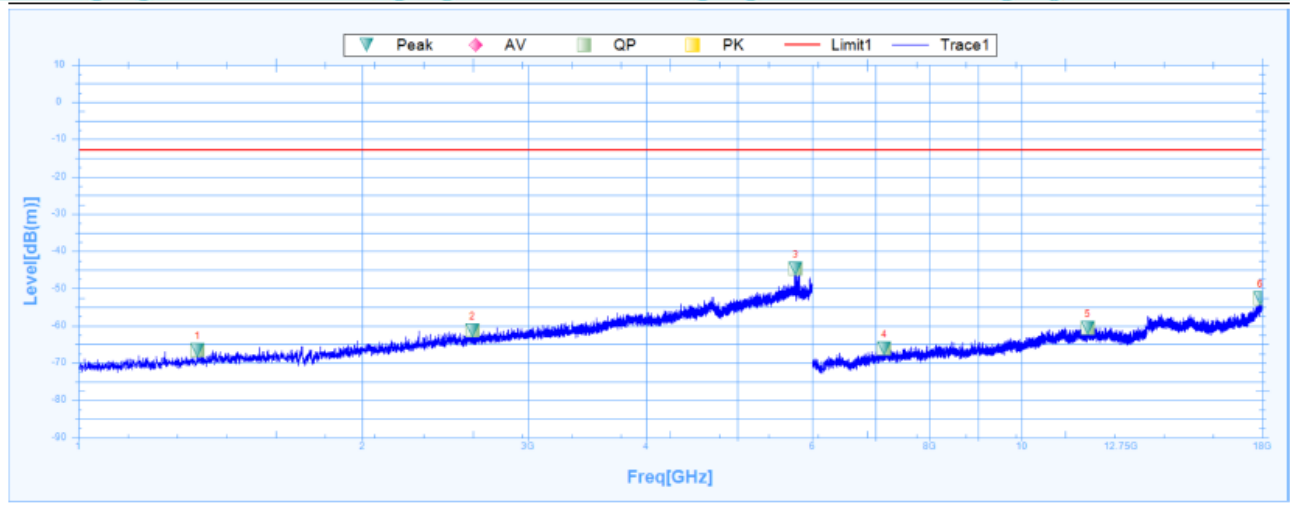

**Susputed Data List**

NO.	Freq. [MHz]	Reading [dB(m)]	Factor [dB]	Level [dB(m)]	Limit [dB]	Margin [dB]	Deg [°]	Polarity	Trace	Verdict
1	1337.5000	-66.66	-0.29	-66.37	-13	-53.66	330.7	Vertical	PK	Pass
1	1337.5000		-0.29		54		330.7	Vertical	AV	Pass
2	2618.1250	-61.34	7.07	-68.41	-13	-48.34	128.7	Vertical	PK	Pass
2	2618.1250		7.07		54		128.7	Vertical	AV	Pass
3	5763.1250	-44.81	22.76	-67.57	-13	-31.81	236.3	Vertical	PK	Pass
3	5763.1250		22.76		54		236.3	Vertical	AV	Pass
4	7155.0000	-66.21	35.73	-101.94	-13	-53.21	1.4	Vertical	PK	Pass
4	7155.0000		35.73		54		1.4	Vertical	AV	Pass
5	11758.5000	-60.65	38.82	-99.47	-13	-47.65	270.6	Vertical	PK	Pass
5	11758.5000		38.82		54		270.6	Vertical	AV	Pass
6	17920.5000	-52.72	45.97	-98.69	-13	-39.72	135.5	Vertical	PK	Pass
6	17920.5000		45.97		54		135.5	Vertical	AV	Pass



Report No.: WSCT-ANAB-R&E250400022A-RF

Band 5:  
Horizontal:

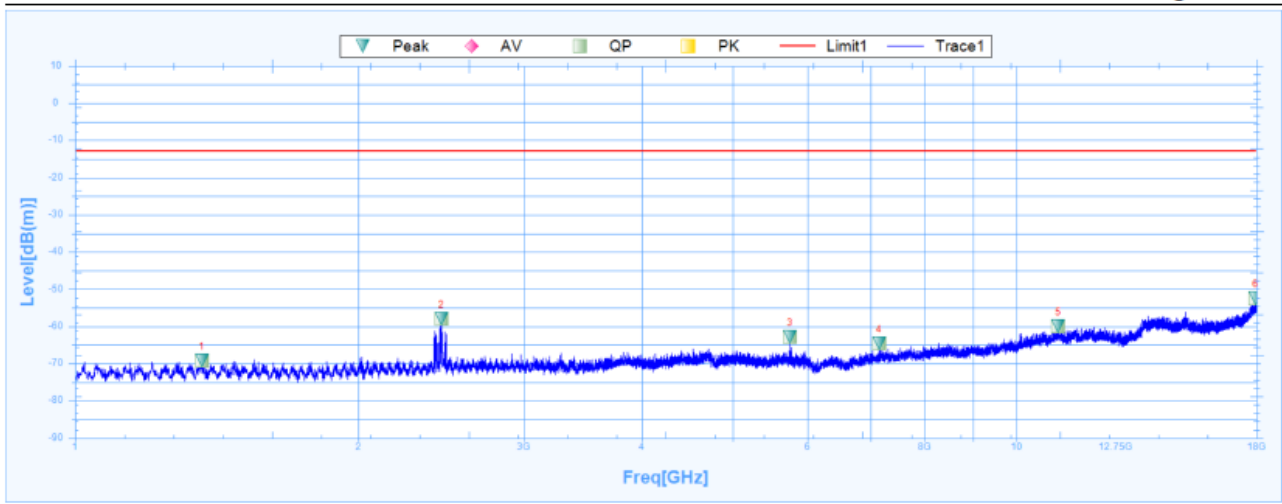

Suspected Data List										
NO.	Freq. [MHz]	Reading [dB(m)]	Factor [dB]	Level [dB(m)]	Limit [dB]	Margin [dB]	Deg [°]	Polarity	Trace	Verdict
1	1363.1250	-69.33	-0.03	-69.3	-13	-56.33	175.4	Horizontal	PK	Pass
1	1363.1250		-0.03		54		175.4	Horizontal	AV	Pass
2	2450.6250	-58	6.29	-64.29	-13	-45	353.4	Horizontal	PK	Pass
2	2450.6250		6.29		54		353.4	Horizontal	AV	Pass
3	5750.0000	-62.81	22.95	-85.76	-13	-49.81	87	Horizontal	PK	Pass
3	5750.0000		22.95		54		87	Horizontal	AV	Pass
4	7149.0000	-64.67	35.72	-100.39	-13	-51.67	322.1	Horizontal	PK	Pass
4	7149.0000		35.72		54		322.1	Horizontal	AV	Pass
5	11082.0000	-59.94	39.43	-99.37	-13	-46.94	8	Horizontal	PK	Pass
5	11082.0000		39.43		54		8	Horizontal	AV	Pass
6	17950.5000	-52.4	46.17	-98.57	-13	-39.4	287.4	Horizontal	PK	Pass
6	17950.5000		46.17		54		287.4	Horizontal	AV	Pass



Report No.: WSCT-ANAB-R&E250400022A-RF

Vertical:

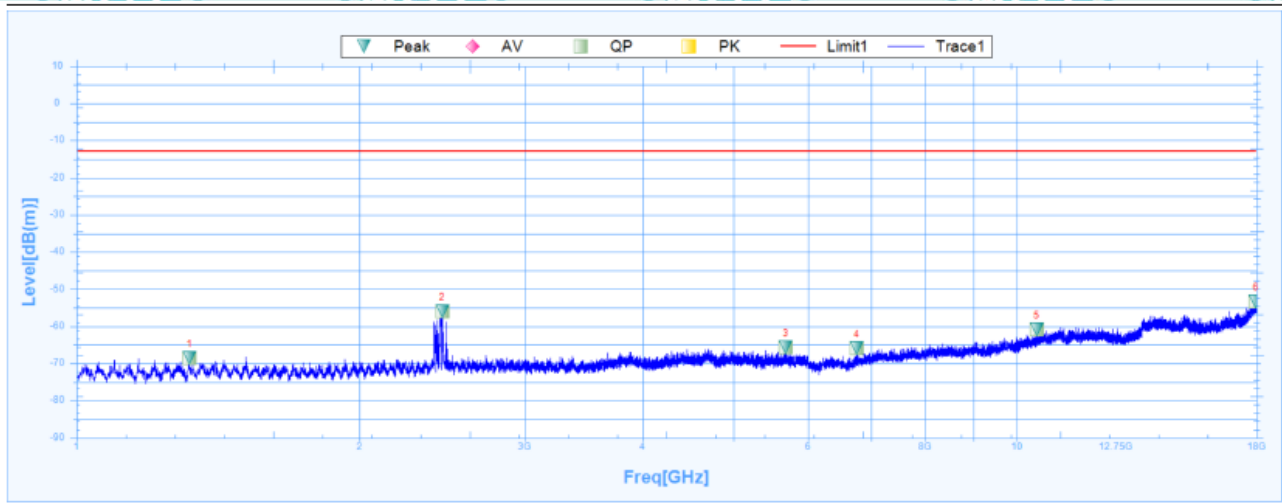

**Susputed Data List**

NO.	Freq. [MHz]	Reading [dB(m)]	Factor [dB]	Level [dB(m)]	Limit [dB]	Margin [dB]	Deg [°]	Polarity	Trace	Verdict
1	1318.7500	-68.64	-0.45	-68.19	-13	-55.64	85.7	Vertical	PK	Pass
1	1318.7500		-0.45		54		85.7	Vertical	AV	Pass
2	2448.7500	-56.07	6.28	-62.35	-13	-43.07	155	Vertical	PK	Pass
2	2448.7500		6.28		54		155	Vertical	AV	Pass
3	5683.1250	-65.64	23.2	-88.84	-13	-52.64	35.5	Vertical	PK	Pass
3	5683.1250		23.2		54		35.5	Vertical	AV	Pass
4	6762.0000	-65.88	34.86	-100.74	-13	-52.88	152.2	Vertical	PK	Pass
4	6762.0000		34.86		54		152.2	Vertical	AV	Pass
5	10507.5000	-60.88	38.81	-99.69	-13	-47.88	47.1	Vertical	PK	Pass
5	10507.5000		38.81		54		47.1	Vertical	AV	Pass
6	17967.0000	-53.37	46.28	-99.65	-13	-40.37	318.5	Vertical	PK	Pass
6	17967.0000		46.28		54		318.5	Vertical	AV	Pass



Report No.: WSCT-ANAB-R&E250400022A-RF  
Band 7:  
Horizontal:

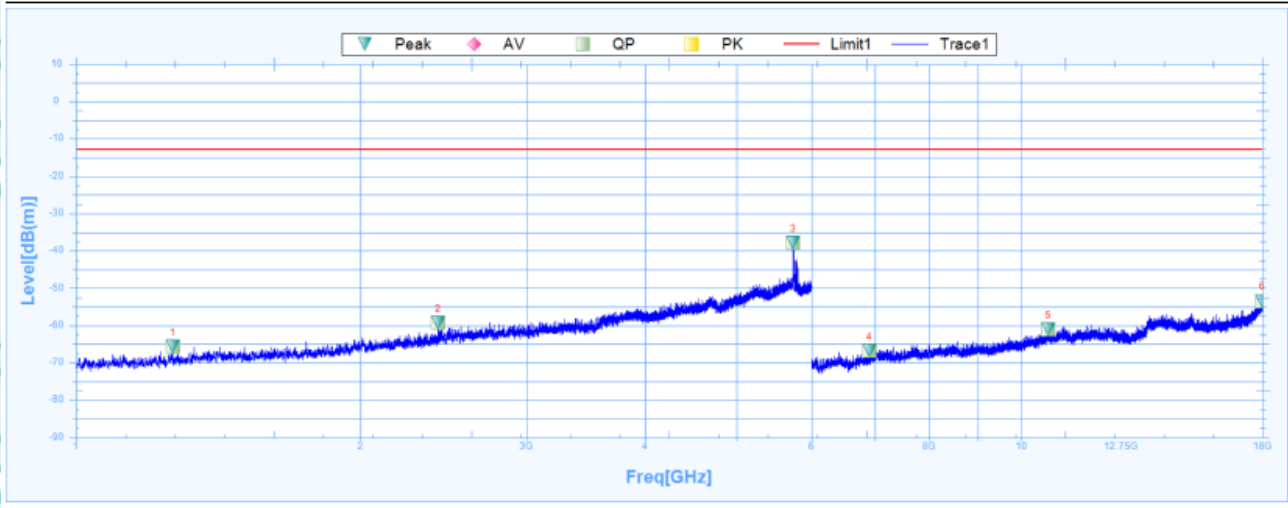

Suspected Data List											
NO.	Freq. [MHz]	Reading [dB(m)]	Factor [dB]	Level [dB(m)]	Limit [dB]	Margin [dB]	Deg [°]	Polarity	Trace	Verdict	
1	1266.8750	-65.65	24.63	-90.28	-13	-52.65	358	Horizontal	PK	Pass	
1	1266.8750		24.63		54		358	Horizontal	AV	Pass	
2	2417.5000	-59.39	27.32	-86.71	-13	-46.39	39.3	Horizontal	PK	Pass	
2	2417.5000		27.32		54		39.3	Horizontal	AV	Pass	
3	5738.1250	-37.92	32.38	-70.3	-13	-24.92	297.5	Horizontal	PK	Pass	
3	5738.1250		32.38		54		297.5	Horizontal	AV	Pass	
4	6912.0000	-66.86	35.26	-102.12	-13	-53.86	0.6	Horizontal	PK	Pass	
4	6912.0000		35.26		54		0.6	Horizontal	AV	Pass	
5	10683.0000	-60.99	39.06	-100.05	-13	-47.99	336.5	Horizontal	PK	Pass	
5	10683.0000		39.06		54		336.5	Horizontal	AV	Pass	
6	17985.0000	-53.44	46.4	-99.84	-13	-40.44	1.1	Horizontal	PK	Pass	
6	17985.0000		46.4		54		1.1	Horizontal	AV	Pass	



Report No.: WSCT-ANAB-R&E250400022A-RF

Vertical:

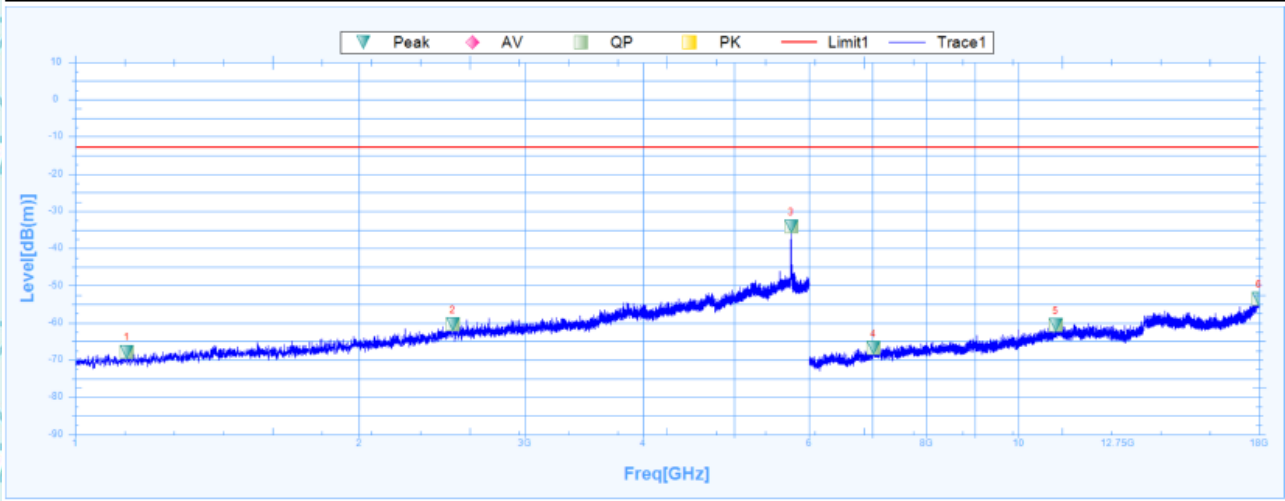

Suspected Data List

NO.	Freq. [MHz]	Reading [dB(m)]	Factor [dB]	Level [dB(m)]	Limit [dB]	Margin [dB]	Deg [°]	Polarity	Trace	Verdict
1	1134.3750	-67.8	24.37	-92.17	-13	-54.8	336.7	Vertical	PK	Pass
1	1134.3750		24.37		54		336.7	Vertical	AV	Pass
2	2514.3750	-60.36	27.62	-87.98	-13	-47.36	185	Vertical	PK	Pass
2	2514.3750		27.62		54		185	Vertical	AV	Pass
3	5745.0000	-34.12	32.39	-66.51	-13	-21.12	345.8	Vertical	PK	Pass
3	5745.0000		32.39		54		345.8	Vertical	AV	Pass
4	7020.0000	-66.89	35.53	-102.42	-13	-53.89	1.2	Vertical	PK	Pass
4	7020.0000		35.53		54		1.2	Vertical	AV	Pass
5	10956.0000	-60.56	39.44	-100	-13	-47.56	360.1	Vertical	PK	Pass
5	10956.0000		39.44		54		360.1	Vertical	AV	Pass
6	17994.0000	-53.48	46.46	-99.94	-13	-40.48	10.6	Vertical	PK	Pass
6	17994.0000		46.46		54		10.6	Vertical	AV	Pass



Report No.: WSCT-ANAB-R&E250400022A-RF

Band 12:  
Horizontal:

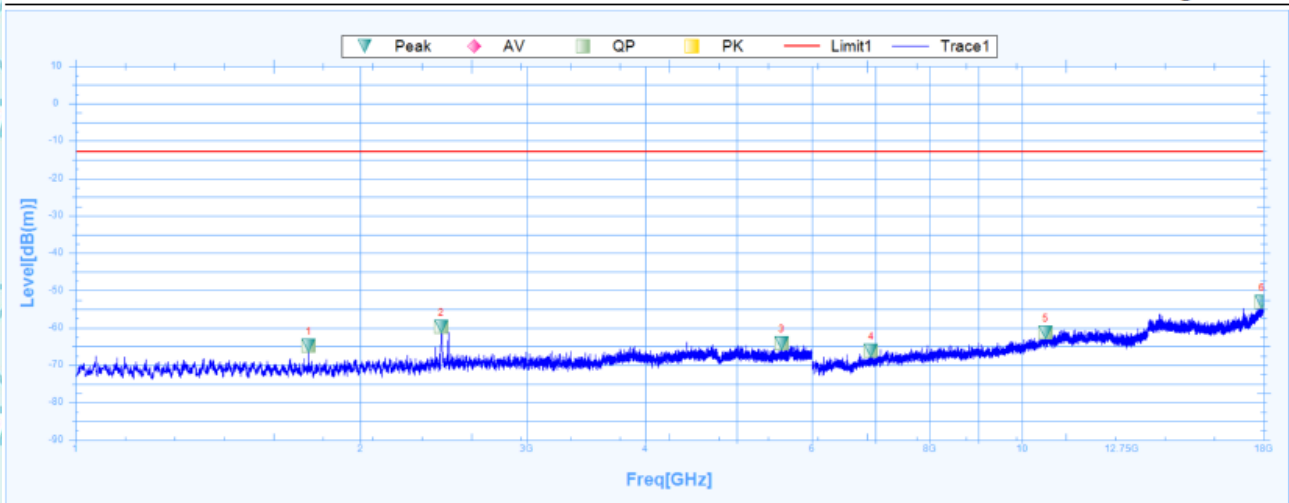

**Susputed Data List**

NO.	Freq. [MHz]	Reading [dB(m)]	Factor [dB]	Level [dB(m)]	Limit [dB]	Margin [dB]	Deg [°]	Polarity	Trace	Verdict
1	1763.7500	-64.79	24.98	-89.77	-13	-51.79	-0.1	Horizontal	PK	Pass
1	1763.7500		24.98		54		-0.1	Horizontal	AV	Pass
2	2435.6250	-59.71	27.38	-87.09	-13	-46.71	6.2	Horizontal	PK	Pass
2	2435.6250		27.38		54		6.2	Horizontal	AV	Pass
3	5575.6250	-64.05	32.12	-96.17	-13	-51.05	16.4	Horizontal	PK	Pass
3	5575.6250		32.12		54		16.4	Horizontal	AV	Pass
4	6931.5000	-66.22	35.32	-101.54	-13	-53.22	73.4	Horizontal	PK	Pass
4	6931.5000		35.32		54		73.4	Horizontal	AV	Pass
5	10594.5000	-61.18	38.93	-100.11	-13	-48.18	315	Horizontal	PK	Pass
5	10594.5000		38.93		54		315	Horizontal	AV	Pass
6	17929.5000	-53.05	46.03	-99.08	-13	-40.05	360.1	Horizontal	PK	Pass
6	17929.5000		46.03		54		360.1	Horizontal	AV	Pass



Report No.: WSCT-ANAB-R&E250400022A-RF

Vertical:

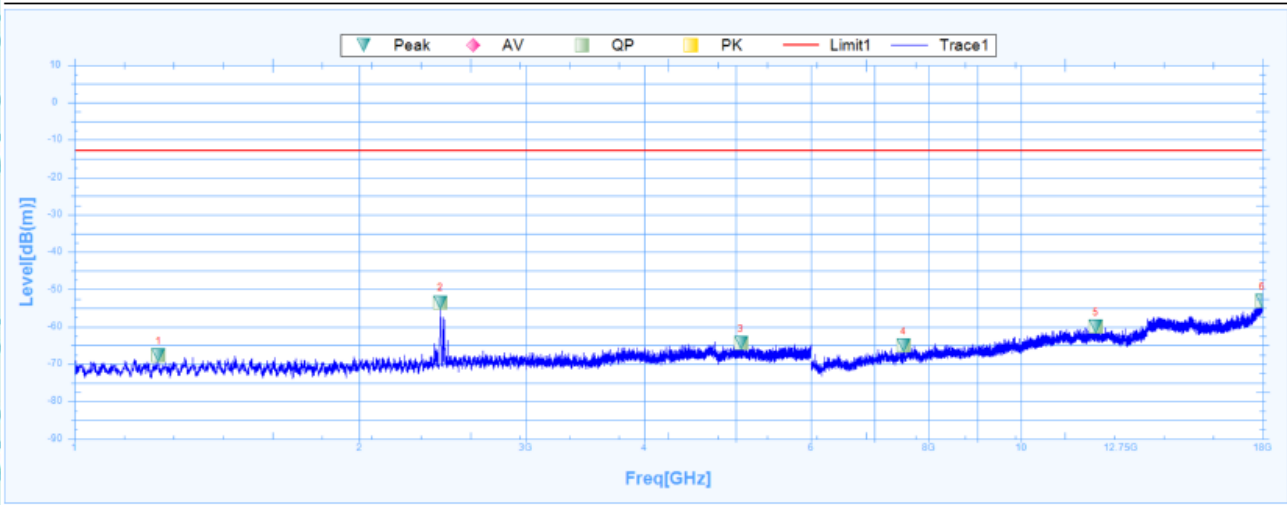

Suspected Data List										
NO.	Freq. [MHz]	Reading [dB(m)]	Factor [dB]	Level [dB(m)]	Limit [dB]	Margin [dB]	Deg [°]	Polarity	Trace	Verdict
1	1227.5000	-67.74	24.5	-92.24	-13	-54.74	159.9	Vertical	PK	Pass
1	1227.5000		24.5		54		159.9	Vertical	AV	Pass
2	2436.2500	-53.43	27.38	-80.81	-13	-40.43	43.9	Vertical	PK	Pass
2	2436.2500		27.38		54		43.9	Vertical	AV	Pass
3	5060.6250	-64.47	31.65	-96.12	-13	-51.47	244.8	Vertical	PK	Pass
3	5060.6250		31.65		54		244.8	Vertical	AV	Pass
4	7515.0000	-65	36.27	-101.27	-13	-52	0.8	Vertical	PK	Pass
4	7515.0000		36.27		54		0.8	Vertical	AV	Pass
5	12001.5000	-59.97	38.6	-98.57	-13	-46.97	15	Vertical	PK	Pass
5	12001.5000		38.6		54		15	Vertical	AV	Pass
6	17986.5000	-53.19	46.41	-99.6	-13	-40.19	12.2	Vertical	PK	Pass
6	17986.5000		46.41		54		12.2	Vertical	AV	Pass



Report No.: WSCT-ANAB-R&E250400022A-RF

Band 41:  
Horizontal:

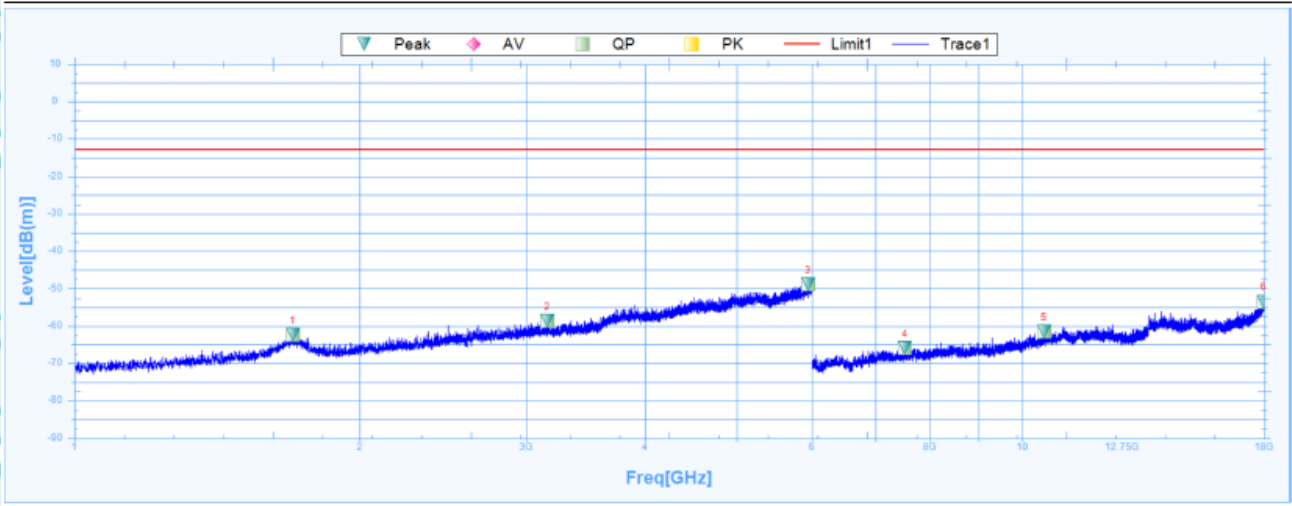

**Susputed Data List**

NO.	Freq. [MHz]	Reading [dB(m)]	Factor [dB]	Level [dB(m)]	Limit [dB]	Margin [dB]	Deg [°]	Polarity	Trace	Verdict
1	1699.3750	-62.37	24.95	-87.32	-13	-49.37	27.2	Horizontal	PK	Pass
1	1699.3750		24.95		54		27.2	Horizontal	AV	Pass
2	3155.0000	-58.68	28.29	-86.97	-13	-45.68	27.2	Horizontal	PK	Pass
2	3155.0000		28.29		54		27.2	Horizontal	AV	Pass
3	5946.8750	-48.95	32.71	-81.66	-13	-35.95	-0.1	Horizontal	PK	Pass
3	5946.8750		32.71		54		-0.1	Horizontal	AV	Pass
4	7524.0000	-65.83	36.29	-102.12	-13	-52.83	334	Horizontal	PK	Pass
4	7524.0000		36.29		54		334	Horizontal	AV	Pass
5	10545.0000	-61.42	38.86	-100.28	-13	-48.42	129.6	Horizontal	PK	Pass
5	10545.0000		38.86		54		129.6	Horizontal	AV	Pass
6	17977.5000	-53.43	46.35	-99.78	-13	-40.43	301.8	Horizontal	PK	Pass
6	17977.5000		46.35		54		301.8	Horizontal	AV	Pass



Report No.: WSCT-ANAB-R&E250400022A-RF

Vertical:

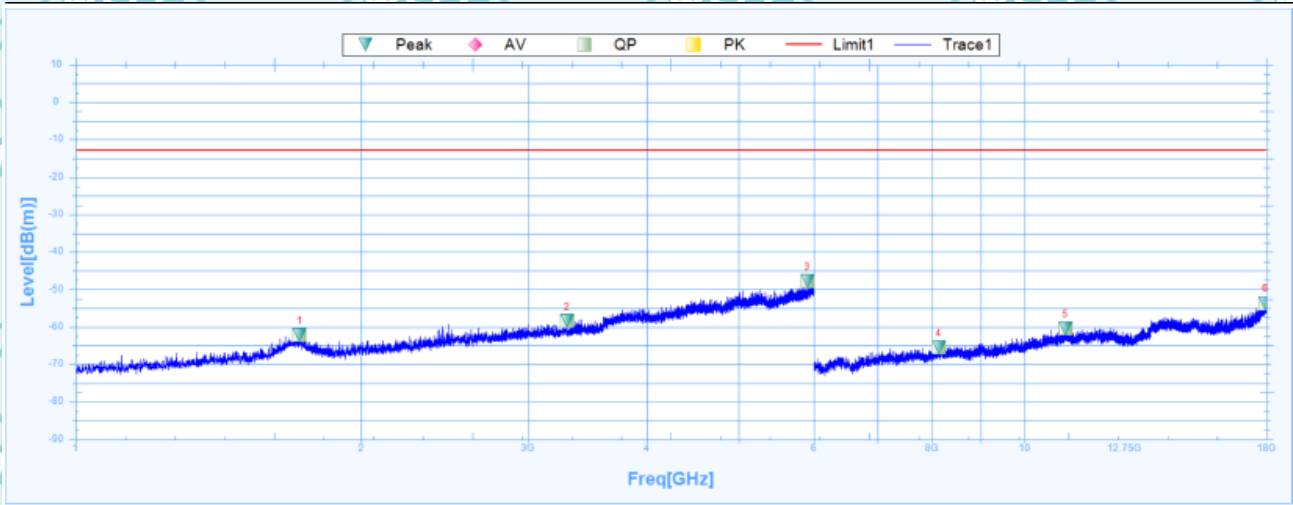

**Susputed Data List**

NO.	Freq. [MHz]	Reading [dB(m)]	Factor [dB]	Level [dB(m)]	Limit [dB]	Margin [dB]	Deg [°]	Polarity	Trace	Verdict
1	1723.1250	-62.26	24.96	-87.22	-13	-49.26	359.6	Vertical	PK	Pass
1	1723.1250		24.96		54		359.6	Vertical	AV	Pass
2	3296.8750	-58.43	28.38	-86.81	-13	-45.43	-0.1	Vertical	PK	Pass
2	3296.8750		28.38		54		-0.1	Vertical	AV	Pass
3	5906.8750	-47.88	32.65	-80.53	-13	-34.88	225.6	Vertical	PK	Pass
3	5906.8750		32.65		54		225.6	Vertical	AV	Pass
4	8122.5000	-65.46	37.05	-102.51	-13	-52.46	318.6	Vertical	PK	Pass
4	8122.5000		37.05		54		318.6	Vertical	AV	Pass
5	11044.5000	-60.36	39.46	-99.82	-13	-47.36	239.7	Vertical	PK	Pass
5	11044.5000		39.46		54		239.7	Vertical	AV	Pass
6	17941.5000	-53.65	46.11	-99.76	-13	-40.65	67.5	Vertical	PK	Pass
6	17941.5000		46.11		54		67.5	Vertical	AV	Pass



## 9. OCCUPIED BANDWIDTH & EMISSION BANDWIDTH

### Test limit:

The occupied bandwidth (OBW), that is the frequency bandwidth such that, below its lower and above its upper frequency limits, the mean powers radiated are each equal to 0.5 percent of the total mean power radiated by a given emission, shall be measured when modulated by an input signal such that its amplitude and symbol rate represent the maximum rated conditions under which the equipment will be operated. The signal shall be applied through any filter networks, pseudo-random generators or other devices required in normal service. Additionally, the occupied bandwidth shall be shown for operation with any devices used for modifying the spectrum when such devices are optional at the discretion of the user. [i]2.1049(h)]

Many of the individual rule parts specify a relative OBW in lieu of the 99% OBW. In such cases, the OBW is defined as the width of the signal between two points, one below the carrier center frequency and one above the carrier center frequency, outside of which all emissions are attenuated by at least X dB below the transmitter power, where the value of X is typically specified as 26.

The relative OBW must be measured and reported when it is specified in the applicable rule part; otherwise, the 99% OBW shall be measured and reported. The test report shall specify which OBW is reported.

A spectrum/signal analyzer or other instrument providing a spectral display is recommended for these measurements and the video bandwidth shall be set to a value at least three times greater than the IF/resolution bandwidth to avoid any amplitude smoothing. Video filtering shall not be used during occupied bandwidth tests.

The OBW shall be measured for all operating conditions that will affect the bandwidth results (e.g. variable modulations, coding, or channel bandwidth settings). See section 4.

### Test procedure:

#### Occupied bandwidth – relative measurement procedure

The reference value is the highest level of the spectral envelope of the modulated signal.

a) The spectrum analyzer center frequency is set to the nominal EUT channel center frequency. The span range for the spectrum analyzer shall be between two and five times the anticipated OBW.

b) The nominal resolution bandwidth (RBW) shall be in the range of 1 to 5 % of the anticipated OBW, and the VBW shall be at least 3 times the RBW.

c) Set the reference level of the instrument as required to prevent the signal from exceeding the maximum input mixer level for linear operation. In general, the peak of the spectral envelope must be at least 10log (OBW / RBW) below the reference level.

d) NOTE—Steps a) through c) may require iteration to adjust within the specified tolerances.

e) The dynamic range of the spectrum analyzer at the selected RBW shall be at least 10 dB below the target “-X dB down” requirement (i.e., if the requirement calls for measuring the -26 dB OBW, the spectrum analyzer noise floor at the selected RBW shall be at least 36 dB below the reference value).

f) Set the detection mode to peak, and the trace mode to max hold.

g) Determine the reference value: Set the EUT to transmit a modulated signal. Allow the trace to stabilize. Set the spectrum analyzer marker to the highest level of the displayed trace (this is the reference value).

h) Determine the “-X dB down amplitude” as equal to (Reference Value – X). Alternatively, this calculation can be performed by the analyzer by using the marker-delta function.

Report No.: WSCT-ANAB-R&E250400022A-RF

- i) Place two markers, one at the lowest and the other at the highest frequency of the envelope of the spectral display such that each marker is at or slightly below the “-X dB down amplitude” determined in step g). If a marker is below this “-X dB down amplitude” value it shall be placed as close as possible to this value. The OBW is the positive frequency difference between the two markers.
- j) The occupied bandwidth shall be reported by providing plot(s) of the measuring instrument display. The frequency and amplitude axes and scale shall be clearly labeled. Tabular data may be reported in addition to the plot(s).  
Occupied bandwidth – power bandwidth (99%) measurement procedure  
The following procedure shall be used for measuring (99 %) power bandwidth
  - a) The spectrum analyzer center frequency is set to the nominal EUT channel center frequency. The frequency span for the spectrum analyzer shall be set wide enough to capture all modulation products including the emission skirts (i.e., two to five times the OBW).
  - b) The nominal IF filter bandwidth (3 dB RBW) shall be in the range of 1 to 5 % of the anticipated OBW, and the VBW shall be at least 3 times the RBW.
  - c) Set the reference level of the instrument as required to keep the signal from exceeding the maximum input mixer level for linear operation. In general, the peak of the spectral envelope must be at least 10log (OBW / RBW) below the reference level.
  - d) NOTE—Steps a) through c) may require iteration to adjust within the specified tolerances.
  - e) Set the detection mode to peak, and the trace mode to max hold..
  - f) Use the 99 % power bandwidth function of the spectrum analyzer (if available) and report the measured bandwidth.
  - g) If the instrument does not have a 99 % power bandwidth function, the trace data points are to be recovered and directly summed in linear power terms. The recovered amplitude data points, beginning at the lowest frequency, are placed in a running sum until 0.5 % of the total is reached; that frequency is recorded as the lower frequency. The process is repeated until 99.5 % of the total is reached; that frequency is recorded as the upper frequency. The 99 % power bandwidth is the difference between these two frequencies.
  - h) The OBW shall be reported by providing plot(s) of the measuring instrument display. The frequency and amplitude axes and scale shall be clearly labeled. Tabular data may be reported in addition to the plot(s).

**Test setup:**

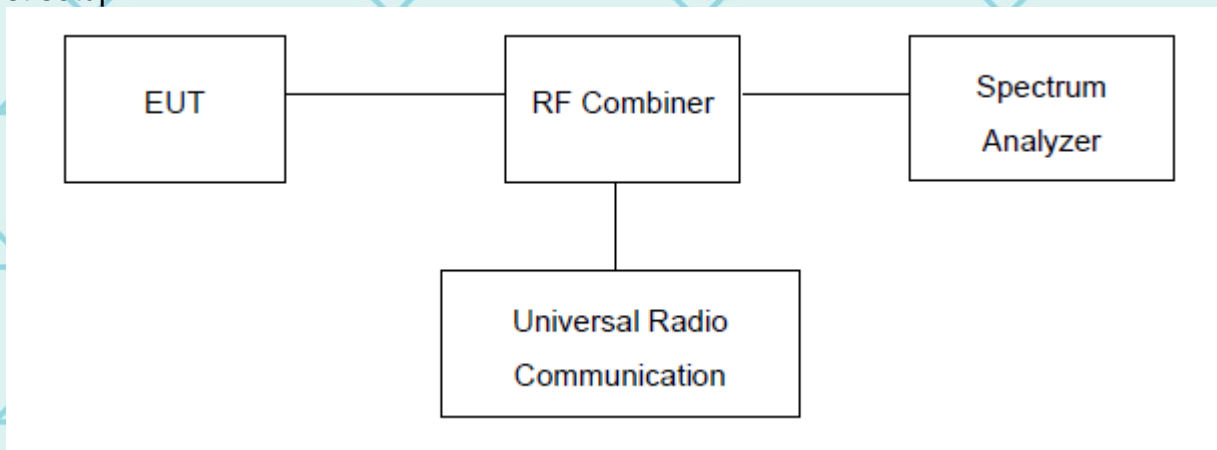

Report No.: WSCT-ANAB-R&E250400022A-RF

### 9.1. Measurement Result

#### UTRA BANDS Band 2:

Frequency	OBW(99%)	26dB BW
1850.1	4.151MHz	4.663MHz
1879.1	4.167MHz	4.679MHz
1905.1	4.167MHz	4.679MHz

#### Band 4:

Frequency	OBW(99%)	26dB BW
1710.0	4.215MHz	4.712MHz
1731.7	4.215MHz	4.696MHz
1750.2	4.199MHz	4.712MHz

#### Band 5:

Frequency	OBW(99%)	26dB BW
825.5	4.151MHz	4.679MHz
835.5	4.151MHz	4.679MHz
845.7	4.151MHz	4.683MHz



Report No.: WSCT-ANAB-R&E250400022A-RF  
Test Plot(s)

### UTRA BANDS Occupied Bandwidth (99% and -26dBc) WCDMA Band 2 CH 9262

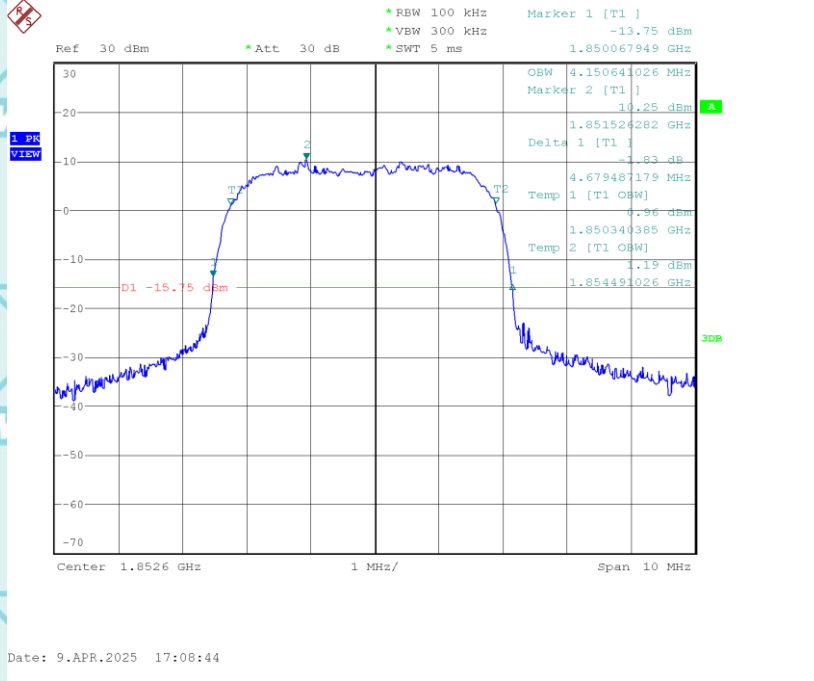

Report No.: WSCT-ANAB-R&E250400022A-RF

### Occupied Bandwidth (99%and-26dBc) WCDMA Band 2 CH 9400

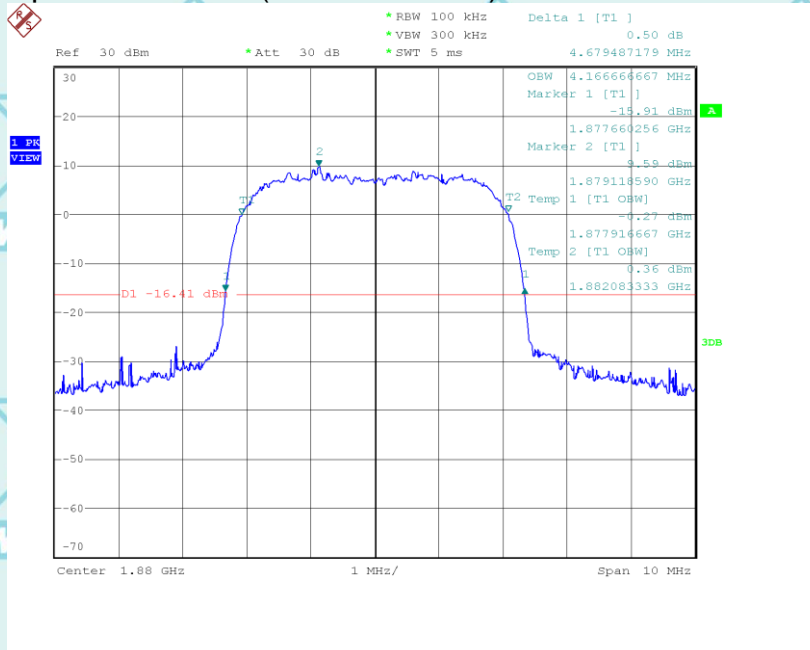

### Occupied Bandwidth (99%and-26dBc) WCDMA Band 2 CH 9538

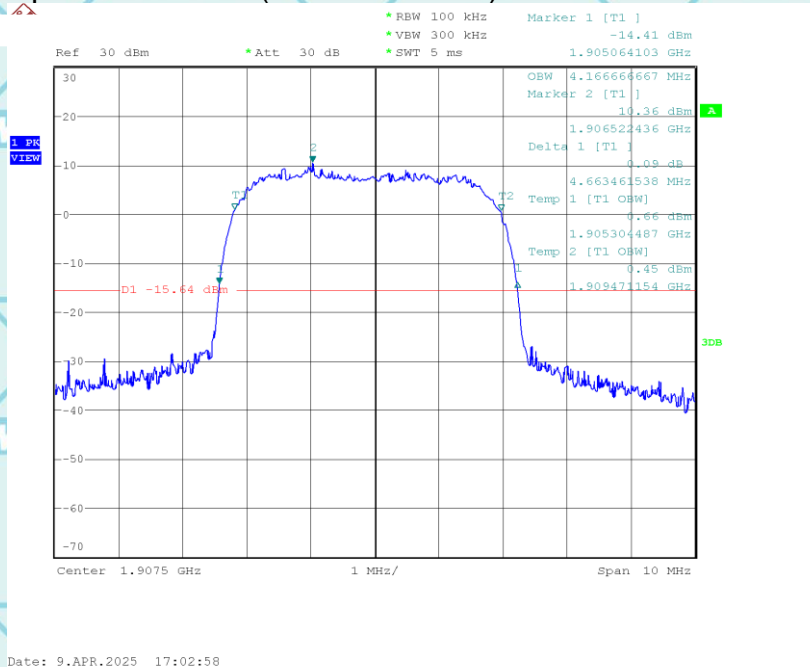

Report No.: WSCT-ANAB-R&E250400022A-RF

### Occupied Bandwidth (99% and -26dBc) WCDMA Band 4 CH 1312

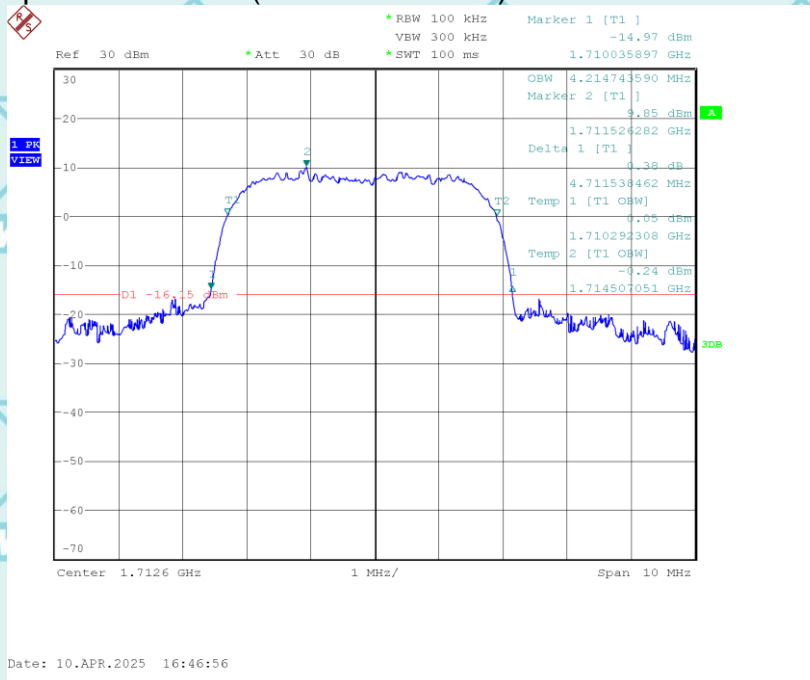

### Occupied Bandwidth (99% and -26dBc) WCDMA Band 4 CH 1413

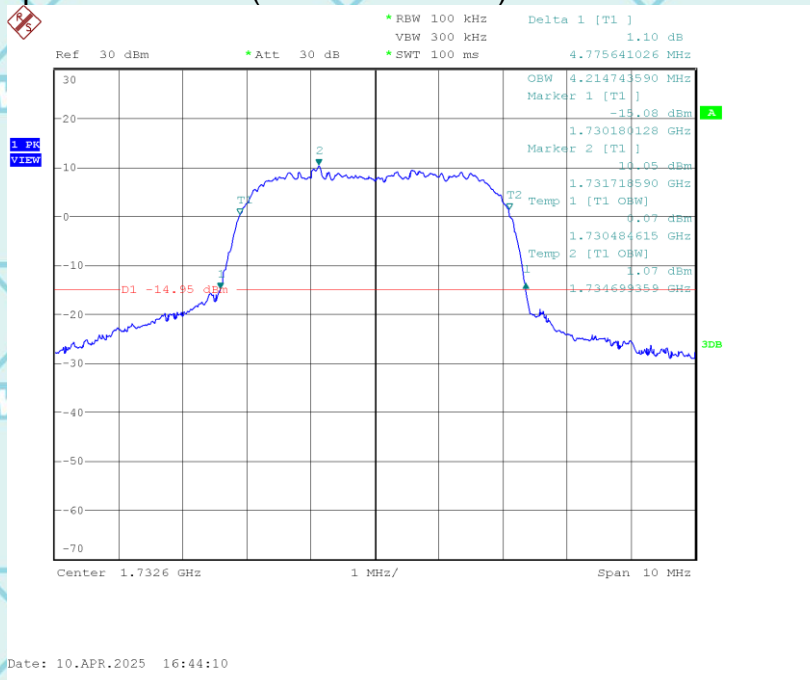

Report No.: WSCT-ANAB-R&E250400022A-RF

Occupied Bandwidth (99% and -26dBc) WCDMA Band 4 CH 1513

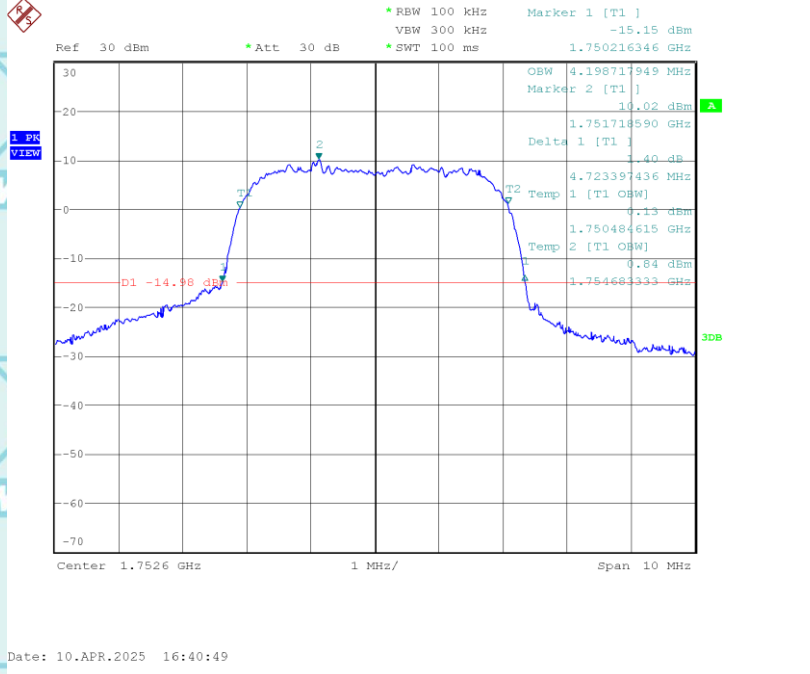

Occupied Bandwidth (99%and-26dBc) WCDMA Band 5 CH 4132

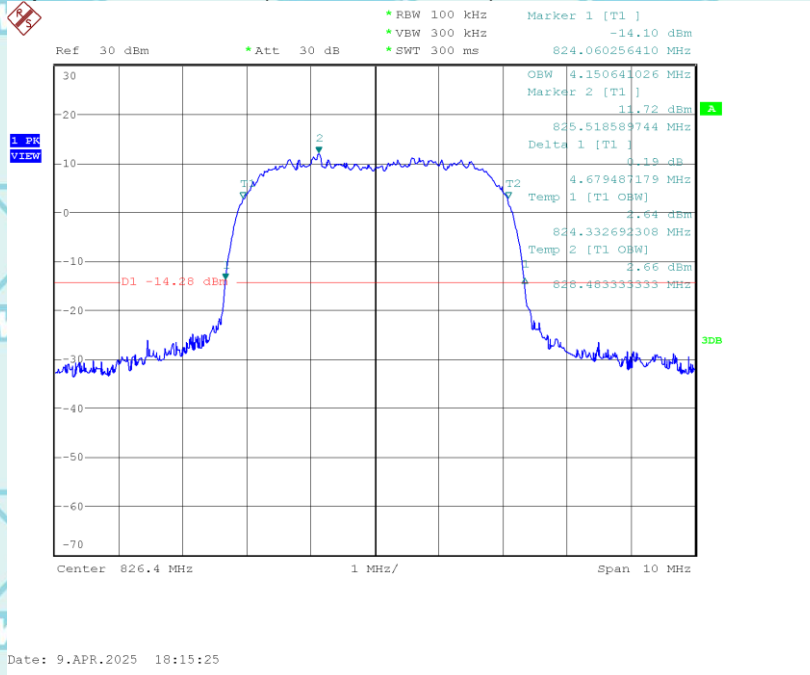

Report No.: WSCT-ANAB-R&E250400022A-RF

Occupied Bandwidth (99%and-26dBc) WCDMA Band 5 CH 4182

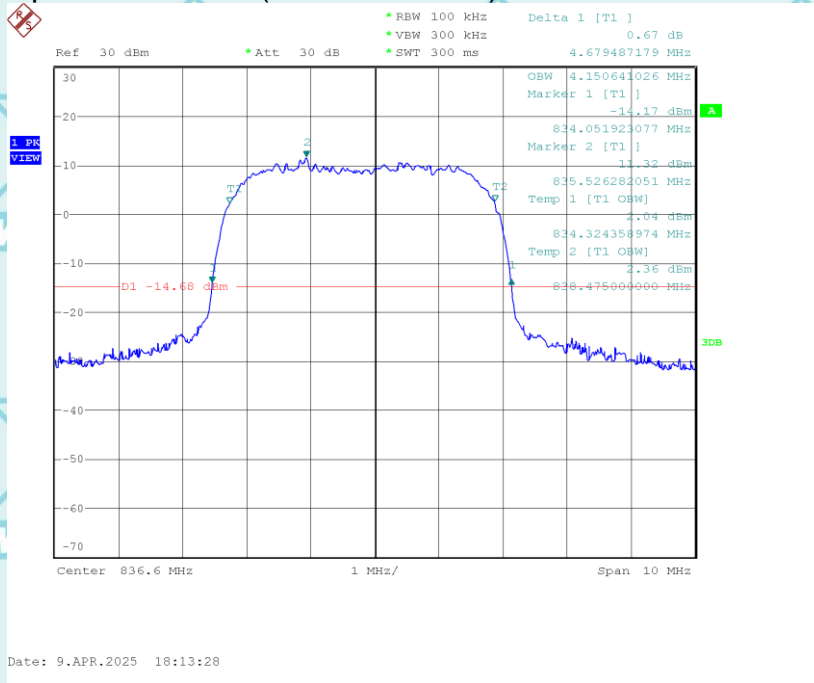

Occupied Bandwidth (99%and-26dBc) WCDMA Band 5 CH 4233

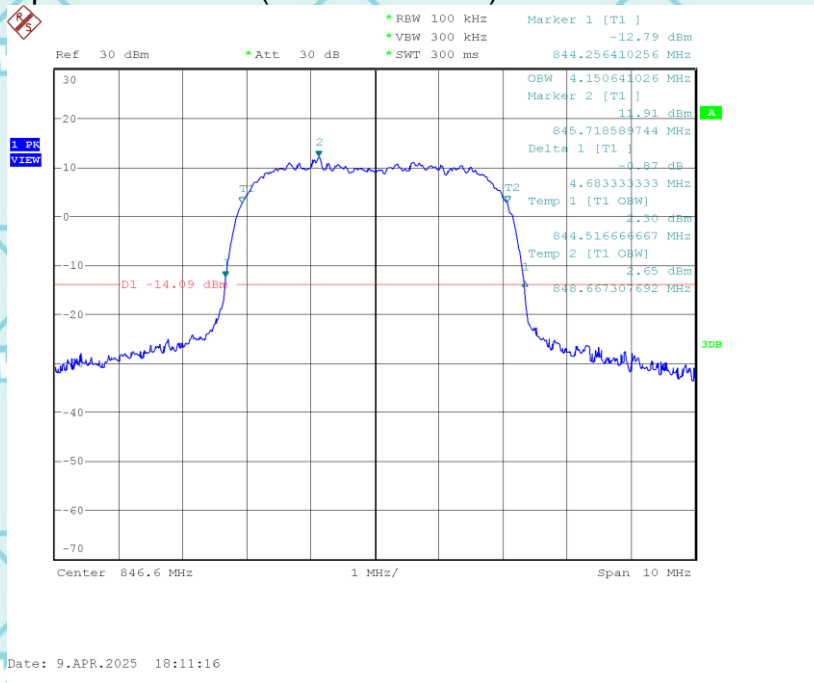

Note: Please refer to Annex (LTE Occupied Bandwidth) for more test data



Report No.: WSCT-ANAB-R&amp;E250400022A-RF

## 10. BAND EDGE

### Test Limit:

The radio frequency voltage or powers generated within the equipment and appearing on a spurious frequency shall be checked at the equipment output terminals when properly load ed with a suitable artificial antenna. Curves or equivalent data shall show the magnitude of each harmonic and other spurious emission that can be detected when the equipment is op erated under the conditions specified in §2.1049 as appropriate. The magnitude of spurious emissions which are attenuated more than 20 dB below the permissible value need not be specified. See section 4.

### Test procedure:

The RF output of the transmitter was connected to the input of the spectrum analyzer through sufficient attenuation.

### Test setup:

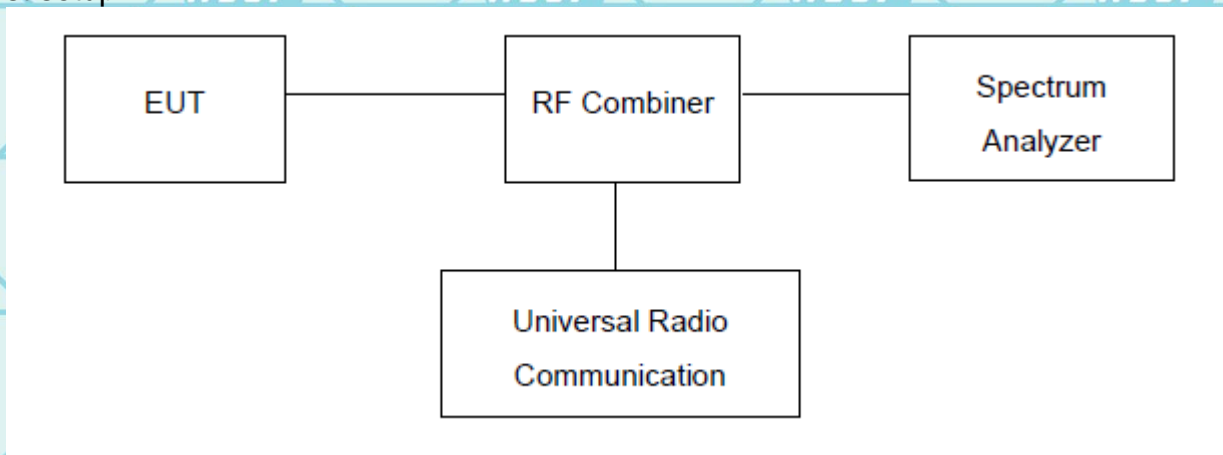

Report No.: WSCT-ANAB-R&E250400022A-RF

### 10.1. Measurement Result

#### Test Plot(s)

Low Band Edge WCDMA Band 2 CH 9263

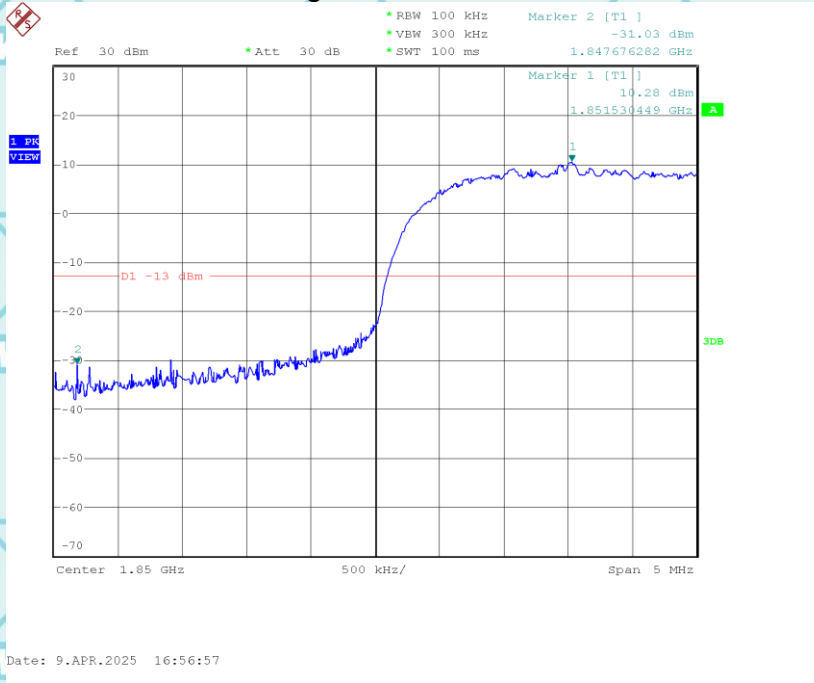

High Band Edge WCDMA Band 2 CH 9537

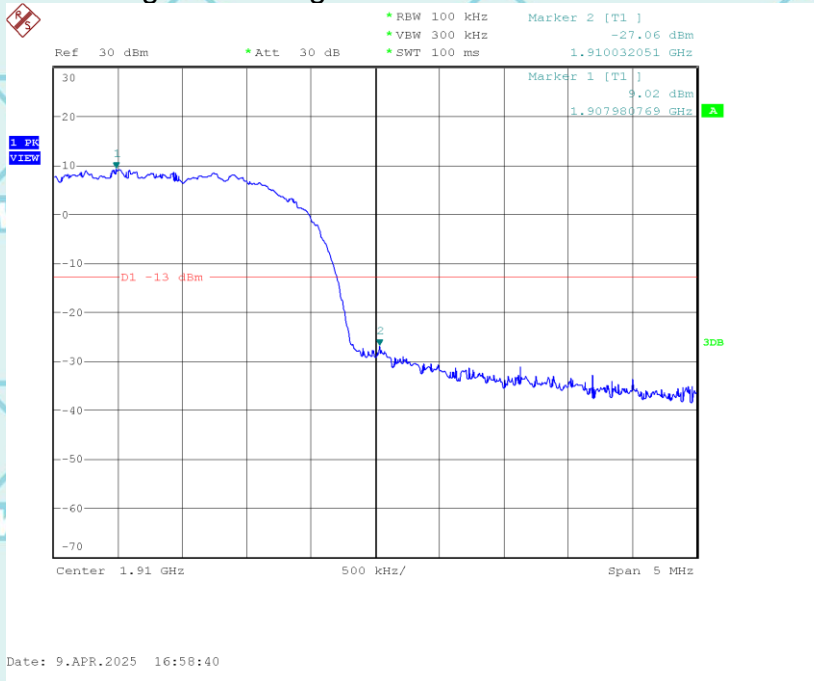

Report No.: WSCT-ANAB-R&E250400022A-RF

### Low Band Edge WCDMA Band 4 CH 1312

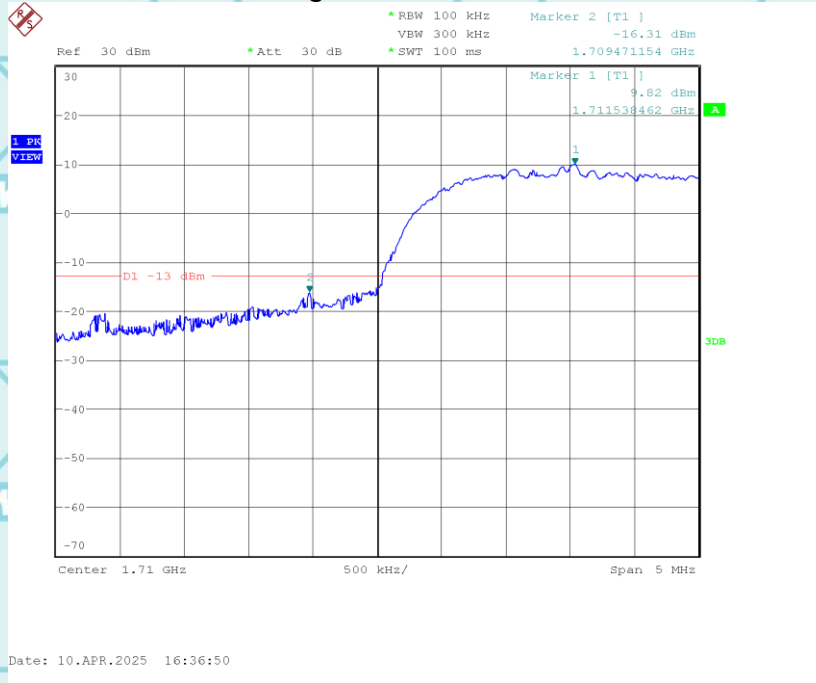

### Low Band Edge WCDMA Band 4 CH 1513

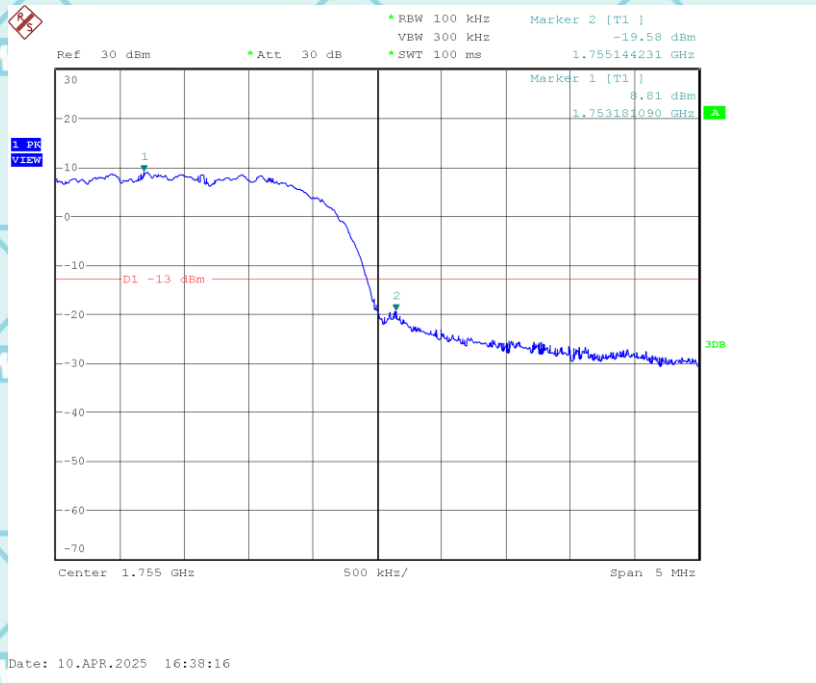

Report No.: WSCT-ANAB-R&E250400022A-RF

### Low Band Edge WCDMA Band 5 CH 4132

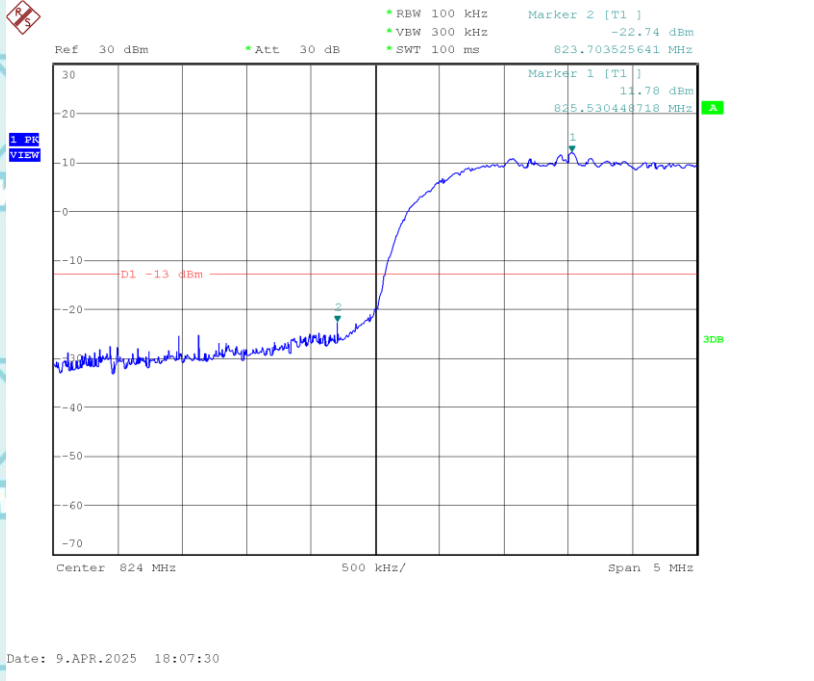

### High Band Edge WCDMA Band 5 CH 4233

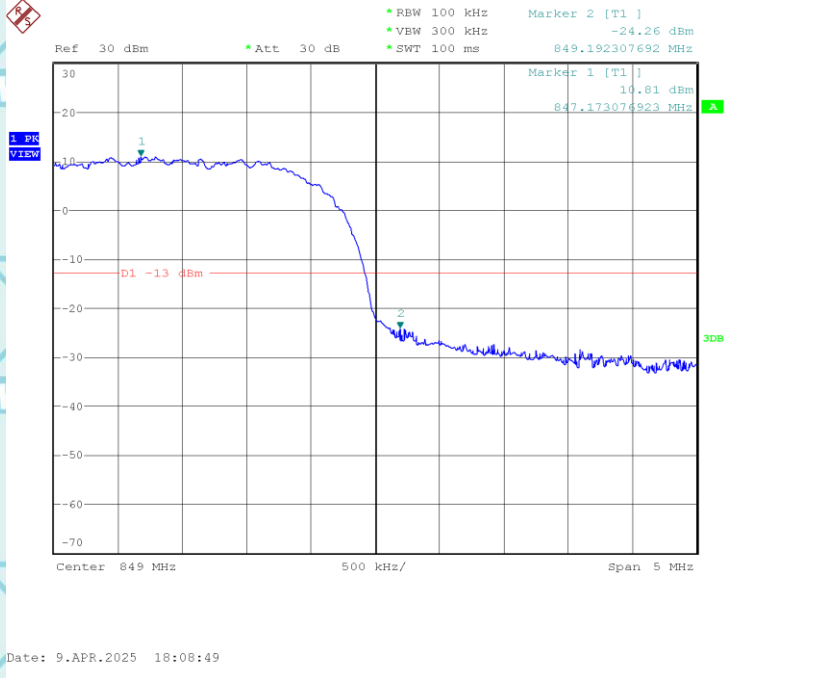

Note: Please refer to Annex (LTE Band Edge) for more test data



Report No.: WSCT-ANAB-R&E250400022A-RF

# 11. SPURIOUS EMISSION (Conducted and Radiated)

## 11.1. Measurement Result (Pre-measurement)

### UTRA BANDS

#### Band 2:

Test Channel	BW(MHz)	UL Channel	Frequency(MHz)	Judgment
Low Range	5	9262	1850.1	Pass
Middle Range	5	9400	1879.1	Pass
High Range	5	9538	1905.1	Pass

#### Band 4:

Test Channel	BW(MHz)	UL Channel	Frequency(MHz)	Judgment
Low Range	5	1312	1710.0	Pass
Middle Range	5	1413	1731.7	Pass
High Range	5	1513	1750.2	Pass

#### Band 5:

Test Channel	BW(MHz)	UL Channel	Frequency(MHz)	Judgment
Low Range	5	4132	825.5	Pass
Middle Range	5	4182	835.5	Pass
High Range	5	4233	845.7	Pass



Report No.: WSCT-ANAB-R&E250400022A-RF

**Test Plot(s)**

**Conducted method**

**Test limit:**

The spurious (unwanted) emission limits specified in the individual FCC rule parts applicable to licensed digital transmitters (typically referred to under the heading 'emission limits') normally apply to any and all emissions that are present outside of the authorized frequency band/block and apply to emissions in both the out-of-band and spurious domains. In some rule parts, the unwanted emission limits are specified by an emission mask that defines the applicable limit as a function of the frequency range relative to the authorized frequency block.

Typically, unwanted emissions are required by the licensed rule parts to be attenuated below the transmitter power by a factor of at least  $X + 10\log(P)$  dB, where P represents the transmitter power expressed in watts and X is a specified scalar value (e.g., 43). This specification can be interpreted in one of two equivalent ways. First, the required attenuation can be construed to be relative to the mean carrier power, with the resultant of the equation  $X + 10\log(P)$  being expressed in dBc (dB relative to the maximum carrier power). Alternatively, the specification can be interpreted as an absolute limit when the specified attenuation is actually subtracted from the maximum permissible transmitter power [i.e.,  $10\log(P) - \{X + 10\log(P)\}$ ], resulting in an absolute level of -X dBW [or  $(-X + 30)$  dBm]. See section 4.

**Test procedure:**

The RF output of the transceiver was connected to a spectrum analyzer and simulator through appropriate attenuation. The resolution bandwidth of the spectrum analyzer was set at 100 kHz below 1 GHz and 1 MHz above 1 GHz. Sufficient scans were taken to show any out of band emissions up to 10th harmonics.

**Conducted Emission Test-Up:**

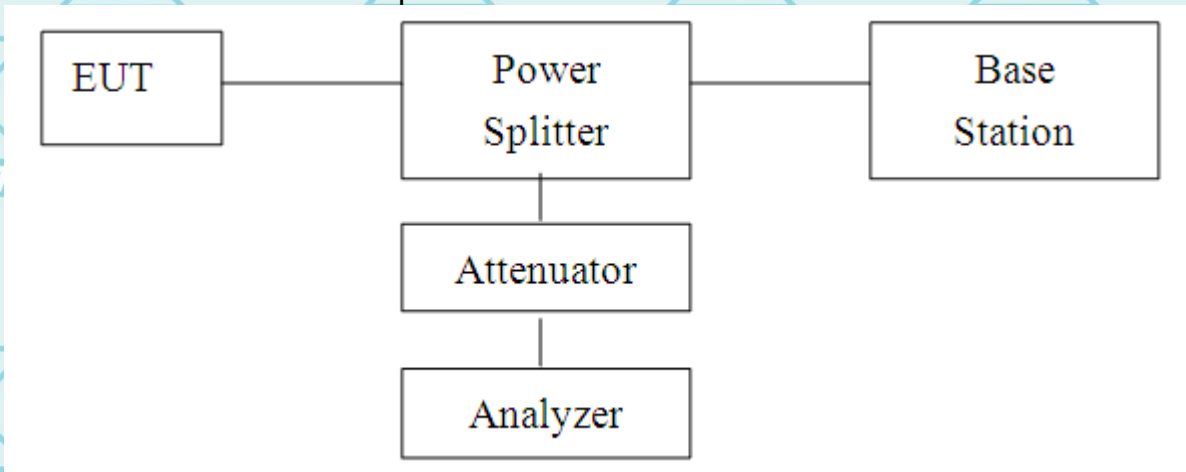

Report No.: WSCT-ANAB-R&E250400022A-RF

### CONDUCTED EMISSION IN WCDMA Band 2 Conducted Emission Transmitting Mode CH 9262 30MHz – 1GHz

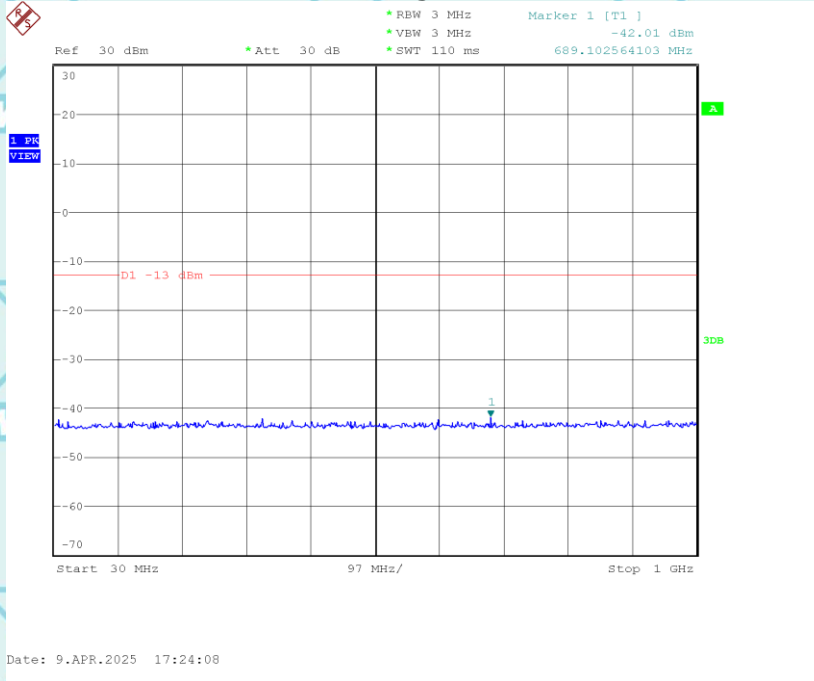

Report No.: WSCT-ANAB-R&E250400022A-RF

### Conducted Emission Transmitting Mode CH 9262 1GHz – 20GHz

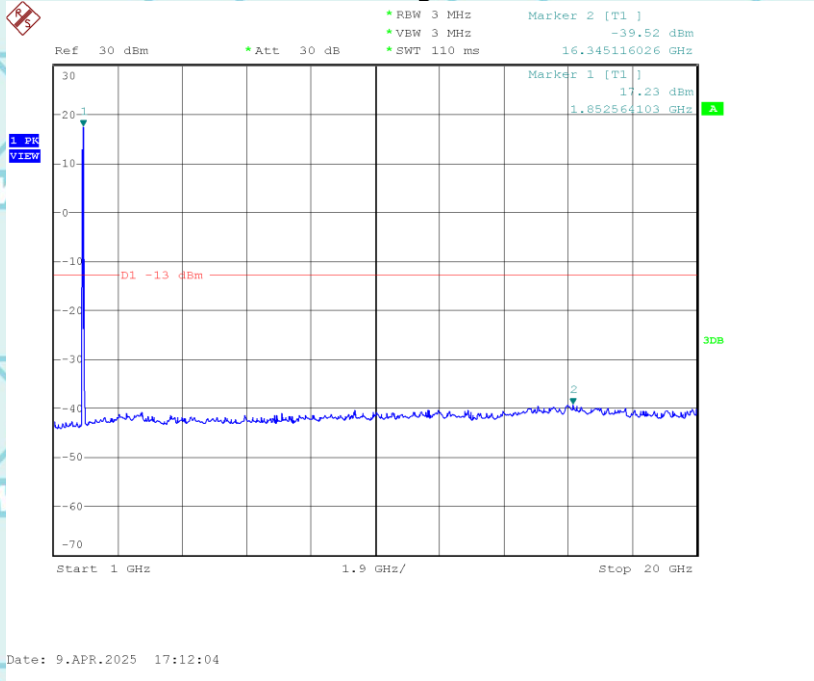

### Conducted Emission Transmitting Mode CH 9400 30MHz – 1GHz

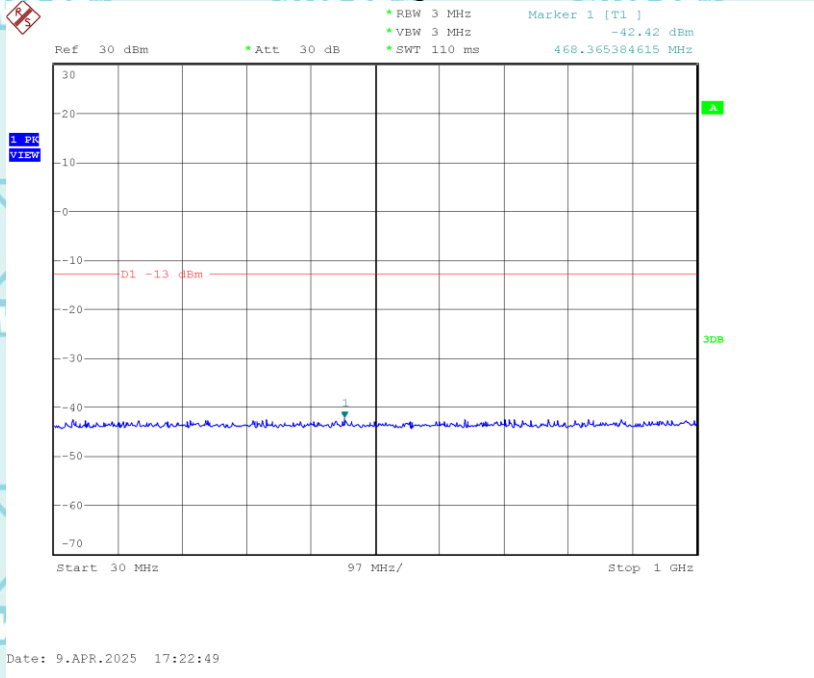

Report No.: WSCT-ANAB-R&E250400022A-RF

### Conducted Emission Transmitting Mode CH 9400 1GHz – 20GHz

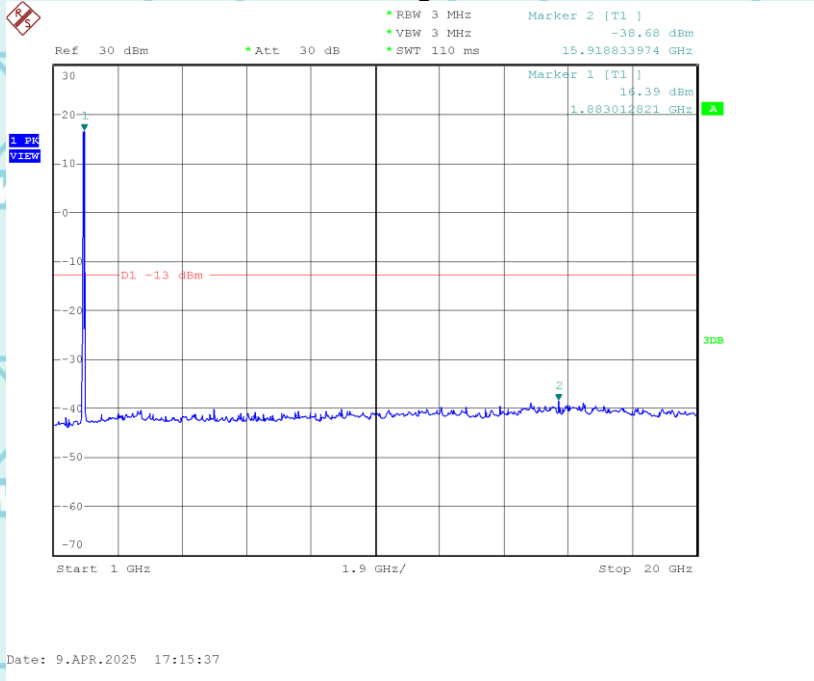

### Conducted Emission Transmitting Mode CH 9538 30MHz – 1GHz

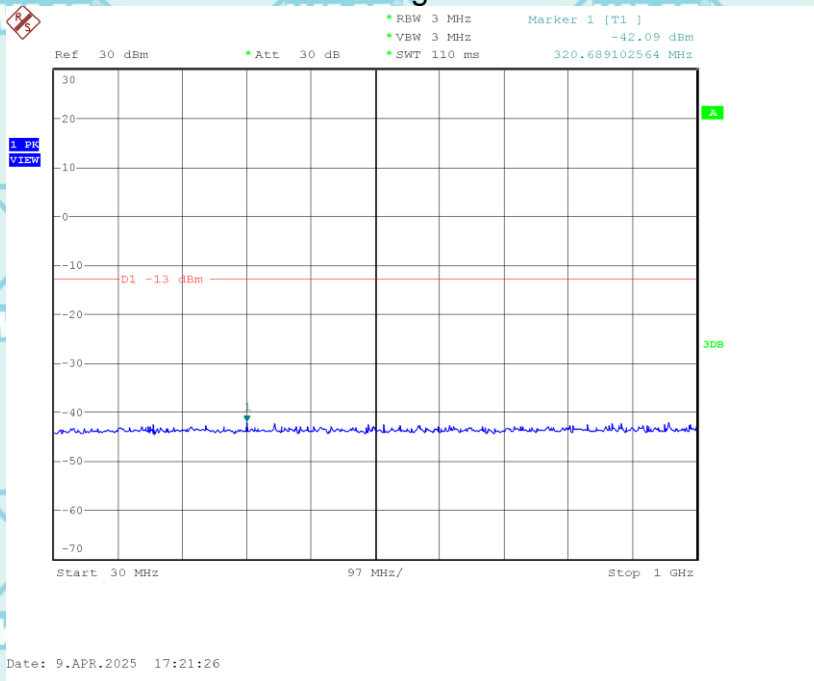

Report No.: WSCT-ANAB-R&E250400022A-RF

### Conducted Emission Transmitting Mode CH 9538 1GHz – 20GHz

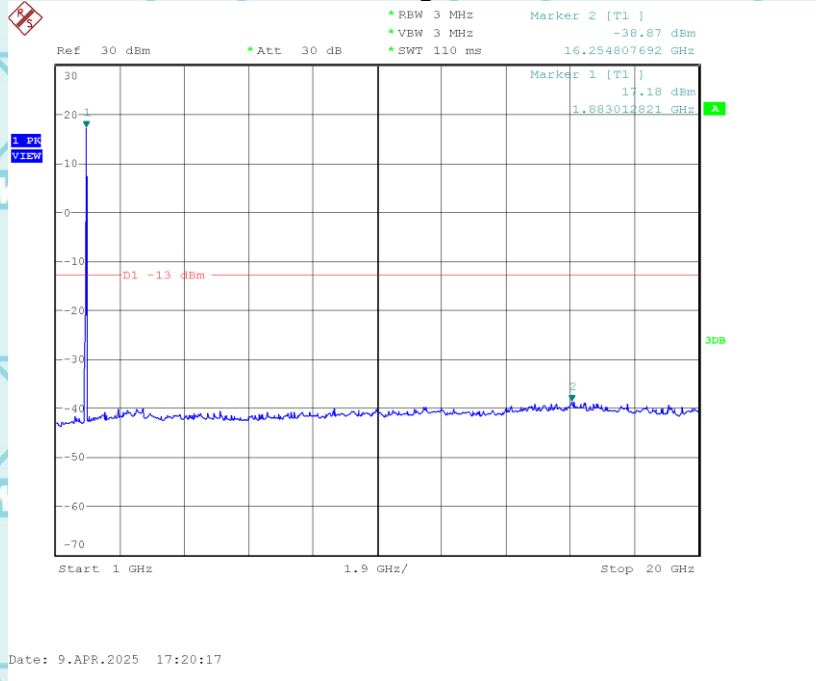

### CONDUCTED EMISSION IN WCDMA Band 4 Conducted Emission Transmitting Mode CH 1312 30MHz – 1GHz

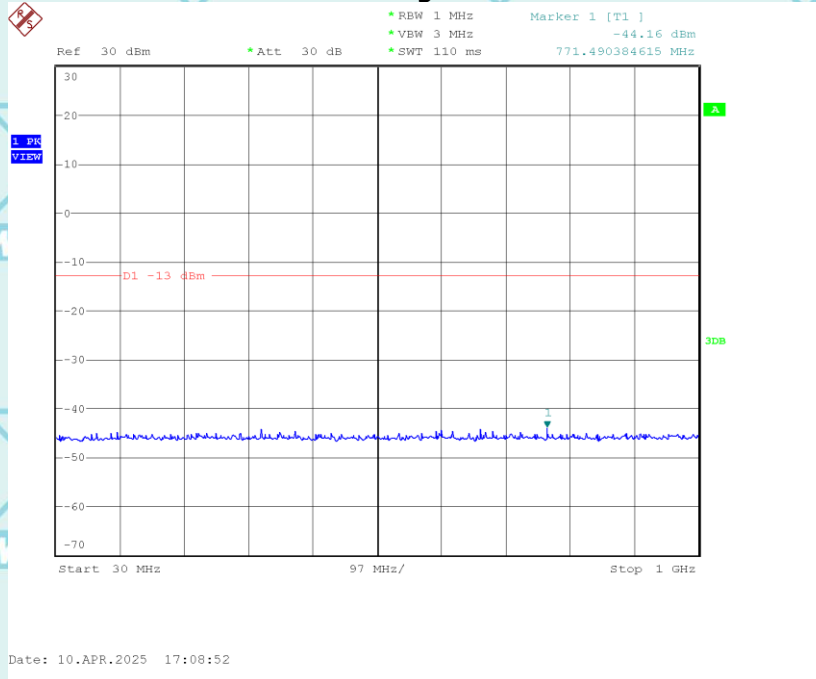

Report No.: WSCT-ANAB-R&E250400022A-RF

### Conducted Emission Transmitting Mode CH 1312 1GHz – 20GHz

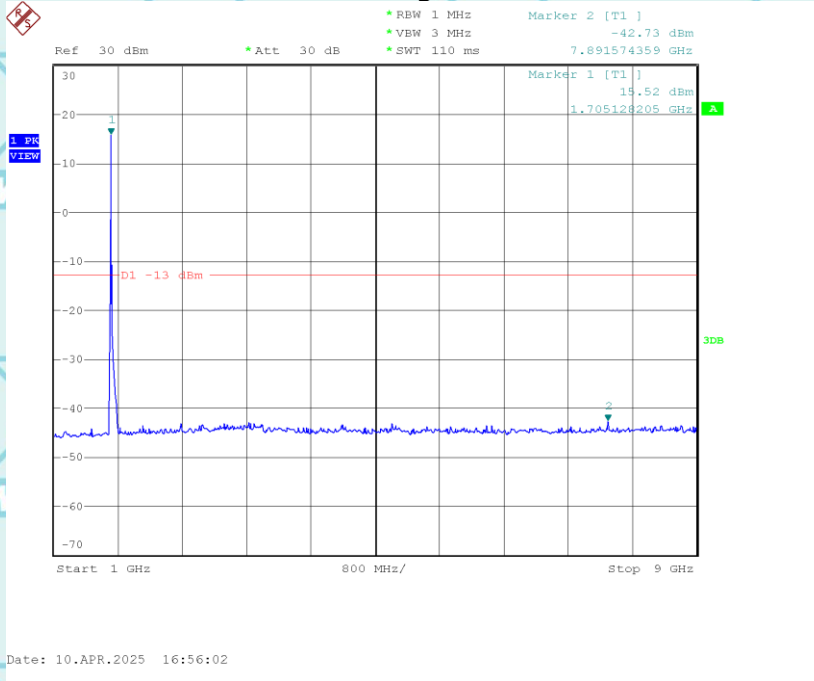

### Conducted Emission Transmitting Mode CH 1413 30MHz – 1GHz

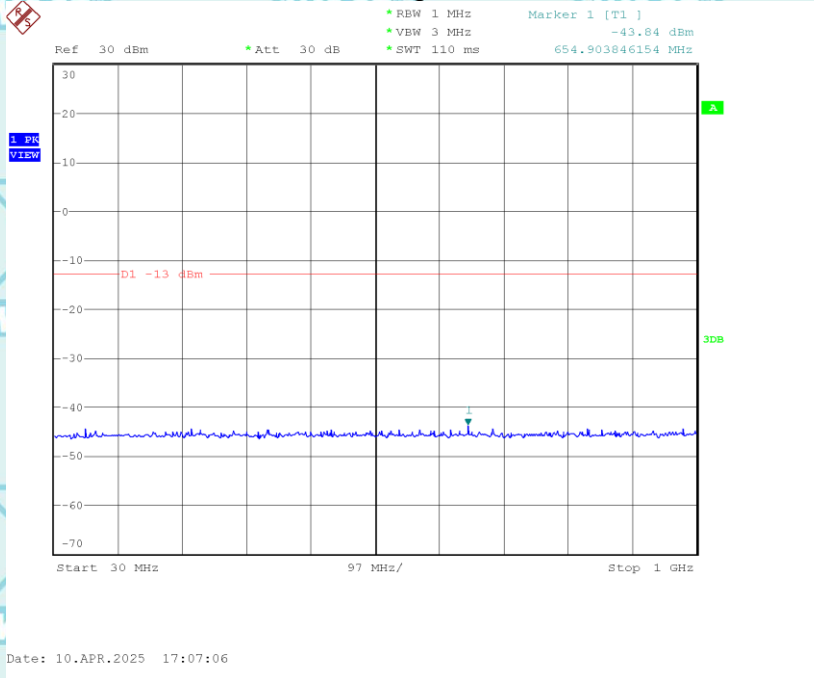

Report No.: WSCT-ANAB-R&E250400022A-RF

### Conducted Emission Transmitting Mode CH 1413 1GHz – 20GHz

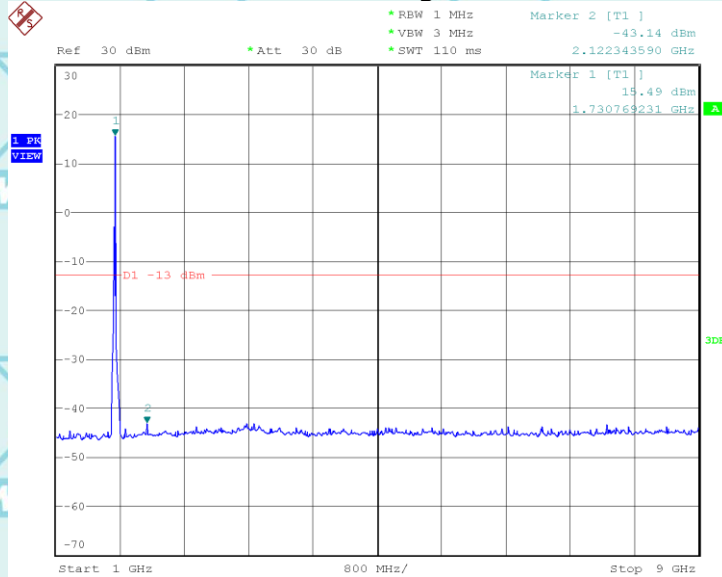

Date: 10.APR.2025 16:57:44

### Conducted Emission Transmitting Mode CH 1513 30MHz – 1GHz

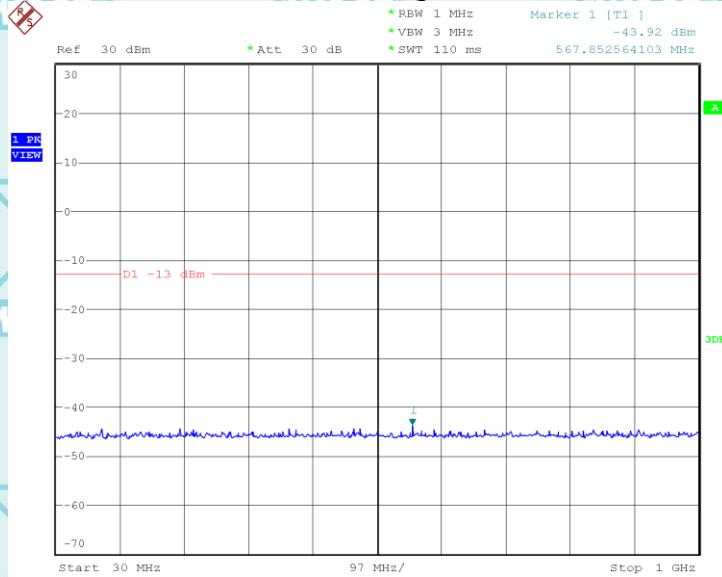

Date: 10.APR.2025 17:03:12



Report No.: WSCT-ANAB-R&E250400022A-RF

### Conducted Emission Transmitting Mode CH 1513 1GHz – 20GHz

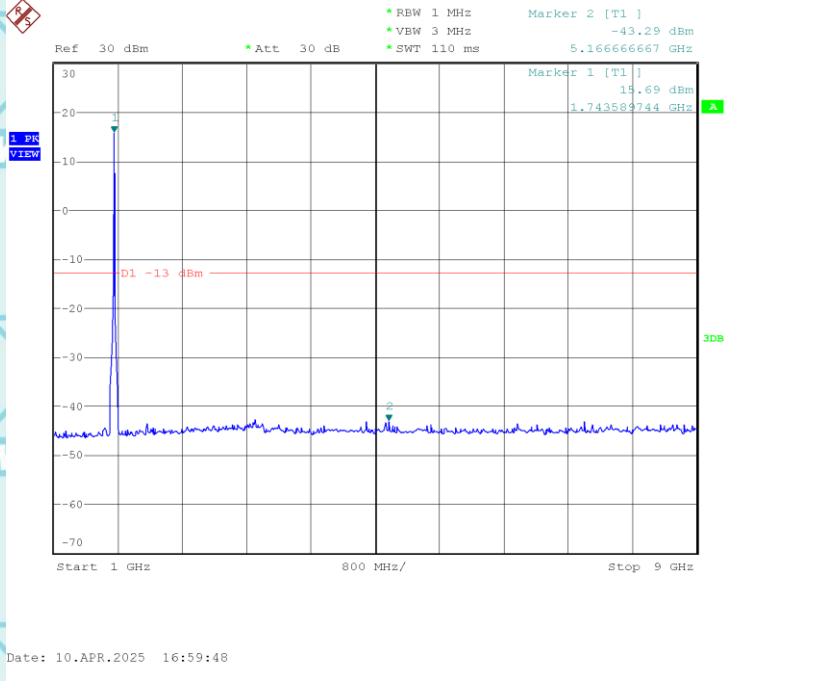

### CONDUCTED EMISSION IN WCDMA Band 5 Conducted Emission Transmitting Mode CH 4132 30MHz – 1GHz

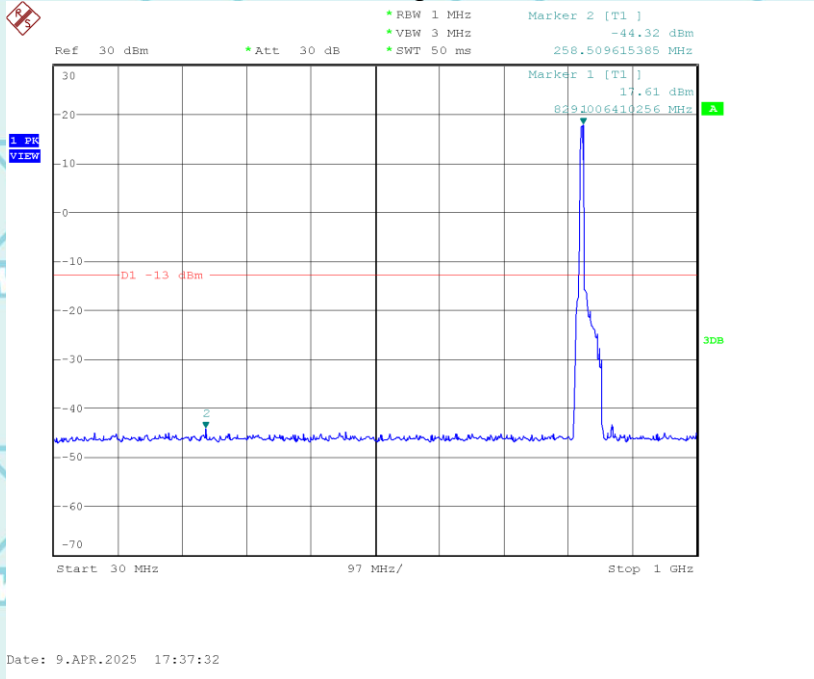

Report No.: WSCT-ANAB-R&E250400022A-RF

### Conducted Emission Transmitting Mode CH 4132 1GHz – 9GHz

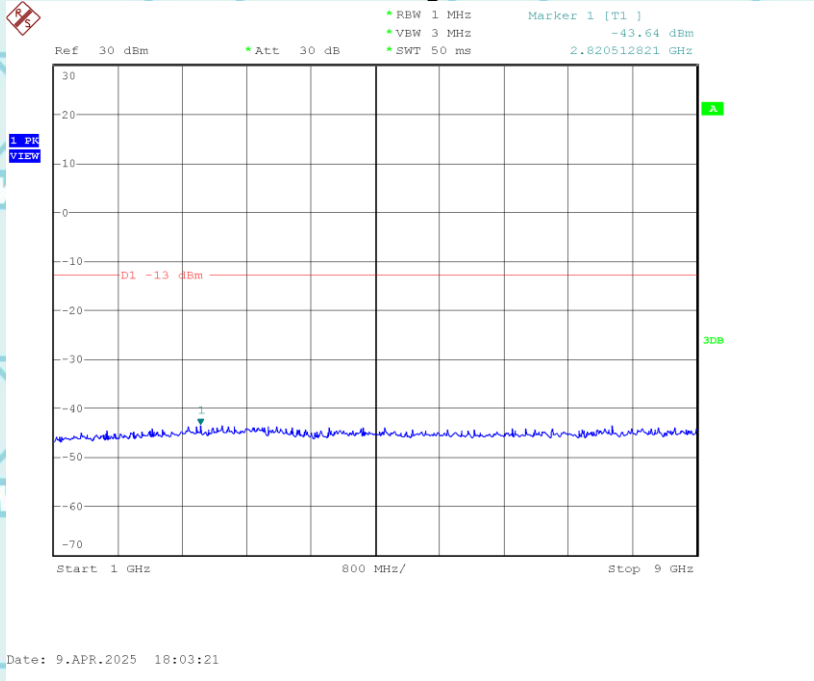

### Conducted Emission Transmitting Mode CH 4182 30MHz – 1GHz

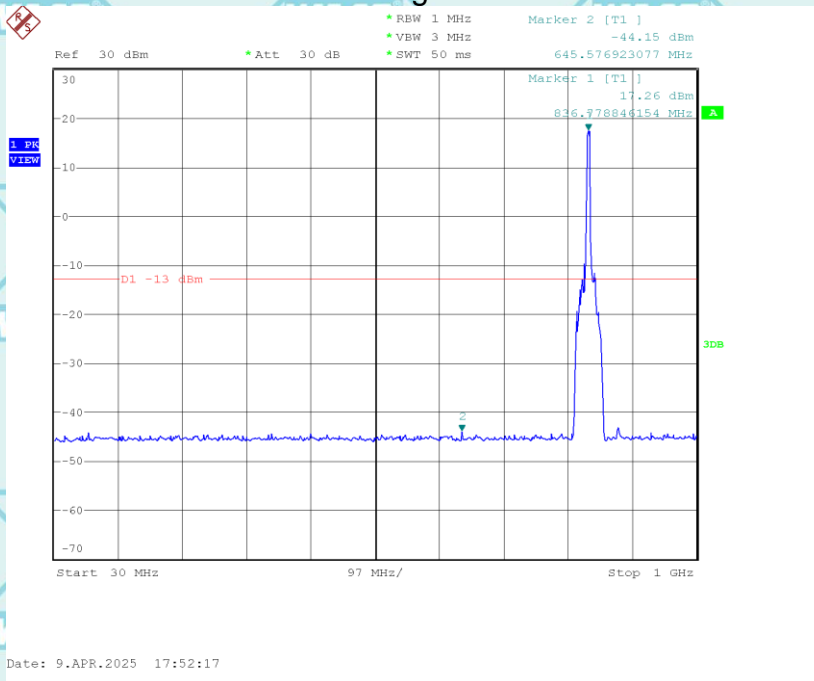

Report No.: WSCT-ANAB-R&E250400022A-RF

### Conducted Emission Transmitting Mode CH 4182 1GHz – 9GHz

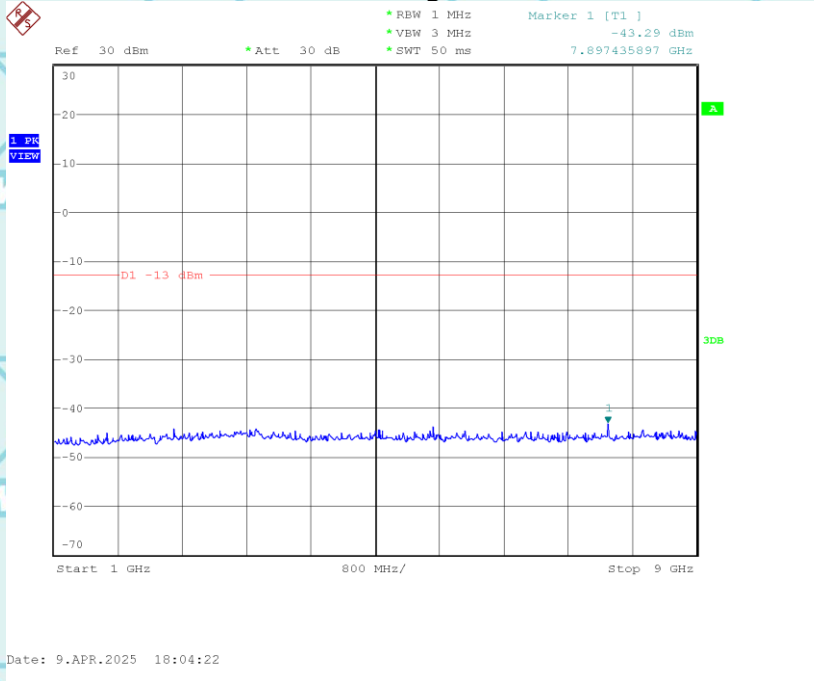

### Conducted Emission Transmitting Mode CH 4233 30MHz – 1GHz

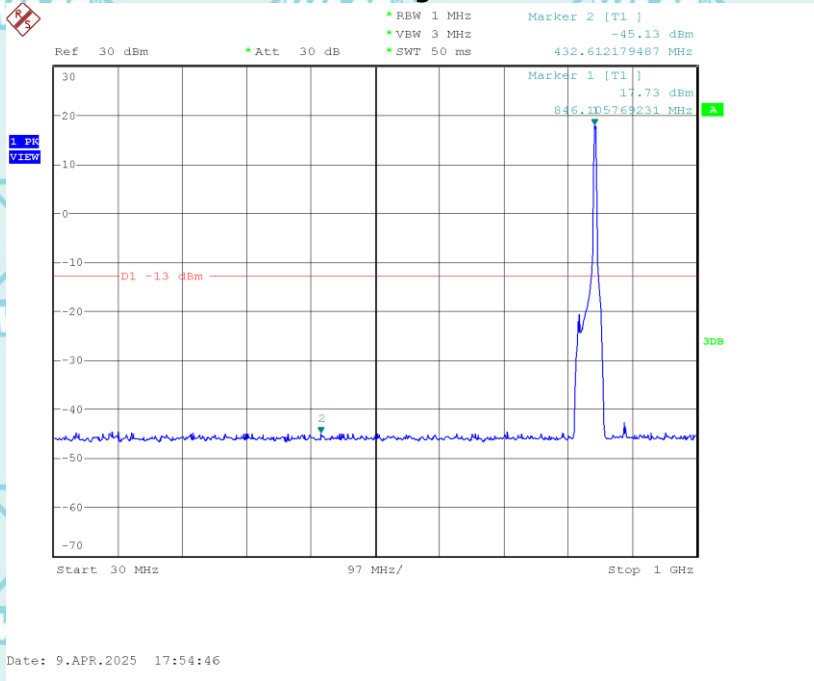

Report No.: WSCT-ANAB-R&E250400022A-RF

### Conducted Emission Transmitting Mode CH 4233 1GHz – 9GHz

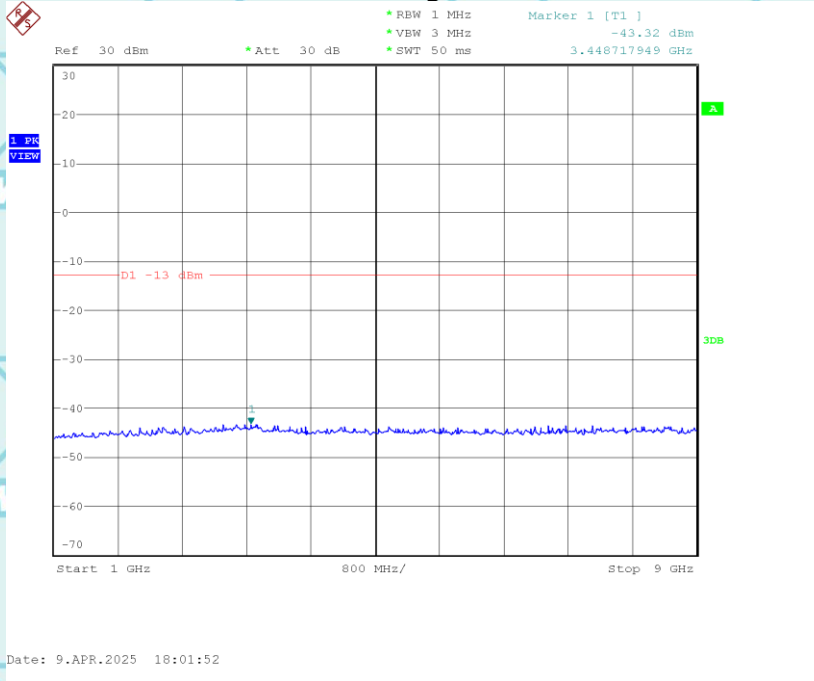

Note: Please refer to Annex (LTE Out-of-band emissions) for more test data



Report No.: WSCT-ANAB-R&E250400022A-RF

### 12. FREQUENCY STABILITY

#### Test limit:

The frequency stability of the transmitter shall be measured while varying the ambient temperatures and supply voltages over the ranges specified in §2.1055. The specific frequency stability limits are provided in the relevant rules section(s). see section 4.

#### Test procedure:

Frequency Stability vs. Temperature: The equipment under test was connected to an external DC power supply and the RF output was connected to communication test set via feed-through attenuators. The EUT was placed inside the temperature chamber. The DC leads and RF output cable exited the chamber through an opening made for the purpose.

#### Test setup:

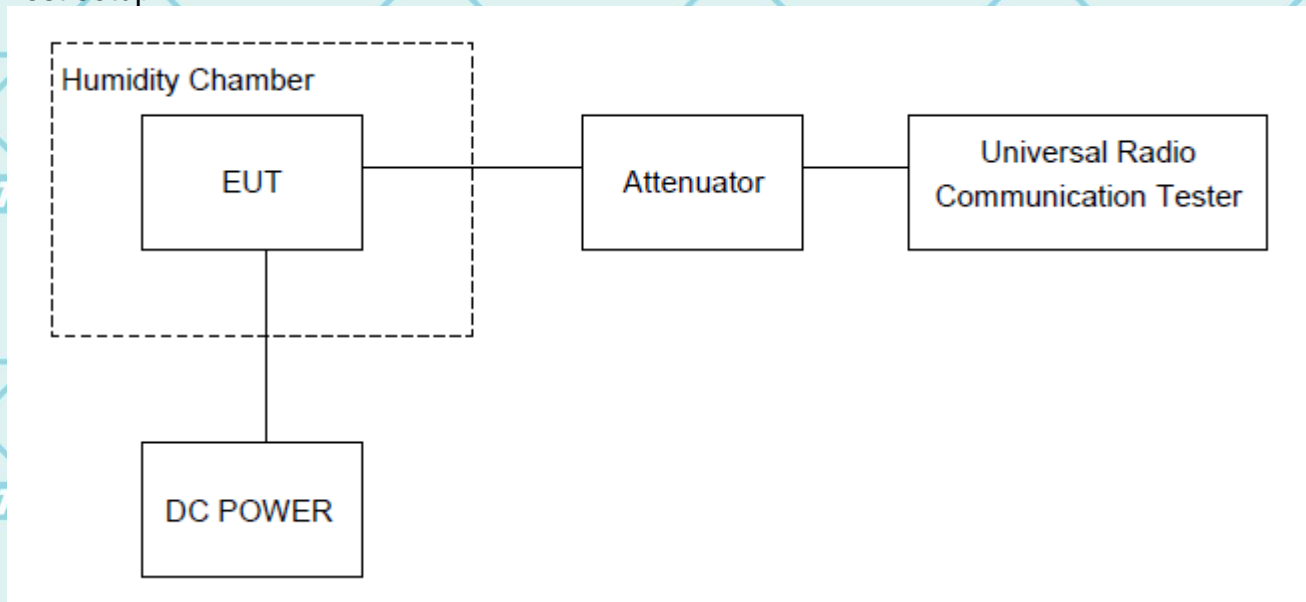

## 12.1. Measurement Result (Worst)

### UTRA BANDS

#### Frequency Error against Voltage for WCDMA Band 2 (1880MHz)

Voltage(V)	Frequency error(Hz)	Frequency error (ppm)
3.7	29	0.015
3.7	32	0.017
4.2	34	0.018

#### Frequency Error against Temperature for WCDMA Band 2 (1880MHz)

Temperature(°C)	Frequency error(Hz)	Frequency error(ppm)
-20	36	0.019
0	34	0.018
10	35	0.019
20	41	0.022
30	29	0.015
40	41	0.022
60	30	0.016

#### Frequency Error against Voltage for WCDMA Band 4 (1732.6MHz)

Voltage(V)	Frequency error(Hz)	Frequency error (ppm)
3.7	38	0.045
3.7	34	0.040
4.2	32	0.038

#### Frequency Error against Temperature for WCDMA Band 4 (1732.6MHz)

Temperature(°C)	Frequency error(Hz)	Frequency error(ppm)
-20	32	0.038
0	40	0.047
10	29	0.035
20	28	0.034
30	34	0.041
40	33	0.039
60	30	0.036

Report No.: WSCT-ANAB-R&E250400022A-RF

**Frequency Error against Voltage for WCDMA Band 5 (836.4MHz)**

Voltage(V)	Frequency error(Hz)	Frequency error(ppm)
3.7	32	0.017
3.7	35	0.018
4.2	28	0.015

**Frequency Error against Temperature for WCDMA Band 5 (836.4MHz)**

Temperature(°C)	Frequency error(Hz)	Frequency error(ppm)
-20	40	0.021
0	38	0.020
10	31	0.017
20	33	0.018
30	32	0.017
40	34	0.018
60	29	0.015

Note: Please refer to Annex (LTE Frequency Error against ) for more test data



Report No.: WSCT-ANAB-R&E250400022A-RF

### 13. Test Setup Photographs

Please refer to Annex "Set Up Photos-RF" for test setup photos

---END OF REPORT---

