



FCC RF Test Report

APPLICANT : D-Link Co.
EQUIPMENT : 4G LTE VPN Router
BRAND NAME : D-Link
MODEL NAME : DWR-925
FCC ID : KA2WR925A2
STANDARD : FCC 47 CFR Part 2, 22(H), 24(E), 27(L)
CLASSIFICATION : PCS Licensed Transmitter (PCB)

The product was received on Sep. 24, 2014 and testing was completed on Oct. 02, 2014. We, SPORTON INTERNATIONAL INC., would like to declare that the tested sample has been evaluated in accordance with the test procedures given in ANSI / TIA / EIA-603-C-2004 and has been in compliance with the applicable technical standards.

The test results in this report apply exclusively to the tested model / sample. Without written approval of SPORTON INTERNATIONAL INC., the test report shall not be reproduced except in full.

Reviewed by: Joseph Lin / Supervisor

Approved by: Jones Tsai / Manager



SPORTON INTERNATIONAL INC.

No. 52, Hwa Ya 1st Rd., Hwa Ya Technology Park, Kwei-Shan Hsiang, Tao Yuan Hsien, Taiwan, R.O.C.



TABLE OF CONTENTS

REVISION HISTORY..... 3

SUMMARY OF TEST RESULT 4

1 GENERAL DESCRIPTION 5

 1.1 Applicant..... 5

 1.2 Manufacturer 5

 1.3 Product Feature of Equipment Under Test 5

 1.4 Product Specification subjective to this standard 6

 1.5 Modification of EUT 6

 1.6 Maximum ERP/EIRP Power, Frequency Tolerance, and Emission Designator 7

 1.7 Testing Location 7

 1.8 Applicable Standards 8

2 TEST CONFIGURATION OF EQUIPMENT UNDER TEST 9

 2.1 Test Mode..... 9

 2.2 Connection Diagram of Test System 11

 2.3 Support Unit used in test configuration 11

 2.4 Measurement Results Explanation Example 11

3 TEST RESULT 12

 3.1 Conducted Output Power and ERP/EIRP Measurement 12

 3.2 Peak-to-Average Ratio 15

 3.3 99% Occupied Bandwidth and 26dB Bandwidth Measurement..... 31

 3.4 Band Edge Measurement..... 55

 3.5 Conducted Spurious Emission Measurement 63

 3.6 Field Strength of Spurious Radiation Measurement 118

 3.7 Frequency Stability Measurement..... 141

4 LIST OF MEASURING EQUIPMENT 147

5 UNCERTAINTY OF EVALUATION 148

APPENDIX A. SETUP PHOTOGRAPHS



SUMMARY OF TEST RESULT

Report Section	FCC Rule	Description	Limit	Result	Remark
3.1	§2.1046	Conducted Output Power	Reporting Only	PASS	-
	§22.913(a)(2)	Effective Radiated Power	< 7 Watts	PASS	-
	§24.232(c)	Equivalent Isotropic Radiated Power	< 2 Watts	PASS	-
	§27.50(d)(4)	Equivalent Isotropic Radiated Power	< 1 Watts	PASS	-
3.2	§24.232(d)	Peak-to-Average Ratio	< 13 dB	PASS	-
3.3	§2.1049 §22.917(b) §24.238(b) §27.53(g)	Occupied Bandwidth	Reporting Only	PASS	-
3.4	§2.1051 §22.917(a) §24.238(a) §27.53(h)	Band Edge Measurement	< 43+10log10(P[Watts])	PASS	-
3.5	§2.1051 §22.917(a) §24.238(a) §27.53(h)	Conducted Emission	< 43+10log10(P[Watts])	PASS	-
3.6	§2.1053 §22.917(a) §24.238(a) §27.53(h)	Field Strength of Spurious Radiation	< 43+10log10(P[Watts])	PASS	Under limit 18.82 dB at 1696.000 MHz
3.7	§2.1055 §22.355 §2.1055 §24.235 §27.54	Frequency Stability for Temperature & Voltage	< 2.5 ppm for Part 22 Within Authorized Band	PASS	-



1 General Description

1.1 Applicant

D-Link Co.

No. 289, Sinhu 3rd Rd., Neihu District Taipei City 114 Taiwan

1.2 Manufacturer

Advance Multimedia Internet Technology Inc.

No. 28, Lane 31, Sec. 1, Huandong Rd., Sinshih District, Tainan City 74146, Taiwan (R.O.C.)

1.3 Product Feature of Equipment Under Test

Product Feature	
Equipment	4G LTE VPN Router
Brand Name	D-Link
Model Name	DWR-925
FCC ID	KA2WR925A2
EUT supports Radios application	GSM/EGPRS/WCDMA/HSPA/LTE WLAN 11b/g/n HT20/HT40
HW Version	A2
SW Version	V1.05
EUT Stage	Production Unit

Remark: The above EUT's information was declared by manufacturer. Please refer to the specifications or user's manual for more detailed description.



1.4 Product Specification subjective to this standard

Product Specification subjective to this standard	
Tx Frequency	GSM850: 824.2 MHz ~ 848.8 MHz GSM1900: 1850.2 MHz ~ 1909.8MHz WCDMA Band V: 826.4 MHz ~ 846.6 MHz WCDMA Band IV : 1712.4 MHz ~ 1752.6 MHz WCDMA Band II: 1852.4 MHz ~ 1907.6 MHz
Rx Frequency	GSM850: 869.2 MHz ~ 893.8 MHz GSM1900: 1930.2 MHz ~ 1989.8 MHz WCDMA Band V: 871.4 MHz ~ 891.6 MHz WCDMA Band IV : 2112.4 MHz ~ 2152.6 MHz WCDMA Band II: 1932.4 MHz ~ 1987.6 MHz
Maximum Output Power to Antenna	GSM850 : 32.16 dBm GSM1900 : 29.48 dBm WCDMA Band V : 23.59 dBm WCDMA Band IV : 24.17 dBm WCDMA Band II : 24.15 dBm
Antenna Type	Dipole Antenna
Antenna Gain	Cellular Band: 2.31 dBi PCS Band: 3.51 dBi AWS Band: 3.41 dBi
Type of Modulation	GSM: GMSK GPRS: GMSK EDGE: GMSK / 8PSK WCDMA: QPSK (Uplink) HSDPA: QPSK (Uplink) HSUPA: QPSK (Uplink)

1.5 Modification of EUT

No modifications are made to the EUT during all test items.



1.6 Maximum ERP/EIRP Power, Frequency Tolerance, and Emission Designator

FCC Rule	System	Type of Modulation	Maximum ERP/EIRP (W)	Frequency Tolerance (ppm)	Emission Designator
Part 22	GSM850 GPRS class 8	GMSK	1.71	0.0084 ppm	248KGXW
Part 22	GSM850 EDGE class 8	8PSK	0.44	0.0132 ppm	250KG7W
Part 22	WCDMA Band V RMC 12.2Kbps	QPSK	0.24	0.0132 ppm	4M18F9W
Part 24	GSM1900 GPRS class 8	GMSK	1.99	0.0186 ppm	248KGXW
Part 24	GSM1900 EDGE class 8	8PSK	0.79	0.0053 ppm	244KG7W
Part 24	WCDMA Band II RMC 12.2Kbps	QPSK	0.58	0.0027 ppm	4M18F9W
Part 27	WCDMA Band IV RMC 12.2Kbps	QPSK	0.57	0.0029 ppm	4M18F9W

1.7 Testing Location

Sporton Lab is accredited to ISO 17025 by Taiwan Accreditation Foundation (TAF code : 1190) and the FCC designation No. TW1022 under the FCC 2.948(e) by Mutual Recognition Agreement (MRA) in FCC Test.

Test Site	SPORTON INTERNATIONAL INC.	
Test Site Location	No. 52, Hwa Ya 1 st Rd., Hwa Ya Technology Park, Kwei-Shan Hsiang, Tao Yuan Hsien, Taiwan, R.O.C. TEL: +886-3-327-3456 FAX: +886-3-328-4978	
Test Site No.	Sporton Site No.	
	TH02-HY	03CH07-HY



1.8 Applicable Standards

According to the specifications of the manufacturer, the EUT must comply with the requirements of the following standards:

- ♦ 47 CFR Part 2, 22(H), 24(E), 27(L)
- ♦ ANSI / TIA / EIA-603-C-2004
- ♦ FCC KDB 971168 D01 Power Meas. License Digital Systems v02r01
- ♦ FCC KDB 412172 D01 Determining ERP and ERIP v01

Remark:

1. All test items were verified and recorded according to the standards and without any deviation during the test.
2. This EUT has also been tested and complied with the requirements of FCC Part 15, Subpart B, recorded in a separate test report.



2 Test Configuration of Equipment Under Test

2.1 Test Mode

Antenna port conducted and radiated test items were performed according to KDB 971168 D01 Power Meas. License Digital Systems v02r01 with maximum output power.

Radiated measurements were performed with rotating EUT in different three orthogonal test planes to find the maximum emission.

Radiated emissions were investigated as following frequency range:

1. 30 MHz to 9000 MHz for GSM850 and WCDMA Band V.
2. 30 MHz to 19000 MHz for GSM1900 and WCDMA Band II.
3. 30 MHz to 18000 MHz for WCDMA Band IV

All modes and data rates and positions were investigated.

Test modes are chosen to be reported as the worst case configuration below:

Test Modes		
Band	Radiated TCs	Conducted TCs
GSM 850	<ul style="list-style-type: none"> ■ GPRS class 8 Link ■ EDGE class 8 Link 	<ul style="list-style-type: none"> ■ GPRS class 8 Link ■ EDGE class 8 Link
GSM 1900	<ul style="list-style-type: none"> ■ GPRS class 8 Link ■ EDGE class 8 Link 	<ul style="list-style-type: none"> ■ GPRS class 8 Link ■ EDGE class 8 Link
WCDMA Band V	<ul style="list-style-type: none"> ■ RMC 12.2Kbps Link 	<ul style="list-style-type: none"> ■ RMC 12.2Kbps Link
WCDMA Band II	<ul style="list-style-type: none"> ■ RMC 12.2Kbps Link 	<ul style="list-style-type: none"> ■ RMC 12.2Kbps Link
WCDMA Band IV	<ul style="list-style-type: none"> ■ RMC 12.2Kbps Link 	<ul style="list-style-type: none"> ■ RMC 12.2Kbps Link

Note: The maximum power levels are chosen to test as the worst case configuration as follows:

- GPRS multi-slot class 8 mode for GMSK modulation,
- EDGE multi-slot class 8 mode for 8PSK modulation,
- RMC 12.2Kbps mode for WCDMA band V, RMC 12.2Kbps mode for WCDMA band II,
- RMC 12.2Kbps mode for WCDMA band IV, only these modes were used for all tests.



Conducted Power Measurement Results:

Conducted Power (*Unit: dBm)						
Band	GSM850			GSM1900		
Channel	128	189	251	512	661	810
Frequency	824.2	836.4	848.8	1850.2	1880.0	1909.8
GPRS class 8	31.88	31.89	32.16	29.48	29.26	29.30
GPRS class 10	-	-	-	29.41	29.19	29.25
GPRS class 11	-	-	-	29.30	29.08	29.19
GPRS class 12	-	-	-	29.17	29.02	29.09
EGPRS class 8	26.14	26.12	26.27	25.44	25.36	25.48
EGPRS class 10	25.93	26.00	26.10	25.46	25.28	25.42
EGPRS class 11	25.78	25.82	25.89	25.36	25.21	25.36
EGPRS class 12	25.65	25.66	25.79	25.25	25.18	25.29

Note : GPRS of GSM 850 Band only supported 1 Tx.

Conducted Power (*Unit: dBm)									
Band	WCDMA Band V			WCDMA Band II			WCDMA Band IV		
Channel	4132	4182	4233	9262	9400	9538	1312	1413	1513
Frequency	826.4	836.4	846.6	1852.4	1880	1907.6	1712.4	1732.6	1752.6
RMC 12.2K	23.57	23.59	23.57	24.15	23.82	23.64	24.17	24.02	24.16
HSDPA Subtest-1	22.33	22.62	23.35	23.24	22.84	22.56	23.05	22.90	23.26
HSDPA Subtest-2	22.59	22.92	22.64	23.49	23.21	22.73	23.43	23.18	23.46
HSDPA Subtest-3	22.08	22.43	22.19	22.90	22.55	22.11	22.77	22.67	23.00
HSDPA Subtest-4	22.05	22.38	22.15	22.91	22.62	22.22	22.70	22.70	23.01
HSUPA Subtest-1	21.06	21.68	21.45	21.93	21.80	21.52	21.94	21.95	22.28
HSUPA Subtest-2	21.27	21.17	21.09	21.96	21.68	21.50	21.91	21.47	22.04
HSUPA Subtest-3	20.77	20.54	20.23	21.44	21.20	20.74	21.53	20.96	21.81
HSUPA Subtest-4	21.87	21.88	21.39	22.15	22.26	22.07	22.49	22.38	22.40
HSUPA Subtest-5	21.92	22.29	21.94	22.61	22.29	22.04	22.50	22.51	22.76

2.2 Connection Diagram of Test System

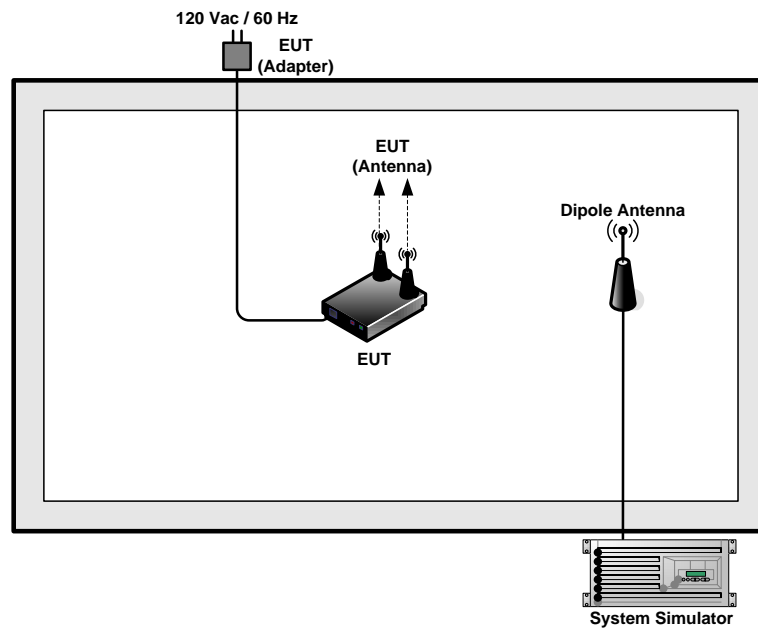

2.3 Support Unit used in test configuration

Item	Equipment	Trade Name	Model No.	FCC ID	Data Cable	Power Cord
1.	System Simulator	R&S	CMU 200	N/A	N/A	Unshielded, 1.8 m

2.4 Measurement Results Explanation Example

For all conducted test items:

The offset level is set in the spectrum analyzer to compensate the RF cable loss and attenuator factor between RF conducted output port and spectrum analyzer. With the offset compensation, the spectrum analyzer reading level will be exactly the RF output level.

The spectrum analyzer offset is derived from RF cable loss and attenuator factor.

Offset = RF cable loss + attenuator factor.

The following shows an offset computation example with RF cable loss 4.2 dB and a 10dB attenuator.

Example :

$$\begin{aligned} \text{Offset(dB)} &= \text{RF cable loss(dB)} + \text{attenuator factor(dB)} \\ &= 4.2 + 10 = 14.2 \text{ (dB)} \end{aligned}$$

3 Test Result

3.1 Conducted Output Power and ERP/EIRP Measurement

3.1.1 Description of the Conducted Output Power and ERP/EIRP Measurement

A system simulator was used to establish communication with the EUT. Its parameters were set to enforce EUT transmitting at the maximum power. The measured power in the radio frequency on the transmitter output terminals shall be reported.

The ERP of mobile transmitters must not exceed 7 Watts (Cellular Band) and the EIRP of mobile transmitters are limited to 2 Watts (PCS Band) and 1 Watts (AWS Band). According to KDB 412172 D01 Power Approach,

$EIRP = P_T + G_T - L_C$, $ERP = EIRP - 2.15$, where

P_T = transmitter output power in dBm

G_T = gain of the transmitting antenna in dBi

L_C = signal attenuation in the connecting cable between the transmitter and antenna in dB

3.1.2 Measuring Instruments

The measuring equipment is listed in the section 4 of this test report.

3.1.3 Test Procedures

1. The transmitter output port was connected to the system simulator.
2. Set EUT at maximum power through system simulator.
3. Select lowest, middle, and highest channels for each band and different modulation.
4. Measure the maximum burst average power for GSM and maximum average power for other modulation signal.

3.1.4 Test Setup

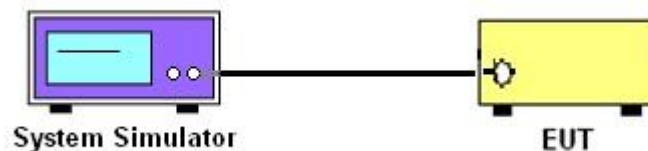



3.1.5 Test Result of Conducted Output Power

Cellular Band ($G_T - L_C = 2.31$ dB)									
Modes	GSM850 (GPRS class 8)			GSM850 (EDGE class 8)			WCDMA Band V (RMC 12.2Kbps)		
Channel	128 (Low)	189 (Mid)	251 (High)	128 (Low)	189 (Mid)	251 (High)	4132 (Low)	4182 (Mid)	4233 (High)
Frequency (MHz)	824.2	836.4	848.8	824.2	836.4	848.8	826.4	836.4	846.6
Conducted Power (dBm)	31.88	31.89	32.16	26.14	26.12	26.27	23.57	23.59	23.57
Conducted Power (Watts)	1.54	1.55	1.64	0.41	0.41	0.42	0.23	0.23	0.23
ERP(dBm)	32.04	32.05	32.32	26.30	26.28	26.43	23.73	23.75	23.73
ERP(Watts)	1.60	1.60	1.71	0.43	0.43	0.44	0.24	0.24	0.24

PCS Band ($G_T - L_C = 3.51$ dB)									
Modes	GSM1900 (GPRS class 8)			GSM1900 (EDGE class 8)			WCDMA Band II (RMC 12.2Kbps)		
Channel	512 (Low)	661 (Mid)	810 (High)	512 (Low)	661 (Mid)	810 (High)	9262 (Low)	9400 (Mid)	9538 (High)
Frequency (MHz)	1850.2	1880	1909.8	1850.2	1880	1909.8	1852.4	1880	1907.6
Conducted Power (dBm)	29.48	29.26	29.3	25.44	25.36	25.48	24.15	23.82	23.64
Conducted Power (Watts)	0.89	0.84	0.85	0.35	0.34	0.35	0.26	0.24	0.23
EIRP(dBm)	32.99	32.77	32.81	28.95	28.87	28.99	27.66	27.33	27.15
EIRP(Watts)	1.99	1.89	1.91	0.79	0.77	0.79	0.58	0.54	0.52



AWS Band ($G_T - L_C = 3.41$ dB)			
Modes	WCDMA Band IV (RMC 12.2Kbps)		
Channel	1312(Low)	1413 (Mid)	1513 (High)
Frequency (MHz)	1712.4	1732.6	1752.6
Conducted Power (dBm)	24.17	24.02	24.16
Conducted Power (Watts)	0.26	0.25	0.26
EIRP(dBm)	27.58	27.43	27.57
EIRP(Watts)	0.57	0.55	0.57

Note: maximum burst average power for GSM, and maximum average power for WCDMA.

$EIRP = P_T + G_T - L_C$, $ERP = EIRP - 2.15$, where

P_T = transmitter output power in dBm

G_T = gain of the transmitting antenna in dBi

L_C = signal attenuation in the connecting cable between the transmitter and antenna in dB

3.2 Peak-to-Average Ratio

3.2.1 Description of the PAR Measurement

The peak-to-average ratio (PAR) of the transmission may not exceed 13 dB.

3.2.2 Measuring Instruments

The measuring equipment is listed in the section 4 of this test report.

3.2.3 Test Procedures

1. The EUT was connected to spectrum analyzer and system simulator via a power divider.
2. Set EUT to transmit at maximum output power.
3. When the duty cycle is less than 98%, then signal gating will be implemented on the spectrum analyzer by triggering from the system simulator.
4. Set the CCDF (Complementary Cumulative Distribution Function) option of the spectrum analyzer.
Record the maximum PAPR level associated with a probability of 0.1%.

3.2.4 Test Setup

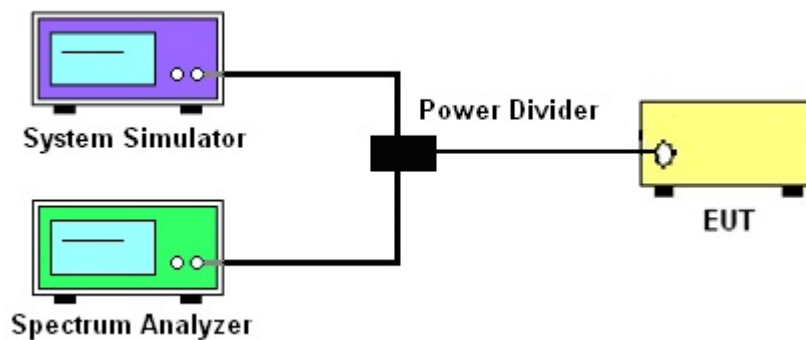



3.2.5 Test Result of Peak-to-Average Ratio

Cellular Band									
Modes	GSM850 (GPRS class 8)			GSM850 (EDGE class 8)			WCDMA Band V (RMC 12.2Kbps)		
Channel	128 (Low)	189 (Mid)	251 (High)	128 (Low)	189 (Mid)	251 (High)	4132 (Low)	4182 (Mid)	4233 (High)
Frequency (MHz)	824.2	836.4	848.8	824.2	836.4	848.8	826.4	836.4	846.6
Peak-to-Average Ratio (dB)	0.24	0.28	0.28	3.24	3.20	3.16	3.16	2.92	3.24

PCS Band									
Modes	GSM1900 (GPRS class 8)			GSM1900 (EDGE class 8)			WCDMA Band II (RMC 12.2Kbps)		
Channel	512 (Low)	661 (Mid)	810 (High)	512 (Low)	661 (Mid)	810 (High)	9262 (Low)	9400 (Mid)	9538 (High)
Frequency (MHz)	1850.2	1880	1909.8	1850.2	1880	1909.8	1852.4	1880	1907.6
Peak-to-Average Ratio (dB)	0.24	0.24	0.24	3.52	3.52	3.16	3.08	3.32	2.92

AWS Band			
Modes	WCDMA Band IV (RMC 12.2Kbps)		
Channel	1312(Low)	1413 (Mid)	1513 (High)
Frequency (MHz)	1712.4	1732.6	1752.6
Peak-to-Average Ratio (dB)	3.00	3.36	3.08



3.2.6 Test Result (Plots) of Peak-to-Average Ratio

Band :	GSM 850	Test Mode :	GPRS class 8 Link (GMSK)
--------	---------	-------------	--------------------------

Peak-to-Average Ratio on Channel 128 (824.2 MHz)

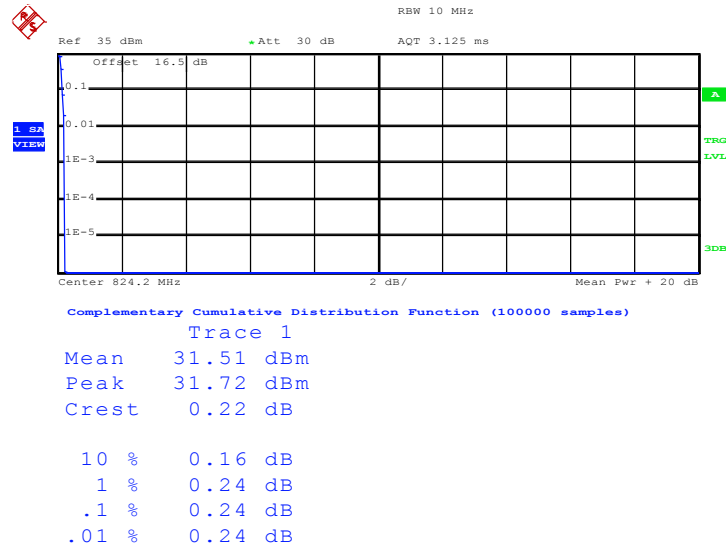

Date: 30.SEP.2014 15:14:09

Peak-to-Average Ratio on Channel 189 (836.4 MHz)

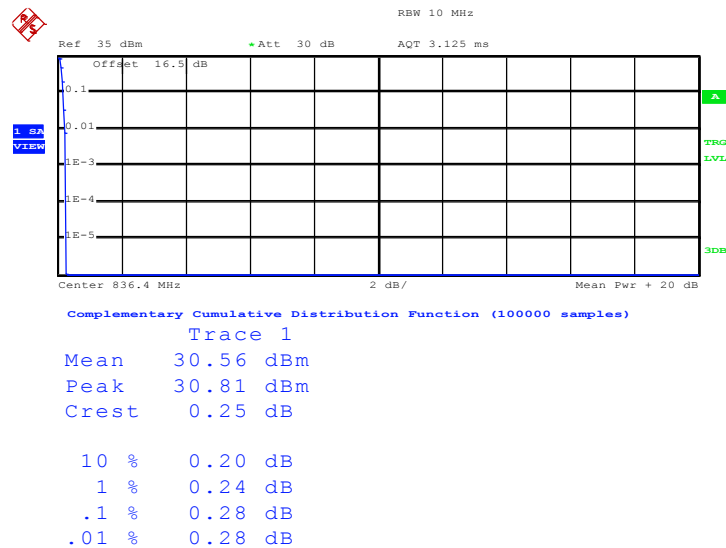

Date: 30.SEP.2014 15:16:50



Peak-to-Average Ratio on Channel 251 (848.8 MHz)

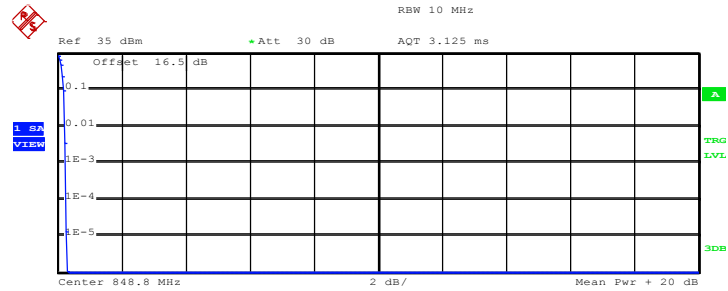

Complementary Cumulative Distribution Function (100000 samples)
 Trace 1
 Mean 30.00 dBm
 Peak 30.31 dBm
 Crest 0.31 dB
 10 % 0.20 dB
 1 % 0.24 dB
 .1 % 0.28 dB
 .01 % 0.28 dB

Date: 30.SEP.2014 15:17:24



Band :	GSM 850	Test Mode :	EDGE class 8 Link (8PSK)
---------------	---------	--------------------	--------------------------

Peak-to-Average Ratio on Channel 128 (824.2 MHz)

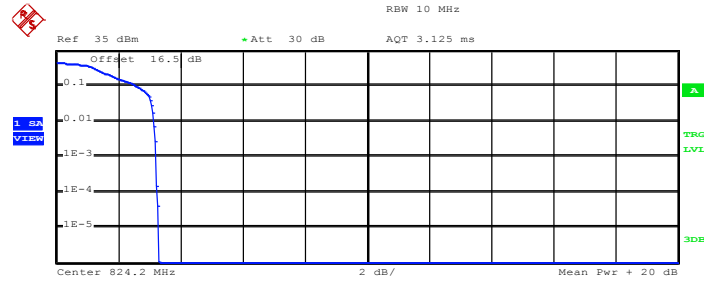

Complementary Cumulative Distribution Function (100000 samples)

Trace 1

Mean	26.18 dBm
Peak	29.47 dBm
Crest	3.29 dB
10 %	2.64 dB
1 %	3.16 dB
.1 %	3.24 dB
.01 %	3.24 dB

Date: 30.SEP.2014 16:16:48

Peak-to-Average Ratio on Channel 189 (836.4 MHz)

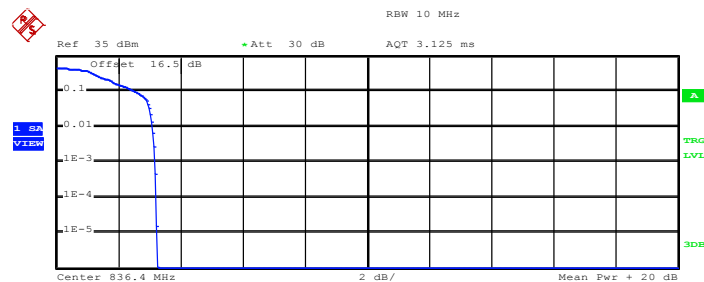

Complementary Cumulative Distribution Function (100000 samples)

Trace 1

Mean	25.35 dBm
Peak	28.62 dBm
Crest	3.27 dB
10 %	2.60 dB
1 %	3.12 dB
.1 %	3.20 dB
.01 %	3.24 dB

Date: 30.SEP.2014 16:17:26



Peak-to-Average Ratio on Channel 251 (848.8 MHz)

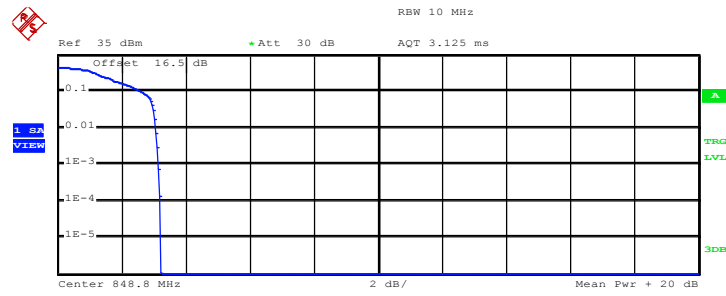

Complementary Cumulative Distribution Function (100000 samples)

Trace 1

Mean 24.85 dBm
 Peak 28.06 dBm
 Crest 3.20 dB

10 % 2.64 dB
 1 % 3.08 dB
 .1 % 3.16 dB
 .01 % 3.20 dB

Date: 30.SEP.2014 16:18:32



Band :	GSM 1900	Test Mode :	GPRS class 8 Link (GMSK)
---------------	----------	--------------------	--------------------------

Peak-to-Average Ratio on Channel 512 (1850.2 MHz)

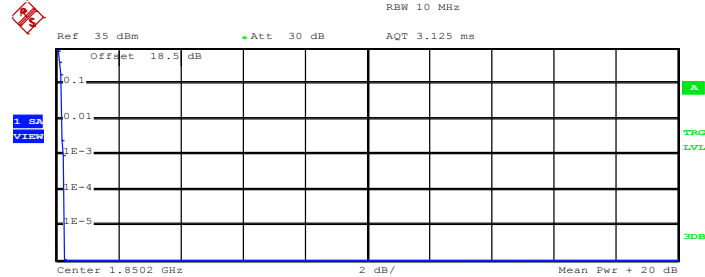

Complementary Cumulative Distribution Function (100000 samples)

Trace 1

Mean	29.56 dBm
Peak	29.82 dBm
Crest	0.26 dB
10 %	0.16 dB
1 %	0.20 dB
.1 %	0.24 dB
.01 %	0.28 dB

Date: 2.OCT.2014 10:00:15

Peak-to-Average Ratio on Channel 661 (1880.0 MHz)

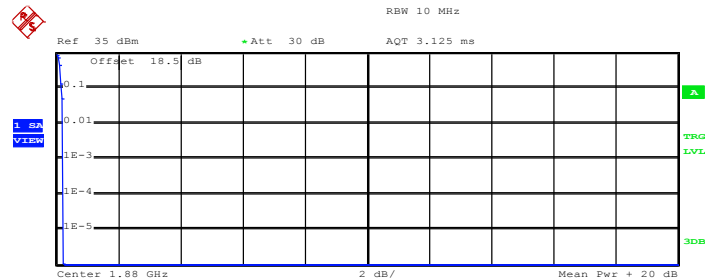

Complementary Cumulative Distribution Function (100000 samples)

Trace 1

Mean	29.38 dBm
Peak	29.61 dBm
Crest	0.23 dB
10 %	0.16 dB
1 %	0.24 dB
.1 %	0.24 dB
.01 %	0.24 dB

Date: 2.OCT.2014 10:00:41



Peak-to-Average Ratio on Channel 810 (1909.8 MHz)

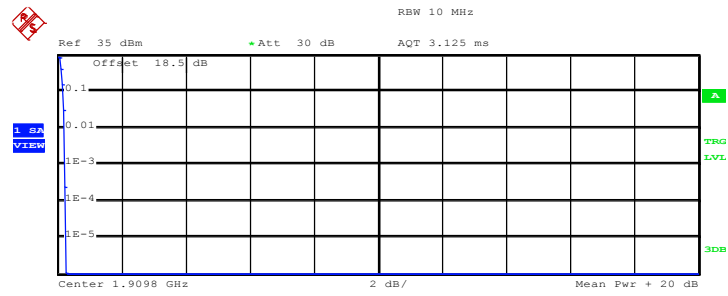

Complementary Cumulative Distribution Function (100000 samples)

Trace 1

Mean 28.91 dBm
 Peak 29.19 dBm
 Crest 0.28 dB

10 % 0.16 dB
 1 % 0.24 dB
 .1 % 0.24 dB
 .01 % 0.28 dB

Date: 2.OCT.2014 10:01:10



Band :	GSM 1900	Test Mode :	EDGE class 8 Link (8PSK)
---------------	----------	--------------------	--------------------------

Peak-to-Average Ratio on Channel 512 (1850.2 MHz)

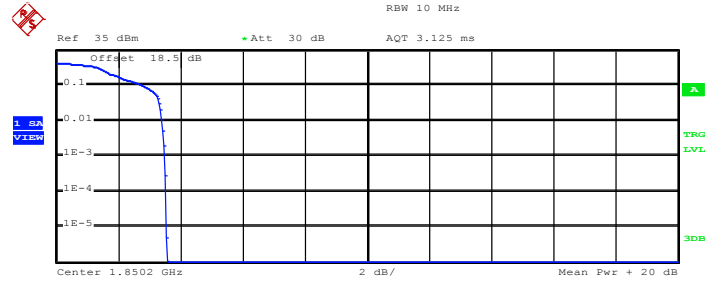

Complementary Cumulative Distribution Function (100000 samples)

Trace 1

Mean	25.67 dBm
Peak	29.26 dBm
Crest	3.59 dB
10 %	2.84 dB
1 %	3.40 dB
.1 %	3.52 dB
.01 %	3.56 dB

Date: 2.OCT.2014 11:10:20

Peak-to-Average Ratio on Channel 661 (1880.0 MHz)

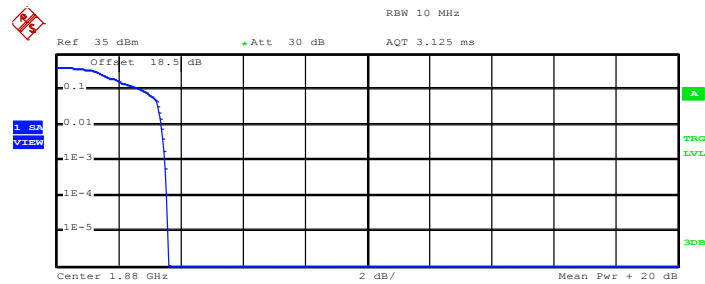

Complementary Cumulative Distribution Function (100000 samples)

Trace 1

Mean	25.66 dBm
Peak	29.26 dBm
Crest	3.60 dB
10 %	2.80 dB
1 %	3.40 dB
.1 %	3.52 dB
.01 %	3.56 dB

Date: 2.OCT.2014 11:10:45



Peak-to-Average Ratio on Channel 810 (1909.8 MHz)

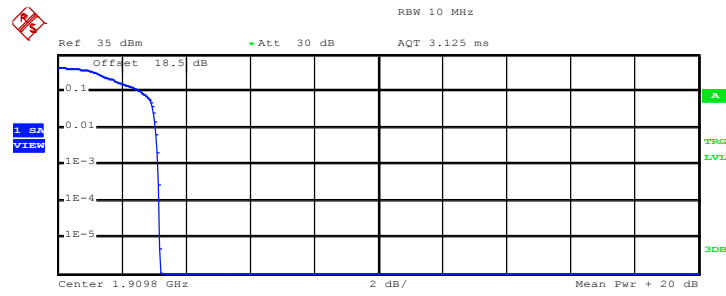

Complementary Cumulative Distribution Function (100000 samples)

Trace 1

Mean 25.53 dBm
 Peak 28.76 dBm
 Crest 3.23 dB

10 % 2.60 dB
 1 % 3.08 dB
 .1 % 3.16 dB
 .01 % 3.20 dB

Date: 2.OCT.2014 11:11:45



Band :	WCDMA Band V	Test Mode :	RMC 12.2Kbps Link (QPSK)
---------------	--------------	--------------------	--------------------------

Peak-to-Average Ratio on Channel 4132 (826.4 MHz)

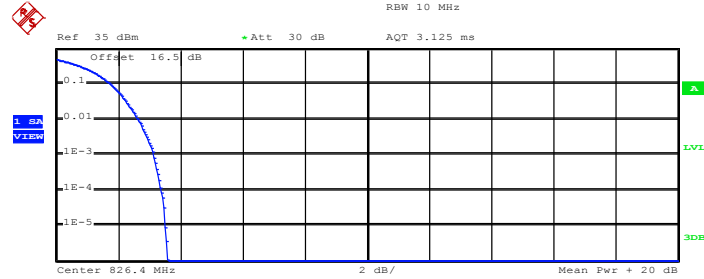

Complementary Cumulative Distribution Function (100000 samples)

Trace 1

Mean	23.28 dBm
Peak	26.86 dBm
Crest	3.58 dB
10 %	1.76 dB
1 %	2.64 dB
.1 %	3.16 dB
.01 %	3.40 dB

Date: 2.OCT.2014 14:33:25

Peak-to-Average Ratio on Channel 4182 (836.4 MHz)

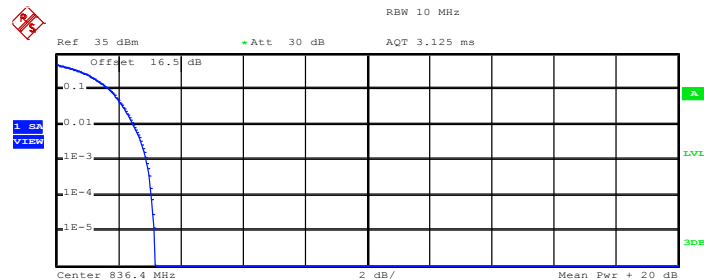

Complementary Cumulative Distribution Function (100000 samples)

Trace 1

Mean	22.90 dBm
Peak	26.08 dBm
Crest	3.18 dB
10 %	1.72 dB
1 %	2.48 dB
.1 %	2.92 dB
.01 %	3.08 dB

Date: 2.OCT.2014 14:34:35



Peak-to-Average Ratio on Channel 4233 (846.6 MHz)

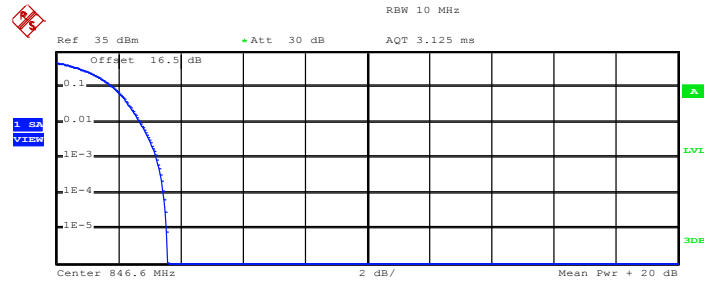

Complementary Cumulative Distribution Function (100000 samples)

Trace 1

Mean	22.30 dBm
Peak	25.87 dBm
Crest	3.57 dB
10 %	1.84 dB
1 %	2.72 dB
.1 %	3.24 dB
.01 %	3.44 dB

Date: 2.OCT.2014 14:35:16



Band :	WCDMA Band IV	Test Mode :	RMC 12.2Kbps Link (QPSK)
---------------	---------------	--------------------	--------------------------

Peak-to-Average Ratio on Channel 1312 (1712.4 MHz)

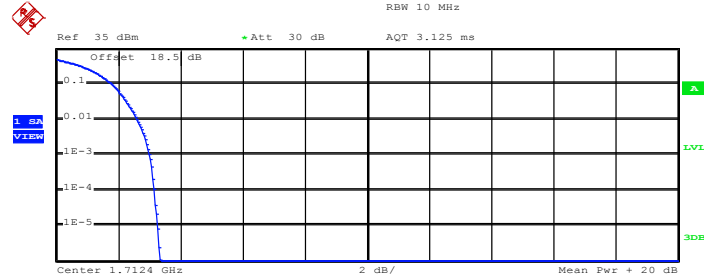

Complementary Cumulative Distribution Function (100000 samples)

Trace 1

Mean	23.95 dBm
Peak	27.28 dBm
Crest	3.33 dB
10 %	1.80 dB
1 %	2.60 dB
.1 %	3.00 dB
.01 %	3.16 dB

Date: 2.OCT.2014 14:00:15

Peak-to-Average Ratio on Channel 1413 (1732.6 MHz)

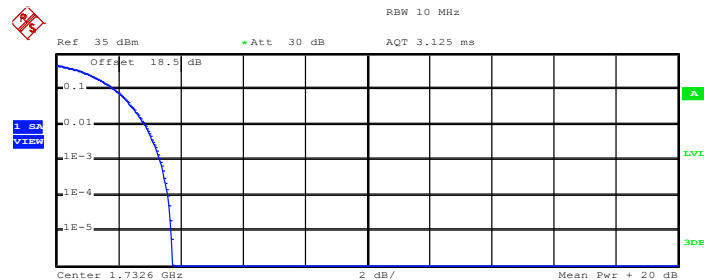

Complementary Cumulative Distribution Function (100000 samples)

Trace 1

Mean	23.60 dBm
Peak	27.35 dBm
Crest	3.76 dB
10 %	1.88 dB
1 %	2.88 dB
.1 %	3.36 dB
.01 %	3.60 dB

Date: 2.OCT.2014 14:00:55



Peak-to-Average Ratio on Channel 1513 (1752.6 MHz)

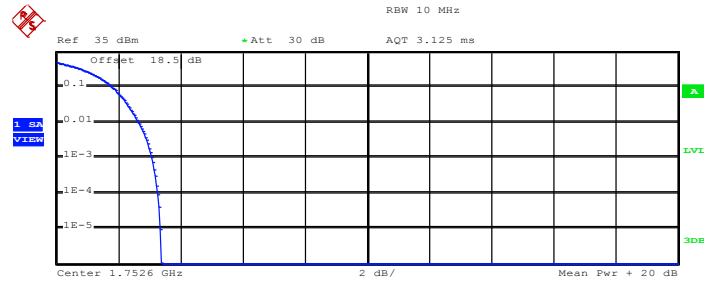

Complementary Cumulative Distribution Function (100000 samples)

Trace 1	
Mean	23.92 dBm
Peak	27.28 dBm
Crest	3.37 dB
10 %	1.84 dB
1 %	2.68 dB
.1 %	3.08 dB
.01 %	3.28 dB

Date: 2.OCT.2014 14:01:30



Band :	WCDMA Band II	Test Mode :	RMC 12.2Kbps Link (QPSK)
---------------	---------------	--------------------	--------------------------

Peak-to-Average Ratio on Channel 9262 (1852.4 MHz)

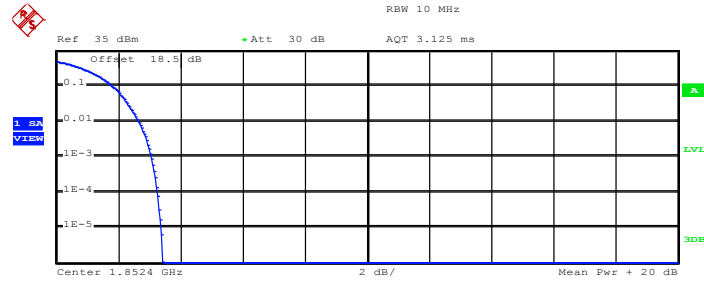

Complementary Cumulative Distribution Function (100000 samples)

Trace 1

Mean	24.12 dBm
Peak	27.56 dBm
Crest	3.44 dB
10 %	1.84 dB
1 %	2.68 dB
.1 %	3.08 dB
.01 %	3.28 dB

Date: 2.OCT.2014 13:36:42

Peak-to-Average Ratio on Channel 9400 (1880.0 MHz)

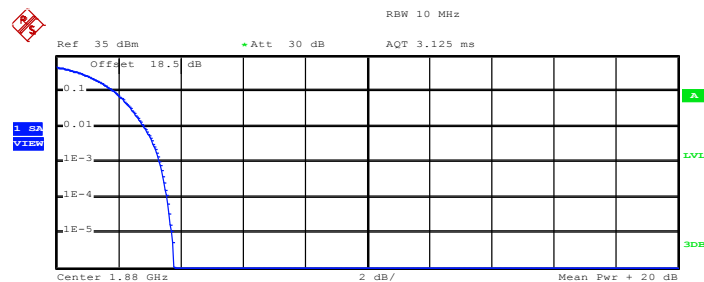

Complementary Cumulative Distribution Function (100000 samples)

Trace 1

Mean	24.05 dBm
Peak	27.85 dBm
Crest	3.79 dB
10 %	1.88 dB
1 %	2.84 dB
.1 %	3.32 dB
.01 %	3.56 dB

Date: 2.OCT.2014 13:37:29



Peak-to-Average Ratio on Channel 9538 (1907.6 MHz)

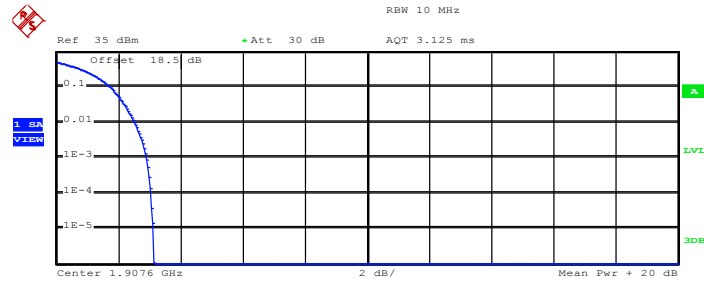

Complementary Cumulative Distribution Function (100000 samples)

Trace 1

Mean	23.29 dBm
Peak	26.43 dBm
Crest	3.14 dB
10 %	1.76 dB
1 %	2.52 dB
.1 %	2.92 dB
.01 %	3.04 dB

Date: 2.OCT.2014 13:38:09

3.3 99% Occupied Bandwidth and 26dB Bandwidth Measurement

3.3.1 Description of 99% Occupied Bandwidth and 26dB Bandwidth Measurement

The 99% occupied bandwidth is the width of a frequency band such that, below the lower and above the upper frequency limits, the mean powers emitted are each equal to a specified percentage 0.5% of the total mean transmitted power.

The emission bandwidth is defined as the width of the signal between two points, located at the 2 sides of the carrier frequency, outside of which all emissions are attenuated at least 26 dB below the transmitter power.

3.3.2 Measuring Instruments

The measuring equipment is listed in the section 4 of this test report.

3.3.3 Test Procedures

1. The testing follows FCC KDB 971168 v02r01 Section 4.2.
2. The EUT was connected to the spectrum analyzer and system simulator via a power divider.
3. The RF output of the EUT was connected to the spectrum analyzer by RF cable and attenuator. The path loss was compensated to the results for each measurement.
4. The 99% occupied bandwidth were measured, set RBW= 1% of span, VBW= 3*RBW, sample detector, trace maximum hold.
5. The 26dB bandwidth were measured, set RBW= 1% of EBW, VBW= 3*RBW, peak detector, trace maximum hold.

3.3.4 Test Setup

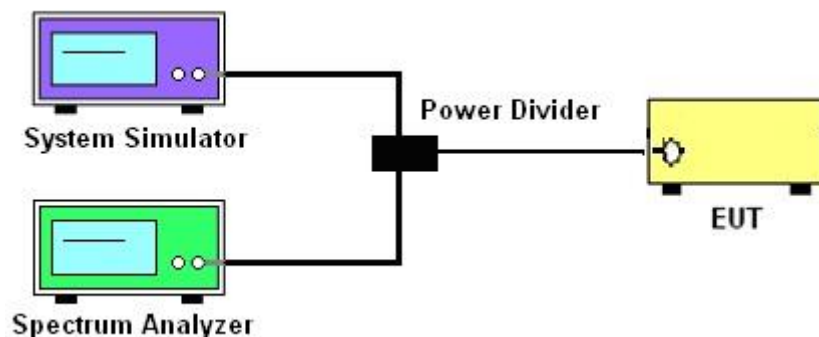



3.3.5 Test Result of Occupied Bandwidth and 26dB Bandwidth

Cellular Band						
Modes	GSM850 (GPRS class 8)			GSM850 (EDGE class 8)		
Channel	128 (Low)	189 (Mid)	251 (High)	128 (Low)	189 (Mid)	251 (High)
Frequency (MHz)	824.2	836.4	848.8	824.2	836.4	848.8
99% OBW (kHz)	248.00	246.00	248.00	248.00	250.00	246.00
26dB BW (kHz)	314.00	318.00	314.00	312.00	310.00	306.00

PCS Band						
Modes	GSM1900 (GPRS class 8)			GSM1900 (EDGE class 8)		
Channel	512 (Low)	661 (Mid)	810 (High)	512 (Low)	661 (Mid)	810 (High)
Frequency (MHz)	1850.2	1880	1909.8	1850.2	1880	1909.8
99% OBW (kHz)	242.00	244.00	248.00	242.00	244.00	242.00
26dB BW (kHz)	312.00	314.00	316.00	304.00	308.00	314.00

Cellular Band			
Modes	WCDMA Band V (RMC 12.2Kbps)		
Channel	4132 (Low)	4182 (Mid)	4233 (High)
Frequency (MHz)	826.4	836.4	846.6
99% OBW (MHz)	4.16	4.16	4.18
26dB BW (MHz)	4.68	4.68	4.68



AWS Band			
Modes	WCDMA Band IV (RMC 12.2Kbps)		
Channel	1312(Low)	1413 (Mid)	1513 (High)
Frequency (MHz)	1712.4	1732.6	1752.6
99% OBW (MHz)	4.18	4.16	4.18
26dB BW (MHz)	4.68	4.68	4.66

PCS Band			
Modes	WCDMA Band II (RMC 12.2Kbps)		
Channel	9262 (Low)	9400 (Mid)	9538 (High)
Frequency (MHz)	1852.4	1880	1907.6
99% OBW (MHz)	4.18	4.18	4.16
26dB BW (MHz)	4.68	4.68	4.66



3.3.6 Test Result (Plots) of Occupied Bandwidth and 26dB Bandwidth

Band :	GSM 850	Test Mode :	GPRS class 8 Link (GMSK)
--------	---------	-------------	--------------------------

99% Occupied Bandwidth Plot on Channel 128 (824.2 MHz)

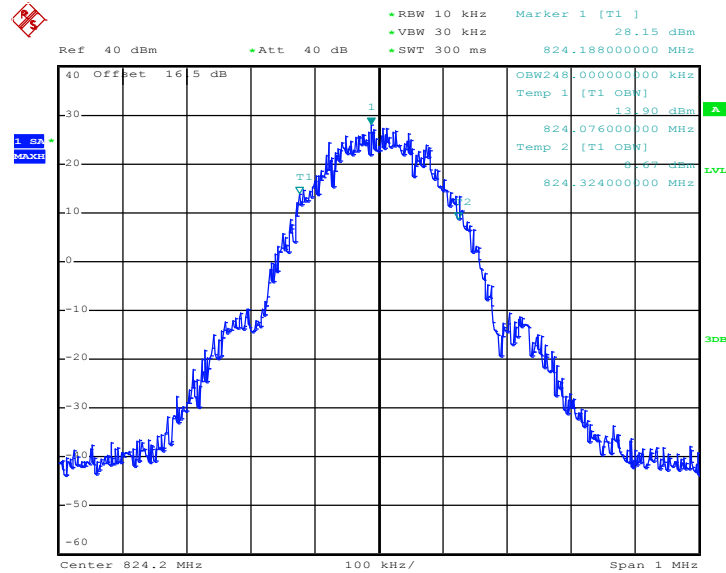

Date: 30.SEP.2014 15:58:03

26dB Bandwidth Plot on Channel 128 (824.2 MHz)

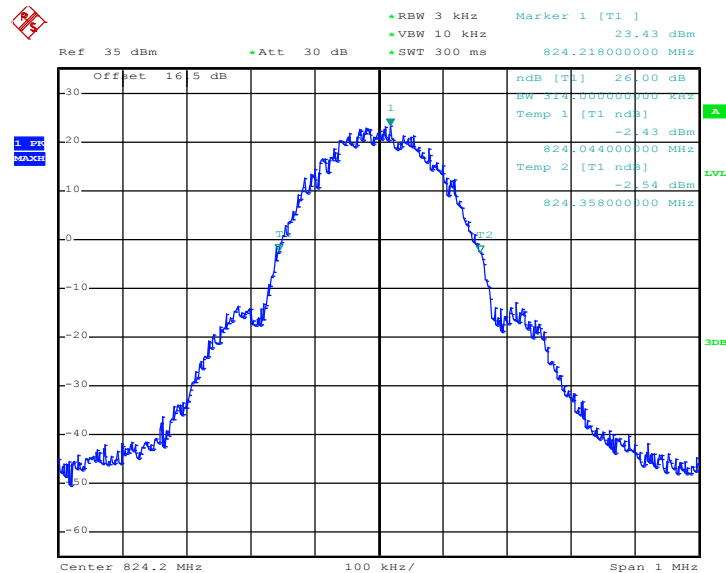

Date: 30.SEP.2014 15:29:57



99% Occupied Bandwidth Plot on Channel 189 (836.4 MHz)

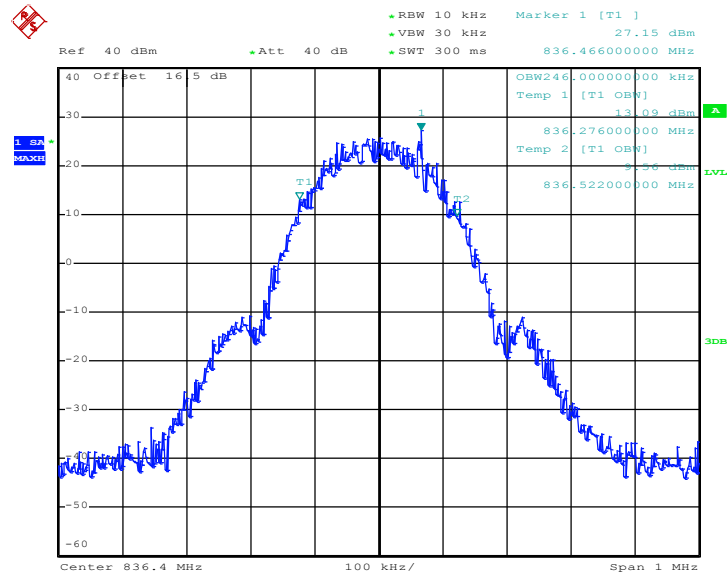

Date: 30.SEP.2014 15:36:04

26dB Bandwidth Plot on Channel 189 (836.4 MHz)

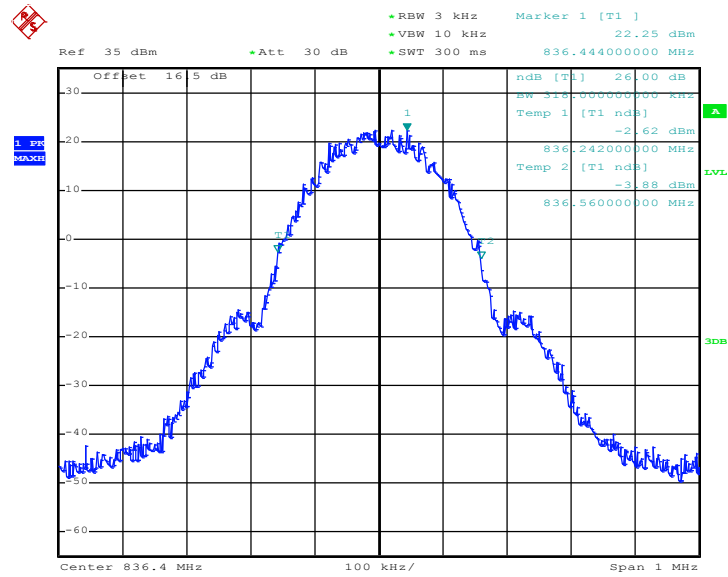

Date: 30.SEP.2014 15:30:32



99% Occupied Bandwidth Plot on Channel 251 (848.8 MHz)

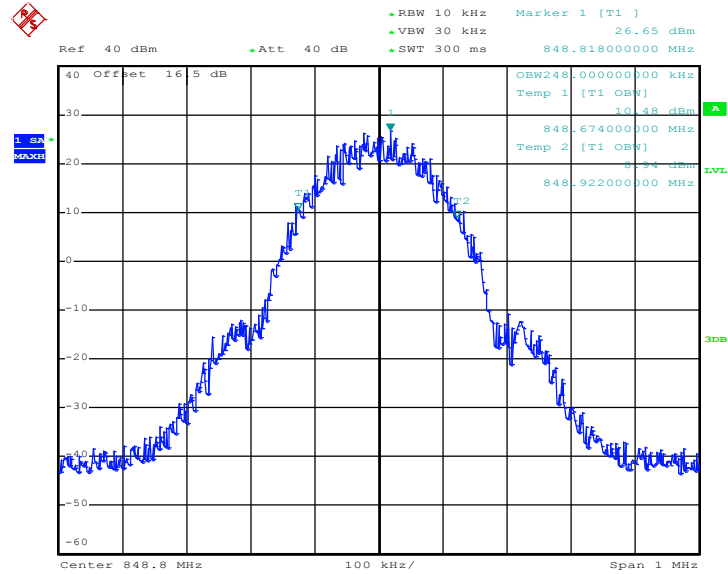

Date: 30.SEP.2014 15:36:50

26dB Bandwidth Plot on Channel 251 (848.8 MHz)

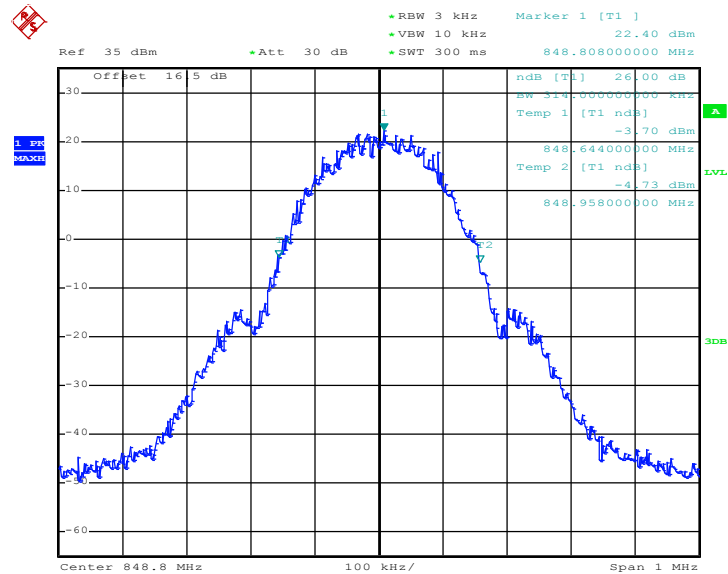

Date: 30.SEP.2014 15:31:10



Band :	GSM 850	Test Mode :	EDGE class 8 Link (8PSK)
---------------	---------	--------------------	--------------------------

99% Occupied Bandwidth Plot on Channel 128 (824.2 MHz)

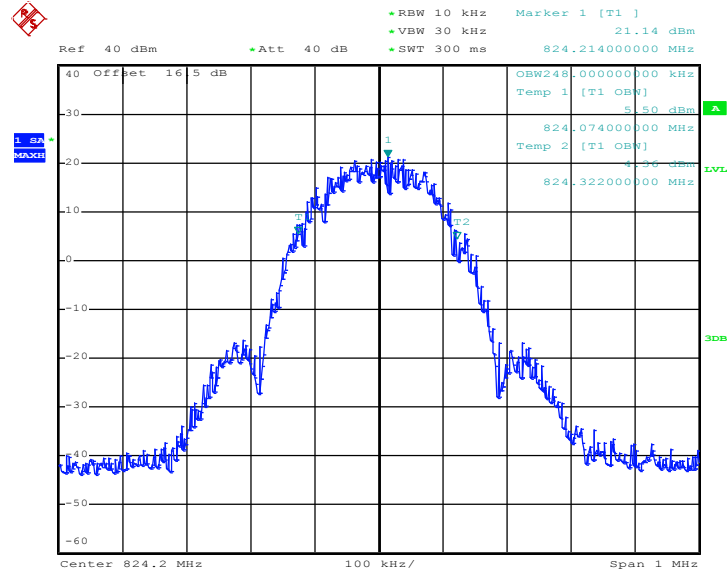

Date: 30.SEP.2014 16:36:35

26dB Bandwidth Plot on Channel 128 (824.2 MHz)

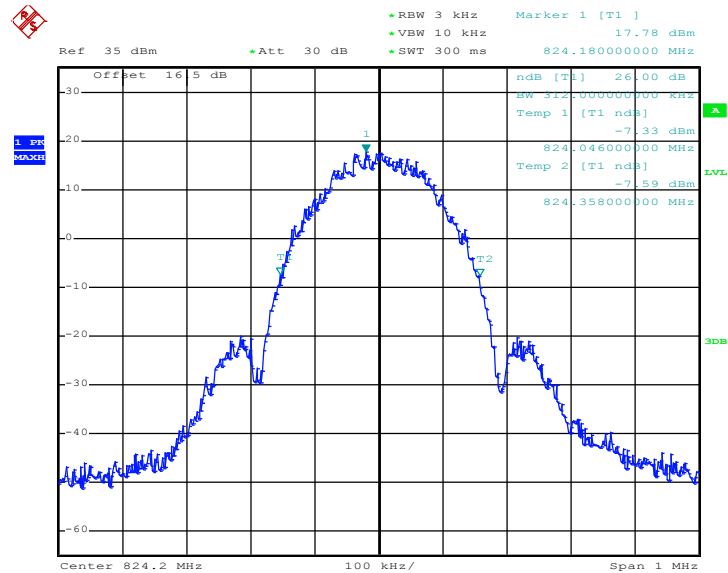

Date: 30.SEP.2014 16:31:09



99% Occupied Bandwidth Plot on Channel 189 (836.4 MHz)

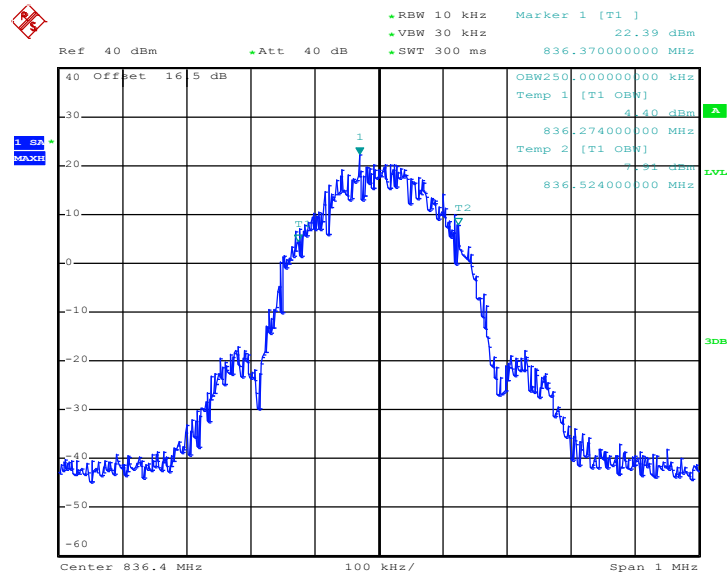

Date: 30.SEP.2014 16:37:10

26dB Bandwidth Plot on Channel 189 (836.4 MHz)

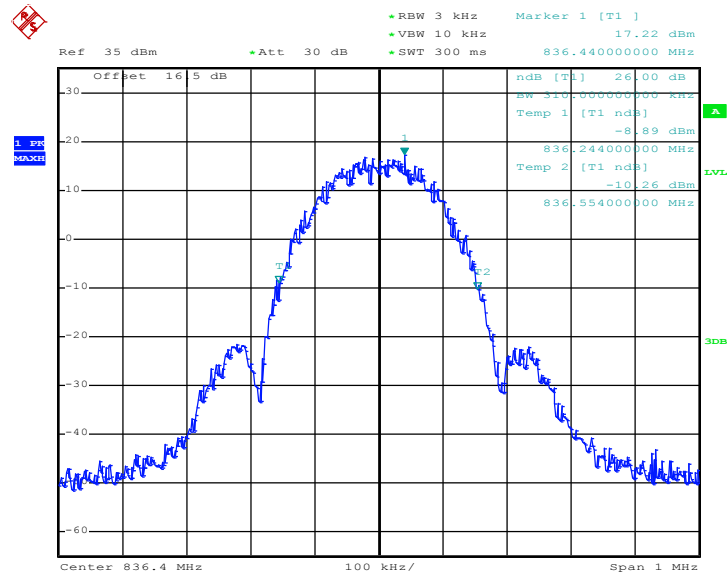

Date: 30.SEP.2014 16:31:43



99% Occupied Bandwidth Plot on Channel 251 (848.8 MHz)

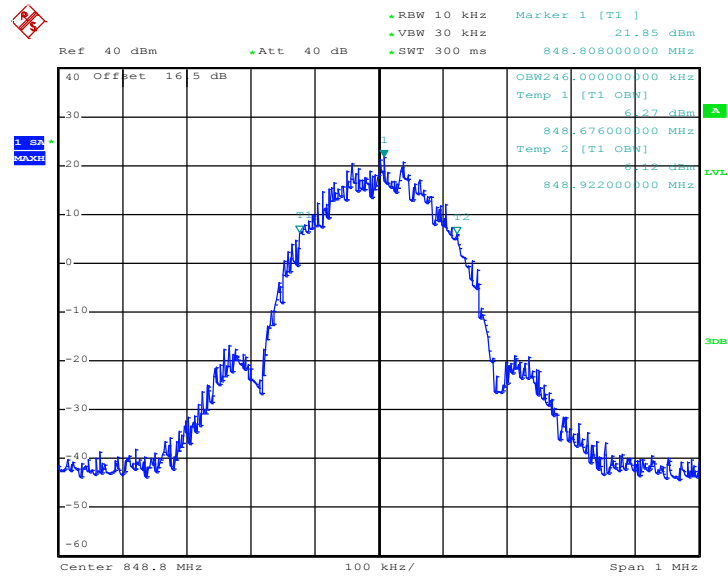

Date: 30.SEP.2014 16:35:39

26dB Bandwidth Plot on Channel 251 (848.8 MHz)

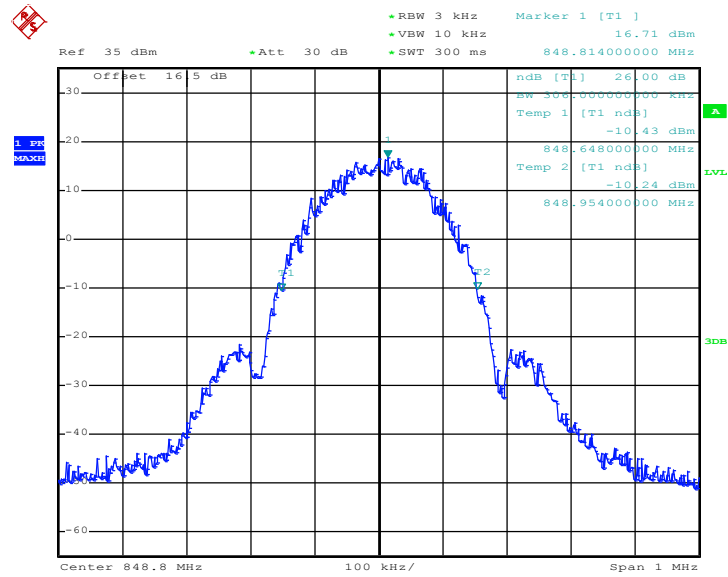

Date: 30.SEP.2014 16:32:20



Band :	GSM 1900	Test Mode :	GPRS class 8 Link (GMSK)
---------------	----------	--------------------	--------------------------

99% Occupied Bandwidth Plot on Channel 512 (1850.2 MHz)

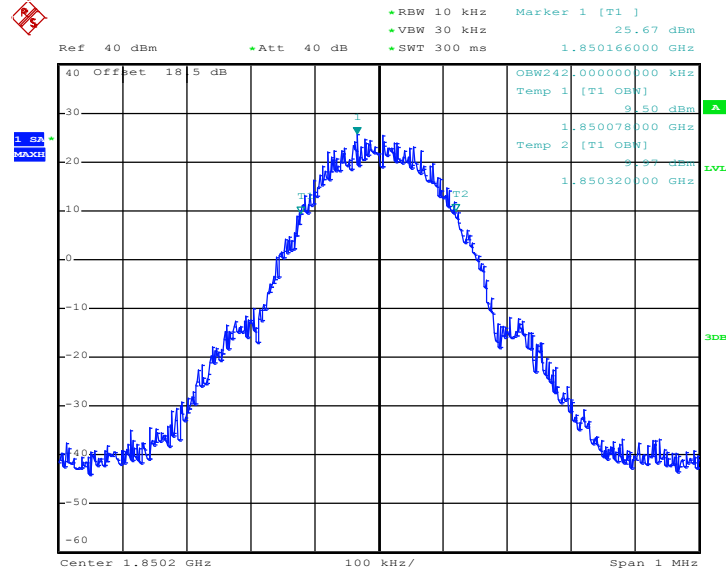

Date: 2.OCT.2014 10:28:42

26dB Bandwidth Plot on Channel 512 (1850.2 MHz)

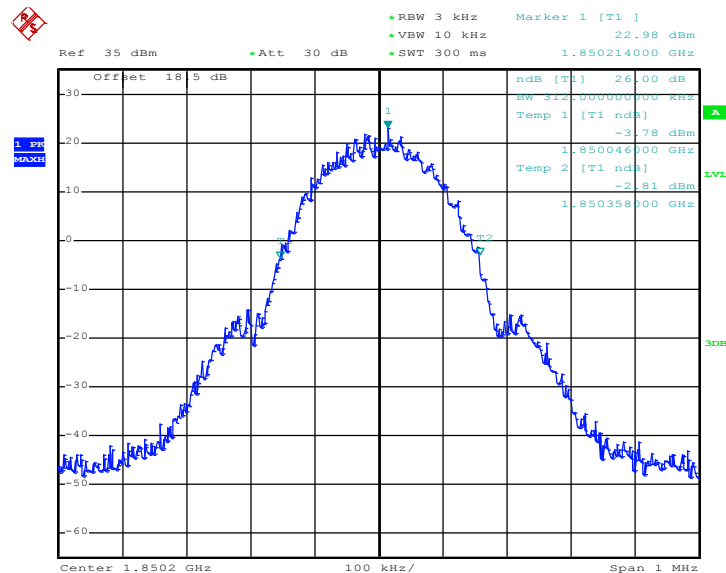

Date: 2.OCT.2014 10:21:28



99% Occupied Bandwidth Plot on Channel 661 (1880.0 MHz)

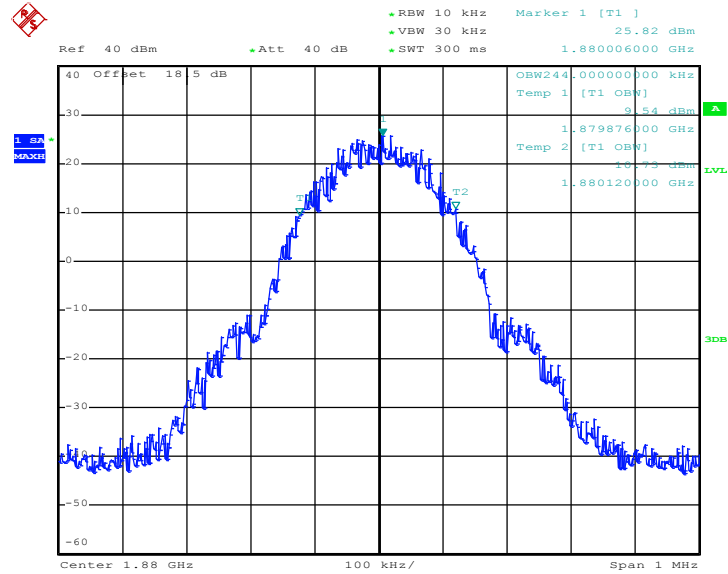

Date: 2.OCT.2014 10:29:21

26dB Bandwidth Plot on Channel 661 (1880.0 MHz)

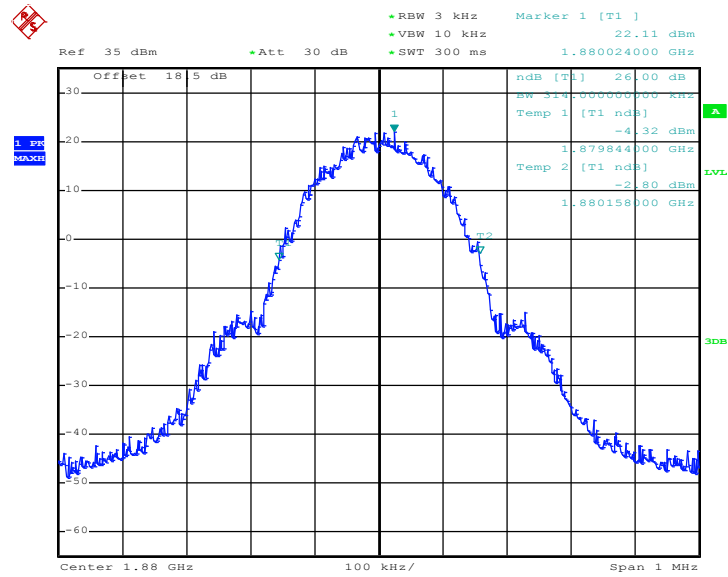

Date: 2.OCT.2014 10:22:01



99% Occupied Bandwidth Plot on Channel 810 (1909.8 MHz)

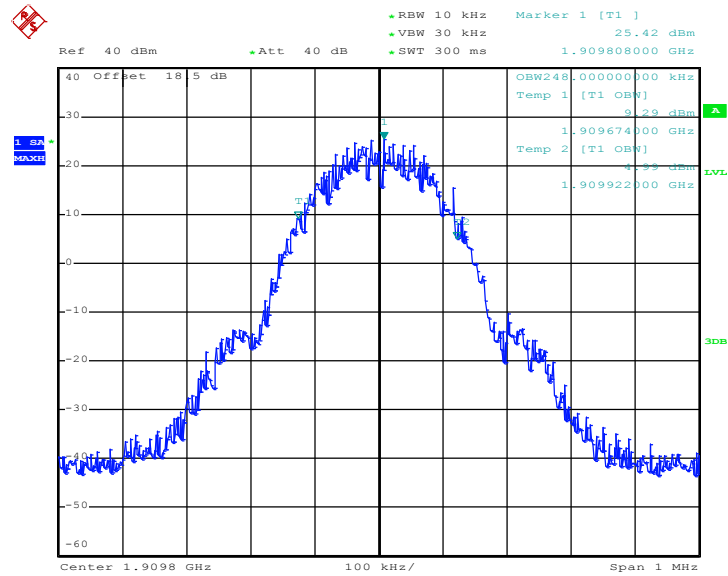

Date: 2.OCT.2014 10:25:18

26dB Bandwidth Plot on Channel 810 (1909.8 MHz)

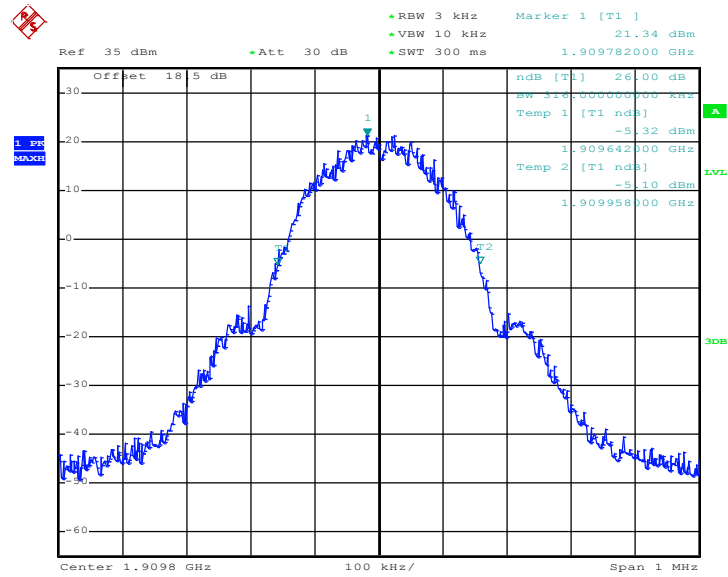

Date: 2.OCT.2014 10:22:41



Band :	GSM 1900	Test Mode :	EDGE class 8 Link (8PSK)
---------------	----------	--------------------	--------------------------

99% Occupied Bandwidth Plot on Channel 512 (1850.2 MHz)

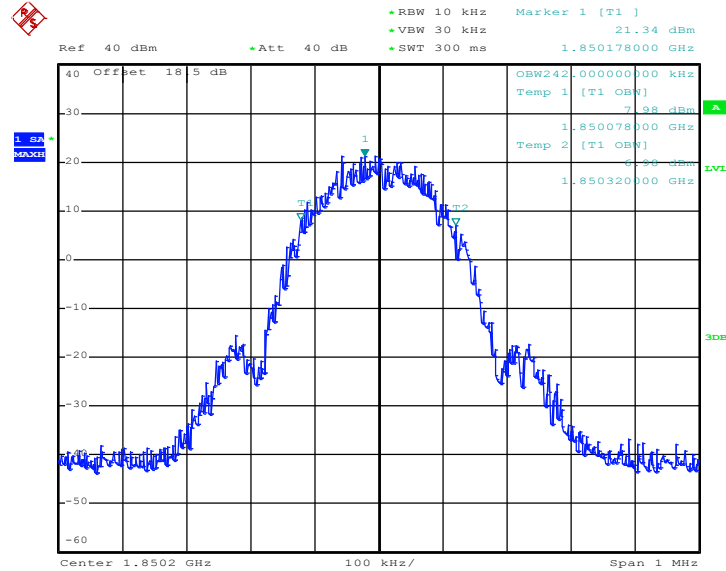

Date: 2.OCT.2014 11:31:45

26dB Bandwidth Plot on Channel 512 (1850.2 MHz)

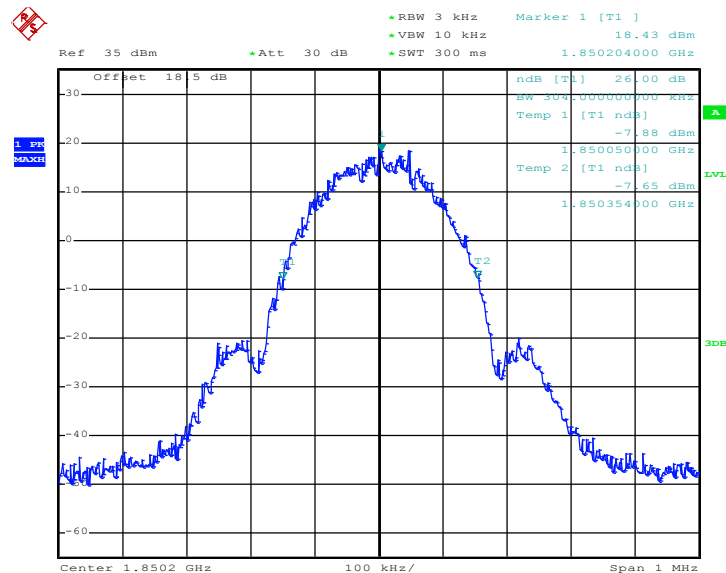

Date: 2.OCT.2014 11:26:21



99% Occupied Bandwidth Plot on Channel 661 (1880.0 MHz)

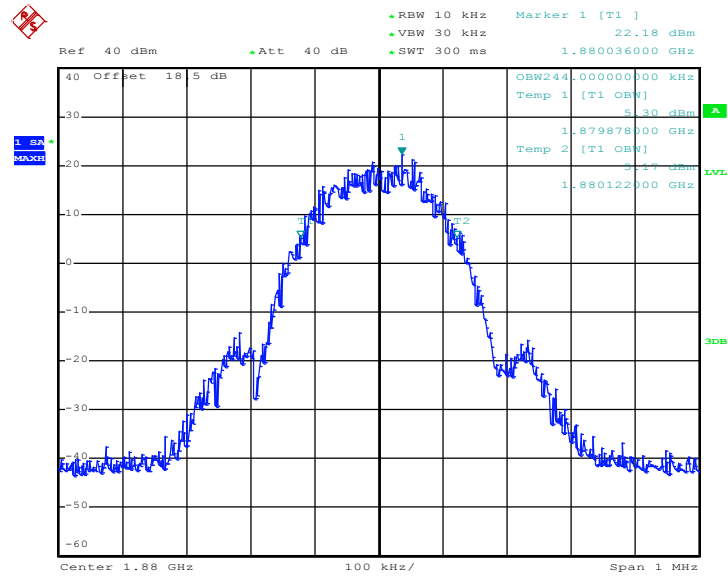

Date: 2.OCT.2014 11:32:20

26dB Bandwidth Plot on Channel 661 (1880.0 MHz)

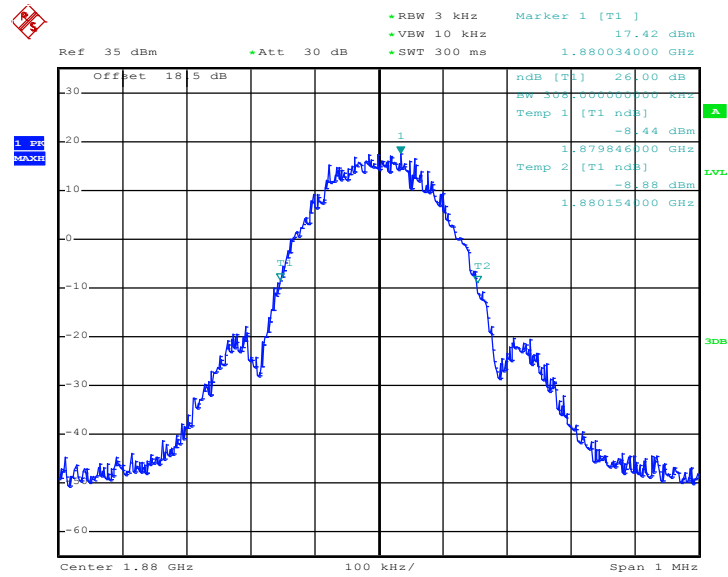

Date: 2.OCT.2014 11:26:53



99% Occupied Bandwidth Plot on Channel 810 (1909.8 MHz)

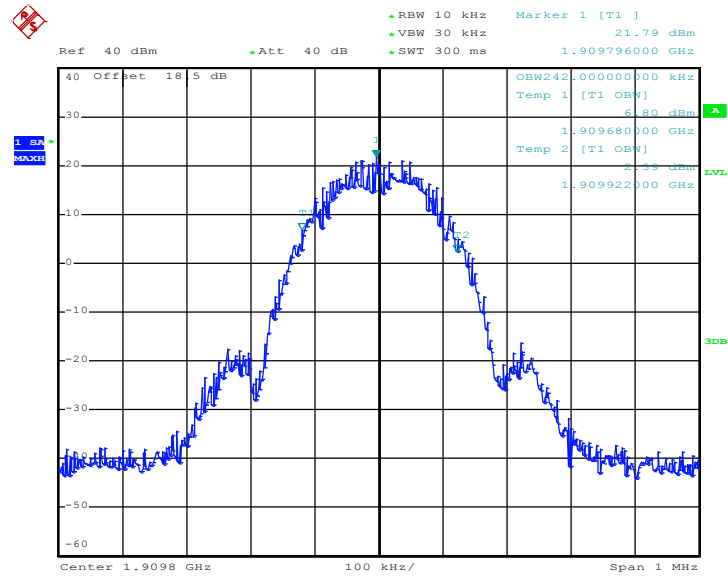

Date: 2.OCT.2014 11:29:27

26dB Bandwidth Plot on Channel 810 (1909.8 MHz)

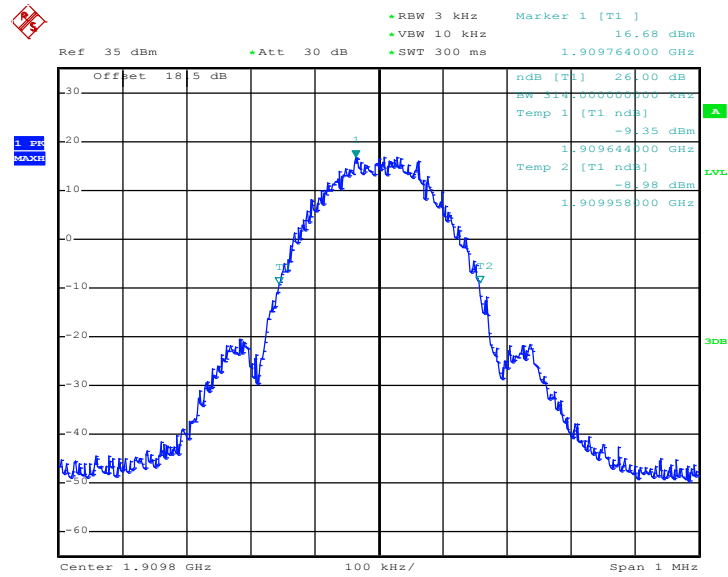

Date: 2.OCT.2014 11:27:26



Band :	WCDMA Band V	Test Mode :	RMC 12.2Kbps Link (QPSK)
---------------	--------------	--------------------	--------------------------

99% Occupied Bandwidth Plot on Channel 4132 (826.4 MHz)

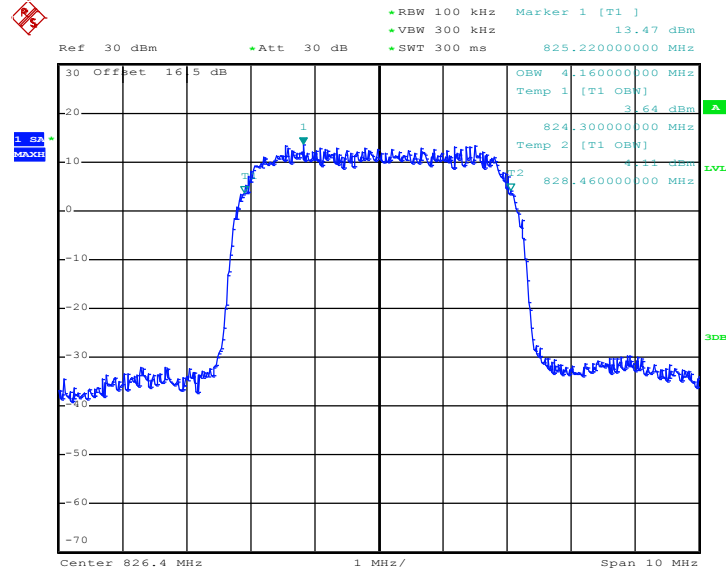

Date: 2.OCT.2014 14:54:27

26dB Bandwidth Plot on Channel 4132 (826.4 MHz)

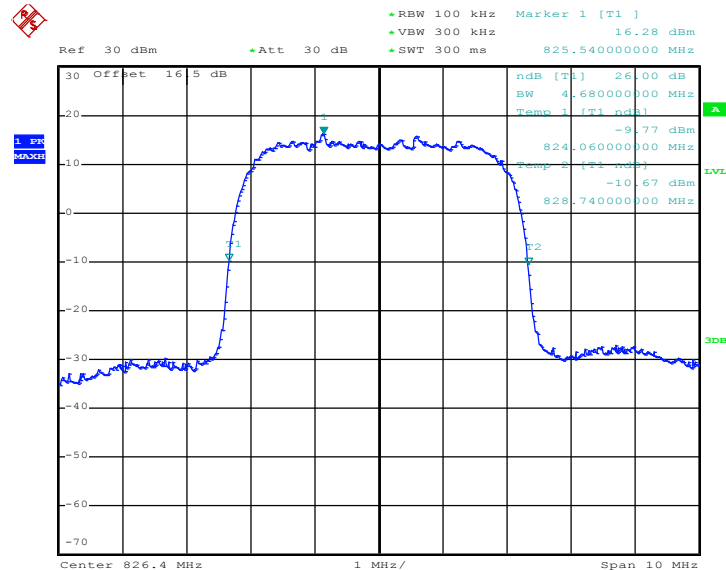

Date: 2.OCT.2014 14:45:31



99% Occupied Bandwidth Plot on Channel 4182 (836.4 MHz)

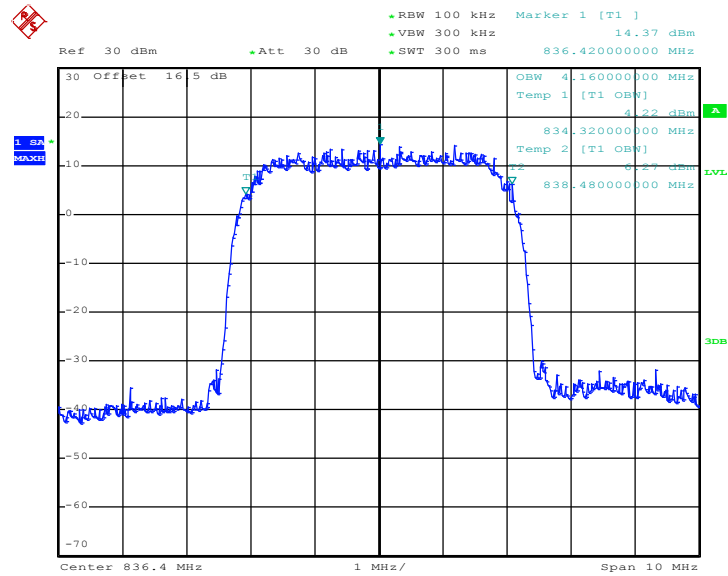

Date: 2.OCT.2014 14:54:56

26dB Bandwidth Plot on Channel 4182 (836.4 MHz)

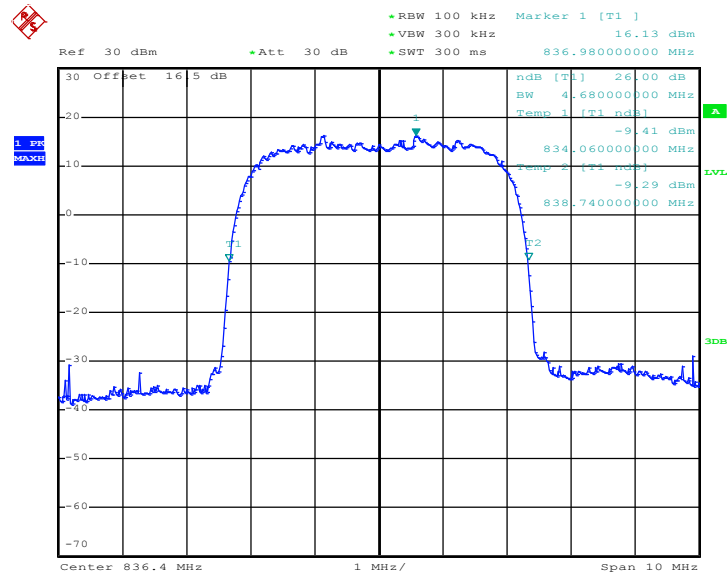

Date: 2.OCT.2014 14:50:54



99% Occupied Bandwidth Plot on Channel 4233 (846.6 MHz)

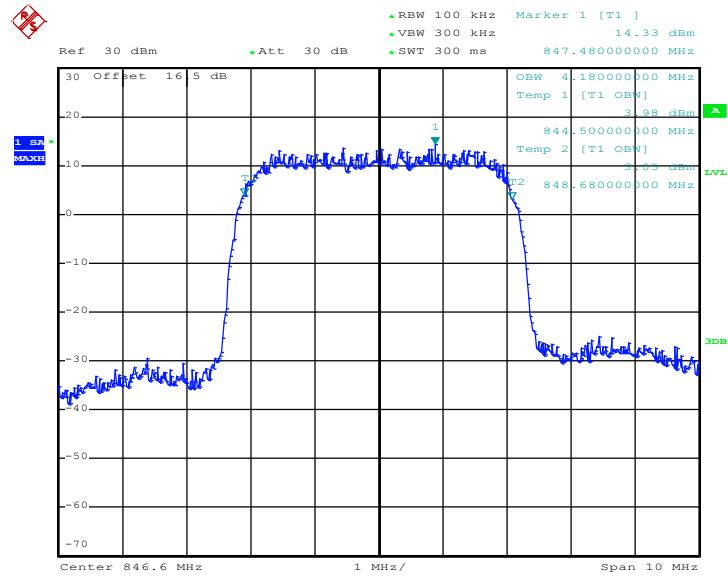

Date: 2.OCT.2014 14:55:24

26dB Bandwidth Plot on Channel 4233 (846.6 MHz)

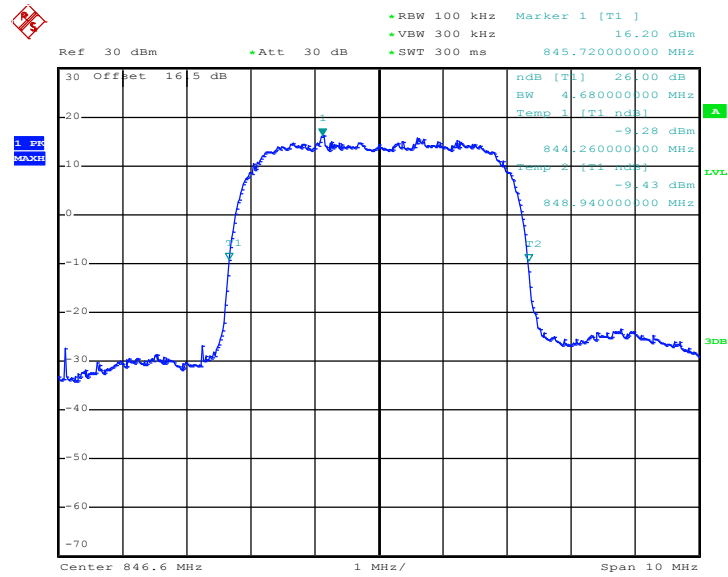

Date: 2.OCT.2014 14:50:15



Band :	WCDMA Band IV	Test Mode :	RMC 12.2Kbps Link (QPSK)
---------------	---------------	--------------------	--------------------------

99% Occupied Bandwidth Plot on Channel 1312 (1712.4 MHz)

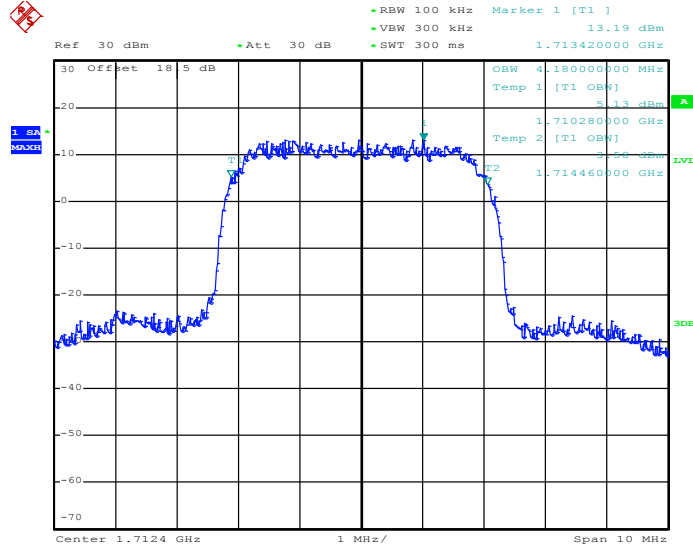

Date: 2.OCT.2014 14:16:46

26dB Bandwidth Plot on Channel 1312 (1712.4 MHz)

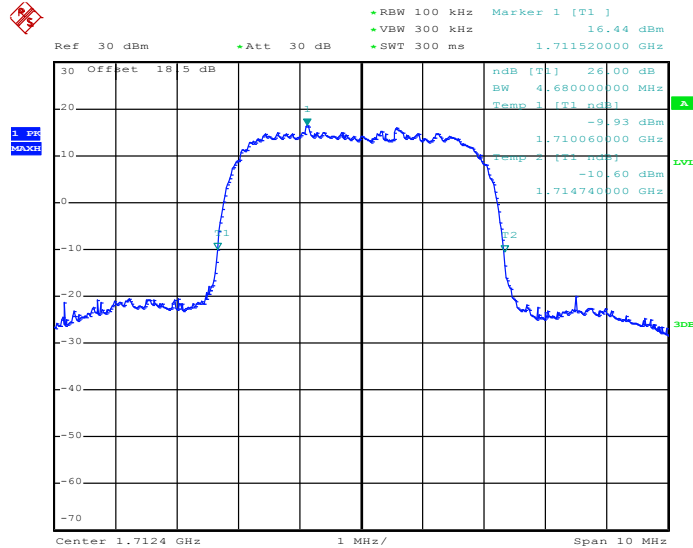

Date: 2.OCT.2014 14:12:49



99% Occupied Bandwidth Plot on Channel 1413 (1732.6 MHz)

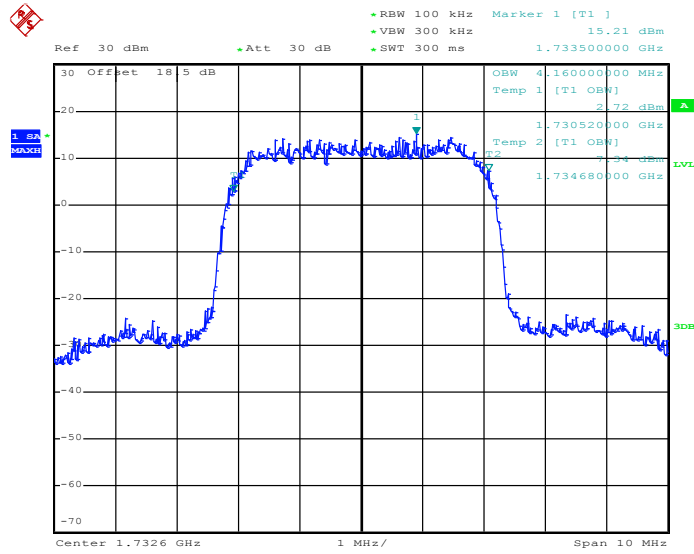

Date: 2.OCT.2014 14:15:30

26dB Bandwidth Plot on Channel 1413 (1732.6 MHz)

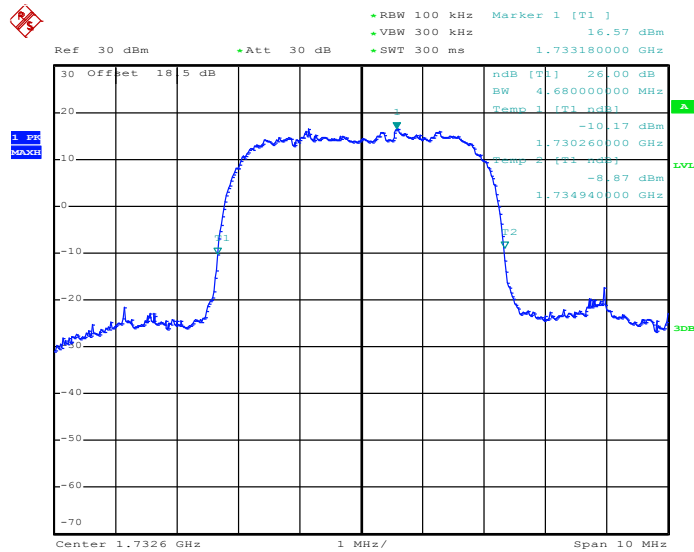

Date: 2.OCT.2014 14:13:17



99% Occupied Bandwidth Plot on Channel 1513 (1752.6 MHz)

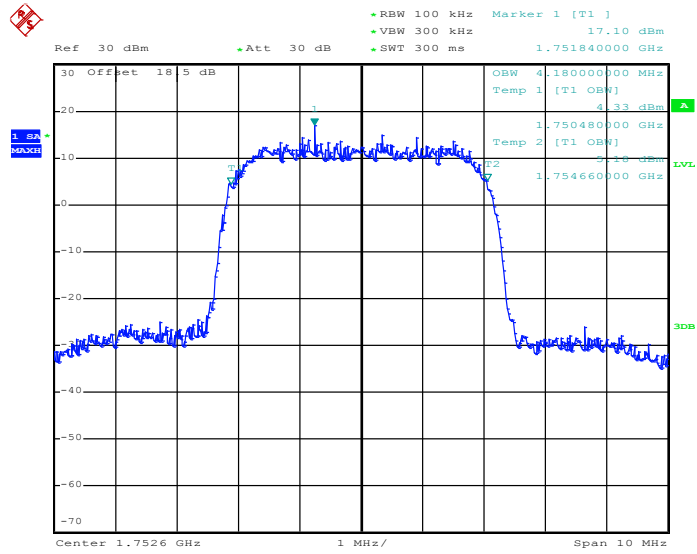

Date: 2.OCT.2014 14:15:59

26dB Bandwidth Plot on Channel 1513 (1752.6 MHz)

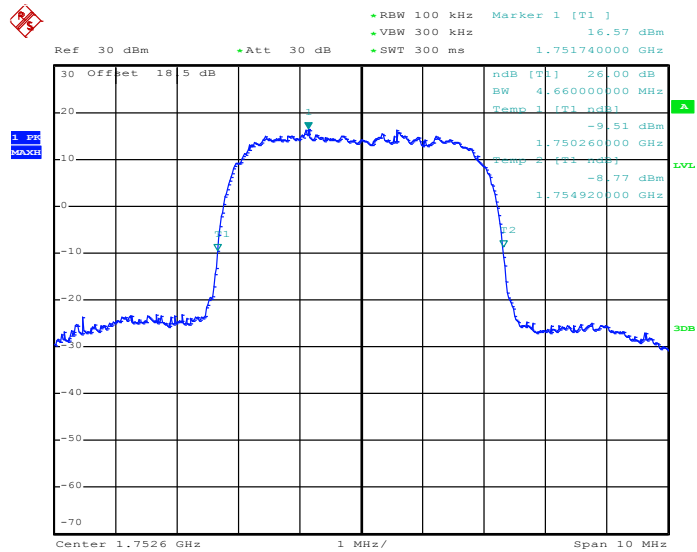

Date: 2.OCT.2014 14:14:28



Band :	WCDMA Band II	Test Mode :	RMC 12.2Kbps Link (QPSK)
---------------	---------------	--------------------	--------------------------

99% Occupied Bandwidth Plot on Channel 9262 (1852.4 MHz)

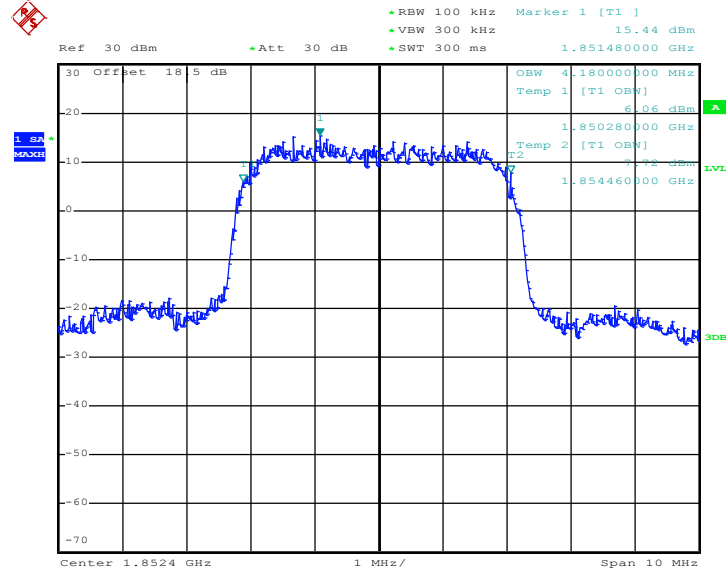

Date: 2.OCT.2014 13:49:28

26dB Bandwidth Plot on Channel 9262 (1852.4 MHz)

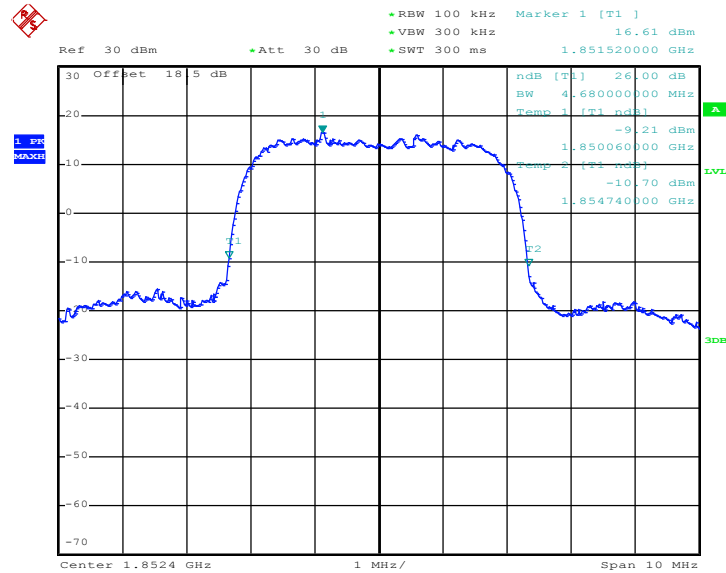

Date: 2.OCT.2014 13:47:40



99% Occupied Bandwidth Plot on Channel 9400 (1880.0 MHz)

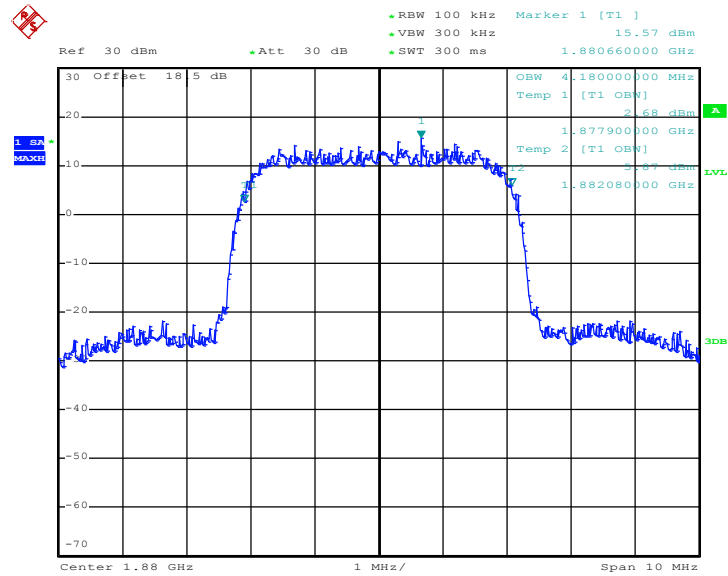

Date: 2.OCT.2014 13:49:57

26dB Bandwidth Plot on Channel 9400 (1880.0 MHz)

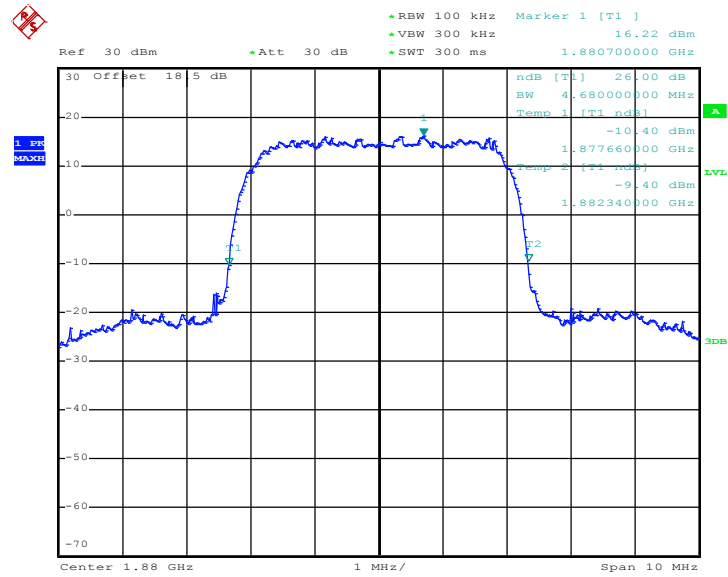

Date: 2.OCT.2014 13:48:09



99% Occupied Bandwidth Plot on Channel 9538 (1907.6 MHz)

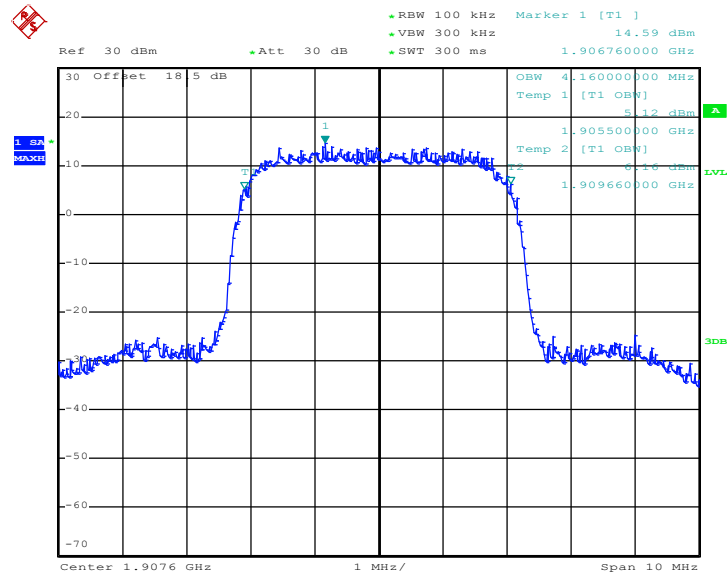

Date: 2.OCT.2014 13:50:25

26dB Bandwidth Plot on Channel 9538 (1907.6 MHz)

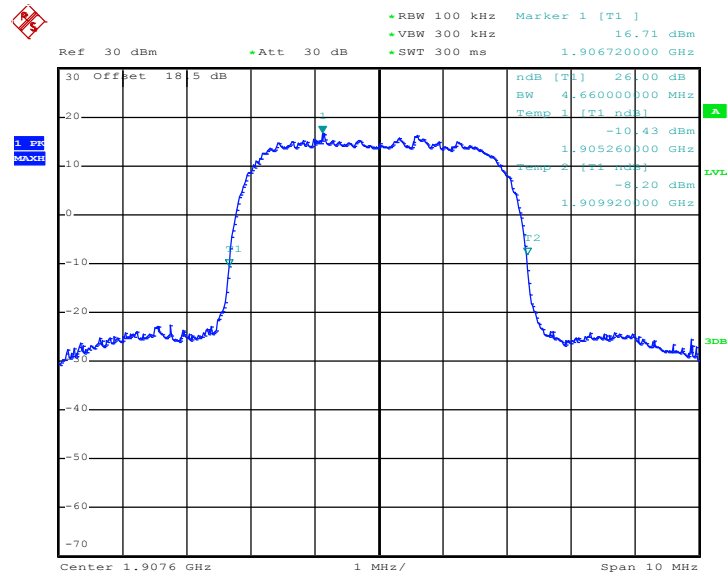

Date: 2.OCT.2014 13:48:38

3.4 Band Edge Measurement

3.4.1 Description of Band Edge Measurement

The power of any emission outside of the authorized operating frequency ranges must be lower than the transmitter power (P) by a factor of at least $43 + 10 \log (P)$ dB.

3.4.2 Measuring Instruments

The measuring equipment is listed in the section 4 of this test report.

3.4.3 Test Procedures

1. The testing follows FCC KDB 971168 v02r01 Section 6.0.
2. The EUT was connected to the spectrum analyzer and system simulator via a power divider.
3. The RF output of EUT was connected to the spectrum analyzer by an RF cable and attenuator. The path loss was compensated to the results for each measurement.
4. The band edges of low and high channels for the highest RF powers were measured.
5. The RF fundamental frequency should be excluded against the limit line in the operating frequency band.
6. The limit line is derived from $43 + 10\log(P)$ dB below the transmitter power P(Watts)
 $= P(W) - [43 + 10\log(P)] \text{ (dB)}$
 $= [30 + 10\log(P)] \text{ (dBm)} - [43 + 10\log(P)] \text{ (dB)}$
 $= -13\text{dBm}.$

3.4.4 Test Setup

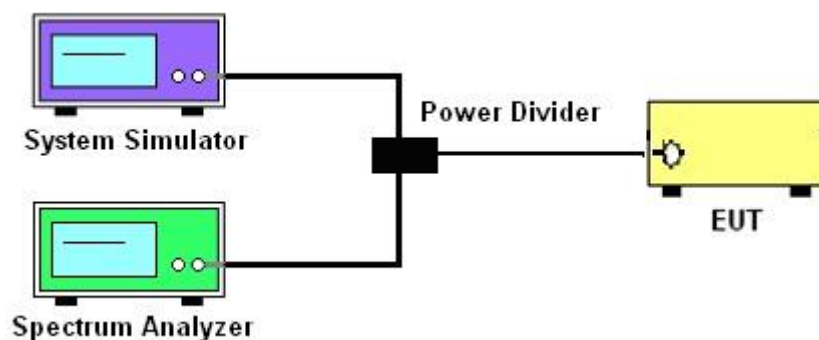



3.4.5 Test Result (Plots) of Conducted Band Edge

Band :	GSM850	Test Mode :	GPRS class 8 Link (GMSK)
--------	--------	-------------	--------------------------

Lower Band Edge Plot on Channel 128 (824.2 MHz)

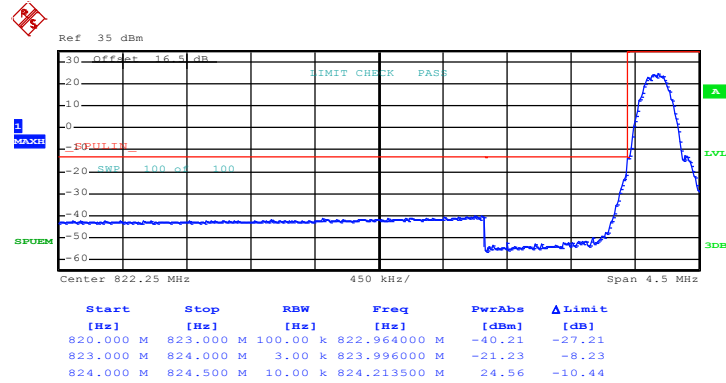

Date: 30.SEP.2014 15:26:55

Higher Band Edge Plot on Channel 251 (848.8 MHz)

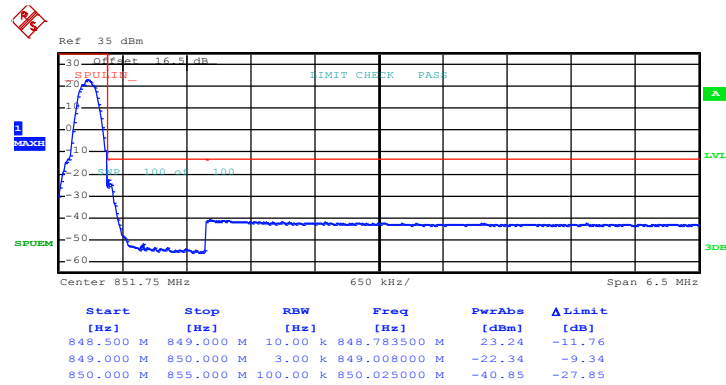

Date: 30.SEP.2014 15:23:43



Band :	GSM850	Test Mode :	EDGE class 8 Link (8PSK)
--------	--------	-------------	--------------------------

Lower Band Edge Plot on Channel 128 (824.2 MHz)

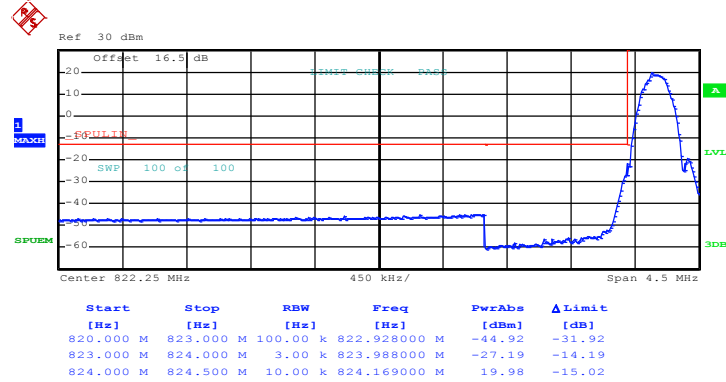

Date: 30.SEP.2014 16:27:47

Higher Band Edge Plot on Channel 251 (848.8 MHz)

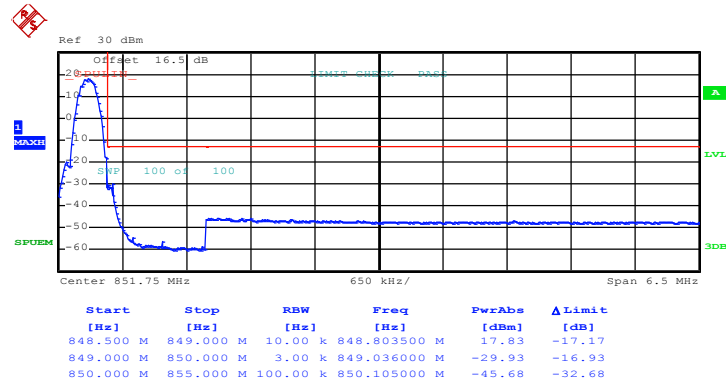

Date: 30.SEP.2014 16:22:24



Band :	GSM1900	Test Mode :	GPRS class 8 Link (GMSK)
--------	---------	-------------	--------------------------

Lower Band Edge Plot on Channel 512 (1850.2 MHz)

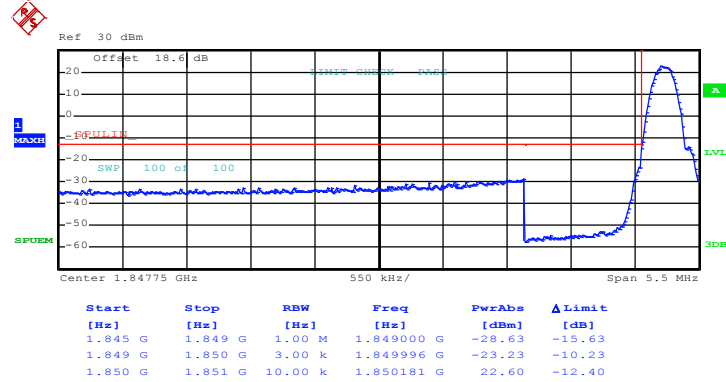

Date: 2.OCT.2014 10:08:41

Higher Band Edge Plot on Channel 810 (1909.8 MHz)

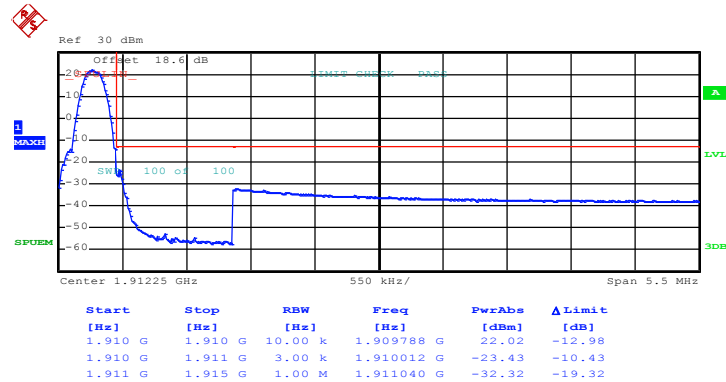

Date: 2.OCT.2014 10:04:53



Band :	GSM1900	Test Mode :	EDGE class 8 Link (8PSK)
--------	---------	-------------	--------------------------

Lower Band Edge Plot on Channel 512 (1850.2 MHz)

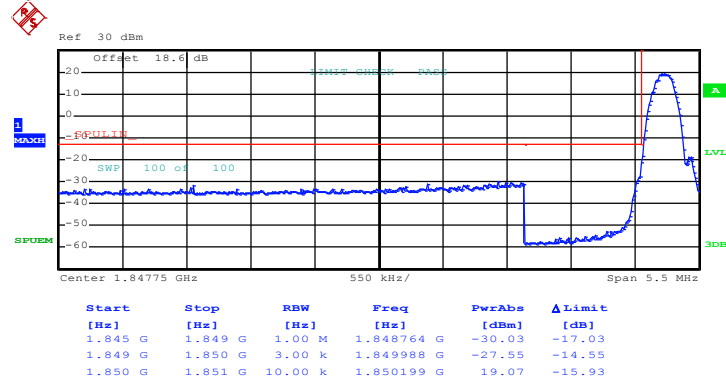

Date: 2.OCT.2014 11:23:56

Higher Band Edge Plot on Channel 810 (1909.8 MHz)

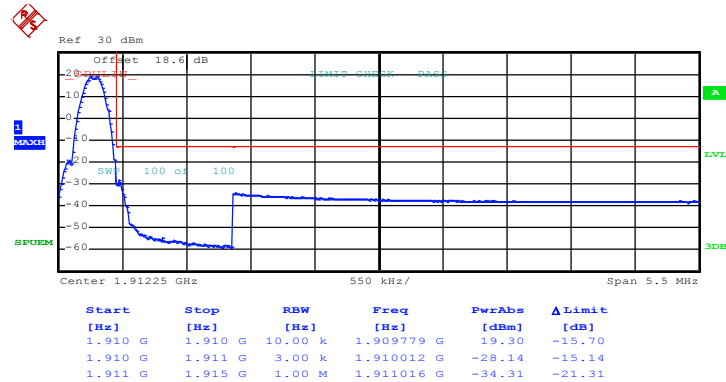

Date: 2.OCT.2014 11:19:06



Band :	WCDMA Band V	Test Mode :	RMC 12.2Kbps Link (QPSK)
--------	--------------	-------------	--------------------------

Lower Band Edge Plot on Channel 4132 (826.4 MHz)

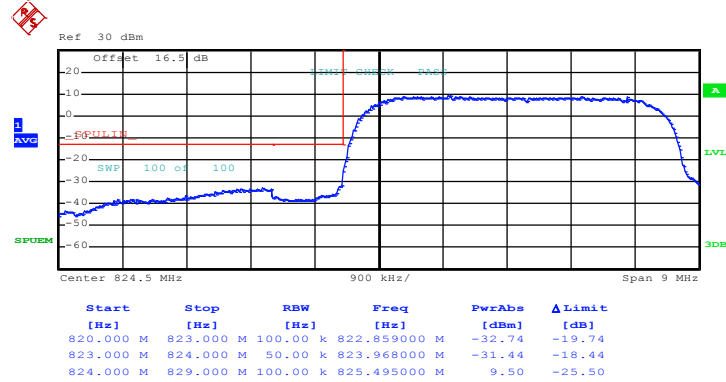

Date: 2.OCT.2014 14:41:59

Higher Band Edge Plot on Channel 4233 (846.6 MHz)

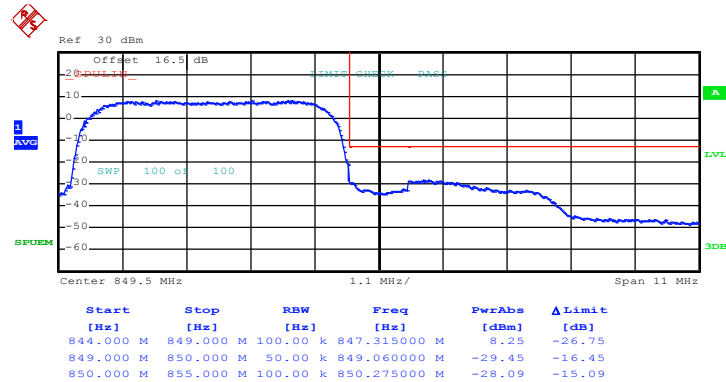

Date: 2.OCT.2014 14:38:10



Band :	WCDMA Band IV	Test Mode :	RMC 12.2Kbps Link (QPSK)
--------	---------------	-------------	--------------------------

Lower Band Edge Plot on Channel 1312 (1712.4 MHz)

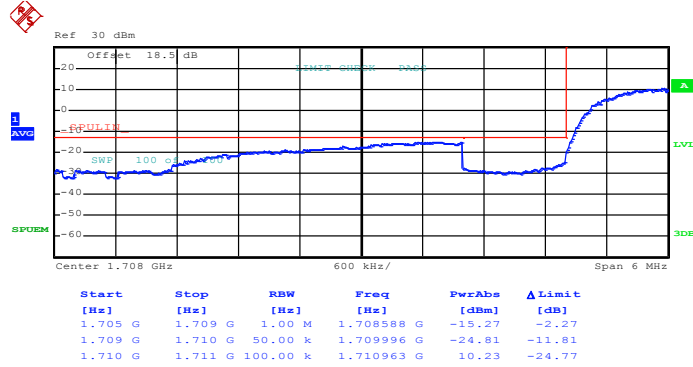

Date: 2.OCT.2014 14:10:01

Higher Band Edge Plot on Channel 1513 (1752.6 MHz)

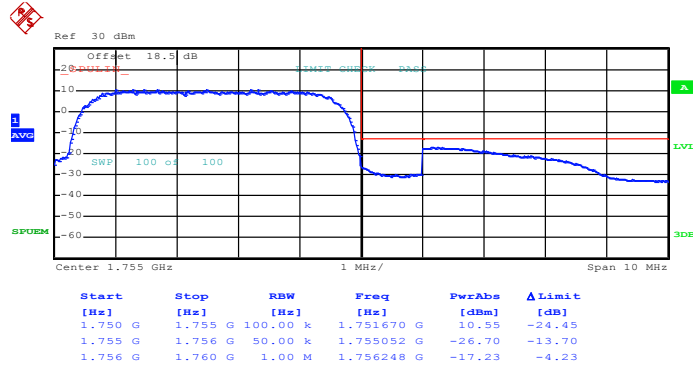

Date: 2.OCT.2014 14:06:33



Band :	WCDMA Band II	Test Mode :	RMC 12.2Kbps Link (QPSK)
--------	---------------	-------------	--------------------------

Lower Band Edge Plot on Channel 9262 (1852.4 MHz)

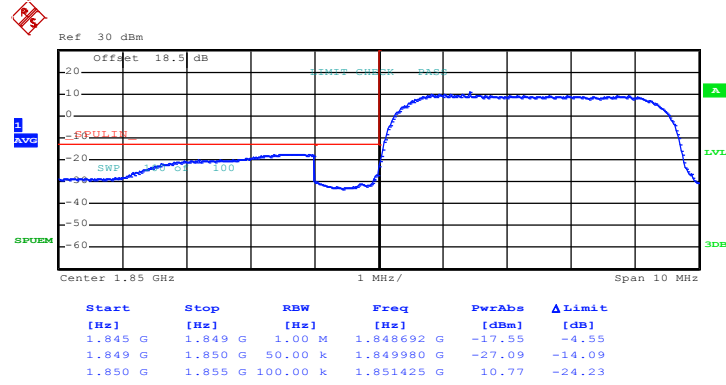

Date: 2.OCT.2014 13:45:10

Higher Band Edge Plot on Channel 9538 (1907.6 MHz)

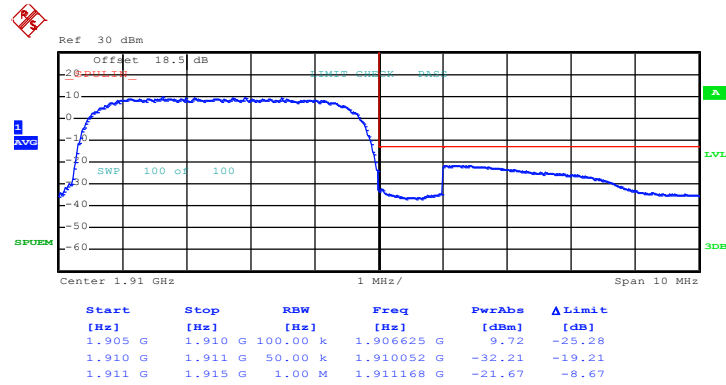

Date: 2.OCT.2014 13:41:24

3.5 Conducted Spurious Emission Measurement

3.5.1 Description of Conducted Spurious Emission Measurement

The power of any emission outside of the authorized operating frequency ranges must be lower than the transmitter power (P) by a factor of at least $43 + 10 \log (P)$ dB.

It is measured by means of a calibrated spectrum analyzer and scanned from 30 MHz up to a frequency including its 10th harmonic.

3.5.2 Measuring Instruments

The measuring equipment is listed in the section 4 of this test report.

3.5.3 Test Procedures

1. The testing follows FCC KDB 971168 v02r01 Section 6.0.
2. The EUT was connected to the spectrum analyzer and system simulator via a power divider.
3. The RF output of EUT was connected to the spectrum analyzer by an RF cable and attenuator. The path loss was compensated to the results for each measurement.
4. The middle channel for the highest RF power within the transmitting frequency was measured.
5. The conducted spurious emission for the whole frequency range was taken.
6. The RF fundamental frequency should be excluded against the limit line in the operating frequency band.
7. The limit line is derived from $43 + 10\log(P)$ dB below the transmitter power P(Watts)
 $= P(W) - [43 + 10\log(P)]$ (dB)
 $= [30 + 10\log(P)]$ (dBm) - $[43 + 10\log(P)]$ (dB)
 $= -13\text{dBm}$.

3.5.4 Test Setup

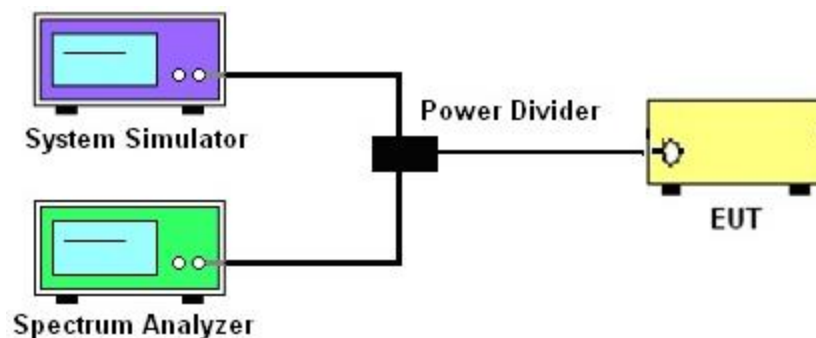



3.5.5 Test Result (Plots) of Conducted Spurious Emission

Band :	GSM850	Channel :	CH128
Test Mode :	GPRS class 8 Link (GMSK)	Frequency :	824.2 MHz

Conducted Spurious Emission Plot between 30MHz ~ 1GHz

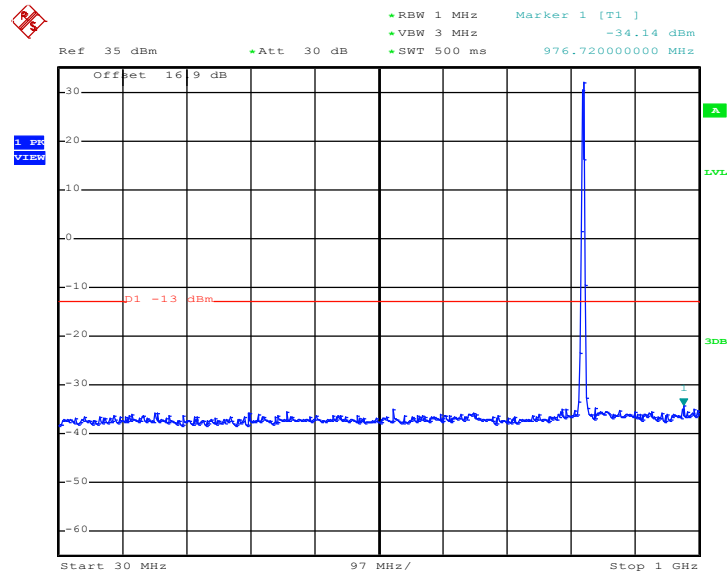

Date: 30.SEP.2014 16:03:44

Conducted Spurious Emission Plot between 1GHz ~ 3GHz

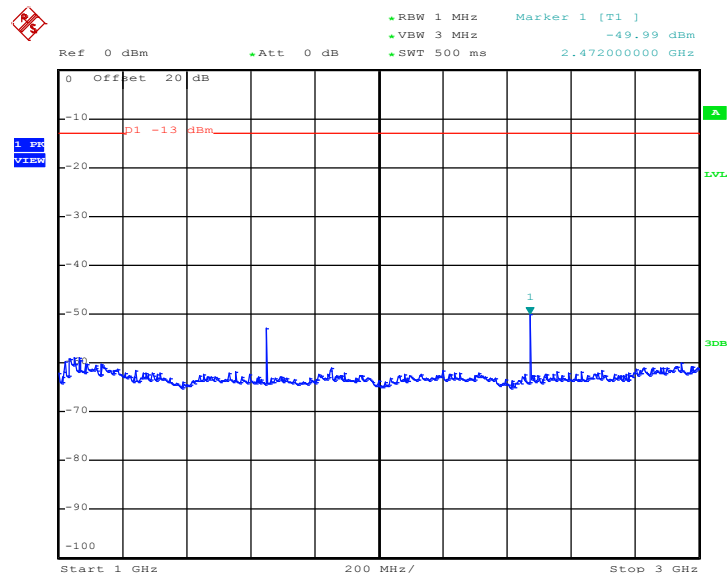

Date: 30.SEP.2014 16:03:55



Conducted Spurious Emission Plot between 3GHz ~ 7GHz

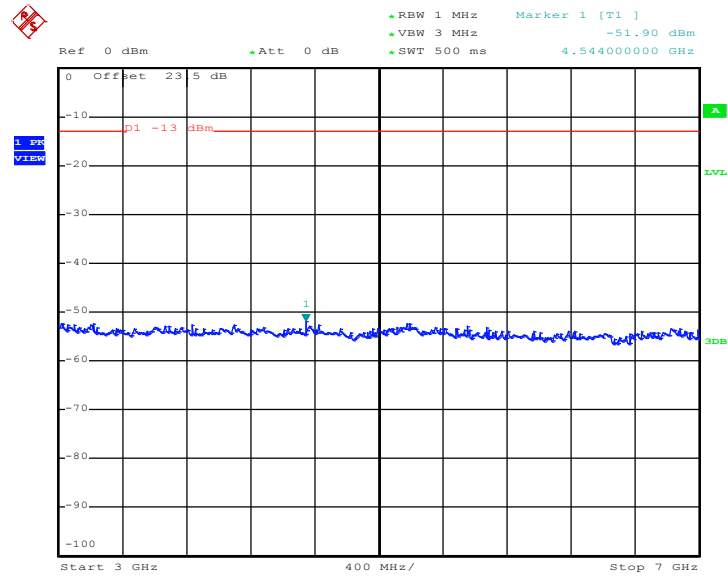

Date: 30.SEP.2014 16:04:04

Conducted Spurious Emission Plot between 7GHz ~ 9GHz

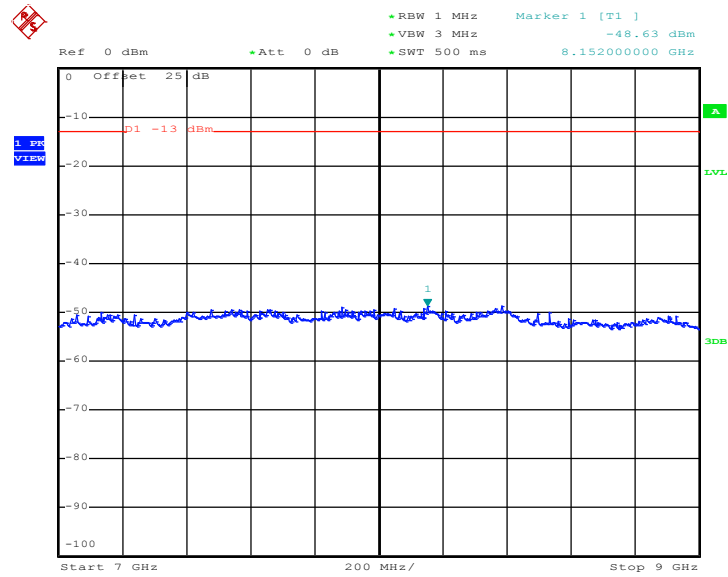

Date: 30.SEP.2014 16:04:12



Band :	GSM850	Channel :	CH189
Test Mode :	GPRS class 8 Link (GMSK)	Frequency :	836.4 MHz

Conducted Spurious Emission Plot between 30MHz ~ 1GHz

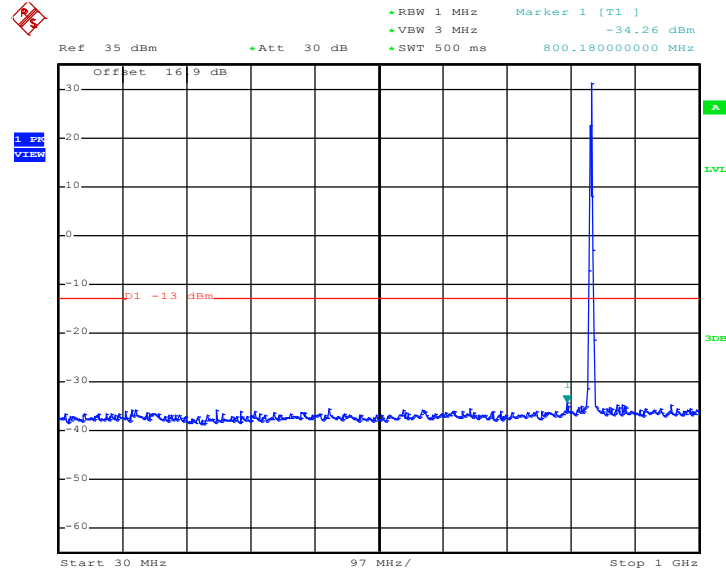

Date: 30.SEP.2014 16:08:52

Conducted Spurious Emission Plot between 1GHz ~ 3GHz

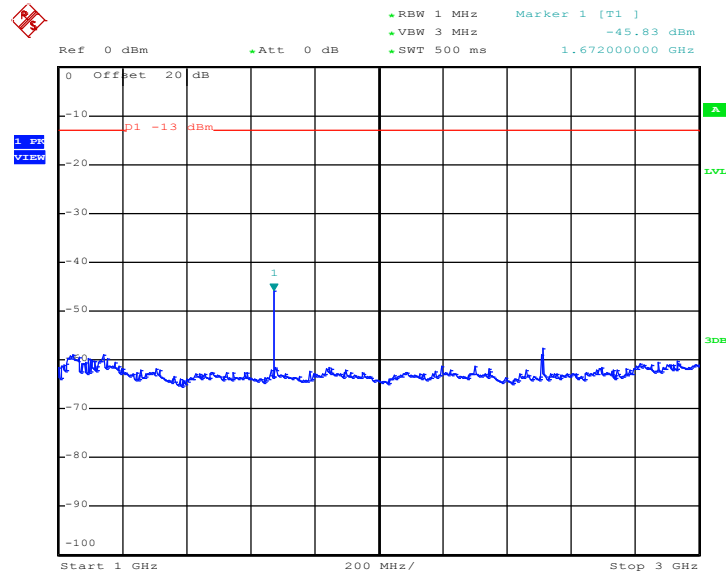

Date: 30.SEP.2014 16:09:02



Conducted Spurious Emission Plot between 3GHz ~ 7GHz

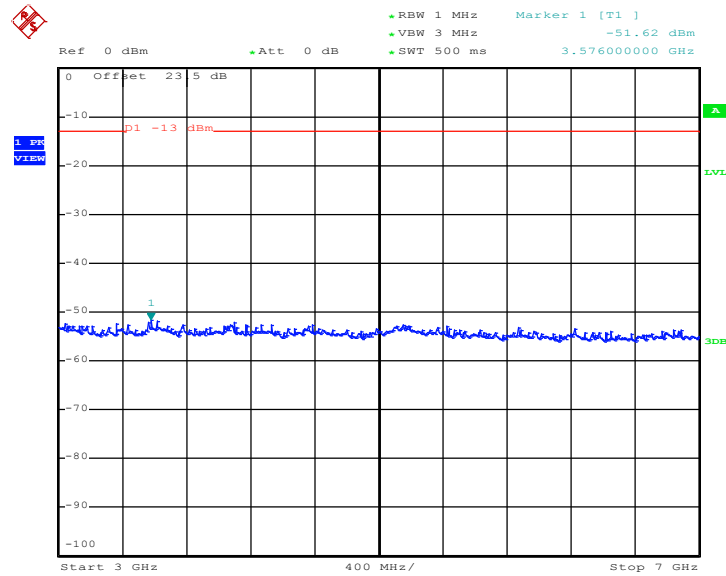

Date: 30.SEP.2014 16:09:11

Conducted Spurious Emission Plot between 7GHz ~ 9GHz

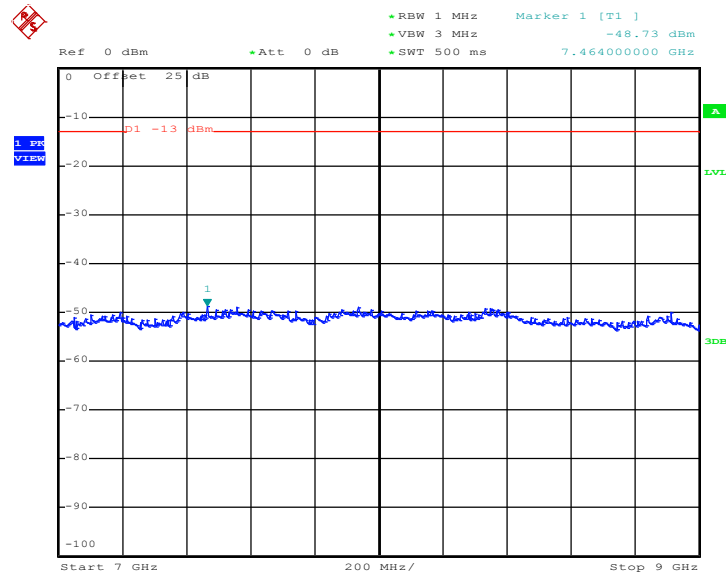

Date: 30.SEP.2014 16:09:19



Band :	GSM850	Channel :	CH251
Test Mode :	GPRS class 8 Link (GMSK)	Frequency :	848.8 MHz

Conducted Spurious Emission Plot between 30MHz ~ 1GHz

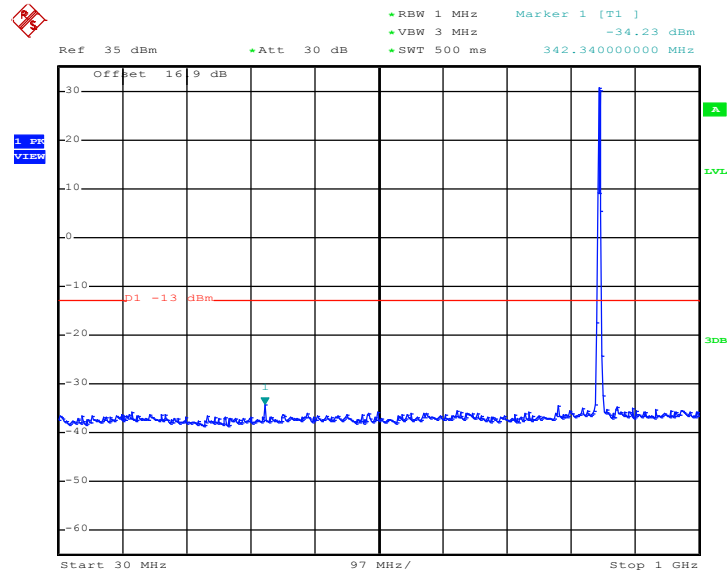

Date: 30.SEP.2014 16:11:20

Conducted Spurious Emission Plot between 1GHz ~ 3GHz

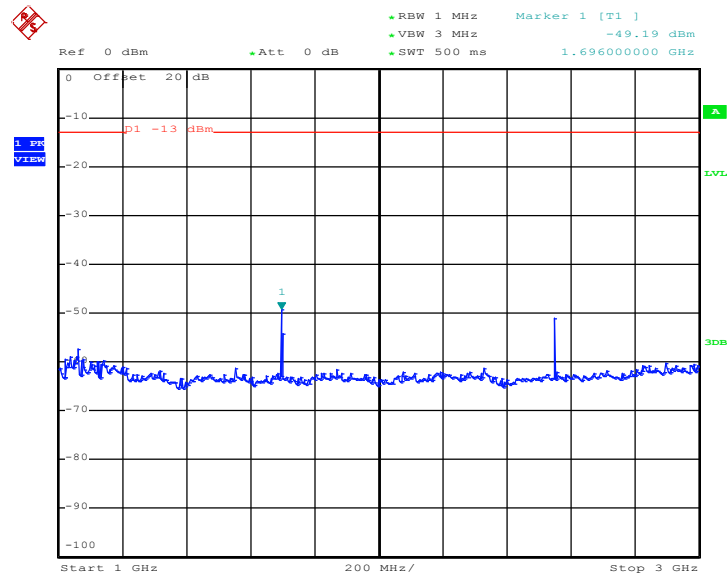

Date: 30.SEP.2014 16:11:32



Conducted Spurious Emission Plot between 3GHz ~ 7GHz

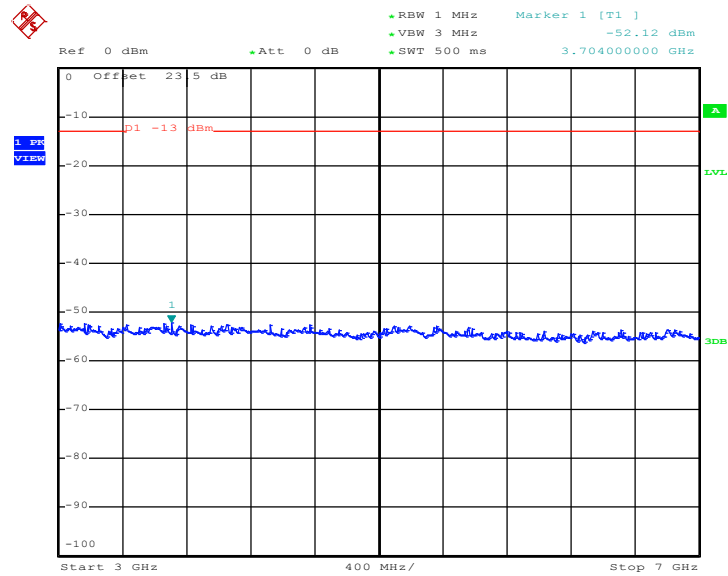

Date: 30.SEP.2014 16:11:41

Conducted Spurious Emission Plot between 7GHz ~ 9GHz

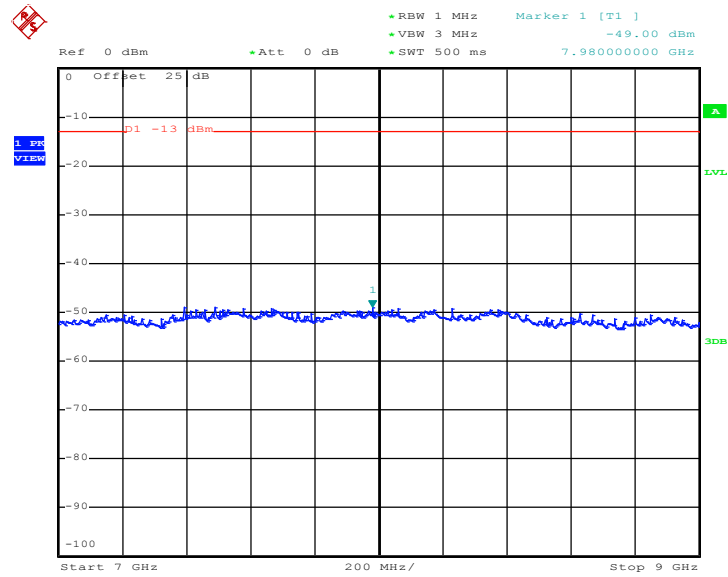

Date: 30.SEP.2014 16:11:49



Band :	GSM850	Channel :	CH128
Test Mode :	EDGE class 8 Link (8PSK)	Frequency :	824.2 MHz

Conducted Spurious Emission Plot between 30MHz ~ 1GHz

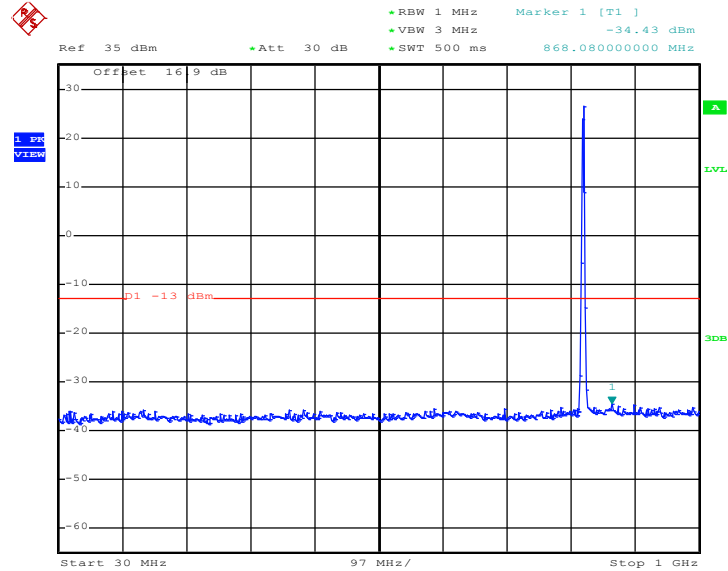

Date: 30.SEP.2014 16:40:41

Conducted Spurious Emission Plot between 1GHz ~ 3GHz

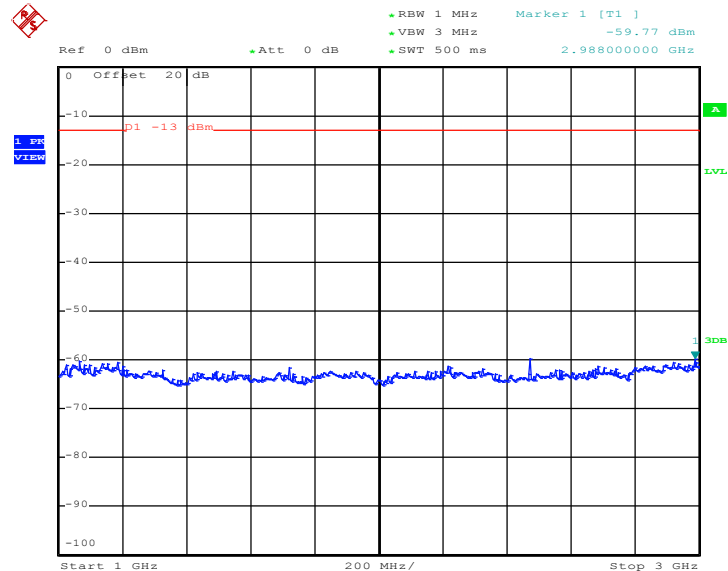

Date: 30.SEP.2014 16:40:51



Conducted Spurious Emission Plot between 3GHz ~ 7GHz

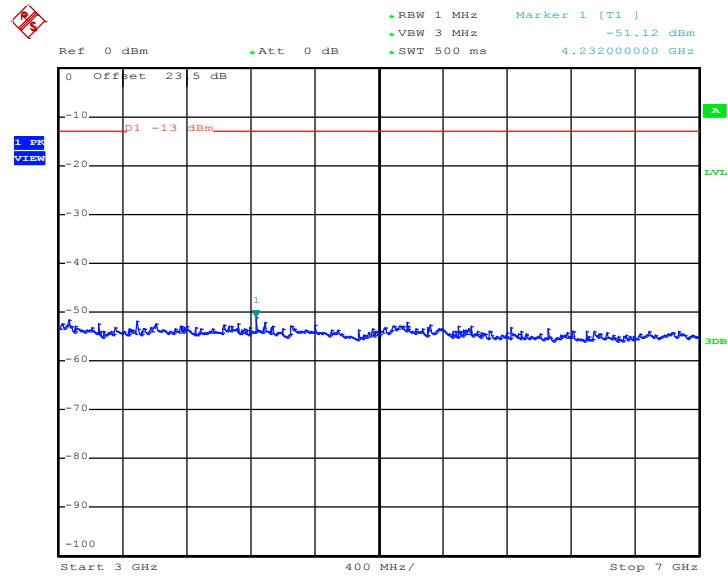

Date: 30.SEP.2014 16:40:59

Conducted Spurious Emission Plot between 7GHz ~ 9GHz

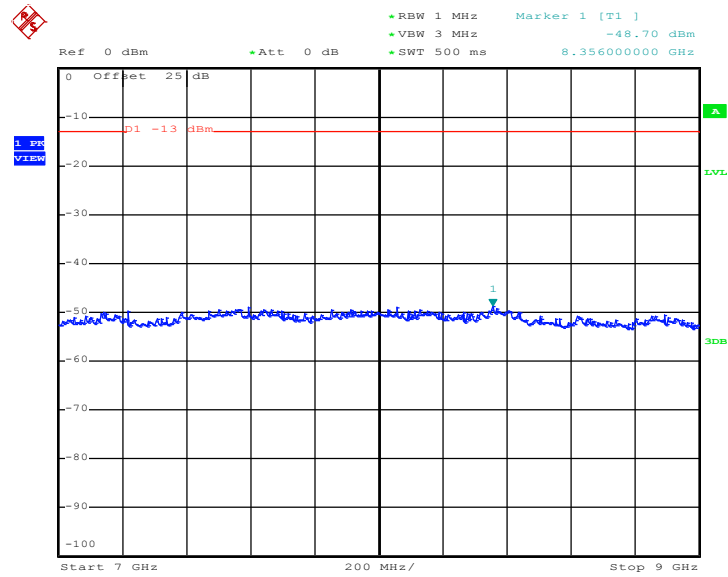

Date: 30.SEP.2014 16:41:08



Band :	GSM850	Channel :	CH189
Test Mode :	EDGE class 8 Link (8PSK)	Frequency :	836.4 MHz

Conducted Spurious Emission Plot between 30MHz ~ 1GHz

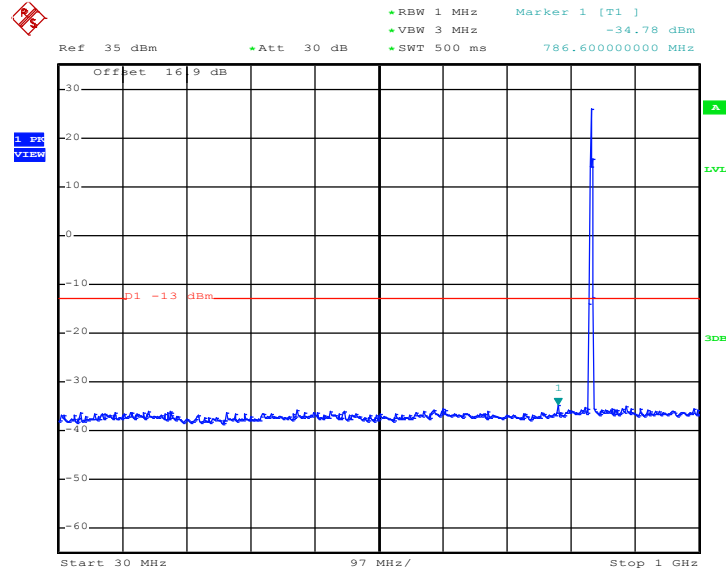

Date: 30.SEP.2014 16:44:08

Conducted Spurious Emission Plot between 1GHz ~ 3GHz

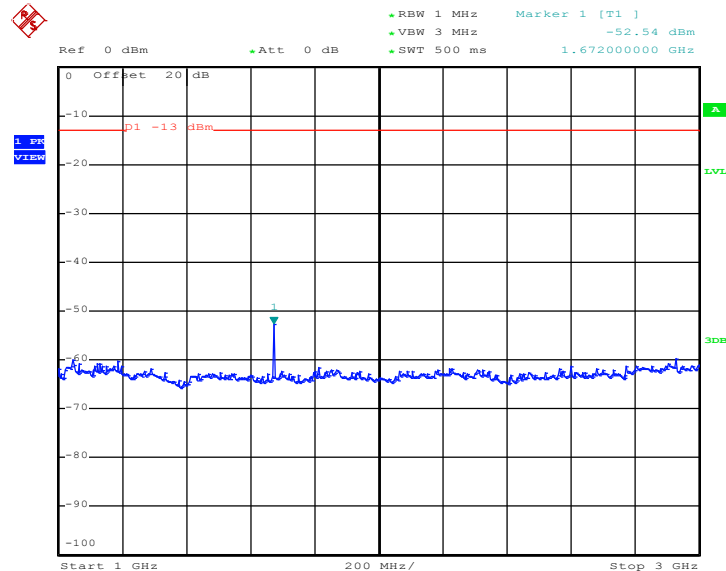

Date: 30.SEP.2014 16:44:18



Conducted Spurious Emission Plot between 3GHz ~ 7GHz

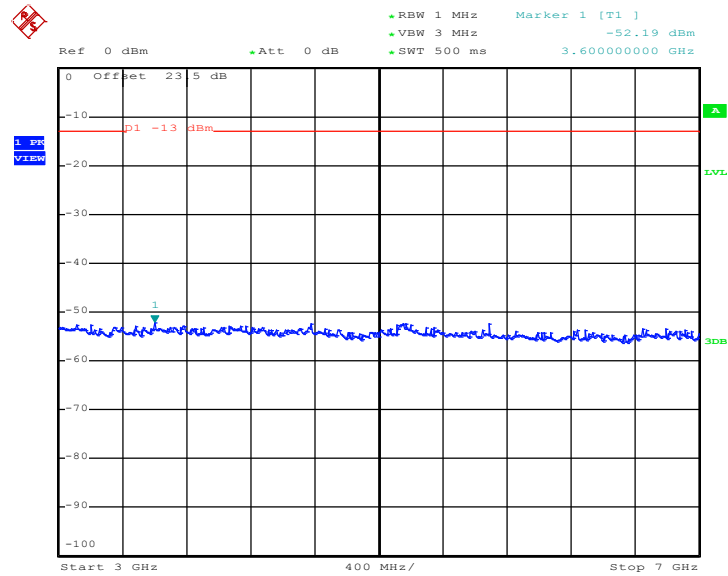

Date: 30.SEP.2014 16:44:27

Conducted Spurious Emission Plot between 7GHz ~ 9GHz

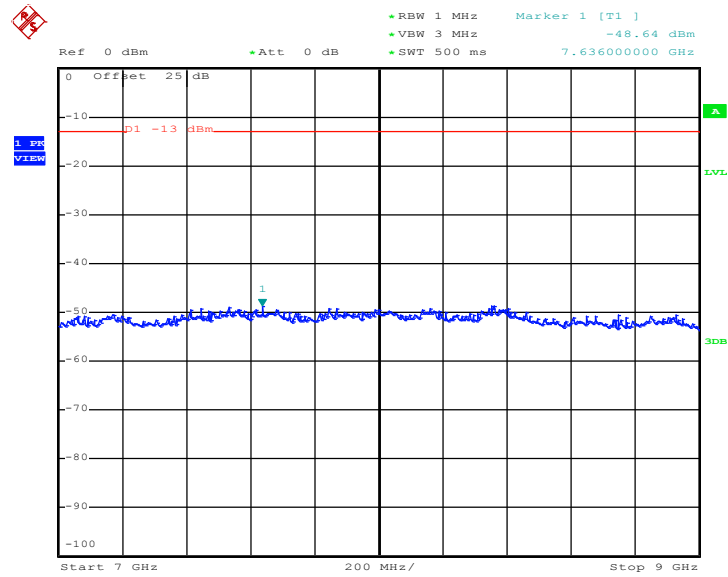

Date: 30.SEP.2014 16:44:35



Band :	GSM850	Channel :	CH251
Test Mode :	EDGE class 8 Link (8PSK)	Frequency :	848.8 MHz

Conducted Spurious Emission Plot between 30MHz ~ 1GHz

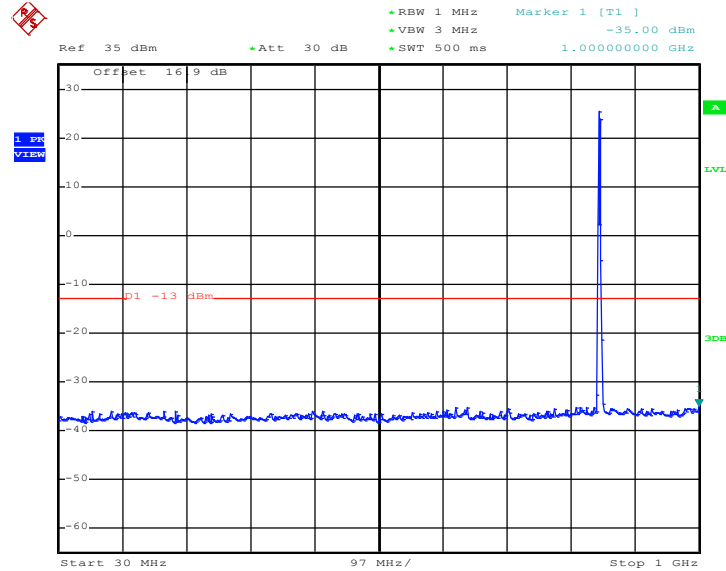

Date: 30.SEP.2014 16:45:57

Conducted Spurious Emission Plot between 1GHz ~ 3GHz

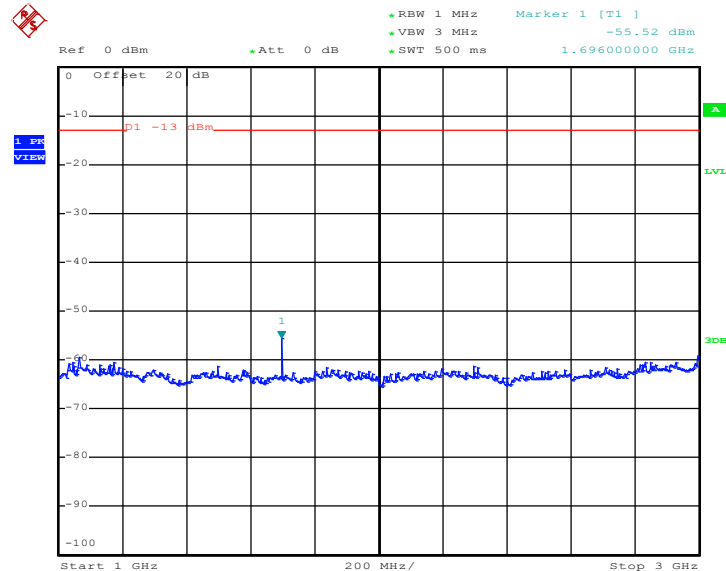

Date: 30.SEP.2014 16:46:07



Conducted Spurious Emission Plot between 3GHz ~ 7GHz

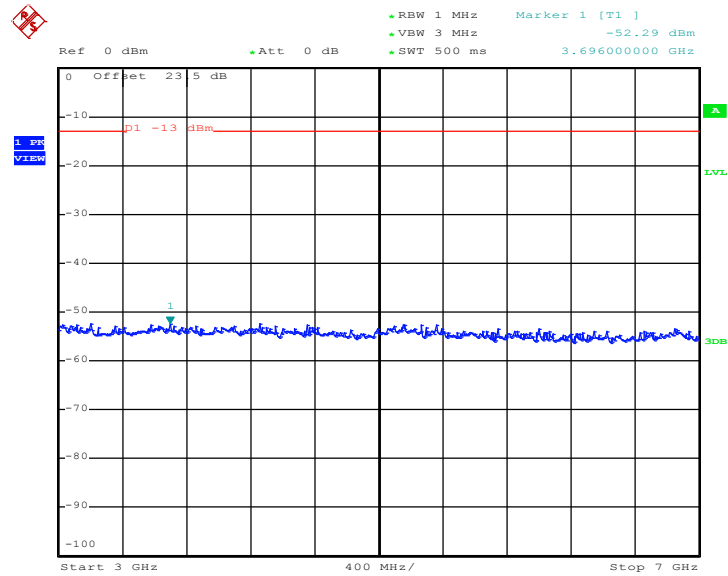

Date: 30.SEP.2014 16:46:16

Conducted Spurious Emission Plot between 7GHz ~ 9GHz

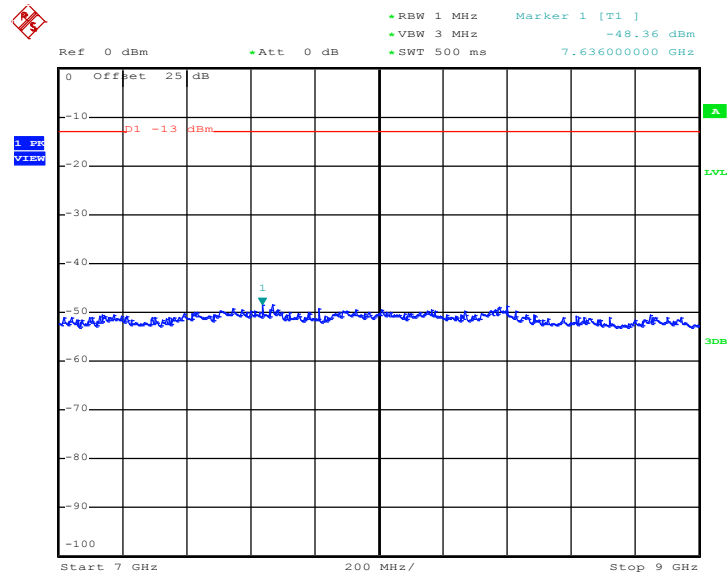

Date: 30.SEP.2014 16:46:24



Band :	GSM1900	Channel :	CH512
Test Mode :	GPRS class 8 Link (GMSK)	Frequency :	1850.2 MHz

Conducted Spurious Emission Plot between 30MHz ~ 1GHz

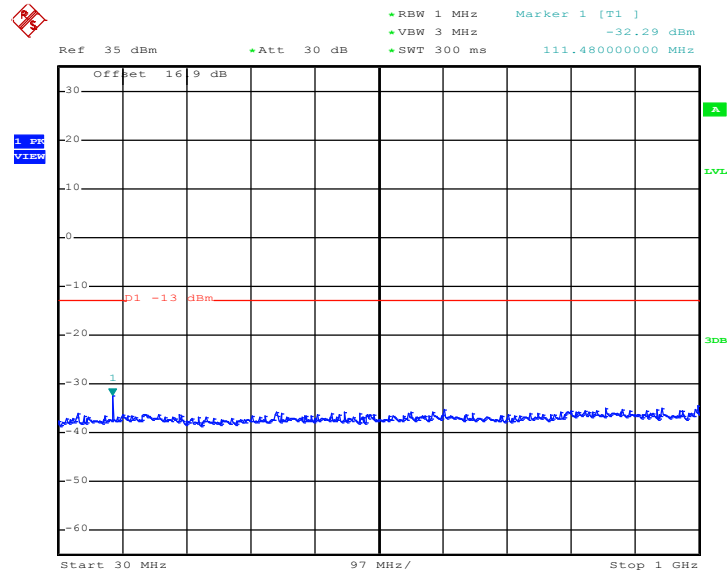

Date: 2.OCT.2014 10:47:38

Conducted Spurious Emission Plot between 1GHz ~ 3GHz

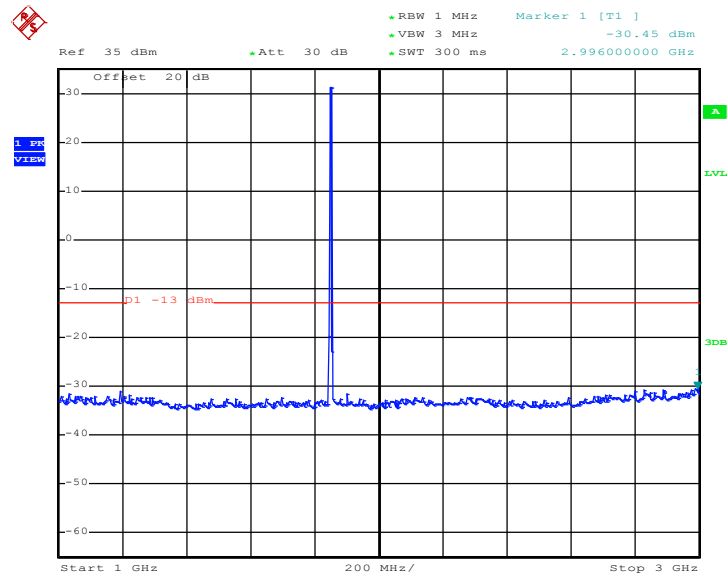

Date: 2.OCT.2014 10:47:46



Conducted Spurious Emission Plot between 3GHz ~ 7GHz

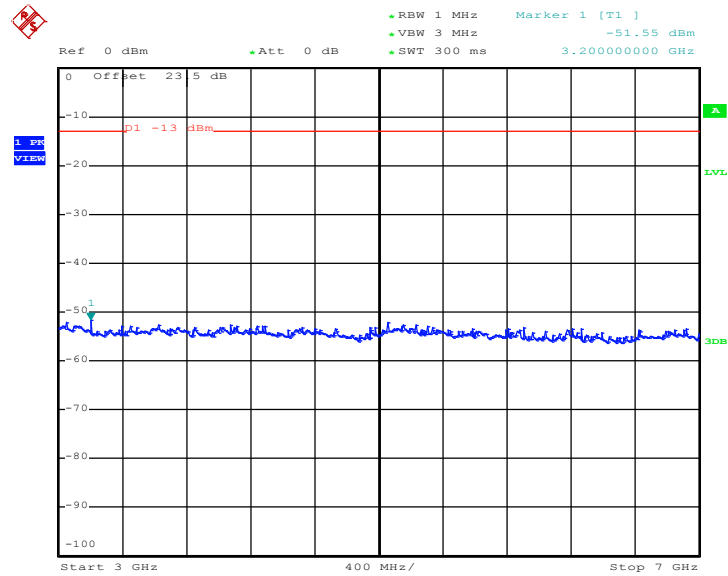

Date: 2.OCT.2014 10:47:56

Conducted Spurious Emission Plot between 7GHz ~ 13.6GHz

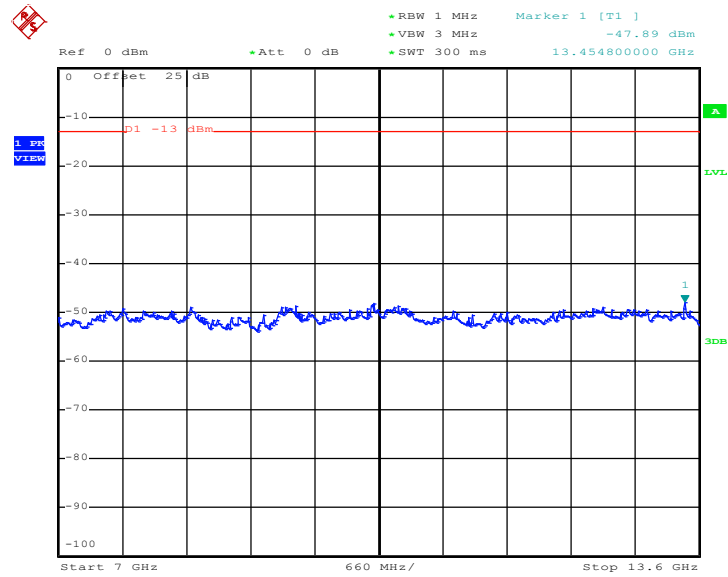

Date: 2.OCT.2014 10:48:05



Conducted Spurious Emission Plot between 13.6GHz ~ 19.1GHz

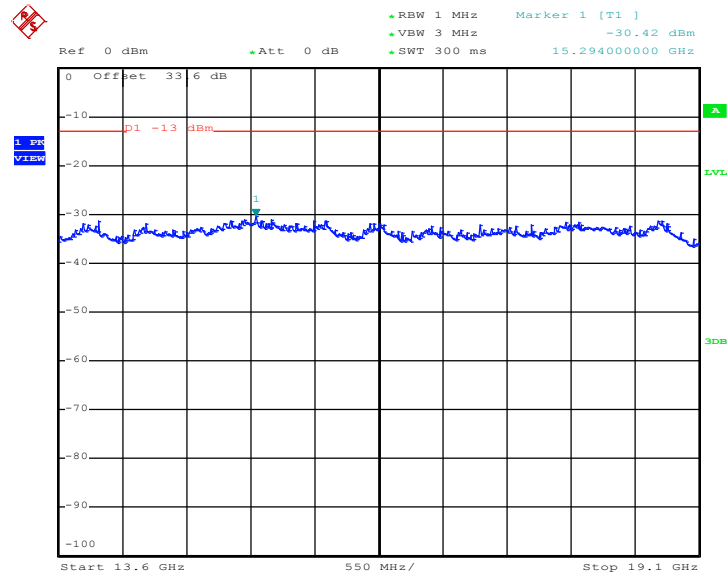

Date: 2.OCT.2014 10:48:13



Band :	GSM1900	Channel :	CH661
Test Mode :	GPRS class 8 Link (GMSK)	Frequency :	1880.0 MHz

Conducted Spurious Emission Plot between 30MHz ~ 1GHz

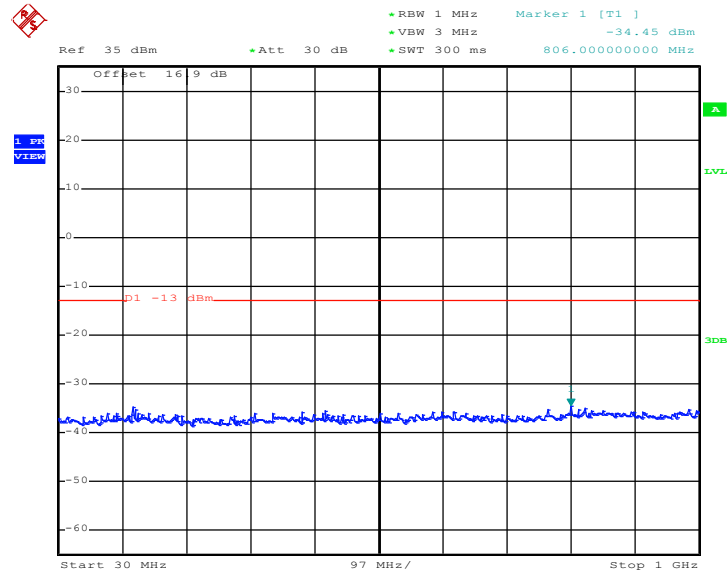

Date: 2.OCT.2014 10:49:14

Conducted Spurious Emission Plot between 1GHz ~ 3GHz

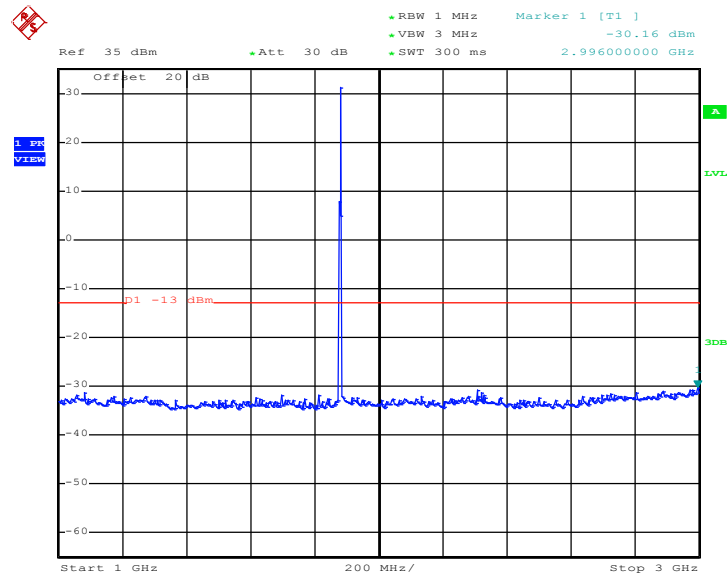

Date: 2.OCT.2014 10:49:22



Conducted Spurious Emission Plot between 3GHz ~ 7GHz

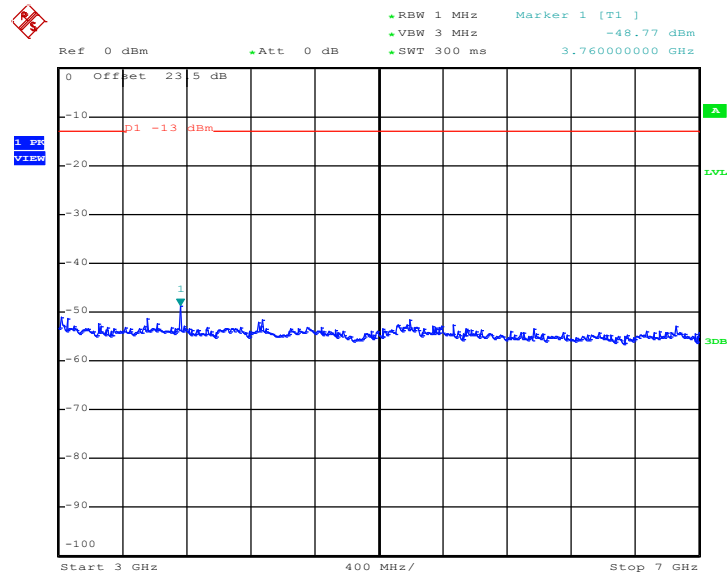

Date: 2.OCT.2014 10:49:32

Conducted Spurious Emission Plot between 7GHz ~ 13.6GHz

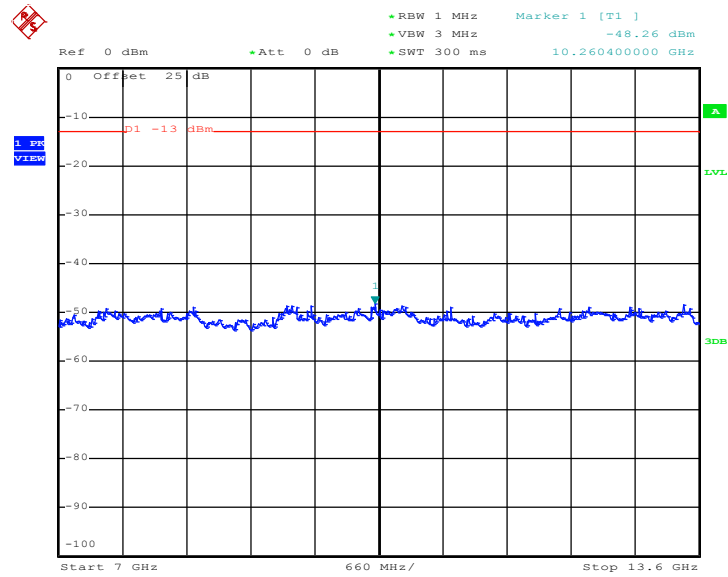

Date: 2.OCT.2014 10:49:41



Conducted Spurious Emission Plot between 13.6GHz ~ 19.1GHz

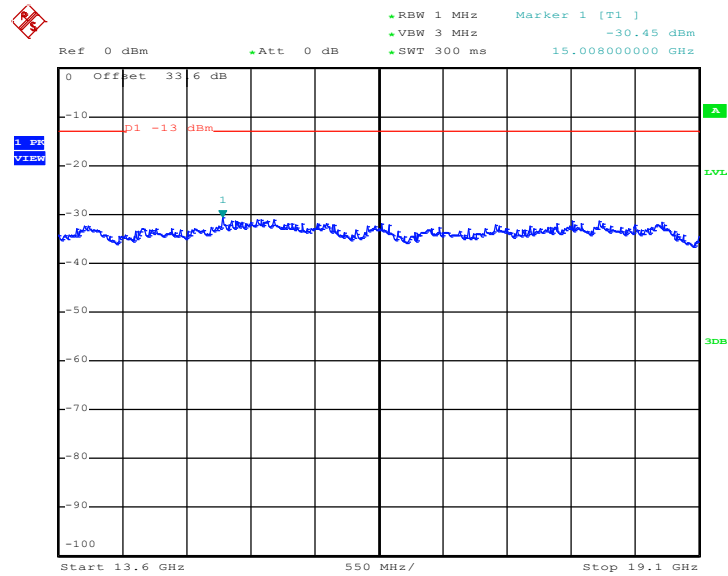

Date: 2.OCT.2014 10:49:49



Band :	GSM1900	Channel :	CH810
Test Mode :	GPRS class 8 Link (GMSK)	Frequency :	1909.8 MHz

Conducted Spurious Emission Plot between 30MHz ~ 1GHz

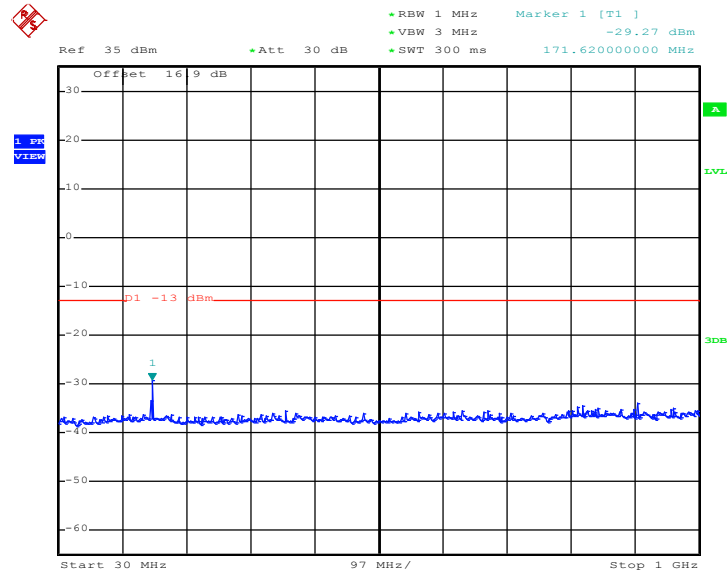

Date: 2.OCT.2014 10:50:23

Conducted Spurious Emission Plot between 1GHz ~ 3GHz

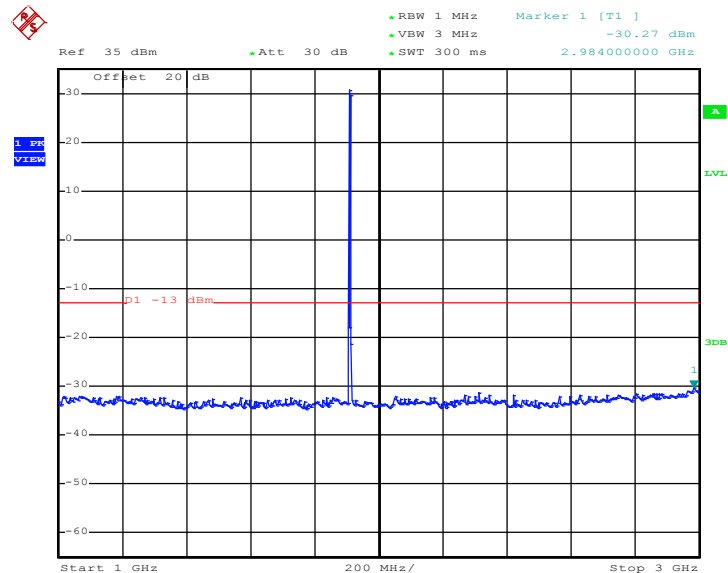

Date: 2.OCT.2014 10:50:32



Conducted Spurious Emission Plot between 3GHz ~ 7GHz

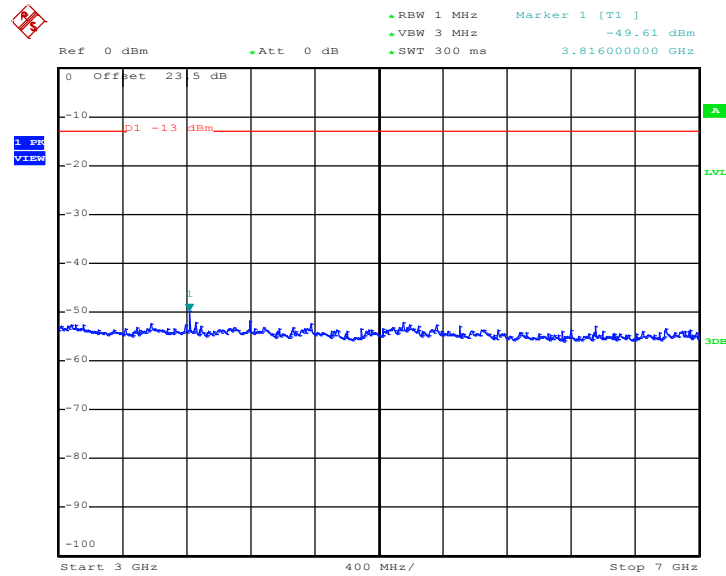

Date: 2.OCT.2014 10:50:43

Conducted Spurious Emission Plot between 7GHz ~ 13.6GHz

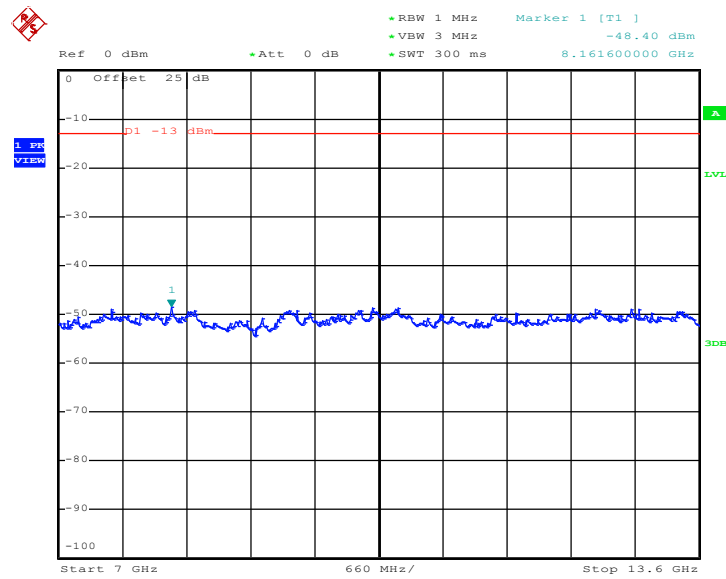

Date: 2.OCT.2014 10:50:51



Conducted Spurious Emission Plot between 13.6GHz ~ 19.1GHz

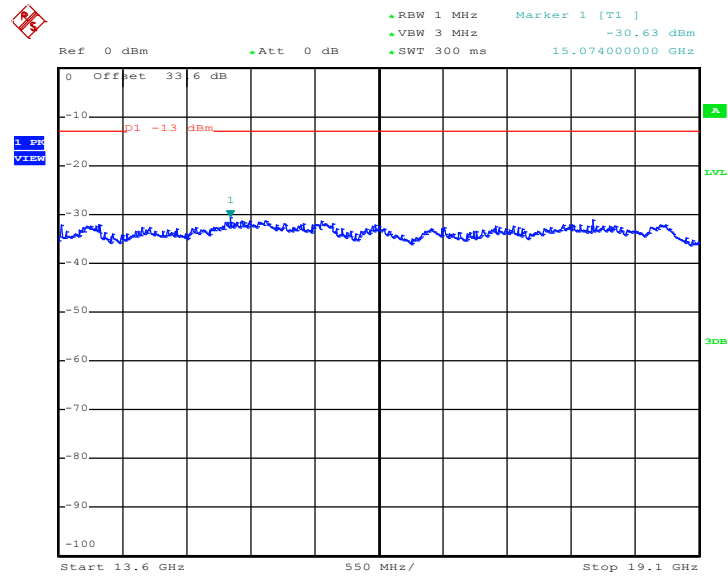

Date: 2.OCT.2014 10:51:00



Band :	GSM1900	Channel :	CH512
Test Mode :	EDGE class 8 Link (8PSK)	Frequency :	1850.2 MHz

Conducted Spurious Emission Plot between 30MHz ~ 1GHz

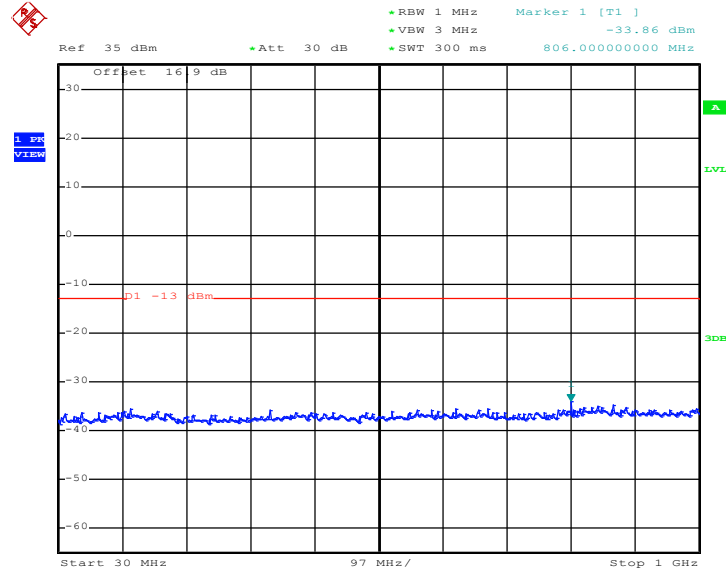

Date: 2.OCT.2014 11:34:36

Conducted Spurious Emission Plot between 1GHz ~ 3GHz

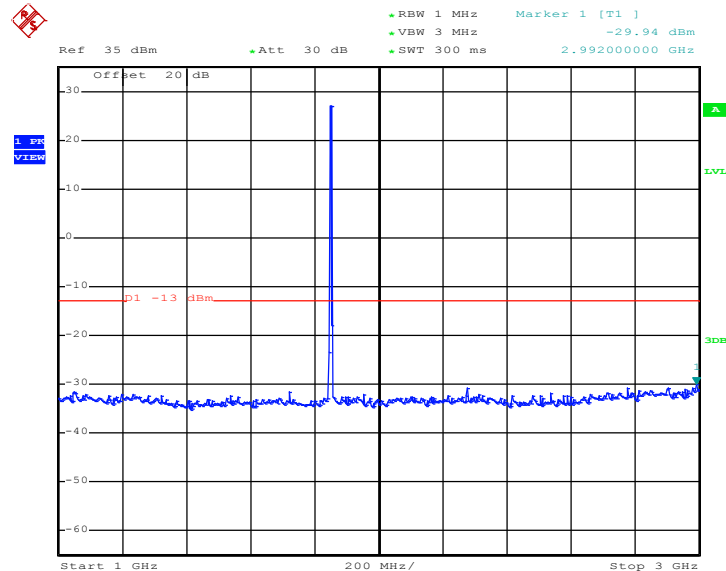

Date: 2.OCT.2014 11:34:44



Conducted Spurious Emission Plot between 3GHz ~ 7GHz

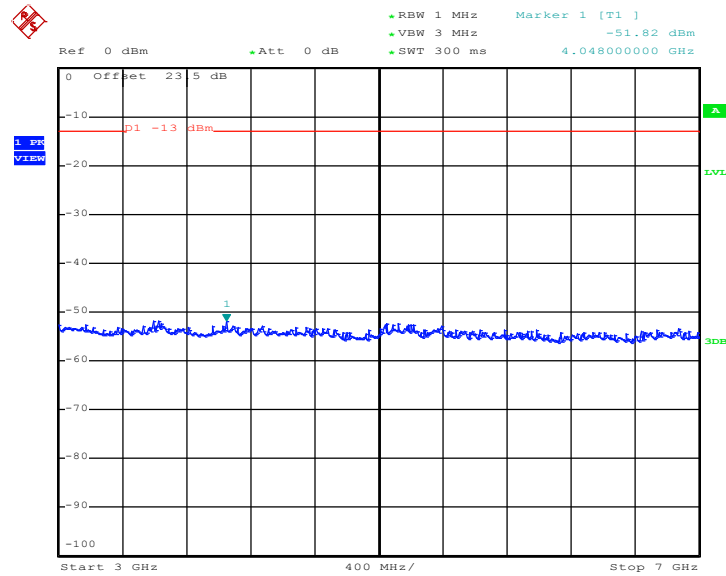

Date: 2.OCT.2014 11:34:55

Conducted Spurious Emission Plot between 7GHz ~ 13.6GHz

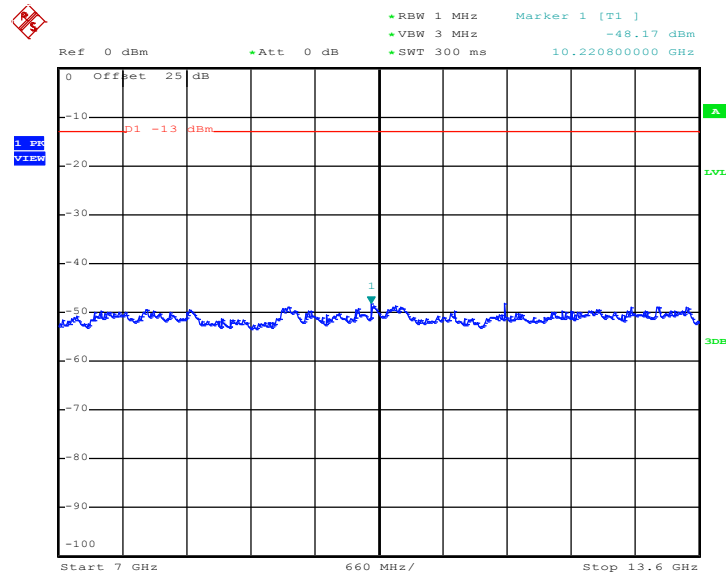

Date: 2.OCT.2014 11:35:03



Conducted Spurious Emission Plot between 13.6GHz ~ 19.1GHz

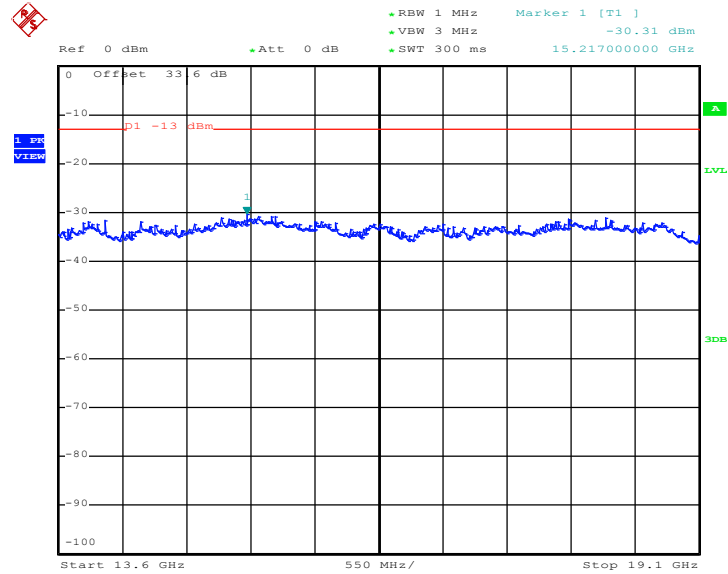

Date: 2.OCT.2014 11:35:11



Band :	GSM1900	Channel :	CH661
Test Mode :	EDGE class 8 Link (8PSK)	Frequency :	1880.0 MHz

Conducted Spurious Emission Plot between 30MHz ~ 1GHz

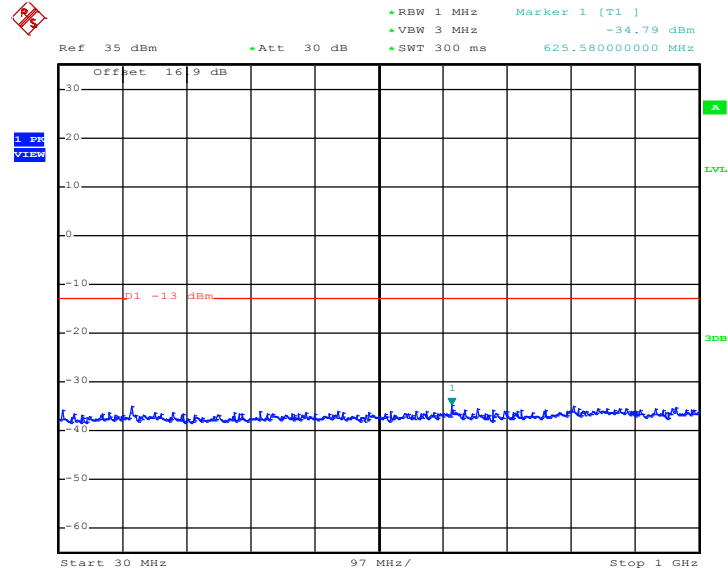

Date: 2.OCT.2014 11:36:06

Conducted Spurious Emission Plot between 1GHz ~ 3GHz

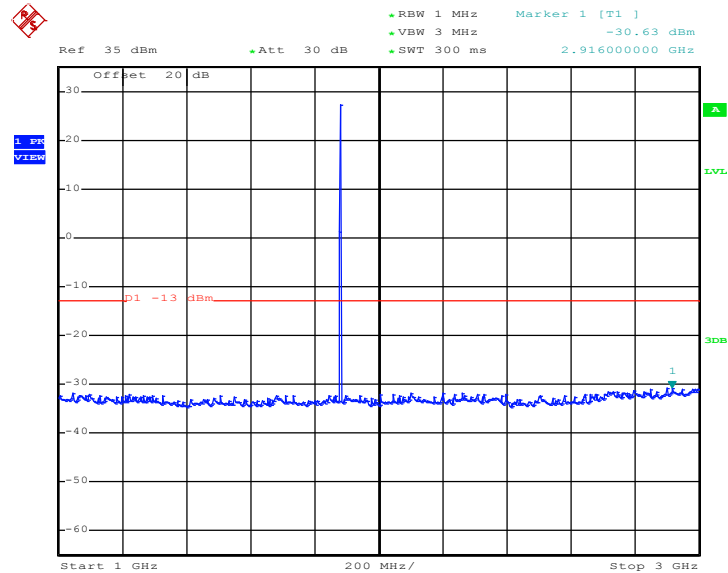

Date: 2.OCT.2014 11:36:14



Conducted Spurious Emission Plot between 3GHz ~ 7GHz

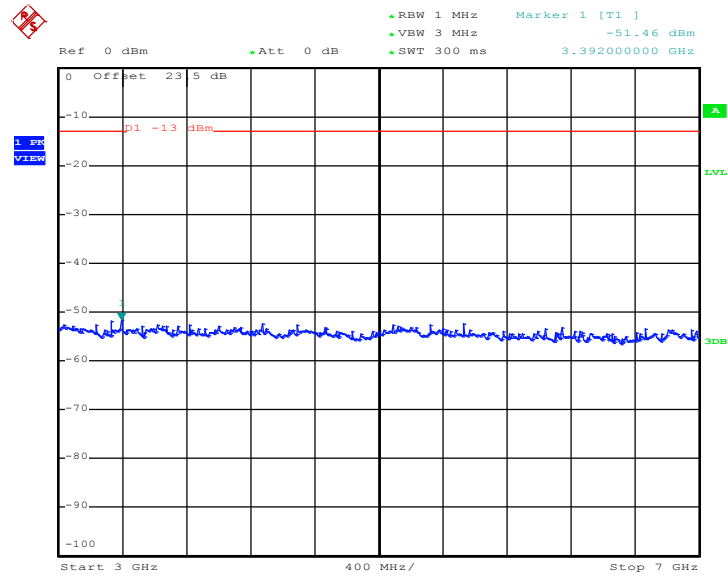

Date: 2.OCT.2014 11:36:25

Conducted Spurious Emission Plot between 7GHz ~ 13.6GHz

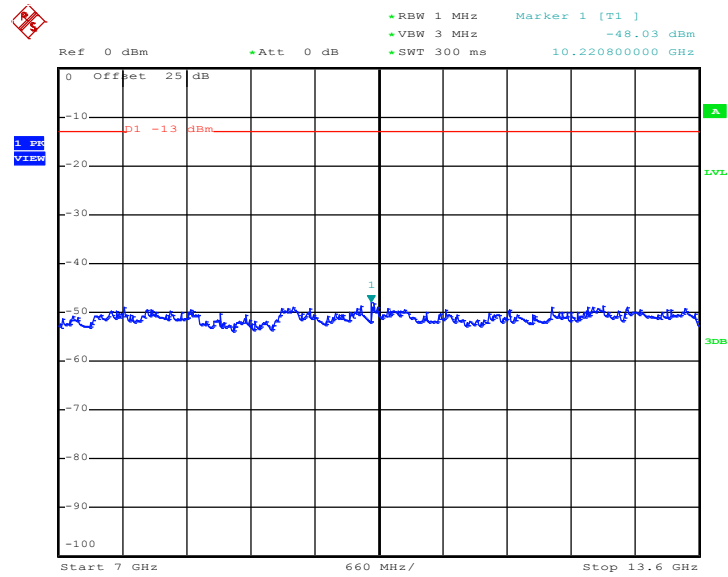

Date: 2.OCT.2014 11:36:33



Conducted Spurious Emission Plot between 13.6GHz ~ 19.1GHz

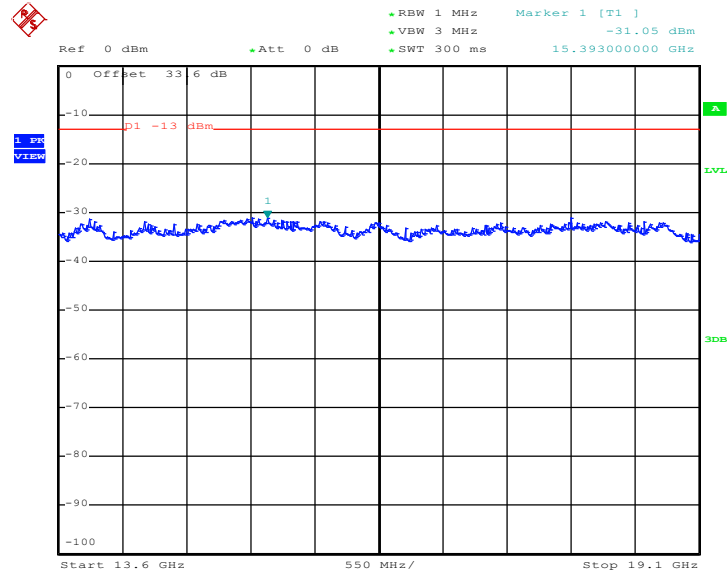

Date: 2.OCT.2014 11:36:42



Band :	GSM1900	Channel :	CH810
Test Mode :	EDGE class 8 Link (8PSK)	Frequency :	1909.8 MHz

Conducted Spurious Emission Plot between 30MHz ~ 1GHz

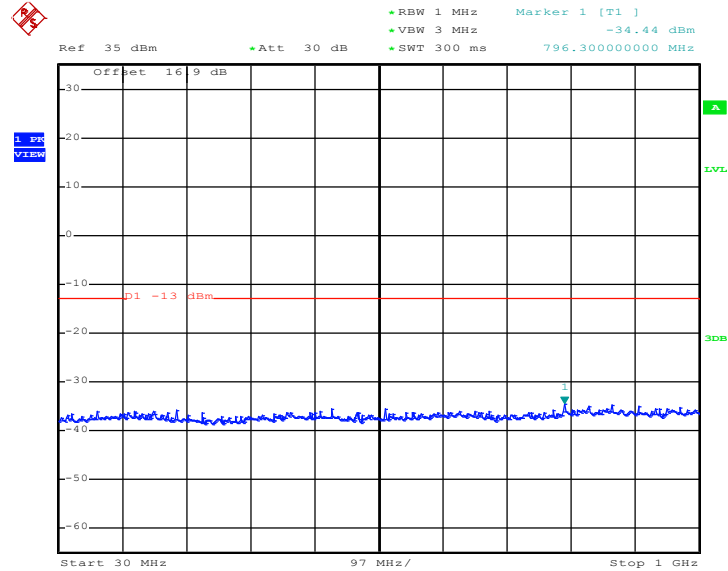

Date: 2.OCT.2014 11:37:15

Conducted Spurious Emission Plot between 1GHz ~ 3GHz

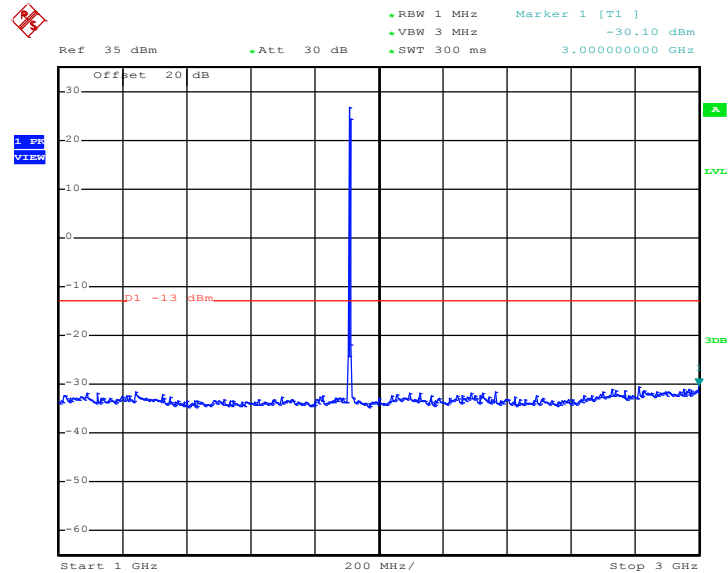

Date: 2.OCT.2014 11:37:23



Conducted Spurious Emission Plot between 3GHz ~ 7GHz

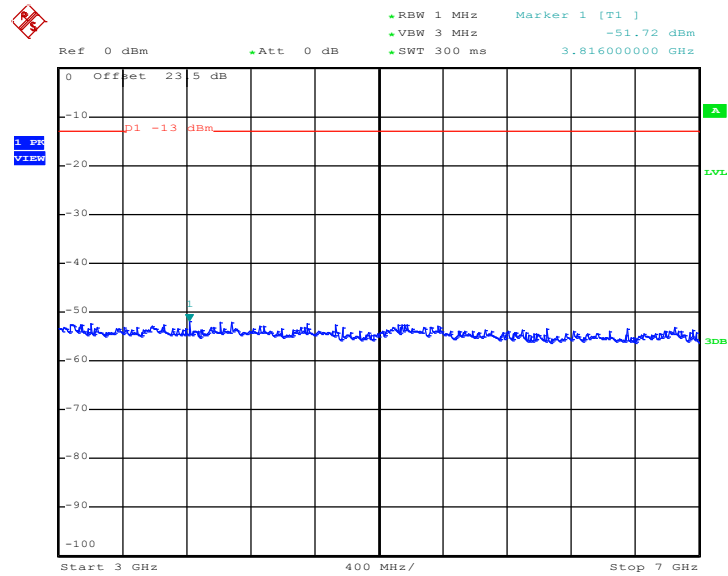

Date: 2.OCT.2014 11:37:35

Conducted Spurious Emission Plot between 7GHz ~ 13.6GHz

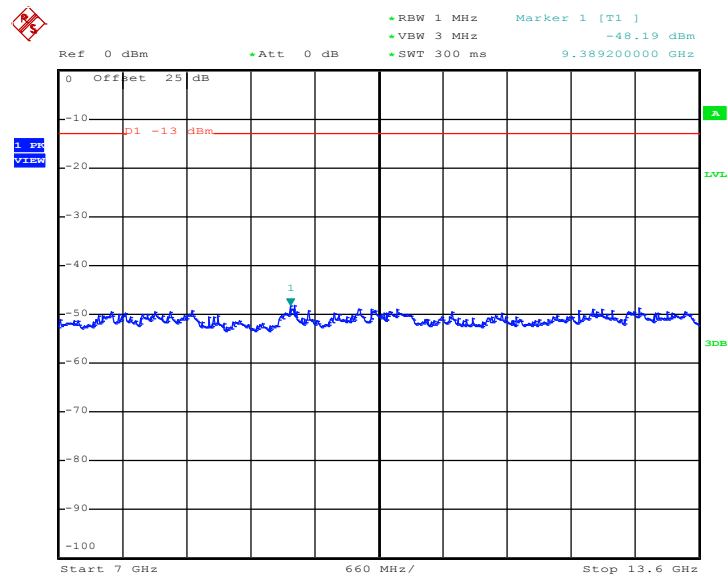

Date: 2.OCT.2014 11:37:43



Conducted Spurious Emission Plot between 13.6GHz ~ 19.1GHz

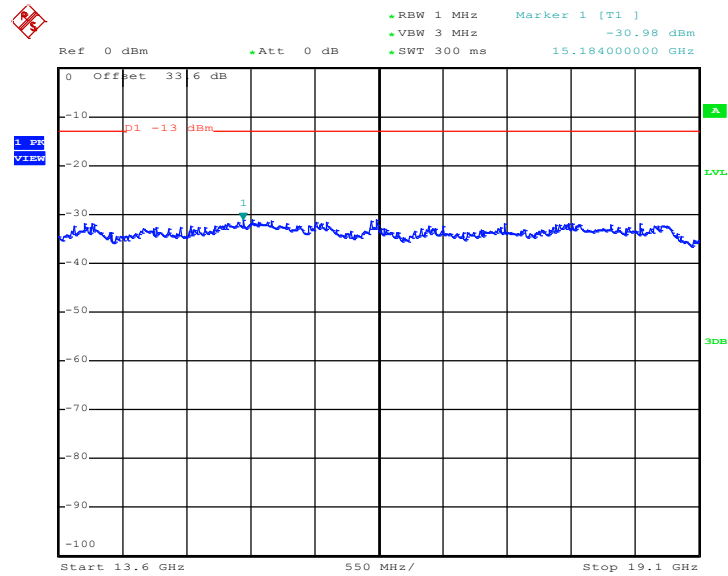

Date: 2.OCT.2014 11:37:52



Band :	WCDMA Band V	Channel :	CH4132
Test Mode :	RMC 12.2Kbps Link (QPSK)	Frequency :	826.4 MHz

Conducted Spurious Emission Plot between 30MHz ~ 1GHz

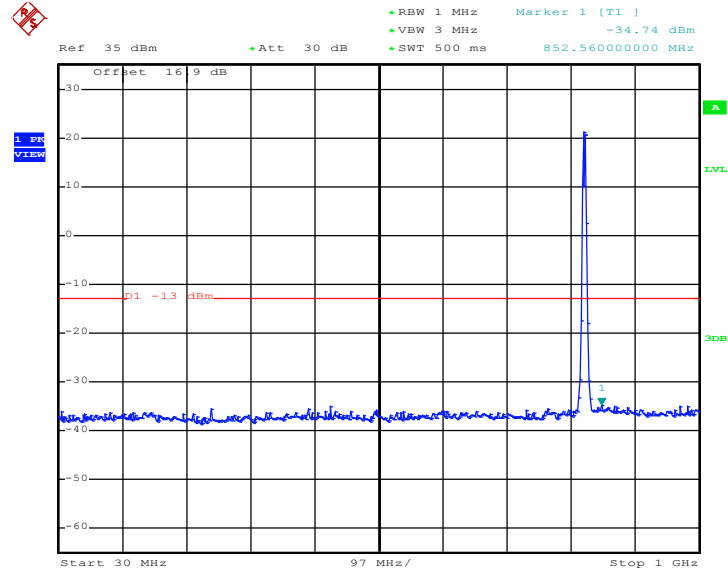

Date: 2.OCT.2014 14:58:29

Conducted Spurious Emission Plot between 1GHz ~ 3GHz

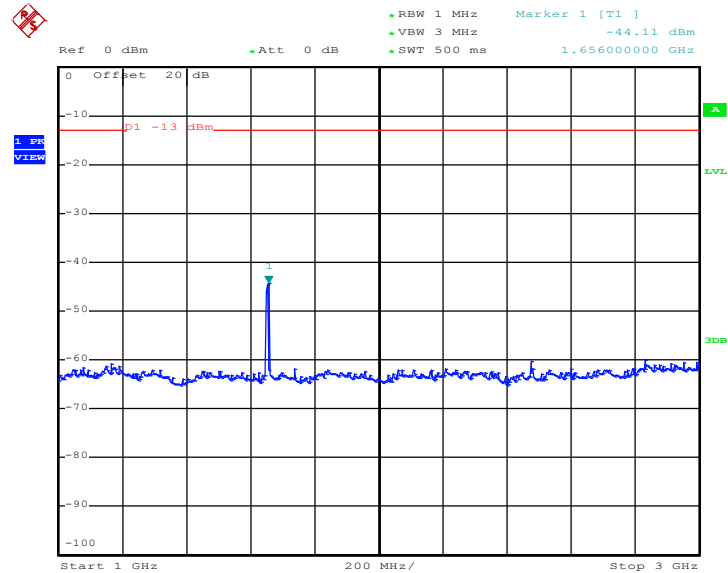

Date: 2.OCT.2014 14:58:40



Conducted Spurious Emission Plot between 3GHz ~ 7GHz

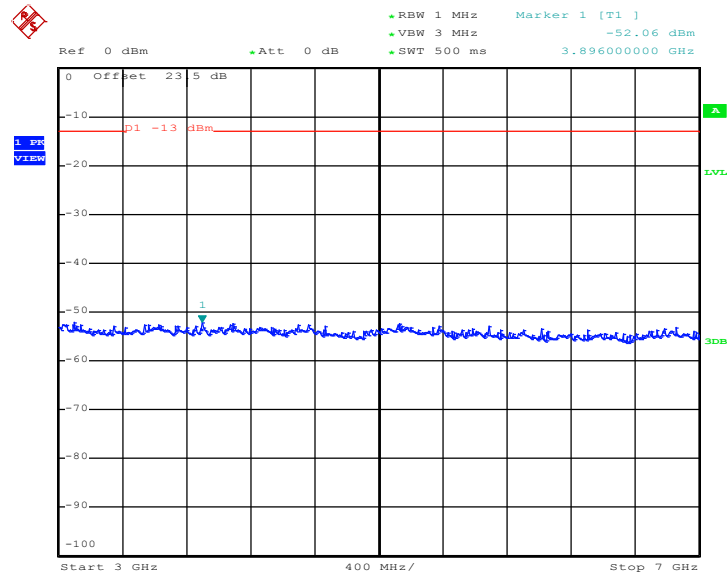

Date: 2.OCT.2014 14:58:48

Conducted Spurious Emission Plot between 7GHz ~ 9GHz

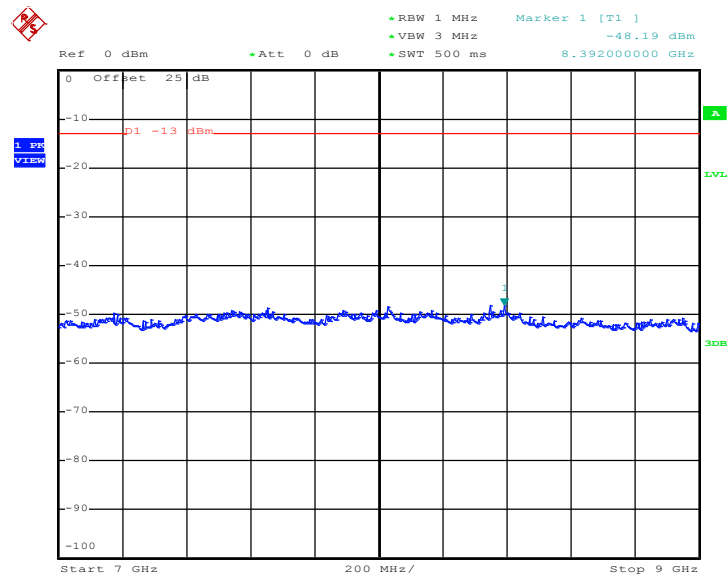

Date: 2.OCT.2014 14:58:56



Band :	WCDMA Band V	Channel :	CH4182
Test Mode :	RMC 12.2Kbps Link (QPSK)	Frequency :	836.4 MHz

Conducted Spurious Emission Plot between 30MHz ~ 1GHz

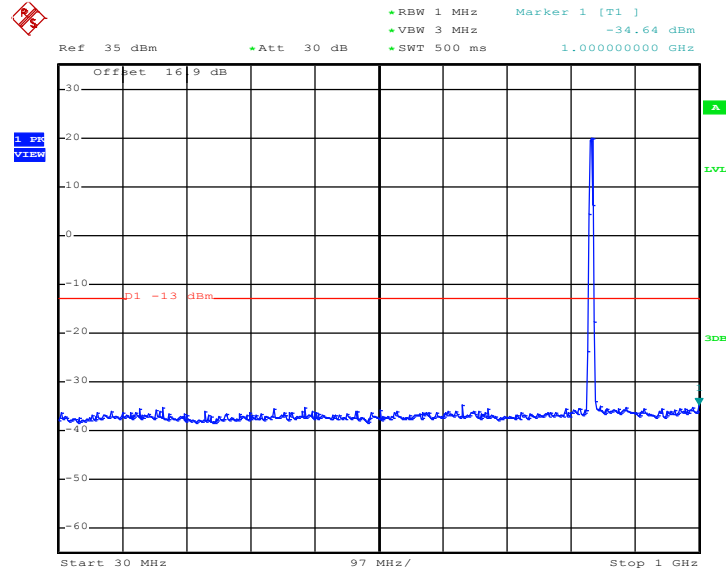

Date: 2.OCT.2014 14:57:03

Conducted Spurious Emission Plot between 1GHz ~ 3GHz

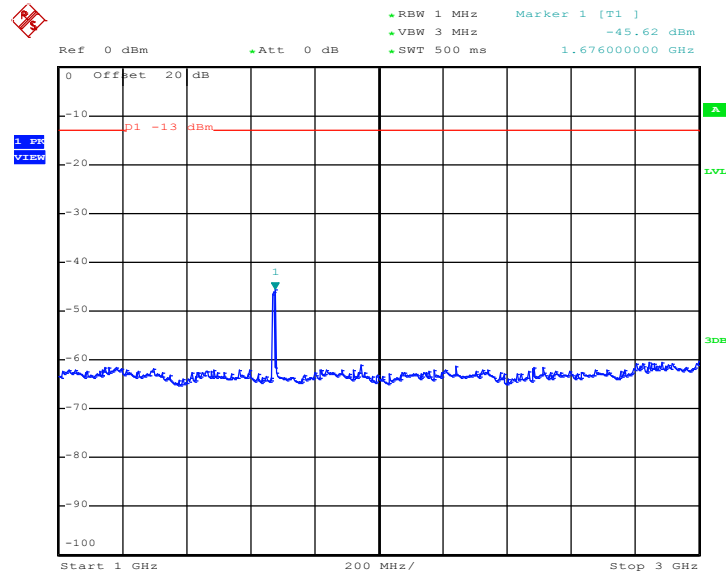

Date: 2.OCT.2014 14:57:14



Conducted Spurious Emission Plot between 3GHz ~ 7GHz

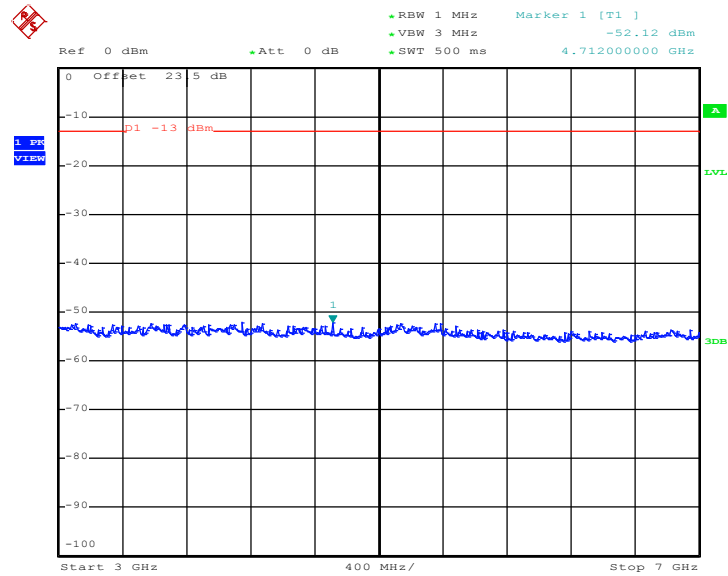

Date: 2.OCT.2014 14:57:22

Conducted Spurious Emission Plot between 7GHz ~ 9GHz

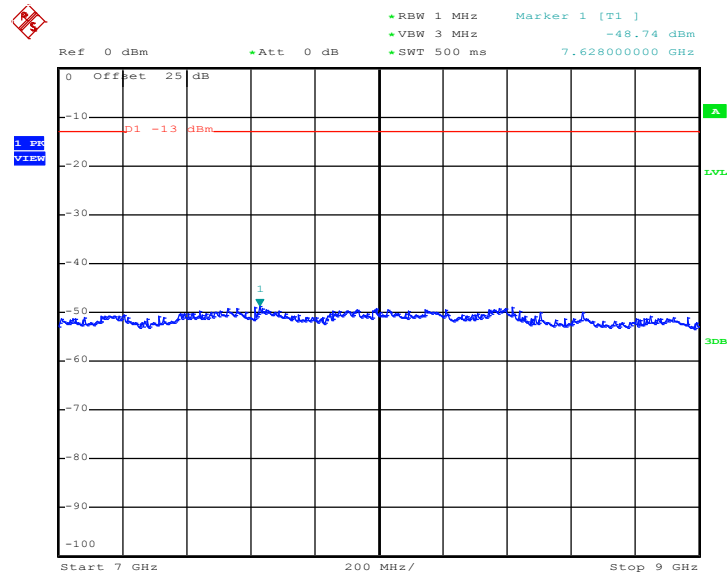

Date: 2.OCT.2014 14:57:30



Band :	WCDMA Band V	Channel :	CH4233
Test Mode :	RMC 12.2Kbps Link (QPSK)	Frequency :	846.6 MHz

Conducted Spurious Emission Plot between 30MHz ~ 1GHz

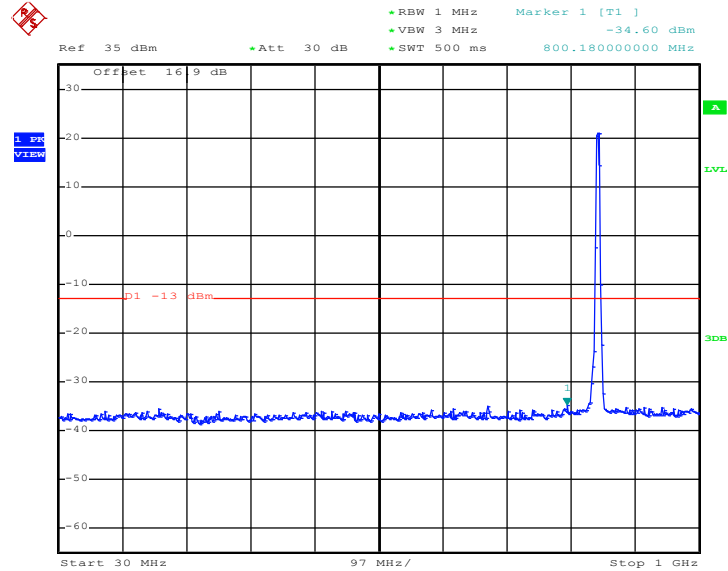

Date: 2.OCT.2014 14:59:43

Conducted Spurious Emission Plot between 1GHz ~ 3GHz

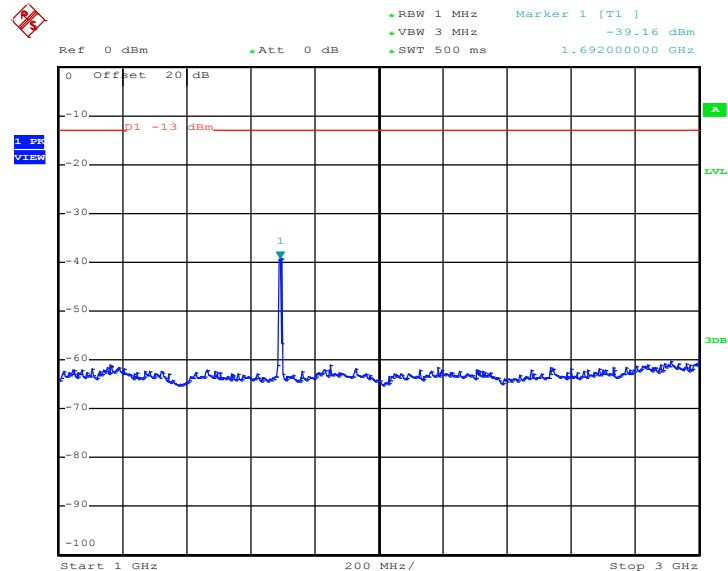

Date: 2.OCT.2014 14:59:53



Conducted Spurious Emission Plot between 3GHz ~ 7GHz

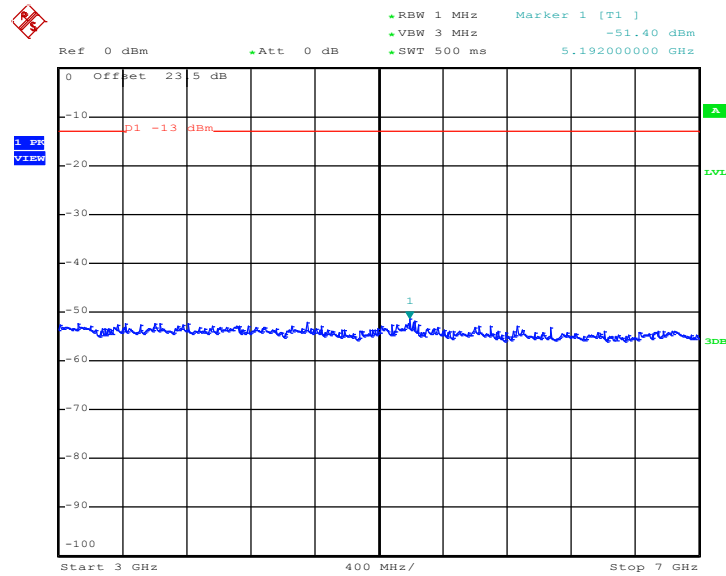

Date: 2.OCT.2014 15:00:01

Conducted Spurious Emission Plot between 7GHz ~ 9GHz

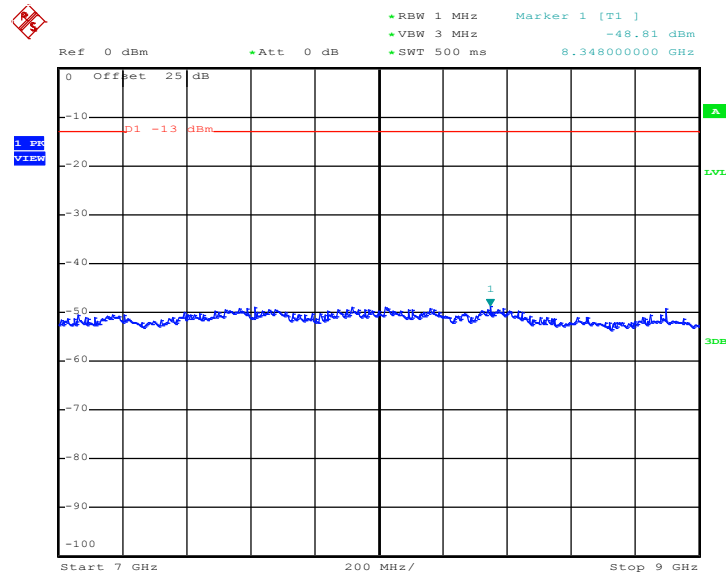

Date: 2.OCT.2014 15:00:09



Band :	WCDMA Band IV	Channel :	CH1312
Test Mode :	RMC 12.2Kbps Link (QPSK)	Frequency :	1712.4 MHz

Conducted Spurious Emission Plot between 30MHz ~ 1GHz

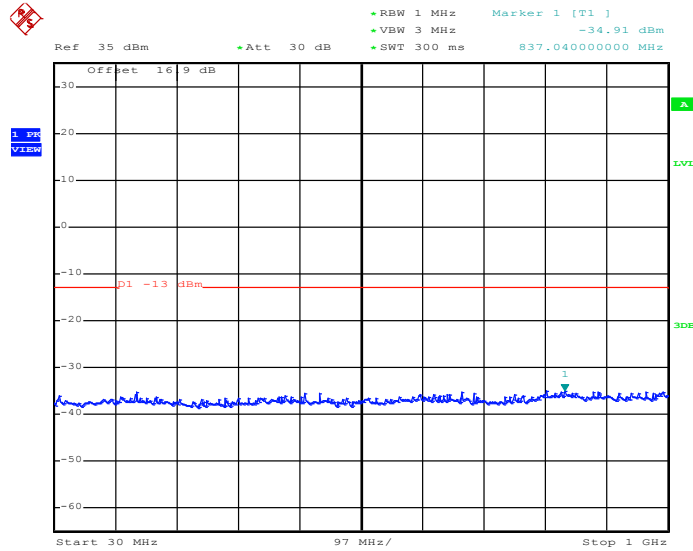

Date: 2.OCT.2014 14:22:38

Conducted Spurious Emission Plot between 1GHz ~ 3GHz

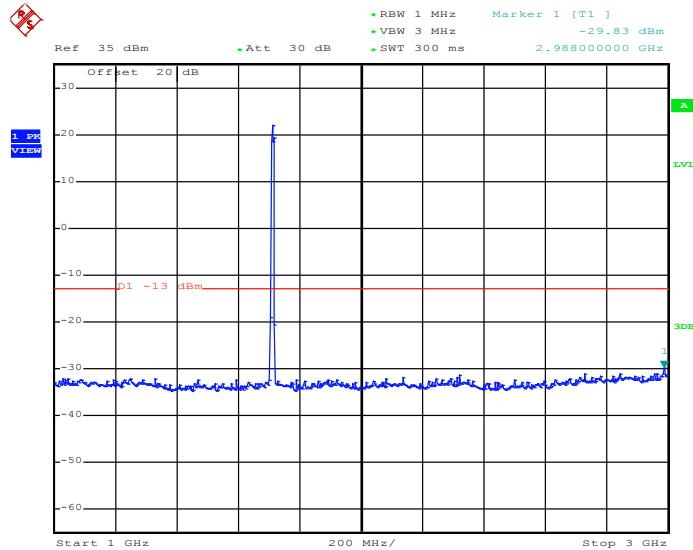

Date: 2.OCT.2014 14:22:46



Conducted Spurious Emission Plot between 3GHz ~ 7GHz

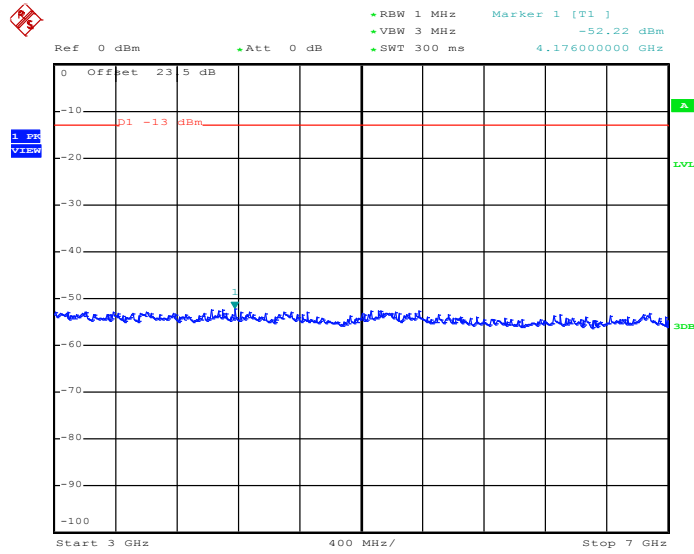

Date: 2.OCT.2014 14:22:57

Conducted Spurious Emission Plot between 7GHz ~ 13.6GHz

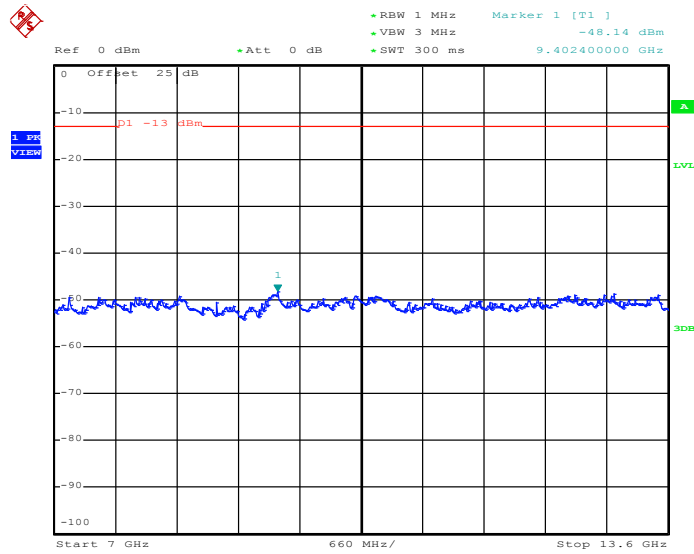

Date: 2.OCT.2014 14:23:05



Conducted Spurious Emission Plot between 13.6GHz ~ 18GHz

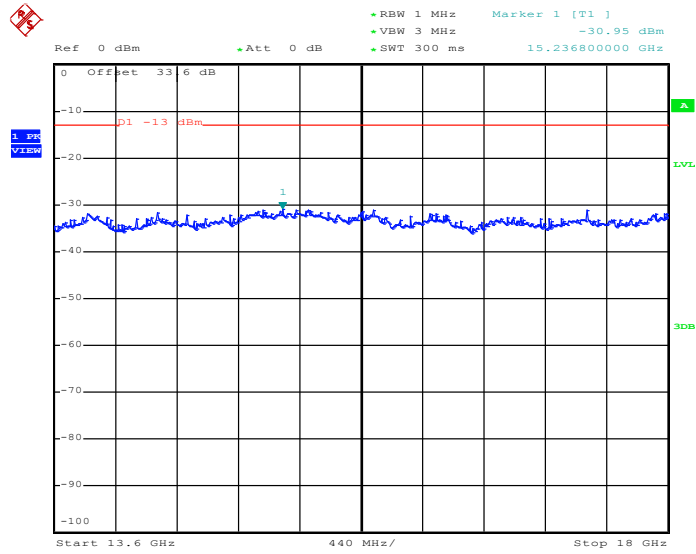

Date: 2.OCT.2014 14:23:14



Band :	WCDMA Band IV	Channel :	CH1413
Test Mode :	RMC 12.2Kbps Link (QPSK)	Frequency :	1732.6 MHz

Conducted Spurious Emission Plot between 30MHz ~ 1GHz

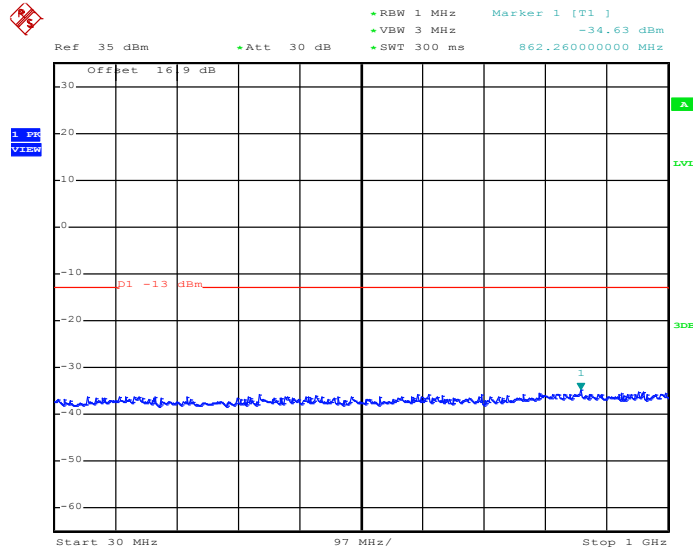

Date: 2.OCT.2014 14:21:25

Conducted Spurious Emission Plot between 1GHz ~ 3GHz

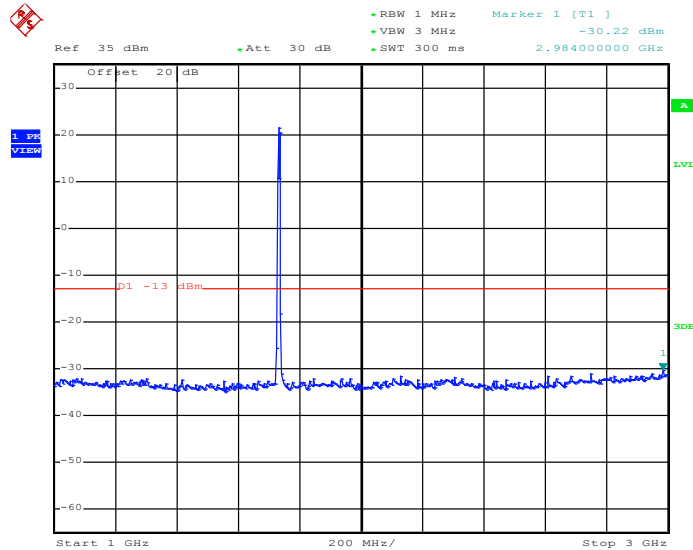

Date: 2.OCT.2014 14:21:33



Conducted Spurious Emission Plot between 3GHz ~ 7GHz

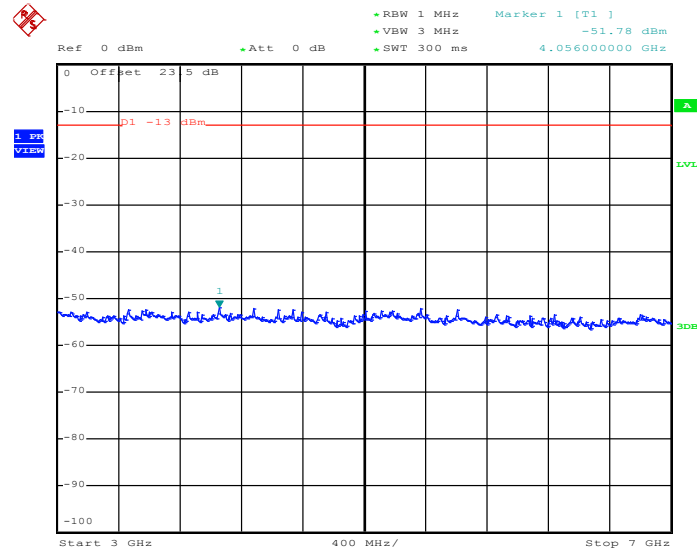

Date: 2.OCT.2014 14:21:44

Conducted Spurious Emission Plot between 7GHz ~ 13.6GHz

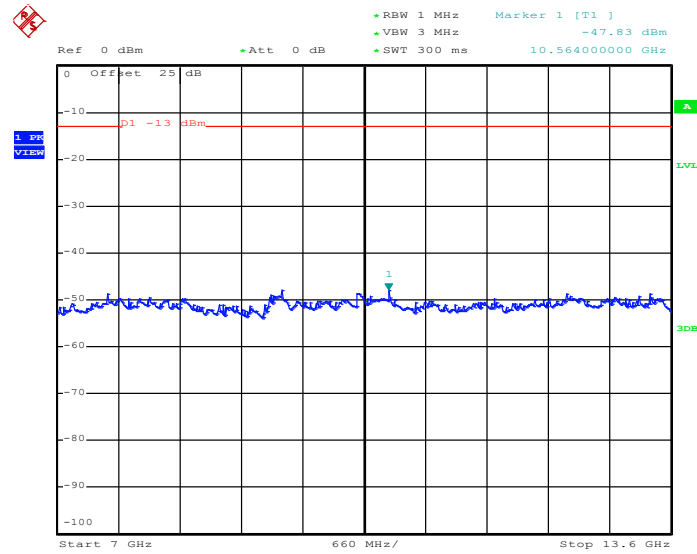

Date: 2.OCT.2014 14:21:53



Conducted Spurious Emission Plot between 13.6GHz ~ 18GHz

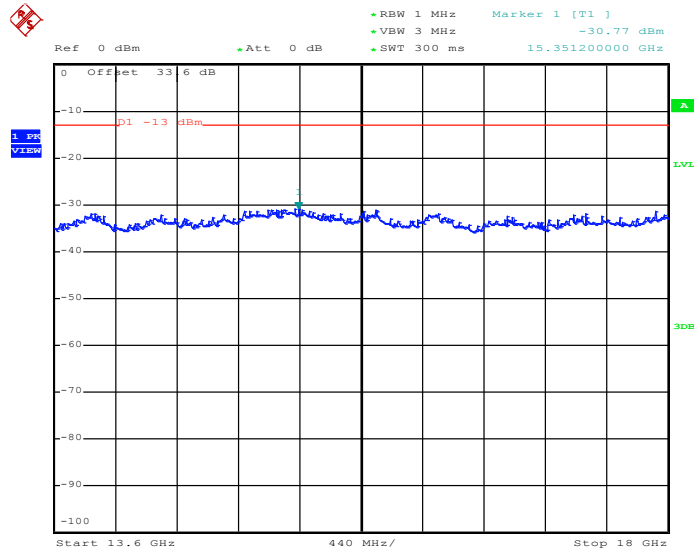

Date: 2.OCT.2014 14:22:01



Band :	WCDMA Band IV	Channel :	CH1513
Test Mode :	RMC 12.2Kbps Link (QPSK)	Frequency :	1752.6 MHz

Conducted Spurious Emission Plot between 30MHz ~ 1GHz

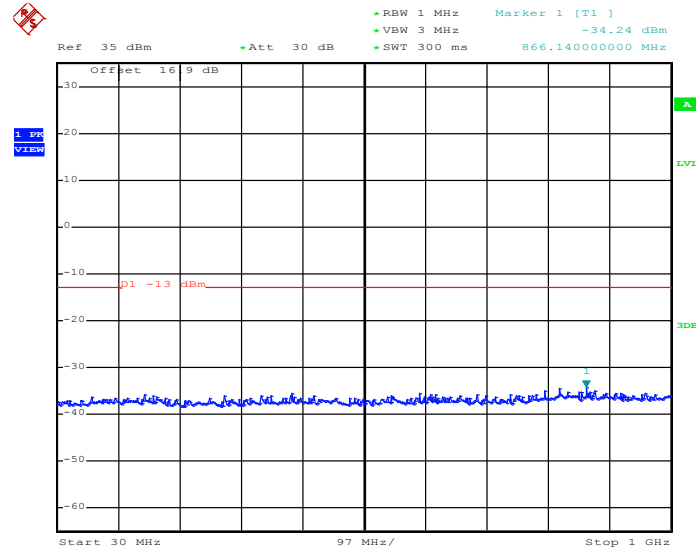

Date: 2.OCT.2014 14:23:47

Conducted Spurious Emission Plot between 1GHz ~ 3GHz

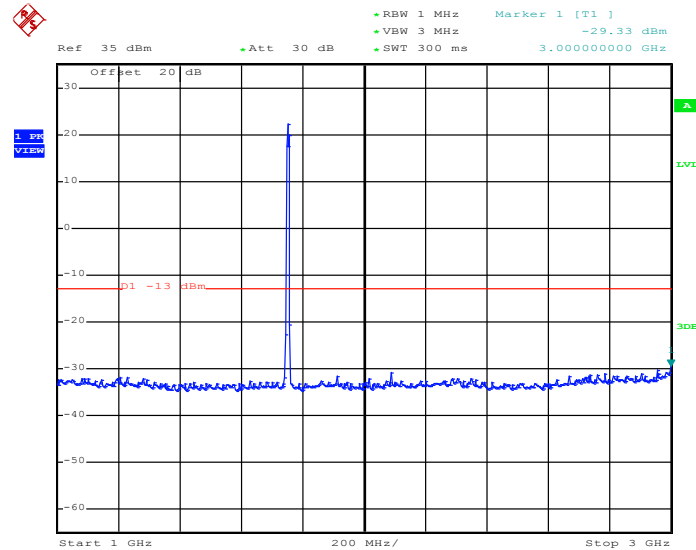

Date: 2.OCT.2014 14:23:56



Conducted Spurious Emission Plot between 3GHz ~ 7GHz

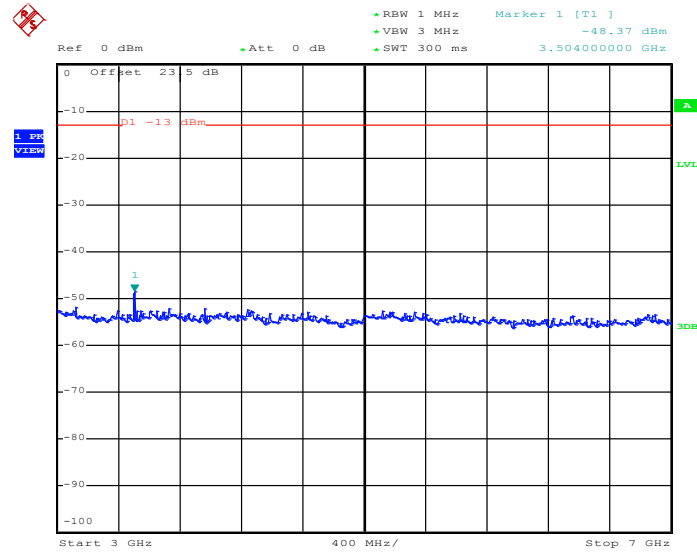

Date: 2.OCT.2014 14:24:06

Conducted Spurious Emission Plot between 7GHz ~ 13.6GHz

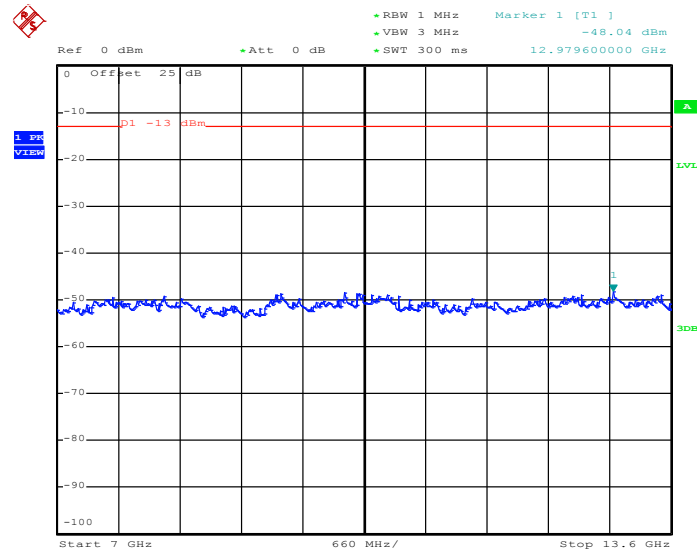

Date: 2.OCT.2014 14:24:15



Conducted Spurious Emission Plot between 13.6GHz ~ 18GHz

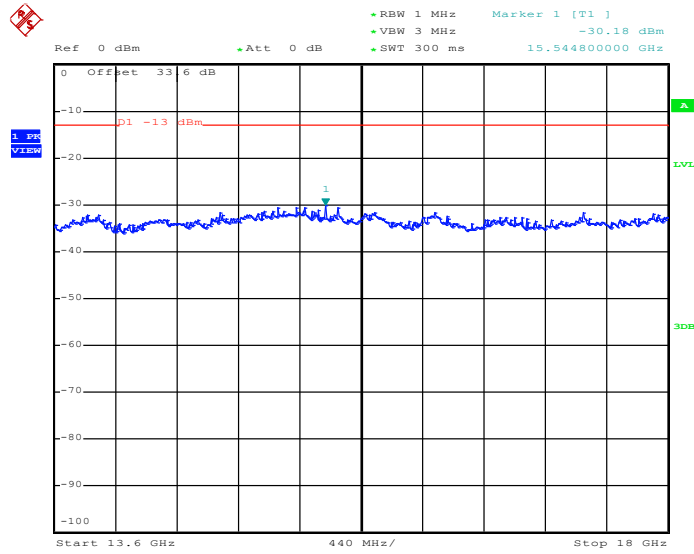

Date: 2.OCT.2014 14:24:23



Band :	WCDMA Band II	Channel :	CH9262
Test Mode :	RMC 12.2Kbps Link (QPSK)	Frequency :	1852.4 MHz

Conducted Spurious Emission Plot between 30MHz ~ 1GHz

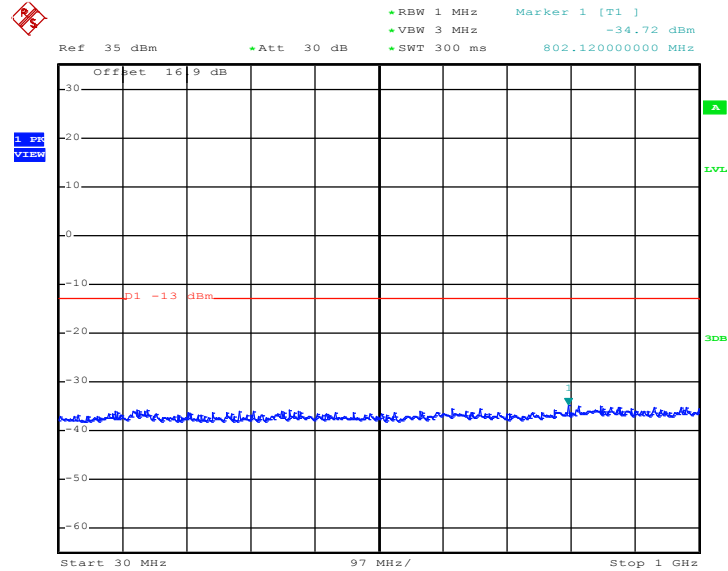

Date: 2.OCT.2014 13:52:44

Conducted Spurious Emission Plot between 1GHz ~ 3GHz

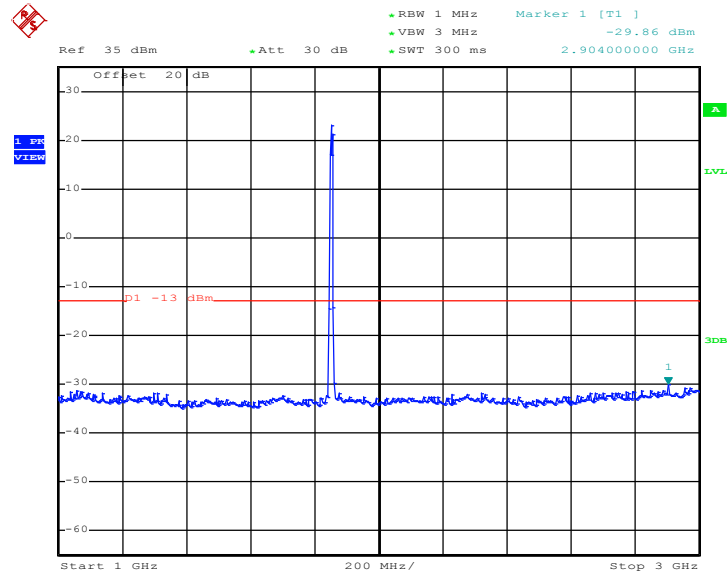

Date: 2.OCT.2014 13:52:52



Conducted Spurious Emission Plot between 3GHz ~ 7GHz

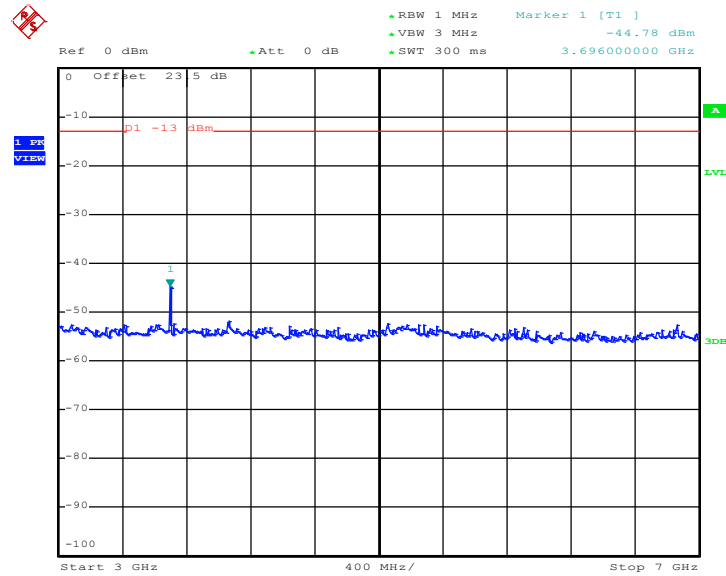

Date: 2.OCT.2014 13:53:03

Conducted Spurious Emission Plot between 7GHz ~ 13.6GHz

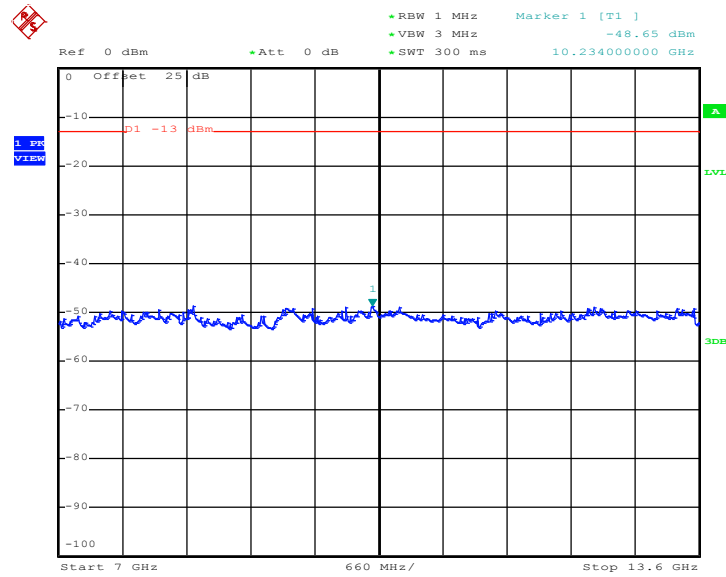

Date: 2.OCT.2014 13:53:11



Conducted Spurious Emission Plot between 13.6GHz ~ 19.1GHz

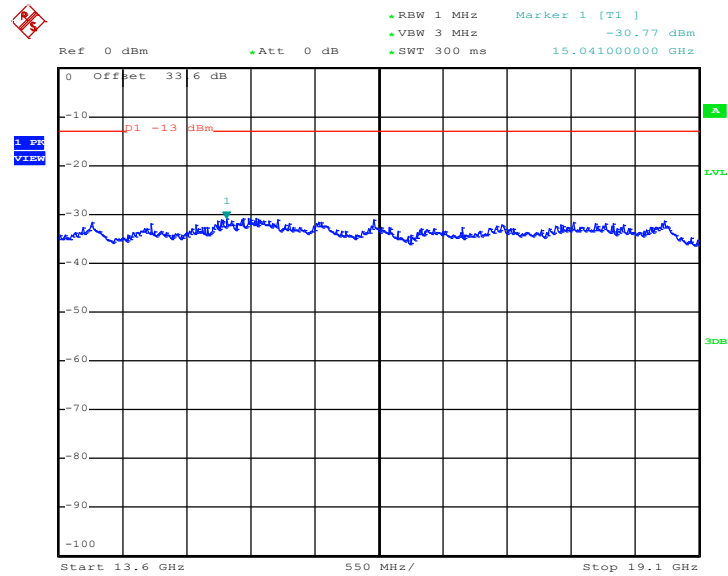

Date: 2.OCT.2014 13:53:20



Band :	WCDMA Band II	Channel :	CH9400
Test Mode :	RMC 12.2Kbps Link (QPSK)	Frequency :	1880.0 MHz

Conducted Spurious Emission Plot between 30MHz ~ 1GHz

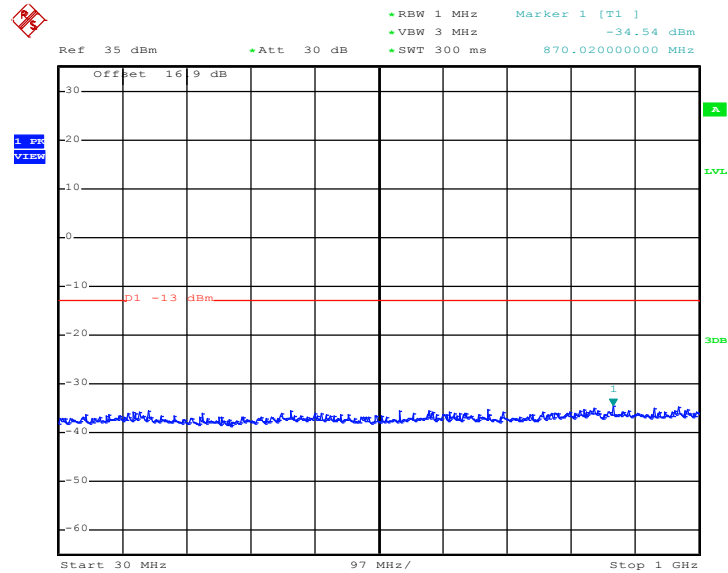

Date: 2.OCT.2014 13:50:51

Conducted Spurious Emission Plot between 1GHz ~ 3GHz

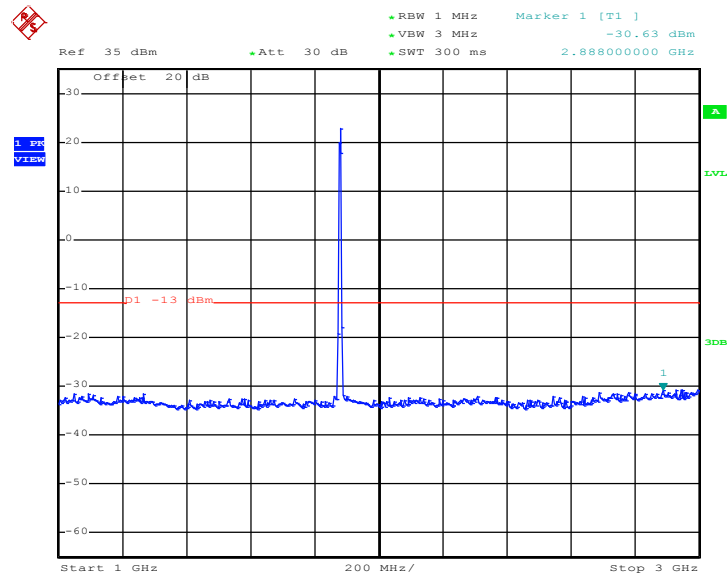

Date: 2.OCT.2014 13:51:00



Conducted Spurious Emission Plot between 3GHz ~ 7GHz

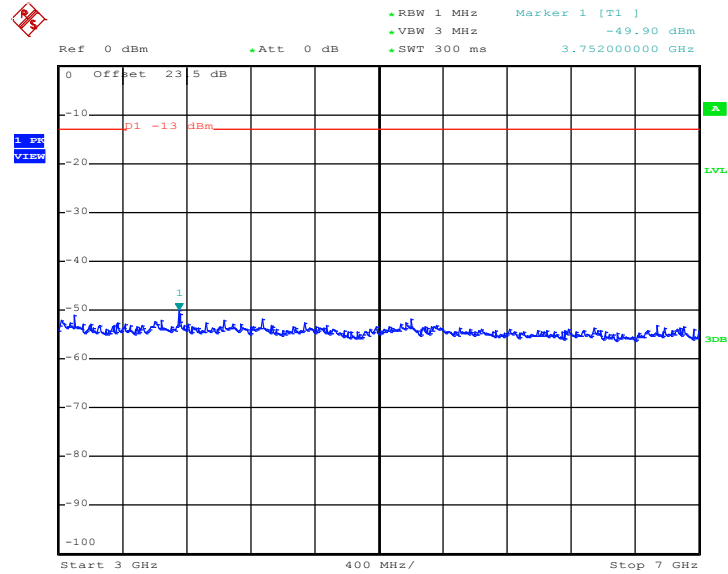

Date: 2.OCT.2014 13:51:11

Conducted Spurious Emission Plot between 7GHz ~ 13.6GHz

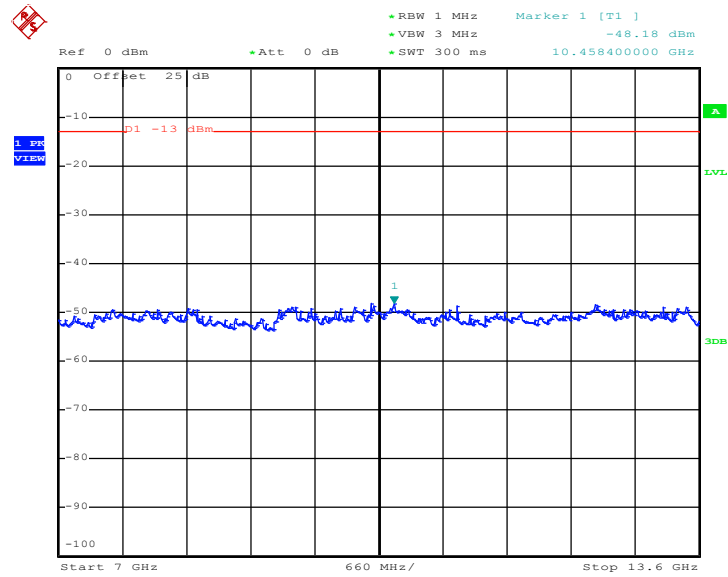

Date: 2.OCT.2014 13:51:20



Conducted Spurious Emission Plot between 13.6GHz ~ 19.1GHz

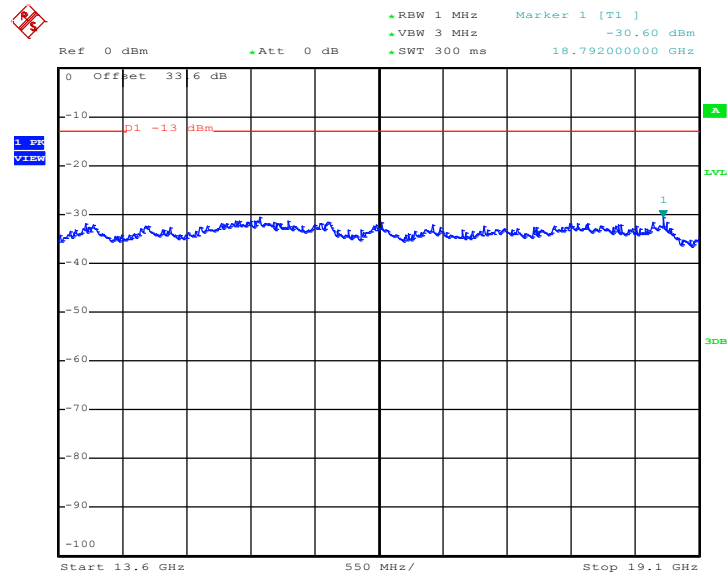

Date: 2.OCT.2014 13:51:28



Band :	WCDMA Band II	Channel :	CH9538
Test Mode :	RMC 12.2Kbps Link (QPSK)	Frequency :	1907.6 MHz

Conducted Spurious Emission Plot between 30MHz ~ 1GHz

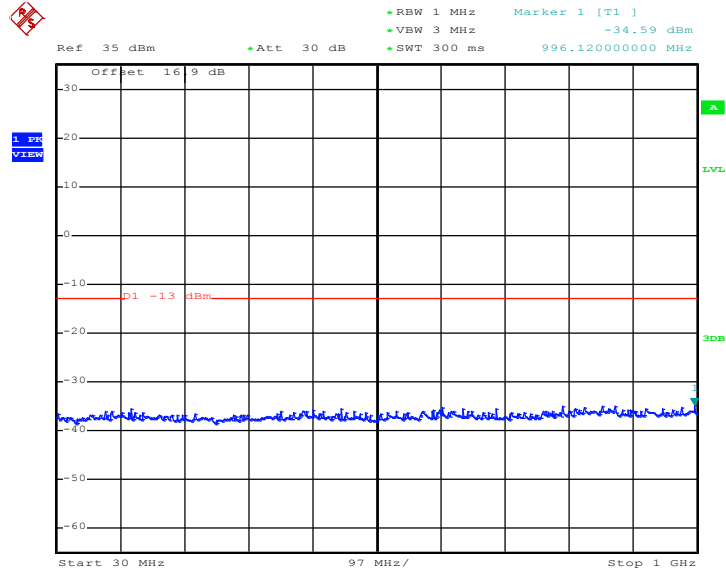

Date: 2.OCT.2014 13:54:20

Conducted Spurious Emission Plot between 1GHz ~ 3GHz

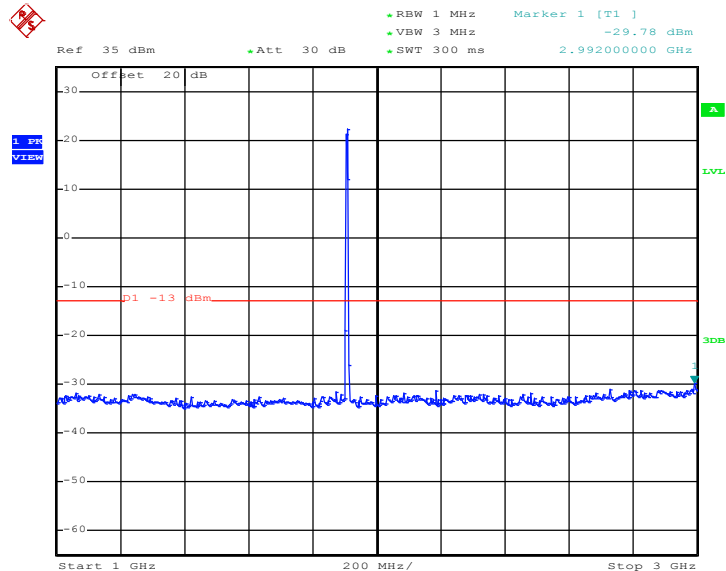

Date: 2.OCT.2014 13:54:29



Conducted Spurious Emission Plot between 3GHz ~ 7GHz

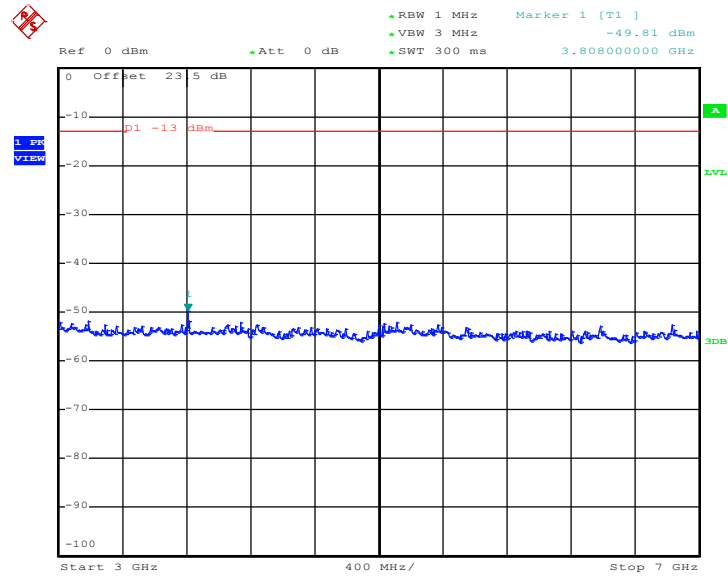

Date: 2.OCT.2014 13:54:40

Conducted Spurious Emission Plot between 7GHz ~ 13.6GHz

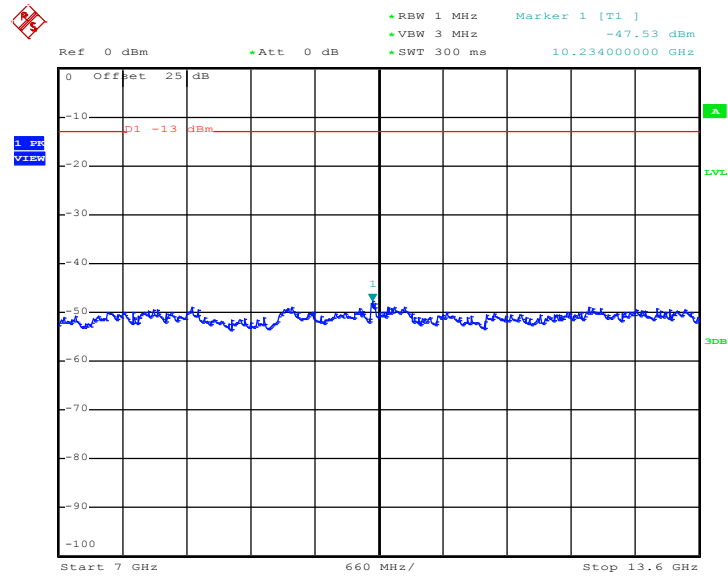

Date: 2.OCT.2014 13:54:49



Conducted Spurious Emission Plot between 13.6GHz ~ 19.1GHz

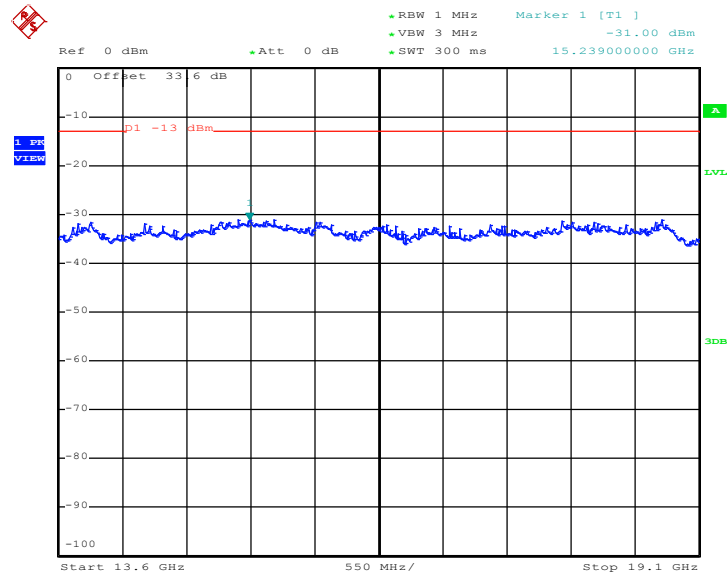

Date: 2.OCT.2014 13:54:57



3.6 Field Strength of Spurious Radiation Measurement

3.6.1 Description of Field Strength of Spurious Radiated Measurement

The power of any emission outside of the authorized operating frequency ranges must be attenuated below the transmitter power (P) by a factor of at least $43 + 10 \log (P)$ dB. The spectrum is scanned from 30 MHz up to a frequency including its 10th harmonic.

3.6.2 Measuring Instruments

The measuring equipment is listed in the section 4 of this test report.

3.6.3 Test Procedures

1. The testing follows FCC KDB 971168 v02r01 Section 5.8 and ANSI / TIA-603-C-2004 Section 2.2.12.
2. The EUT was placed on a rotatable wooden table 0.8 meters above the ground.
3. The EUT was set 3 meters from the receiving antenna, which was mounted on the antenna tower.
4. The table was rotated 360 degrees to determine the position of the highest spurious emission.
5. The height of the receiving antenna is varied between one meter and four meters to search for the maximum spurious emission for both horizontal and vertical polarizations.
6. Make the measurement with the spectrum analyzer's RBW = 1MHz, VBW = 3MHz, taking record of maximum spurious emission.
7. A horn antenna was substituted in place of the EUT and was driven by a signal generator.
8. Tune the output power of signal generator to the same emission level with EUT maximum spurious emission.
9. Taking the record of output power at antenna port.
10. Repeat step 7 to step 8 for another polarization.
11. $EIRP \text{ (dBm)} = S.G. \text{ Power} - Tx \text{ Cable Loss} + Tx \text{ Antenna Gain}$
12. $ERP \text{ (dBm)} = EIRP - 2.15$
13. The RF fundamental frequency should be excluded against the limit line in the operating frequency band.
14. The limit line is derived from $43 + 10\log(P)$ dB below the transmitter power P(Watts)
 $= P(W) - [43 + 10\log(P)] \text{ (dB)}$
 $= [30 + 10\log(P)] \text{ (dBm)} - [43 + 10\log(P)] \text{ (dB)}$
 $= -13dBm.$

3.6.4 Test Setup

For radiated emissions from 30MHz to 1GHz

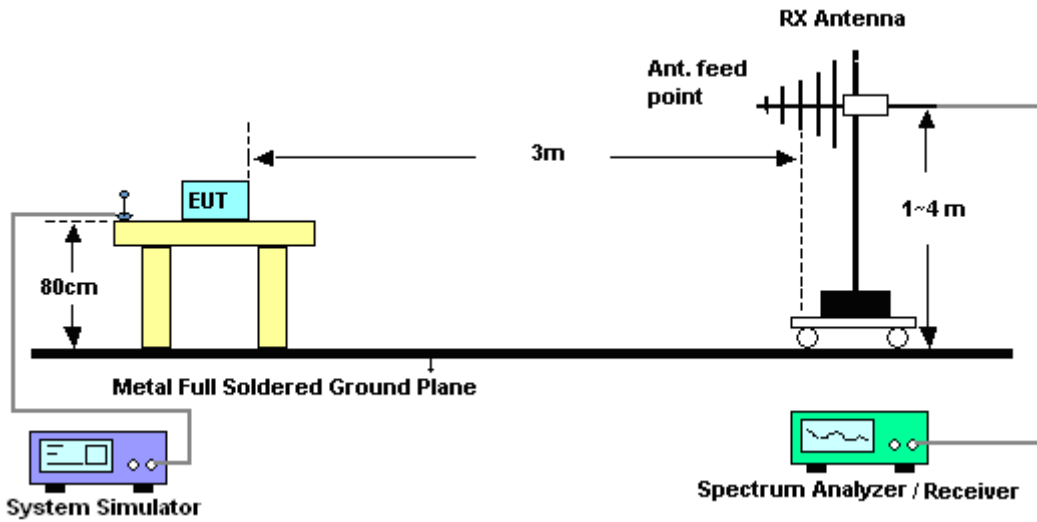

For radiated emissions above 1GHz

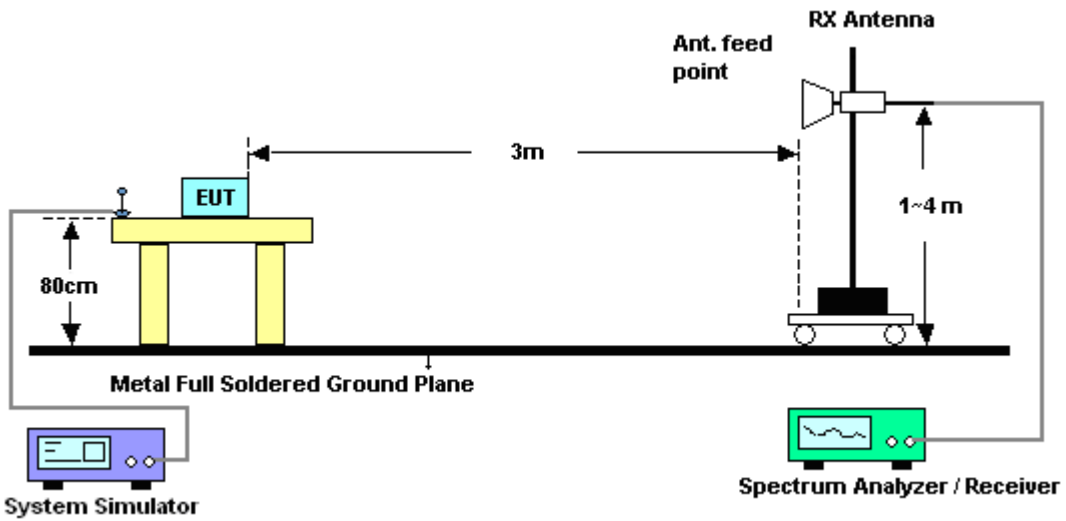



3.6.5 Test Result of Field Strength of Spurious Radiated

<Low Channel>

Band :	GSM850		Temperature :	23~24°C					
Test Mode :	GPRS class 8 Link (GMSK)		Relative Humidity :	46~48%					
Test Engineer :	Derreck Chen		Polarization :	Horizontal					
Remark :	Spurious emissions within 30-1000MHz were found more than 20dB below limit line.								
Frequency (MHz)	ERP (dBm)	Limit (dBm)	Over Limit (dB)	SPA Reading (dBm)	S.G. Power (dBm)	TX Cable loss (dB)	TX Antenna Gain (dBi)	Polarization (H/V)	Result
1648	-44.99	-13	-31.99	-55.76	-46.75	0.98	4.89	H	Pass
2472	-40.08	-13	-27.08	-55.58	-41.96	1.28	5.32	H	Pass
3296	-50.06	-13	-37.06	-65.65	-53.47	1.54	7.10	H	Pass

Band :	GSM850		Temperature :	23~24°C					
Test Mode :	GPRS class 8 Link (GMSK)		Relative Humidity :	46~48%					
Test Engineer :	Derreck Chen		Polarization :	Vertical					
Remark :	Spurious emissions within 30-1000MHz were found more than 20dB below limit line.								
Frequency (MHz)	ERP (dBm)	Limit (dBm)	Over Limit (dB)	SPA Reading (dBm)	S.G. Power (dBm)	TX Cable loss (dB)	TX Antenna Gain (dBi)	Polarization (H/V)	Result
1648	-49.88	-13	-36.88	-63.1	-51.64	0.98	4.89	V	Pass
2472	-45.98	-13	-32.98	-61.84	-47.86	1.28	5.32	V	Pass
3296	-47.63	-13	-34.63	-65.5	-51.04	1.54	7.10	V	Pass



<Middle Channel>

Band :	GSM850		Temperature :	23~24°C					
Test Mode :	GPRS class 8 Link (GMSK)		Relative Humidity :	46~48%					
Test Engineer :	Derreck Chen		Polarization :	Horizontal					
Remark :	Spurious emissions within 30-1000MHz were found more than 20dB below limit line.								
Frequency (MHz)	ERP (dBm)	Limit (dBm)	Over Limit (dB)	SPA Reading (dBm)	S.G. Power (dBm)	TX Cable loss (dB)	TX Antenna Gain (dBi)	Polarization (H/V)	Result
1672	-46.27	-13	-33.27	-57.22	-47.95	0.99	4.82	H	Pass
2512	-36.57	-13	-23.57	-52.02	-38.54	1.29	5.41	H	Pass
3344	-49.86	-13	-36.86	-65.85	-53.47	1.56	7.31	H	Pass

Band :	GSM850		Temperature :	23~24°C					
Test Mode :	GPRS class 8 Link (GMSK)		Relative Humidity :	46~48%					
Test Engineer :	Derreck Chen		Polarization :	Vertical					
Remark :	Spurious emissions within 30-1000MHz were found more than 20dB below limit line.								
Frequency (MHz)	ERP (dBm)	Limit (dBm)	Over Limit (dB)	SPA Reading (dBm)	S.G. Power (dBm)	TX Cable loss (dB)	TX Antenna Gain (dBi)	Polarization (H/V)	Result
1672	-48.56	-13	-35.56	-61.8	-50.24	0.99	4.82	V	Pass
2512	-44.40	-13	-31.40	-60.35	-46.37	1.29	5.41	V	Pass
3344	-48.24	-13	-35.24	-66.05	-51.85	1.56	7.31	V	Pass



<High Channel>

Band :	GSM850		Temperature :	23~24°C					
Test Mode :	GPRS class 8 Link (GMSK)		Relative Humidity :	46~48%					
Test Engineer :	Derreck Chen		Polarization :	Horizontal					
Remark :	Spurious emissions within 30-1000MHz were found more than 20dB below limit line.								
Frequency (MHz)	ERP (dBm)	Limit (dBm)	Over Limit (dB)	SPA Reading (dBm)	S.G. Power (dBm)	TX Cable loss (dB)	TX Antenna Gain (dBi)	Polarization (H/V)	Result
1696	-45.25	-13	-32.25	-56.47	-46.85	1.00	4.75	H	Pass
2544	-38.26	-13	-25.26	-53.82	-40.24	1.30	5.44	H	Pass
3392	-47.68	-13	-34.68	-64.2	-51.48	1.57	7.52	H	Pass

Band :	GSM850		Temperature :	23~24°C					
Test Mode :	GPRS class 8 Link (GMSK)		Relative Humidity :	46~48%					
Test Engineer :	Derreck Chen		Polarization :	Vertical					
Remark :	Spurious emissions within 30-1000MHz were found more than 20dB below limit line.								
Frequency (MHz)	ERP (dBm)	Limit (dBm)	Over Limit (dB)	SPA Reading (dBm)	S.G. Power (dBm)	TX Cable loss (dB)	TX Antenna Gain (dBi)	Polarization (H/V)	Result
1696	-49.25	-13	-36.25	-62.63	-50.85	1.00	4.75	V	Pass
2544	-43.88	-13	-30.88	-60.14	-45.86	1.30	5.44	V	Pass
3392	-48.67	-13	-35.67	-66.1	-52.47	1.57	7.52	V	Pass



<Low Channel>

Band :	GSM850	Temperature :	23~24°C						
Test Mode :	EDGE class 8 Link (8PSK)	Relative Humidity :	46~48%						
Test Engineer :	Derreck Chen	Polarization :	Horizontal						
Remark :	Spurious emissions within 30-1000MHz were found more than 20dB below limit line.								
Frequency (MHz)	ERP (dBm)	Limit (dBm)	Over Limit (dB)	SPA Reading (dBm)	S.G. Power (dBm)	TX Cable loss (dB)	TX Antenna Gain (dBi)	Polarization (H/V)	Result
1672	-53.66	-13	-40.66	-64.54	-55.34	0.99	4.82	H	Pass
2512	-48.86	-13	-35.86	-64.55	-50.83	1.29	5.41	H	Pass
3344	-48.88	-13	-35.88	-65.32	-52.49	1.56	7.31	H	Pass

Band :	GSM850	Temperature :	23~24°C						
Test Mode :	EDGE class 8 Link (8PSK)	Relative Humidity :	46~48%						
Test Engineer :	Derreck Chen	Polarization :	Vertical						
Remark :	Spurious emissions within 30-1000MHz were found more than 20dB below limit line.								
Frequency (MHz)	ERP (dBm)	Limit (dBm)	Over Limit (dB)	SPA Reading (dBm)	S.G. Power (dBm)	TX Cable loss (dB)	TX Antenna Gain (dBi)	Polarization (H/V)	Result
1672	-49.99	-13	-36.99	-63.47	-51.67	0.99	4.82	V	Pass
2512	-48.94	-13	-35.94	-65.06	-50.91	1.29	5.41	V	Pass
3344	-47.14	-13	-34.14	-65.13	-50.75	1.56	7.31	V	Pass



<Middle Channel>

Band :	GSM850	Temperature :	23~24°C						
Test Mode :	EDGE class 8 Link (8PSK)	Relative Humidity :	46~48%						
Test Engineer :	Derreck Chen	Polarization :	Horizontal						
Remark :	Spurious emissions within 30-1000MHz were found more than 20dB below limit line.								
Frequency (MHz)	ERP (dBm)	Limit (dBm)	Over Limit (dB)	SPA Reading (dBm)	S.G. Power (dBm)	TX Cable loss (dB)	TX Antenna Gain (dBi)	Polarization (H/V)	Result
1672	-49.80	-13	-36.80	-60.66	-51.48	0.99	4.82	H	Pass
2512	-42.54	-13	-29.54	-58.28	-44.51	1.29	5.41	H	Pass
3344	-49.66	-13	-36.66	-65.53	-53.27	1.56	7.31	H	Pass

Band :	GSM850	Temperature :	23~24°C						
Test Mode :	EDGE class 8 Link (8PSK)	Relative Humidity :	46~48%						
Test Engineer :	Derreck Chen	Polarization :	Vertical						
Remark :	Spurious emissions within 30-1000MHz were found more than 20dB below limit line.								
Frequency (MHz)	ERP (dBm)	Limit (dBm)	Over Limit (dB)	SPA Reading (dBm)	S.G. Power (dBm)	TX Cable loss (dB)	TX Antenna Gain (dBi)	Polarization (H/V)	Result
1672	-51.46	-13	-38.46	-64.67	-53.14	0.99	4.82	V	Pass
2512	-48.60	-13	-35.60	-64.58	-50.57	1.29	5.41	V	Pass
3344	-47.25	-13	-34.25	-65.15	-50.86	1.56	7.31	V	Pass



<High Channel>

Band :	GSM850				Temperature :	23~24°C			
Test Mode :	EDGE class 8 Link (8PSK)				Relative Humidity :	46~48%			
Test Engineer :	Derreck Chen				Polarization :	Horizontal			
Remark :	Spurious emissions within 30-1000MHz were found more than 20dB below limit line.								
Frequency (MHz)	ERP (dBm)	Limit (dBm)	Over Limit (dB)	SPA Reading (dBm)	S.G. Power (dBm)	TX Cable loss (dB)	TX Antenna Gain (dBi)	Polarization (H/V)	Result
1696	-48.25	-13	-35.25	-59.32	-49.85	1.00	4.75	H	Pass
2544	-45.26	-13	-32.26	-60.87	-47.24	1.30	5.44	H	Pass
3392	-49.47	-13	-36.47	-65.77	-53.27	1.57	7.52	H	Pass

Band :	GSM850				Temperature :	23~24°C			
Test Mode :	EDGE class 8 Link (8PSK)				Relative Humidity :	46~48%			
Test Engineer :	Derreck Chen				Polarization :	Vertical			
Remark :	Spurious emissions within 30-1000MHz were found more than 20dB below limit line.								
Frequency (MHz)	ERP (dBm)	Limit (dBm)	Over Limit (dB)	SPA Reading (dBm)	S.G. Power (dBm)	TX Cable loss (dB)	TX Antenna Gain (dBi)	Polarization (H/V)	Result
1696	-50.54	-13	-37.54	-63.81	-52.14	1.00	4.75	V	Pass
2544	-48.36	-13	-35.36	-64.15	-52.49	1.30	5.44	V	Pass
3392	-47.61	-13	-34.61	-65.22	-53.56	1.57	7.52	V	Pass



<Low Channel>

Band :	GSM1900	Temperature :	23~24°C						
Test Mode :	GPRS class 8 Link (GMSK)	Relative Humidity :	46~48%						
Test Engineer :	Derreck Chen	Polarization :	Horizontal						
Remark :	Spurious emissions within 30-1000MHz were found more than 20dB below limit line.								
Frequency (MHz)	EIRP (dBm)	Limit (dBm)	Over Limit (dB)	SPA Reading (dBm)	S.G. Power (dBm)	TX Cable loss (dB)	TX Antenna Gain (dBi)	Polarization (H/V)	Result
3700	-48.82	-13	-35.82	-66.37	-55.39	1.67	8.24	H	Pass
5548	-45.00	-13	-32.00	-67.36	-52.07	2.65	9.72	H	Pass
7403	-38.26	-13	-25.26	-67.54	-47.41	2.46	11.61	H	Pass

Band :	GSM1900	Temperature :	23~24°C						
Test Mode :	GPRS class 8 Link (GMSK)	Relative Humidity :	46~48%						
Test Engineer :	Derreck Chen	Polarization :	Vertical						
Remark :	Spurious emissions within 30-1000MHz were found more than 20dB below limit line.								
Frequency (MHz)	EIRP (dBm)	Limit (dBm)	Over Limit (dB)	SPA Reading (dBm)	S.G. Power (dBm)	TX Cable loss (dB)	TX Antenna Gain (dBi)	Polarization (H/V)	Result
3700	-47.80	-13	-34.80	-66.13	-54.37	1.67	8.24	V	Pass
5548	-45.09	-13	-32.09	-67.45	-52.16	2.65	9.72	V	Pass
7403	-38.39	-13	-25.39	-67.57	-47.54	2.46	11.61	V	Pass



<Middle Channel>

Band :	GSM1900	Temperature :	23~24°C						
Test Mode :	GPRS class 8 Link (GMSK)	Relative Humidity :	46~48%						
Test Engineer :	Derreck Chen	Polarization :	Horizontal						
Remark :	Spurious emissions within 30-1000MHz were found more than 20dB below limit line.								
Frequency (MHz)	EIRP (dBm)	Limit (dBm)	Over Limit (dB)	SPA Reading (dBm)	S.G. Power (dBm)	TX Cable loss (dB)	TX Antenna Gain (dBi)	Polarization (H/V)	Result
3763	-48.85	-13	-35.85	-66.33	-55.48	1.69	8.32	H	Pass
5639	-44.52	-13	-31.52	-66.86	-51.57	2.71	9.76	H	Pass
7522	-38.10	-13	-25.10	-87.33	-47.49	2.42	11.81	H	Pass

Band :	GSM1900	Temperature :	23~24°C						
Test Mode :	GPRS class 8 Link (GMSK)	Relative Humidity :	46~48%						
Test Engineer :	Derreck Chen	Polarization :	Vertical						
Remark :	Spurious emissions within 30-1000MHz were found more than 20dB below limit line.								
Frequency (MHz)	EIRP (dBm)	Limit (dBm)	Over Limit (dB)	SPA Reading (dBm)	S.G. Power (dBm)	TX Cable loss (dB)	TX Antenna Gain (dBi)	Polarization (H/V)	Result
3763	-48.06	-13	-35.06	-66.59	-54.69	1.69	8.32	V	Pass
5639	-44.02	-13	-31.02	-66.49	-51.07	2.71	9.76	V	Pass
7522	-37.99	-13	-24.99	-67.09	-47.38	2.42	11.81	V	Pass



<High Channel>

Band :	GSM1900	Temperature :	23~24°C						
Test Mode :	GPRS class 8 Link (GMSK)	Relative Humidity :	46~48%						
Test Engineer :	Derreck Chen	Polarization :	Horizontal						
Remark :	Spurious emissions within 30-1000MHz were found more than 20dB below limit line.								
Frequency (MHz)	EIRP (dBm)	Limit (dBm)	Over Limit (dB)	SPA Reading (dBm)	S.G. Power (dBm)	TX Cable loss (dB)	TX Antenna Gain (dBi)	Polarization (H/V)	Result
3819	-49.04	-13	-36.04	-66.61	-55.72	1.70	8.38	H	Pass
5730	-44.45	-13	-31.45	-67.35	-51.48	2.76	9.79	H	Pass
7641	-38.77	-13	-25.77	-67.29	-48.27	2.38	11.88	H	Pass
9552	-38.52	-13	-25.52	-67.8	-48.39	2.60	12.47	H	Pass

Band :	GSM1900	Temperature :	23~24°C						
Test Mode :	GPRS class 8 Link (GMSK)	Relative Humidity :	46~48%						
Test Engineer :	Derreck Chen	Polarization :	Vertical						
Remark :	Spurious emissions within 30-1000MHz were found more than 20dB below limit line.								
Frequency (MHz)	EIRP (dBm)	Limit (dBm)	Over Limit (dB)	SPA Reading (dBm)	S.G. Power (dBm)	TX Cable loss (dB)	TX Antenna Gain (dBi)	Polarization (H/V)	Result
3819	-48.01	-13	-35.01	-66.83	-54.69	1.70	8.38	V	Pass
5730	-44.72	-13	-31.72	-67.37	-51.75	2.76	9.79	V	Pass
7641	-38.77	-13	-25.77	-66.71	-48.27	2.38	11.88	V	Pass
9552	-39.06	-13	-26.06	-68.06	-48.93	2.60	12.47	V	Pass



<Low Channel>

Band :	GSM1900	Temperature :	23~24°C						
Test Mode :	EDGE class 8 Link (8PSK)	Relative Humidity :	46~48%						
Test Engineer :	Derreck Chen	Polarization :	Horizontal						
Remark :	Spurious emissions within 30-1000MHz were found more than 20dB below limit line.								
Frequency (MHz)	EIRP (dBm)	Limit (dBm)	Over Limit (dB)	SPA Reading (dBm)	S.G. Power (dBm)	TX Cable loss (dB)	TX Antenna Gain (dBi)	Polarization (H/V)	Result
3700	-48.70	-13	-35.70	-66.11	-55.27	1.67	8.24	H	Pass
5548	-45.78	-13	-32.78	-67.34	-52.85	2.65	9.72	H	Pass
7403	-38.04	-13	-25.04	-67.64	-47.19	2.46	11.61	H	Pass

Band :	GSM1900	Temperature :	23~24°C						
Test Mode :	EDGE class 8 Link (8PSK)	Relative Humidity :	46~48%						
Test Engineer :	Derreck Chen	Polarization :	Vertical						
Remark :	Spurious emissions within 30-1000MHz were found more than 20dB below limit line.								
Frequency (MHz)	EIRP (dBm)	Limit (dBm)	Over Limit (dB)	SPA Reading (dBm)	S.G. Power (dBm)	TX Cable loss (dB)	TX Antenna Gain (dBi)	Polarization (H/V)	Result
3700	-47.80	-13	-34.80	-66.37	-54.37	1.67	8.24	V	Pass
5548	-45.42	-13	-32.42	-67.64	-52.49	2.65	9.72	V	Pass
7403	-38.16	-13	-25.16	-67.32	-47.31	2.46	11.61	V	Pass



<Middle Channel>

Band :	GSM1900	Temperature :	23~24°C						
Test Mode :	EDGE class 8 Link (8PSK)	Relative Humidity :	46~48%						
Test Engineer :	Derreck Chen	Polarization :	Horizontal						
Remark :	Spurious emissions within 30-1000MHz were found more than 20dB below limit line.								
Frequency (MHz)	EIRP (dBm)	Limit (dBm)	Over Limit (dB)	SPA Reading (dBm)	S.G. Power (dBm)	TX Cable loss (dB)	TX Antenna Gain (dBi)	Polarization (H/V)	Result
3763	-48.55	-13	-35.55	-66.07	-55.18	1.69	8.32	H	Pass
5639	-44.02	-13	-31.02	-66.67	-51.07	2.71	9.76	H	Pass
7522	-38.20	-13	-25.20	-67.58	-47.59	2.42	11.81	H	Pass

Band :	GSM1900	Temperature :	23~24°C						
Test Mode :	EDGE class 8 Link (8PSK)	Relative Humidity :	46~48%						
Test Engineer :	Derreck Chen	Polarization :	Vertical						
Remark :	Spurious emissions within 30-1000MHz were found more than 20dB below limit line.								
Frequency (MHz)	EIRP (dBm)	Limit (dBm)	Over Limit (dB)	SPA Reading (dBm)	S.G. Power (dBm)	TX Cable loss (dB)	TX Antenna Gain (dBi)	Polarization (H/V)	Result
3763	-48.33	-13	-35.33	-66.62	-54.96	1.69	8.32	V	Pass
5639	-44.32	-13	-31.32	-66.7	-51.37	2.71	9.76	V	Pass
7522	-37.76	-13	-24.76	-66.62	-47.15	2.42	11.81	V	Pass



<High Channel>

Band :	GSM1900	Temperature :	23~24°C						
Test Mode :	EDGE class 8 Link (8PSK)	Relative Humidity :	46~48%						
Test Engineer :	Derreck Chen	Polarization :	Horizontal						
Remark :	Spurious emissions within 30-1000MHz were found more than 20dB below limit line.								
Frequency (MHz)	EIRP (dBm)	Limit (dBm)	Over Limit (dB)	SPA Reading (dBm)	S.G. Power (dBm)	TX Cable loss (dB)	TX Antenna Gain (dBi)	Polarization (H/V)	Result
3819	-48.70	-13	-35.70	-66.68	-55.38	1.70	8.38	H	Pass
5730	-44.14	-13	-31.14	-67.33	-51.17	2.76	9.79	H	Pass
7641	-38.81	-13	-25.81	-67	-48.31	2.38	11.88	H	Pass

Band :	GSM1900	Temperature :	23~24°C						
Test Mode :	EDGE class 8 Link (8PSK)	Relative Humidity :	46~48%						
Test Engineer :	Derreck Chen	Polarization :	Vertical						
Remark :	Spurious emissions within 30-1000MHz were found more than 20dB below limit line.								
Frequency (MHz)	EIRP (dBm)	Limit (dBm)	Over Limit (dB)	SPA Reading (dBm)	S.G. Power (dBm)	TX Cable loss (dB)	TX Antenna Gain (dBi)	Polarization (H/V)	Result
3819	-48.00	-13	-35.00	-66.82	-54.68	1.70	8.38	V	Pass
5730	-44.06	-13	-31.06	-66.81	-51.09	2.76	9.79	V	Pass
7641	-39.07	-13	-26.07	-67.02	-48.57	2.38	11.88	V	Pass



<Low Channel>

Band :	WCDMA Band V	Temperature :	23~24°C						
Test Mode :	RMC 12.2Kbps Link (QPSK)	Relative Humidity :	46~48%						
Test Engineer :	Derreck Chen	Polarization :	Horizontal						
Remark :	Spurious emissions within 30-1000MHz were found more than 20dB below limit line.								
Frequency (MHz)	ERP (dBm)	Limit (dBm)	Over Limit (dB)	SPA Reading (dBm)	S.G. Power (dBm)	TX Cable loss (dB)	TX Antenna Gain (dBi)	Polarization (H/V)	Result
1656	-36.73	-13	-23.73	-47.42	-38.46	0.98	4.86	H	Pass
2480	-47.94	-13	-34.94	-63.53	-49.85	1.28	5.34	H	Pass
3304	-49.03	-13	-36.03	-65.44	-52.47	1.54	7.14	H	Pass

Band :	WCDMA Band V	Temperature :	23~24°C						
Test Mode :	RMC 12.2Kbps Link (QPSK)	Relative Humidity :	46~48%						
Test Engineer :	Derreck Chen	Polarization :	Vertical						
Remark :	Spurious emissions within 30-1000MHz were found more than 20dB below limit line.								
Frequency (MHz)	ERP (dBm)	Limit (dBm)	Over Limit (dB)	SPA Reading (dBm)	S.G. Power (dBm)	TX Cable loss (dB)	TX Antenna Gain (dBi)	Polarization (H/V)	Result
1656	-43.12	-13	-30.12	-55.85	-44.85	0.98	4.86	V	Pass
2480	-49.02	-13	-36.02	-64.84	-50.93	1.28	5.34	V	Pass
3304	-47.74	-13	-34.74	-65.58	-51.18	1.54	7.14	V	Pass



<Middle Channel>

Band :	WCDMA Band V	Temperature :	23~24°C						
Test Mode :	RMC 12.2Kbps Link (QPSK)	Relative Humidity :	46~48%						
Test Engineer :	Derreck Chen	Polarization :	Horizontal						
Remark :	Spurious emissions within 30-1000MHz were found more than 20dB below limit line.								
Frequency (MHz)	ERP (dBm)	Limit (dBm)	Over Limit (dB)	SPA Reading (dBm)	S.G. Power (dBm)	TX Cable loss (dB)	TX Antenna Gain (dBi)	Polarization (H/V)	Result
1672	-33.01	-13	-20.01	-43.79	-34.69	0.99	4.82	H	Pass
2512	-47.95	-13	-34.95	-63.71	-49.92	1.29	5.41	H	Pass
3344	-47.78	-13	-34.78	-64.3	-51.39	1.56	7.31	H	Pass

Band :	WCDMA Band V	Temperature :	23~24°C						
Test Mode :	RMC 12.2Kbps Link (QPSK)	Relative Humidity :	46~48%						
Test Engineer :	Derreck Chen	Polarization :	Vertical						
Remark :	Spurious emissions within 30-1000MHz were found more than 20dB below limit line.								
Frequency (MHz)	ERP (dBm)	Limit (dBm)	Over Limit (dB)	SPA Reading (dBm)	S.G. Power (dBm)	TX Cable loss (dB)	TX Antenna Gain (dBi)	Polarization (H/V)	Result
1672	-40.15	-13	-27.15	-53.38	-41.83	0.99	4.82	V	Pass
2512	-49.22	-13	-36.22	-65.14	-51.19	1.29	5.41	V	Pass
3344	-48.33	-13	-35.33	-65.5	-51.94	1.56	7.31	V	Pass



<High Channel>

Band :	WCDMA Band V					Temperature :	23~24°C		
Test Mode :	RMC 12.2Kbps Link (QPSK)					Relative Humidity :	46~48%		
Test Engineer :	Derreck Chen					Polarization :	Horizontal		
Remark :	Spurious emissions within 30-1000MHz were found more than 20dB below limit line.								
Frequency (MHz)	ERP (dBm)	Limit (dBm)	Over Limit (dB)	SPA Reading (dBm)	S.G. Power (dBm)	TX Cable loss (dB)	TX Antenna Gain (dBi)	Polarization (H/V)	Result
1696	-31.82	-13	-18.82	-42.65	-33.42	1.00	4.75	H	Pass
2536	-49.29	-13	-36.29	-65	-51.27	1.30	5.43	H	Pass
3384	-49.92	-13	-36.92	-66.38	-53.69	1.57	7.49	H	Pass

Band :	WCDMA Band V					Temperature :	23~24°C		
Test Mode :	RMC 12.2Kbps Link (QPSK)					Relative Humidity :	46~48%		
Test Engineer :	Derreck Chen					Polarization :	Vertical		
Remark :	Spurious emissions within 30-1000MHz were found more than 20dB below limit line.								
Frequency (MHz)	ERP (dBm)	Limit (dBm)	Over Limit (dB)	SPA Reading (dBm)	S.G. Power (dBm)	TX Cable loss (dB)	TX Antenna Gain (dBi)	Polarization (H/V)	Result
1696	-37.67	-13	-24.67	-50.93	-39.27	1.00	4.75	V	Pass
2536	-48.97	-13	-35.97	-65.05	-50.95	1.30	5.43	V	Pass
3384	-47.52	-13	-34.52	-65.15	-51.29	1.57	7.49	V	Pass



<Low Channel>

Band :	WCDMA Band IV	Temperature :	23~24°C						
Test Mode :	RMC 12.2Kbps Link (QPSK)	Relative Humidity :	46~48%						
Test Engineer :	Derreck Chen	Polarization :	Horizontal						
Remark :	Spurious emissions within 30-1000MHz were found more than 20dB below limit line.								
Frequency (MHz)	EIRP (dBm)	Limit (dBm)	Over Limit (dB)	SPA Reading (dBm)	S.G. Power (dBm)	TX Cable loss (dB)	TX Antenna Gain (dBi)	Polarization (H/V)	Result
3427	-50.14	-13	-37.14	-66.76	-56.24	1.58	7.68	H	Pass
5137	-47.93	-13	-34.93	-68.14	-55.21	2.42	9.70	H	Pass
6849	-39.41	-13	-26.41	-67.25	-47.39	2.64	10.62	H	Pass

Band :	WCDMA Band IV	Temperature :	23~24°C						
Test Mode :	RMC 12.2Kbps Link (QPSK)	Relative Humidity :	46~48%						
Test Engineer :	Derreck Chen	Polarization :	Vertical						
Remark :	Spurious emissions within 30-1000MHz were found more than 20dB below limit line.								
Frequency (MHz)	EIRP (dBm)	Limit (dBm)	Over Limit (dB)	SPA Reading (dBm)	S.G. Power (dBm)	TX Cable loss (dB)	TX Antenna Gain (dBi)	Polarization (H/V)	Result
3247	-49.88	-13	-36.88	-67.41	-55.24	1.52	6.89	V	Pass
5137	-47.08	-13	-34.08	-67.98	-54.36	2.42	9.70	V	Pass
6849	-39.70	-13	-26.70	-67.03	-47.68	2.64	10.62	V	Pass



<Middle Channel>

Band :	WCDMA Band IV	Temperature :	23~24°C						
Test Mode :	RMC 12.2Kbps Link (QPSK)	Relative Humidity :	46~48%						
Test Engineer :	Derreck Chen	Polarization :	Horizontal						
Remark :	Spurious emissions within 30-1000MHz were found more than 20dB below limit line.								
Frequency (MHz)	EIRP (dBm)	Limit (dBm)	Over Limit (dB)	SPA Reading (dBm)	S.G. Power (dBm)	TX Cable loss (dB)	TX Antenna Gain (dBi)	Polarization (H/V)	Result
3462	-49.98	-13	-36.98	-66.55	-56.22	1.59	7.83	H	Pass
5197	-47.08	-13	-34.08	-67.67	-54.33	2.45	9.70	H	Pass
6930	-39.02	-13	-26.02	-67.41	-47.12	2.61	10.72	H	Pass

Band :	WCDMA Band IV	Temperature :	23~24°C						
Test Mode :	RMC 12.2Kbps Link (QPSK)	Relative Humidity :	46~48%						
Test Engineer :	Derreck Chen	Polarization :	Vertical						
Remark :	Spurious emissions within 30-1000MHz were found more than 20dB below limit line.								
Frequency (MHz)	EIRP (dBm)	Limit (dBm)	Over Limit (dB)	SPA Reading (dBm)	S.G. Power (dBm)	TX Cable loss (dB)	TX Antenna Gain (dBi)	Polarization (H/V)	Result
3462	-49.39	-13	-36.39	-66.85	-55.63	1.59	7.83	V	Pass
5197	-46.88	-13	-33.88	-67.74	-54.13	2.45	9.70	V	Pass
6930	-40.17	-13	-27.17	-67.19	-48.27	2.61	10.72	V	Pass



<High Channel>

Band :	WCDMA Band IV	Temperature :	23~24°C						
Test Mode :	RMC 12.2Kbps Link (QPSK)	Relative Humidity :	46~48%						
Test Engineer :	Derreck Chen	Polarization :	Horizontal						
Remark :	Spurious emissions within 30-1000MHz were found more than 20dB below limit line.								
Frequency (MHz)	EIRP (dBm)	Limit (dBm)	Over Limit (dB)	SPA Reading (dBm)	S.G. Power (dBm)	TX Cable loss (dB)	TX Antenna Gain (dBi)	Polarization (H/V)	Result
3504	-50.72	-13	-37.72	-67.05	-57.12	1.61	8.00	H	Pass
5257	-46.27	-13	-33.27	-67.51	-53.48	2.49	9.70	H	Pass
7010	-38.90	-13	-25.90	-67.14	-47.13	2.59	10.82	H	Pass

Band :	WCDMA Band IV	Temperature :	23~24°C						
Test Mode :	RMC 12.2Kbps Link (QPSK)	Relative Humidity :	46~48%						
Test Engineer :	Derreck Chen	Polarization :	Vertical						
Remark :	Spurious emissions within 30-1000MHz were found more than 20dB below limit line.								
Frequency (MHz)	EIRP (dBm)	Limit (dBm)	Over Limit (dB)	SPA Reading (dBm)	S.G. Power (dBm)	TX Cable loss (dB)	TX Antenna Gain (dBi)	Polarization (H/V)	Result
3504	-48.74	-13	-35.74	-66.22	-55.14	1.61	8.00	V	Pass
5257	-46.28	-13	-33.28	-67.48	-53.49	2.49	9.70	V	Pass
7010	-39.19	-13	-26.19	-67.07	-47.42	2.59	10.82	V	Pass



<Low Channel>

Band :	WCDMA Band II	Temperature :	23~24°C						
Test Mode :	RMC 12.2Kbps Link (QPSK)	Relative Humidity :	46~48%						
Test Engineer :	Derreck Chen	Polarization :	Horizontal						
Remark :	Spurious emissions within 30-1000MHz were found more than 20dB below limit line.								
Frequency (MHz)	EIRP (dBm)	Limit (dBm)	Over Limit (dB)	SPA Reading (dBm)	S.G. Power (dBm)	TX Cable loss (dB)	TX Antenna Gain (dBi)	Polarization (H/V)	Result
3707	-47.59	-13	-34.59	-64.77	-54.17	1.67	8.25	H	Pass
5555	-43.98	-13	-30.98	-66.32	-51.05	2.66	9.72	H	Pass
7410	-38.33	-13	-25.33	-67.49	-47.49	2.46	11.62	H	Pass

Band :	WCDMA Band II	Temperature :	23~24°C						
Test Mode :	RMC 12.2Kbps Link (QPSK)	Relative Humidity :	46~48%						
Test Engineer :	Derreck Chen	Polarization :	Vertical						
Remark :	Spurious emissions within 30-1000MHz were found more than 20dB below limit line.								
Frequency (MHz)	EIRP (dBm)	Limit (dBm)	Over Limit (dB)	SPA Reading (dBm)	S.G. Power (dBm)	TX Cable loss (dB)	TX Antenna Gain (dBi)	Polarization (H/V)	Result
3707	-48.39	-13	-35.39	-66.46	-54.97	1.67	8.25	V	Pass
5555	-44.15	-13	-31.15	-66.55	-51.22	2.66	9.72	V	Pass
7410	-38.15	-13	-25.15	-67.07	-47.31	2.46	11.62	V	Pass



<Middle Channel>

Band :	WCDMA Band II	Temperature :	23~24°C						
Test Mode :	RMC 12.2Kbps Link (QPSK)	Relative Humidity :	46~48%						
Test Engineer :	Derreck Chen	Polarization :	Horizontal						
Remark :	Spurious emissions within 30-1000MHz were found more than 20dB below limit line.								
Frequency (MHz)	EIRP (dBm)	Limit (dBm)	Over Limit (dB)	SPA Reading (dBm)	S.G. Power (dBm)	TX Cable loss (dB)	TX Antenna Gain (dBi)	Polarization (H/V)	Result
3763	-48.85	-13	-35.85	-66.53	-55.48	1.69	8.32	H	Pass
5639	-44.62	-13	-31.62	-66.65	-51.67	2.71	9.76	H	Pass
7522	-37.92	-13	-24.92	-67.23	-47.31	2.42	11.81	H	Pass

Band :	WCDMA Band II	Temperature :	23~24°C						
Test Mode :	RMC 12.2Kbps Link (QPSK)	Relative Humidity :	46~48%						
Test Engineer :	Derreck Chen	Polarization :	Vertical						
Remark :	Spurious emissions within 30-1000MHz were found more than 20dB below limit line.								
Frequency (MHz)	EIRP (dBm)	Limit (dBm)	Over Limit (dB)	SPA Reading (dBm)	S.G. Power (dBm)	TX Cable loss (dB)	TX Antenna Gain (dBi)	Polarization (H/V)	Result
3763	-47.65	-13	-34.65	-66.37	-54.28	1.69	8.32	V	Pass
5639	-44.81	-13	-31.81	-66.62	-51.86	2.71	9.76	V	Pass
7522	-38.15	-13	-25.15	-67.3	-47.54	2.42	11.81	V	Pass



<High Channel>

Band :	WCDMA Band II	Temperature :	23~24°C						
Test Mode :	RMC 12.2Kbps Link (QPSK)	Relative Humidity :	46~48%						
Test Engineer :	Derreck Chen	Polarization :	Horizontal						
Remark :	Spurious emissions within 30-1000MHz were found more than 20dB below limit line.								
Frequency (MHz)	EIRP (dBm)	Limit (dBm)	Over Limit (dB)	SPA Reading (dBm)	S.G. Power (dBm)	TX Cable loss (dB)	TX Antenna Gain (dBi)	Polarization (H/V)	Result
3812	-47.28	-13	-34.28	-64.84	-53.95	1.70	8.37	H	Pass
5723	-43.77	-13	-30.77	-66.81	-50.81	2.75	9.79	H	Pass
7627	-38.90	-13	-25.90	-67.34	-48.39	2.39	11.88	H	Pass

Band :	WCDMA Band II	Temperature :	23~24°C						
Test Mode :	RMC 12.2Kbps Link (QPSK)	Relative Humidity :	46~48%						
Test Engineer :	Derreck Chen	Polarization :	Vertical						
Remark :	Spurious emissions within 30-1000MHz were found more than 20dB below limit line.								
Frequency (MHz)	EIRP (dBm)	Limit (dBm)	Over Limit (dB)	SPA Reading (dBm)	S.G. Power (dBm)	TX Cable loss (dB)	TX Antenna Gain (dBi)	Polarization (H/V)	Result
3812	-47.70	-13	-34.70	-66.42	-54.37	1.70	8.37	V	Pass
5723	-44.20	-13	-31.20	-66.82	-51.24	2.75	9.79	V	Pass
7627	-39.19	-13	-26.19	-67.66	-48.68	2.39	11.88	V	Pass



3.7 Frequency Stability Measurement

3.7.1 Description of Frequency Stability Measurement

The frequency stability shall be measured by variation of ambient temperature and variation of primary supply voltage to ensure that the fundamental emission stays within the authorized frequency block. The frequency stability of the transmitter shall be maintained within $\pm 0.00025\%$ ($\pm 2.5\text{ppm}$) of the center frequency.

3.7.2 Measuring Instruments

The measuring equipment is listed in the section 4 of this test report.

3.7.3 Test Procedures for Temperature Variation

1. The testing follows FCC KDB 971168 v02r01 Section 9.0.
2. The EUT was set up in the thermal chamber and connected with the system simulator.
3. With power OFF, the temperature was decreased to -30°C and the EUT was stabilized before testing. Power was applied and the maximum change in frequency was recorded within one minute.
4. With power OFF, the temperature was raised in 10°C steps up to 50°C . The EUT was stabilized at each step for at least half an hour. Power was applied and the maximum frequency change was recorded within one minute.

3.7.4 Test Procedures for Voltage Variation

1. The testing follows FCC KDB 971168 v02r01 Section 9.0.
2. The EUT was placed in a temperature chamber at $25\pm 5^{\circ}\text{C}$ and connected with the system simulator.
3. The power supply voltage to the EUT was varied from BEP to 115% of the nominal value measured at the input to the EUT.
4. The variation in frequency was measured for the worst case.

3.7.5 Test Setup

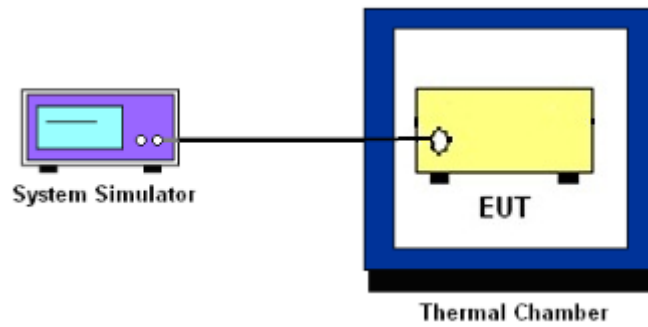



3.7.6 Test Result of Temperature Variation

Band :	GSM 850	Channel :	189
Limit (ppm) :	2.5	Frequency :	836.4 MHz

Temperature (°C)	GPRS class 8	EDGE class 8	Result
	Deviation (ppm)	Deviation (ppm)	
50	0.0048	0.0132	PASS
40	0.0036	0.0072	
30	0.0024	0.0012	
20(Ref.)	0.0000	0.0000	
10	0.0048	0.0048	
0	0.0084	0.0024	
-10	0.0024	0.0048	
-20	0.0048	0.0036	
-30	0.0000	0.0096	

Band :	GSM 1900	Channel :	661
Limit (ppm) :	within authorized band	Frequency :	1880.0 MHz

Temperature (°C)	GPRS class 8	EDGE class 8	Result
	Deviation (ppm)	Deviation (ppm)	
50	0.0181	0.0048	PASS
40	0.0170	0.0053	
30	0.0149	0.0011	
20(Ref.)	0.0000	0.0000	
10	0.0170	0.0027	
0	0.0154	0.0032	
-10	0.0176	0.0016	
-20	0.0186	0.0005	
-30	0.0181	0.0021	

Note: The frequency fundamental emissions stay within the authorized frequency block based on the frequency deviation measured is small.



Band :	WCDMA Band V	Channel :	4182
Limit (ppm) :	2.5	Frequency :	836.4 MHz

Temperature (°C)	RMC 12.2Kbps		Result
	Deviation (ppm)		
50	0.0132		PASS
40	0.0024		
30	0.0108		
20(Ref.)	0.0000		
10	0.0012		
0	0.0120		
-10	0.0012		
-20	0.0132		
-30	0.0036		

Band :	WCDMA Band IV	Channel :	1413
Limit (ppm) :	within authorized band	Frequency :	1732.6 MHz

Temperature (°C)	RMC 12.2Kbps		Result
	Deviation (ppm)		
50	0.0017		PASS
40	0.0023		
30	0.0012		
20(Ref.)	0.0000		
10	0.0006		
0	0.0012		
-10	0.0017		
-20	0.0029		
-30	0.0023		

Note: The frequency fundamental emissions stay within the authorized frequency block based on the frequency deviation measured is small.



Band :	WCDMA Band II	Channel :	9400
Limit (ppm) :	within authorized band	Frequency :	1880.0 MHz

Temperature (°C)	RMC 12.2Kbps	Result
	Deviation (ppm)	
50	0.0027	PASS
40	0.0021	
30	0.0011	
20(Ref.)	0.0000	
10	0.0005	
0	0.0011	
-10	0.0005	
-20	0.0021	
-30	0.0011	

Note: The frequency fundamental emissions stay within the authorized frequency block based on the frequency deviation measured is small.



3.7.7 Test Result of Voltage Variation

Band & Channel	Mode	Voltage (Volt)	Deviation (ppm)	Limit (ppm)	Result
GSM 850 CH189	GPRS class 8	240.00	0.0060	2.5	PASS
		120.00	0.0072		
		BEP	0.0048		
	EDGE class 8	240.00	0.0084		
		120.00	0.0108		
		BEP	0.0060		
GSM 1900 CH661	GPRS class 8	240.00	0.0170	(Note 3.)	
		120.00	0.0149		
		BEP	0.0165		
	EDGE class 8	240.00	0.0027		
		120.00	0.0011		
		BEP	0.0011		
WCDMA Band V CH4182	RMC 12.2Kbps	240.00	0.0000	2.5	
		120.00	0.0108		
		BEP	0.0012		
WCDMA Band IV CH1413	RMC 12.2Kbps	240.00	0.0012	(Note 3.)	
		120.00	0.0006		
		BEP	0.0017		
WCDMA Band II CH9400	RMC 12.2Kbps	240.00	0.0016	(Note 3.)	
		120.00	0.0005		
		BEP	0.0011		

Note:

1. Normal Voltage = 120.00V.
2. Battery End Point (BEP) = 100.00 V.
3. The frequency fundamental emissions stay within the authorized frequency block based on the frequency deviation measured is small.



4 List of Measuring Equipment

Instrument	Manufacturer	Model No.	Serial No.	Characteristics	Calibration Date	Test Date	Due Date	Remark
System Simulator	Rohde & Schwarz	CMU200	117995	N/A	Jul. 29, 2014	Sep. 30, 2014 ~ Oct. 02, 2014	Jul. 28, 2015	Conducted (TH02-HY)
Spectrum Analyzer	Rohde & Schwarz	FSP40	100055	9kHz~40GHz	Jun. 09, 2014	Sep. 30, 2014 ~ Oct. 02, 2014	Jun. 08, 2015	Conducted (TH02-HY)
Thermal Chamber	Ten Billion	TTH-D3SP	TBN-930701	N/A	Jul. 17, 2014	Sep. 30, 2014 ~ Oct. 02, 2014	Jul. 16, 2015	Conducted (TH02-HY)
Spectrum Analyzer	Rohde & Schwarz	FSV30	101749	10Hz ~ 30GHz	Feb. 10, 2014	Sep. 29, 2014~ Oct. 01, 2014	Feb. 09, 2015	Radiation (03CH07-HY)
Bilog Antenna	Schaffner	CBL6111C	2726	30MHz ~ 1GHz	Oct. 10, 2013	Sep. 29, 2014~ Oct. 01, 2014	Oct. 09, 2014	Radiation (03CH07-HY)
Double Ridge Horn Antenna	ESCO	3117	75962	1GHz~18GHz	Aug. 19, 2014	Sep. 29, 2014~ Oct. 01, 2014	Aug. 18, 2015	Radiation (03CH07-HY)
Preamplifier	COM-POWER	PA-103A	161241	10 MHz ~ 1000MHz	Mar. 17, 2014	Sep. 29, 2014~ Oct. 01, 2014	Mar. 16, 2015	Radiation (03CH07-HY)
Preamplifier	Agilent	8449B	3008A02362	1 GHz~26.5 GHz	Nov. 29, 2013	Sep. 29, 2014~ Oct. 01, 2014	Nov. 28, 2014	Radiation (03CH07-HY)
Turn Table	ChainTek	ChainTek 3000	N/A	0 ~ 360 degree	N/A	Sep. 29, 2014~ Oct. 01, 2014	N/A	Radiation (03CH07-HY)
Antenna Mast	ChainTek	M-400-0	114/8000604/L	N/A	N/A	Sep. 29, 2014~ Oct. 01, 2014	N/A	Radiation (03CH07-HY)
SHF-EHF Horn Antenna	SCHWARZBECK	BBHA 9170	BBHA9170251	18GHz~40GHz	Oct. 03, 2013	Sep. 29, 2014~ Oct. 01, 2014	Oct. 02, 2014	Radiation (03CH07-HY)



5 Uncertainty of Evaluation

Uncertainty of Radiated Emission Measurement (30 MHz ~ 1000 MHz)

Measuring Uncertainty for a Level of Confidence of 95% ($U = 2Uc(y)$)	4.50
---	------