

FCC Test Report

Report No.: RF150825C34

FCC ID: KA2WL8710APA1

Test Model: DWL-8710AP

Received Date: Aug. 25, 2015

Test Date: Sep. 25 ~ Oct. 29, 2015

Issued Date: Nov. 05, 2015

Applicant: D-Link Corporation

Address: No.289, Xinhu 3rd Rd., Neihu District, Taipei City 11494, Taiwan, R.O.C.

Issued By: Bureau Veritas Consumer Products Services (H.K.) Ltd., Taoyuan Branch

Lab Address: No. 47-2, 14th Ling, Chia Pau Vil., Lin Kou Dist., New Taipei City, Taiwan (R.O.C.)

Test Location: No.19, Hwa Ya 2nd Rd., Wen Hwa Vil., Kwei Shan Dist., Taoyuan City 33383, TAIWAN (R.O.C.)



This report is for your exclusive use. Any copying or replication of this report to or for any other person or entity, or use of our name or trademark, is permitted only with our prior written permission. This report sets forth our findings solely with respect to the test samples identified herein. The results set forth in this report are not indicative or representative of the quality or characteristics of the lot from which a test sample was taken or any similar or identical product specifically and expressly noted. Our report includes all of the tests requested by you and the results thereof based upon the information that you provided to us. You have 60 days from date of issuance of this report to notify us of any material error or omission caused by our negligence, provided, however, that such notice shall be in writing and shall specifically address the issue you wish to raise. A failure to raise such issue within the prescribed time shall constitute your unqualified acceptance of the completeness of this report, the tests conducted and the correctness of the report contents. Unless specific mention, the uncertainty of measurement has been explicitly taken into account to declare the compliance or non-compliance to the specification. The report must not be used by the client to claim product certification, approval, or endorsement by TAF or any government agencies.

Table of Contents

| | |
|--|-----------|
| Release Control Record | 4 |
| 1 Certificate of Conformity | 5 |
| 2 Summary of Test Results | 6 |
| 2.1 Measurement Uncertainty | 6 |
| 2.2 Modification Record | 6 |
| 3 General Information | 7 |
| 3.1 General Description of EUT | 7 |
| 3.2 Description of Test Modes | 8 |
| 3.2.1 Test Mode Applicability and Tested Channel Detail | 9 |
| 3.3 Duty Cycle of Test Signal | 11 |
| 3.4 Description of Support Units | 12 |
| 3.4.1 Configuration of System under Test | 12 |
| 3.5 General Description of Applied Standards | 13 |
| 4 Test Types and Results | 14 |
| 4.1 Radiated Emission and Bandedge Measurement..... | 14 |
| 4.1.1 Limits of Radiated Emission and Bandedge Measurement | 14 |
| 4.1.2 Test Instruments | 15 |
| 4.1.3 Test Procedures..... | 16 |
| 4.1.4 Deviation from Test Standard | 16 |
| 4.1.5 Test Set Up | 17 |
| 4.1.6 EUT Operating Conditions..... | 17 |
| 4.1.7 Test Results | 18 |
| 4.2 Conducted Emission Measurement | 31 |
| 4.2.1 Limits of Conducted Emission Measurement | 31 |
| 4.2.2 Test Instruments | 31 |
| 4.2.3 Test Procedures..... | 32 |
| 4.2.4 Deviation from Test Standard | 32 |
| 4.2.5 Test Setup..... | 32 |
| 4.2.6 EUT Operating Conditions..... | 32 |
| 4.2.7 Test Results | 33 |
| 4.3 6dB Bandwidth Measurement..... | 35 |
| 4.3.1 Limits of 6dB Bandwidth Measurement..... | 35 |
| 4.3.2 Test Setup..... | 35 |
| 4.3.3 Test Instruments | 35 |
| 4.3.4 Test Procedure | 35 |
| 4.3.5 Deviation from Test Standard | 35 |
| 4.3.6 EUT Operating Conditions..... | 35 |
| 4.3.7 Test Result..... | 36 |
| 4.4 Conducted Output Power Measurement..... | 38 |
| 4.4.1 Limits of Conducted Output Power Measurement | 38 |
| 4.4.2 Test Setup..... | 38 |
| 4.4.3 Test Instruments | 38 |
| 4.4.4 Test Procedures..... | 38 |
| 4.4.5 Deviation from Test Standard | 38 |
| 4.4.6 EUT Operating Conditions..... | 38 |
| 4.4.7 Test Results | 39 |
| 4.5 Power Spectral Density Measurement..... | 40 |
| 4.5.1 Limits of Power Spectral Density Measurement | 40 |
| 4.5.2 Test Setup..... | 40 |
| 4.5.3 Test Instruments | 40 |
| 4.5.4 Test Procedure | 40 |
| 4.5.5 Deviation from Test Standard | 40 |



| | |
|--|-----------|
| 4.5.6 EUT Operating Condition | 40 |
| 4.5.7 Test Results | 41 |
| 4.6 Conducted Out of Band Emission Measurement..... | 44 |
| 4.6.1 Limits of Conducted Out of Band Emission Measurement | 44 |
| 4.6.2 Test Setup..... | 44 |
| 4.6.3 Test Instruments | 44 |
| 4.6.4 Test Procedure | 44 |
| 4.6.5 Deviation from Test Standard | 44 |
| 4.6.6 EUT Operating Condition | 44 |
| 4.6.7 Test Results | 44 |
| 5 Pictures of Test Arrangements..... | 53 |
| Appendix – Information on the Testing Laboratories | 54 |



Release Control Record

| Issue No. | Description | Date Issued |
|-------------|-------------------|---------------|
| RF150825C34 | Original release. | Nov. 05, 2015 |

2 Summary of Test Results

| 47 CFR FCC Part 15, Subpart C (Section 15.247) | | | |
|--|--|--------|--|
| FCC Clause | Test Item | Result | Remarks |
| 15.207 | AC Power Conducted Emission | PASS | Meet the requirement of limit. Minimum passing margin is -2.53dB at 0.43116MHz. |
| 15.205 / 15.209 / 15.247(d) | Radiated Emissions and Band Edge Measurement | PASS | Meet the requirement of limit. Minimum passing margin is -1.2dB at 2390.00MHz. |
| 15.247(d) | Antenna Port Emission | PASS | Meet the requirement of limit. |
| 15.247(a)(2) | 6dB bandwidth | PASS | Meet the requirement of limit. |
| 15.247(b) | Conducted power | PASS | Meet the requirement of limit. |
| 15.247(e) | Power Spectral Density | PASS | Meet the requirement of limit. |
| 15.203 | Antenna Requirement | PASS | Antenna connector is N Plug. (The device is professionally installed) |

2.1 Measurement Uncertainty

Where relevant, the following measurement uncertainty levels have been estimated for tests performed on the EUT as specified in CISPR 16-4-2:

| Measurement | Frequency | Expanded Uncertainty (k=2) (±) |
|------------------------------------|------------------|--------------------------------|
| Conducted Emissions at mains ports | 150kHz ~ 30MHz | 2.44 dB |
| Radiated Emissions up to 1 GHz | 30MHz ~ 200MHz | 3.86 dB |
| | 200MHz ~ 1000MHz | 3.87 dB |
| Radiated Emissions above 1 GHz | 1GHz ~ 18GHz | 2.29 dB |
| | 18GHz ~ 40GHz | 2.29 dB |

2.2 Modification Record

There were no modifications required for compliance.

3 General Information

3.1 General Description of EUT

| | |
|-----------------------|---|
| Product | 802.11n/ac Unified Wireless Outdoor Access Point |
| Brand | D-Link |
| Test Model | DWL-8710AP |
| Sample Status | Engineering sample |
| Power Supply Rating | 54Vdc (POE) |
| Modulation Type | CCK, DQPSK, DBPSK for DSSS 64QAM, 16QAM, QPSK, BPSK for OFDM |
| Modulation Technology | DSSS, OFDM |
| Transfer Rate | 802.11b: 11/5.5/2/1Mbps 802.11g: 54/48/36/24/18/12/9/6Mbps 802.11n: up to 300Mbps |
| Operating Frequency | 2412 ~ 2462MHz |
| Number of Channel | 11 for 802.11b, 802.11g, 802.11n (HT20) 7 for 802.11n (HT40) |
| Output Power | 746.74mW |
| Antenna Type | Dipole antenna with 4.92dBi gain |
| Antenna Connector | N Plug (The device is professionally installed) |
| Accessory Device | POE, POE's adapter |
| Cable Supplied | 1.75m non-shielded ground cable |

Note:

1. The EUT incorporates a MIMO function. Physically, the EUT provides 2 completed transmitters and 2 receivers.

| Modulation Mode | TX Function |
|-----------------|-------------|
| 802.11b | 2TX |
| 802.11g | 2TX |
| 802.11n (HT20) | 2TX |
| 802.11n (HT40) | 2TX |

2. The EUT uses following POE.

| POE | |
|---------------|---|
| Brand | D-Link |
| Model | DPE-301GI |
| Rating | 54Vdc, 0.6A |
| POE's adapter | |
| Brand | Gospell Digital Technology Co., Ltd. |
| Model | G0753-540-060 |
| Input Power | 100-240Vac, 0.75A MAX, 50/60Hz |
| Output Power | 54Vdc, 0.6A |
| Power Line | 1.45m DC cable without core attached on adapter |

3.2 Description of Test Modes

11 channels are provided for 802.11b, 802.11g and 802.11n (HT20):

| Channel | Frequency | Channel | Frequency |
|---------|-----------|---------|-----------|
| 1 | 2412MHz | 7 | 2442MHz |
| 2 | 2417MHz | 8 | 2447MHz |
| 3 | 2422MHz | 9 | 2452MHz |
| 4 | 2427MHz | 10 | 2457MHz |
| 5 | 2432MHz | 11 | 2462MHz |
| 6 | 2437MHz | | |

7 channels are provided for 802.11n (HT40):

| Channel | Frequency | Channel | Frequency |
|---------|-----------|---------|-----------|
| 3 | 2422MHz | 7 | 2442MHz |
| 4 | 2427MHz | 8 | 2447MHz |
| 5 | 2432MHz | 9 | 2452MHz |
| 6 | 2437MHz | | |

3.2.1 Test Mode Applicability and Tested Channel Detail

| EUT Configure Mode | Applicable to | | | | Description |
|--------------------|---------------|-------|-----|------|-------------|
| | RE \geq 1G | RE<1G | PLC | APCM | |
| - | √ | √ | √ | √ | - |

Where RE \geq 1G: Radiated Emission above 1GHz & Bandedge Measurement
 RE<1G: Radiated Emission below 1GHz
 PLC: Power Line Conducted Emission
 APCM: Antenna Port Conducted Measurement

Note: The EUT had been pre-tested on the positioned of each 3 axis. The worst case was found when positioned on **Z-plane**.

Radiated Emission Test (Above 1GHz):

- Pre-Scan has been conducted to determine the worst-case mode from all possible combinations between available modulations, data rates and antenna ports (if EUT with antenna diversity architecture).
- Following channel(s) was (were) selected for the final test as listed below.

| EUT Configure Mode | Mode | Available Channel | Tested Channel | Modulation Technology | Modulation Type | Date Rate (Mbps) |
|--------------------|----------------|-------------------|----------------|-----------------------|-----------------|------------------|
| - | 802.11b | 1 to 11 | 1, 6, 11 | DSSS | DBPSK | 1.0 |
| - | 802.11g | 1 to 11 | 1, 6, 11 | OFDM | BPSK | 6.0 |
| - | 802.11n (HT20) | 1 to 11 | 1, 6, 11 | OFDM | BPSK | 7.2 |
| - | 802.11n (HT40) | 3 to 9 | 3, 6, 9 | OFDM | BPSK | 15.0 |

Radiated Emission Test (Below 1GHz):

- Pre-Scan has been conducted to determine the worst-case mode from all possible combinations between available modulations, data rates and antenna ports (if EUT with antenna diversity architecture).
- Following channel(s) was (were) selected for the final test as listed below.

| EUT Configure Mode | Mode | Available Channel | Tested Channel | Modulation Technology | Modulation Type | Date Rate (Mbps) |
|--------------------|---------|-------------------|----------------|-----------------------|-----------------|------------------|
| - | 802.11b | 1 to 11 | 1 | DSSS | DBPSK | 1.0 |

Power Line Conducted Emission Test:

- Pre-Scan has been conducted to determine the worst-case mode from all possible combinations between available modulations, data rates and antenna ports (if EUT with antenna diversity architecture).
- Following channel(s) was (were) selected for the final test as listed below.

| EUT Configure Mode | Mode | Available Channel | Tested Channel | Modulation Technology | Modulation Type | Date Rate (Mbps) |
|--------------------|---------|-------------------|----------------|-----------------------|-----------------|------------------|
| - | 802.11b | 1 to 11 | 1 | DSSS | DBPSK | 1.0 |

Antenna Port Conducted Measurement:

- This item includes all test value of each mode, but only includes spectrum plot of worst value of each mode.
- Pre-Scan has been conducted to determine the worst-case mode from all possible combinations between available modulations, data rates and antenna ports (if EUT with antenna diversity architecture).
- Following channel(s) was (were) selected for the final test as listed below.

| EUT Configure Mode | Mode | Available Channel | Tested Channel | Modulation Technology | Modulation Type | Date Rate (Mbps) |
|--------------------|----------------|-------------------|----------------|-----------------------|-----------------|------------------|
| - | 802.11b | 1 to 11 | 1, 6, 11 | DSSS | DBPSK | 1.0 |
| - | 802.11g | 1 to 11 | 1, 6, 11 | OFDM | BPSK | 6.0 |
| - | 802.11n (HT20) | 1 to 11 | 1, 6, 11 | OFDM | BPSK | 7.2 |
| - | 802.11n (HT40) | 3 to 9 | 3, 6, 9 | OFDM | BPSK | 15.0 |

Test Condition:

| Applicable to | Environmental Conditions | Input Power | Tested by |
|---------------|--------------------------|--------------|-------------|
| RE \geq 1G | 23 deg. C, 65% RH | 120Vac, 60Hz | Jones Chang |
| RE $<$ 1G | 18 deg. C, 70% RH | 120Vac, 60Hz | Nick Hsu |
| PLC | 18 deg. C, 70% RH | 120Vac, 60Hz | Nick Hsu |
| APCM | 25 deg. C, 60% RH | 120Vac, 60Hz | Ted Chang |

3.3 Duty Cycle of Test Signal

802.11b, 802.11n (HT20): Duty cycle of test signal is $\geq 98\%$, duty factor is not required.

802.11g, 802.11n (HT40): Duty cycle of test signal is $< 98\%$, duty factor shall be considered.

802.11b: Duty cycle = 100%

802.11g: Duty cycle = $2.052/2.1 = 0.977$, Duty factor = $10 * \log(1/0.977) = 0.10$

802.11n (HT20): Duty cycle = $1.912/1.949 = 0.981$

802.11n (HT40): Duty cycle = $0.929/0.972 = 0.956$, Duty factor = $10 * \log(1/0.956) = 0.20$

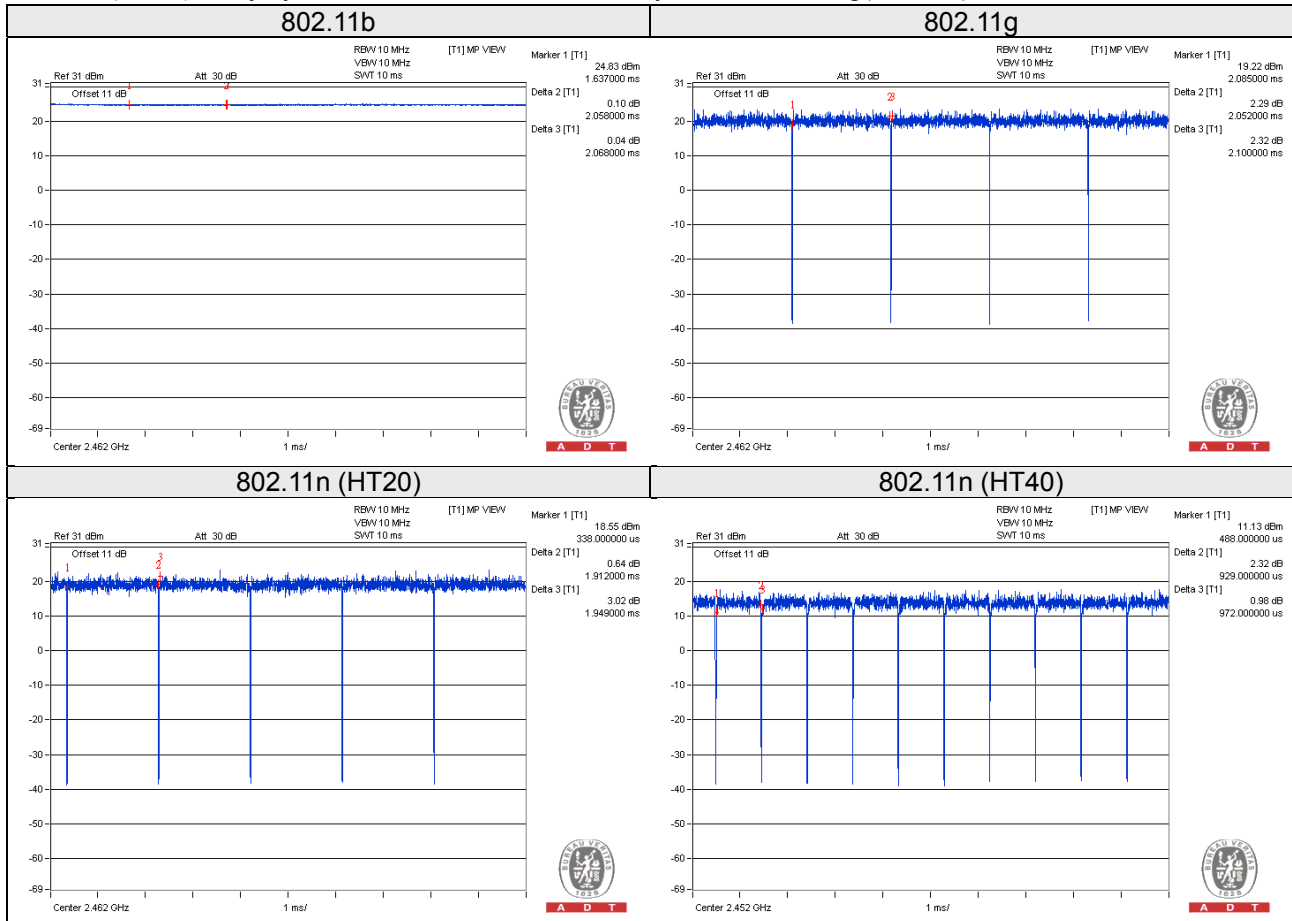

3.4 Description of Support Units

The EUT has been tested as an independent unit together with other necessary accessories or support units. The following support units or accessories were used to form a representative test configuration during the tests.

| ID | Product | Brand | Model No. | Serial No. | FCC ID | Remarks |
|----|----------|-------|-----------|------------|------------------|---------|
| A. | Load | NA | NA | NA | NA | - |
| B. | Notebook | DELL | E5410 | 1HC2XM1 | FCC DoC Approved | - |

Note:

1. All power cords of the above support units are non-shielded (1.8m).
2. Item B acted as a communication partner to transfer data.

| ID | Descriptions | Qty. | Length (m) | Shielding (Yes/No) | Cores (Qty.) | Remarks |
|----|--------------|------|------------|--------------------|--------------|------------------|
| 1. | RJ45 | 1 | 1.8 | N | 0 | - |
| 2. | RJ45 | 1 | 1.8 | N | 0 | - |
| 3. | RJ45 | 1 | 5 | N | 0 | - |
| 4. | Ground | 1 | 1.75 | N | 0 | Accessory of EUT |

3.4.1 Configuration of System under Test

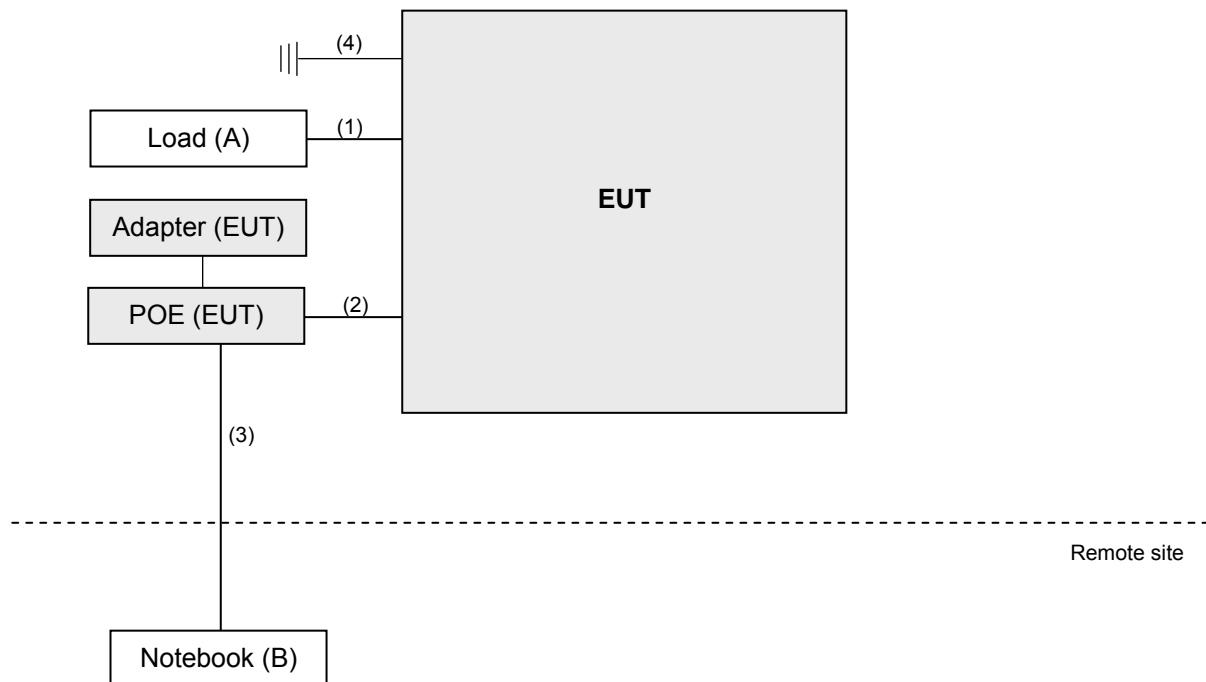

3.5 General Description of Applied Standards

The EUT is a RF Product. According to the specification of the EUT declared by the manufacturer, it must comply with the requirements of the following standards:

FCC Part 15, Subpart C (15.247)

558074 D01 DTS Meas Guidance v03r03

662911 D01 Multiple Transmitter Output v02r01

ANSI C63.10-2013

All test items have been performed and recorded as per the above standards.

NOTE: The EUT has been verified to comply with the requirements of FCC Part 15, Subpart B, Class B (DoC).
The test report has been issued separately.

4 Test Types and Results

4.1 Radiated Emission and Bandedge Measurement

4.1.1 Limits of Radiated Emission and Bandedge Measurement

Radiated emissions which fall in the restricted bands must comply with the radiated emission limits specified as below table. Other emissions shall be at least 30dB below the highest level of the desired power:

| Frequencies (MHz) | Field Strength (microvolts/meter) | Measurement Distance (meters) |
|-------------------|-----------------------------------|-------------------------------|
| 0.009 ~ 0.490 | 2400/F(kHz) | 300 |
| 0.490 ~ 1.705 | 24000/F(kHz) | 30 |
| 1.705 ~ 30.0 | 30 | 30 |
| 30 ~ 88 | 100 | 3 |
| 88 ~ 216 | 150 | 3 |
| 216 ~ 960 | 200 | 3 |
| Above 960 | 500 | 3 |

NOTE:

1. The lower limit shall apply at the transition frequencies.
2. Emission level (dBuV/m) = 20 log Emission level (uV/m).
3. For frequencies above 1000MHz, the field strength limits are based on average detector, however, the peak field strength of any emission shall not exceed the maximum permitted average limits, specified above by more than 30dB under any condition of modulation.



4.1.2 Test Instruments

| Description & Manufacturer | Model No. | Serial No. | Cal. Date | Cal. Due |
|--------------------------------------|------------------------------|--------------------------------|---------------|---------------|
| Test Receiver ROHDE & SCHWARZ | ESIB7 | 100187 | Apr. 10, 2015 | Apr. 09, 2016 |
| Spectrum Analyzer ROHDE & SCHWARZ | FSP40 | 100040 | Jul. 08, 2015 | Jul. 07, 2016 |
| BILOG Antenna SCHWARZBECK | VULB9168 | 9168-160 | Feb. 05, 2015 | Feb. 04, 2016 |
| HORN Antenna SCHWARZBECK | 9120D | 209 | Feb. 09, 2015 | Feb. 08, 2016 |
| HORN Antenna SCHWARZBECK | BBHA 9170 | BBHA9170241 | Feb. 09, 2015 | Feb. 08, 2016 |
| Loop Antenna R&S | HFH2-Z2 | 100070 | Mar. 06, 2014 | Mar. 05, 2016 |
| Preamplifier Agilent | 8447D | 2944A10738 | Oct.18, 2014 | Oct. 17, 2015 |
| | | | Oct.18, 2015 | Oct. 17, 2016 |
| Preamplifier Agilent | 8449B | 3008A01964 | Aug. 22, 2015 | Aug. 21, 2016 |
| RF signal cable HUBER+SUHNER | SUCOFLEX 104 | Cable-CH3-03 (214378) | Aug. 22, 2015 | Aug. 21, 2016 |
| RF signal cable HUBER+SUHNER | SUCOFLEX 106 | Cable-CH3-03 (309224+12738) | Aug. 22, 2015 | Aug. 21, 2016 |
| Software BV ADT | ADT_Radiated_ V7.6.15.9.4 | NA | NA | NA |
| Antenna Tower inn-co GmbH | MA 4000 | 013303 | NA | NA |
| Antenna Tower Controller BV ADT | AT100 | AT93021702 | NA | NA |
| Turn Table BV ADT | TT100 | TT93021702 | NA | NA |
| Turn Table Controller BV ADT | SC100 | SC93021702 | NA | NA |
| High Speed Peak Power Meter | ML2495A | 0824011 | Jul. 09, 2015 | Jul. 08, 2016 |
| Power Sensor | MA2411B | 0738171 | Jul. 09, 2015 | Jul. 08, 2016 |

- Note:
1. The calibration interval of the above test instruments is 12 months and the calibrations are traceable to NML/ROC and NIST/USA.
 2. The calibration interval of the loop antenna is 24 months and the calibrations are traceable to NML/ROC and NIST/USA.
 2. The test was performed in HwaYa Chamber 3.
 3. The horn antenna and preamplifier (model: 8449B) are used only for the measurement of emission frequency above 1GHz if tested.
 4. The FCC Site Registration No. is 988962.
 5. The IC Site Registration No. is IC 7450F-3.

4.1.3 Test Procedures

- a. The EUT was placed on the top of a rotating table 0.8 meters (for below 1GHz) / 1.5 meters (for above 1GHz) above the ground at 3 meter chamber room for test. The table was rotated 360 degrees to determine the position of the highest radiation.
- b. The EUT was set 3 meters away from the interference-receiving antenna, which was mounted on the top of a variable-height antenna tower.
- c. The height of antenna is varied from one meter to four meters above the ground to determine the maximum value of the field strength. Both horizontal and vertical polarizations of the antenna are set to make the measurement.
- d. For each suspected emission, the EUT was arranged to its worst case and then the antenna was tuned to heights from 1 meter to 4 meters and the rotatable table was turned from 0 degrees to 360 degrees to find the maximum reading.
- e. The test-receiver system was set to quasi-peak detect function and specified bandwidth with maximum hold mode when the test frequency is below 1 GHz.
- f. The test-receiver system was set to peak and average detect function and specified bandwidth with maximum hold mode when the test frequency is above 1 GHz. If the peak reading value also meets average limit, measurement with the average detector is unnecessary.

Note:

1. The resolution bandwidth and video bandwidth of test receiver/spectrum analyzer is 120kHz for Quasi-peak detection (QP) at frequency below 1GHz.
2. The resolution bandwidth of test receiver/spectrum analyzer is 1 MHz and the video bandwidth is 3 MHz for Peak detection (PK) at frequency above 1GHz.
3. The resolution bandwidth of test receiver/spectrum analyzer is 1MHz and the video bandwidth is 3MHz for RMS Average (Duty cycle < 98%) for Average detection (AV) at frequency above 1GHz, then the measurement results was added to a correction factor ($10 \log(1/\text{duty cycle})$).
4. The resolution bandwidth of test receiver/spectrum analyzer is 1MHz and the video bandwidth is 10Hz (Duty cycle $\geq 98\%$) for Average detection (AV) at frequency above 1GHz.
5. All modes of operation were investigated and the worst-case emissions are reported.

4.1.4 Deviation from Test Standard

No deviation.

4.1.5 Test Set Up

<Frequency Range 30MHz~1GHz>

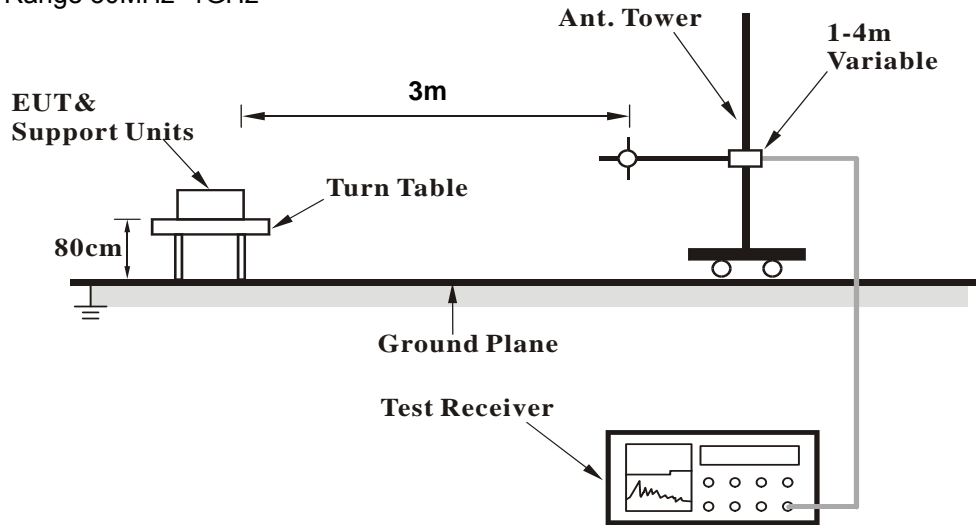

<Frequency Range above 1GHz>

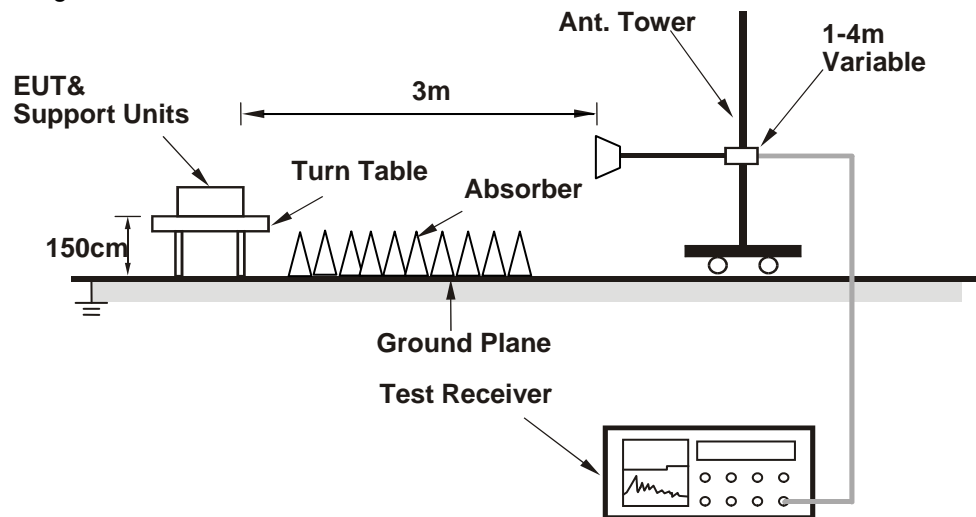

For the actual test configuration, please refer to the attached file (Test Setup Photo).

4.1.6 EUT Operating Conditions

- a. Placed the EUT on the testing table.
- b. Prepared a notebook to act as a communication partner and placed it outside of testing area.
- c. The communication partner connected with EUT via a RJ45 cable and ran a test program (provided by manufacturer) to enable EUT under transmission condition continuously at specific channel frequency.
- d. The communication partner sent data to EUT by command "PING".
- e. The necessary accessories enable the system in full functions.

4.1.7 Test Results

Above 1GHz Data :

802.11b

| | | | |
|-----------------|--------------|----------------------|--------------|
| CHANNEL | TX Channel 1 | DETECTOR FUNCTION | Peak (PK) |
| FREQUENCY RANGE | 1GHz ~ 25GHz | | Average (AV) |

ANTENNA POLARITY & TEST DISTANCE: HORIZONTAL AT 3 M

| NO. | FREQ. (MHz) | EMISSION LEVEL (dBuV/m) | LIMIT (dBuV/m) | MARGIN (dB) | ANTENNA HEIGHT (m) | TABLE ANGLE (Degree) | RAW VALUE (dBuV) | CORRECTION FACTOR (dB/m) |
|-----|-------------|-------------------------|----------------|-------------|--------------------|----------------------|------------------|--------------------------|
| 1 | 2390.00 | 57.0 PK | 74.0 | -17.0 | 1.00 H | 218 | 24.50 | 32.50 |
| 2 | 2390.00 | 45.1 AV | 54.0 | -8.9 | 1.00 H | 218 | 12.60 | 32.50 |
| 3 | *2412.00 | 108.7 PK | | | 1.00 H | 134 | 76.10 | 32.60 |
| 4 | *2412.00 | 105.0 AV | | | 1.00 H | 134 | 72.40 | 32.60 |
| 5 | 2492.00 | 58.3 PK | 74.0 | -15.7 | 1.00 H | 120 | 25.60 | 32.70 |
| 6 | 2492.00 | 46.6 AV | 54.0 | -7.4 | 1.00 H | 120 | 13.90 | 32.70 |
| 7 | 4824.00 | 49.6 PK | 74.0 | -24.4 | 1.30 H | 156 | 43.50 | 6.10 |
| 8 | 4824.00 | 36.6 AV | 54.0 | -17.4 | 1.30 H | 156 | 30.50 | 6.10 |

ANTENNA POLARITY & TEST DISTANCE: VERTICAL AT 3 M

| NO. | FREQ. (MHz) | EMISSION LEVEL (dBuV/m) | LIMIT (dBuV/m) | MARGIN (dB) | ANTENNA HEIGHT (m) | TABLE ANGLE (Degree) | RAW VALUE (dBuV) | CORRECTION FACTOR (dB/m) |
|-----|-------------|-------------------------|----------------|-------------|--------------------|----------------------|------------------|--------------------------|
| 1 | 2387.00 | 62.7 PK | 74.0 | -11.3 | 1.71 V | 347 | 30.20 | 32.50 |
| 2 | 2387.00 | 52.1 AV | 54.0 | -1.9 | 1.71 V | 347 | 19.60 | 32.50 |
| 3 | *2412.00 | 120.5 PK | | | 1.86 V | 3 | 87.90 | 32.60 |
| 4 | *2412.00 | 116.6 AV | | | 1.86 V | 3 | 84.00 | 32.60 |
| 5 | 2492.00 | 61.7 PK | 74.0 | -12.3 | 1.76 V | 358 | 29.00 | 32.70 |
| 6 | 2492.00 | 51.6 AV | 54.0 | -2.4 | 1.76 V | 358 | 18.90 | 32.70 |
| 7 | 4824.00 | 48.9 PK | 74.0 | -25.1 | 1.60 V | 123 | 42.80 | 6.10 |
| 8 | 4824.00 | 36.7 AV | 54.0 | -17.3 | 1.60 V | 123 | 30.60 | 6.10 |

REMARKS:

1. Emission Level(dBuV/m) = Raw Value(dBuV) + Correction Factor(dB/m)
2. Correction Factor(dB/m) = Antenna Factor(dB/m) + Cable Factor(dB)
3. The other emission levels were very low against the limit.
4. Margin value = Emission Level – Limit value
5. " * ": Fundamental frequency.



| | | | |
|-----------------|--------------|----------------------|--------------|
| CHANNEL | TX Channel 6 | DETECTOR FUNCTION | Peak (PK) |
| FREQUENCY RANGE | 1GHz ~ 25GHz | | Average (AV) |

ANTENNA POLARITY & TEST DISTANCE: HORIZONTAL AT 3 M

| NO. | FREQ. (MHz) | EMISSION LEVEL (dBuV/m) | LIMIT (dBuV/m) | MARGIN (dB) | ANTENNA HEIGHT (m) | TABLE ANGLE (Degree) | RAW VALUE (dBuV) | CORRECTION FACTOR (dB/m) |
|-----|-------------|-------------------------------|-------------------|----------------|--------------------------|----------------------------|------------------------|--------------------------------|
| 1 | *2437.00 | 111.4 PK | | | 1.52 H | 124 | 78.70 | 32.70 |
| 2 | *2437.00 | 107.8 AV | | | 1.52 H | 124 | 75.10 | 32.70 |
| 3 | 2483.50 | 56.3 PK | 74.0 | -17.7 | 1.50 H | 134 | 23.60 | 32.70 |
| 4 | 2483.50 | 45.8 AV | 54.0 | -8.2 | 1.50 H | 134 | 13.10 | 32.70 |
| 5 | 4874.00 | 50.1 PK | 74.0 | -23.9 | 1.49 H | 225 | 43.90 | 6.20 |
| 6 | 4874.00 | 37.0 AV | 54.0 | -17.0 | 1.49 H | 225 | 30.80 | 6.20 |
| 7 | 7311.00 | 50.2 PK | 74.0 | -23.8 | 1.23 H | 297 | 37.60 | 12.60 |
| 8 | 7311.00 | 43.4 AV | 54.0 | -10.6 | 1.23 H | 297 | 30.80 | 12.60 |

ANTENNA POLARITY & TEST DISTANCE: VERTICAL AT 3 M

| NO. | FREQ. (MHz) | EMISSION LEVEL (dBuV/m) | LIMIT (dBuV/m) | MARGIN (dB) | ANTENNA HEIGHT (m) | TABLE ANGLE (Degree) | RAW VALUE (dBuV) | CORRECTION FACTOR (dB/m) |
|-----|-------------|-------------------------------|-------------------|----------------|--------------------------|----------------------------|------------------------|--------------------------------|
| 1 | *2437.00 | 122.0 PK | | | 1.83 V | 357 | 89.30 | 32.70 |
| 2 | *2437.00 | 118.1 AV | | | 1.83 V | 357 | 85.40 | 32.70 |
| 3 | 2483.50 | 63.4 PK | 74.0 | -10.6 | 1.79 V | 4 | 30.70 | 32.70 |
| 4 | 2483.50 | 52.1 AV | 54.0 | -1.9 | 1.79 V | 4 | 19.40 | 32.70 |
| 5 | 4874.00 | 52.0 PK | 74.0 | -22.0 | 1.80 V | 72 | 45.80 | 6.20 |
| 6 | 4874.00 | 38.9 AV | 54.0 | -15.1 | 1.80 V | 72 | 32.70 | 6.20 |
| 7 | 7311.00 | 62.6 PK | 74.0 | -11.4 | 1.66 V | 348 | 50.00 | 12.60 |
| 8 | 7311.00 | 51.1 AV | 54.0 | -2.9 | 1.66 V | 348 | 38.50 | 12.60 |

REMARKS:

1. Emission Level(dBuV/m) = Raw Value(dBuV) + Correction Factor(dB/m)
2. Correction Factor(dB/m) = Antenna Factor(dB/m) + Cable Factor(dB)
3. The other emission levels were very low against the limit.
4. Margin value = Emission Level – Limit value
5. " * ": Fundamental frequency.



| | | | |
|-----------------|---------------|----------------------|--------------|
| CHANNEL | TX Channel 11 | DETECTOR FUNCTION | Peak (PK) |
| FREQUENCY RANGE | 1GHz ~ 25GHz | | Average (AV) |

ANTENNA POLARITY & TEST DISTANCE: HORIZONTAL AT 3 M

| NO. | FREQ. (MHz) | EMISSION LEVEL (dBuV/m) | LIMIT (dBuV/m) | MARGIN (dB) | ANTENNA HEIGHT (m) | TABLE ANGLE (Degree) | RAW VALUE (dBuV) | CORRECTION FACTOR (dB/m) |
|-----|-------------|-------------------------------|-------------------|----------------|--------------------------|----------------------------|------------------------|--------------------------------|
| 1 | *2462.00 | 106.9 PK | | | 1.50 H | 128 | 74.30 | 32.60 |
| 2 | *2462.00 | 103.1 AV | | | 1.50 H | 128 | 70.50 | 32.60 |
| 3 | 2483.50 | 57.3 PK | 74.0 | -16.7 | 1.50 H | 128 | 24.60 | 32.70 |
| 4 | 2483.50 | 45.7 AV | 54.0 | -8.3 | 1.50 H | 128 | 13.00 | 32.70 |
| 5 | 4924.00 | 48.7 PK | 74.0 | -25.3 | 1.39 H | 197 | 42.40 | 6.30 |
| 6 | 4924.00 | 35.7 AV | 54.0 | -18.3 | 1.39 H | 197 | 29.40 | 6.30 |

ANTENNA POLARITY & TEST DISTANCE: VERTICAL AT 3 M

| NO. | FREQ. (MHz) | EMISSION LEVEL (dBuV/m) | LIMIT (dBuV/m) | MARGIN (dB) | ANTENNA HEIGHT (m) | TABLE ANGLE (Degree) | RAW VALUE (dBuV) | CORRECTION FACTOR (dB/m) |
|-----|-------------|-------------------------------|-------------------|----------------|--------------------------|----------------------------|------------------------|--------------------------------|
| 1 | *2462.00 | 118.9 PK | | | 1.82 V | 359 | 86.30 | 32.60 |
| 2 | *2462.00 | 115.3 AV | | | 1.82 V | 359 | 82.70 | 32.60 |
| 3 | 2483.50 | 63.0 PK | 74.0 | -11.0 | 1.80 V | 355 | 30.30 | 32.70 |
| 4 | 2483.50 | 52.7 AV | 54.0 | -1.3 | 1.80 V | 355 | 20.00 | 32.70 |
| 5 | 4924.00 | 49.0 PK | 74.0 | -25.0 | 1.62 V | 229 | 42.70 | 6.30 |
| 6 | 4924.00 | 35.9 AV | 54.0 | -18.1 | 1.62 V | 229 | 29.60 | 6.30 |

REMARKS:

1. Emission Level(dBuV/m) = Raw Value(dBuV) + Correction Factor(dB/m)
2. Correction Factor(dB/m) = Antenna Factor(dB/m) + Cable Factor(dB)
3. The other emission levels were very low against the limit.
4. Margin value = Emission Level – Limit value
5. " * ": Fundamental frequency.

802.11g

| | | | |
|-----------------|--------------|----------------------|--------------|
| CHANNEL | TX Channel 1 | DETECTOR FUNCTION | Peak (PK) |
| FREQUENCY RANGE | 1GHz ~ 25GHz | | Average (AV) |

| ANTENNA POLARITY & TEST DISTANCE: HORIZONTAL AT 3 M | | | | | | | | |
|---|-------------|-------------------------|----------------|-------------|--------------------|----------------------|------------------|--------------------------|
| NO. | FREQ. (MHz) | EMISSION LEVEL (dBuV/m) | LIMIT (dBuV/m) | MARGIN (dB) | ANTENNA HEIGHT (m) | TABLE ANGLE (Degree) | RAW VALUE (dBuV) | CORRECTION FACTOR (dB/m) |
| 1 | 2390.00 | 68.0 PK | 74.0 | -6.0 | 1.42 H | 118 | 35.50 | 32.50 |
| 2 | 2390.00 | 50.9 AV | 54.0 | -3.1 | 1.42 H | 118 | 18.40 | 32.50 |
| 3 | *2412.00 | 101.2 PK | | | 1.43 H | 119 | 68.60 | 32.60 |
| 4 | *2412.00 | 91.5 AV | | | 1.43 H | 119 | 58.90 | 32.60 |
| 5 | 4824.00 | 50.2 PK | 74.0 | -23.8 | 1.21 H | 248 | 44.10 | 6.10 |
| 6 | 4824.00 | 37.6 AV | 54.0 | -16.4 | 1.21 H | 248 | 31.50 | 6.10 |

| ANTENNA POLARITY & TEST DISTANCE: VERTICAL AT 3 M | | | | | | | | |
|---|-------------|-------------------------|----------------|-------------|--------------------|----------------------|------------------|--------------------------|
| NO. | FREQ. (MHz) | EMISSION LEVEL (dBuV/m) | LIMIT (dBuV/m) | MARGIN (dB) | ANTENNA HEIGHT (m) | TABLE ANGLE (Degree) | RAW VALUE (dBuV) | CORRECTION FACTOR (dB/m) |
| 1 | 2390.00 | 72.1 PK | 74.0 | -1.9 | 1.64 V | 141 | 39.60 | 32.50 |
| 2 | 2390.00 | 52.3 AV | 54.0 | -1.7 | 1.64 V | 141 | 19.80 | 32.50 |
| 3 | *2412.00 | 115.7 PK | | | 1.73 V | 321 | 83.10 | 32.60 |
| 4 | *2412.00 | 106.3 AV | | | 1.73 V | 321 | 73.70 | 32.60 |
| 5 | 4824.00 | 49.6 PK | 74.0 | -24.4 | 1.60 V | 38 | 43.50 | 6.10 |
| 6 | 4824.00 | 36.9 AV | 54.0 | -17.1 | 1.60 V | 38 | 30.80 | 6.10 |

REMARKS:

1. Emission Level(dBuV/m) = Raw Value(dBuV) + Correction Factor(dB/m)
2. Correction Factor(dB/m) = Antenna Factor(dB/m) + Cable Factor(dB)
3. The other emission levels were very low against the limit.
4. Margin value = Emission Level – Limit value
5. " * ": Fundamental frequency.

| | | | |
|-----------------|--------------|----------------------|--------------|
| CHANNEL | TX Channel 6 | DETECTOR FUNCTION | Peak (PK) |
| FREQUENCY RANGE | 1GHz ~ 25GHz | | Average (AV) |

ANTENNA POLARITY & TEST DISTANCE: HORIZONTAL AT 3 M

| NO. | FREQ. (MHz) | EMISSION LEVEL (dBuV/m) | LIMIT (dBuV/m) | MARGIN (dB) | ANTENNA HEIGHT (m) | TABLE ANGLE (Degree) | RAW VALUE (dBuV) | CORRECTION FACTOR (dB/m) |
|-----|-------------|-------------------------------|-------------------|----------------|--------------------------|----------------------------|------------------------|--------------------------------|
| 1 | 2390.00 | 59.2 PK | 74.0 | -14.8 | 1.26 H | 222 | 26.70 | 32.50 |
| 2 | 2390.00 | 46.0 AV | 54.0 | -8.0 | 1.26 H | 222 | 13.50 | 32.50 |
| 3 | *2437.00 | 109.5 PK | | | 2.11 H | 207 | 76.80 | 32.70 |
| 4 | *2437.00 | 100.1 AV | | | 2.11 H | 207 | 67.40 | 32.70 |
| 5 | 2483.50 | 58.1 PK | 74.0 | -15.9 | 1.22 H | 353 | 25.40 | 32.70 |
| 6 | 2483.50 | 45.3 AV | 54.0 | -8.7 | 1.22 H | 353 | 12.60 | 32.70 |
| 7 | 4874.00 | 51.2 PK | 74.0 | -22.8 | 1.41 H | 149 | 45.00 | 6.20 |
| 8 | 4874.00 | 38.8 AV | 54.0 | -15.2 | 1.41 H | 149 | 32.60 | 6.20 |

ANTENNA POLARITY & TEST DISTANCE: VERTICAL AT 3 M

| NO. | FREQ. (MHz) | EMISSION LEVEL (dBuV/m) | LIMIT (dBuV/m) | MARGIN (dB) | ANTENNA HEIGHT (m) | TABLE ANGLE (Degree) | RAW VALUE (dBuV) | CORRECTION FACTOR (dB/m) |
|-----|-------------|-------------------------------|-------------------|----------------|--------------------------|----------------------------|------------------------|--------------------------------|
| 1 | 2390.00 | 68.0 PK | 74.0 | -6.0 | 1.84 V | 28 | 35.50 | 32.50 |
| 2 | 2390.00 | 50.2 AV | 54.0 | -3.8 | 1.84 V | 28 | 17.70 | 32.50 |
| 3 | *2437.00 | 124.0 PK | | | 1.83 V | 324 | 91.30 | 32.70 |
| 4 | *2437.00 | 113.9 AV | | | 1.83 V | 324 | 81.20 | 32.70 |
| 5 | 2483.50 | 67.7 PK | 74.0 | -6.3 | 1.60 V | 19 | 35.00 | 32.70 |
| 6 | 2483.50 | 52.7 AV | 54.0 | -1.3 | 1.60 V | 19 | 20.00 | 32.70 |
| 7 | 4874.00 | 52.2 PK | 74.0 | -21.8 | 1.59 V | 203 | 46.00 | 6.20 |
| 8 | 4874.00 | 39.2 AV | 54.0 | -14.8 | 1.59 V | 203 | 33.00 | 6.20 |

REMARKS:

1. Emission Level(dBuV/m) = Raw Value(dBuV) + Correction Factor(dB/m)
2. Correction Factor(dB/m) = Antenna Factor(dB/m) + Cable Factor(dB)
3. The other emission levels were very low against the limit.
4. Margin value = Emission Level – Limit value
5. " * ": Fundamental frequency.

| | | | |
|-----------------|---------------|----------------------|--------------|
| CHANNEL | TX Channel 11 | DETECTOR FUNCTION | Peak (PK) |
| FREQUENCY RANGE | 1GHz ~ 25GHz | | Average (AV) |

ANTENNA POLARITY & TEST DISTANCE: HORIZONTAL AT 3 M

| NO. | FREQ. (MHz) | EMISSION LEVEL (dBuV/m) | LIMIT (dBuV/m) | MARGIN (dB) | ANTENNA HEIGHT (m) | TABLE ANGLE (Degree) | RAW VALUE (dBuV) | CORRECTION FACTOR (dB/m) |
|-----|-------------|-------------------------|----------------|-------------|--------------------|----------------------|------------------|--------------------------|
| 1 | *2462.00 | 104.4 PK | | | 1.54 H | 104 | 71.80 | 32.60 |
| 2 | *2462.00 | 94.8 AV | | | 1.54 H | 104 | 62.20 | 32.60 |
| 3 | 2483.50 | 63.7 PK | 74.0 | -10.3 | 1.52 H | 107 | 31.00 | 32.70 |
| 4 | 2483.50 | 48.6 AV | 54.0 | -5.4 | 1.52 H | 107 | 15.90 | 32.70 |
| 5 | 4924.00 | 50.2 PK | 74.0 | -23.8 | 1.26 H | 122 | 43.90 | 6.30 |
| 6 | 4924.00 | 37.3 AV | 54.0 | -16.7 | 1.26 H | 122 | 31.00 | 6.30 |

ANTENNA POLARITY & TEST DISTANCE: VERTICAL AT 3 M

| NO. | FREQ. (MHz) | EMISSION LEVEL (dBuV/m) | LIMIT (dBuV/m) | MARGIN (dB) | ANTENNA HEIGHT (m) | TABLE ANGLE (Degree) | RAW VALUE (dBuV) | CORRECTION FACTOR (dB/m) |
|-----|-------------|-------------------------|----------------|-------------|--------------------|----------------------|------------------|--------------------------|
| 1 | *2462.00 | 113.8 PK | | | 1.60 V | 242 | 81.20 | 32.60 |
| 2 | *2462.00 | 102.8 AV | | | 1.60 V | 242 | 70.20 | 32.60 |
| 3 | 2483.50 | 72.3 PK | 74.0 | -1.7 | 1.61 V | 19 | 39.60 | 32.70 |
| 4 | 2483.50 | 52.6 AV | 54.0 | -1.4 | 1.61 V | 19 | 19.90 | 32.70 |
| 5 | 4924.00 | 49.5 PK | 74.0 | -24.5 | 1.50 V | 279 | 43.20 | 6.30 |
| 6 | 4924.00 | 36.7 AV | 54.0 | -17.3 | 1.50 V | 279 | 30.40 | 6.30 |

REMARKS:

1. Emission Level(dBuV/m) = Raw Value(dBuV) + Correction Factor(dB/m)
2. Correction Factor(dB/m) = Antenna Factor(dB/m) + Cable Factor(dB)
3. The other emission levels were very low against the limit.
4. Margin value = Emission Level – Limit value
5. " * ": Fundamental frequency.

802.11n (HT20)

| | | | |
|-----------------|--------------|----------------------|--------------|
| CHANNEL | TX Channel 1 | DETECTOR FUNCTION | Peak (PK) |
| FREQUENCY RANGE | 1GHz ~ 25GHz | | Average (AV) |

| ANTENNA POLARITY & TEST DISTANCE: HORIZONTAL AT 3 M | | | | | | | | |
|---|-------------|-------------------------|----------------|-------------|--------------------|----------------------|------------------|--------------------------|
| NO. | FREQ. (MHz) | EMISSION LEVEL (dBuV/m) | LIMIT (dBuV/m) | MARGIN (dB) | ANTENNA HEIGHT (m) | TABLE ANGLE (Degree) | RAW VALUE (dBuV) | CORRECTION FACTOR (dB/m) |
| 1 | 2390.00 | 62.5 PK | 74.0 | -11.5 | 1.06 H | 130 | 30.00 | 32.50 |
| 2 | 2390.00 | 45.9 AV | 54.0 | -8.1 | 1.06 H | 130 | 13.40 | 32.50 |
| 3 | *2412.00 | 102.7 PK | | | 1.00 H | 133 | 70.10 | 32.60 |
| 4 | *2412.00 | 93.3 AV | | | 1.00 H | 133 | 60.70 | 32.60 |
| 5 | 4824.00 | 50.1 PK | 74.0 | -23.9 | 1.36 H | 22 | 44.00 | 6.10 |
| 6 | 4824.00 | 37.8 AV | 54.0 | -16.2 | 1.36 H | 22 | 31.70 | 6.10 |

| ANTENNA POLARITY & TEST DISTANCE: VERTICAL AT 3 M | | | | | | | | |
|---|----------------|-------------------------|----------------|-------------|--------------------|----------------------|------------------|--------------------------|
| NO. | FREQ. (MHz) | EMISSION LEVEL (dBuV/m) | LIMIT (dBuV/m) | MARGIN (dB) | ANTENNA HEIGHT (m) | TABLE ANGLE (Degree) | RAW VALUE (dBuV) | CORRECTION FACTOR (dB/m) |
| 1 | 2390.00 | 71.5 PK | 74.0 | -2.5 | 1.56 V | 125 | 39.00 | 32.50 |
| 2 | 2390.00 | 52.8 AV | 54.0 | -1.2 | 1.56 V | 125 | 20.30 | 32.50 |
| 3 | *2412.00 | 114.2 PK | | | 1.81 V | 347 | 81.60 | 32.60 |
| 4 | *2412.00 | 104.3 AV | | | 1.81 V | 347 | 71.70 | 32.60 |
| 5 | 4824.00 | 49.8 PK | 74.0 | -24.2 | 1.71 V | 264 | 43.70 | 6.10 |
| 6 | 4824.00 | 37.1 AV | 54.0 | -16.9 | 1.71 V | 264 | 31.00 | 6.10 |

REMARKS:

1. Emission Level(dBuV/m) = Raw Value(dBuV) + Correction Factor(dB/m)
2. Correction Factor(dB/m) = Antenna Factor(dB/m) + Cable Factor(dB)
3. The other emission levels were very low against the limit.
4. Margin value = Emission Level – Limit value
5. " * ": Fundamental frequency.

| | | | |
|-----------------|--------------|----------------------|--------------|
| CHANNEL | TX Channel 6 | DETECTOR FUNCTION | Peak (PK) |
| FREQUENCY RANGE | 1GHz ~ 25GHz | | Average (AV) |

ANTENNA POLARITY & TEST DISTANCE: HORIZONTAL AT 3 M

| NO. | FREQ. (MHz) | EMISSION LEVEL (dBuV/m) | LIMIT (dBuV/m) | MARGIN (dB) | ANTENNA HEIGHT (m) | TABLE ANGLE (Degree) | RAW VALUE (dBuV) | CORRECTION FACTOR (dB/m) |
|-----|-------------|-------------------------|----------------|-------------|--------------------|----------------------|------------------|--------------------------|
| 1 | 2390.00 | 58.2 PK | 74.0 | -15.8 | 1.23 H | 100 | 25.70 | 32.50 |
| 2 | 2390.00 | 46.1 AV | 54.0 | -7.9 | 1.23 H | 100 | 13.60 | 32.50 |
| 3 | *2437.00 | 110.6 PK | | | 1.00 H | 130 | 77.90 | 32.70 |
| 4 | *2437.00 | 102.1 AV | | | 1.00 H | 130 | 69.40 | 32.70 |
| 5 | 2483.50 | 59.0 PK | 74.0 | -15.0 | 1.11 H | 22 | 26.30 | 32.70 |
| 6 | 2483.50 | 47.1 AV | 54.0 | -6.9 | 1.11 H | 22 | 14.40 | 32.70 |
| 7 | 4874.00 | 50.1 PK | 74.0 | -23.9 | 1.11 H | 68 | 43.90 | 6.20 |
| 8 | 4874.00 | 37.9 AV | 54.0 | -16.1 | 1.11 H | 68 | 31.70 | 6.20 |

ANTENNA POLARITY & TEST DISTANCE: VERTICAL AT 3 M

| NO. | FREQ. (MHz) | EMISSION LEVEL (dBuV/m) | LIMIT (dBuV/m) | MARGIN (dB) | ANTENNA HEIGHT (m) | TABLE ANGLE (Degree) | RAW VALUE (dBuV) | CORRECTION FACTOR (dB/m) |
|-----|-------------|-------------------------|----------------|-------------|--------------------|----------------------|------------------|--------------------------|
| 1 | 2390.00 | 68.8 PK | 74.0 | -5.2 | 1.89 V | 317 | 36.30 | 32.50 |
| 2 | 2390.00 | 50.8 AV | 54.0 | -3.2 | 1.89 V | 317 | 18.30 | 32.50 |
| 3 | *2437.00 | 121.3 PK | | | 1.61 V | 79 | 88.60 | 32.70 |
| 4 | *2437.00 | 111.3 AV | | | 1.61 V | 79 | 78.60 | 32.70 |
| 5 | 2483.50 | 68.2 PK | 74.0 | -5.8 | 1.82 V | 326 | 35.50 | 32.70 |
| 6 | 2483.50 | 52.1 AV | 54.0 | -1.9 | 1.82 V | 326 | 19.40 | 32.70 |
| 7 | 4874.00 | 49.7 PK | 74.0 | -24.3 | 1.53 V | 229 | 43.50 | 6.20 |
| 8 | 4874.00 | 36.4 AV | 54.0 | -17.6 | 1.53 V | 229 | 30.20 | 6.20 |

REMARKS:

1. Emission Level(dBuV/m) = Raw Value(dBuV) + Correction Factor(dB/m)
2. Correction Factor(dB/m) = Antenna Factor(dB/m) + Cable Factor(dB)
3. The other emission levels were very low against the limit.
4. Margin value = Emission Level – Limit value
5. " * ": Fundamental frequency.



| | | | |
|-----------------|---------------|----------------------|--------------|
| CHANNEL | TX Channel 11 | DETECTOR FUNCTION | Peak (PK) |
| FREQUENCY RANGE | 1GHz ~ 25GHz | | Average (AV) |

ANTENNA POLARITY & TEST DISTANCE: HORIZONTAL AT 3 M

| NO. | FREQ. (MHz) | EMISSION LEVEL (dBuV/m) | LIMIT (dBuV/m) | MARGIN (dB) | ANTENNA HEIGHT (m) | TABLE ANGLE (Degree) | RAW VALUE (dBuV) | CORRECTION FACTOR (dB/m) |
|-----|-------------|-------------------------|----------------|-------------|--------------------|----------------------|------------------|--------------------------|
| 1 | *2462.00 | 102.8 PK | | | 1.11 H | 132 | 70.20 | 32.60 |
| 2 | *2462.00 | 93.5 AV | | | 1.11 H | 132 | 60.90 | 32.60 |
| 3 | 2483.50 | 59.9 PK | 74.0 | -14.1 | 1.15 H | 130 | 27.20 | 32.70 |
| 4 | 2483.50 | 47.6 AV | 54.0 | -6.4 | 1.15 H | 130 | 14.90 | 32.70 |
| 5 | 4924.00 | 48.5 PK | 74.0 | -25.5 | 1.23 H | 358 | 42.20 | 6.30 |
| 6 | 4924.00 | 35.7 AV | 54.0 | -18.3 | 1.23 H | 358 | 29.40 | 6.30 |

ANTENNA POLARITY & TEST DISTANCE: VERTICAL AT 3 M

| NO. | FREQ. (MHz) | EMISSION LEVEL (dBuV/m) | LIMIT (dBuV/m) | MARGIN (dB) | ANTENNA HEIGHT (m) | TABLE ANGLE (Degree) | RAW VALUE (dBuV) | CORRECTION FACTOR (dB/m) |
|-----|-------------|-------------------------|----------------|-------------|--------------------|----------------------|------------------|--------------------------|
| 1 | *2462.00 | 114.4 PK | | | 1.66 V | 12 | 81.80 | 32.60 |
| 2 | *2462.00 | 104.8 AV | | | 1.66 V | 12 | 72.20 | 32.60 |
| 3 | 2483.50 | 71.0 PK | 74.0 | -3.0 | 1.70 V | 15 | 38.30 | 32.70 |
| 4 | 2483.50 | 52.6 AV | 54.0 | -1.4 | 1.70 V | 15 | 19.90 | 32.70 |
| 5 | 4924.00 | 49.0 PK | 74.0 | -25.0 | 1.43 V | 81 | 42.70 | 6.30 |
| 6 | 4924.00 | 35.6 AV | 54.0 | -18.4 | 1.43 V | 81 | 29.30 | 6.30 |

REMARKS:

1. Emission Level(dBuV/m) = Raw Value(dBuV) + Correction Factor(dB/m)
2. Correction Factor(dB/m) = Antenna Factor(dB/m) + Cable Factor(dB)
3. The other emission levels were very low against the limit.
4. Margin value = Emission Level – Limit value
5. " * ": Fundamental frequency.

802.11n (HT40)

| | | | |
|-----------------|--------------|----------------------|--------------|
| CHANNEL | TX Channel 3 | DETECTOR FUNCTION | Peak (PK) |
| FREQUENCY RANGE | 1GHz ~ 25GHz | | Average (AV) |

| ANTENNA POLARITY & TEST DISTANCE: HORIZONTAL AT 3 M | | | | | | | | |
|---|-------------|-------------------------|----------------|-------------|--------------------|----------------------|------------------|--------------------------|
| NO. | FREQ. (MHz) | EMISSION LEVEL (dBuV/m) | LIMIT (dBuV/m) | MARGIN (dB) | ANTENNA HEIGHT (m) | TABLE ANGLE (Degree) | RAW VALUE (dBuV) | CORRECTION FACTOR (dB/m) |
| 1 | 2390.00 | 62.8 PK | 74.0 | -11.2 | 1.30 H | 191 | 30.30 | 32.50 |
| 2 | 2390.00 | 47.1 AV | 54.0 | -6.9 | 1.30 H | 191 | 14.60 | 32.50 |
| 3 | *2422.00 | 100.2 PK | | | 1.00 H | 131 | 67.60 | 32.60 |
| 4 | *2422.00 | 90.8 AV | | | 1.00 H | 131 | 58.20 | 32.60 |
| 5 | 4844.00 | 48.1 PK | 74.0 | -25.9 | 1.20 H | 221 | 42.00 | 6.10 |
| 6 | 4844.00 | 35.3 AV | 54.0 | -18.7 | 1.20 H | 221 | 29.20 | 6.10 |

| ANTENNA POLARITY & TEST DISTANCE: VERTICAL AT 3 M | | | | | | | | |
|---|-------------|-------------------------|----------------|-------------|--------------------|----------------------|------------------|--------------------------|
| NO. | FREQ. (MHz) | EMISSION LEVEL (dBuV/m) | LIMIT (dBuV/m) | MARGIN (dB) | ANTENNA HEIGHT (m) | TABLE ANGLE (Degree) | RAW VALUE (dBuV) | CORRECTION FACTOR (dB/m) |
| 1 | 2390.00 | 66.9 PK | 74.0 | -7.1 | 1.70 V | 341 | 34.40 | 32.50 |
| 2 | 2390.00 | 52.5 AV | 54.0 | -1.5 | 1.70 V | 341 | 20.00 | 32.50 |
| 3 | *2422.00 | 109.3 PK | | | 1.72 V | 344 | 76.70 | 32.60 |
| 4 | *2422.00 | 100.2 AV | | | 1.72 V | 344 | 67.60 | 32.60 |
| 5 | 4844.00 | 48.6 PK | 74.0 | -25.4 | 1.62 V | 284 | 42.50 | 6.10 |
| 6 | 4844.00 | 35.6 AV | 54.0 | -18.4 | 1.62 V | 284 | 29.50 | 6.10 |

REMARKS:

1. Emission Level(dBuV/m) = Raw Value(dBuV) + Correction Factor(dB/m)
2. Correction Factor(dB/m) = Antenna Factor(dB/m) + Cable Factor(dB)
3. The other emission levels were very low against the limit.
4. Margin value = Emission Level – Limit value
5. " * ": Fundamental frequency.



| | | | |
|-----------------|--------------|----------------------|--------------|
| CHANNEL | TX Channel 6 | DETECTOR FUNCTION | Peak (PK) |
| FREQUENCY RANGE | 1GHz ~ 25GHz | | Average (AV) |

ANTENNA POLARITY & TEST DISTANCE: HORIZONTAL AT 3 M

| NO. | FREQ. (MHz) | EMISSION LEVEL (dBuV/m) | LIMIT (dBuV/m) | MARGIN (dB) | ANTENNA HEIGHT (m) | TABLE ANGLE (Degree) | RAW VALUE (dBuV) | CORRECTION FACTOR (dB/m) |
|-----|-------------|-------------------------------|-------------------|----------------|--------------------------|----------------------------|------------------------|--------------------------------|
| 1 | 2390.00 | 56.7 PK | 74.0 | -17.3 | 1.00 H | 123 | 24.20 | 32.50 |
| 2 | 2390.00 | 45.0 AV | 54.0 | -9.0 | 1.00 H | 123 | 12.50 | 32.50 |
| 3 | *2437.00 | 102.3 PK | | | 1.00 H | 123 | 69.60 | 32.70 |
| 4 | *2437.00 | 93.0 AV | | | 1.00 H | 123 | 60.30 | 32.70 |
| 5 | 2483.50 | 58.9 PK | 74.0 | -15.1 | 1.06 H | 130 | 26.20 | 32.70 |
| 6 | 2483.50 | 46.1 AV | 54.0 | -7.9 | 1.06 H | 130 | 13.40 | 32.70 |
| 7 | 4874.00 | 48.4 PK | 74.0 | -25.6 | 1.29 H | 176 | 42.20 | 6.20 |
| 8 | 4874.00 | 35.4 AV | 54.0 | -18.6 | 1.29 H | 176 | 29.20 | 6.20 |

ANTENNA POLARITY & TEST DISTANCE: VERTICAL AT 3 M

| NO. | FREQ. (MHz) | EMISSION LEVEL (dBuV/m) | LIMIT (dBuV/m) | MARGIN (dB) | ANTENNA HEIGHT (m) | TABLE ANGLE (Degree) | RAW VALUE (dBuV) | CORRECTION FACTOR (dB/m) |
|-----|-------------|-------------------------------|-------------------|----------------|--------------------------|----------------------------|------------------------|--------------------------------|
| 1 | 2390.00 | 67.1 PK | 74.0 | -6.9 | 2.02 V | 0 | 34.60 | 32.50 |
| 2 | 2390.00 | 50.3 AV | 54.0 | -3.7 | 2.02 V | 0 | 17.80 | 32.50 |
| 3 | *2437.00 | 113.2 PK | | | 1.68 V | 322 | 80.50 | 32.70 |
| 4 | *2437.00 | 103.8 AV | | | 1.68 V | 322 | 71.10 | 32.70 |
| 5 | 2483.50 | 70.3 PK | 74.0 | -3.7 | 1.62 V | 6 | 37.60 | 32.70 |
| 6 | 2483.50 | 52.6 AV | 54.0 | -1.4 | 1.62 V | 6 | 19.90 | 32.70 |
| 7 | 4874.00 | 49.2 PK | 74.0 | -24.8 | 1.60 V | 343 | 43.00 | 6.20 |
| 8 | 4874.00 | 36.0 AV | 54.0 | -18.0 | 1.60 V | 343 | 29.80 | 6.20 |

REMARKS:

1. Emission Level(dBuV/m) = Raw Value(dBuV) + Correction Factor(dB/m)
2. Correction Factor(dB/m) = Antenna Factor(dB/m) + Cable Factor(dB)
3. The other emission levels were very low against the limit.
4. Margin value = Emission Level – Limit value
5. " * ": Fundamental frequency.



| | | | |
|-----------------|--------------|----------------------|--------------|
| CHANNEL | TX Channel 9 | DETECTOR FUNCTION | Peak (PK) |
| FREQUENCY RANGE | 1GHz ~ 25GHz | | Average (AV) |

ANTENNA POLARITY & TEST DISTANCE: HORIZONTAL AT 3 M

| NO. | FREQ. (MHz) | EMISSION LEVEL (dBuV/m) | LIMIT (dBuV/m) | MARGIN (dB) | ANTENNA HEIGHT (m) | TABLE ANGLE (Degree) | RAW VALUE (dBuV) | CORRECTION FACTOR (dB/m) |
|-----|-------------|-------------------------------|-------------------|----------------|--------------------------|----------------------------|------------------------|--------------------------------|
| 1 | *2452.00 | 98.0 PK | | | 1.00 H | 132 | 65.30 | 32.70 |
| 2 | *2452.00 | 89.4 AV | | | 1.00 H | 132 | 56.70 | 32.70 |
| 3 | 2483.50 | 58.8 PK | 74.0 | -15.2 | 1.03 H | 144 | 26.10 | 32.70 |
| 4 | 2483.50 | 46.3 AV | 54.0 | -7.7 | 1.03 H | 144 | 13.60 | 32.70 |
| 5 | 4904.00 | 47.6 PK | 74.0 | -26.4 | 1.22 H | 163 | 41.50 | 6.10 |
| 6 | 4904.00 | 34.6 AV | 54.0 | -19.4 | 1.22 H | 163 | 28.50 | 6.10 |

ANTENNA POLARITY & TEST DISTANCE: VERTICAL AT 3 M

| NO. | FREQ. (MHz) | EMISSION LEVEL (dBuV/m) | LIMIT (dBuV/m) | MARGIN (dB) | ANTENNA HEIGHT (m) | TABLE ANGLE (Degree) | RAW VALUE (dBuV) | CORRECTION FACTOR (dB/m) |
|-----|-------------|-------------------------------|-------------------|----------------|--------------------------|----------------------------|------------------------|--------------------------------|
| 1 | *2452.00 | 109.2 PK | | | 1.68 V | 330 | 76.50 | 32.70 |
| 2 | *2452.00 | 100.1 AV | | | 1.68 V | 330 | 67.40 | 32.70 |
| 3 | 2483.50 | 67.2 PK | 74.0 | -6.8 | 1.62 V | 10 | 34.50 | 32.70 |
| 4 | 2483.50 | 52.4 AV | 54.0 | -1.6 | 1.62 V | 10 | 19.70 | 32.70 |
| 5 | 4904.00 | 47.8 PK | 74.0 | -26.2 | 1.59 V | 166 | 41.70 | 6.10 |
| 6 | 4904.00 | 34.8 AV | 54.0 | -19.2 | 1.59 V | 166 | 28.70 | 6.10 |

REMARKS:

1. Emission Level(dBuV/m) = Raw Value(dBuV) + Correction Factor(dB/m)
2. Correction Factor(dB/m) = Antenna Factor(dB/m) + Cable Factor(dB)
3. The other emission levels were very low against the limit.
4. Margin value = Emission Level – Limit value
5. " * ": Fundamental frequency.

Below 1GHz Worst-Case Data: 802.11b

| | | | |
|-----------------|--------------|----------------------|-----------------|
| CHANNEL | TX Channel 1 | DETECTOR FUNCTION | Quasi-Peak (QP) |
| FREQUENCY RANGE | 9kHz ~ 1GHz | | |

| ANTENNA POLARITY & TEST DISTANCE: HORIZONTAL AT 3 M | | | | | | | | |
|---|-------------|-------------------------|----------------|-------------|--------------------|----------------------|------------------|--------------------------|
| NO. | FREQ. (MHz) | EMISSION LEVEL (dBuV/m) | LIMIT (dBuV/m) | MARGIN (dB) | ANTENNA HEIGHT (m) | TABLE ANGLE (Degree) | RAW VALUE (dBuV) | CORRECTION FACTOR (dB/m) |
| 1 | 57.12 | 31.6 QP | 40.0 | -8.4 | 1.50 H | 59 | 46.40 | -14.80 |
| 2 | 97.95 | 33.4 QP | 43.5 | -10.1 | 1.99 H | 252 | 52.70 | -19.30 |
| 3 | 142.67 | 35.3 QP | 43.5 | -8.2 | 1.99 H | 72 | 49.70 | -14.40 |
| 4 | 183.50 | 34.7 QP | 43.5 | -8.8 | 1.50 H | 132 | 50.20 | -15.50 |
| 5 | 202.94 | 35.1 QP | 43.5 | -8.4 | 1.50 H | 39 | 51.90 | -16.80 |
| 6 | 288.49 | 28.2 QP | 46.0 | -17.8 | 1.00 H | 120 | 41.00 | -12.80 |

| ANTENNA POLARITY & TEST DISTANCE: VERTICAL AT 3 M | | | | | | | | |
|---|-------------|-------------------------|----------------|-------------|--------------------|----------------------|------------------|--------------------------|
| NO. | FREQ. (MHz) | EMISSION LEVEL (dBuV/m) | LIMIT (dBuV/m) | MARGIN (dB) | ANTENNA HEIGHT (m) | TABLE ANGLE (Degree) | RAW VALUE (dBuV) | CORRECTION FACTOR (dB/m) |
| 1 | 49.93 | 36.8 QP | 40.0 | -3.2 | 1.12 V | 30 | 51.40 | -14.60 |
| 2 | 62.95 | 35.2 QP | 40.0 | -4.8 | 1.00 V | 124 | 50.60 | -15.40 |
| 3 | 109.62 | 36.4 QP | 43.5 | -7.1 | 1.00 V | 277 | 53.80 | -17.40 |
| 4 | 148.50 | 33.4 QP | 43.5 | -10.1 | 1.00 V | 296 | 47.40 | -14.00 |
| 5 | 175.72 | 31.8 QP | 43.5 | -11.7 | 1.00 V | 3 | 46.50 | -14.70 |
| 6 | 202.94 | 32.7 QP | 43.5 | -10.8 | 1.00 V | 183 | 49.50 | -16.80 |

REMARKS:

1. Emission Level(dBuV/m) = Raw Value(dBuV) + Correction Factor(dB/m)
2. Correction Factor(dB/m) = Antenna Factor(dB/m) + Cable Factor(dB)
3. The other emission levels were very low against the limit.
4. Margin value = Emission Level – Limit value

4.2 Conducted Emission Measurement

4.2.1 Limits of Conducted Emission Measurement

| Frequency (MHz) | Conducted Limit (dBuV) | |
|-----------------|------------------------|---------|
| | Quasi-peak | Average |
| 0.15 - 0.5 | 66 - 56 | 56 - 46 |
| 0.50 - 5.0 | 56 | 46 |
| 5.0 - 30.0 | 60 | 50 |

Note: 1. The lower limit shall apply at the transition frequencies.

2. The limit decreases in line with the logarithm of the frequency in the range of 0.15 to 0.50MHz.

4.2.2 Test Instruments

| Description & Manufacturer | Model No. | Serial No. | Cal. Date | Cal. Due |
|--|--------------------------|----------------|---------------|---------------|
| Test Receiver ROHDE & SCHWARZ | ESCS 30 | 100288 | Apr. 27, 2015 | Apr. 26, 2016 |
| RF signal cable (with 10dB PAD) Woken | 5D-FB | Cable-cond2-01 | Dec. 26, 2014 | Dec. 25, 2015 |
| LISN ROHDE & SCHWARZ (EUT) | ESH2-Z5 | 100100 | Dec. 30, 2014 | Dec. 29, 2015 |
| LISN ROHDE & SCHWARZ (Peripheral) | ESH3-Z5 | 100312 | Jul. 21, 2015 | Jul. 20, 2016 |
| Software ADT | BV ADT_Cond_ V7.3.7.3 | NA | NA | NA |

Note: 1. The calibration interval of the above test instruments is 12 months and the calibrations are traceable to NML/ROC and NIST/USA.

2. The test was performed in HwaYa Shielded Room 2.

3. The VCCI Site Registration No. is C-2047.

4.2.3 Test Procedures

- The EUT was placed 0.4 meters from the conducting wall of the shielded room with EUT being connected to the power mains through a line impedance stabilization network (LISN). Other support units were connected to the power mains through another LISN. The two LISNs provide 50 ohm/ 50uH of coupling impedance for the measuring instrument.
- Both lines of the power mains connected to the EUT were checked for maximum conducted interference.
- The frequency range from 150kHz to 30MHz was searched. Emission levels under (Limit - 20dB) were not recorded.

NOTE: The resolution bandwidth and video bandwidth of test receiver is 9kHz for quasi-peak detection (QP) and average detection (AV) at frequency 0.15MHz-30MHz.

4.2.4 Deviation from Test Standard

No deviation.

4.2.5 Test Setup

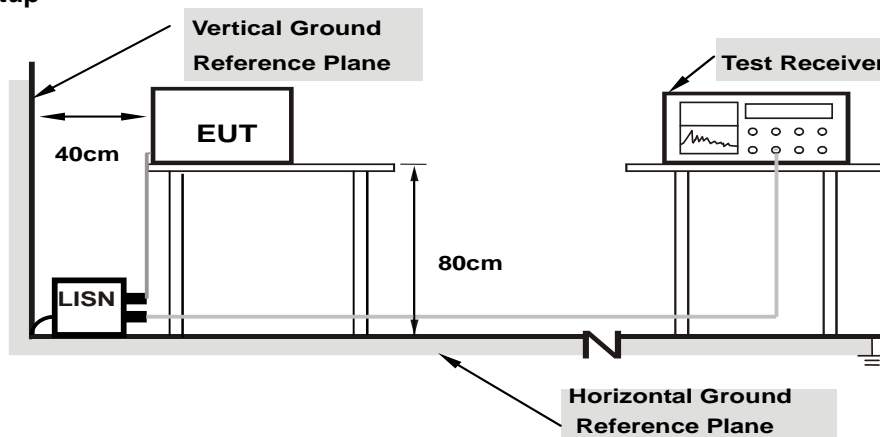

Note: 1.Support units were connected to second LISN.

For the actual test configuration, please refer to the attached file (Test Setup Photo).

4.2.6 EUT Operating Conditions

Same as 4.1.6.

4.2.7 Test Results

| Phase | Line (L) | Detector Function | Quasi-Peak (QP) / Average (AV) |
|-------|----------|-------------------|--------------------------------|
|-------|----------|-------------------|--------------------------------|

| No | Freq. [MHz] | Corr. Factor (dB) | Reading Value [dB (uV)] | | Emission Level [dB (uV)] | | Limit [dB (uV)] | | Margin (dB) | |
|----|----------------|-------------------------|----------------------------|---------|-----------------------------|-------|--------------------|-------|----------------|--------|
| | | | Q.P. | AV. | Q.P. | AV. | Q.P. | AV. | Q.P. | AV. |
| | | | 1 | 0.15000 | 9.94 | 39.50 | 27.20 | 49.44 | 37.14 | 66.00 |
| 2 | 0.18125 | 9.94 | 39.02 | 28.72 | 48.96 | 38.66 | 64.43 | 54.43 | -15.46 | -15.76 |
| 3 | 0.43234 | 9.96 | 36.25 | 34.50 | 46.21 | 44.46 | 57.21 | 47.21 | -11.00 | -2.75 |
| 4 | 4.59766 | 10.29 | 28.23 | 21.09 | 38.52 | 31.38 | 56.00 | 46.00 | -17.48 | -14.62 |
| 5 | 5.55078 | 10.31 | 30.31 | 22.21 | 40.62 | 32.52 | 60.00 | 50.00 | -19.38 | -17.48 |
| 6 | 6.89453 | 10.35 | 32.50 | 26.52 | 42.85 | 36.87 | 60.00 | 50.00 | -17.15 | -13.13 |

REMARKS:

1. Q.P. and AV. are abbreviations of quasi-peak and average individually.
2. The emission levels of other frequencies were very low against the limit.
3. Margin value = Emission level - Limit value
4. Correction factor = Insertion loss + Cable loss
5. Emission Level = Correction Factor + Reading Value.

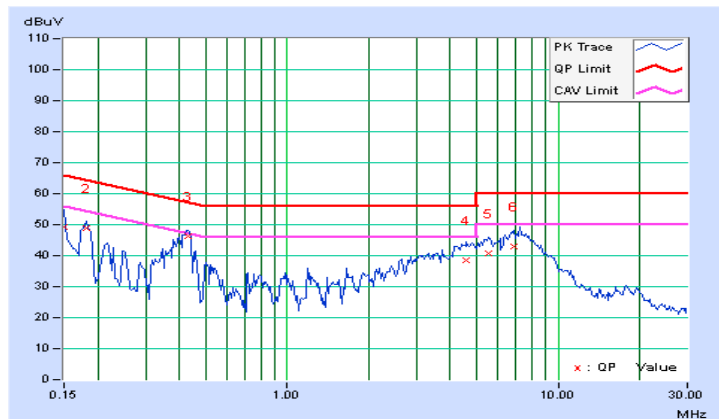

| | | | |
|-------|-------------|-------------------|--------------------------------|
| Phase | Neutral (N) | Detector Function | Quasi-Peak (QP) / Average (AV) |
|-------|-------------|-------------------|--------------------------------|

| No | Freq. [MHz] | Corr. Factor (dB) | Reading Value [dB (uV)] | | Emission Level [dB (uV)] | | Limit [dB (uV)] | | Margin (dB) | |
|----------|----------------|----------------------|----------------------------|--------------|-----------------------------|--------------|--------------------|--------------|----------------|--------------|
| | | | Q.P. | AV. | Q.P. | AV. | Q.P. | AV. | Q.P. | AV. |
| | | | 1 | 0.15000 | 9.95 | 40.08 | 27.00 | 50.03 | 36.95 | 66.00 |
| 2 | 0.17989 | 9.96 | 39.43 | 29.35 | 49.39 | 39.31 | 64.49 | 54.49 | -15.10 | -15.18 |
| 3 | 0.43116 | 10.00 | 36.41 | 34.70 | 46.41 | 44.70 | 57.23 | 47.23 | -10.82 | -2.53 |
| 4 | 0.97521 | 10.07 | 21.25 | 16.09 | 31.32 | 26.16 | 56.00 | 46.00 | -24.68 | -19.84 |
| 5 | 4.71875 | 10.33 | 29.48 | 22.01 | 39.81 | 32.34 | 56.00 | 46.00 | -16.19 | -13.66 |
| 6 | 7.52734 | 10.42 | 32.41 | 27.11 | 42.83 | 37.53 | 60.00 | 50.00 | -17.17 | -12.47 |

REMARKS:

1. Q.P. and AV. are abbreviations of quasi-peak and average individually.
2. The emission levels of other frequencies were very low against the limit.
3. Margin value = Emission level - Limit value
4. Correction factor = Insertion loss + Cable loss
5. Emission Level = Correction Factor + Reading Value.

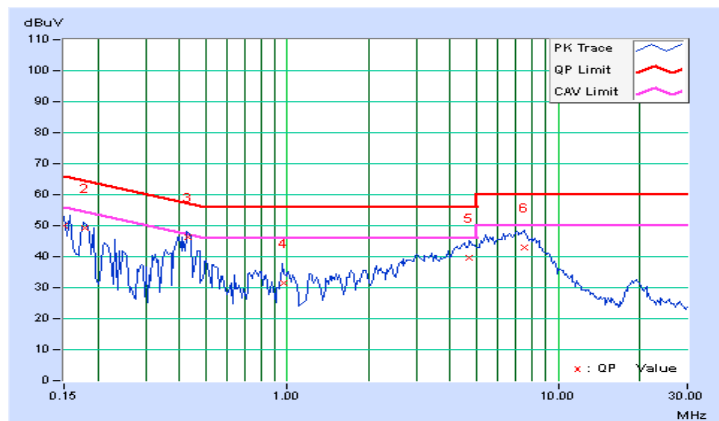

4.3 6dB Bandwidth Measurement

4.3.1 Limits of 6dB Bandwidth Measurement

The minimum of 6dB Bandwidth Measurement is 0.5 MHz.

4.3.2 Test Setup

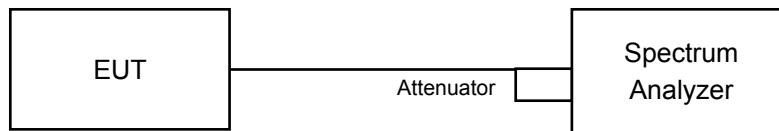

4.3.3 Test Instruments

Refer to section 4.1.2 to get information of above instrument.

4.3.4 Test Procedure

- Set resolution bandwidth (RBW) = 100kHz
- Set the video bandwidth (VBW) $\geq 3 \times$ RBW, Detector = Peak.
- Trace mode = max hold.
- Sweep = auto couple.
- Measure the maximum width of the emission that is constrained by the frequencies associated with the two amplitude points (upper and lower) that are attenuated by 6 dB relative to the maximum level measured in the fundamental emission

4.3.5 Deviation from Test Standard

No deviation.

4.3.6 EUT Operating Conditions

The software provided by client to enable the EUT under transmission condition continuously at lowest, middle and highest channel frequencies individually.

4.3.7 Test Result

802.11b

| Channel | Frequency (MHz) | 6dB Bandwidth (MHz) | | Minimum Limit (MHz) | Pass / Fail |
|---------|-----------------|---------------------|---------|---------------------|-------------|
| | | CHAIN 0 | CHAIN 1 | | |
| 1 | 2412 | 9.07 | 9.12 | 0.5 | Pass |
| 6 | 2437 | 9.10 | 9.08 | 0.5 | Pass |
| 11 | 2462 | 8.57 | 9.09 | 0.5 | Pass |

802.11g

| Channel | Frequency (MHz) | 6dB Bandwidth (MHz) | | Minimum Limit (MHz) | Pass / Fail |
|---------|-----------------|---------------------|---------|---------------------|-------------|
| | | CHAIN 0 | CHAIN 1 | | |
| 1 | 2412 | 16.43 | 16.45 | 0.5 | Pass |
| 6 | 2437 | 16.35 | 16.40 | 0.5 | Pass |
| 11 | 2462 | 16.40 | 16.44 | 0.5 | Pass |

802.11n (HT20)

| Channel | Frequency (MHz) | 6dB Bandwidth (MHz) | | Minimum Limit (MHz) | Pass / Fail |
|---------|-----------------|---------------------|---------|---------------------|-------------|
| | | CHAIN 0 | CHAIN 1 | | |
| 1 | 2412 | 17.65 | 17.67 | 0.5 | Pass |
| 6 | 2437 | 17.21 | 17.67 | 0.5 | Pass |
| 11 | 2462 | 17.63 | 17.66 | 0.5 | Pass |

802.11n (HT40)

| Channel | Frequency (MHz) | 6dB Bandwidth (MHz) | | Minimum Limit (MHz) | Pass / Fail |
|---------|-----------------|---------------------|---------|---------------------|-------------|
| | | CHAIN 0 | CHAIN 1 | | |
| 3 | 2422 | 36.24 | 36.41 | 0.5 | Pass |
| 6 | 2437 | 36.12 | 36.42 | 0.5 | Pass |
| 9 | 2452 | 36.37 | 36.45 | 0.5 | Pass |

Spectrum Plot of Worst Value

802.11b

802.11g

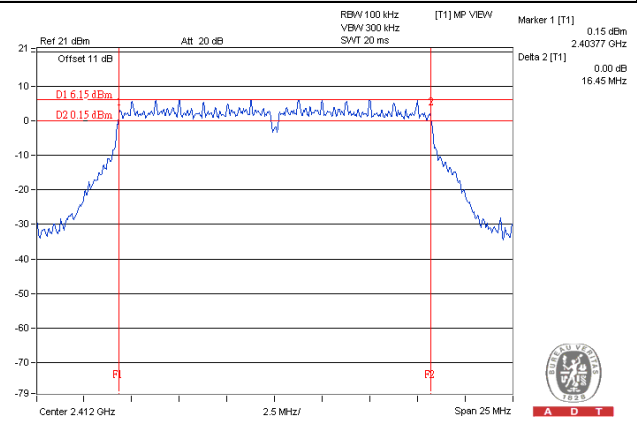
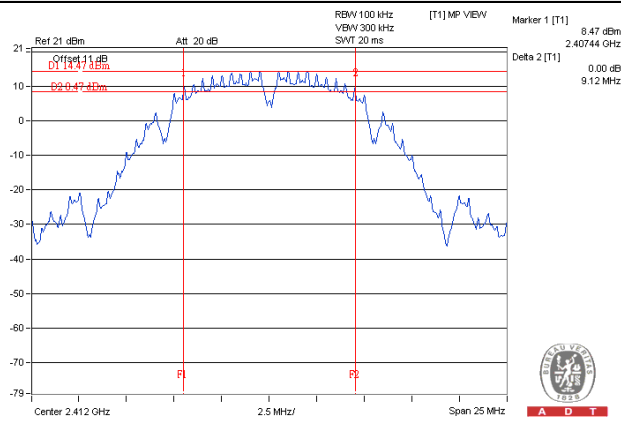

802.11n (HT20)

802.11n (HT40)

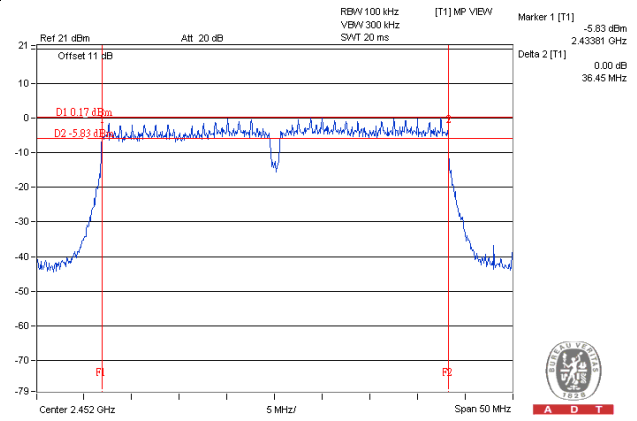
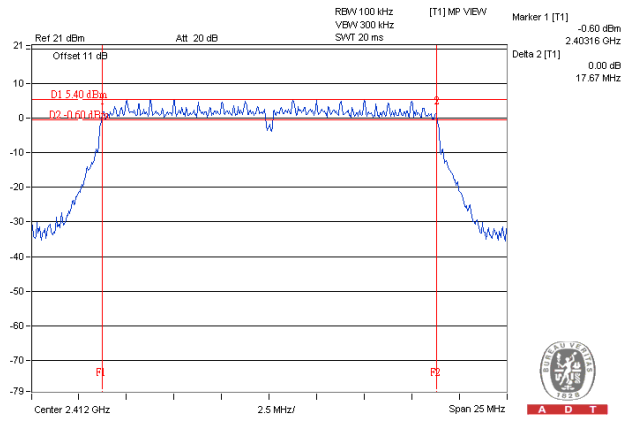

4.4 Conducted Output Power Measurement

4.4.1 Limits of Conducted Output Power Measurement

For systems using digital modulation in the 2400–2483.5 MHz bands: 1 Watt (30dBm)
Per KDB 662911 D01 Multiple Transmitter Output Method of conducted output power measurement on IEEE 802.11 devices,

Array Gain = 0 dB (i.e., no array gain) for $NANT \leq 4$;

Array Gain = 0 dB (i.e., no array gain) for channel widths ≥ 40 MHz for any NANT;

Array Gain = $5 \log(NANT/NSS)$ dB or 3 dB, whichever is less for 20-MHz channel widths with $NANT \geq 5$.

For power measurements on all other devices: Array Gain = $10 \log(NANT/NSS)$ dB.

4.4.2 Test Setup

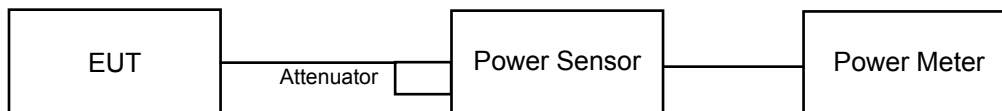

4.4.3 Test Instruments

Refer to section 4.1.2 to get information of above instrument.

4.4.4 Test Procedures

An average power sensor was used on the output port of the EUT. A power meter was used to read the response of the average power sensor. Record the power level.

4.4.5 Deviation from Test Standard

No deviation.

4.4.6 EUT Operating Conditions

Same as item 4.3.6.

4.4.7 Test Results

For Average Power

802.11b

| Chan. | Freq. (MHz) | Average Power (dBm) | | Total Power (mW) | Total Power (dBm) | Limit (dBm) | Pass / Fail |
|-------|-------------|---------------------|---------|------------------|-------------------|-------------|-------------|
| | | Chain 0 | Chain 1 | | | | |
| 1 | 2412 | 23.84 | 23.63 | 472.778 | 26.75 | 30 | Pass |
| 6 | 2437 | 25.83 | 25.61 | 746.740 | 28.73 | 30 | Pass |
| 11 | 2462 | 22.37 | 22.01 | 331.439 | 25.20 | 30 | Pass |

802.11g

| Chan. | Freq. (MHz) | Average Power (dBm) | | Total Power (mW) | Total Power (dBm) | Limit (dBm) | Pass / Fail |
|-------|-------------|---------------------|---------|------------------|-------------------|-------------|-------------|
| | | Chain 0 | Chain 1 | | | | |
| 1 | 2412 | 18.76 | 18.43 | 144.825 | 21.61 | 30 | Pass |
| 6 | 2437 | 24.45 | 24.14 | 538.030 | 27.31 | 30 | Pass |
| 11 | 2462 | 17.53 | 17.52 | 113.118 | 20.54 | 30 | Pass |

802.11n (HT20)

| Chan. | Freq. (MHz) | Average Power (dBm) | | Total Power (mW) | Total Power (dBm) | Limit (dBm) | Pass / Fail |
|-------|-------------|---------------------|---------|------------------|-------------------|-------------|-------------|
| | | Chain 0 | Chain 1 | | | | |
| 1 | 2412 | 17.76 | 17.46 | 115.423 | 20.62 | 30 | Pass |
| 6 | 2437 | 24.24 | 23.79 | 504.793 | 27.03 | 30 | Pass |
| 11 | 2462 | 16.80 | 16.53 | 92.841 | 19.68 | 30 | Pass |

802.11n (HT40)

| Chan. | Freq. (MHz) | Average Power (dBm) | | Total Power (mW) | Total Power (dBm) | Limit (dBm) | Pass / Fail |
|-------|-------------|---------------------|---------|------------------|-------------------|-------------|-------------|
| | | Chain 0 | Chain 1 | | | | |
| 3 | 2422 | 16.35 | 15.95 | 82.507 | 19.16 | 30 | Pass |
| 6 | 2437 | 18.59 | 18.40 | 141.460 | 21.51 | 30 | Pass |
| 9 | 2452 | 14.92 | 14.78 | 61.107 | 17.86 | 30 | Pass |

4.5 Power Spectral Density Measurement

4.5.1 Limits of Power Spectral Density Measurement

The Maximum of Power Spectral Density Measurement is 8dBm.

4.5.2 Test Setup

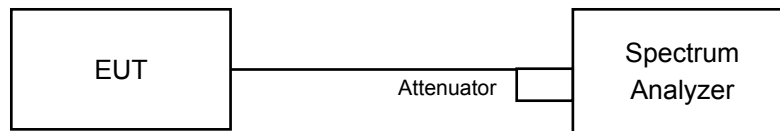

4.5.3 Test Instruments

Refer to section 4.1.2 to get information of above instrument.

4.5.4 Test Procedure

For AVG. power (duty cycle $\geq 98\%$)

- Set instrument center frequency to DTS channel center frequency.
- Set span to at least 1.5 times the OBW.
- Set RBW to: $3 \text{ kHz} \leq \text{RBW} \leq 100 \text{ kHz}$.
- Set VBW $\geq 3 \times \text{RBW}$.
- Detector = power averaging (RMS) or sample detector (when RMS not available).
- Ensure that the number of measurement points in the sweep $\geq 2 \times \text{span}/\text{RBW}$.
- Sweep time = auto couple.
- Employ trace averaging (RMS) mode over a minimum of 100 traces.
- Use the peak marker function to determine the maximum amplitude level.

For AVG. power (duty cycle $< 98\%$)

- Measure the duty cycle (x).
- Set instrument center frequency to DTS channel center frequency.
- Set span to at least 1.5 times the OBW.
- Set RBW to: $3 \text{ kHz} \leq \text{RBW} \leq 100 \text{ kHz}$.
- Set VBW $\geq 3 \times \text{RBW}$.
- Detector = power averaging (RMS) or sample detector (when RMS not available).
- Ensure that the number of measurement points in the sweep $\geq 2 \times \text{span}/\text{RBW}$.
- Sweep time = auto couple.
- Do not use sweep triggering. Allow sweep to "free run".
- Employ trace averaging (RMS) mode over a minimum of 100 traces.
- Use the peak marker function to determine the maximum amplitude level.
- Add $10 \log(1/x)$, where x is the duty cycle measured in step (a), to the measured PSD to compute the average PSD during the actual transmission time.

4.5.5 Deviation from Test Standard

No deviation.

4.5.6 EUT Operating Condition

Same as item 4.3.6

4.5.7 Test Results

802.11b

| TX chain | Channel | Freq. (MHz) | PSD (dBm) | 10 log (N=2) dB | Total PSD (dBm) | Limit (dBm) | Pass/Fail |
|----------|---------|-------------|-----------|-----------------|-----------------|-------------|-----------|
| 0 | 1 | 2412 | -4.46 | 3.01 | -1.45 | 6.07 | Pass |
| | 6 | 2437 | -2.81 | 3.01 | 0.20 | 6.07 | Pass |
| | 11 | 2462 | -5.77 | 3.01 | -2.76 | 6.07 | Pass |
| 1 | 1 | 2412 | -5.38 | 3.01 | -2.37 | 6.07 | Pass |
| | 6 | 2437 | -3.48 | 3.01 | -0.47 | 6.07 | Pass |
| | 11 | 2462 | -6.57 | 3.01 | -3.56 | 6.07 | Pass |

Note:

- Method 1 of power density measurement of KDB 662911 is using for calculating total power density. Total power density is summing entire spectra across corresponding frequency bins on the various outputs by computer.
- Directional gain = $4.92\text{dBi} + 10\log(2) = 7.93\text{dBi} > 6\text{dBi}$, so the limit shall be reduced to $8-(7.93-6) = 6.07\text{dBm}$.

802.11g

| TX chain | Channel | Freq. (MHz) | PSD (dBm) | 10 log (N=2) dB | Duty Factor | Total PSD with Duty Factor (dBm) | Limit (dBm) | Pass/Fail |
|----------|---------|-------------|-----------|-----------------|-------------|----------------------------------|-------------|-----------|
| 0 | 1 | 2412 | -12.41 | 3.01 | 0.10 | -9.30 | 6.07 | Pass |
| | 6 | 2437 | -6.40 | 3.01 | 0.10 | -3.29 | 6.07 | Pass |
| | 11 | 2462 | -13.25 | 3.01 | 0.10 | -10.14 | 6.07 | Pass |
| 1 | 1 | 2412 | -13.07 | 3.01 | 0.10 | -9.96 | 6.07 | Pass |
| | 6 | 2437 | -6.83 | 3.01 | 0.10 | -3.72 | 6.07 | Pass |
| | 11 | 2462 | -13.80 | 3.01 | 0.10 | -10.69 | 6.07 | Pass |

Note:

- Method 1 of power density measurement of KDB 662911 is using for calculating total power density. Total power density is summing entire spectra across corresponding frequency bins on the various outputs by computer.
- Directional gain = $4.92\text{dBi} + 10\log(2) = 7.93\text{dBi} > 6\text{dBi}$, so the limit shall be reduced to $8-(7.93-6) = 6.07\text{dBm}$.
- Refer to section 3.3 for duty cycle spectrum plot.

802.11n (HT20)

| TX chain | Channel | Freq. (MHz) | PSD (dBm) | 10 log (N=2) dB | Total PSD (dBm) | Limit (dBm) | Pass/Fail |
|----------|---------|-------------|-----------|-----------------|-----------------|-------------|-----------|
| 0 | 1 | 2412 | -14.26 | 3.01 | -11.25 | 6.07 | Pass |
| | 6 | 2437 | -7.42 | 3.01 | -4.41 | 6.07 | Pass |
| | 11 | 2462 | -15.01 | 3.01 | -12.00 | 6.07 | Pass |
| 1 | 1 | 2412 | -15.01 | 3.01 | -12.00 | 6.07 | Pass |
| | 6 | 2437 | -7.76 | 3.01 | -4.75 | 6.07 | Pass |
| | 11 | 2462 | -15.52 | 3.01 | -12.51 | 6.07 | Pass |

Note:

- Method 1 of power density measurement of KDB 662911 is using for calculating total power density. Total power density is summing entire spectra across corresponding frequency bins on the various outputs by computer.
- Directional gain = 4.92dBi + 10log(2) = 7.93dBi > 6dBi, so the limit shall be reduced to 8-(7.93-6) = 6.07dBm.

802.11n (HT40)

| TX chain | Channel | Freq. (MHz) | PSD (dBm) | 10 log (N=2) dB | Duty Factor | Total PSD with Duty Factor (dBm) | Limit (dBm) | Pass/Fail |
|----------|---------|-------------|-----------|-----------------|-------------|----------------------------------|-------------|-----------|
| 0 | 3 | 2422 | -18.71 | 3.01 | 0.20 | -15.50 | 6.07 | Pass |
| | 6 | 2437 | -15.07 | 3.01 | 0.20 | -11.86 | 6.07 | Pass |
| | 9 | 2452 | -20.11 | 3.01 | 0.20 | -16.90 | 6.07 | Pass |
| 1 | 3 | 2422 | -18.20 | 3.01 | 0.20 | -14.99 | 6.07 | Pass |
| | 6 | 2437 | -17.50 | 3.01 | 0.20 | -14.29 | 6.07 | Pass |
| | 9 | 2452 | -20.03 | 3.01 | 0.20 | -16.82 | 6.07 | Pass |

Note:

- Method 1 of power density measurement of KDB 662911 is using for calculating total power density. Total power density is summing entire spectra across corresponding frequency bins on the various outputs by computer.
- Directional gain = 4.92dBi + 10log(2) = 7.93dBi > 6dBi, so the limit shall be reduced to 8-(7.93-6) = 6.07dBm.
- Refer to section 3.3 for duty cycle spectrum plot.

Spectrum Plot of Worst Value

802.11b

802.11g

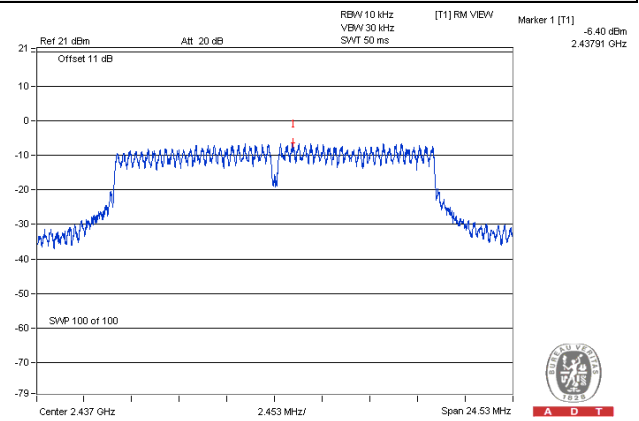
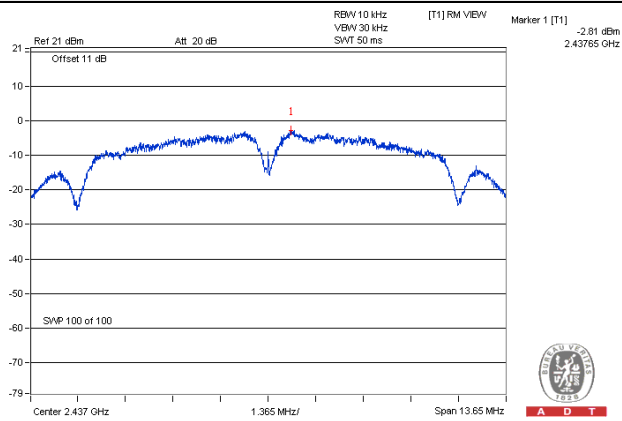

802.11n (HT20)

802.11n (HT40)

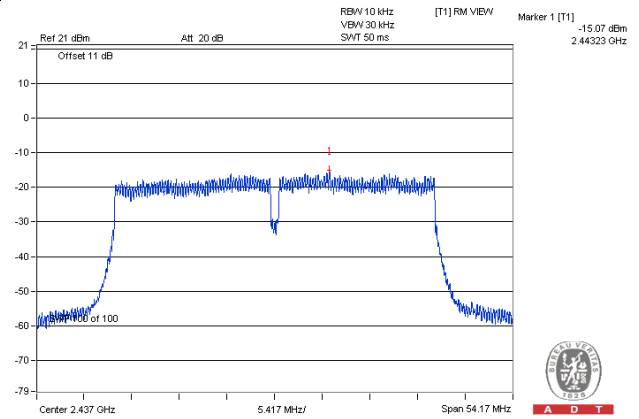
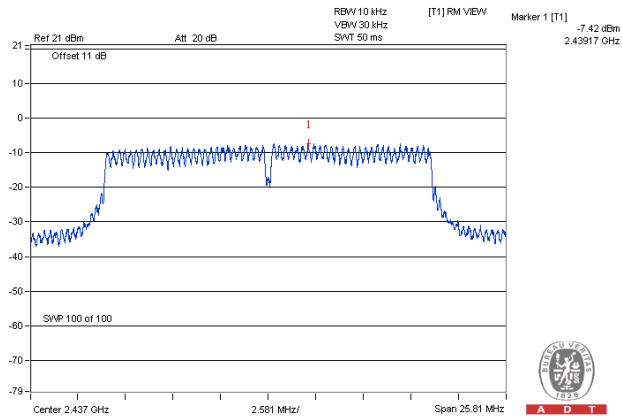

4.6 Conducted Out of Band Emission Measurement

4.6.1 Limits of Conducted Out of Band Emission Measurement

Below 30dB of the highest emission level of operating band (in 100kHz Resolution Bandwidth).

4.6.2 Test Setup

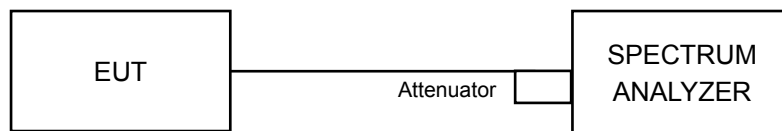

4.6.3 Test Instruments

Refer to section 4.1.2 to get information of above instrument.

4.6.4 Test Procedure

MEASUREMENT PROCEDURE REF

1. Set the RBW = 100 kHz.
2. Set the VBW \geq 300 kHz.
3. Detector = peak.
4. Sweep time = auto couple.
5. Trace mode = max hold.
6. Allow trace to fully stabilize.
7. Use the peak marker function to determine the maximum power level in any 100 kHz band segment within the fundamental EBW.

MEASUREMENT PROCEDURE OOB

1. Set RBW = 100 kHz.
2. Set VBW \geq 300 kHz.
3. Detector = peak.
4. Sweep = auto couple.
5. Trace Mode = max hold.
6. Allow trace to fully stabilize.
7. Use the peak marker function to determine the maximum amplitude level.

4.6.5 Deviation from Test Standard

No deviation.

4.6.6 EUT Operating Condition

Same as item 4.3.6

4.6.7 Test Results

The conducted emission test is performed on each TX port of operating mode without summing or adding 10log (N) since the limit is relative emission limit.

The spectrum plots are attached on the following pages. D1 line indicates the highest level, and D2 line indicates the 30dB offset below D1. It shows compliance with the requirement.

802.11b_CHAIN 0

CH 1

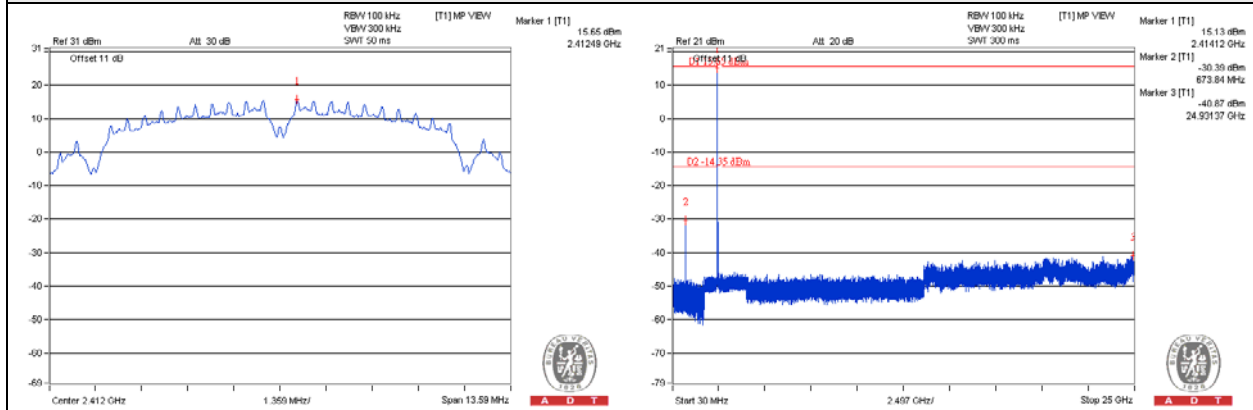

CH 6

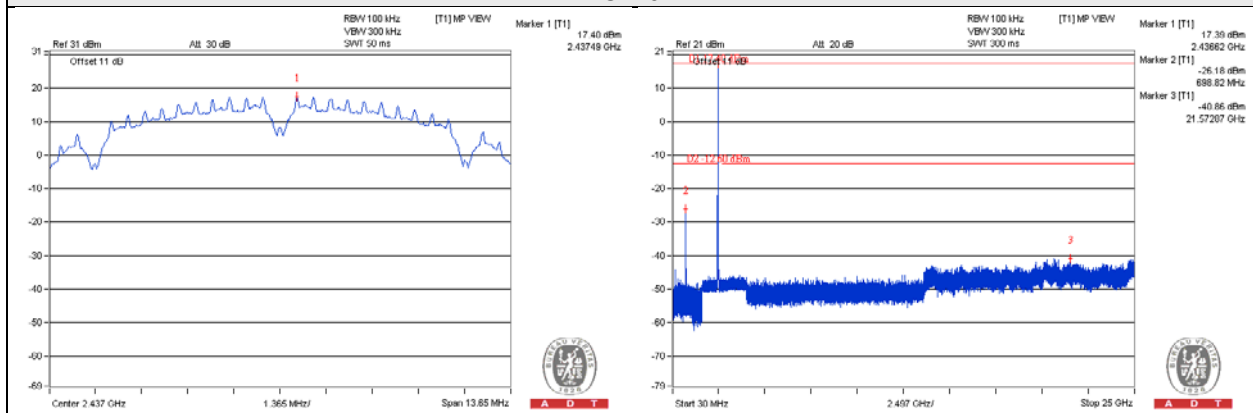

CH 11

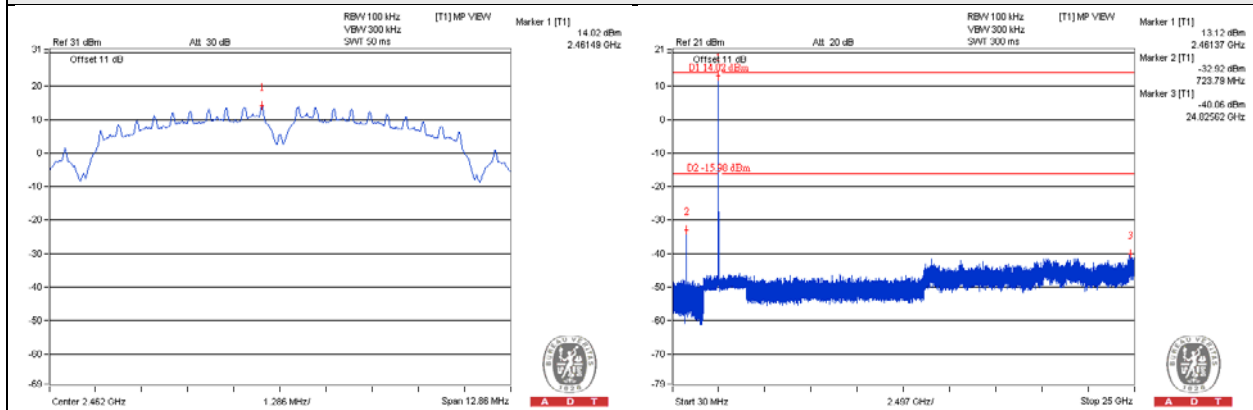

CH 1 Band edge

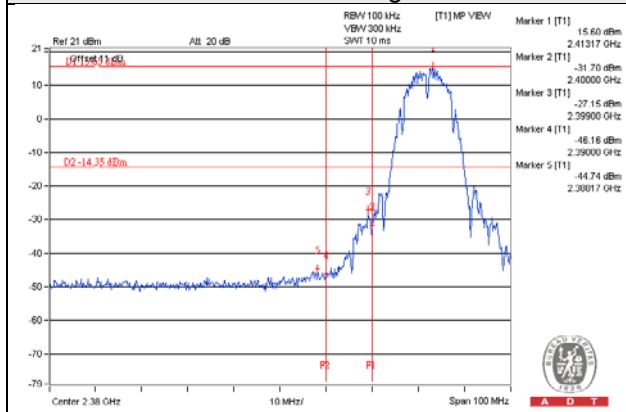

CH 11 Band edge

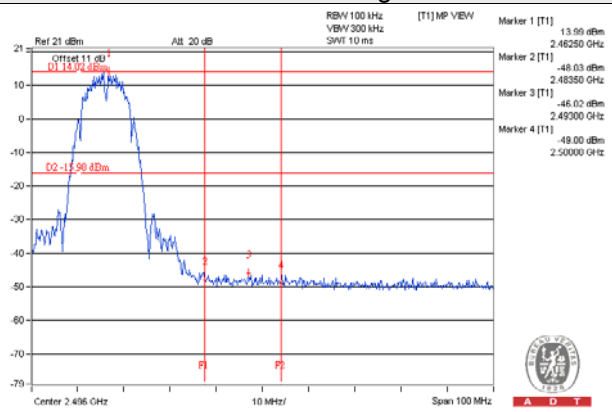

802.11b_CHAIN 1

CH 1

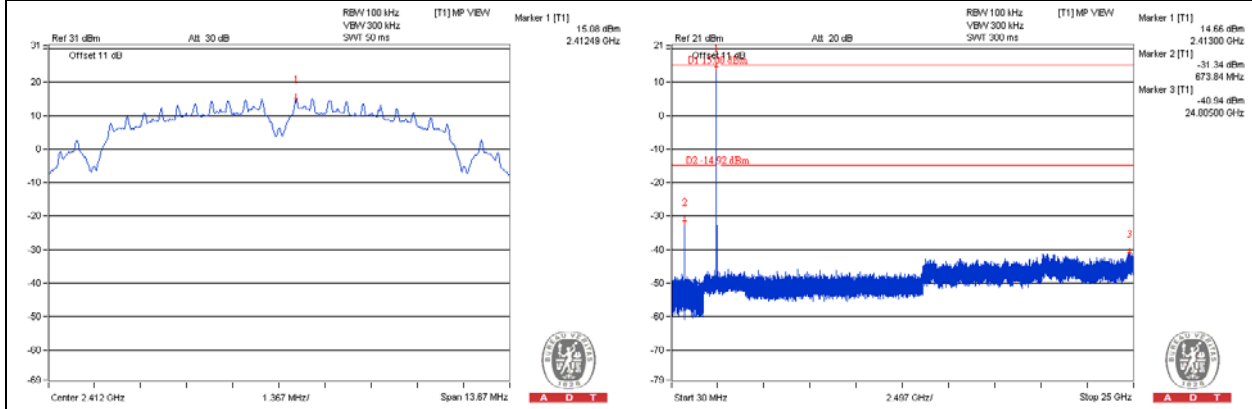

CH 6

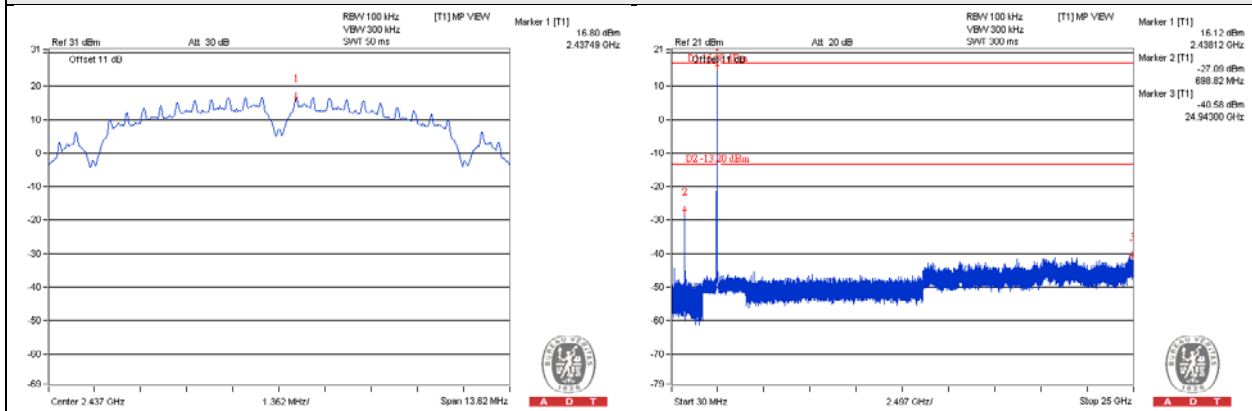

CH 11

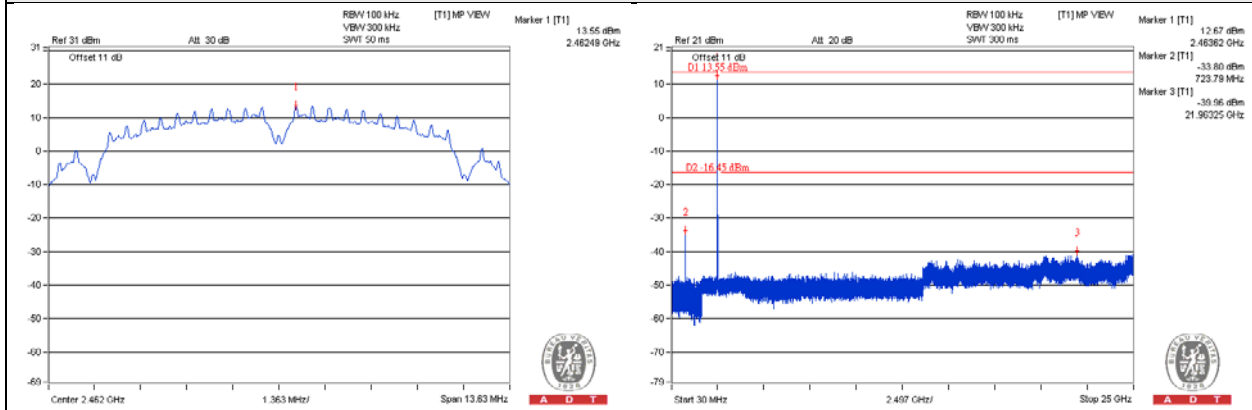

CH 1 Band edge

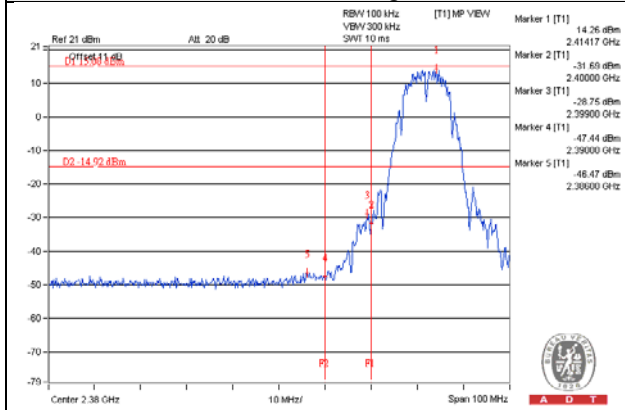

CH 11 Band edge

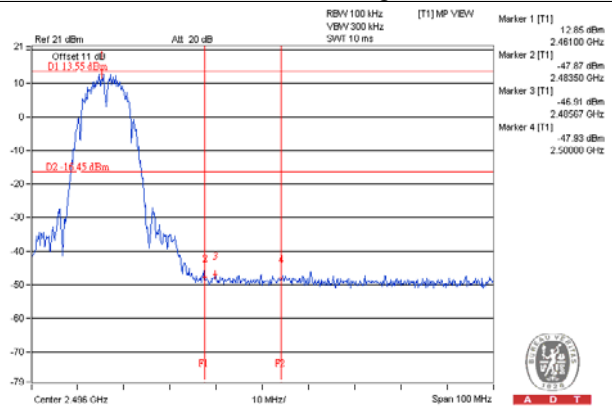

802.11g_CHAIN 0

CH 1

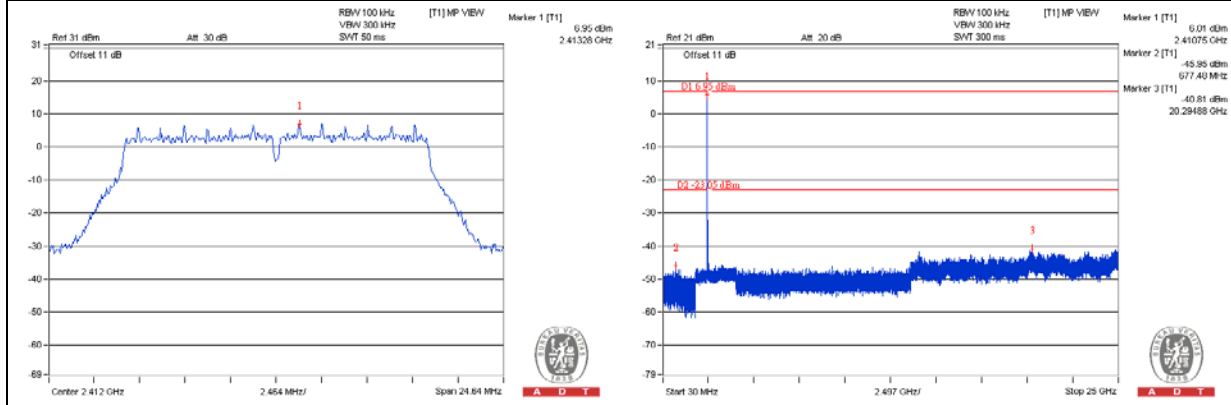

CH 6

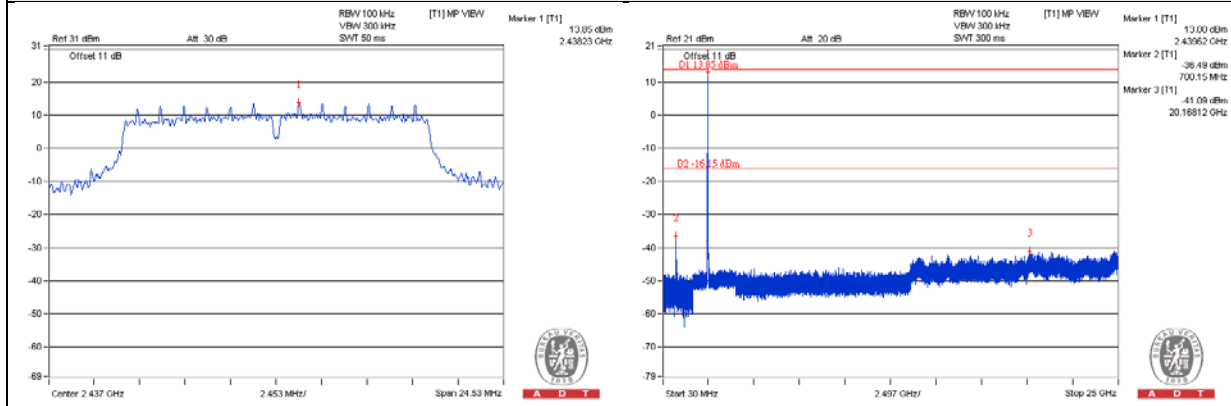

CH 11

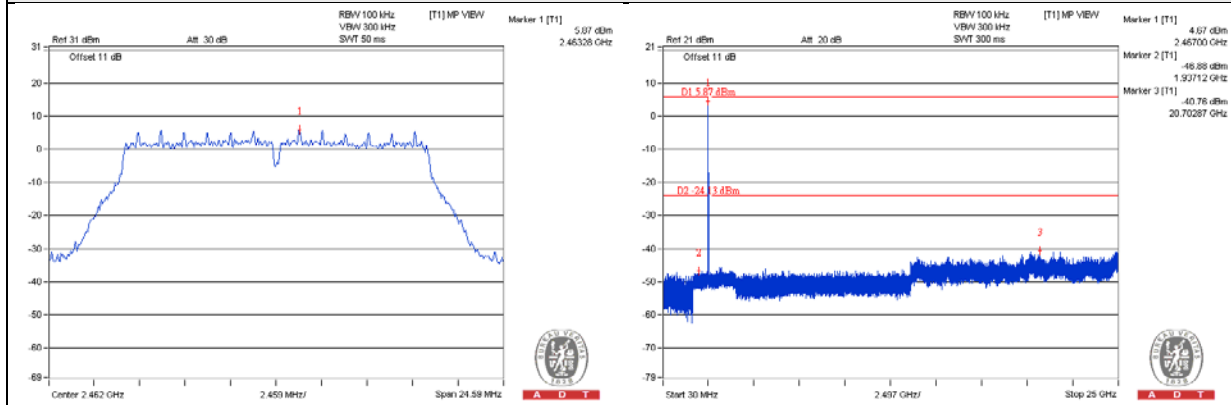

CH 1 Band edge

CH 11 Band edge

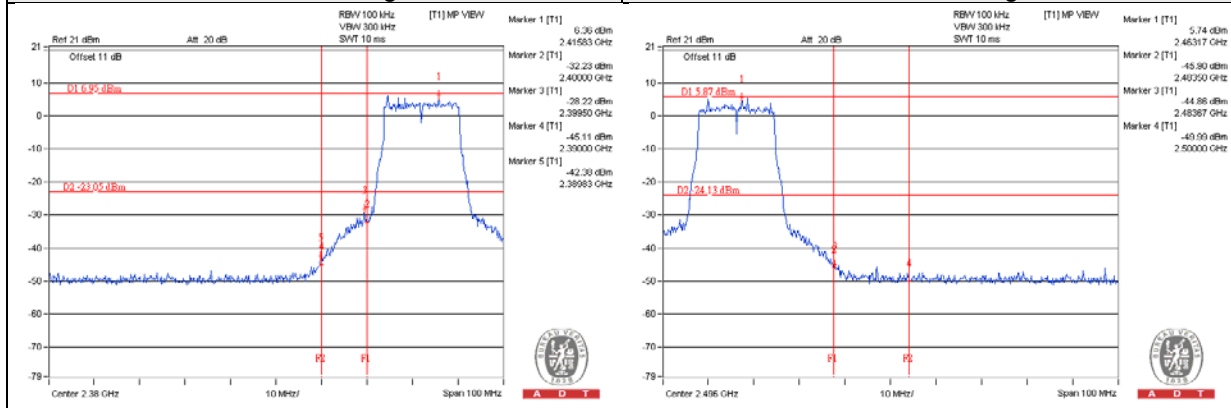

802.11g_CHAIN 1

CH 1

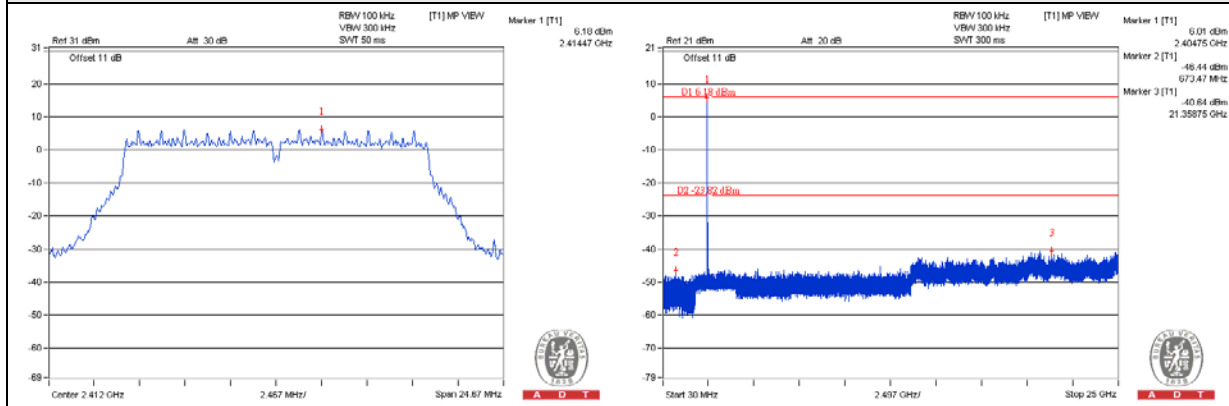

CH 6

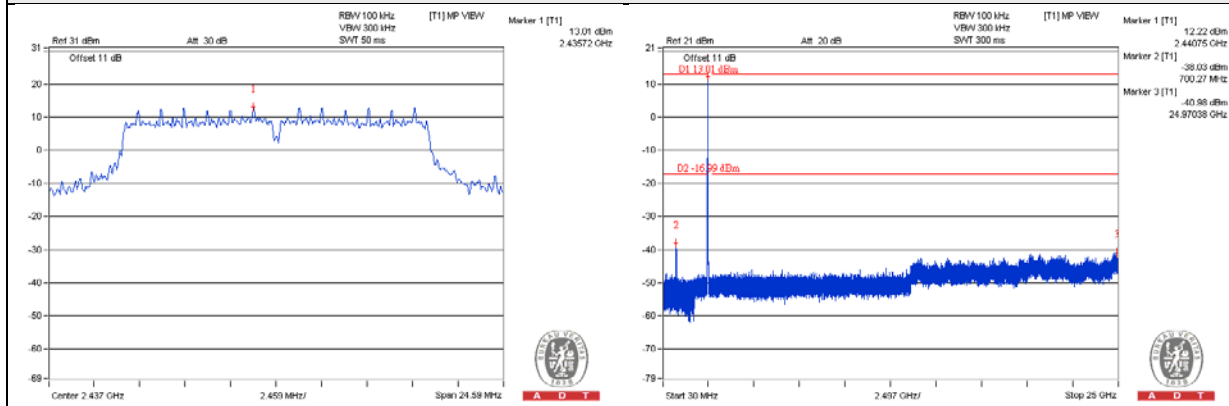

CH 11

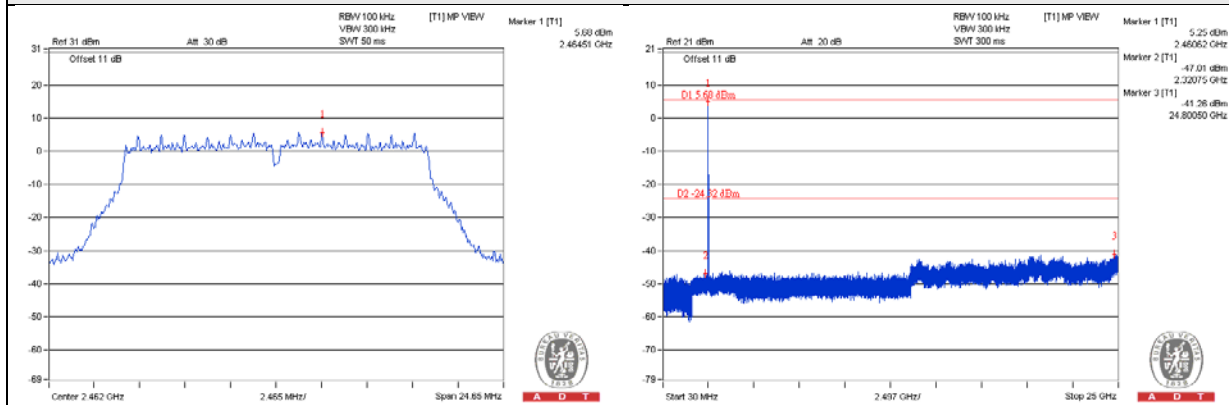

CH 1 Band edge

CH 11 Band edge

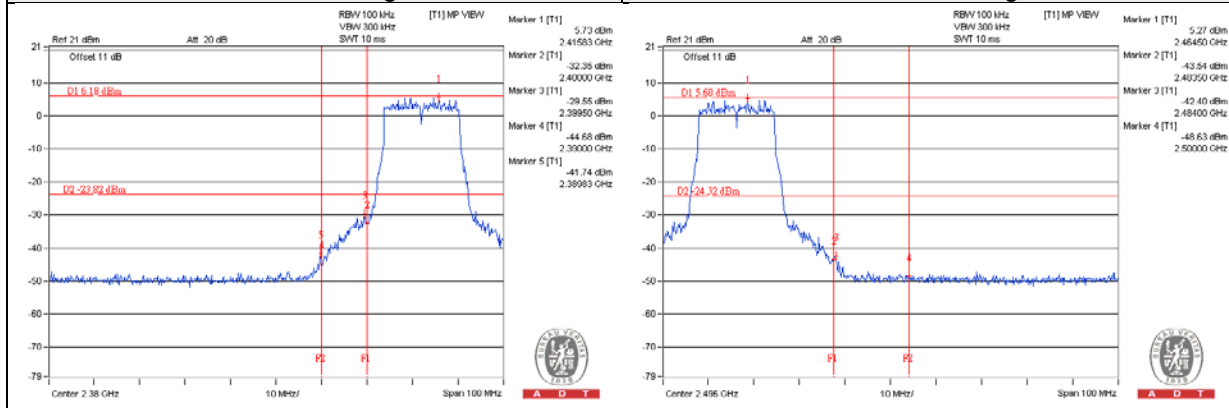

802.11n (HT20)_CHAIN 0

CH 1

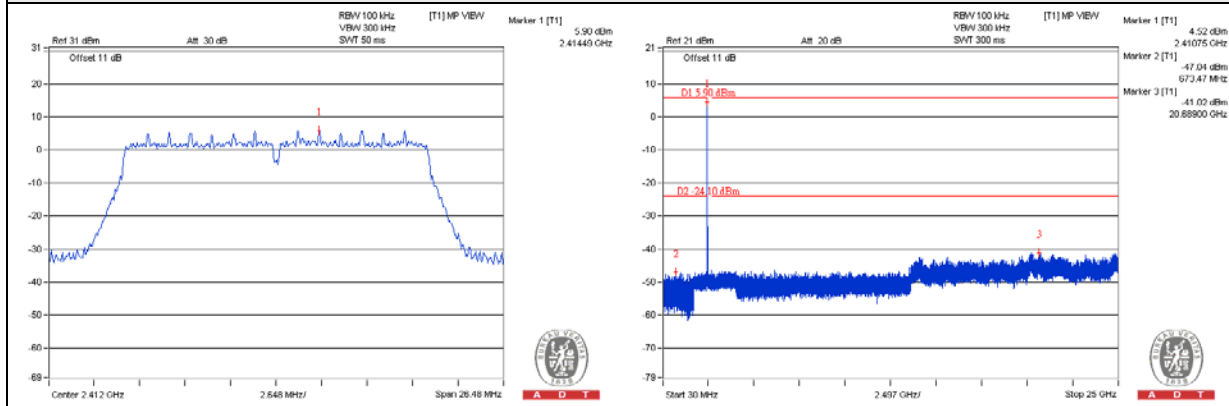

CH 6

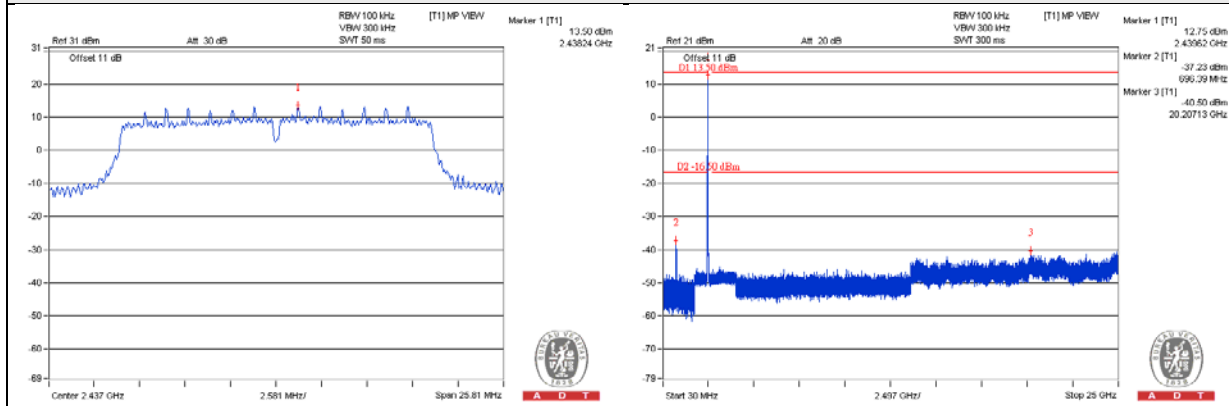

CH 11

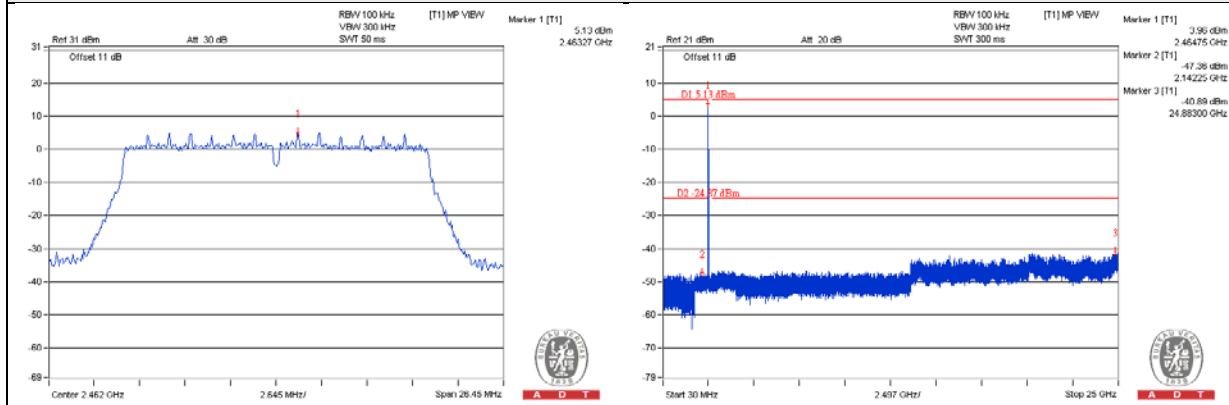

CH 1 Band edge

CH 11 Band edge

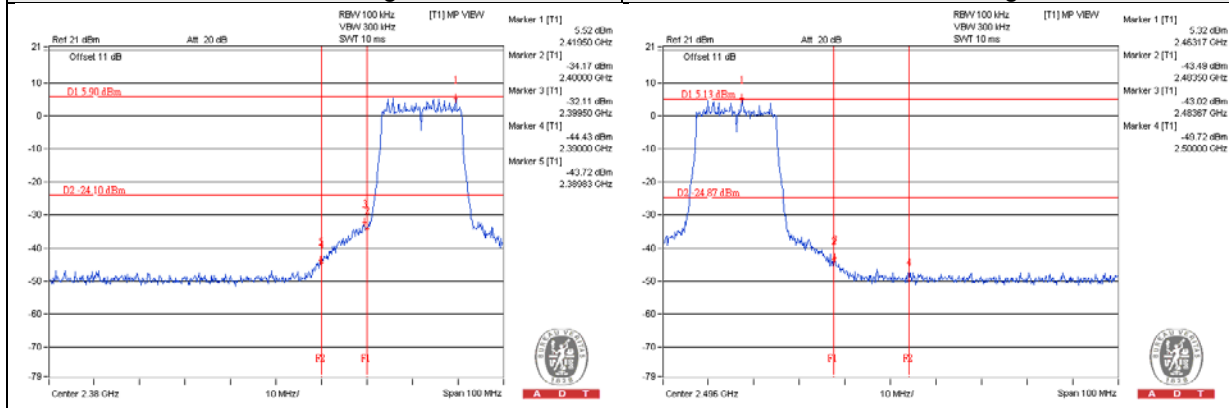

802.11n (HT20)_CHAIN 1

CH 1

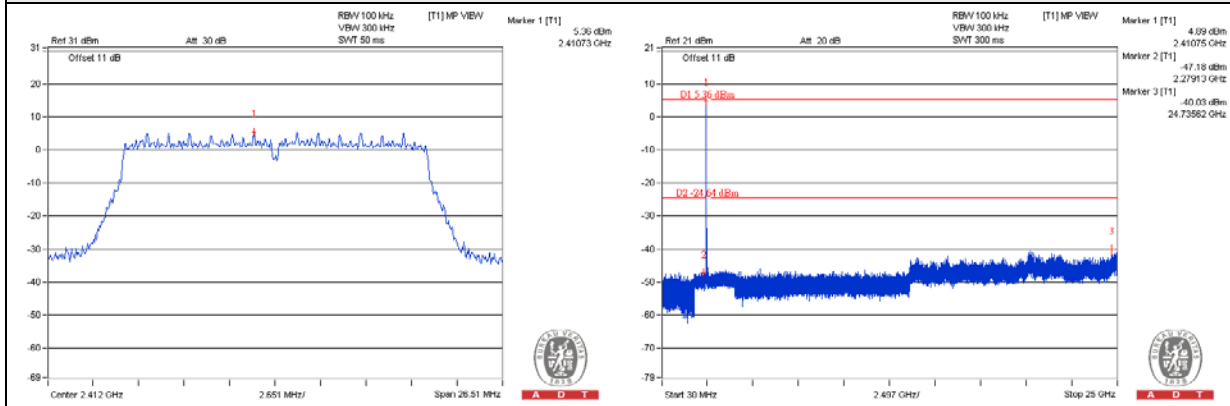

CH 6

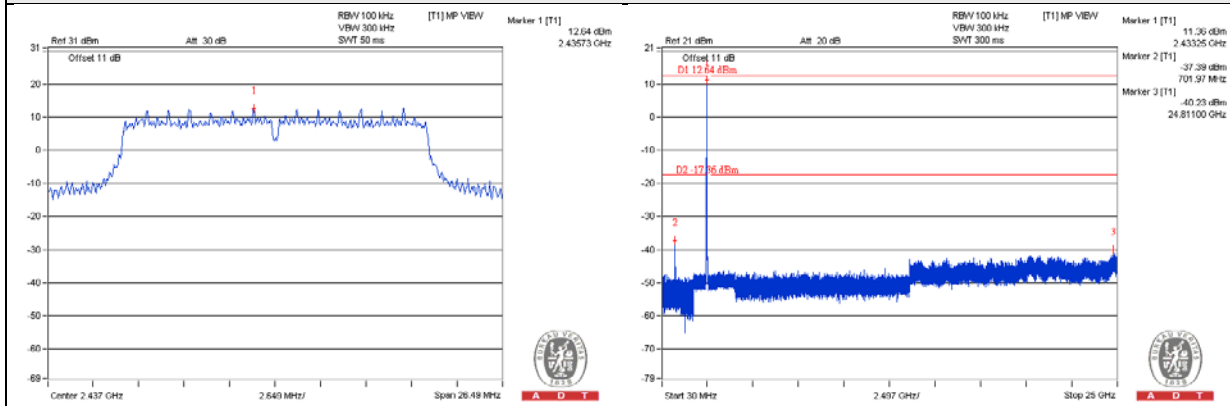

CH 11

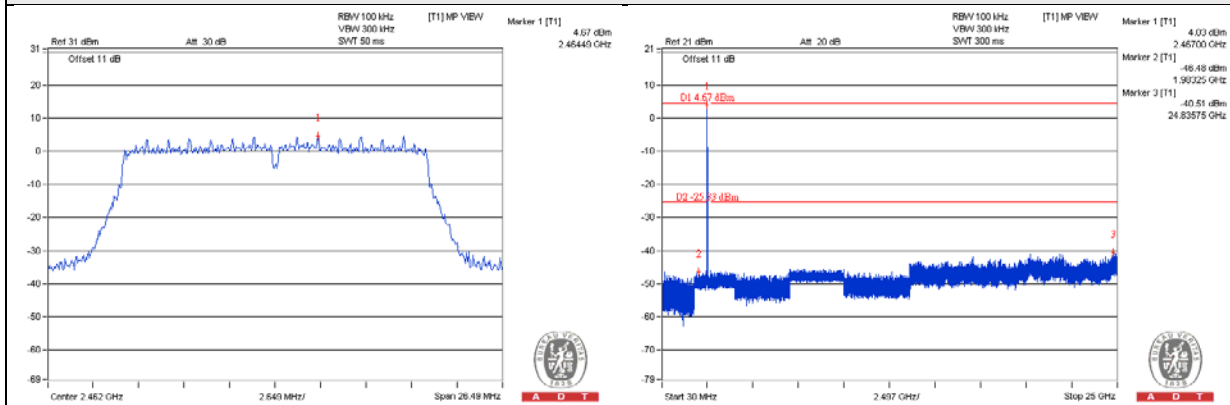

CH 1 Band edge

CH 11 Band edge

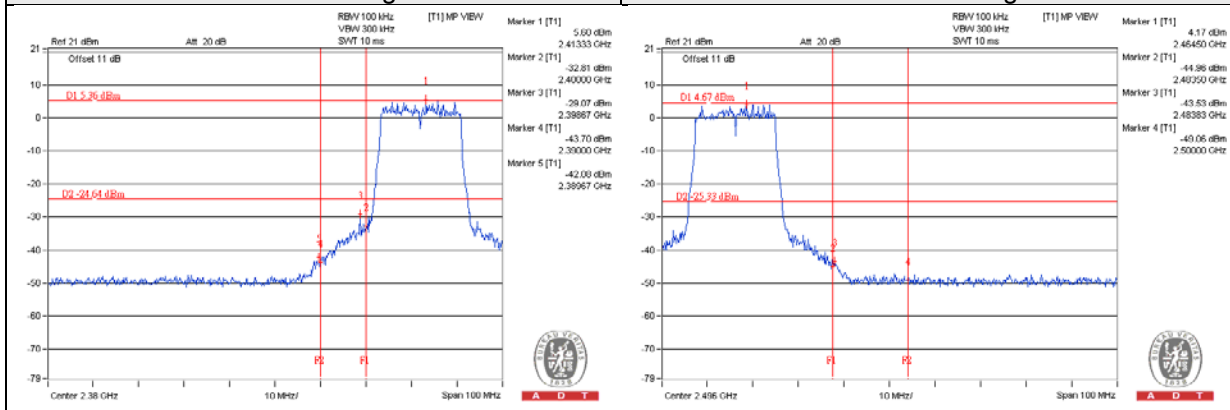

802.11n (HT40)_CHAIN 0

CH 3

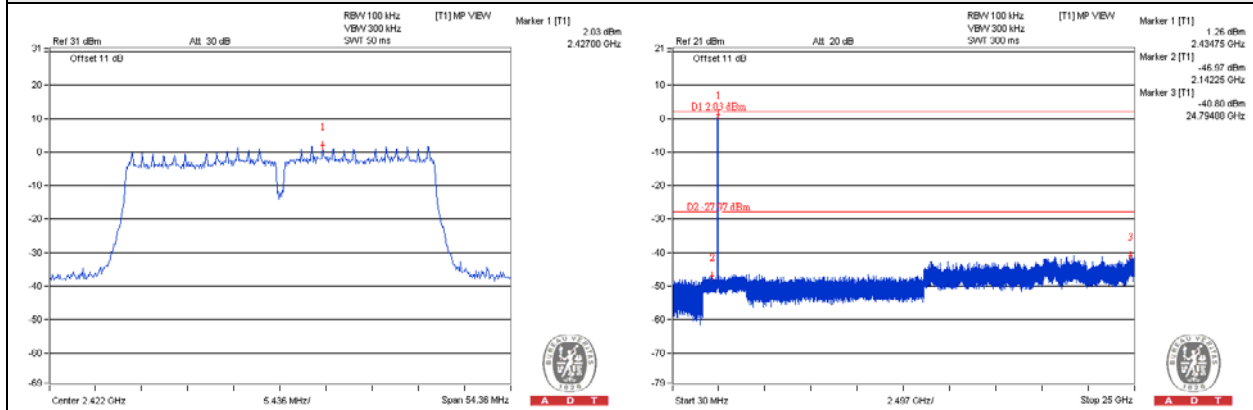

CH 6

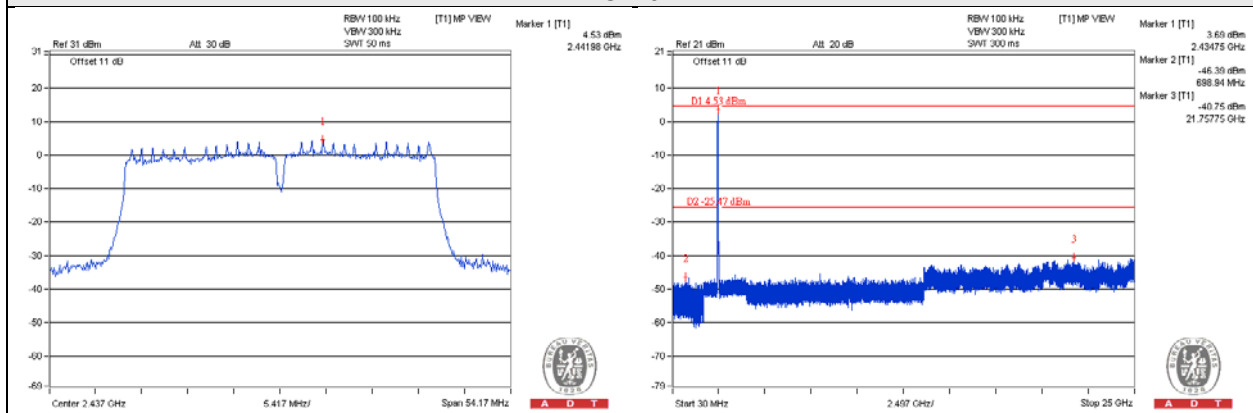

CH 9

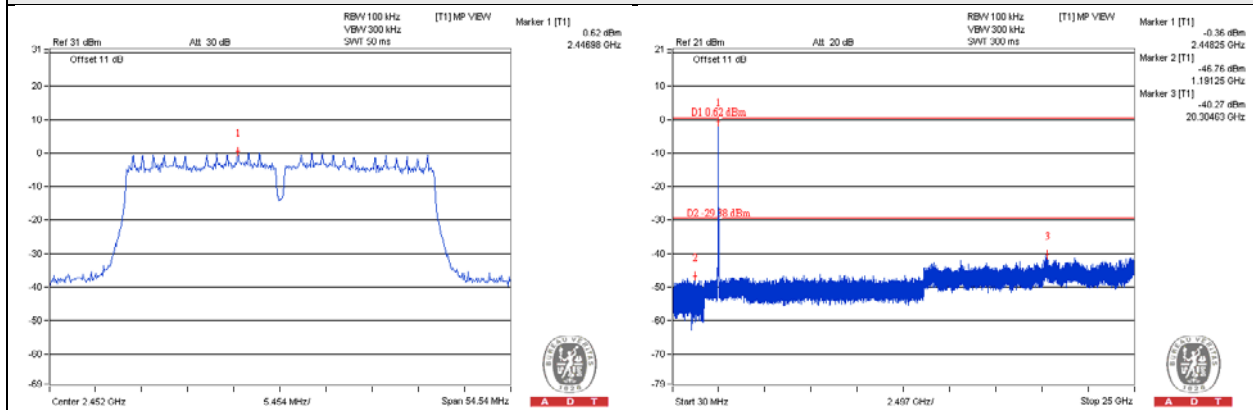

CH 3 Band edge

CH 9 Band edge

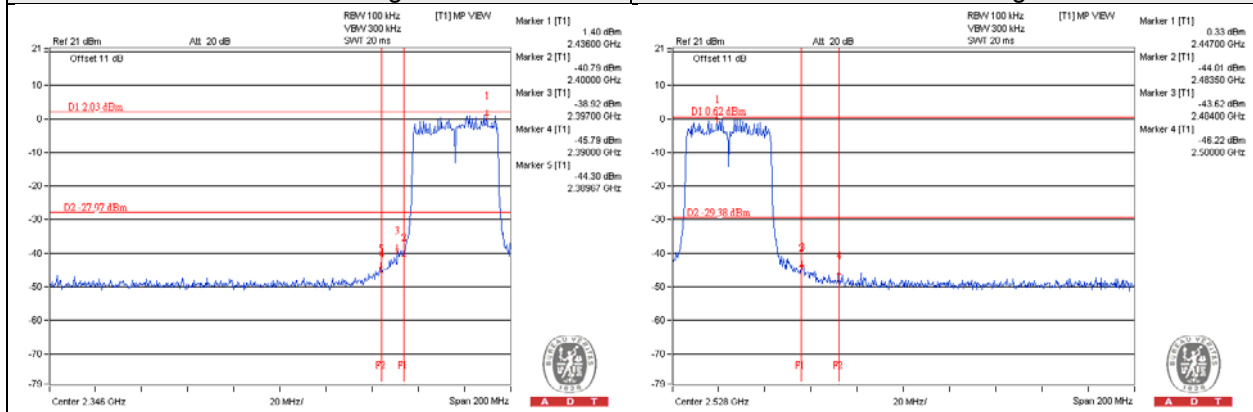

802.11n (HT40)_CHAIN 1

CH 3

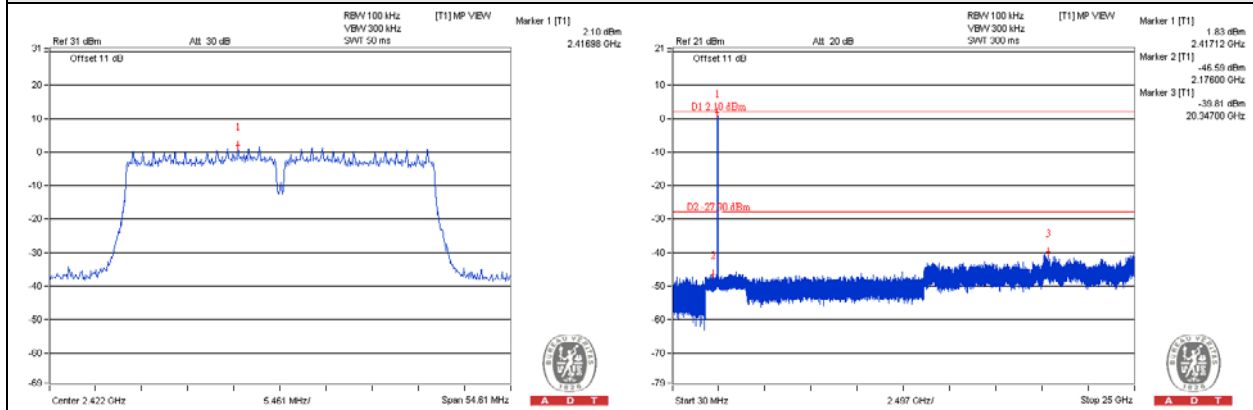

CH 6

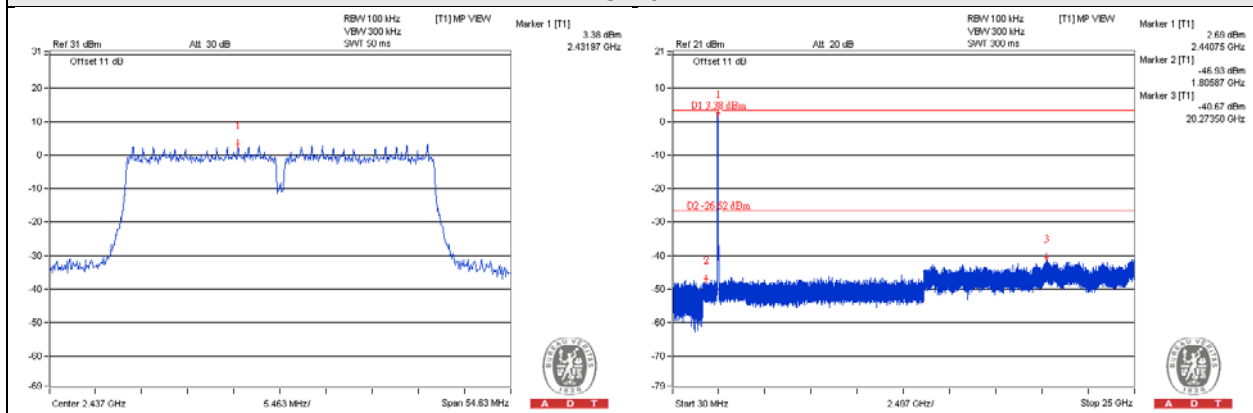

CH 9

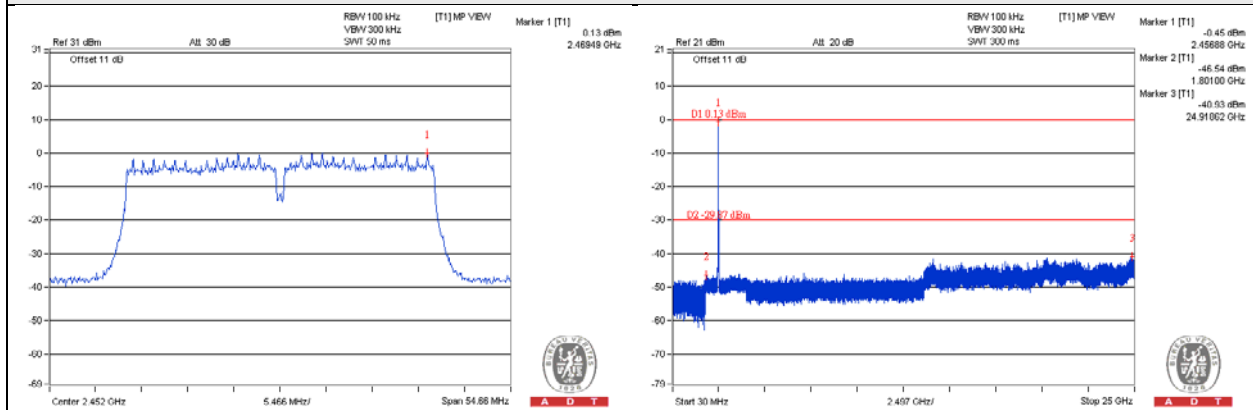

CH 3 Band edge

CH 9 Band edge

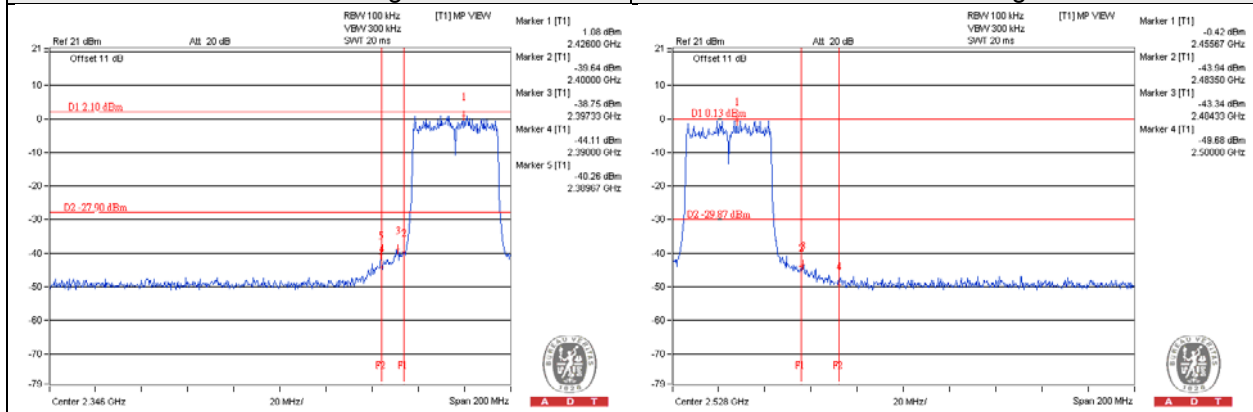

5 Pictures of Test Arrangements

Please refer to the attached file (Test Setup Photo).

Appendix – Information on the Testing Laboratories

We, Bureau Veritas Consumer Products Services (H.K.) Ltd., Taoyuan Branch, were founded in 1988 to provide our best service in EMC, Radio, Telecom and Safety consultation. Our laboratories are accredited and approved according to ISO/IEC 17025.

If you have any comments, please feel free to contact us at the following:

Linko EMC/RF Lab

Tel: 886-2-26052180

Fax: 886-2-26051924

Hsin Chu EMC/RF/Telecom Lab

Tel: 886-3-5935343

Fax: 886-3-5935342

Hwa Ya EMC/RF/Safety Lab

Tel: 886-3-3183232

Fax: 886-3-3270892

Email: service.adt@tw.bureauveritas.com

Web Site: www.bureauveritas-adt.com

The address and road map of all our labs can be found in our web site also.

--- END ---