

FCC Test Report (Co-Located)

Report No.: RF150825C34-2

FCC ID: KA2WL8710APA1

Test Model: DWL-8710AP

Received Date: Aug. 25, 2015

Test Date: Mar. 25 ~ Mar. 28, 2016

Issued Date: Mar. 30, 2016

Applicant: D-Link Corporation

Address: No.289, Xinhua 3rd Rd., Neihu District, Taipei City 11494, Taiwan, R.O.C.

Issued By: Bureau Veritas Consumer Products Services (H.K.) Ltd., Taoyuan Branch

Lab Address: No. 47-2, 14th Ling, Chia Pau Vil., Lin Kou Dist., New Taipei City, Taiwan

Test Location: No. 19, Hwa Ya 2nd Rd., Wen Hwa Vil., Kwei Shan Dist., Taoyuan City 33383, TAIWAN (R.O.C.)



This report is for your exclusive use. Any copying or replication of this report to or for any other person or entity, or use of our name or trademark, is permitted only with our prior written permission. This report sets forth our findings solely with respect to the test samples identified herein. The results set forth in this report are not indicative or representative of the quality or characteristics of the lot from which a test sample was taken or any similar or identical product unless specifically and expressly noted. Our report includes all of the tests requested by you and the results thereof based upon the information that you provided to us. You have 60 days from date of issuance of this report to notify us of any material error or omission caused by our negligence, provided, however, that such notice shall be in writing and shall specifically address the issue you wish to raise. A failure to raise such issue within the prescribed time shall constitute your unqualified acceptance of the completeness of this report, the tests conducted and the correctness of the report contents. Unless specific mention, the uncertainty of measurement has been explicitly taken into account to declare the compliance or non-compliance to the specification. The report must not be used by the client to claim product certification, approval, or endorsement by TAF or any government agencies.

Table of Contents

Release Control Record	3
1 Certificate of Conformity	4
2 Summary of Test Results	5
2.1 Measurement Uncertainty.....	5
2.2 Modification Record.....	5
3 General Information	6
3.1 General Description of EUT.....	6
3.2 Description of Test Modes.....	8
3.2.1 Test Mode Applicability and Tested Channel Detail.....	10
3.3 Description of Support Units.....	12
3.3.1 Configuration of System under Test.....	12
3.4 General Description of Applied Standard.....	13
4 Test Types and Results	14
4.1 Radiated Emission and Bandedge Measurement.....	14
4.1.1 Limits of Radiated Emission and Bandedge Measurement.....	14
4.1.2 Test Instruments.....	15
4.1.3 Test Procedure.....	16
4.1.4 Deviation from Test Standard.....	16
4.1.5 Test Setup.....	17
4.1.6 EUT Operating Conditions.....	17
4.1.7 Test Results.....	18
4.2 Conducted Emission Measurement.....	21
4.2.1 Limits of Conducted Emission Measurement.....	21
4.2.2 Test Instruments.....	21
4.2.3 Test Procedure.....	22
4.2.4 Deviation from Test Standard.....	22
4.2.5 Test Setup.....	22
4.2.6 EUT Operating Conditions.....	22
4.2.7 Test Results.....	23
5 Pictures of Test Arrangements	25
Appendix – Information on the Testing Laboratories	26



A D T

Release Control Record

Issue No.	Description	Date Issued
RF150825C34-2	Original release.	Mar. 30, 2016

1 Certificate of Conformity

Product: 802.11n/ac Unified Wireless Outdoor Access Point

Brand: D-Link

Test Model: DWL-8710AP

Sample Status: Engineering sample

Applicant: D-Link Corporation

Test Date: Mar. 25 ~ Mar. 28, 2016

Standard: 47 CFR FCC Part 15, Subpart C (Section 15.247)
47 CFR FCC Part 15, Subpart E (Section 15.407)
ANSI C63.10:2013

The above equipment has been tested by **Bureau Veritas Consumer Products Services (H.K.) Ltd., Taoyuan Branch**, and found compliance with the requirement of the above standards. The test record, data evaluation & Equipment Under Test (EUT) configurations represented herein are true and accurate accounts of the measurements of the sample's EMC characteristics under the Conditions specified in this report.

Prepared by :

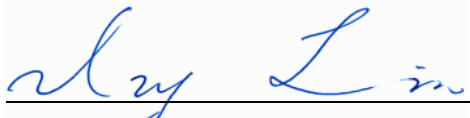
Ivy Lin / Specialist

Date:

Mar. 30, 2016

Approved by :

Ken Liu / Senior Manager

Date:

Mar. 30, 2016

2 Summary of Test Results

47 CFR FCC Part 15, Subpart C (Section 15.247) 47 CFR FCC Part 15, Subpart E (Section 15.407)			
FCC Clause	Test Item	Result	Remarks
15.207 15.407(b)(6)	AC Power Conducted Emissions	PASS	Meet the requirement of limit. Minimum passing margin is -2.56dB at 0.43106MHz.
15.205 / 15.209 / 15.247(d) 15.407(b) (1/2/3/4/6)	Radiated Emissions	PASS	Meet the requirement of limit. Minimum passing margin is -1.2dB at 2483.50MHz.

2.1 Measurement Uncertainty

Where relevant, the following measurement uncertainty levels have been estimated for tests performed on the EUT as specified in CISPR 16-4-2:

Measurement	Frequency	Expanded Uncertainty (k=2) (±)
Conducted Emissions at mains ports	150kHz ~ 30MHz	2.44 dB
Radiated Emissions up to 1 GHz	30MHz ~ 200MHz	3.86 dB
	200MHz ~ 1000MHz	3.87 dB
Radiated Emissions above 1 GHz	1GHz ~ 18GHz	2.29 dB
	18GHz ~ 40GHz	2.29 dB

2.2 Modification Record

There were no modifications required for compliance.

3 General Information

3.1 General Description of EUT

Product	802.11n/ac Unified Wireless Outdoor Access Point
Brand	D-Link
Test Model	DWL-8710AP
Status of EUT	Engineering sample
Power Supply Rating	54Vdc (POE)
Modulation Type	CCK, DQPSK, DBPSK for DSSS 256QAM, 64QAM, 16QAM, QPSK, BPSK for OFDM
Modulation Technology	DSSS, OFDM
Transfer Rate	802.11b: 11.0/ 5.5/ 2.0/ 1.0Mbps 802.11g: 54.0/ 48.0/ 36.0/ 24.0/ 18.0/ 12.0/ 9.0/ 6.0Mbps 802.11a: 54.0/ 48.0/ 36.0/ 24.0/ 18.0/ 12.0/ 9.0/ 6.0Mbps 802.11n: up to 300.0Mbps 802.11ac: up to 867Mbps
Operating Frequency	2412 ~ 2462MHz, 5180 ~ 5240MHz & 5745 ~ 5825MHz
Number of Channel	2412 ~ 2462MHz: 11 for 802.11b, 802.11g, 802.11n (HT20) 7 for 802.11n (HT40) 5180 ~ 5240MHz: 4 for 802.11a, 802.11n (HT20), 802.11ac (VHT20) 2 for 802.11n (HT40), 802.11ac (VHT40) 1 for 802.11ac (VHT80) 5745 ~ 5825MHz: 5 for 802.11a, 802.11n (HT20), 802.11ac (VHT20) 2 for 802.11n (HT40), 802.11ac (VHT40) 1 for 802.11ac (VHT80)
Output Power	2412 ~ 2462MHz: 746.74mW 5180 ~ 5240MHz: 119.43mW 5745 ~ 5825MHz: 238.289mW
Antenna Type	2.4GHz: Dipole antenna with 4.92dBi gain 5GHz: Dipole antenna with 6.92dBi gain
Antenna Connector	N-TYPE (The device is professionally installed)
Accessory Device	POE, POE's adapter
Data Cable Supplied	1.75m non-shielded ground cable

Note:

1. The EUT incorporates a MIMO function. Physically, the EUT provides 2 completed transmitters and 2 receivers.

Modulation Mode	TX Function
802.11b	2TX
802.11g	2TX
802.11a	2TX
802.11n (HT20)	2TX
802.11n (HT40)	2TX
802.11ac (VHT20)	2TX
802.11ac (VHT40)	2TX
802.11ac (VHT80)	2TX

* The modulation and bandwidth are similar between 802.11n mode for HT20 / HT40 and 802.11ac mode for VHT20 / VHT40, and therefore investigated worst case to representative mode in test report. (Final test mode refer section 3.2.1)

2. The EUT will install at outdoor area, the highest antenna gain from the horizon above 30 degrees as below, for more detail information please refer to antenna specification and user manual.

Antenna	Antenna gain	Antenna install degree
Dipole	-2.33dBi	

3. The EUT uses following POE.

POE	
Brand	D-Link
Model	DPE-301GI
Rating	54Vdc, 0.6A
POE's adapter	
Brand	Gospell Digital Technology Co., Ltd.
Model	G0753-540-060
Input Power	100-240Vac, 0.75A MAX, 50/60Hz
Output Power	54Vdc, 0.6A
Power Line	1.45m DC cable without core attached on adapter

3.2 Description of Test Modes

FOR 2.4GHz

11 channels are provided for 802.11b, 802.11g and 802.11n (HT20):

Channel	Frequency	Channel	Frequency
1	2412MHz	7	2442MHz
2	2417MHz	8	2447MHz
3	2422MHz	9	2452MHz
4	2427MHz	10	2457MHz
5	2432MHz	11	2462MHz
6	2437MHz		

7 channels are provided for 802.11n (HT40):

Channel	Frequency	Channel	Frequency
3	2422MHz	7	2442MHz
4	2427MHz	8	2447MHz
5	2432MHz	9	2452MHz
6	2437MHz		

FOR 5180 ~ 5240MHz

4 channels are provided for 802.11a, 802.11n (HT20), 802.11ac (VHT20):

Channel	Frequency	Channel	Frequency
36	5180 MHz	44	5220 MHz
40	5200 MHz	48	5240 MHz

2 channels are provided for 802.11n (HT40), 802.11ac (40MHz):

Channel	Frequency	Channel	Frequency
38	5190 MHz	46	5230 MHz

1 channel is provided for 802.11ac (VHT80):

Channel	Frequency
42	5210MHz

FOR 5745 ~ 5825MHz:

5 channels are provided for 802.11a, 802.11n (HT20), 802.11ac (VHT20):

Channel	Frequency	Channel	Frequency
149	5745MHz	161	5805MHz
153	5765MHz	165	5825MHz
157	5785MHz		

2 channels are provided for 802.11n (HT40), 802.11ac (VHT40):

Channel	Frequency	Channel	Frequency
151	5755MHz	159	5795MHz

1 channel is provided for 802.11ac (VHT80):

Channel	Frequency
155	5775MHz

3.2.1 Test Mode Applicability and Tested Channel Detail

EUT CONFIGURE MODE	APPLICABLE TO			DESCRIPTION
	RE \geq 1G	RE<1G	PLC	
-	√	√	√	-

Where **RE \geq 1G**: Radiated Emission above 1GHz **RE<1G**: Radiated Emission below 1GHz
PLC: Power Line Conducted Emission

Note: The EUT had been pre-tested on the positioned of each 3 axis. The worst case was found when positioned on **Z-plane**.

Radiated Emission Test (Above 1GHz):

- Pre-Scan has been conducted to determine the worst-case mode from all possible combinations between available modulations, data rates and antenna ports (if EUT with antenna diversity architecture).
- Following channel(s) was (were) selected for the final test as listed below.

EUT CONFIGURE MODE	MODE	FREQ. BAND (MHz)	AVAILABLE CHANNEL	TESTED CHANNEL	MODULATION TECHNOLOGY	MODULATION TYPE
-	802.11g	2412-2462	1 to 11	6	OFDM	BPSK
-	802.11n (HT20)	5180-5240, 5745-5825	36 to 48, 149 to 165	157	OFDM	BPSK

Radiated Emission Test (Below 1GHz):

- Pre-Scan has been conducted to determine the worst-case mode from all possible combinations between available modulations, data rates and antenna ports (if EUT with antenna diversity architecture).
- Following channel(s) was (were) selected for the final test as listed below.

EUT CONFIGURE MODE	MODE	FREQ. BAND (MHz)	AVAILABLE CHANNEL	TESTED CHANNEL	MODULATION TECHNOLOGY	MODULATION TYPE
-	802.11g	2412-2462	1 to 11	6	OFDM	BPSK
-	802.11n (HT20)	5180-5240, 5745-5825	36 to 48, 149 to 165	157	OFDM	BPSK

Power Line Conducted Emission Test:

- Pre-Scan has been conducted to determine the worst-case mode from all possible combinations between available modulations, data rates and antenna ports (if EUT with antenna diversity architecture).
- Following channel(s) was (were) selected for the final test as listed below.

EUT CONFIGURE MODE	MODE	FREQ. BAND (MHz)	AVAILABLE CHANNEL	TESTED CHANNEL	MODULATION TECHNOLOGY	MODULATION TYPE
-	802.11g	2412-2462	1 to 11	6	OFDM	BPSK
-	802.11n (HT20)	5180-5240, 5745-5825	36 to 48, 149 to 165	157	OFDM	BPSK

Test Condition:

APPLICABLE TO	ENVIRONMENTAL CONDITIONS	INPUT POWER	TESTED BY
RE \geq 1G	18deg. C, 70%RH	120Vac, 60Hz	Match Tsui
RE<1G	24deg. C, 64%RH	120Vac, 60Hz	Match Tsui
PLC	24deg. C, 64%RH	120Vac, 60Hz	Match Tsui

3.3 Description of Support Units

The EUT has been tested as an independent unit together with other necessary accessories or support units. The following support units or accessories were used to form a representative test configuration during the tests.

ID	Product	Brand	Model No.	Serial No.	FCC ID	Remarks
A.	Load	NA	NA	NA	NA	-
B.	Notebook	DELL	E5410	1HC2XM1	FCC DoC Approved	-

Note:

1. All power cords of the above support units are non-shielded (1.8m).
2. Item B acted as a communication partner to transfer data.

ID	Descriptions	Qty.	Length (m)	Shielding (Yes/No)	Cores (Qty.)	Remarks
1.	RJ45	1	1.8	N	0	-
2.	RJ45	1	1.8	N	0	-
3.	RJ45	1	5	N	0	-
4.	Ground	1	1.75	N	0	Accessory of EUT

3.3.1 Configuration of System under Test

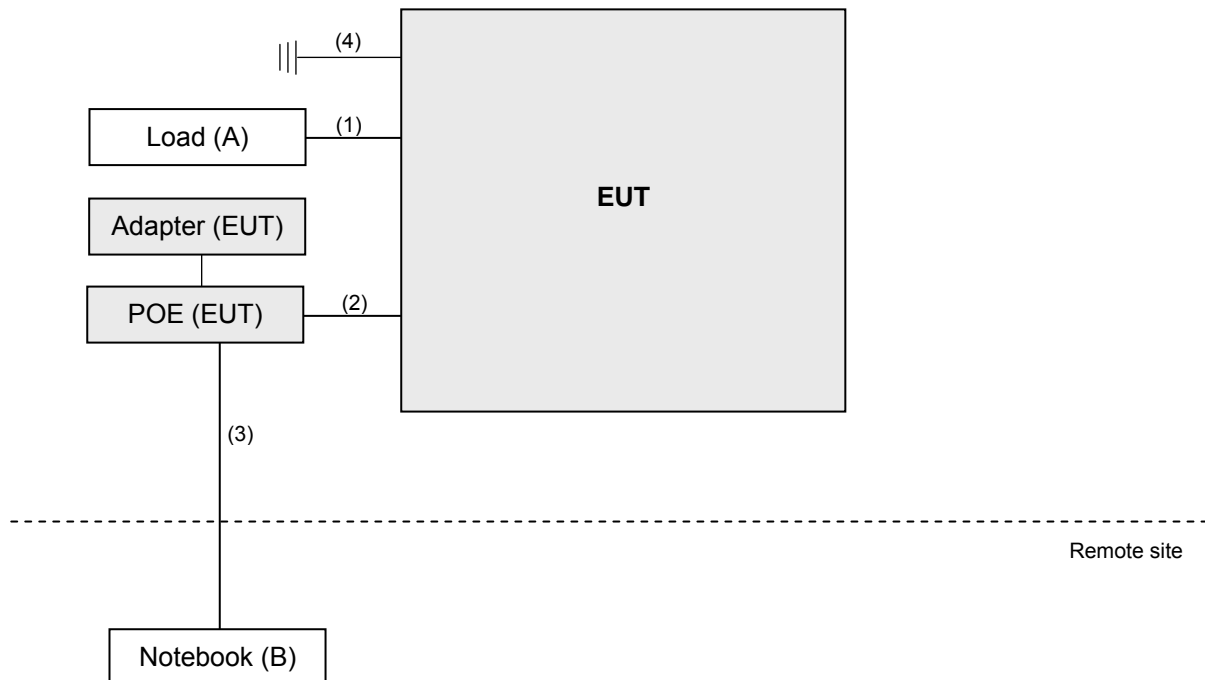

3.4 General Description of Applied Standard

The EUT is a RF Product. According to the specifications of the manufacturer, it must comply with the requirements of the following standards:

FCC Part 15, Subpart C (15.247)

FCC Part 15, Subpart E (15.407)

ANSI C63.10-2013

All test items have been performed and recorded as per the above standards.

Note: The EUT is also considered as a kind of computer peripheral, because the connection to computer is necessary for typical use. It has been verified to comply with the requirements of FCC Part 15, Subpart B, Class B (DoC). The test report has been issued separately.

4 Test Types and Results

4.1 Radiated Emission and Bandedge Measurement

4.1.1 Limits of Radiated Emission and Bandedge Measurement

Radiated emissions which fall in the restricted bands must comply with the radiated emission limits specified as below table.

Frequencies (MHz)	Field Strength (microvolts/meter)	Measurement Distance (meters)
0.009 ~ 0.490	2400/F(kHz)	300
0.490 ~ 1.705	24000/F(kHz)	30
1.705 ~ 30.0	30	30
30 ~ 88	100	3
88 ~ 216	150	3
216 ~ 960	200	3
Above 960	500	3

NOTE:

1. The lower limit shall apply at the transition frequencies.
2. Emission level (dBuV/m) = 20 log Emission level (uV/m).
3. For frequencies above 1000MHz, the field strength limits are based on average detector, however, the peak field strength of any emission shall not exceed the maximum permitted average limits, specified above by more than 30dB under any Condition of modulation.

LIMITS OF UNWANTED EMISSION OUT OF THE RESTRICTED BANDS

APPLICABLE TO	LIMIT	
789033 D02 General UNII Test Procedure New Rules v01	FIELD STRENGTH AT 3m	
	PK:74 (dBuV/m)	AV:54 (dBuV/m)
APPLICABLE TO	EIRP LIMIT	EQUIVALENT FIELD STRENGTH AT 3m
15.407(b)(1)	PK:-27 (dBm/MHz)	PK:68.2(dBuV/m)
15.407(b)(2)		
15.407(b)(3)		
15.407(b)(4)	PK:-27 (dBm/MHz) ^{*1} PK:-17 (dBm/MHz) ^{*2}	PK: 68.2(dBuV/m) ^{*1} PK:78.2 (dBuV/m) ^{*2}

NOTE: ^{*1} beyond 10MHz of the band edge ^{*2} within 10 MHz of band edge

The following formula is used to convert the equipment isotropic radiated power (eirp) to field strength:

$$E = \frac{1000000\sqrt{30P}}{3} \mu\text{V/m, where P is the eirp (Watts).}$$



4.1.2 Test Instruments

Description & Manufacturer	Model No.	Serial No.	Cal. Date	Cal. Due
Test Receiver ROHDE & SCHWARZ	ESIB7	100187	Apr. 10, 2015	Apr. 09, 2016
Spectrum Analyzer ROHDE & SCHWARZ	FSP40	100041	Sep. 02, 2015	Sep. 01, 2016
BILOG Antenna SCHWARZBECK	VULB9168	9168-151	Jan. 07, 2016	Jan. 06, 2017
HORN Antenna SCHWARZBECK	9120D	209	Jan. 20, 2016	Jan. 19, 2017
HORN Antenna SCHWARZBECK	BBHA 9170	BBHA9170241	Jan. 18, 2016	Jan. 17, 2017
Preamplifier Agilent	8447D	2944A10738	Oct.18, 2015	Oct. 17, 2016
Preamplifier Agilent	8449B	3008A01964	Aug. 22, 2015	Aug. 21, 2016
RF signal cable HUBER+SUHNER	SUCOFLEX 104	Cable-CH3-03 (214378)	Aug. 22, 2015	Aug. 21, 2016
RF signal cable HUBER+SUHNER	SUCOFLEX 106	Cable-CH3-03 (309224+12738)	Aug. 22, 2015	Aug. 21, 2016
Software BV ADT	ADT_Radiated_ V7.6.15.9.4	NA	NA	NA
Antenna Tower inn-co GmbH	MA 4000	013303	NA	NA
Antenna Tower Controller BV ADT	AT100	AT93021702	NA	NA
Turn Table BV ADT	TT100	TT93021702	NA	NA
Turn Table Controller BV ADT	SC100	SC93021702	NA	NA

- Note:
1. The calibration interval of the above test instruments is 12 months and the calibrations are traceable to NML/ROC and NIST/USA.
 2. The test was performed in HwaYa Chamber 3.
 3. The horn antenna and preamplifier (model: 8449B) are used only for the measurement of emission frequency above 1GHz if tested.
 4. The FCC Site Registration No. is 988962.
 5. The IC Site Registration No. is IC 7450F-3.

4.1.3 Test Procedure

- a. The EUT was placed on the top of a rotating table 0.8 meters (for below 1GHz) / 1.5 meters (for above 1GHz) above the ground at 3 meter chamber room for test. The table was rotated 360 degrees to determine the position of the highest radiation.
- b. The EUT was set 3 meters away from the interference-receiving antenna, which was mounted on the top of a variable-height antenna tower.
- c. The height of antenna is varied from one meter to four meters above the ground to determine the maximum value of the field strength. Both horizontal and vertical polarizations of the antenna are set to make the measurement.
- d. For each suspected emission, the EUT was arranged to its worst case and then the antenna was tuned to heights from 1 meter to 4 meters and the rotatable table was turned from 0 degrees to 360 degrees to find the maximum reading.
- e. The test-receiver system was set to quasi-peak detect function and specified bandwidth with maximum hold mode when the test frequency is below 1 GHz.
- f. The test-receiver system was set to peak and average detect function and specified bandwidth with maximum hold mode when the test frequency is above 1 GHz. If the peak reading value also meets average limit, measurement with the average detector is unnecessary.

Note:

1. The resolution bandwidth and video bandwidth of test receiver/spectrum analyzer is 120kHz for Quasi-peak detection (QP) at frequency below 1GHz.
2. The resolution bandwidth of test receiver/spectrum analyzer is 1 MHz and the video bandwidth is 3 MHz for Peak detection (PK) at frequency above 1GHz.
3. The resolution bandwidth of test receiver/spectrum analyzer is 1MHz and the video bandwidth is 3MHz for RMS Average (Duty cycle < 98%) for Average detection (AV) at frequency above 1GHz, then the measurement results was added to a correction factor ($10 \log(1/\text{duty cycle})$).
4. The resolution bandwidth of test receiver/spectrum analyzer is 1MHz and the video bandwidth is 10Hz (Duty cycle $\geq 98\%$) for Average detection (AV) at frequency above 1GHz.
5. All modes of operation were investigated and the worst-case emissions are reported.

4.1.4 Deviation from Test Standard

No deviation.

4.1.5 Test Setup

<Frequency Range below 1GHz>

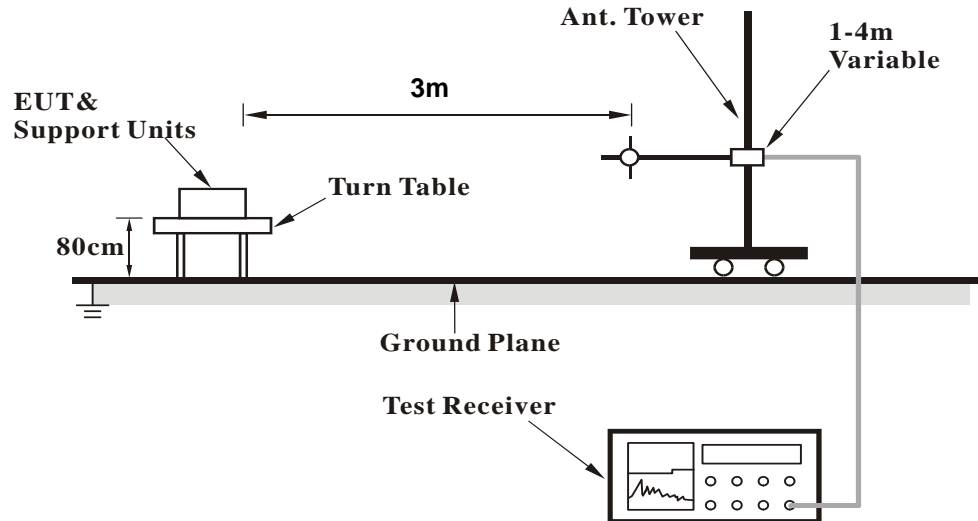

<Frequency Range above 1GHz>

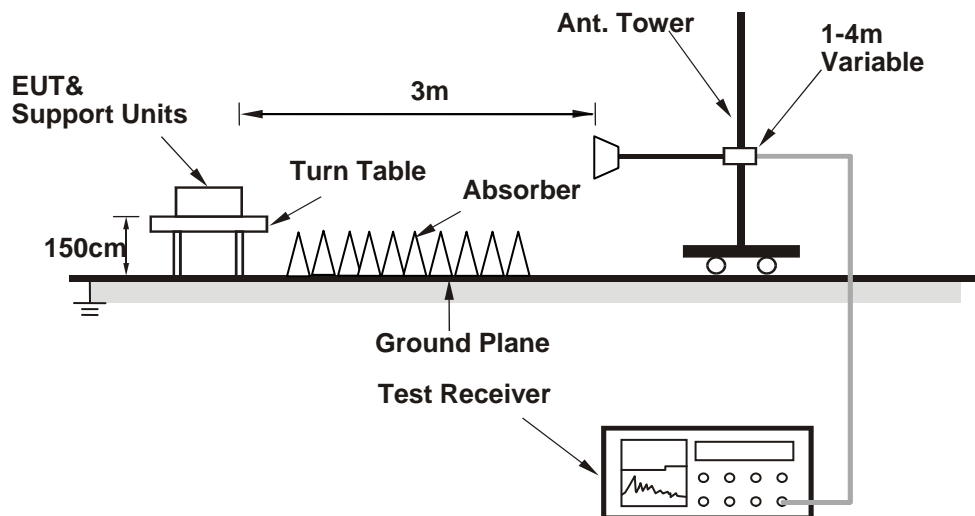

For the actual test configuration, please refer to the attached file (Test Setup Photo).

4.1.6 EUT Operating Conditions

- Placed the EUT on the testing table.
- Prepared a notebook to act as a communication partner and placed it outside of testing area.
- The communication partner connected with EUT via a RJ45 cable and ran a test program (provided by manufacturer) to enable EUT under transmission condition continuously at specific channel frequency.
- The communication partner sent data to EUT by command "PING".
- The necessary accessories enable the system in full functions.

4.1.7 Test Results

ABOVE 1GHz WORST-CASE DATA :

CHANNEL	802.11g CH 6 + 802.11n (HT20) CH 157	DETECTOR FUNCTION	Peak (PK) Average (AV)
FREQUENCY RANGE	1GHz ~ 25GHz		

ANTENNA POLARITY & TEST DISTANCE: HORIZONTAL AT 3 M

NO.	FREQ. (MHz)	EMISSION LEVEL (dBuV/m)	LIMIT (dBuV/m)	MARGIN (dB)	ANTENNA HEIGHT (m)	TABLE ANGLE (Degree)	RAW VALUE (dBuV)	CORRECTION FACTOR (dB/m)
1	2390.00	60.2 PK	74.0	-13.8	2.00 H	205	61.50	-1.30
2	2390.00	46.6 AV	54.0	-7.4	2.00 H	205	47.90	-1.30
3	*2437.00	109.1 PK			2.05 H	210	76.20	32.90
4	*2437.00	99.8 AV			2.05 H	210	66.90	32.90
5	2483.50	58.3 PK	74.0	-15.7	2.00 H	211	59.40	-1.10
6	2483.50	45.6 AV	54.0	-8.4	2.00 H	211	46.70	-1.10
7	4874.00	52.1 PK	74.0	-21.9	1.40 H	155	46.10	6.00
8	4874.00	39.4 AV	54.0	-14.6	1.40 H	155	33.40	6.00

ANTENNA POLARITY & TEST DISTANCE: VERTICAL AT 3 M

NO.	FREQ. (MHz)	EMISSION LEVEL (dBuV/m)	LIMIT (dBuV/m)	MARGIN (dB)	ANTENNA HEIGHT (m)	TABLE ANGLE (Degree)	RAW VALUE (dBuV)	CORRECTION FACTOR (dB/m)
1	2390.00	68.9 PK	74.0	-5.1	1.90 V	300	70.20	-1.30
2	2390.00	50.6 AV	54.0	-3.4	1.90 V	300	51.90	-1.30
3	*2437.00	123.6 PK			1.94 V	300	90.70	32.90
4	*2437.00	113.5 AV			1.94 V	300	80.60	32.90
5	2483.50	68.1 PK	74.0	-5.9	1.90 V	305	69.20	-1.10
6	2483.50	52.8 AV	54.0	-1.2	1.90 V	305	53.90	-1.10
7	4874.00	53.1 PK	74.0	-20.9	1.60 V	200	47.10	6.00
8	4874.00	40.3 AV	54.0	-13.7	1.60 V	200	34.30	6.00

REMARKS:

1. Emission Level(dBuV/m) = Raw Value(dBuV) + Correction Factor(dB/m)
2. Correction Factor(dB/m) = Antenna Factor(dB/m) + Cable Factor(dB)
3. The other emission levels were very low against the limit.
4. Margin value = Emission Level – Limit value
5. " * ": Fundamental frequency.

CHANNEL	802.11g CH 6 + 802.11n (HT20) CH 157	DETECTOR FUNCTION	Peak (PK) Average (AV)
FREQUENCY RANGE	1GHz ~ 40GHz		

ANTENNA POLARITY & TEST DISTANCE: HORIZONTAL AT 3 M

NO.	FREQ. (MHz)	EMISSION LEVEL (dBuV/m)	LIMIT (dBuV/m)	MARGIN (dB)	ANTENNA HEIGHT (m)	TABLE ANGLE (Degree)	RAW VALUE (dBuV)	CORRECTION FACTOR (dB/m)
1	*5785.00	104.9 PK			1.20 H	150	97.40	7.50
2	*5785.00	95.6 AV			1.20 H	150	88.10	7.50
3	11570.00	61.2 PK	74.0	-12.8	1.30 H	155	42.50	18.70
4	11570.00	48.3 AV	54.0	-5.7	1.30 H	155	29.60	18.70

ANTENNA POLARITY & TEST DISTANCE: VERTICAL AT 3 M

NO.	FREQ. (MHz)	EMISSION LEVEL (dBuV/m)	LIMIT (dBuV/m)	MARGIN (dB)	ANTENNA HEIGHT (m)	TABLE ANGLE (Degree)	RAW VALUE (dBuV)	CORRECTION FACTOR (dB/m)
1	#5630.00	66.0 PK	68.2	-2.2	2.08 V	125	58.90	7.10
2	*5785.00	118.0 PK			2.10 V	100	110.50	7.50
3	*5785.00	105.9 AV			2.10 V	100	98.40	7.50
4	#5940.00	64.9 PK	68.2	-3.3	2.05 V	144	57.20	7.70
5	11570.00	61.2 PK	74.0	-12.8	1.90 V	200	42.50	18.70
6	11570.00	49.0 AV	54.0	-5.0	1.90 V	200	30.30	18.70

REMARKS:

1. Emission Level(dBuV/m) = Raw Value(dBuV) + Correction Factor(dB/m)
2. Correction Factor(dB/m) = Antenna Factor(dB/m) + Cable Factor(dB)
3. The other emission levels were very low against the limit.
4. Margin value = Emission Level – Limit value
5. " * ": Fundamental frequency.
6. " # ": The radiated frequency is out of the restricted band.

BELOW 1GHz WORST-CASE DATA:

CHANNEL	802.11g CH 6 + 802.11n (HT20) CH 157	DETECTOR FUNCTION	Quasi-Peak (QP)
FREQUENCY RANGE	30MHz ~ 1GHz		

ANTENNA POLARITY & TEST DISTANCE: HORIZONTAL AT 3 M

NO.	FREQ. (MHz)	EMISSION LEVEL (dBuV/m)	LIMIT (dBuV/m)	MARGIN (dB)	ANTENNA HEIGHT (m)	TABLE ANGLE (Degree)	RAW VALUE (dBuV)	CORRECTION FACTOR (dB/m)
1	56.89	30.6 QP	40.0	-9.4	1.50 H	65	45.40	-14.80
2	98.89	34.5 QP	43.5	-9.0	2.00 H	311	53.60	-19.10
3	143.52	34.6 QP	43.5	-8.9	2.50 H	150	48.90	-14.30
4	185.54	33.6 QP	43.5	-9.9	1.50 H	236	49.30	-15.70
5	203.87	36.6 QP	43.5	-6.9	1.50 H	45	53.40	-16.80
6	288.00	30.6 QP	46.0	-15.4	1.00 H	241	43.40	-12.80

ANTENNA POLARITY & TEST DISTANCE: VERTICAL AT 3 M

NO.	FREQ. (MHz)	EMISSION LEVEL (dBuV/m)	LIMIT (dBuV/m)	MARGIN (dB)	ANTENNA HEIGHT (m)	TABLE ANGLE (Degree)	RAW VALUE (dBuV)	CORRECTION FACTOR (dB/m)
1	50.05	37.5 QP	40.0	-2.5	1.00 V	310	52.10	-14.60
2	72.31	37.1 QP	40.0	-2.9	1.00 V	210	54.20	-17.10
3	104.52	37.4 QP	43.5	-6.1	1.50 V	233	55.70	-18.30
4	150.63	31.1 QP	43.5	-12.4	1.00 V	300	45.10	-14.00
5	174.25	30.9 QP	43.5	-12.6	1.50 V	325	45.50	-14.60
6	215.57	34.5 QP	43.5	-9.0	1.00 V	148	51.00	-16.50

REMARKS:

1. Emission Level(dBuV/m) = Raw Value(dBuV) + Correction Factor(dB/m)
2. Correction Factor(dB/m) = Antenna Factor(dB/m) + Cable Factor(dB)
3. The other emission levels were very low against the limit.
4. Margin value = Emission Level – Limit value

4.2 Conducted Emission Measurement

4.2.1 Limits of Conducted Emission Measurement

Frequency (MHz)	Conducted Limit (dBuV)	
	Quasi-peak	Average
0.15 - 0.5	66 - 56	56 - 46
0.50 - 5.0	56	46
5.0 - 30.0	60	50

Note: 1. The lower limit shall apply at the transition frequencies.

2. The limit decreases in line with the logarithm of the frequency in the range of 0.15 to 0.50MHz.

4.2.2 Test Instruments

Description & Manufacturer	Model No.	Serial No.	Cal. Date	Cal. Due
Test Receiver ROHDE & SCHWARZ	ESCS 30	100288	Apr. 27, 2015	Apr. 26, 2016
RF signal cable (with 10dB PAD) Woken	5D-FB	Cable-cond2-01	Dec. 26, 2015	Dec. 25, 2016
LISN ROHDE & SCHWARZ (EUT)	ESH2-Z5	100100	Jan. 11, 2016	Jan. 10, 2017
LISN ROHDE & SCHWARZ (Peripheral)	ESH3-Z5	100312	Jul. 21, 2015	Jul. 20, 2016
Software ADT	BV ADT_Cond_ V7.3.7.3	NA	NA	NA

Note: 1. The calibration interval of the above test instruments is 12 months and the calibrations are traceable to NML/ROC and NIST/USA.

2. The test was performed in HwaYa Shielded Room 2.

3. The VCCI Site Registration No. is C-2047.

4.2.3 Test Procedure

- The EUT was placed 0.4 meters from the conducting wall of the shielded room with EUT being connected to the power mains through a line impedance stabilization network (LISN). Other support units were connected to the power mains through another LISN. The two LISNs provide 50 ohm/ 50uH of coupling impedance for the measuring instrument.
- Both lines of the power mains connected to the EUT were checked for maximum conducted interference.
- The frequency range from 150kHz to 30MHz was searched. Emission levels under (Limit - 20dB) was not recorded.

NOTE: The resolution bandwidth and video bandwidth of test receiver is 9kHz for quasi-peak detection (QP) and average detection (AV) at frequency 0.15MHz-30MHz.

4.2.4 Deviation from Test Standard

No deviation.

4.2.5 Test Setup

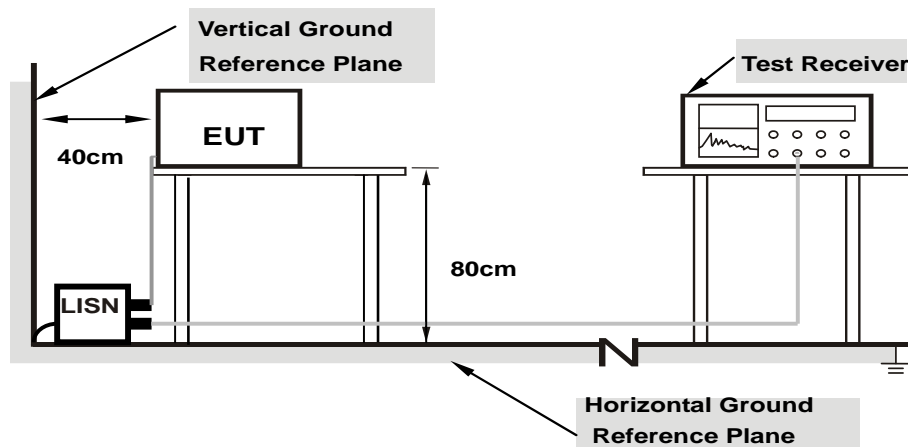

Note: 1.Support units were connected to second LISN.

2.Both of LISNs (AMN) are 80 cm from EUT and at least 80 from other units and other metal planes

For the actual test configuration, please refer to the attached file (Test Setup Photo).

4.2.6 EUT Operating Conditions

Same as 4.1.6.

4.2.7 Test Results

Phase	Line (L)	Detector Function	Quasi-Peak (QP) / Average (AV)
Channel	802.11g CH 6 + 802.11n (HT20) CH 157		

No	Freq. [MHz]	Corr. Factor (dB)	Reading Value		Emission Level		Limit		Margin	
			[dB (uV)]		[dB (uV)]		[dB (uV)]		(dB)	
			Q.P.	AV.	Q.P.	AV.	Q.P.	AV.	Q.P.	AV.
1	0.15000	10.17	39.24	26.74	49.41	36.91	66.00	56.00	-16.59	-19.09
2	0.18125	10.17	38.68	28.27	48.85	38.44	64.43	54.43	-15.58	-15.99
3	0.43106	10.21	36.35	34.46	46.56	44.67	57.23	47.23	-10.67	-2.56
4	4.38672	10.43	27.56	20.48	37.99	30.91	56.00	46.00	-18.01	-15.09
5	5.43750	10.50	31.12	23.57	41.62	34.07	60.00	50.00	-18.38	-15.93
6	7.33984	10.62	33.45	27.29	44.07	37.91	60.00	50.00	-15.93	-12.09

REMARKS:

1. Q.P. and AV. are abbreviations of quasi-peak and average individually.
2. The emission levels of other frequencies were very low against the limit.
3. Margin value = Emission level - Limit value
4. Correction factor = Insertion loss + Cable loss
5. Emission Level = Correction Factor + Reading Value.

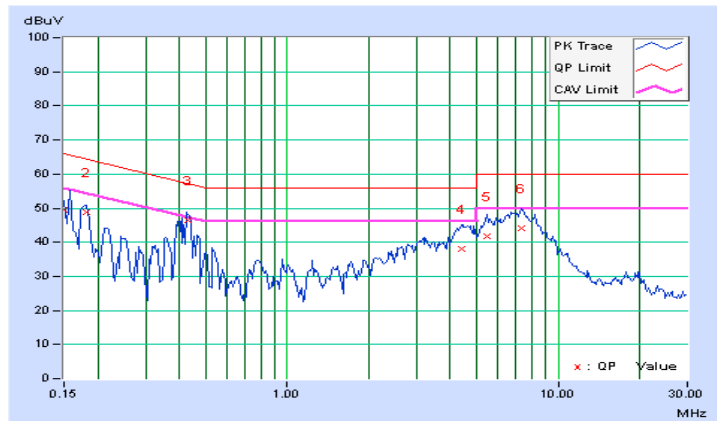

Phase	Neutral (N)	Detector Function	Quasi-Peak (QP) / Average (AV)
Channel	802.11g CH 6 + 802.11n (HT20) CH 157		

No	Freq. [MHz]	Corr. Factor (dB)	Reading Value [dB (uV)]		Emission Level [dB (uV)]		Limit [dB (uV)]		Margin (dB)	
			Q.P.	AV.	Q.P.	AV.	Q.P.	AV.	Q.P.	AV.
	1	0.15000	10.18	40.25	27.54	50.43	37.72	66.00	56.00	-15.57
2	0.17857	10.17	39.28	28.85	49.45	39.02	64.55	54.55	-15.10	-15.53
3	0.43116	10.28	36.04	34.31	46.32	44.59	57.23	47.23	-10.91	-2.64
4	0.54145	10.28	24.41	21.04	34.69	31.32	56.00	46.00	-21.31	-14.68
5	4.65359	10.57	29.21	23.00	39.78	33.57	56.00	46.00	-16.22	-12.43
6	7.11458	10.70	33.11	27.74	43.81	38.44	60.00	50.00	-16.19	-11.56

REMARKS:

1. Q.P. and AV. are abbreviations of quasi-peak and average individually.
2. The emission levels of other frequencies were very low against the limit.
3. Margin value = Emission level - Limit value
4. Correction factor = Insertion loss + Cable loss
5. Emission Level = Correction Factor + Reading Value.

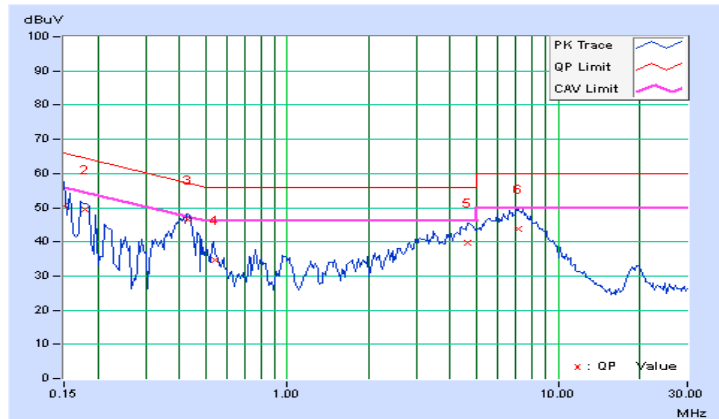

5 Pictures of Test Arrangements

Please refer to the attached file (Test Setup Photo).



Appendix – Information on the Testing Laboratories

We, Bureau Veritas Consumer Products Services (H.K.) Ltd., Taoyuan Branch, were founded in 1988 to provide our best service in EMC, Radio, Telecom and Safety consultation. Our laboratories are accredited and approved according to ISO/IEC 17025.

If you have any comments, please feel free to contact us at the following:

Linko EMC/RF Lab

Tel: 886-2-26052180

Fax: 886-2-26051924

Hsin Chu EMC/RF/Telecom Lab

Tel: 886-3-6668565

Fax: 886-3-6668323

Hwa Ya EMC/RF/Safety Lab

Tel: 886-3-3183232

Fax: 886-3-3270892

Email: service.adt@tw.bureauveritas.com

Web Site: www.bureauveritas-adt.com

The address and road map of all our labs can be found in our web site also.

--- END ---