

FCC Radio Test Report

FCC ID: KA2IR842G1

This report concerns: Original Grant

Project No. : 2006H006
Equipment : AC1200 Wi-Fi Gigabit Router
Brand Name : D-Link
Test Model : DIR-842
Series Model : DIR-825
Applicant : D-Link Corporation
Address : 17595 Mt. Herrmann, Fountain Valley, California United State 92708
Manufacturer : D-Link Corporation
Address : 17595 Mt. Herrmann, Fountain Valley, California United State 92708
Date of Receipt : Jun. 08, 2020
Date of Test : Jun. 10, 2020~Jul. 10, 2020
Issued Date : Jul. 27, 2020
Report Version : R00
Test Sample : Engineering Sample No.: SH2020060867, SH2020060867-5,
AMS200-1201500F
Standard(s) : FCC Part15, Subpart C (15.247)
ANSI C63.10-2013
KDB 558074 D01 15.247 Meas Guidance v05r02

The above equipment has been tested and found compliance with the requirement of the relative standards by BTL Inc.

Krain Wu

Prepared by : Krain Wu

Ryan Wang

Approved by : Ryan Wang



Certificate # 5123.03

Add: No. 29, Jintang Road, Tangzhen Industry Park, Pudong New Area, Shanghai 201210, China

TEL: +86-021-61765666

Web: www.newbtl.com

Declaration

BTL represents to the client that testing is done in accordance with standard procedures as applicable and that test instruments used has been calibrated with standards traceable to international standard(s) and/or national standard(s).

BTL's reports apply only to the specific samples tested under conditions. It is manufacture's responsibility to ensure that additional production units of this model are manufactured with the identical electrical and mechanical components. **BTL** shall have no liability for any declarations, inferences or generalizations drawn by the client or others from **BTL** issued reports.

The report must not be used by the client to claim product certification, approval, or endorsement by NVLAP, NIST, A2LA, or any agency of the U.S. Government.

This report is the confidential property of the client. As a mutual protection to the clients, the public and ourselves, the test report shall not be reproduced, except in full, without our written approval.

BTL's laboratory quality assurance procedures are in compliance with the **ISO/IEC 17025** requirements, and accredited by the conformity assessment authorities listed in this test report.

BTL is not responsible for the sampling stage, so the results only apply to the sample as received.

The information, data and test plan are provided by manufacturer which may affect the validity of results, so it is manufacturer's responsibility to ensure that the apparatus meets the essential requirements of applied standards and in all the possible configurations as representative of its intended use.

Limitation

For the use of the authority's logo is limited unless the Test Standard(s)/Scope(s)/Item(s) mentioned in this test report is (are) included in the conformity assessment authorities acceptance respective.

Please note that the measurement uncertainty is provided for informational purpose only and are not use in determining the Pass/Fail results.

Table of Contents	Page
REPORT ISSUED HISTORY	6
1 . SUMMARY OF TEST RESULTS	7
1.1 TEST FACILITY	7
1.2 MEASUREMENT UNCERTAINTY	8
1.3 TEST ENVIRONMENT CONDITIONS	8
2 . GENERAL INFORMATION	9
2.1 GENERAL DESCRIPTION OF EUT	9
2.2 DESCRIPTION OF TEST MODES	11
2.3 PARAMETERS OF TEST SOFTWARE	13
2.4 DUTY CYCLE	14
2.5 BLOCK DIAGRAM SHOWING THE CONFIGURATION OF SYSTEM TESTED	15
2.6 SUPPORT UNITS	15
3 . AC POWER LINE CONDUCTED EMISSIONS TEST	16
3.1 LIMIT	16
3.2 TEST PROCEDURE	16
3.3 DEVIATION FROM TEST STANDARD	16
3.4 TEST SETUP	17
3.5 EUT OPERATION CONDITIONS	17
3.6 TEST RESULTS	17
4 . RADIATED EMISSIONS TEST	18
4.1 LIMIT	18
4.2 TEST PROCEDURE	19
4.3 DEVIATION FROM TEST STANDARD	19
4.4 TEST SETUP	20
4.5 EUT OPERATION CONDITIONS	21
4.6 TEST RESULTS - 9 KHZ TO 30 MHZ	21
4.7 TEST RESULTS - 30 MHZ TO 1000 MHZ	21
4.8 TEST RESULTS - ABOVE 1000 MHZ	21
5 . BANDWIDTH TEST	22
5.1 LIMIT	22
5.2 TEST PROCEDURE	22
5.3 DEVIATION FROM STANDARD	22
5.4 TEST SETUP	22

Table of Contents	Page
5.5 EUT OPERATION CONDITIONS	22
5.6 TEST RESULTS	22
6 . MAXIMUM OUTPUT POWER TEST	23
6.1 LIMIT	23
6.2 TEST PROCEDURE	23
6.3 DEVIATION FROM STANDARD	23
6.4 TEST SETUP	23
6.5 EUT OPERATION CONDITIONS	23
6.6 TEST RESULTS	23
7 . CONDUCTED SPURIOUS EMISSIONS	24
7.1 LIMIT	24
7.2 TEST PROCEDURE	24
7.3 DEVIATION FROM STANDARD	24
7.4 TEST SETUP	24
7.5 EUT OPERATION CONDITIONS	24
7.6 TEST RESULTS	24
8 . POWER SPECTRAL DENSITY TEST	25
8.1 LIMIT	25
8.2 TEST PROCEDURE	25
8.3 DEVIATION FROM STANDARD	25
8.4 TEST SETUP	25
8.5 EUT OPERATION CONDITIONS	25
8.6 TEST RESULTS	25
9 . MEASUREMENT INSTRUMENTS LIST	26
10 . EUT TEST PHOTO	28
APPENDIX A - AC POWER LINE CONDUCTED EMISSIONS	30
APPENDIX B - RADIATED EMISSION - 9 KHZ TO 30 MHZ	33
APPENDIX C - RADIATED EMISSION - 30 MHZ TO 1000 MHZ	34
APPENDIX D - RADIATED EMISSION- ABOVE 1000 MHZ	37
APPENDIX E - BANDWIDTH	86
APPENDIX F - MAXIMUM OUTPUT POWER	91
APPENDIX G - CONDUCTED SPURIOUS EMISSIONS	96

Table of Contents	Page
APPENDIX H - POWER SPECTRAL DENSITY	104

REPORT ISSUED HISTORY

Report Version	Description	Issued Date
R00	Original Issue.	Jul. 27, 2020

1. SUMMARY OF TEST RESULTS

Test procedures according to the technical standard(s):

FCC Part15, Subpart C (15.247)				
Standard(s) Section	Test Item	Test Result	Judgment	Remark
15.207	AC Power Line Conducted Emissions	APPENDIX A	PASS	-----
15.247(d) 15.205(a) 15.209(a)	Radiated Emissions	APPENDIX B APPENDIX C APPENDIX D	PASS	-----
15.247(a)(2)	Bandwidth	APPENDIX E	PASS	-----
15.247(b)(3)	Maximum Output Power	APPENDIX F	PASS	-----
15.247(d)	Conducted Spurious Emissions	APPENDIX G	PASS	-----
15.247(e)	Power Spectral Density	APPENDIX H	PASS	-----
15.203	Antenna Requirement	-----	PASS	Note(2)

Note:

- (1) "N/A" denotes test is not applicable in this test report.
- (2) The device what use a permanently attached antenna were considered sufficient to comply with the provisions of 15.203.

1.1 TEST FACILITY

The test facilities used to collect the test data in this report is at the location of No. 29, Jintang Road, Tangzhen Industry Park, Pudong New Area, Shanghai 201210,China
 BTL's Test Firm Registration Number for FCC: 476765
 BTL's Designation Number for FCC: CN1241

1.2 MEASUREMENT UNCERTAINTY

ISO/IEC 17025 requires that an estimate of the measurement uncertainties associated with the emissions test results be included in the report. The measurement uncertainties given below are based on a 95% confidence level (based on a coverage factor (k=2))

The BTL measurement uncertainty as below table:

A. Radiated emissions test:

Test Site	Method	Measurement Frequency Range	Ant. H / V	U, (dB)
SH-CB01	CISPR	9 KHz~30 MHz	V	3.79
		9 KHz~30 MHz	H	3.57
		30 MHz~200 MHz	V	4.04
		30 MHz~200 MHz	H	3.76
		200 MHz~1,000 MHz	V	4.24
		200 MHz~1,000 MHz	H	3.84
		1 GHz~18 GHz	V	4.46
		1 GHz~18 GHz	H	4.40
		18 GHz~40 GHz	V	3.95
		18 GHz~40 GHz	H	3.95

Note: Unless specifically mentioned, the uncertainty of measurement has not been taken into account to declare the compliance or non-compliance to the specification.

1.3 TEST ENVIRONMENT CONDITIONS

Test Item	Temperature	Humidity	Test Voltage	Tested By
AC Power Line Conducted Emissions	24°C	58 %	AC 120V/60Hz	Vince Zong
Radiated Emissions-9K-30MHz	22°C	52 %	AC 120V/60Hz	Vince Zong
Radiated Emissions-30 MHz to 1GHz	22°C	52 %	AC 120V/60Hz	Vince Zong
Radiated Emissions-Above 1000 MHz	22°C	52 %	AC 120V/60Hz	Vince Zong
Bandwidth	25°C	55 %	AC 120V/60Hz	Forest Li
Maximum output power & e.i.r.p.	25°C	55 %	AC 120V/60Hz	Forest Li
Conducted Spurious Emissions	25°C	55 %	AC 120V/60Hz	Forest Li
Power Spectral Density	25°C	55 %	AC 120V/60Hz	Forest Li

2. GENERAL INFORMATION

2.1 GENERAL DESCRIPTION OF EUT

Equipment	AC1200 Wi-Fi Gigabit Router
Brand Name	D-Link
Test Model	DIR-842
Series Model	DIR-825
Model Difference(s)	Only the model name is differen
Software Version	1.0.0
Hardware Version	G1,I1
Power Source	DC voltage supplied from AC/DC adapter. 1# Brand/Model:AMIGO/AMS200-1201500F 2# Brand/Model:HEWEISHUN/BN074-A18012U
Power Rating	1# I/P:100-240V~50/60Hz 0.8A Max O/P:12.0V --- 1.5A 18.0W 2# I/P:100-240V~50/60Hz 0.6A O/P:12V --- 1.5A
Operation Frequency	2412 MHz ~ 2462 MHz
Modulation Type	IEEE 802.11b: DSSS IEEE 802.11g: OFDM IEEE 802.11n: OFDM
Bit Rate of Transmitter	IEEE 802.11b: 11/5.5/2/1 Mbps IEEE 802.11g: 54/48/36/24/18/12/9/6 Mbps IEEE 802.11n: up to 300 Mbps
Maximum Output Power CDD	IEEE 802.11b: 21.77 dBm (0.1503 W) IEEE 802.11g: 24.21 dBm (0.2636 W) IEEE 802.11n (HT20): 24.30 dBm (0.2692 W) IEEE 802.11n (HT40): 20.38 dBm (0.1091 W)

Note:

- For a more detailed features description, please refer to the manufacturer's specifications or the user's manual.
- Channel List:

CH01 - CH11 for IEEE 802.11b, IEEE 802.11g, IEEE 802.11n (HT20) CH03 - CH09 for IEEE 802.11n (HT40)							
Channel	Frequency (MHz)	Channel	Frequency (MHz)	Channel	Frequency (MHz)	Channel	Frequency (MHz)
01	2412	04	2427	07	2442	10	2457
02	2417	05	2432	08	2447	11	2462
03	2422	06	2437	09	2452		

3. Antenna Specification:

Ant.	Brand	Model Name	Antenna Type	Connector	Gain (dBi)	Note
1	N/A	N/A	Dipole	N/A	5	N/A
2	N/A	N/A	Dipole	N/A	5	N/A

Note:

All antennas have the same gain, Directional gain = $G_{ANT} + \text{Array Gain}$,

For power spectral density measurements, $N_{ANT} = 2$, $N_{SS} = 1$. So Directional gain = $G_{ANT} + \text{Array Gain} = 10 \log(N_{ANT}/N_{SS}) \text{ dB} = 5 + 10 \log(2/1) \text{ dBi} = 8.01$. Then, the power density limit is $8 - (8.01 - 6) = 5.99$.

For power measurements, Array Gain = 0 dB ($N_{ANT} \leq 4$), so the Directional gain = 5.

4. Table for Antenna Configuration:

Operating Mode TX Mode	Ant. 1	Ant. 2	Ant. 1+2
802.11b	✓	✓	✗
802.11g	✓	✓	✓
802.11n(20 MHz)	✓	✓	✓
802.11n(40 MHz)	✓	✓	✓

2.2 DESCRIPTION OF TEST MODES

The test system was pre-tested based on the consideration of all possible combinations of EUT operation mode.

Pretest Mode	Description
Mode 1	TX B Mode Channel 01/06/11
Mode 2	TX G Mode Channel 01/06/11
Mode 3	TX N-20 MHz Mode Channel 01/06/11
Mode 4	TX N-40 MHz Mode Channel 03/06/09
Mode 5	TX N20 Mode Channel 06

Following mode(s) as (were) found to be the worst case(s) and selected for the final test.

AC power line conducted emissions test	
Final Test Mode:	Description
Mode 5	TX N20 Mode Channel 06

Radiated emissions test - Below 1GHz	
Final Test Mode:	Description
Mode 5	TX N20 Mode Channel 06

Radiated emissions test- Above 1GHz	
Final Test Mode:	Description
Mode 1	TX B Mode Channel 01/06/11
Mode 2	TX G Mode Channel 01/06/11
Mode 3	TX N-20 MHz Mode Channel 01/06/11
Mode 4	TX N-40 MHz Mode Channel 03/06/09

Conducted test	
Final Test Mode:	Description
Mode 1	TX B Mode Channel 01/06/11
Mode 2	TX G Mode Channel 01/06/11
Mode 3	TX N-20 MHz Mode Channel 01/06/11
Mode 4	TX N-40 MHz Mode Channel 03/06/09

NOTE:

- (1) The measurements are performed at the high, middle, low available channels.
- (2) 802.11b mode: CCK (1 Mbps)
802.11g mode: OFDM (6 Mbps)
802.11n HT20 mode : BPSK (13 Mbps)
802.11n HT40 mode : BPSK (27 Mbps)
For radiated emission tests, the highest output powers were set for final test.
- (3) For radiated emission below 1 GHz test, the IEEE 802.11n20 Channel 06 is found to be the worst case and recorded.

2.3 PARAMETERS OF TEST SOFTWARE**CDD**

Test Software	MP_TOOL		
Frequency (MHz)	2412	2437	2462
IEEE 802.11b	110	112	85
IEEE 802.11g	92	114	82
IEEE 802.11n (HT20)	96	114	84
Frequency (MHz)	2422	2437	2452
IEEE 802.11n (HT40)	91	100	84

2.4 DUTY CYCLE

If duty cycle is $\geq 98\%$, duty factor is not required.
 If duty cycle is $< 98\%$, duty factor shall be considered.
 The output power = measured power + duty factor.

IEEE 802.11b

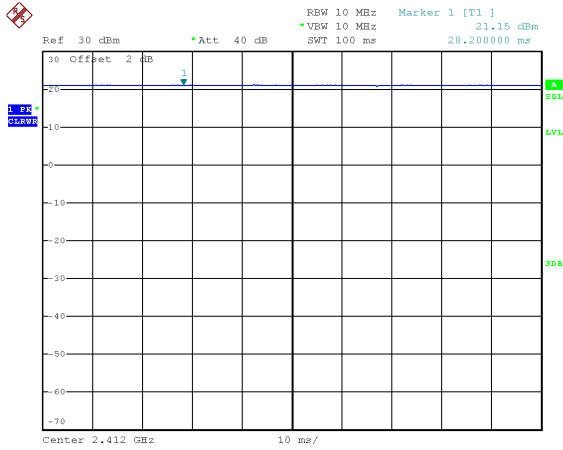

IEEE 802.11g

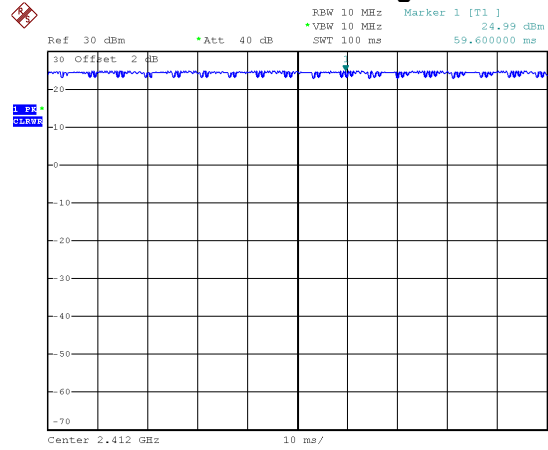

Date: 10.JUL.2020 11:47:08

Duty cycle = 0.000 ms / 0.000 ms = 0.00%
 Duty Factor = $10 \log(1/\text{Duty cycle}) = 0.00$

IEEE 802.11n (HT20)

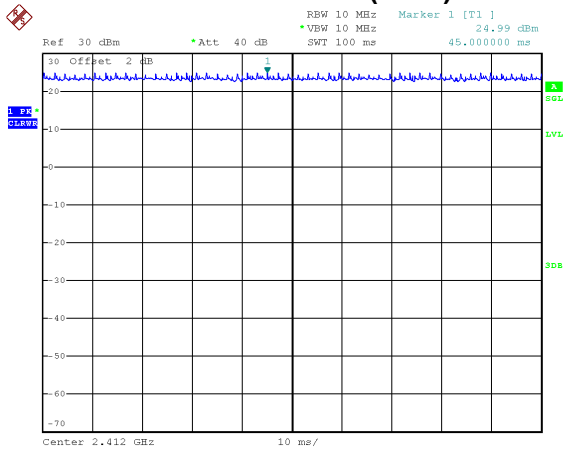

Date: 10.JUL.2020 11:34:27

Duty cycle = 0.000 ms / 0.000 ms = 0.00%
 Duty Factor = $10 \log(1/\text{Duty cycle}) = 0.00$,

Date: 10.JUL.2020 11:47:39

Duty cycle = 0.000 ms / 0.000 ms = 0.00%
 Duty Factor = $10 \log(1/\text{Duty cycle}) = 0.00$

IEEE 802.11n (HT40)

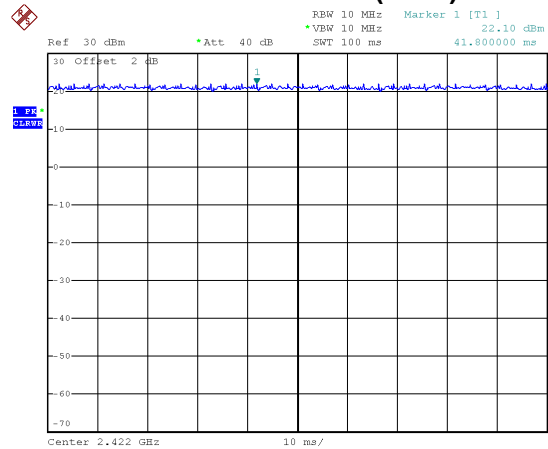

Date: 10.JUL.2020 11:41:15

Duty cycle = 0.000 ms / 0.000 ms = 0.00%
 Duty Factor = $10 \log(1/\text{Duty cycle}) = 0.00$

NOTE:

For IEEE 802.11b, IEEE 802.11g, IEEE 802.11n (HT20) and IEEE 802.11n (HT40):
 For radiated emissions frequency above 1 GHz, the resolution bandwidth of test receiver/spectrum analyzer is 1 MHz and the video bandwidth is 0.01 kHz (Duty cycle > 98%).

2.5 BLOCK DIAGRAM SHOWING THE CONFIGURATION OF SYSTEM TESTED

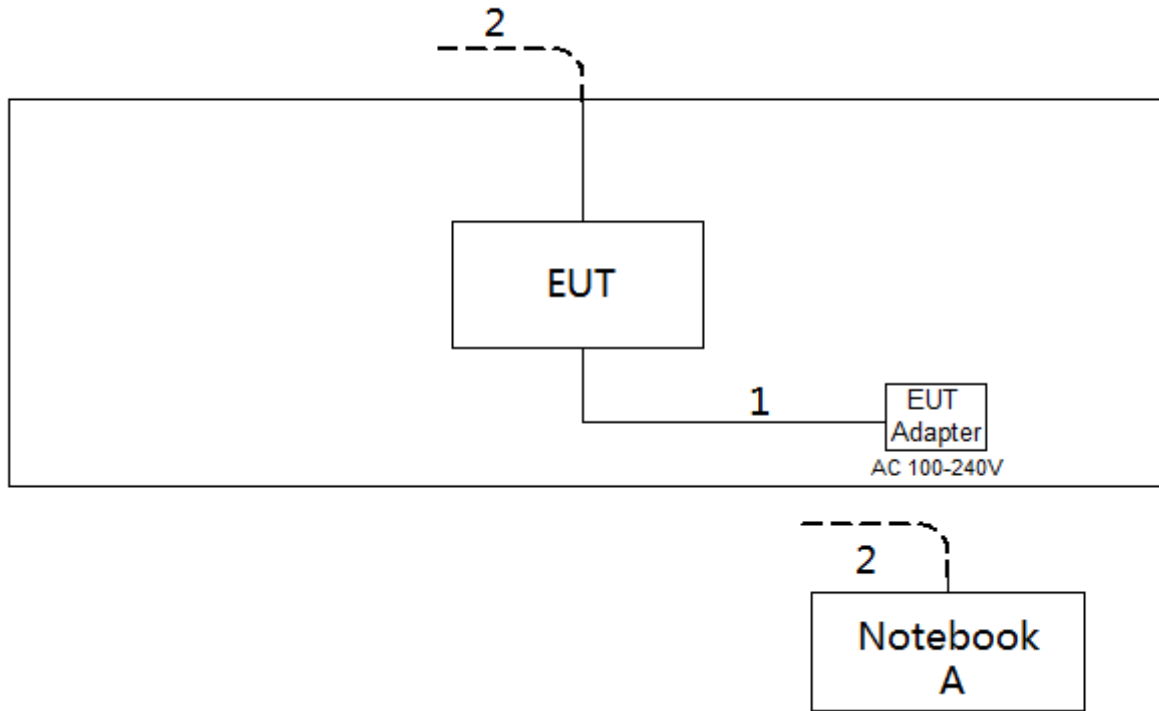

2.6 SUPPORT UNITS

Item	Equipment	Brand	Model No.	Series No.
A	Notebook	Lenovo	#P152014	N/A

Item	Cable Type	Shielded Type	Ferrite Core	Length
1	DC Cable	NO	NO	1.5m
2	RJ45 Cable	NO	NO	10m

3. AC POWER LINE CONDUCTED EMISSIONS TEST

3.1 LIMIT

Frequency of Emission (MHz)	Limit (dB μ V)	
	Quasi-peak	Average
0.15 - 0.50	66 to 56*	56 to 46*
0.50 - 5.0	56	46
5.0 - 30.0	60	50

NOTE:

- (1) The tighter limit applies at the band edges.
- (2) The limit of " * " marked band means the limitation decreases linearly with the logarithm of the frequency in the range.

The following table is the setting of the receiver

Receiver Parameters	Setting
Attenuation	10 dB
Start Frequency	0.15 MHz
Stop Frequency	30 MHz
IF Bandwidth	9 kHz

3.2 TEST PROCEDURE

- a. The EUT was placed 0.8 meters from the horizontal ground plane with EUT being connected to the power mains through a line impedance stabilization network (LISN). All other support equipment powered from additional LISN(s). The LISN provide 50 Ohm/ 50uH of coupling impedance for the measuring instrument.
- b. Interconnecting cables that hang closer than 40 cm to the ground plane shall be folded back and forth in the center forming a bundle 30 to 40 cm long.
- c. I/O cables that are not connected to a peripheral shall be bundled in the center. The end of the cable may be terminated, if required, using the correct terminating impedance. The overall length shall not exceed 1 m.
- d. LISN at least 80 cm from nearest part of EUT chassis.
- e. For the actual test configuration, please refer to the related Item -EUT Test Photos.

3.3 DEVIATION FROM TEST STANDARD

No deviation

3.4 TEST SETUP

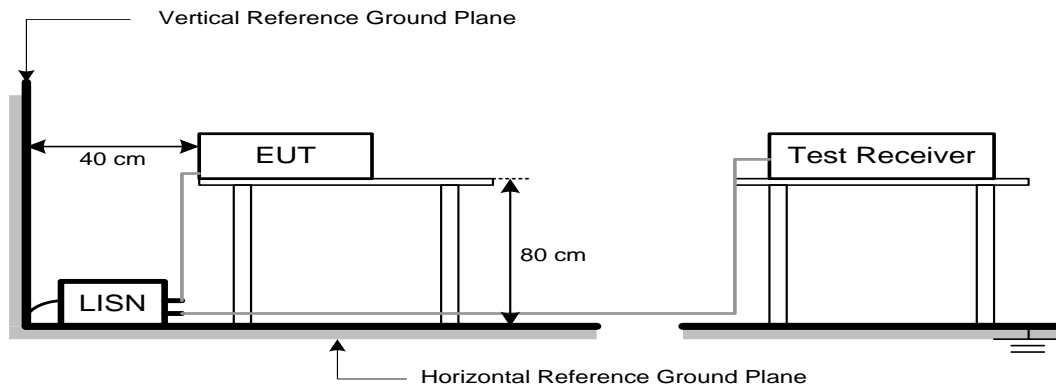

3.5 EUT OPERATION CONDITIONS

EUT was programmed to be in continuously transmitting mode.

3.6 TEST RESULTS

Please refer to the APPENDIX A.

4. RADIATED EMISSIONS TEST

4.1 LIMIT

In case the emission fall within the restricted band specified on 15.205(a), then the 15.209(a) limit in the table below has to be followed.

LIMITS OF RADIATED EMISSION MEASUREMENT (9 kHz-1000 MHz)

Frequency (MHz)	Field Strength (microvolts/meter)	Measurement Distance (meters)
0.009-0.490	2400/F(kHz)	300
0.490-1.705	24000/F(kHz)	30
1.705-30.0	30	30
30-88	100	3
88-216	150	3
216-960	200	3
Above 960	500	3

LIMITS OF RADIATED EMISSION MEASUREMENT (Above 1000 MHz)

Frequency (MHz)	(dBuV/m at 3 m)	
	Peak	Average
Above 1000	74	54

NOTE:

- (1) The limit for radiated test was performed according to FCC PART 15C.
- (2) The tighter limit applies at the band edges.
- (3) Emission level (dBuV/m)=20log Emission level (uV/m).
- (4) The test result calculated as following:
 Measurement Value = Reading Level + Correct Factor
 Correct Factor = Antenna Factor + Cable Loss - Amplifier Gain(if use)
 Margin Level = Measurement Value - Limit Value

Spectrum Parameter	Setting
Attenuation	Auto
Start Frequency	1000 MHz
Stop Frequency	10th carrier harmonic
RBW / VBW (Emission in restricted band)	1 MHz / 3 MHz for Peak, 1 MHz / 1/T for Average

Receiver Parameter	Setting
Attenuation	Auto
Start ~ Stop Frequency	9 kHz~90 kHz for PK/AVG detector
Start ~ Stop Frequency	90 kHz~110 kHz for QP detector
Start ~ Stop Frequency	110 kHz~490 kHz for PK/AVG detector
Start ~ Stop Frequency	490 kHz~30 MHz for QP detector
Start ~ Stop Frequency	30 MHz~1000 MHz for QP detector

4.2 TEST PROCEDURE

- a. The measuring distance of 3 m shall be used for measurements. The EUT was placed on the top of a rotating table 0.8 meter above the ground at a 3 meter semi-anechoic chamber. The table was rotated 360 degrees to determine the position of the highest radiation.(below 1 GHz)
- b. The measuring distance of 3 m shall be used for measurements. The EUT was placed on the top of a rotating table 1.5 meter above the ground at a 3 meter semi-anechoic chamber. The table was rotated 360 degrees to determine the position of the highest radiation.(above 1 GHz)
- c. The height of the equipment or of the substitution antenna shall be 0.8m or 1.5m; the height of the test antenna shall vary between 1 m to 4 m. Both horizontal and vertical polarizations of the antenna are set to make the measurement.
- d. For each suspected emission, the EUT was arranged to its worst case and then the antenna was tuned to heights find the maximum reading (used Bore sight function).
- e. The receiver system was set to peak and average detect function and specified bandwidth with maximum hold mode when the test frequency is above 1 GHz.
- f. The initial step in collecting radiated emission data is a receiver peak detector mode pre-scanning the measurement frequency range. Significant peaks are then marked and then Quasi Peak detector mode re-measured.
- g. All readings are Peak unless otherwise stated QP in column of Note. Peak denotes that the Peak reading compliance with the QP Limits and then QP Mode measurement didn't perform.
(below 1 GHz)
- h. All readings are Peak Mode value unless otherwise stated AVG in column of Note. If the Peak Mode Measured value compliance with the Peak Limits and lower than AVG Limits, the EUT shall be deemed to meet both Peak & AVG Limits and then only Peak Mode was measured, but AVG Mode didn't perform. (above 1 GHz)
- i. For the actual test configuration, please refer to the related Item -EUT Test Photos.

4.3 DEVIATION FROM TEST STANDARD

No deviation

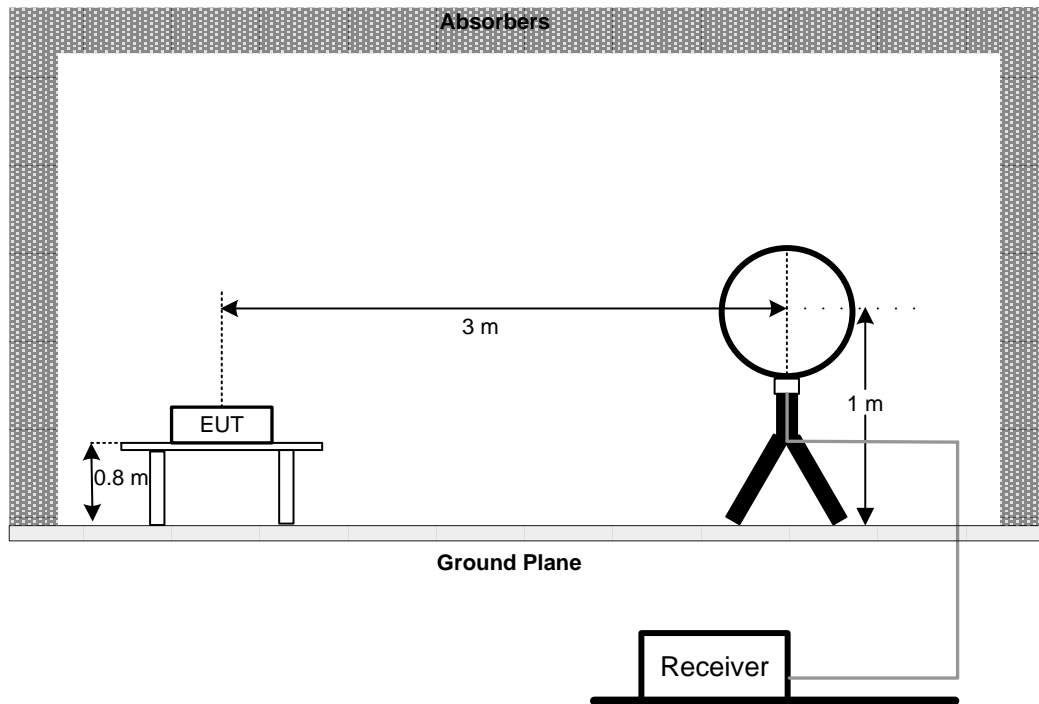
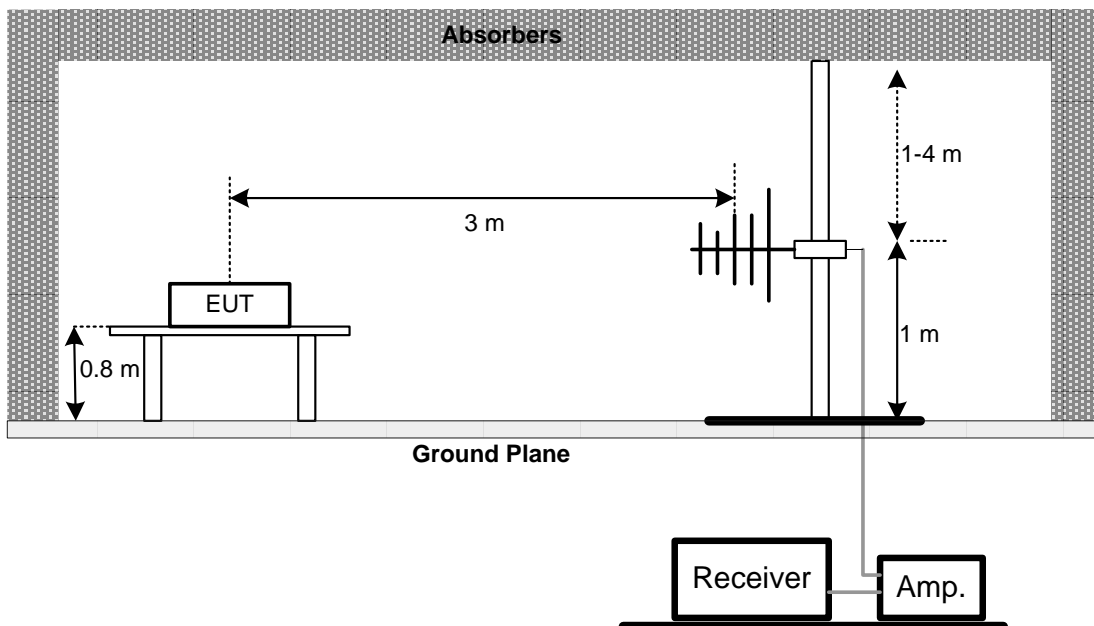
4.4 TEST SETUP**9 kHz-30 MHz****30 MHz to 1 GHz**

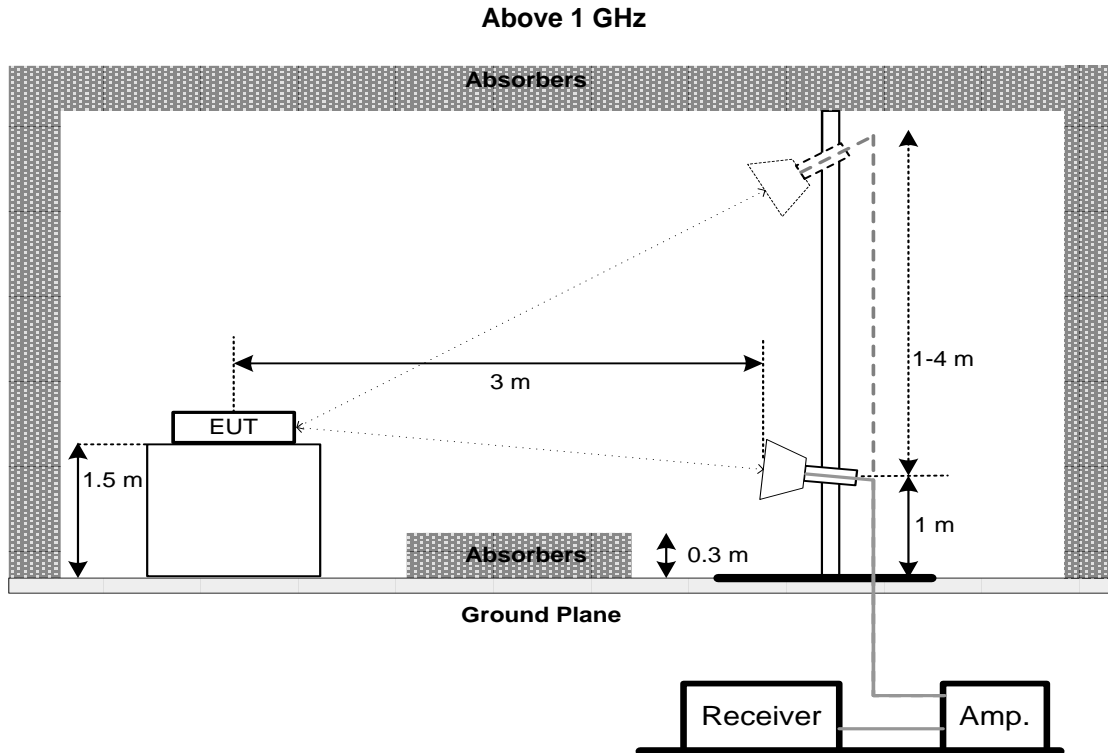

4.5 EUT OPERATION CONDITIONS

The EUT was programmed to be in continuously transmitting mode.

4.6 TEST RESULTS - 9 KHZ TO 30 MHZ

Please refer to the APPENDIX B

Remark:

- (1) Distance extrapolation factor = $40 \log (\text{specific distance} / \text{test distance})$ (dB).
- (2) Limit line = specific limits (dBuV) + distance extrapolation factor.

4.7 TEST RESULTS - 30 MHZ TO 1000 MHZ

Please refer to the APPENDIX C.

4.8 TEST RESULTS - ABOVE 1000 MHZ

Please refer to the APPENDIX D.

Remark:

- (1) No limit: This is fundamental signal, the judgment is not applicable.
For fundamental signal judgment was referred to Peak output test.

5. BANDWIDTH TEST

5.1 LIMIT

FCC Part15, Subpart C (15.247)		
Section	Test Item	Limit
15.247(a)(2)	6 dB Bandwidth	Minimum 500 kHz
	99% Emission Bandwidth	-

5.2 TEST PROCEDURE

- a. The EUT was directly connected to the spectrum analyzer and antenna output port as show in the block diagram below.
- b. Spectrum Setting:
 - For 6 dB Bandwidth : RBW= 100 kHz, VBW=300 kHz, Sweep time = auto.
 - For 99% Emission Bandwidth B/G/N-20 Mode: RBW= 300 KHz, VBW=1 MHz, Sweep time = 2.5 ms.
 - For 99% Emission Bandwidth N-40 Mode: RBW= 1 MHz, VBW=3 MHz, Sweep time = 2.5 ms.
- c. The bandwidth was performed in accordance with method 11.8.1 of ANSI C63.10-2013.

5.3 DEVIATION FROM STANDARD

No deviation.

5.4 TEST SETUP



5.5 EUT OPERATION CONDITIONS

The EUT was programmed to be in continuously transmitting mode.

5.6 TEST RESULTS

Please refer to the APPENDIX E.

6. MAXIMUM OUTPUT POWER TEST

6.1 LIMIT

FCC Part15, Subpart C (15.247)		
Section	Test Item	Limit
15.247(b)(3)	Maximum Output Power	1 Watt or 30dBm

6.2 TEST PROCEDURE

- The EUT was directly connected to the power meter and antenna output port as show in the block diagram below.
- The maximum conducted output power was performed in accordance with method 11.9.1.3 (for peak power) or 11.9.2.3.1 (for AVG power) of ANSI C63.10-2013.

6.3 DEVIATION FROM STANDARD

No deviation.

6.4 TEST SETUP



6.5 EUT OPERATION CONDITIONS

The EUT was programmed to be in continuously transmitting mode.

6.6 TEST RESULTS

Please refer to the APPENDIX F.

7. CONDUCTED SPURIOUS EMISSIONS

7.1 LIMIT

In any 100 kHz bandwidth outside the frequency band in which the spread spectrum or digitally modulated intentional radiator is operating, the radio frequency power that is produced by the intentional radiator shall be at least 20 dB below that in the 100 kHz bandwidth within the band that contains the highest level of the desired power, based on either an RF conducted or a radiated measurement, provided the transmitter demonstrates compliance with the peak Output Power limits. If the transmitter complies with the Output Power limits based on the use of RMS averaging over a time interval, as permitted under paragraph (b)(3) of this section, the attenuation required under this paragraph shall be 30 dB instead of 20 dB. Attenuation below the general limits specified in Section 15.209(a) is not required.

7.2 TEST PROCEDURE

- a. The EUT was directly connected to the spectrum analyzer and antenna output port as show in the block diagram below.
- b. Spectrum Setting: RBW= 100 kHz, VBW=300 kHz, Sweep time = Auto.

7.3 DEVIATION FROM STANDARD

No deviation.

7.4 TEST SETUP



7.5 EUT OPERATION CONDITIONS

The EUT was programmed to be in continuously transmitting mode.

7.6 TEST RESULTS

Please refer to the APPENDIX G.

8. POWER SPECTRAL DENSITY TEST

8.1 LIMIT

FCC Part15, Subpart C (15.247)		
Section	Test Item	Limit
15.247(e)	Power Spectral Density	8 dBm (in any 3 kHz)

8.2 TEST PROCEDURE

- The EUT was directly connected to the spectrum analyzer and antenna output port as show in the block diagram below.
- Spectrum Setting: RBW=3 kHz, VBW=10 kHz, Sweep time = Auto.
- The Power Spectral Density was performed in accordance with method 11.10.2 of ANSI C63.10-2013.

8.3 DEVIATION FROM STANDARD

No deviation.

8.4 TEST SETUP

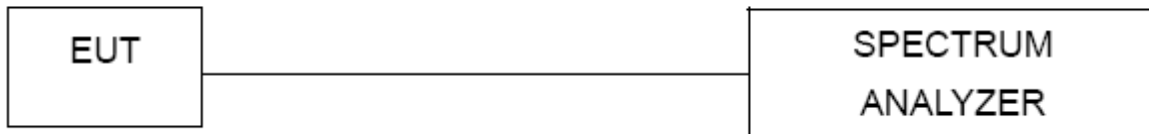

8.5 EUT OPERATION CONDITIONS

The EUT was programmed to be in continuously transmitting mode.

8.6 TEST RESULTS

Please refer to the APPENDIX H.

9. MEASUREMENT INSTRUMENTS LIST

AC Power Line Conducted Emissions					
Item	Kind of Equipment	Manufacturer	Type No.	Serial No.	Calibrated until
1	Line Impedance Stabilisation Network	Schwarzbeck	NNLK 8121	8121-822	Mar. 21, 2021
2	TWO-LINE V-NETWORK	R&S	ENV216	101340	Sep. 01, 2020
3	Test Cable	emci	EMCRG400-BM-N M-10000	170628	Jul. 15, 2020
4	EMI Test Receiver	R&S	ESCI	100082	Mar. 28, 2021
5	50Ω Terminator	SHX	TF2-1G-A	17051602	Mar. 21, 2021
6	50Ω coaxial switch	Anritsu	MP59B	6201750902	Mar. 21, 2021
7	Measurement Software	Farad	EZ-EMC Ver.NB-03A1-01	N/A	N/A

Radiated Emissions - 9 kHz to 30 MHz					
Item	Kind of Equipment	Manufacturer	Type No.	Serial No.	Calibrated until
1	Loop Antenna	EMCI	EMCI LPA600	275	Mar. 28, 2021
2	EMI Test Receiver	R&S	ESCI	100082	Mar. 28, 2021
3	Measurement Software	Farad	EZ-EMC Ver.NB-03A1-01	N/A	N/A

Radiated Emissions - 30 MHz to 1 GHz					
Item	Kind of Equipment	Manufacturer	Type No.	Serial No.	Calibrated until
1	TRILOG Broadband Antenna	Schwarzbeck	VULB 9168	719	Mar. 28, 2021
2	Pre-Amplifier	emci	EMC9135	980400	Mar. 21, 2021
3	MXE EMI Receiver	Keysight	N9038A	MY57150106	Mar. 21, 2021
4	Test Cable	emci	EMC104-SM-SM-7000	170330	Apr. 16, 2021
5	Test Cable	emci	EMC104-SM-SM-1000	170331	Apr. 16, 2021
6	Test Cable	emci	EMC104-SM-NM-3500	170621	Apr. 16, 2021
7	Measurement Software	Farad	EZ-EMC Ver.NB-03A1-01	N/A	N/A

Radiated Emissions - Above 1 GHz					
Item	Kind of Equipment	Manufacturer	Type No.	Serial No.	Calibrated until
1	Double-Ridged Waveguide Horn Antenna	ETS-Lindgren	9120D	00206960	Mar. 28, 2021
2	Pre-Amplifier	emci	EMC012645SE	980421	Mar. 28, 2021
3	EXA Spectrum Analyzer	Keysight	N9010A	MY56480545	Mar. 21, 2021
4	Test Cable	emci	EMC104-SM-SM-7000	170330	Apr. 16, 2021
5	Test Cable	emci	EMC104-SM-SM-1000	170331	Apr. 16, 2021
6	Test Cable	emci	EMC104-SM-NM-3500	170621	Apr. 16, 2021
7	Measurement Software	Farad	EZ-EMC Ver.NB-03A1-01	N/A	N/A
8	MXE EMI Receiver	Keysight	N9038A	MY57150106	Mar. 28, 2021
9	Antenna	Schwarzbeck	BBHA9170	9170-651	Apr. 02, 2021
10	Pre-Amplifier	EMC INSTRUMENT	EMC184045B	980265	Mar. 21, 2021
11	EXA Spectrum Analyzer	Keysight	N9010A	MY56480579	Mar. 21, 2021
12	Test Cable	emci	EMC102-SM-SM-800	170335	Apr. 13, 2021
13	Test Cable	emci	EMC102-KM-KM-2500	170627	Apr. 13, 2021

Bandwidth					
Item	Kind of Equipment	Manufacturer	Type No.	Serial No.	Calibrated until
1	Spectrum Analyzer	R&S	FSP40	100626	Mar. 21, 2021

Maximum Output Power					
Item	Kind of Equipment	Manufacturer	Type No.	Serial No.	Calibrated until
1	Peak Power Analyze	Keysight	8990B	MY51000507	Mar. 21, 2021
2	Wideband Power Sensor	Keysight	N9123A	MY58310003	Mar. 21, 2021

Antenna Conducted Spurious Emissions					
Item	Kind of Equipment	Manufacturer	Type No.	Serial No.	Calibrated until
1	Spectrum Analyzer	R&S	FSP40	100626	Mar. 21, 2021

Power Spectral Density					
Item	Kind of Equipment	Manufacturer	Type No.	Serial No.	Calibrated until
1	Spectrum Analyzer	R&S	FSP40	100626	Mar. 21, 2021

Remark: "N/A" denotes no model name, serial no. or calibration specified.

All calibration period of equipment list is one year.

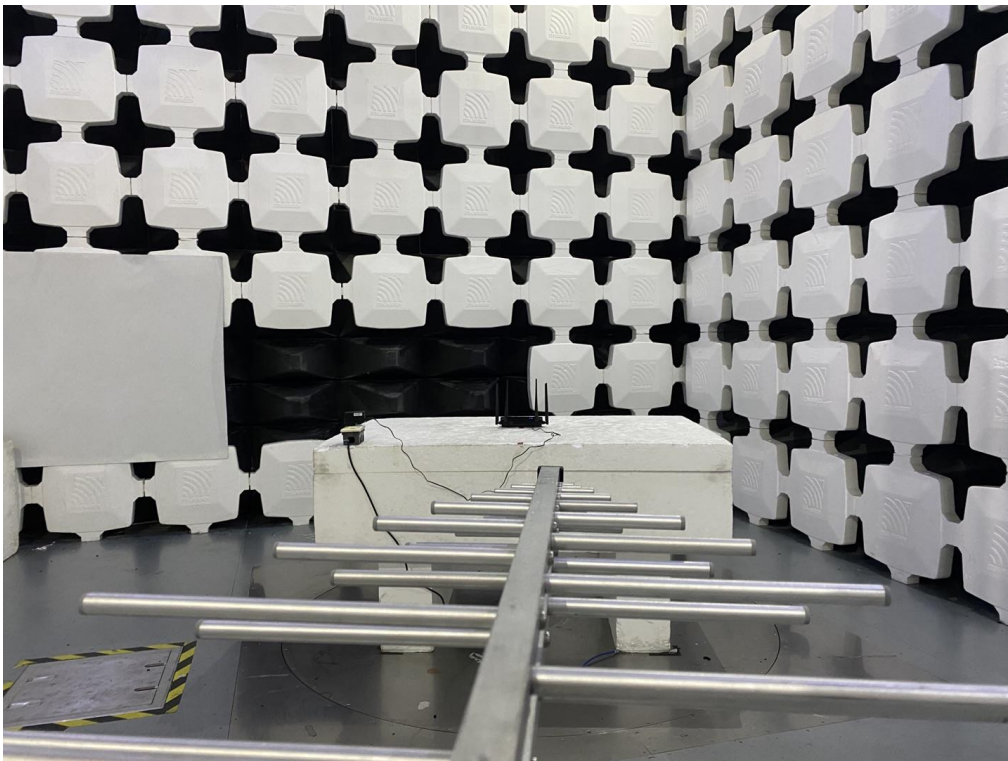
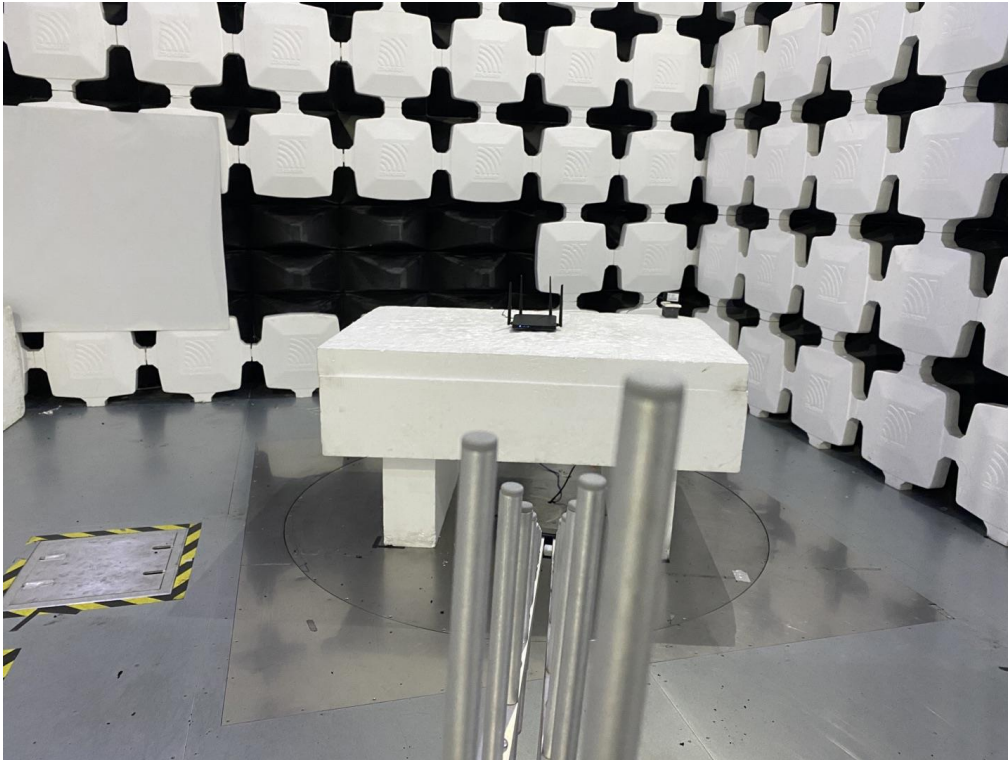
10. EUT TEST PHOTO**Radiated Emissions Test Photos****30 MHz to 1 GHz**

Radiated Emissions Test Photos

Above 1 GHz

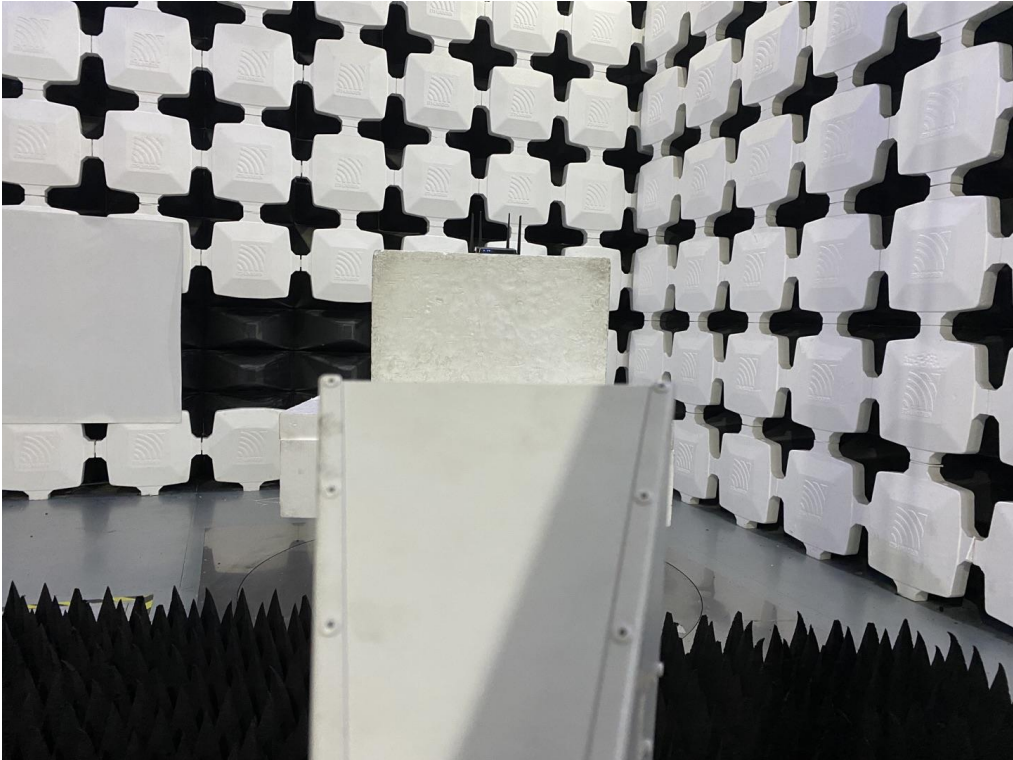
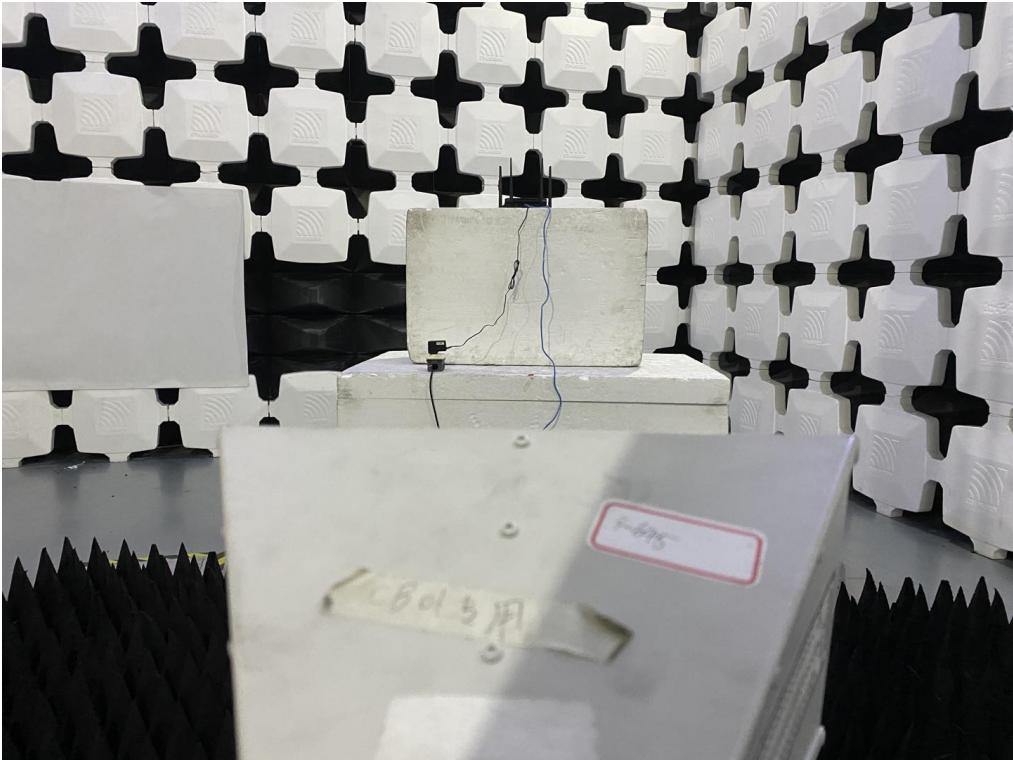

APPENDIX A - AC POWER LINE CONDUCTED EMISSIONS

Test Mode: TX N20 Mode Channel 06

Line

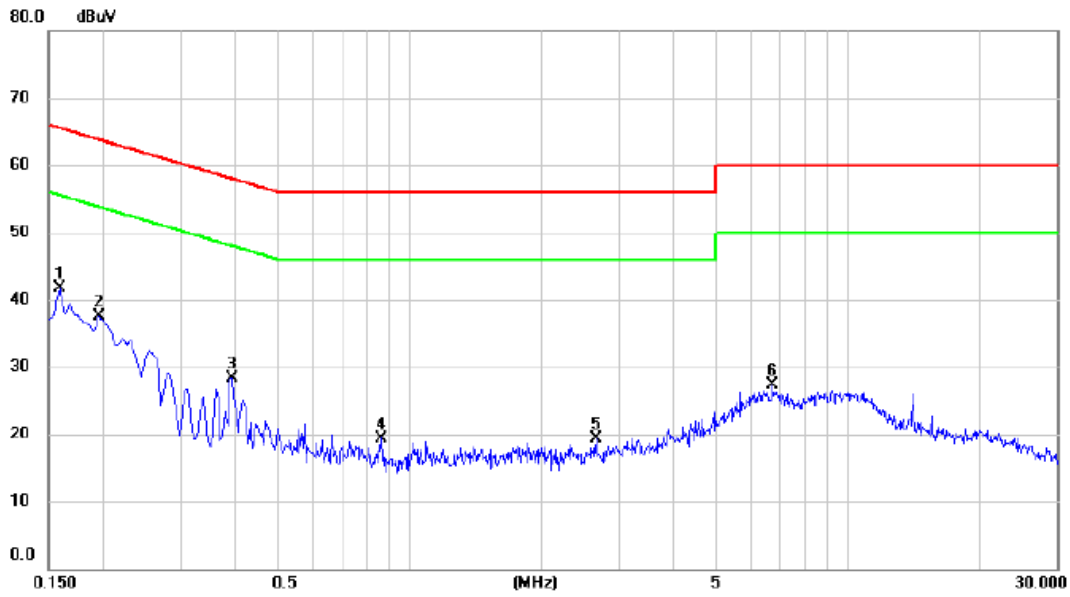

No.	Mk.	Freq. MHz	Reading Level dBuV	Correct Factor dB	Measure- ment dBuV	Limit dBuV	Margin dB	Detector	Comment
1	*	0.1590	32.03	9.74	41.77	65.52	-23.75	peak	
2		0.1950	27.75	9.78	37.53	63.82	-26.29	peak	
3		0.3930	18.52	9.86	28.38	58.00	-29.62	peak	
4		0.8610	9.61	9.79	19.40	56.00	-36.60	peak	
5		2.6700	9.45	9.84	19.29	56.00	-36.71	peak	
6		6.7380	17.25	10.06	27.31	60.00	-32.69	peak	

REMARKS:

- (1) Measurement Value = Reading Level + Correct Factor.
- (2) Margin Level = Measurement Value - Limit Value.

Test Mode: TX N20 Mode Channel 06

Neutral

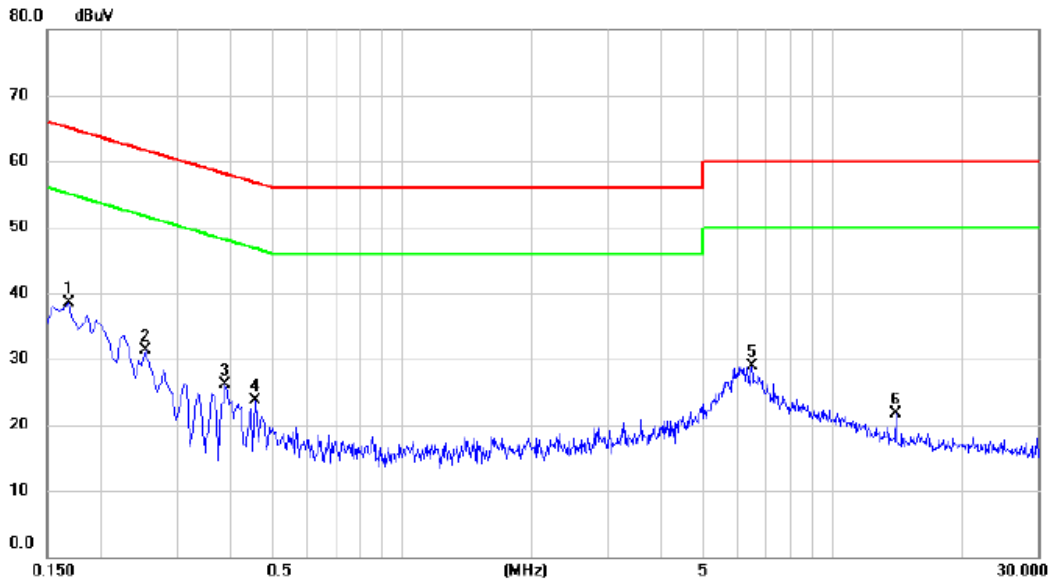

No.	Mk.	Freq. MHz	Reading Level dBuV	Correct Factor dB	Measure- ment dBuV	Limit dBuV	Margin dB	Detector	Comment
1	*	0.1680	28.93	9.61	38.54	65.06	-26.52	peak	
2		0.2535	21.67	9.65	31.32	61.64	-30.32	peak	
3		0.3885	16.45	9.67	26.12	58.10	-31.98	peak	
4		0.4560	14.03	9.69	23.72	56.77	-33.05	peak	
5		6.5175	18.94	10.04	28.98	60.00	-31.02	peak	
6		14.0010	11.54	10.15	21.69	60.00	-38.31	peak	

REMARKS:

- (1) Measurement Value = Reading Level + Correct Factor.
- (2) Margin Level = Measurement Value - Limit Value.

APPENDIX B - RADIATED EMISSION - 9 KHZ TO 30 MHZ

Note: Below 30MHz, The measured value have enough margin over 20dB than the limit,
therefore they are not reported

APPENDIX C - RADIATED EMISSION - 30 MHZ TO 1000 MHZ

Test Mode: TX N20 Mode Channel 06

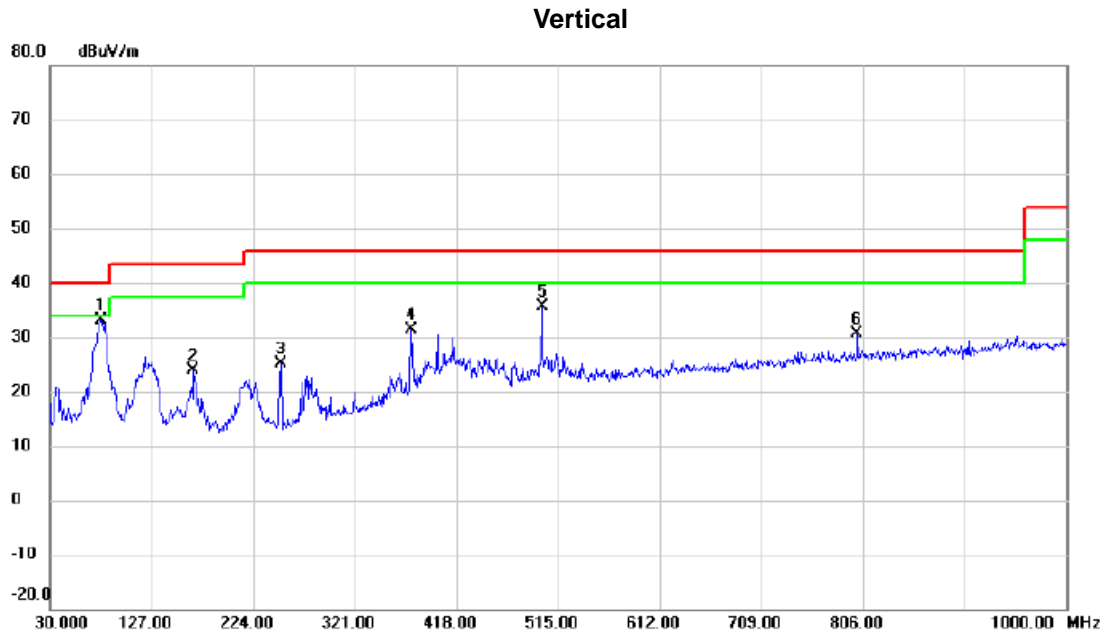

No.	Mk.	Freq. MHz	Reading Level dBuV	Correct Factor dB	Measure- ment dBuV/m	Limit dBuV/m	Margin dB	Detector	Comment
1	*	78.0150	53.19	-20.03	33.16	40.00	-6.84	peak	
2		166.7700	39.55	-15.70	23.85	43.50	-19.65	peak	
3		250.1900	41.68	-16.67	25.01	46.00	-20.99	peak	
4		374.8350	44.58	-13.11	31.47	46.00	-14.53	peak	
5		499.9650	45.92	-10.32	35.60	46.00	-10.40	peak	
6		800.1800	35.65	-5.13	30.52	46.00	-15.48	peak	

REMARKS:

- (1) Measurement Value = Reading Level + Correct Factor.
- (2) Margin Level = Measurement Value - Limit Value.

Test Mode: TX N20 Mode Channel 06

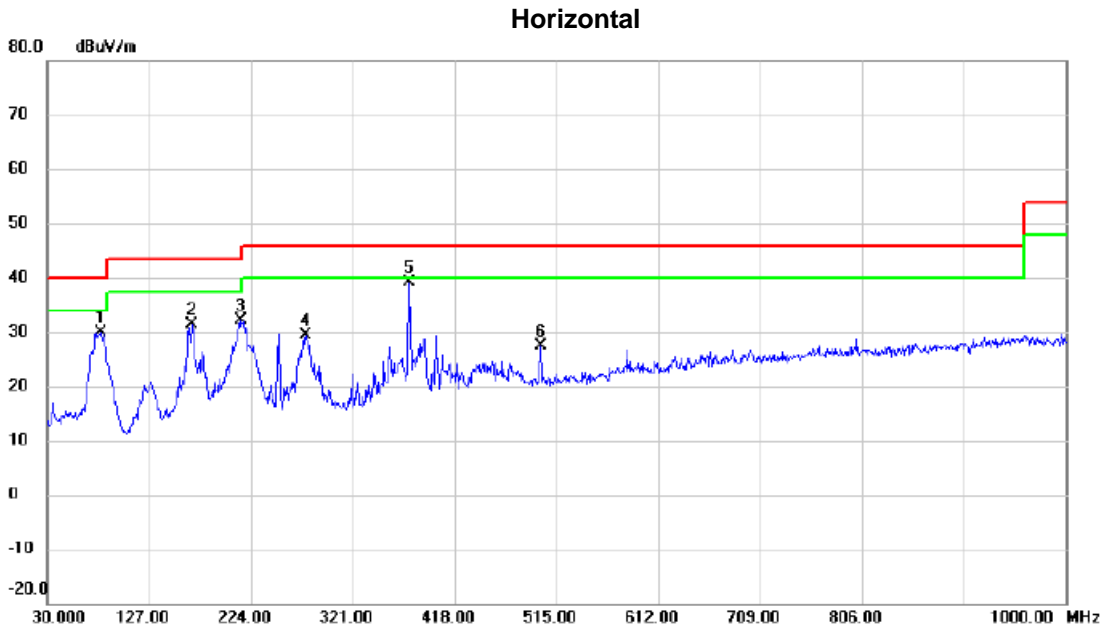

No.	Mk.	Freq. MHz	Reading Level dBuV	Correct Factor dB	Measure- ment dBuV/m	Limit dBuV/m	Margin dB	Detector	Comment
1		80.4400	50.54	-20.60	29.94	40.00	-10.06	peak	
2		168.2250	47.21	-15.73	31.48	43.50	-12.02	peak	
3		213.8150	50.83	-18.69	32.14	43.50	-11.36	peak	
4		276.3800	44.84	-15.54	29.30	46.00	-16.70	peak	
5	*	374.8350	52.27	-13.11	39.16	46.00	-6.84	peak	
6		499.9650	37.71	-10.32	27.39	46.00	-18.61	peak	

REMARKS:

- (1) Measurement Value = Reading Level + Correct Factor.
- (2) Margin Level = Measurement Value - Limit Value.

APPENDIX D - RADIATED EMISSION- ABOVE 1000 MHZ

Test Mode: TX B Mode 2412 MHz

Vertical

120 dBuV/m

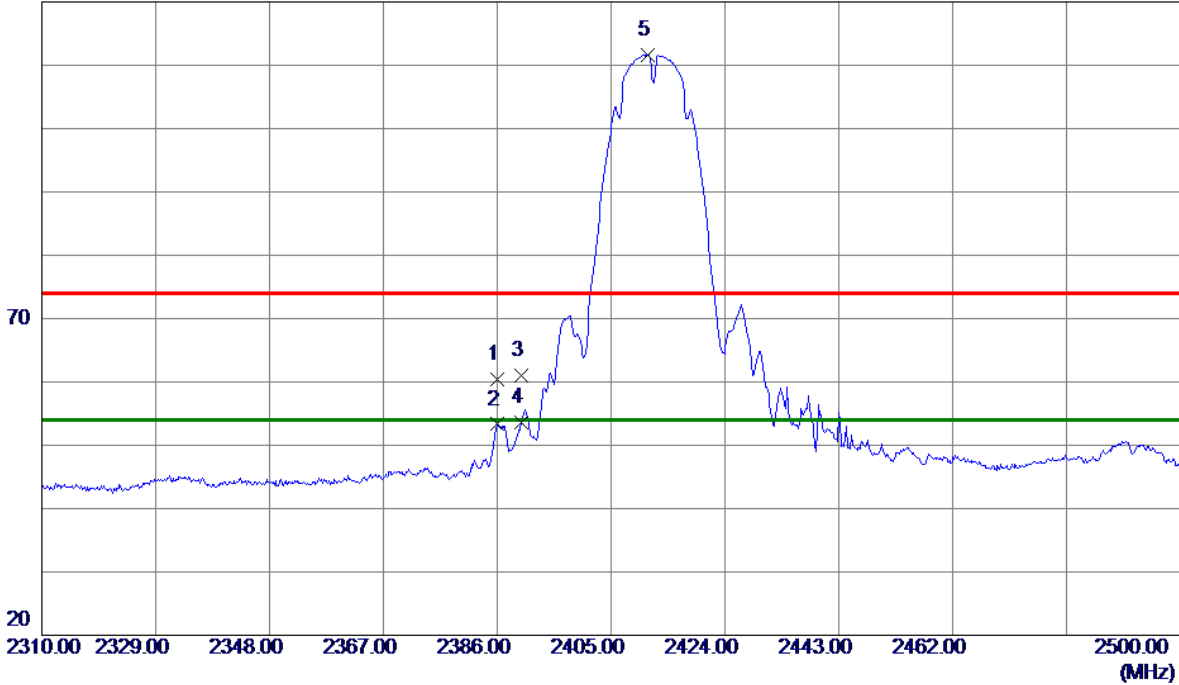

No.	Freq. MHz	Reading Level dBuV/m	Correct Factor dB	Measure ment dBuV/m	Limit dBuV/m	Margin dB	Detector	Comment
1	2386.0950	26.99	33.34	60.33	74.00	-13.67	Peak	
2	2386.0950	19.96	33.34	53.30	54.00	-0.70	AVG	
3	2390.0000	27.64	33.36	61.00	74.00	-13.00	Peak	
4	2390.0000	20.19	33.36	53.55	54.00	-0.45	AVG	
5 *	2411.1750	78.18	33.45	111.63	54.00	57.63	AVG	No limit

REMARKS:

- (1) Measurement Value = Reading Level + Correct Factor.
- (2) Margin Level = Measurement Value - Limit Value.

Test Mode: TX B Mode 2412 MHz

Vertical

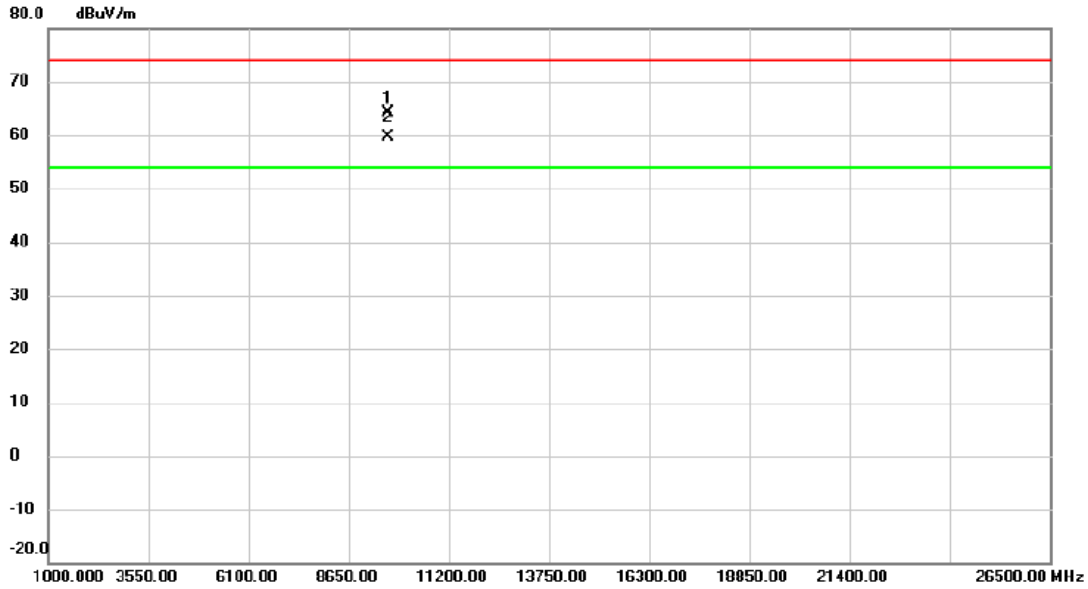

No.	Mk.	Freq. MHz	Reading Level dBuV	Correct Factor dB	Measure- ment dBuV/m	Limit dBuV/m	Margin dB	Detector	Comment
1		9644.500	64.46	-0.43	64.03	74.00	-9.97	peak	
2	*	9644.500	60.18	-0.43	59.75	61.63	-1.88	AVG	

REMARKS:

- (1) Measurement Value = Reading Level + Correct Factor.
- (2) Margin Level = Measurement Value - Limit Value.
- (3) "*" is not in restricted band, its limit is 30dBc of the fundamental emission level(111.3dBuV/m) or 15.209 Which is higher.

Test Mode: TX B Mode 2412 MHz

Horizontal

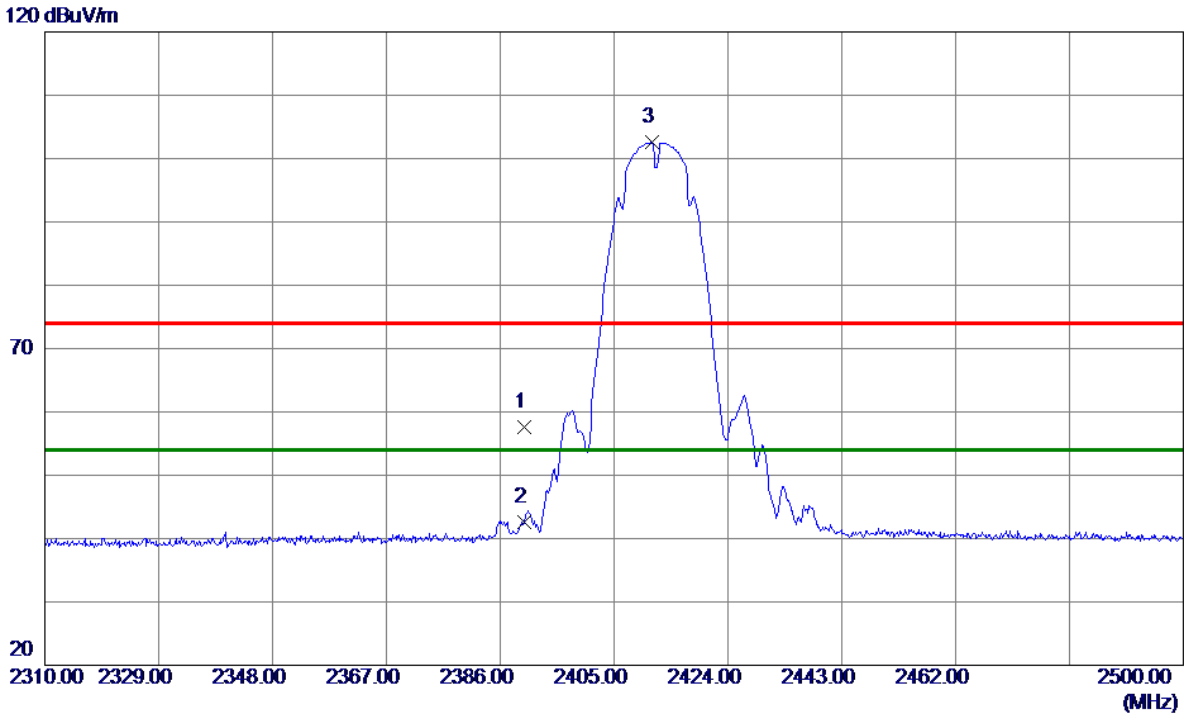

No.	Freq. MHz	Reading Level dBuV/m	Correct Factor dB	Measure ment dBuV/m	Limit dBuV/m	Margin dB	Detector	Comment
1	2390.0000	24.31	33.36	57.67	74.00	-16.33	Peak	
2	2390.0000	9.29	33.36	42.65	54.00	-11.35	AVG	
3 *	2411.2700	69.11	33.45	102.56	54.00	48.56	AVG	No limit

REMARKS:

- (1) Measurement Value = Reading Level + Correct Factor.
- (2) Margin Level = Measurement Value - Limit Value.

Test Mode: TX B Mode 2412 MHz

Horizontal

80 dBuV/m

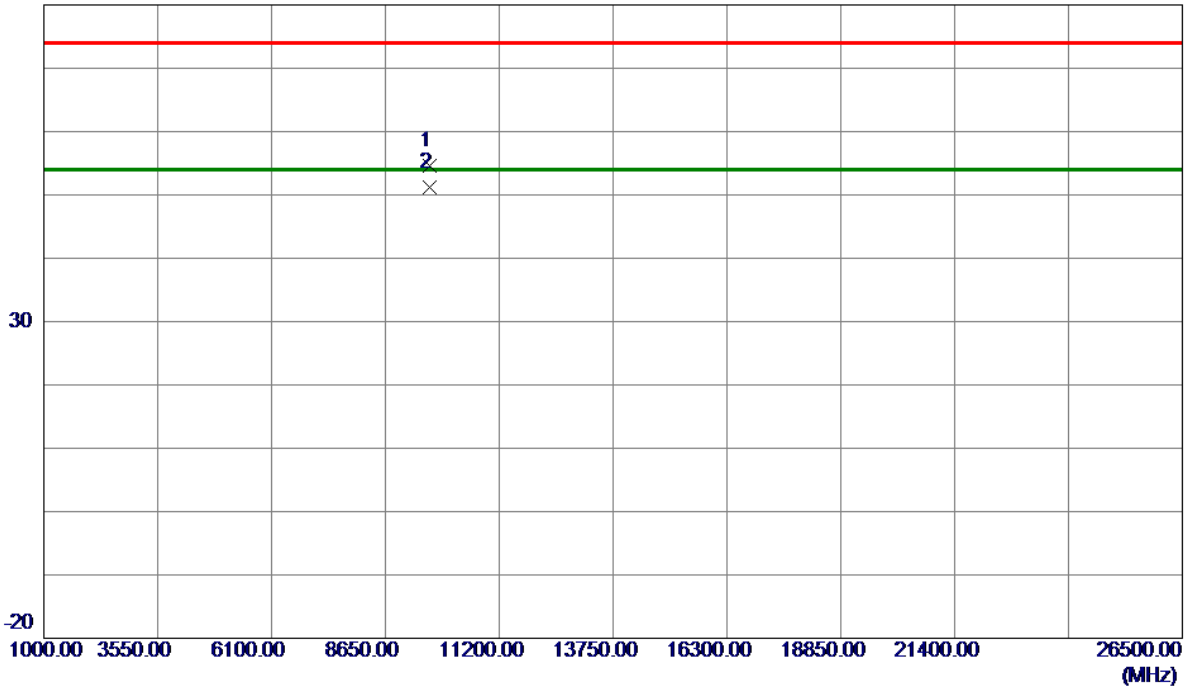

No.	Freq. MHz	Reading Level dBuV/m	Correct Factor dB	Measure ment dBuV/m	Limit dBuV/m	Margin dB	Detector	Comment
1	9644.5000	55.03	-0.43	54.60	74.00	-19.40	Peak	
2 *	9644.5000	51.54	-0.43	51.11	54.00	-2.89	AVG	

REMARKS:

(1) Measurement Value = Reading Level + Correct Factor.

(2) Margin Level = Measurement Value - Limit Value.

(3) "*" is not in restricted band, its limit is 30dBc of the fundamental emission level(111.3dBuV/m) or 15.209 Which is higher.

Test Mode: TX B Mode 2437 MHz

Vertical

120 dBuV/m

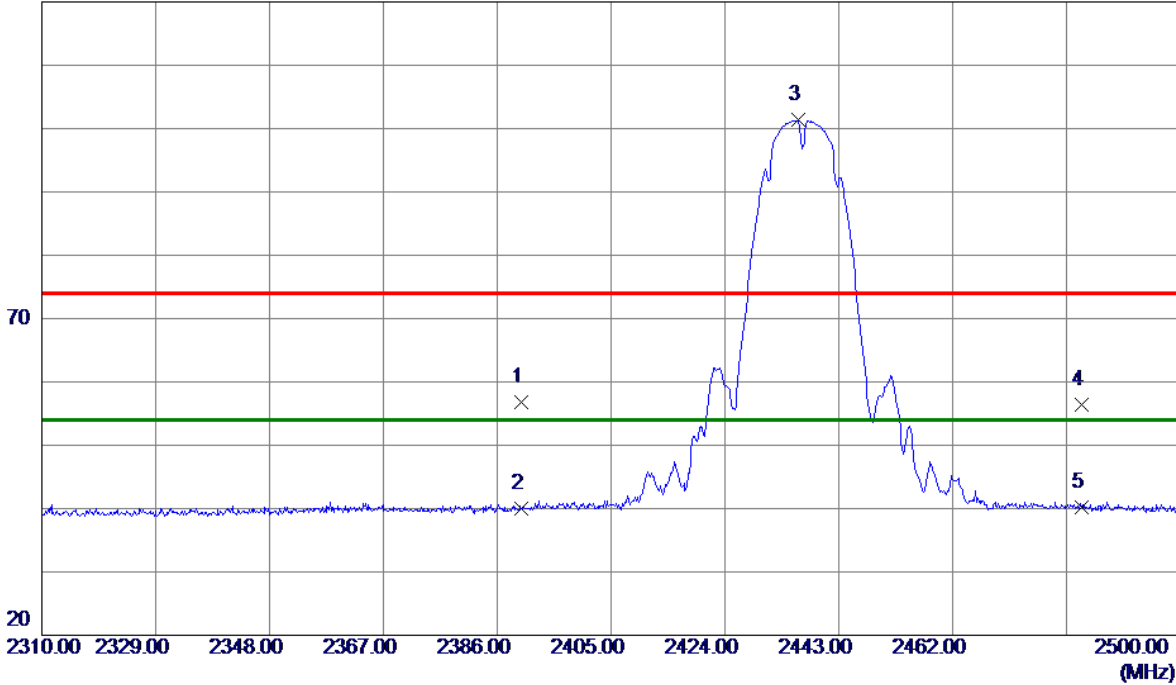

No.	Freq. MHz	Reading Level dBuV/m	Correct Factor dB	Measure ment dBuV/m	Limit dBuV/m	Margin dB	Detector	Comment
1	2390.0000	23.52	33.36	56.88	74.00	-17.12	Peak	
2	2390.0000	6.68	33.36	40.04	54.00	-13.96	AVG	
3 *	2436.2549	67.76	33.56	101.32	54.00	47.32	AVG	No limit
4	2483.5000	22.65	33.76	56.41	74.00	-17.59	Peak	
5	2483.5000	6.50	33.76	40.26	54.00	-13.74	AVG	

REMARKS:

- (1) Measurement Value = Reading Level + Correct Factor.
- (2) Margin Level = Measurement Value - Limit Value.

Test Mode: TX B Mode 2437 MHz

Vertical

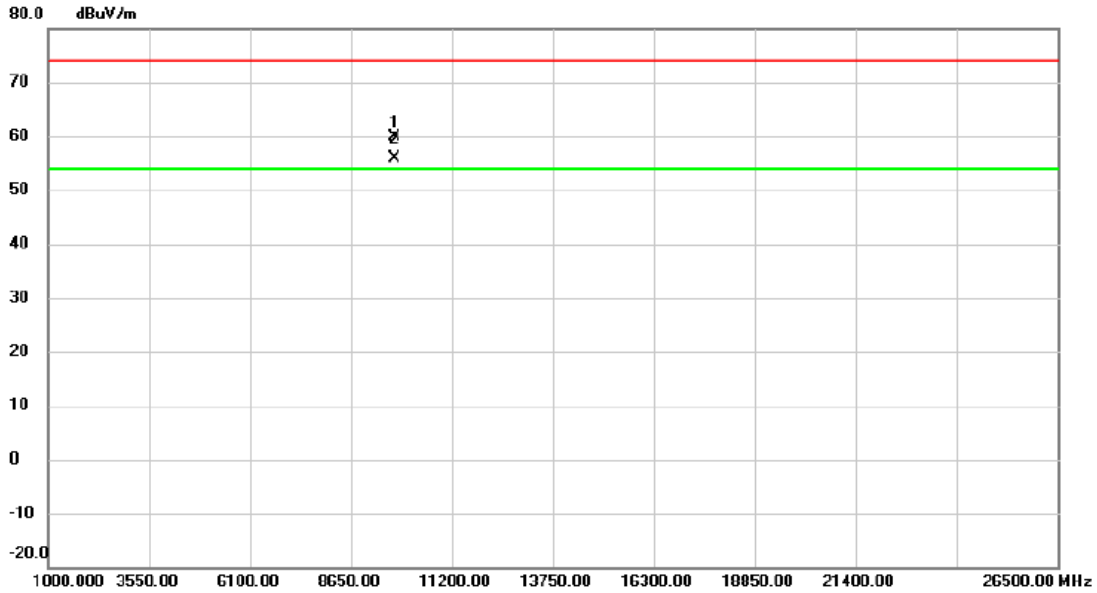

No.	Mk.	Freq. MHz	Reading Level dBuV	Correct Factor dB	Measure- ment dBuV/m	Limit dBuV/m	Margin dB	Detector	Comment
1		9746.500	60.42	-0.44	59.98	74.00	-14.02	peak	
2	*	9746.500	56.27	-0.44	55.83	62.05	-6.22	AVG	

REMARKS:

- (1) Measurement Value = Reading Level + Correct Factor.
- (2) Margin Level = Measurement Value - Limit Value.
- (3) "*" is not in restricted band, its limit is 30dBc of the fundamental emission level(111.3dBuV/m) or 15.209 Which is higher.

Test Mode: TX B Mode 2437 MHz

Horizontal

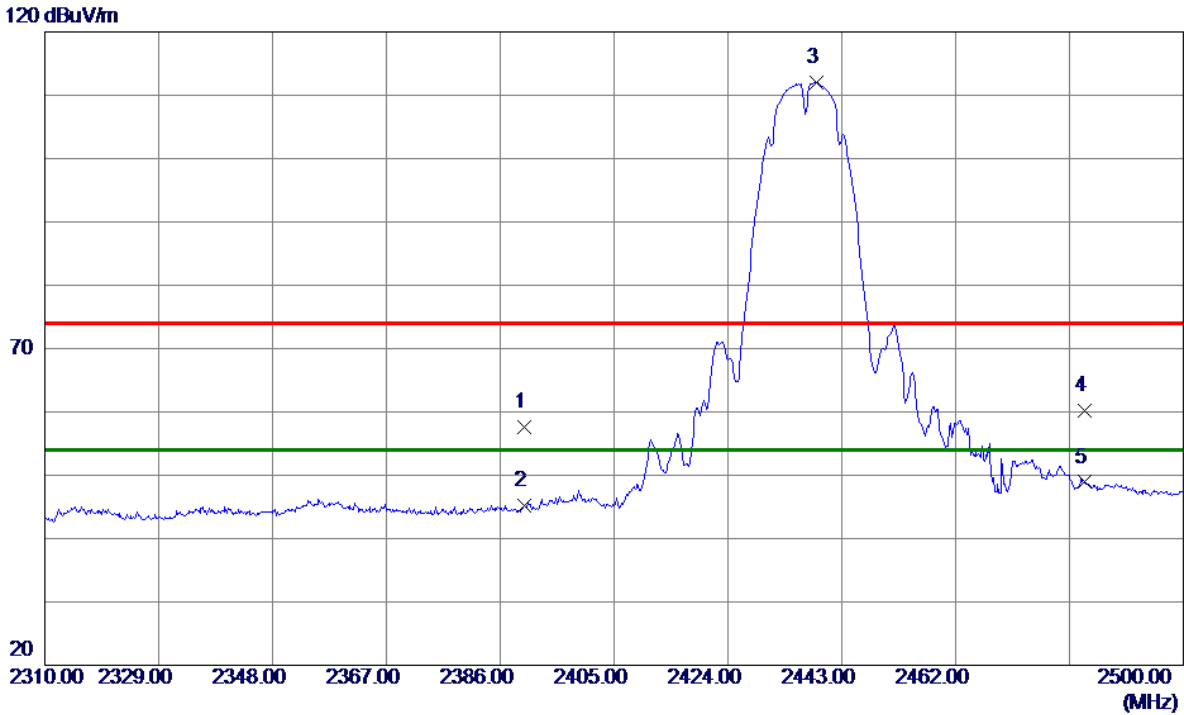

No.	Freq. MHz	Reading Level dBuV/m	Correct Factor dB	Measurement dBuV/m	Limit dBuV/m	Margin dB	Detector	Comment
1	2390.0000	24.25	33.36	57.61	74.00	-16.39	Peak	
2	2390.0000	11.79	33.36	45.15	54.00	-8.85	AVG	
3 *	2438.7250	78.48	33.57	112.05	54.00	58.05	AVG	No limit
4	2483.5000	26.42	33.76	60.18	74.00	-13.82	Peak	
5	2483.5000	15.14	33.76	48.90	54.00	-5.10	AVG	

REMARKS:

- (1) Measurement Value = Reading Level + Correct Factor.
- (2) Margin Level = Measurement Value - Limit Value.

Test Mode: TX B Mode 2437 MHz

Horizontal

80 dBuV/m

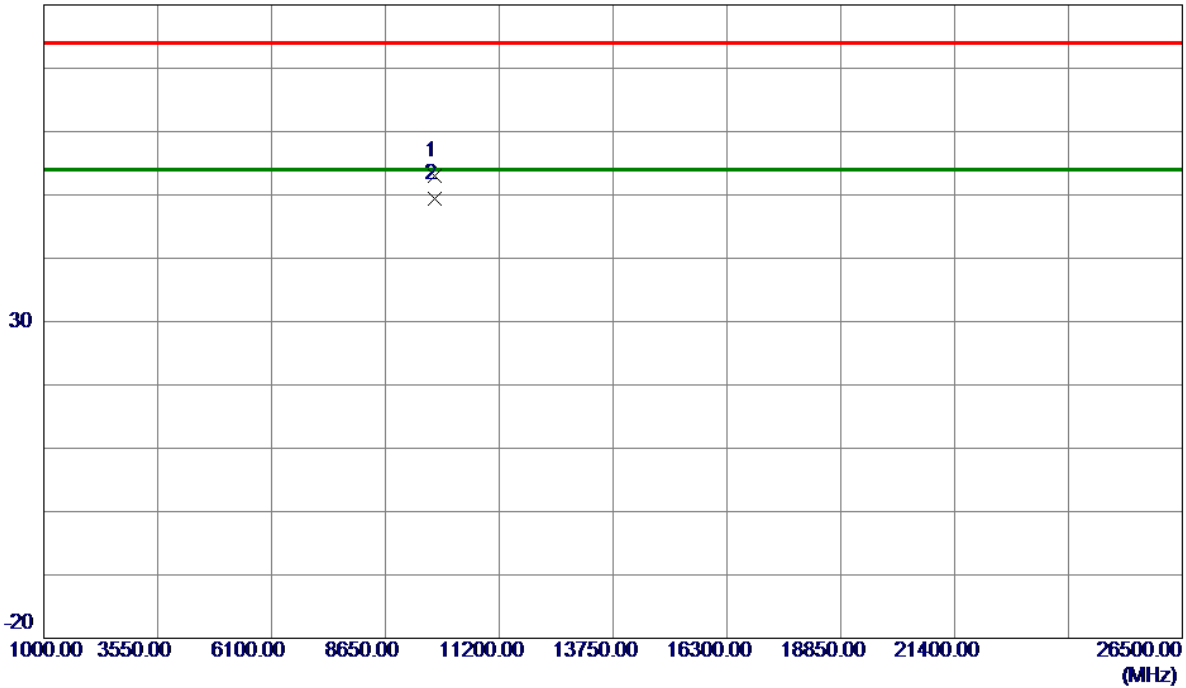

No.	Freq. MHz	Reading Level dBuV/m	Correct Factor dB	Measure ment dBuV/m	Limit dBuV/m	Margin dB	Detector	Comment
1	9746.5000	53.51	-0.44	53.07	74.00	-20.93	Peak	
2 *	9746.5000	49.90	-0.44	49.46	54.00	-4.54	AVG	

REMARKS:

(1) Measurement Value = Reading Level + Correct Factor.

(2) Margin Level = Measurement Value - Limit Value.

(3) "*" is not in restricted band, its limit is 30dBc of the fundamental emission level(111.3dBuV/m) or 15.209 Which is higher.

Test Mode: TX B Mode 2462 MHz

Vertical

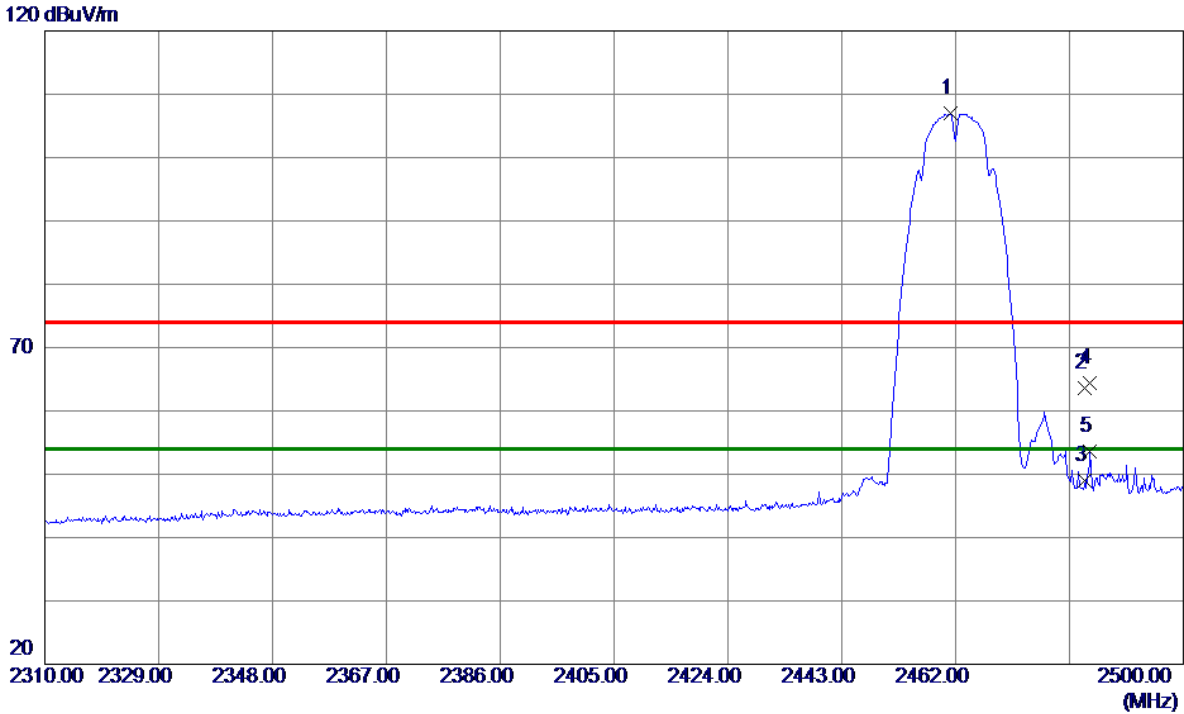

No.	Freq. MHz	Reading Level dBuV/m	Correct Factor dB	Measure ment dBuV/m	Limit dBuV/m	Margin dB	Detector	Comment
1 *	2461.2400	73.29	33.66	106.95	54.00	52.95	AVG	No limit
2	2483.5000	29.84	33.76	63.60	74.00	-10.40	Peak	
3	2483.5000	15.23	33.76	48.99	54.00	-5.01	AVG	
4	2484.4200	30.70	33.76	64.46	74.00	-9.54	Peak	
5	2484.4200	19.86	33.76	53.62	54.00	-0.38	AVG	

REMARKS:

- (1) Measurement Value = Reading Level + Correct Factor.
- (2) Margin Level = Measurement Value - Limit Value.

Test Mode: TX B Mode 2462 MHz

Vertical

80 dBuV/m

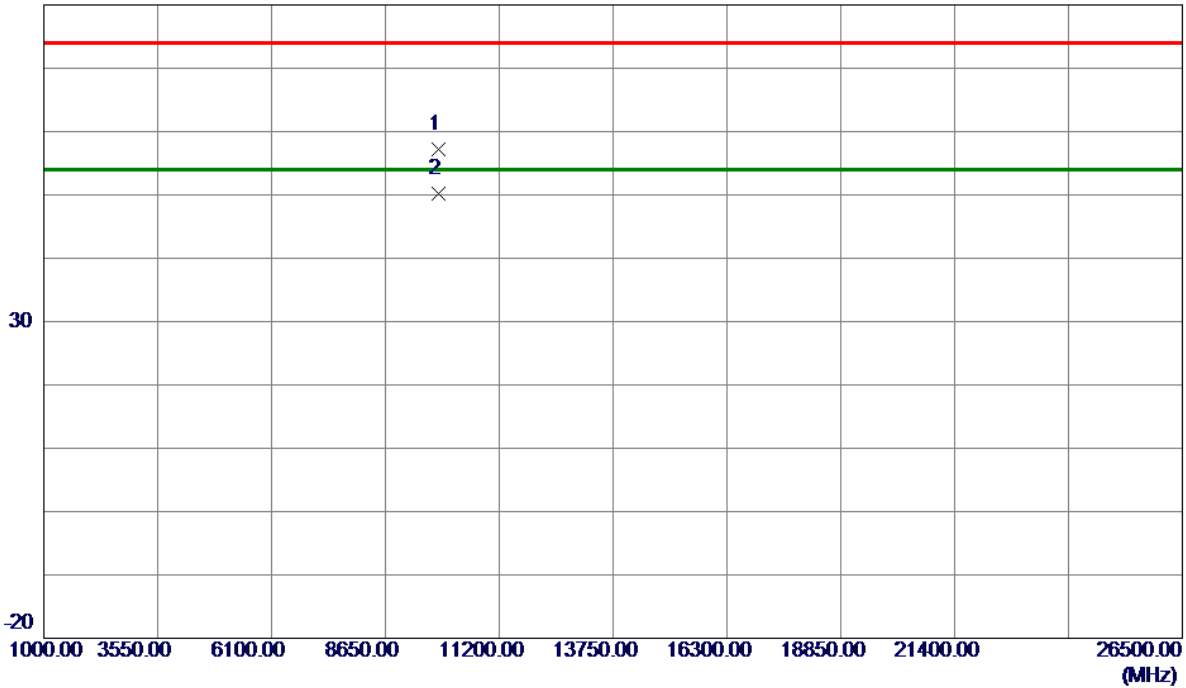

No.	Freq. MHz	Reading Level dBuV/m	Correct Factor dB	Measure ment dBuV/m	Limit dBuV/m	Margin dB	Detector	Comment
1	9848.5000	57.58	-0.45	57.13	74.00	-16.87	Peak	
2 *	9848.5000	50.68	-0.45	50.23	54.00	-3.77	AVG	

REMARKS:

- (1) Measurement Value = Reading Level + Correct Factor.
- (2) Margin Level = Measurement Value - Limit Value.
- (3) "*" is not in restricted band, its limit is 30dBc of the fundamental emission level(111.3dBuV/m) or 15.209 Which is higher.

Test Mode: TX B Mode 2462 MHz

Horizontal

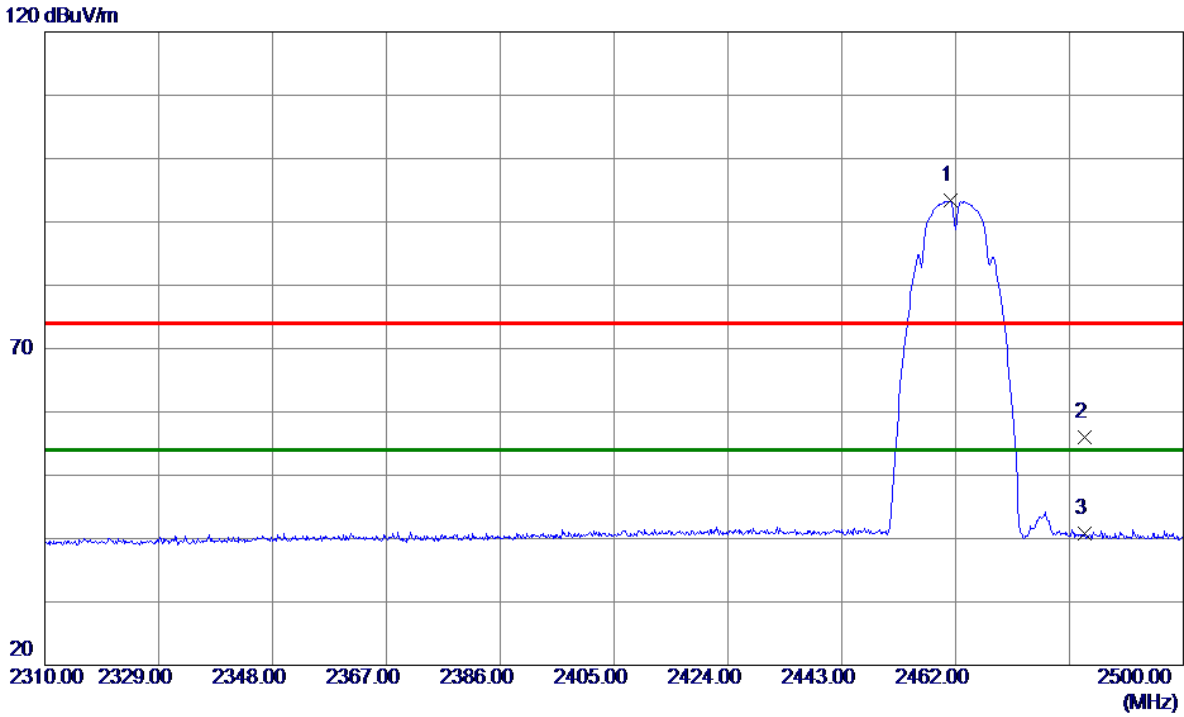

No.	Freq. MHz	Reading Level dBuV/m	Correct Factor dB	Measure ment dBuV/m	Limit dBuV/m	Margin dB	Detector	Comment
1 *	2461.1450	59.65	33.66	93.31	54.00	39.31	AVG	No limit
2	2483.5000	22.22	33.76	55.98	74.00	-18.02	Peak	
3	2483.5000	6.96	33.76	40.72	54.00	-13.28	AVG	

REMARKS:

- (1) Measurement Value = Reading Level + Correct Factor.
- (2) Margin Level = Measurement Value - Limit Value.

Test Mode: TX B Mode 2462 MHz

Horizontal

80 dBuV/m

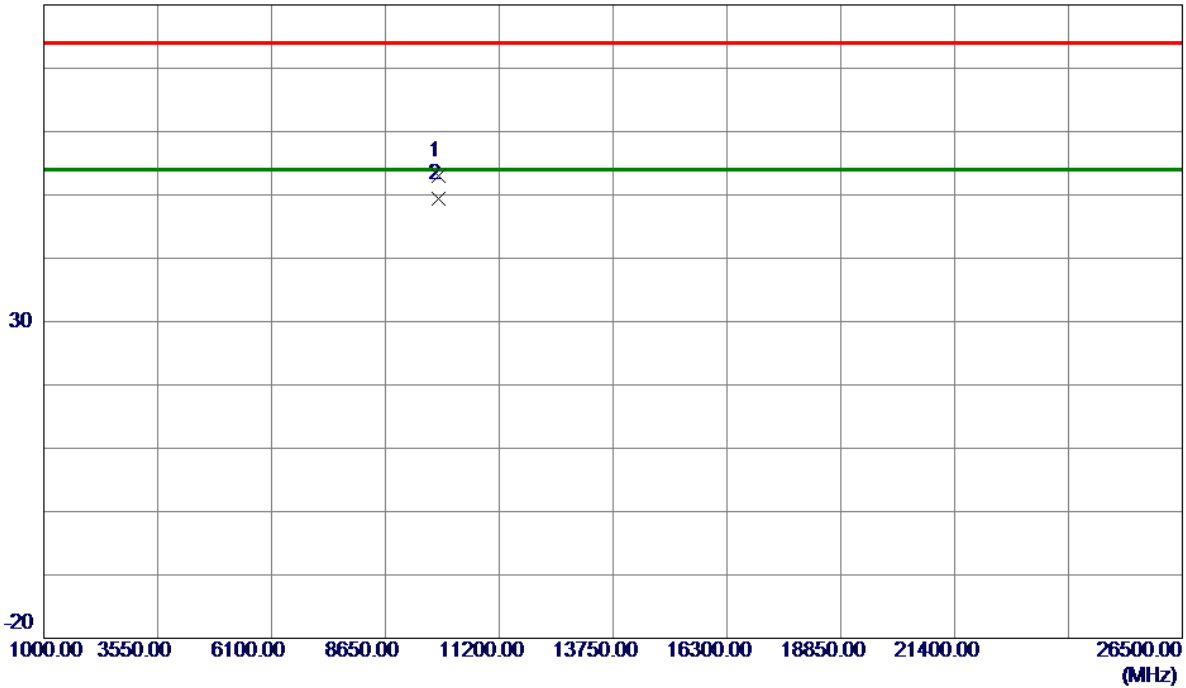

No.	Freq. MHz	Reading Level dBuV/m	Correct Factor dB	Measure ment dBuV/m	Limit dBuV/m	Margin dB	Detector	Comment
1	9848.5000	53.39	-0.45	52.94	74.00	-21.06	Peak	
2 *	9848.5000	49.85	-0.45	49.40	54.00	-4.60	AVG	

REMARKS:

- (1) Measurement Value = Reading Level + Correct Factor.
- (2) Margin Level = Measurement Value - Limit Value.
- (3) "*" is not in restricted band, its limit is 30dBc of the fundamental emission level(111.3dBuV/m) or 15.209 Which is higher.

Test Mode: TX G Mode 2412 MHz

Vertical

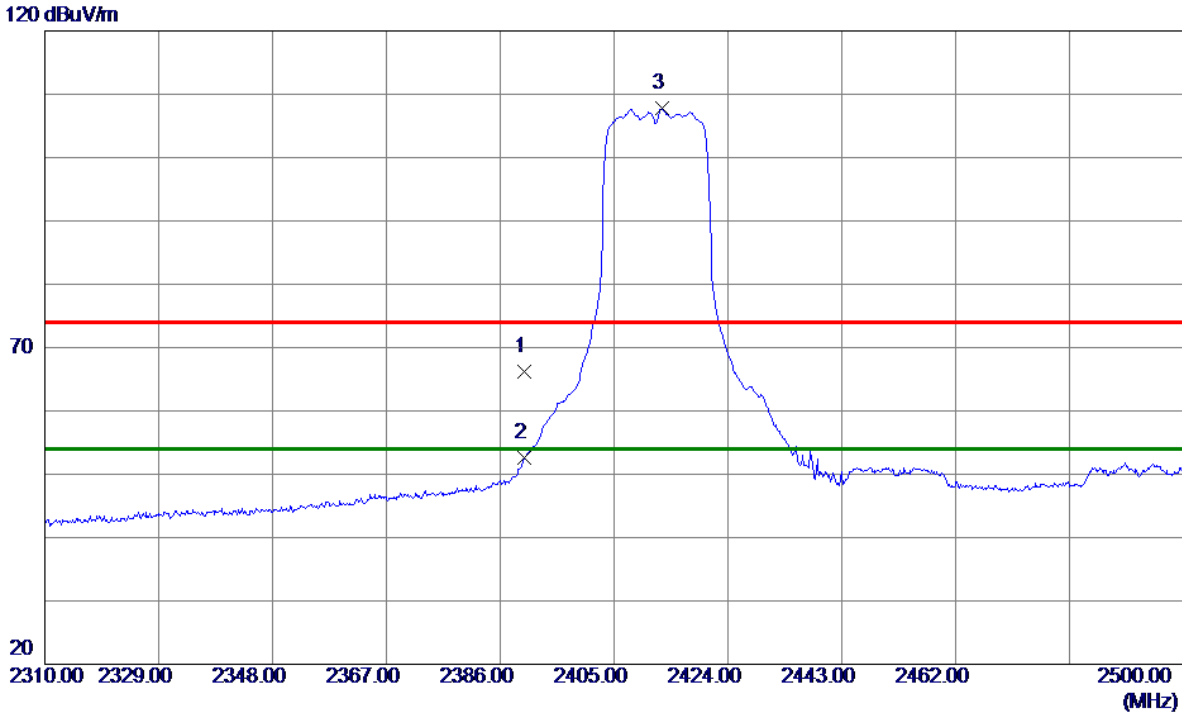

No.	Freq. MHz	Reading Level dBuV/m	Correct Factor dB	Measure ment dBuV/m	Limit dBuV/m	Margin dB	Detector	Comment
1	2390.0000	32.91	33.36	66.27	74.00	-7.73	Peak	
2	2390.0000	19.29	33.36	52.65	54.00	-1.35	AVG	
3 *	2412.9800	74.34	33.46	107.80	54.00	53.80	AVG	No limit

REMARKS:

- (1) Measurement Value = Reading Level + Correct Factor.
- (2) Margin Level = Measurement Value - Limit Value.

Test Mode: TX G Mode 2412 MHz

Vertical

80 dBuV/m

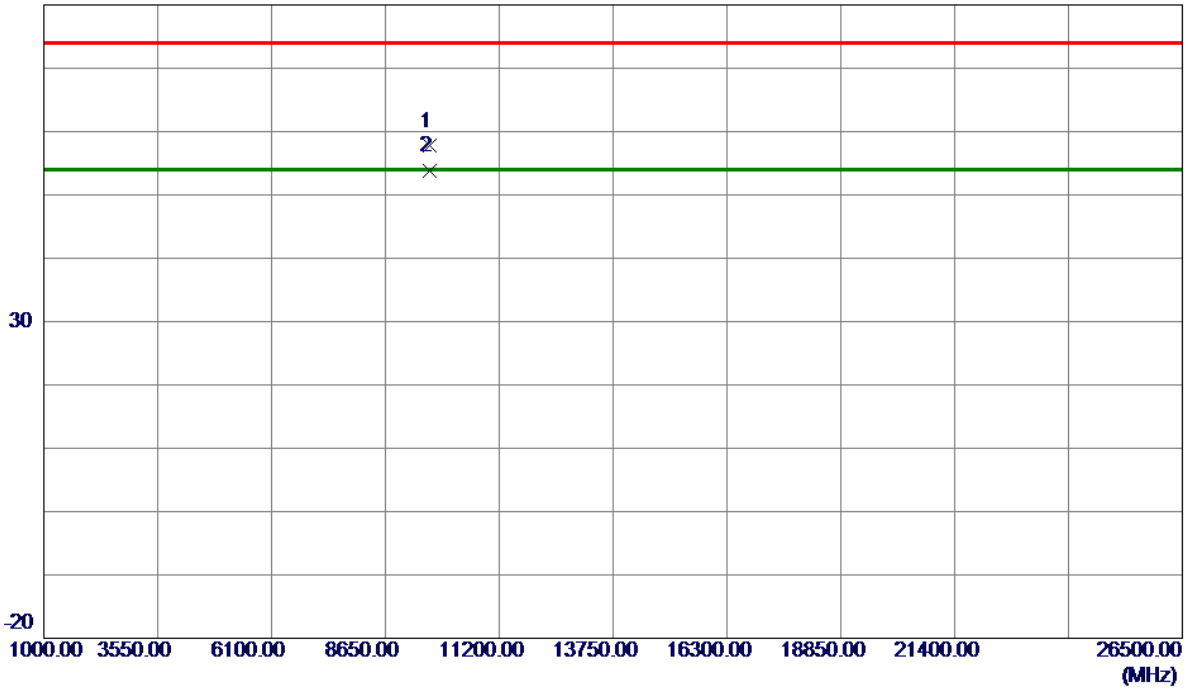

No.	Freq. MHz	Reading Level dBuV/m	Correct Factor dB	Measure ment dBuV/m	Limit dBuV/m	Margin dB	Detector	Comment
1	9644.5000	58.13	-0.43	57.70	74.00	-16.30	Peak	
2 *	9644.5000	54.28	-0.43	53.85	54.00	-0.15	AVG	

REMARKS:

- (1) Measurement Value = Reading Level + Correct Factor.
- (2) Margin Level = Measurement Value - Limit Value.
- (3) "*" is not in restricted band, its limit is 30dBc of the fundamental emission level(111.3dBuV/m) or 15.209 Which is higher.

Test Mode: TX G Mode 2412 MHz

Horizontal

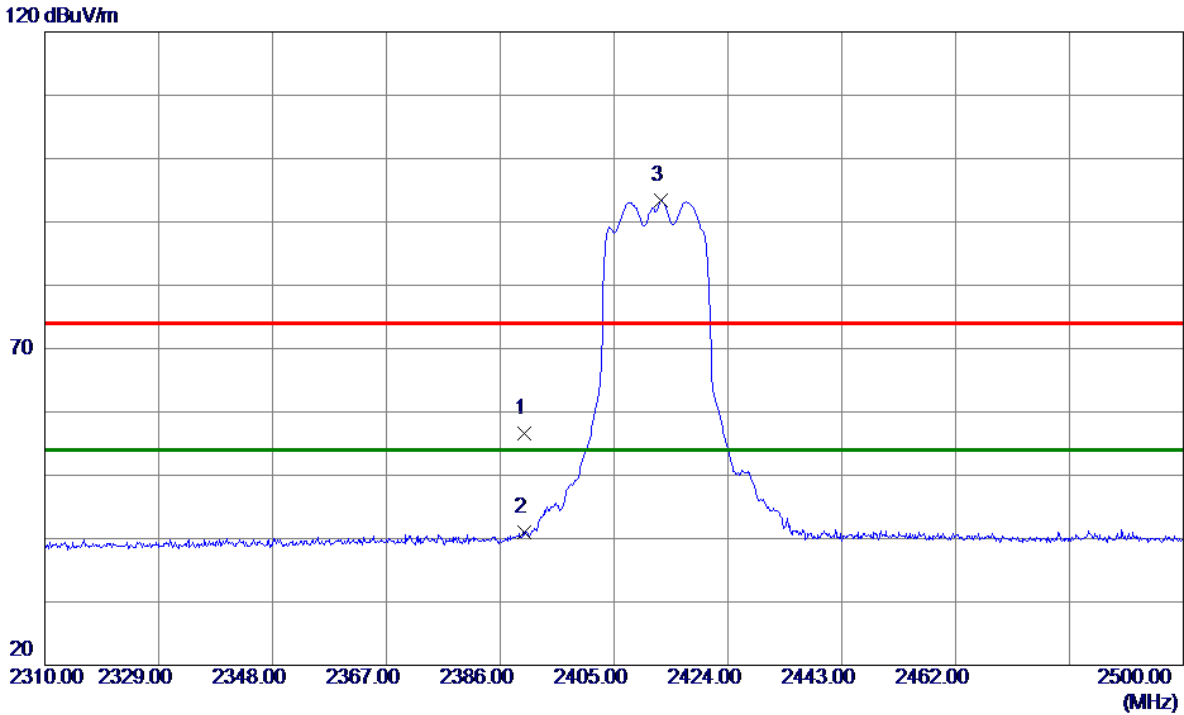

No.	Freq. MHz	Reading Level dBuV/m	Correct Factor dB	Measure ment dBuV/m	Limit dBuV/m	Margin dB	Detector	Comment
1	2390.0000	23.24	33.36	56.60	74.00	-17.40	Peak	
2	2390.0000	7.64	33.36	41.00	54.00	-13.00	AVG	
3 *	2412.8850	59.90	33.46	93.36	54.00	39.36	AVG	No limit

REMARKS:

- (1) Measurement Value = Reading Level + Correct Factor.
- (2) Margin Level = Measurement Value - Limit Value.

Test Mode: TX G Mode 2412 MHz

Horizontal

80 dBuV/m

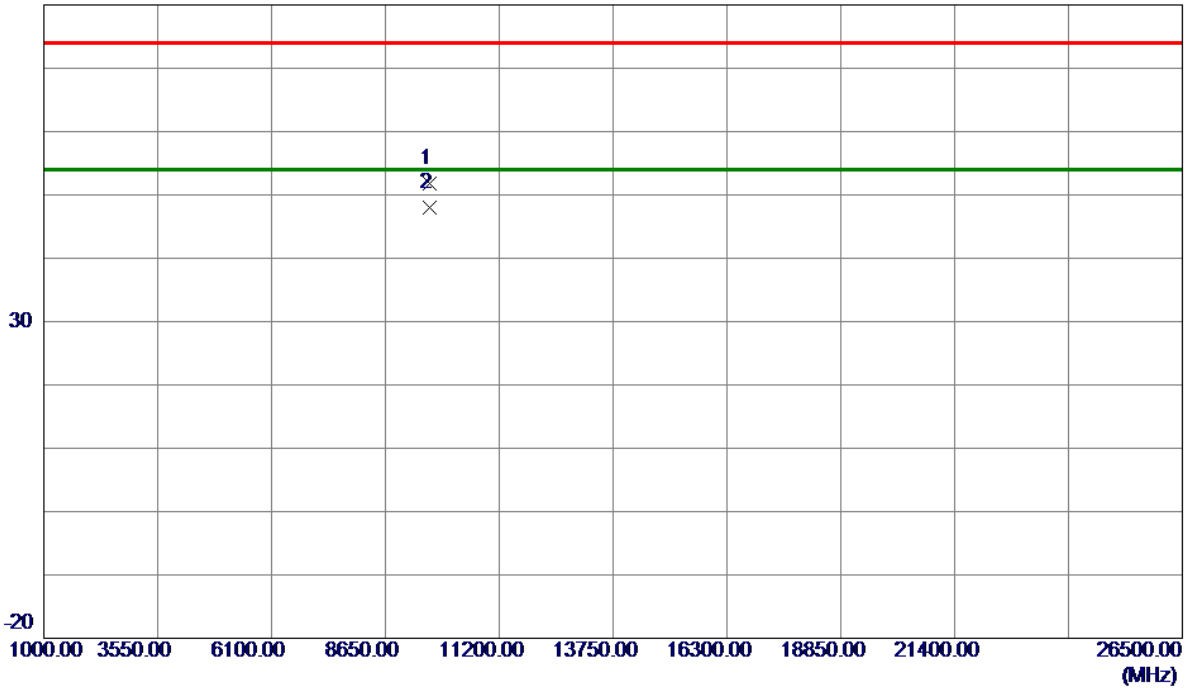

No.	Freq. MHz	Reading Level dBuV/m	Correct Factor dB	Measure ment dBuV/m	Limit dBuV/m	Margin dB	Detector	Comment
1	9644.5000	52.16	-0.43	51.73	74.00	-22.27	Peak	
2 *	9644.5000	48.35	-0.43	47.92	54.00	-6.08	AVG	

REMARKS:

(1) Measurement Value = Reading Level + Correct Factor.

(2) Margin Level = Measurement Value - Limit Value.

(3) "*" is not in restricted band, its limit is 30dBc of the fundamental emission level(111.3dBuV/m) or 15.209 Which is higher.

Test Mode: TX G Mode 2437 MHz

Vertical

120 dBuV/m

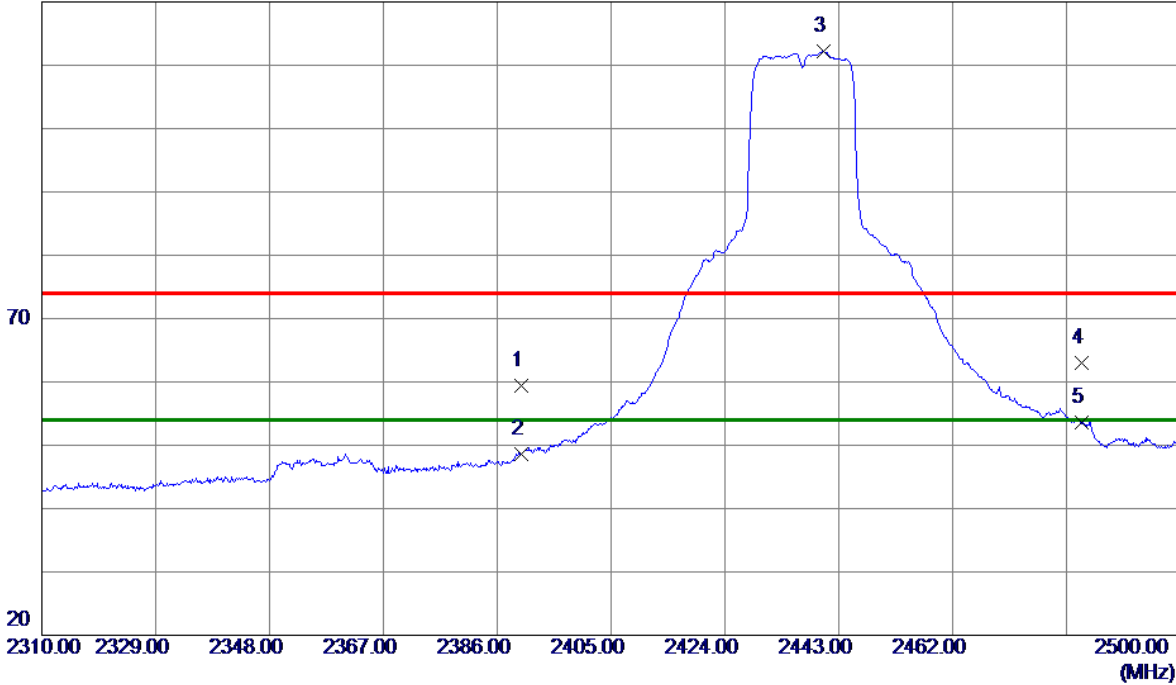

No.	Freq. MHz	Reading Level dBuV/m	Correct Factor dB	Measure ment dBuV/m	Limit dBuV/m	Margin dB	Detector	Comment
1	2390.0000	26.06	33.36	59.42	74.00	-14.58	Peak	
2	2390.0000	15.30	33.36	48.66	54.00	-5.34	AVG	
3 *	2440.5300	78.60	33.58	112.18	54.00	58.18	AVG	No limit
4	2483.5000	29.15	33.76	62.91	74.00	-11.09	Peak	
5	2483.5000	19.80	33.76	53.56	54.00	-0.44	AVG	

REMARKS:

- (1) Measurement Value = Reading Level + Correct Factor.
- (2) Margin Level = Measurement Value - Limit Value.

Test Mode: TX G Mode 2437 MHz

Vertical

80 dBuV/m

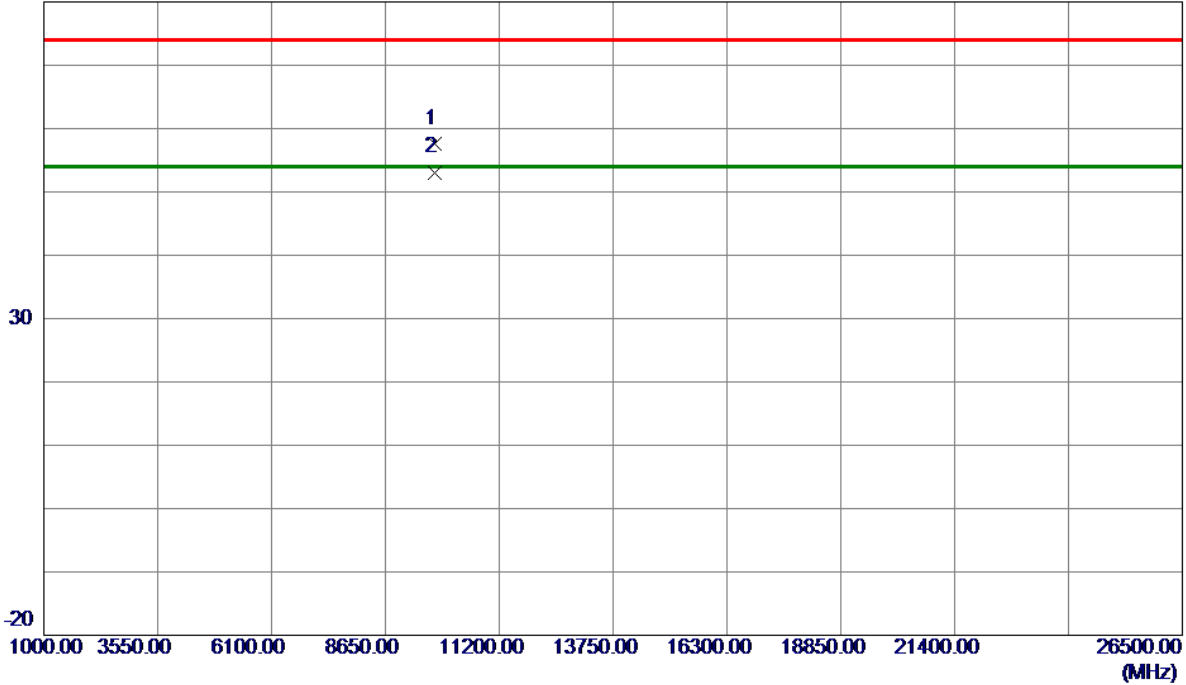

No.	Freq. MHz	Reading Level dBuV/m	Correct Factor dB	Measure ment dBuV/m	Limit dBuV/m	Margin dB	Detector	Comment
1	9746.5000	58.03	-0.44	57.59	74.00	-16.41	Peak	
2 *	9746.5000	53.54	-0.44	53.10	54.00	-0.90	AVG	

REMARKS:

- (1) Measurement Value = Reading Level + Correct Factor.
- (2) Margin Level = Measurement Value - Limit Value.
- (3) "*" is not in restricted band, its limit is 30dBc of the fundamental emission level(111.3dBuV/m) or 15.209 Which is higher.

Test Mode: TX G Mode 2437 MHz

Horizontal

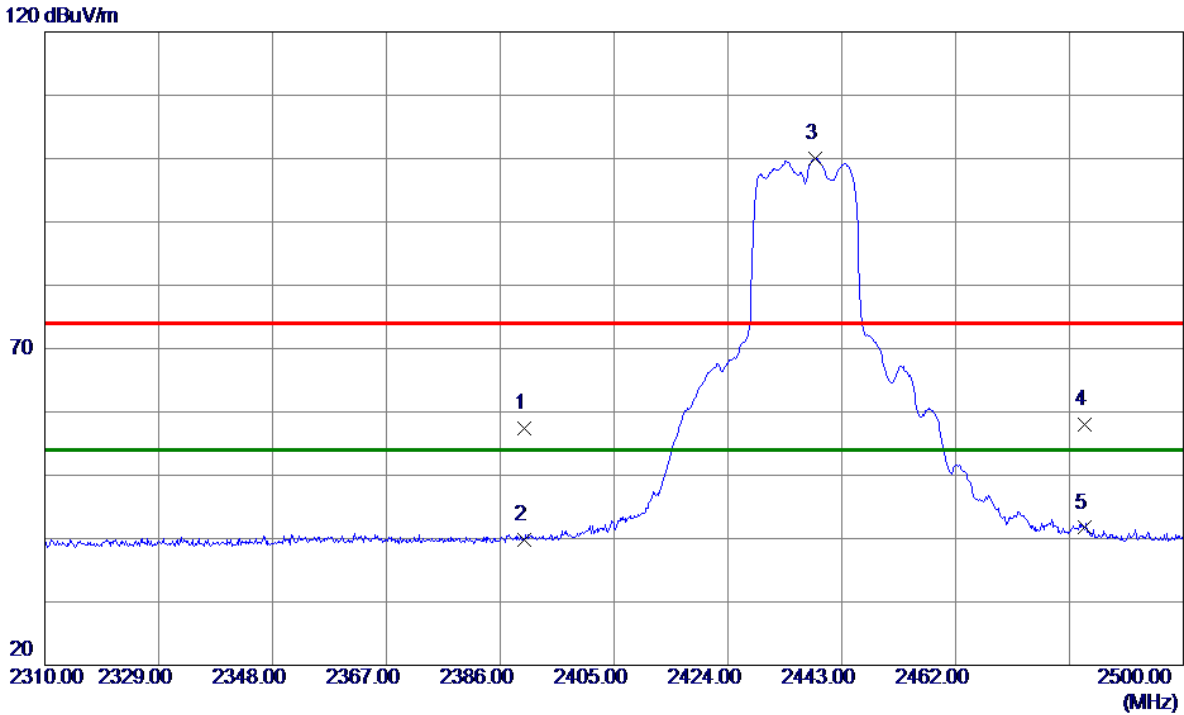

No.	Freq. MHz	Reading Level dBuV/m	Correct Factor dB	Measure ment dBuV/m	Limit dBuV/m	Margin dB	Detector	Comment
1	2390.0000	23.97	33.36	57.33	74.00	-16.67	Peak	
2	2390.0000	6.51	33.36	39.87	54.00	-14.13	AVG	
3 *	2438.5350	66.51	33.57	100.08	54.00	46.08	AVG	No limit
4	2483.5000	24.33	33.76	58.09	74.00	-15.91	Peak	
5	2483.5000	7.94	33.76	41.70	54.00	-12.30	AVG	

REMARKS:

- (1) Measurement Value = Reading Level + Correct Factor.
- (2) Margin Level = Measurement Value - Limit Value.

Test Mode: TX G Mode 2437 MHz

Horizontal

80 dBuV/m

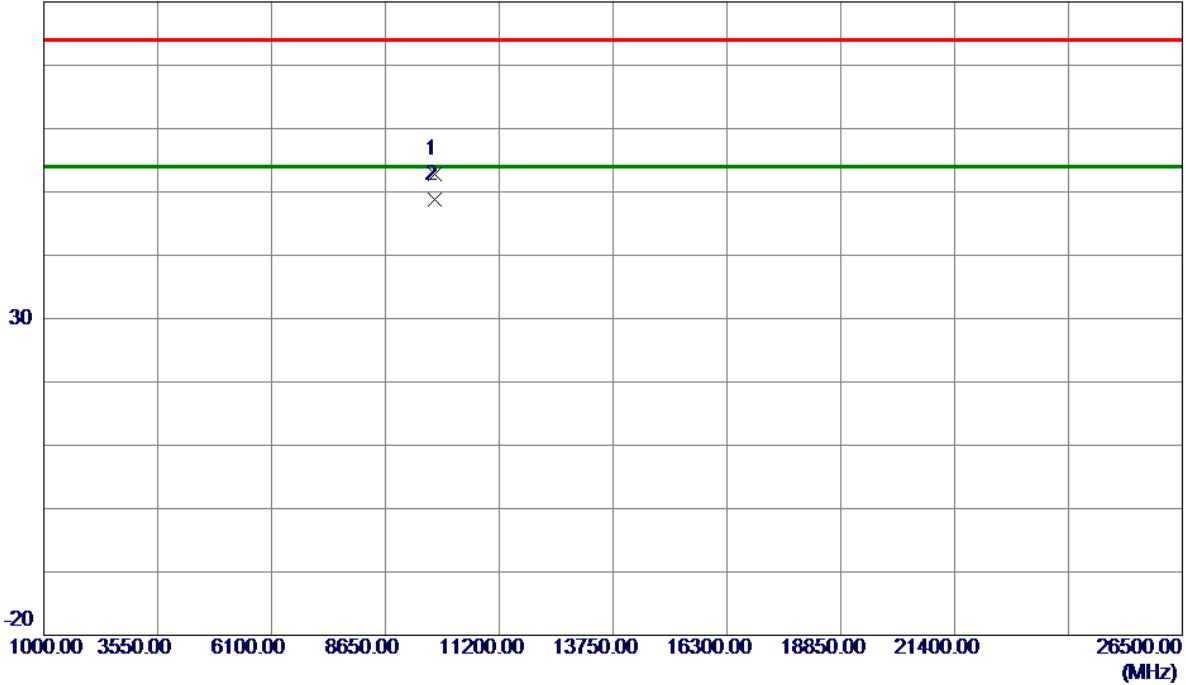

No.	Freq. MHz	Reading Level dBuV/m	Correct Factor dB	Measure ment dBuV/m	Limit dBuV/m	Margin dB	Detector	Comment
1	9759.2500	53.16	-0.44	52.72	74.00	-21.28	Peak	
2 *	9759.2500	49.32	-0.44	48.88	54.00	-5.12	AVG	

REMARKS:

- (1) Measurement Value = Reading Level + Correct Factor.
- (2) Margin Level = Measurement Value - Limit Value.
- (3) "*" is not in restricted band, its limit is 30dBc of the fundamental emission level(111.3dBuV/m) or 15.209 Which is higher.

Test Mode: TX G Mode 2462 MHz

Vertical

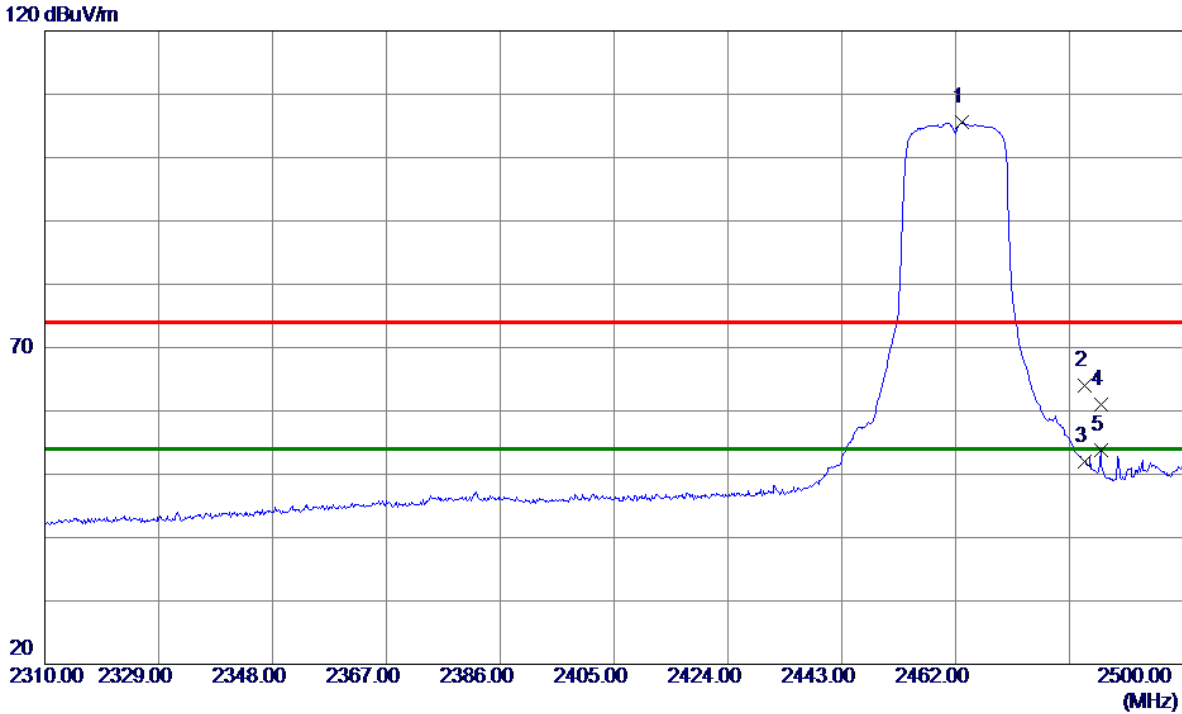

No.	Freq. MHz	Reading Level dBuV/m	Correct Factor dB	Measure ment dBuV/m	Limit dBuV/m	Margin dB	Detector	Comment
1 *	2463.1399	71.84	33.67	105.51	54.00	51.51	AVG	No limit
2	2483.5000	30.18	33.76	63.94	74.00	-10.06	Peak	
3	2483.5000	18.29	33.76	52.05	54.00	-1.95	AVG	
4	2486.2250	27.30	33.77	61.07	74.00	-12.93	Peak	
5	2486.2250	19.96	33.77	53.73	54.00	-0.27	AVG	

REMARKS:

- (1) Measurement Value = Reading Level + Correct Factor.
- (2) Margin Level = Measurement Value - Limit Value.

Test Mode: TX G Mode 2462 MHz

Vertical

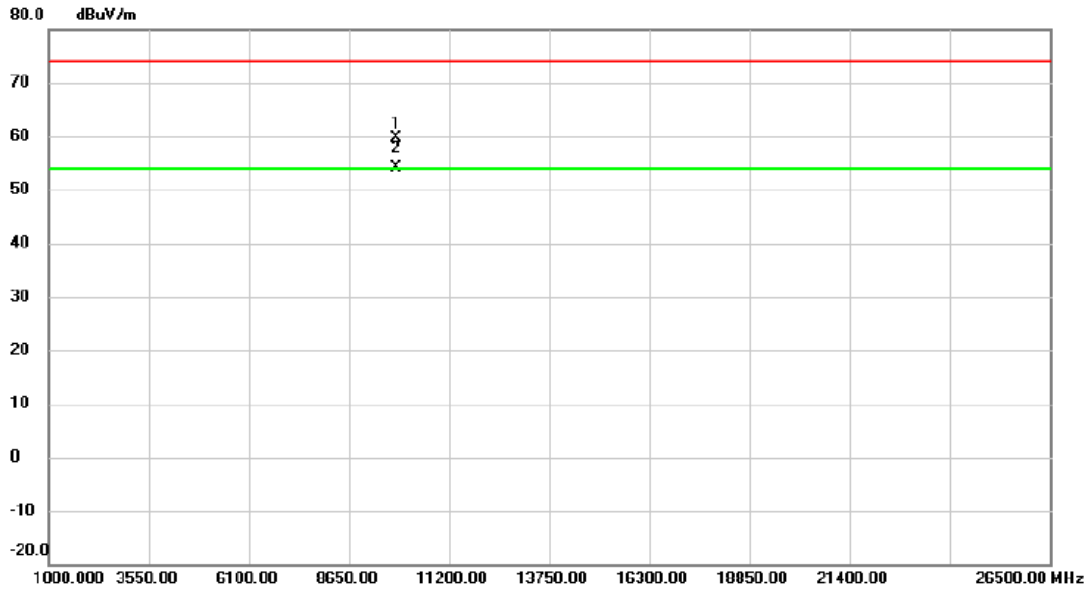

No.	Mk.	Freq. MHz	Reading Level dBuV	Correct Factor dB	Measure- ment dBuV/m	Limit dBuV/m	Margin dB	Detector	Comment
1		9848.500	59.99	-0.45	59.54	74.00	-14.46	peak	
2	*	9848.500	54.68	-0.45	54.23	55.51	-1.28	AVG	

REMARKS:

- (1) Measurement Value = Reading Level + Correct Factor.
- (2) Margin Level = Measurement Value - Limit Value.
- (3) "*" is not in restricted band, its limit is 30dBc of the fundamental emission level(111.3dBuV/m) or 15.209 Which is higher.

Test Mode: TX G Mode 2462 MHz

Horizontal

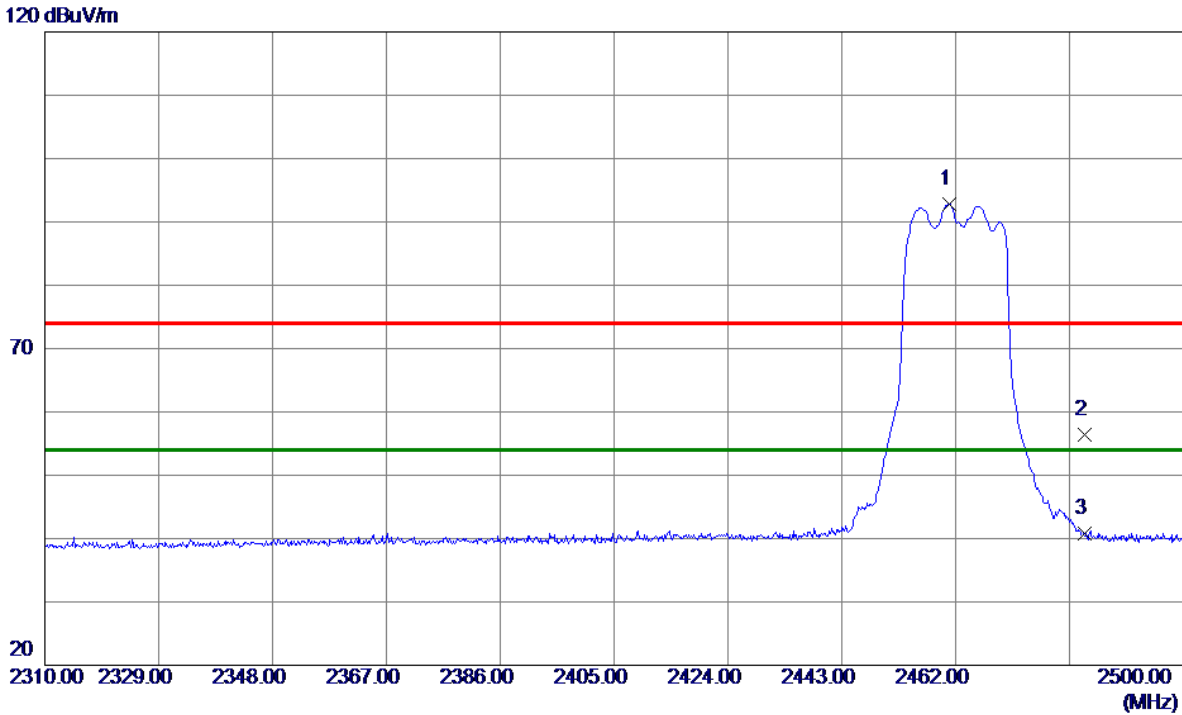

No.	Freq. MHz	Reading Level dBuV/m	Correct Factor dB	Measure ment dBuV/m	Limit dBuV/m	Margin dB	Detector	Comment
1 *	2460.9550	59.22	33.66	92.88	54.00	38.88	AVG	No limit
2	2483.5000	22.68	33.76	56.44	74.00	-17.56	Peak	
3	2483.5000	6.96	33.76	40.72	54.00	-13.28	AVG	

REMARKS:

- (1) Measurement Value = Reading Level + Correct Factor.
- (2) Margin Level = Measurement Value - Limit Value.

Test Mode: TX G Mode 2462 MHz

Horizontal

80 dBuV/m

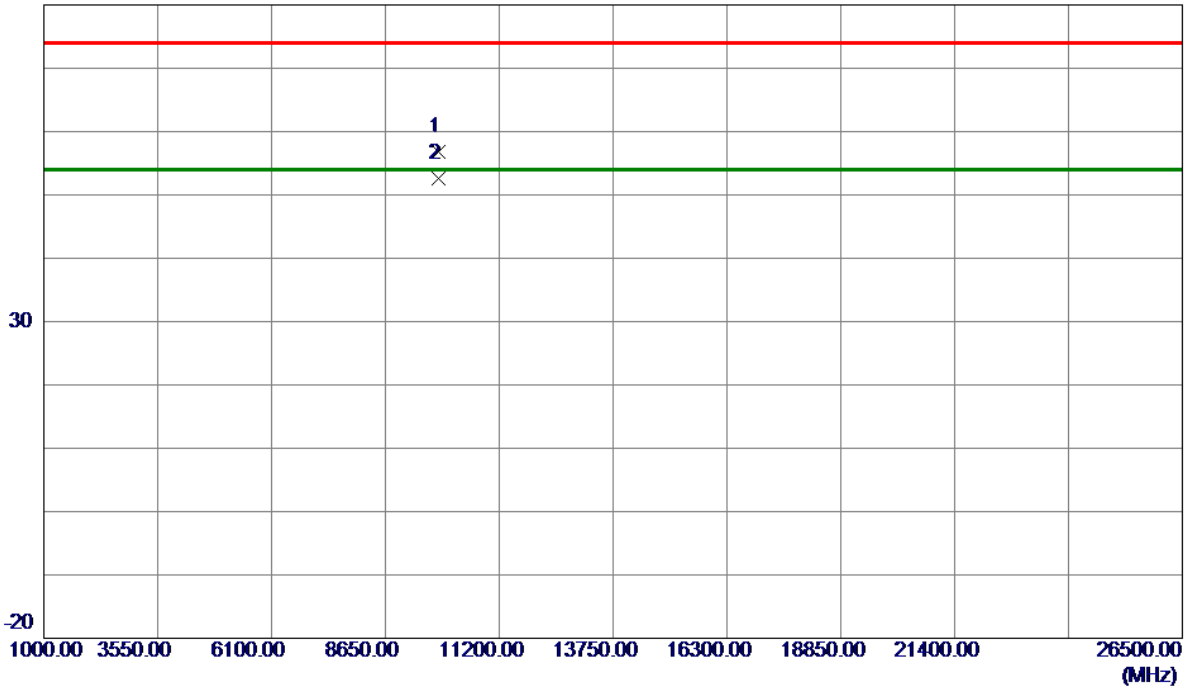

No.	Freq. MHz	Reading Level dBuV/m	Correct Factor dB	Measure ment dBuV/m	Limit dBuV/m	Margin dB	Detector	Comment
1	9848.5000	57.29	-0.45	56.84	74.00	-17.16	Peak	
2 *	9848.5000	53.11	-0.45	52.66	54.00	-1.34	AVG	

REMARKS:

- (1) Measurement Value = Reading Level + Correct Factor.
- (2) Margin Level = Measurement Value - Limit Value.
- (3) "*" is not in restricted band, its limit is 30dBc of the fundamental emission level(111.3dBuV/m) or 15.209 Which is higher.

Test Mode: TX N-20M Mode 2412 MHz

Vertical

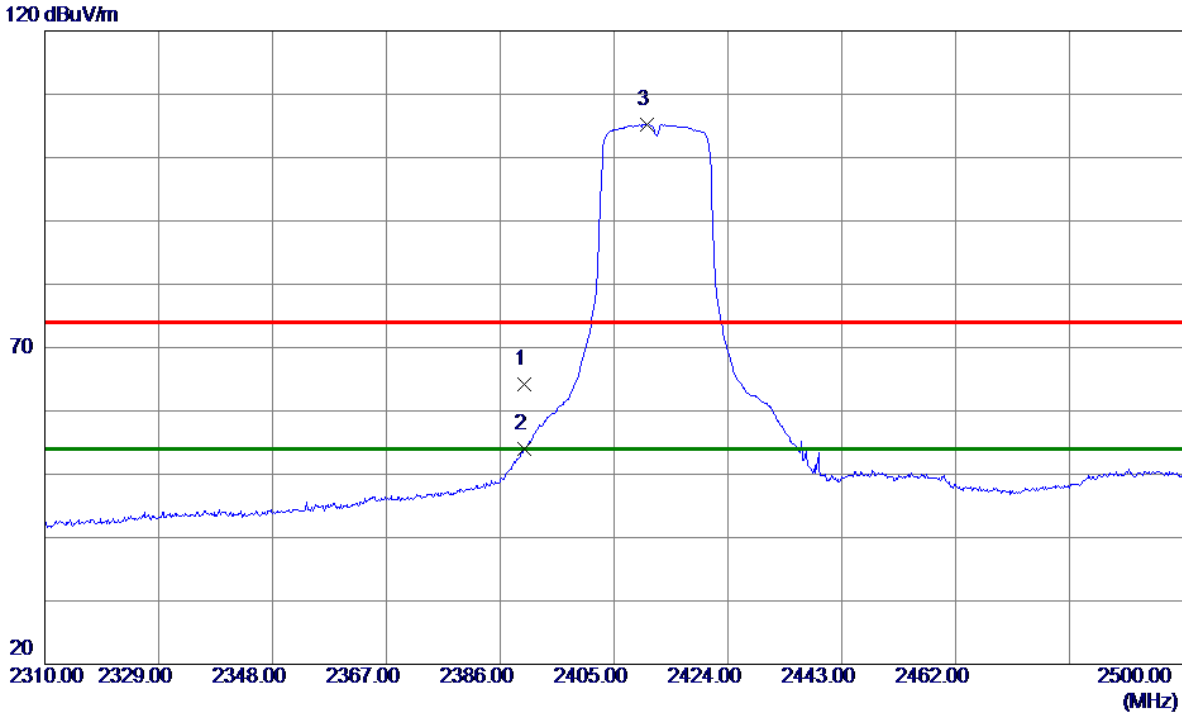

No.	Freq. MHz	Reading Level dBuV/m	Correct Factor dB	Measure ment dBuV/m	Limit dBuV/m	Margin dB	Detector	Comment
1	2390.0000	30.87	33.36	64.23	74.00	-9.77	Peak	
2	2390.0000	20.59	33.36	53.95	54.00	-0.05	AVG	
3 *	2410.4150	71.84	33.45	105.29	54.00	51.29	AVG	No limit

REMARKS:

- (1) Measurement Value = Reading Level + Correct Factor.
- (2) Margin Level = Measurement Value - Limit Value.

Test Mode: TX N-20M Mode 2412 MHz

Vertical

80 dBuV/m

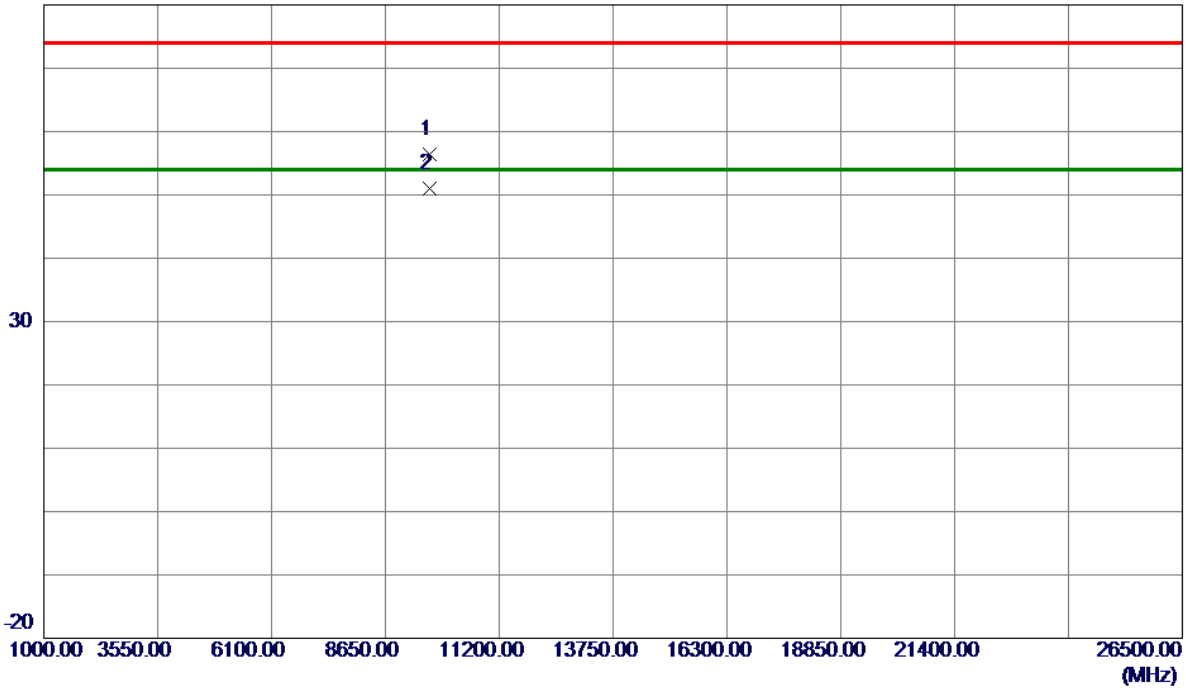

No.	Freq. MHz	Reading Level dBuV/m	Correct Factor dB	Measure ment dBuV/m	Limit dBuV/m	Margin dB	Detector	Comment
1	9644.5000	56.82	-0.43	56.39	74.00	-17.61	Peak	
2 *	9644.5000	51.47	-0.43	51.04	54.00	-2.96	AVG	

REMARKS:

- (1) Measurement Value = Reading Level + Correct Factor.
- (2) Margin Level = Measurement Value - Limit Value.
- (3) "*" is not in restricted band, its limit is 30dBc of the fundamental emission level(111.3dBuV/m) or 15.209 Which is higher.

Test Mode: TX N-20M Mode 2412 MHz

Horizontal

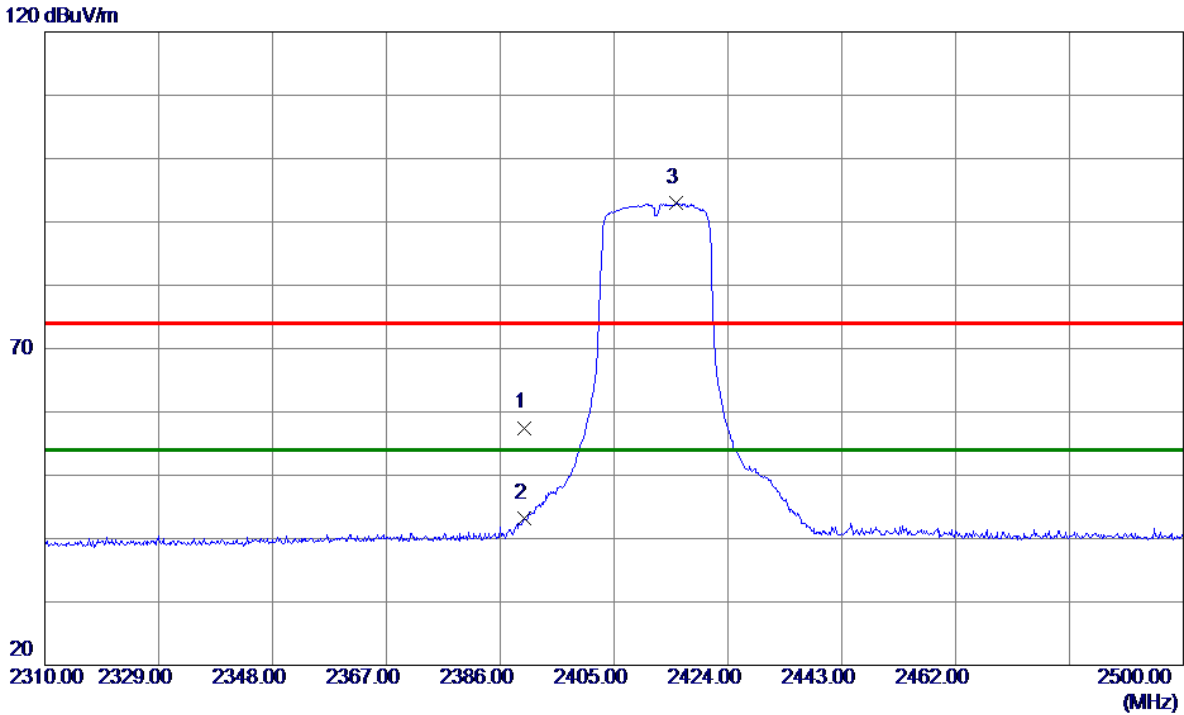

No.	Freq. MHz	Reading Level dBuV/m	Correct Factor dB	Measure ment dBuV/m	Limit dBuV/m	Margin dB	Detector	Comment
1	2390.0000	24.14	33.36	57.50	74.00	-16.50	Peak	
2	2390.0000	9.79	33.36	43.15	54.00	-10.85	AVG	
3 *	2415.3550	59.60	33.47	93.07	54.00	39.07	AVG	No limit

REMARKS:

- (1) Measurement Value = Reading Level + Correct Factor.
- (2) Margin Level = Measurement Value - Limit Value.

Test Mode: TX N-20M Mode 2412 MHz

Horizontal

80 dBuV/m

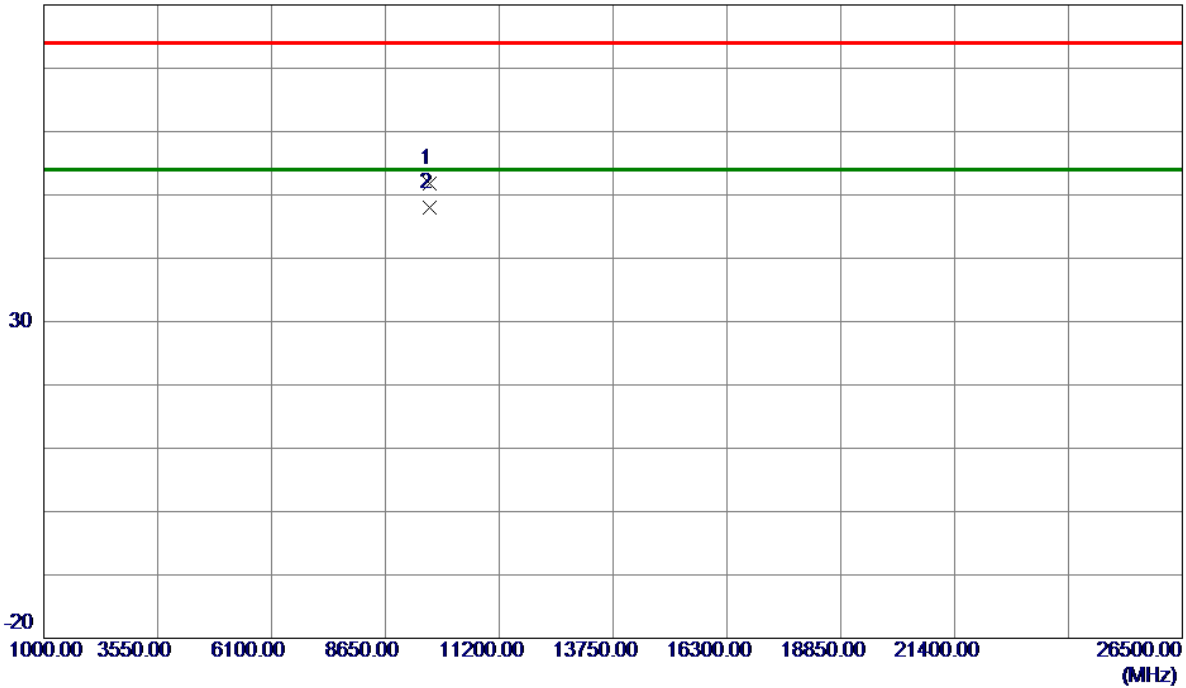

No.	Freq. MHz	Reading Level dBuV/m	Correct Factor dB	Measure ment dBuV/m	Limit dBuV/m	Margin dB	Detector	Comment
1 *	9644.5000	52.26	-0.43	51.83	74.00	-22.17	Peak	
2	9644.5000	48.35	-0.43	47.92	74.00	-26.08	Peak	

REMARKS:

- (1) Measurement Value = Reading Level + Correct Factor.
- (2) Margin Level = Measurement Value - Limit Value.
- (3) "*" is not in restricted band, its limit is 30dBc of the fundamental emission level(111.3dBuV/m) or 15.209 Which is higher.

Test Mode: TX N-20M Mode 2437 MHz

Vertical

120 dBuV/m

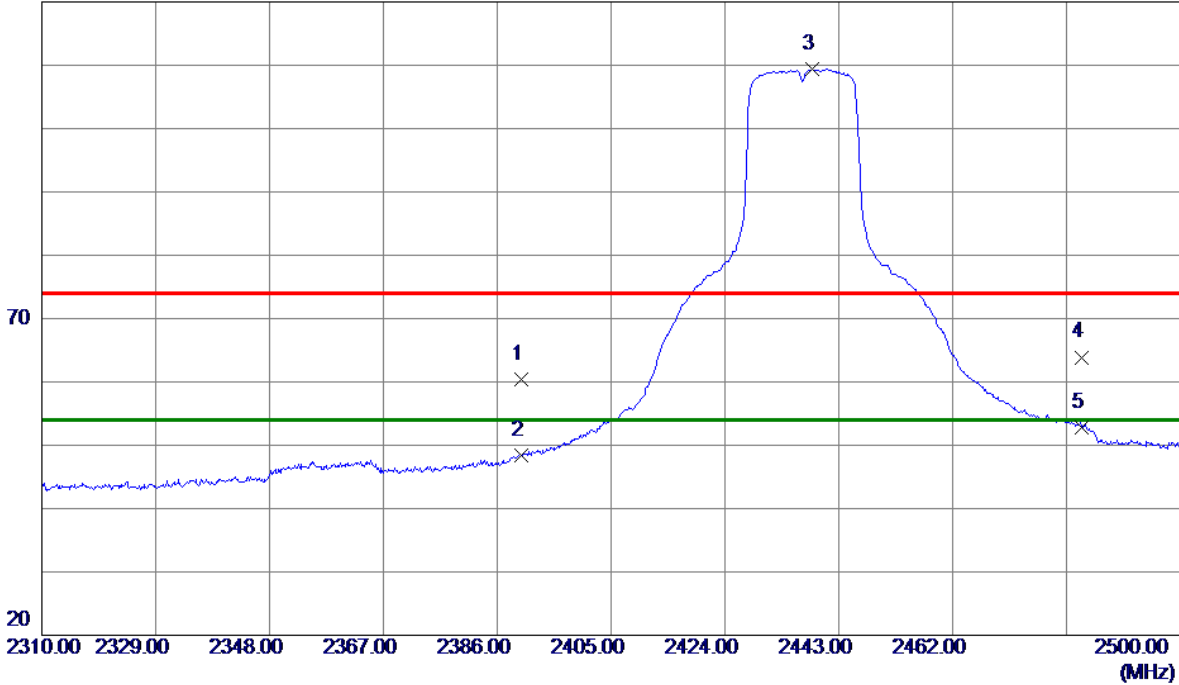

No.	Freq. MHz	Reading Level dBuV/m	Correct Factor dB	Measure ment dBuV/m	Limit dBuV/m	Margin dB	Detector	Comment
1	2390.0000	27.03	33.36	60.39	74.00	-13.61	Peak	
2	2390.0000	15.01	33.36	48.37	54.00	-5.63	AVG	
3 *	2438.6299	75.81	33.57	109.38	54.00	55.38	AVG	No limit
4	2483.5000	30.14	33.76	63.90	74.00	-10.10	Peak	
5	2483.5000	18.98	33.76	52.74	54.00	-1.26	AVG	

REMARKS:

- (1) Measurement Value = Reading Level + Correct Factor.
- (2) Margin Level = Measurement Value - Limit Value.

Test Mode: TX N-20M Mode 2437 MHz

Vertical

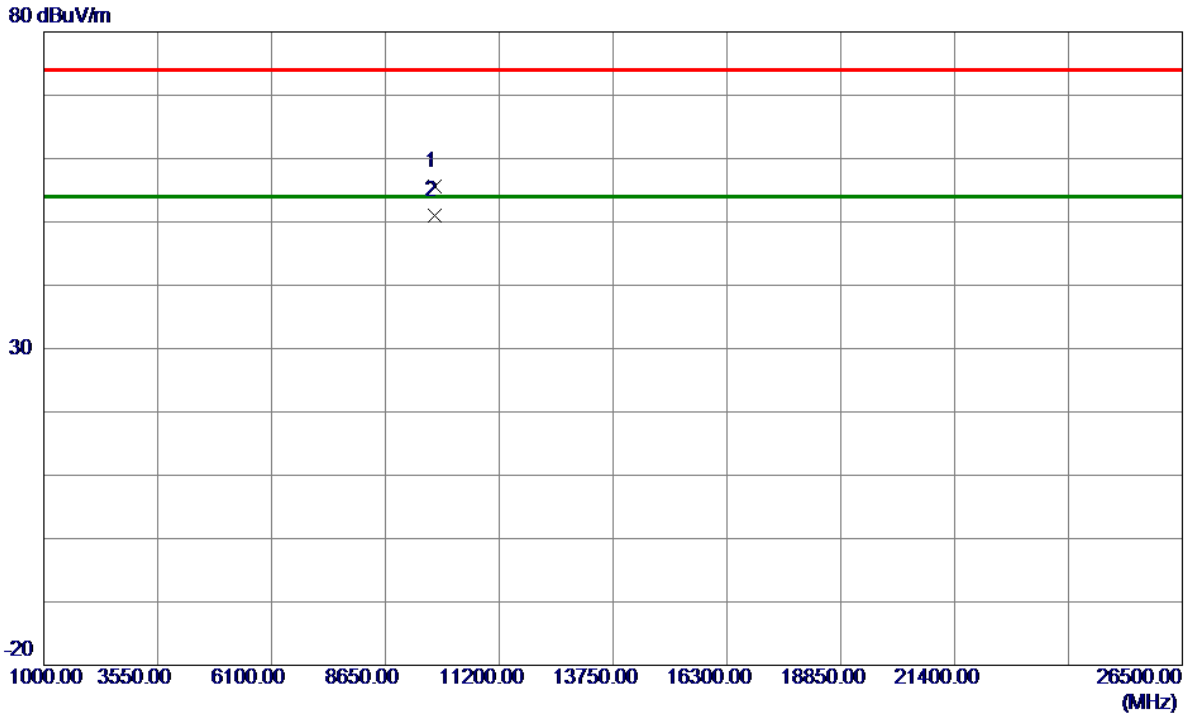

No.	Freq. MHz	Reading Level dBuV/m	Correct Factor dB	Measure ment dBuV/m	Limit dBuV/m	Margin dB	Detector	Comment
1	9746.5000	56.07	-0.44	55.63	74.00	-18.37	Peak	
2 *	9746.5000	51.45	-0.44	51.01	54.00	-2.99	AVG	

REMARKS:

- (1) Measurement Value = Reading Level + Correct Factor.
- (2) Margin Level = Measurement Value - Limit Value.
- (3) "*" is not in restricted band, its limit is 30dBc of the fundamental emission level(111.3dBuV/m) or 15.209 Which is higher.

Test Mode: TX N-20M Mode 2437 MHz

Horizontal

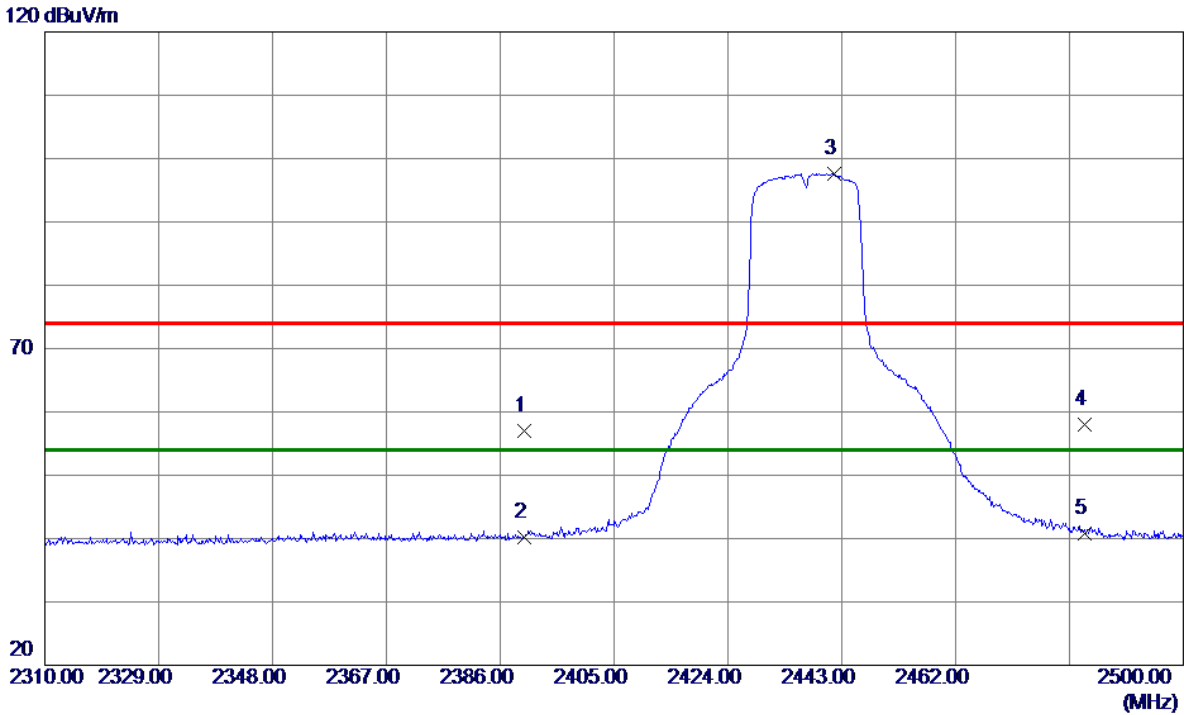

No.	Freq. MHz	Reading Level dBuV/m	Correct Factor dB	Measurement dBuV/m	Limit dBuV/m	Margin dB	Detector	Comment
1	2390.0000	23.55	33.36	56.91	74.00	-17.09	Peak	
2	2390.0000	6.91	33.36	40.27	54.00	-13.73	AVG	
3 *	2441.7649	64.06	33.58	97.64	54.00	43.64	AVG	No limit
4	2483.5000	24.27	33.76	58.03	74.00	-15.97	Peak	
5	2483.5000	7.06	33.76	40.82	54.00	-13.18	AVG	

REMARKS:

- (1) Measurement Value = Reading Level + Correct Factor.
- (2) Margin Level = Measurement Value - Limit Value.

Test Mode: TX N-20M Mode 2437 MHz

Horizontal

80 dBuV/m

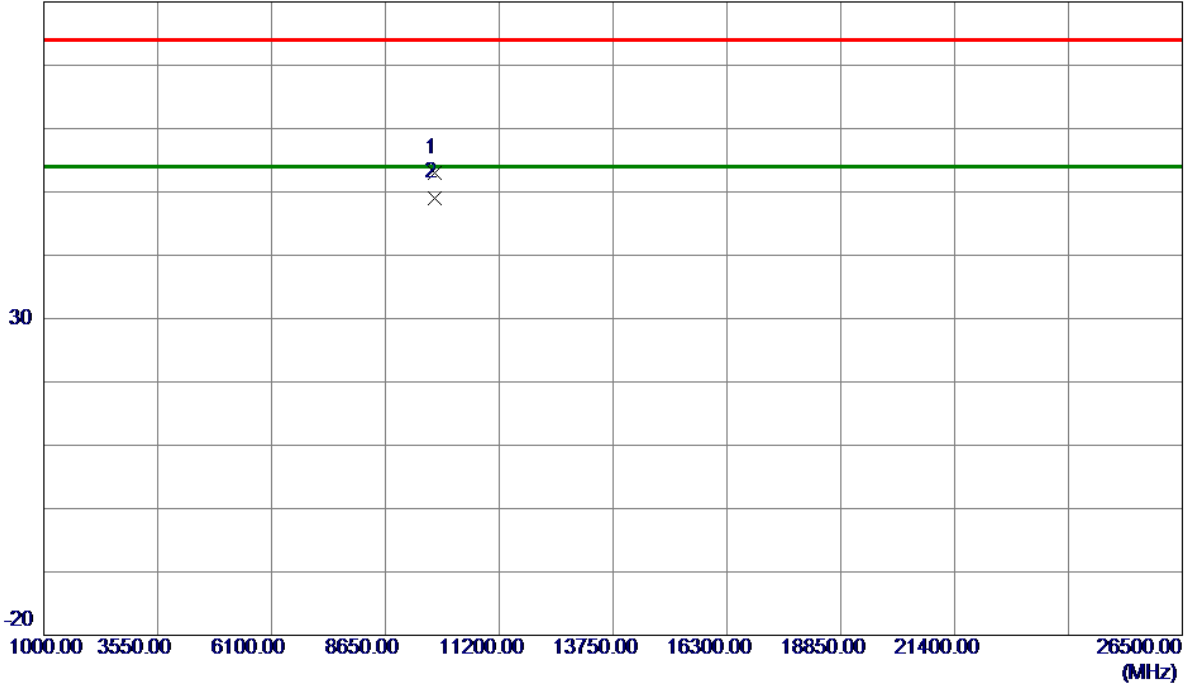

No.	Freq. MHz	Reading Level dBuV/m	Correct Factor dB	Measure ment dBuV/m	Limit dBuV/m	Margin dB	Detector	Comment
1	9746.5000	53.41	-0.44	52.97	74.00	-21.03	Peak	
2 *	9746.5000	49.54	-0.44	49.10	54.00	-4.90	AVG	

REMARKS:

- (1) Measurement Value = Reading Level + Correct Factor.
- (2) Margin Level = Measurement Value - Limit Value.
- (3) "*" is not in restricted band, its limit is 30dBc of the fundamental emission level(111.3dBuV/m) or 15.209 Which is higher.

Test Mode: TX N-20M Mode 2462 MHz

Vertical

120 dBuV/m

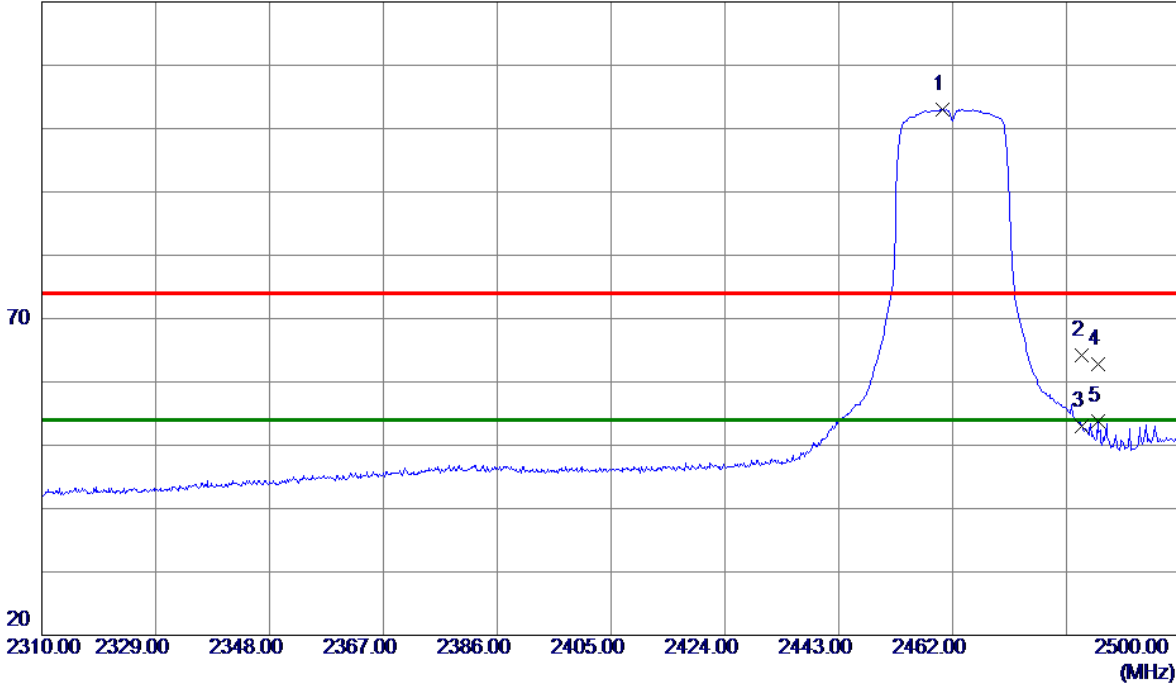

No.	Freq. MHz	Reading Level dBuV/m	Correct Factor dB	Measure ment dBuV/m	Limit dBuV/m	Margin dB	Detector	Comment
1 *	2460.2900	69.34	33.66	103.00	54.00	49.00	AVG	No limit
2	2483.5000	30.35	33.76	64.11	74.00	-9.89	Peak	
3	2483.5000	19.21	33.76	52.97	54.00	-1.03	AVG	
4	2486.2250	29.01	33.77	62.78	74.00	-11.22	Peak	
5	2486.2250	19.98	33.77	53.75	54.00	-0.25	AVG	

REMARKS:

- (1) Measurement Value = Reading Level + Correct Factor.
- (2) Margin Level = Measurement Value - Limit Value.

Test Mode: TX N-20M Mode 2462 MHz

Vertical

80 dBuV/m

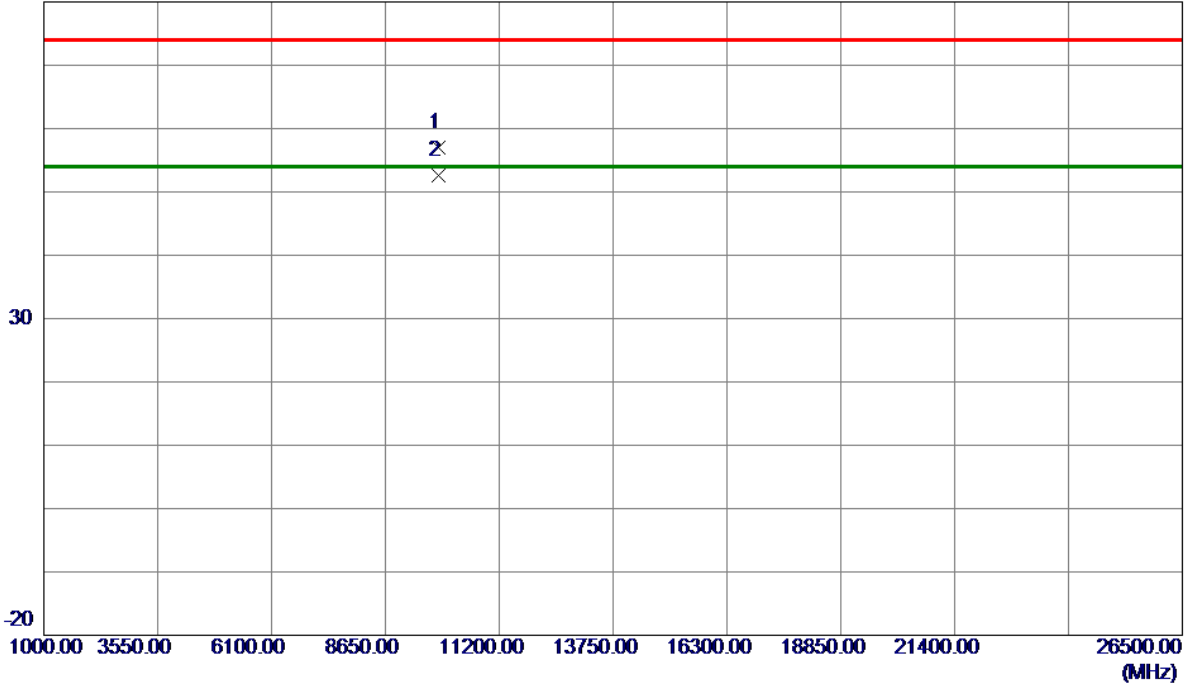

No.	Freq. MHz	Reading Level dBuV/m	Correct Factor dB	Measure ment dBuV/m	Limit dBuV/m	Margin dB	Detector	Comment
1	9848.5000	57.47	-0.45	57.02	74.00	-16.98	Peak	
2 *	9848.5000	53.14	-0.45	52.69	54.00	-1.31	AVG	

REMARKS:

- (1) Measurement Value = Reading Level + Correct Factor.
- (2) Margin Level = Measurement Value - Limit Value.
- (3) "*" is not in restricted band, its limit is 30dBc of the fundamental emission level(111.3dBuV/m) or 15.209 Which is higher.

Test Mode: TX N-20M Mode 2462 MHz

Horizontal

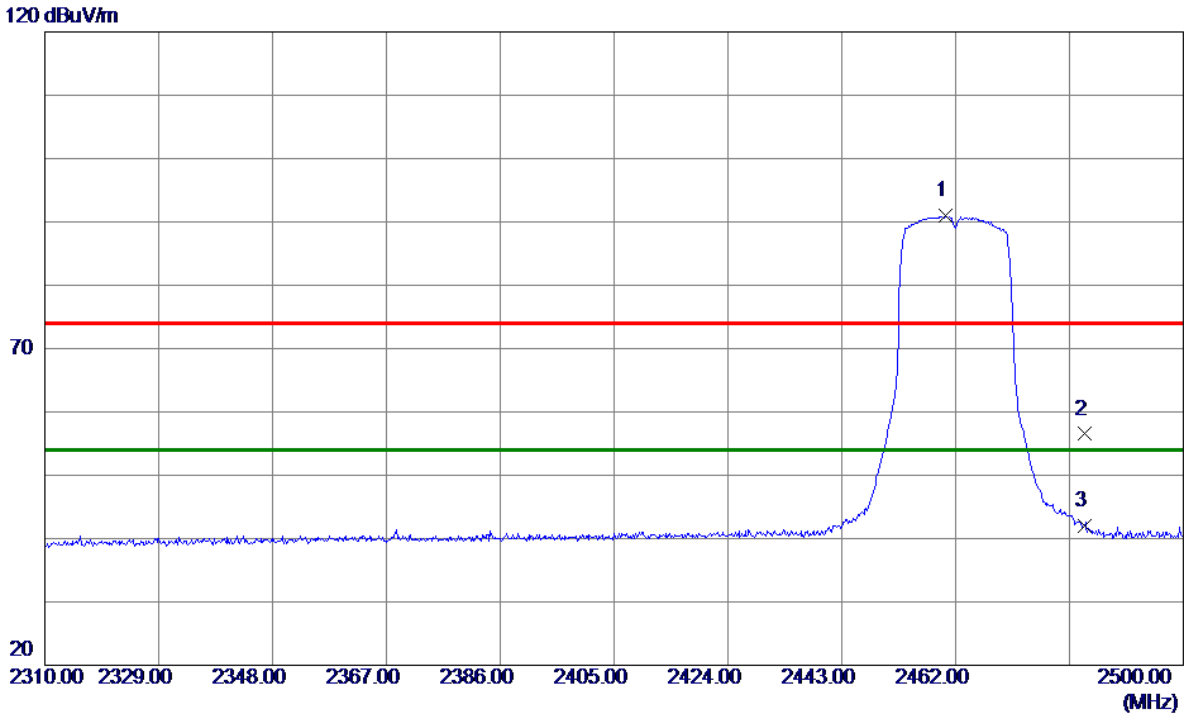

No.	Freq. MHz	Reading Level dBuV/m	Correct Factor dB	Measure ment dBuV/m	Limit dBuV/m	Margin dB	Detector	Comment
1 *	2460.2900	57.25	33.66	90.91	54.00	36.91	AVG	No limit
2	2483.5000	22.74	33.76	56.50	74.00	-17.50	Peak	
3	2483.5000	8.21	33.76	41.97	54.00	-12.03	AVG	

REMARKS:

- (1) Measurement Value = Reading Level + Correct Factor.
- (2) Margin Level = Measurement Value - Limit Value.

Test Mode: TX N-20M Mode 2462 MHz

Horizontal

80 dBuV/m

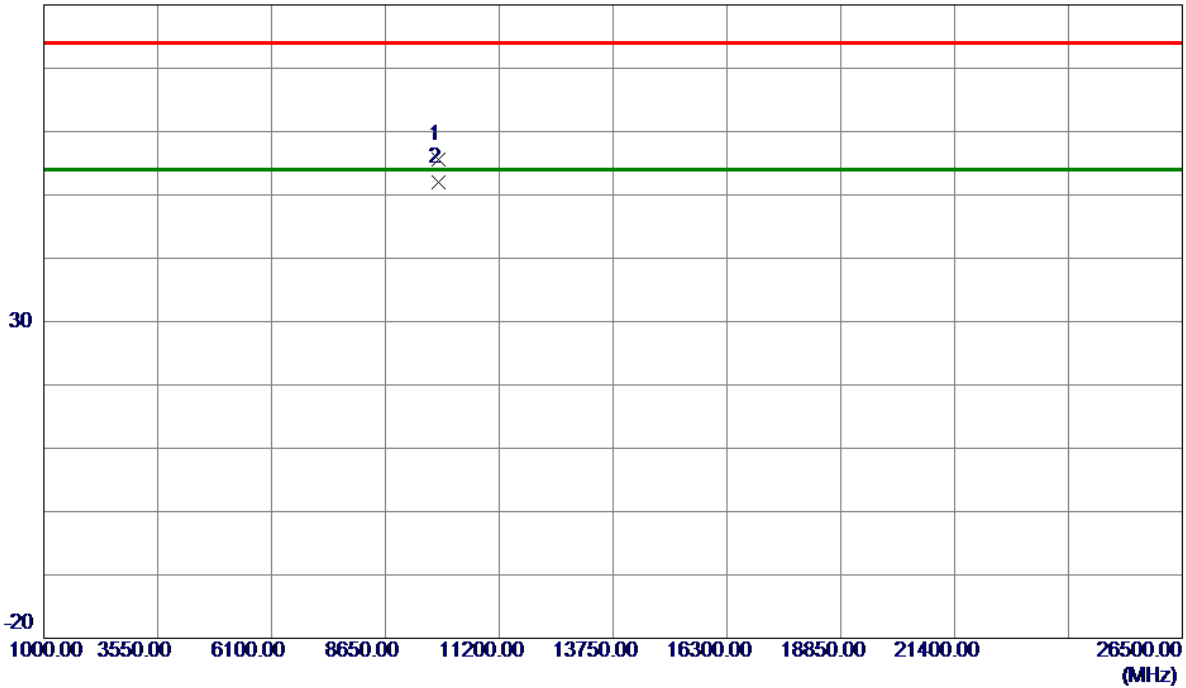

No.	Freq. MHz	Reading Level dBuV/m	Correct Factor dB	Measure ment dBuV/m	Limit dBuV/m	Margin dB	Detector	Comment
1	9848.5000	56.10	-0.45	55.65	74.00	-18.35	Peak	
2 *	9848.5000	52.47	-0.45	52.02	54.00	-1.98	AVG	

REMARKS:

- (1) Measurement Value = Reading Level + Correct Factor.
- (2) Margin Level = Measurement Value - Limit Value.
- (3) "*" is not in restricted band, its limit is 30dBc of the fundamental emission level(111.3dBuV/m) or 15.209 Which is higher.

Test Mode: TX N-40M Mode 2422MHz

Vertical

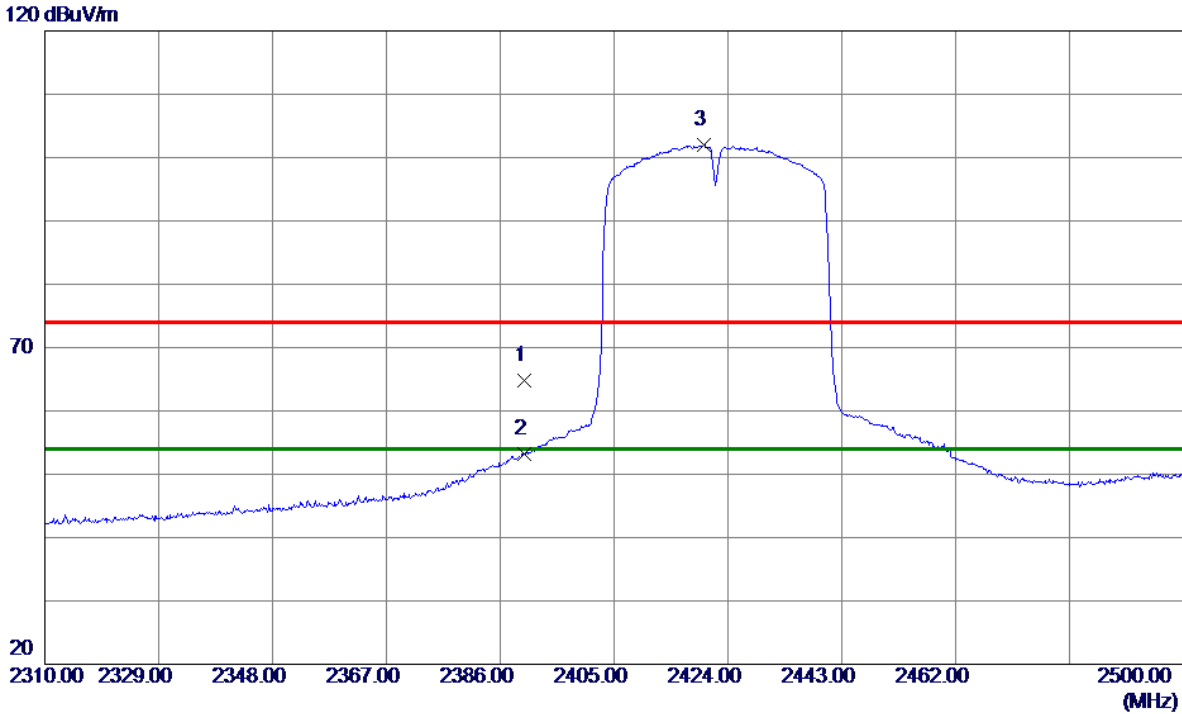

No.	Freq. MHz	Reading Level dBuV/m	Correct Factor dB	Measure ment dBuV/m	Limit dBuV/m	Margin dB	Detector	Comment
1	2390.0000	31.42	33.36	64.78	74.00	-9.22	Peak	
2	2390.0000	19.78	33.36	53.14	54.00	-0.86	AVG	
3 *	2419.9150	68.42	33.49	101.91	54.00	47.91	AVG	No limit

REMARKS:

- (1) Measurement Value = Reading Level + Correct Factor.
- (2) Margin Level = Measurement Value - Limit Value.

Test Mode: TX N-40M Mode 2422MHz

Vertical

80 dBuV/m

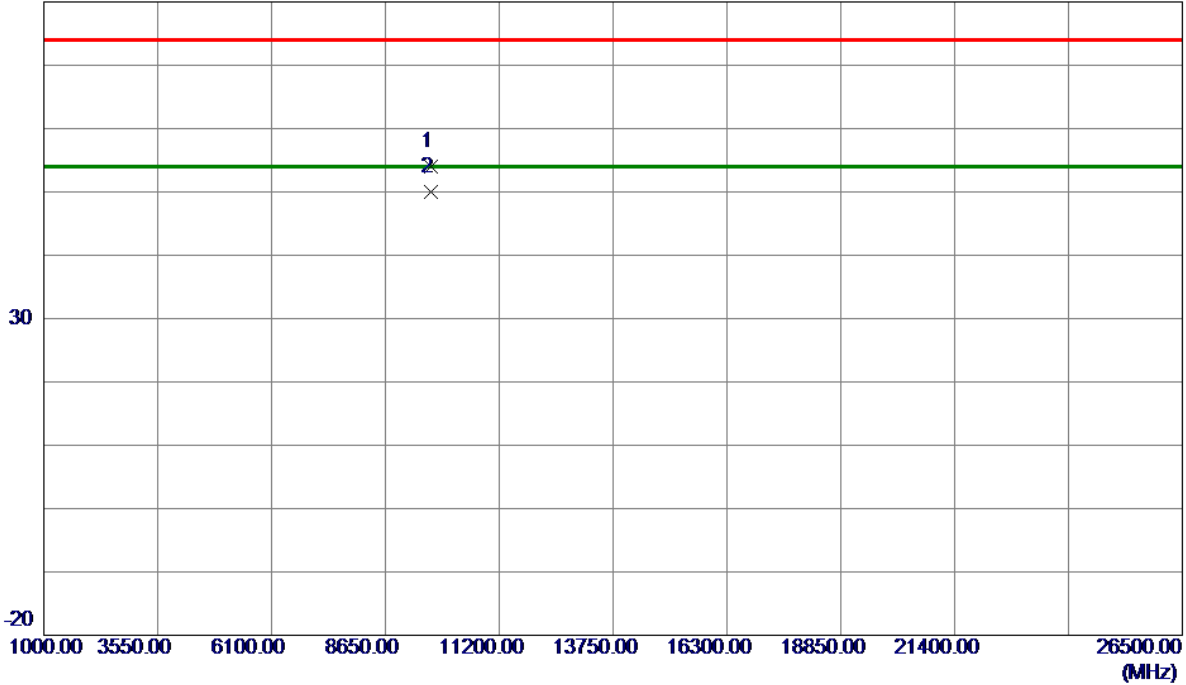

No.	Freq. MHz	Reading Level dBuV/m	Correct Factor dB	Measure ment dBuV/m	Limit dBuV/m	Margin dB	Detector	Comment
1	9682.7500	54.44	-0.43	54.01	74.00	-19.99	Peak	
2 *	9682.7500	50.47	-0.43	50.04	54.00	-3.96	AVG	

REMARKS:

- (1) Measurement Value = Reading Level + Correct Factor.
- (2) Margin Level = Measurement Value - Limit Value.
- (3) "*" is not in restricted band, its limit is 30dBc of the fundamental emission level(111.3dBuV/m) or 15.209 Which is higher.

Test Mode: TX N-40M Mode 2422MHz

Horizontal

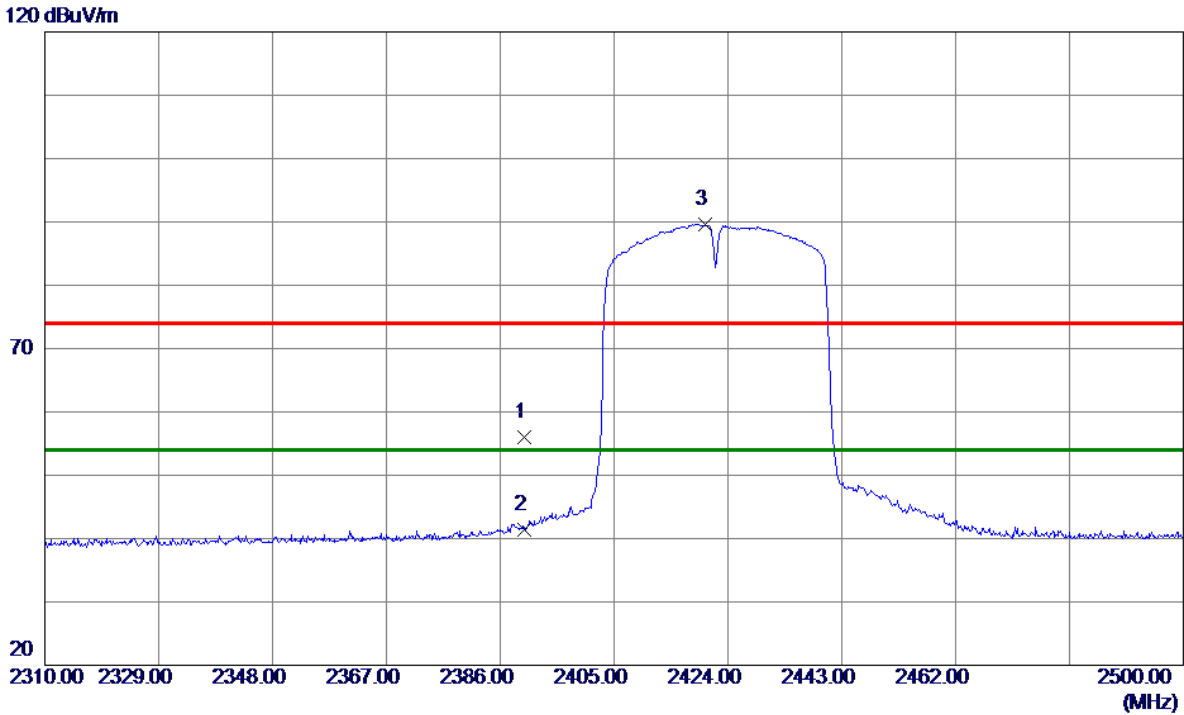

No.	Freq. MHz	Reading Level dBuV/m	Correct Factor dB	Measure ment dBuV/m	Limit dBuV/m	Margin dB	Detector	Comment
1	2390.0000	22.71	33.36	56.07	74.00	-17.93	Peak	
2	2390.0000	8.05	33.36	41.41	54.00	-12.59	AVG	
3 *	2420.1050	56.14	33.49	89.63	54.00	35.63	AVG	No limit

REMARKS:

- (1) Measurement Value = Reading Level + Correct Factor.
- (2) Margin Level = Measurement Value - Limit Value.

Test Mode: TX N-40M Mode 2422MHz

Horizontal

80 dBuV/m

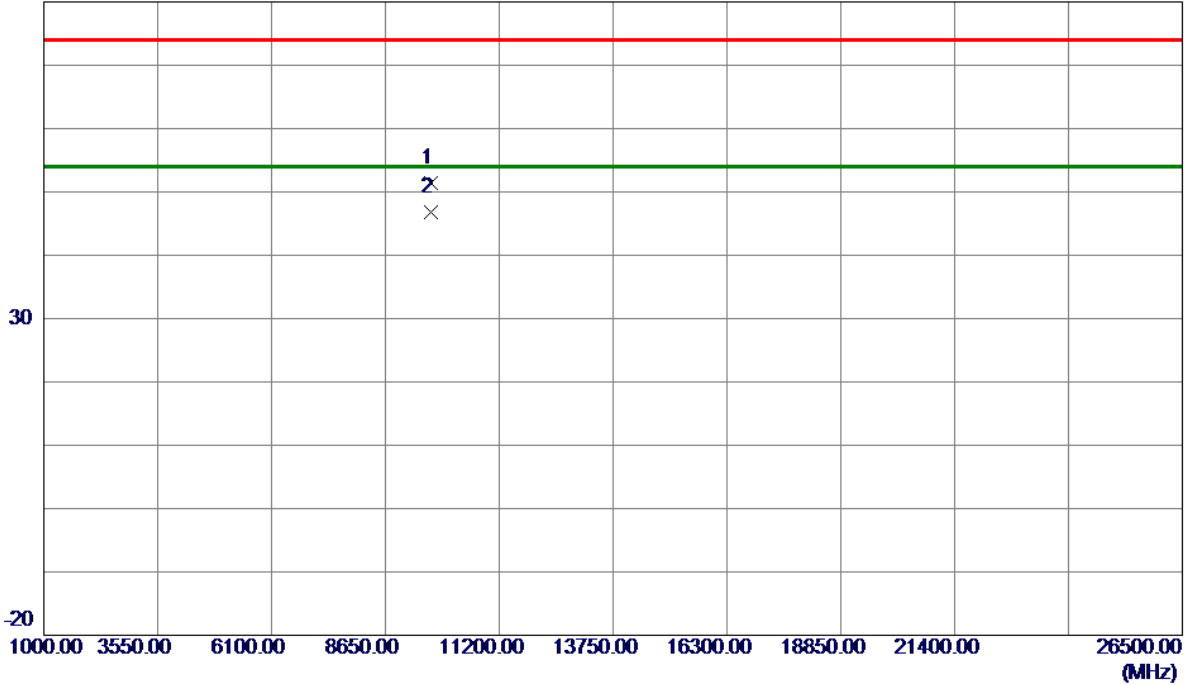

No.	Freq. MHz	Reading Level dBuV/m	Correct Factor dB	Measure ment dBuV/m	Limit dBuV/m	Margin dB	Detector	Comment
1	9682.7500	51.80	-0.43	51.37	74.00	-22.63	Peak	
2 *	9682.7500	47.24	-0.43	46.81	54.00	-7.19	AVG	

REMARKS:

- (1) Measurement Value = Reading Level + Correct Factor.
- (2) Margin Level = Measurement Value - Limit Value.
- (3) "*" is not in restricted band, its limit is 30dBc of the fundamental emission level(111.3dBuV/m) or 15.209 Which is higher.

Test Mode: TX N-40M Mode 2437 MHz

Vertical

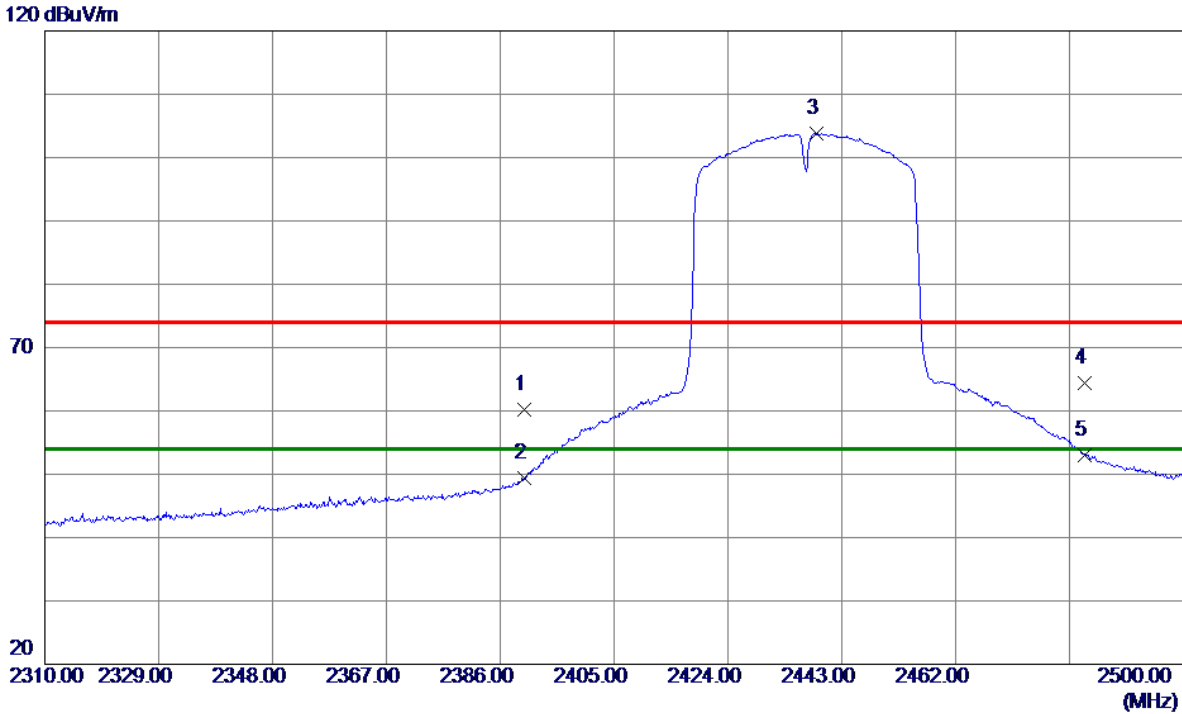

No.	Freq. MHz	Reading Level dBuV/m	Correct Factor dB	Measure ment dBuV/m	Limit dBuV/m	Margin dB	Detector	Comment
1	2390.0000	26.87	33.36	60.23	74.00	-13.77	Peak	
2	2390.0000	15.98	33.36	49.34	54.00	-4.66	AVG	
3 *	2438.8200	70.21	33.57	103.78	54.00	49.78	AVG	No limit
4	2483.5000	30.71	33.76	64.47	74.00	-9.53	Peak	
5	2483.5000	19.19	33.76	52.95	54.00	-1.05	AVG	

REMARKS:

- (1) Measurement Value = Reading Level + Correct Factor.
- (2) Margin Level = Measurement Value - Limit Value.

Test Mode: TX N-40M Mode 2437 MHz

Vertical

80 dBuV/m

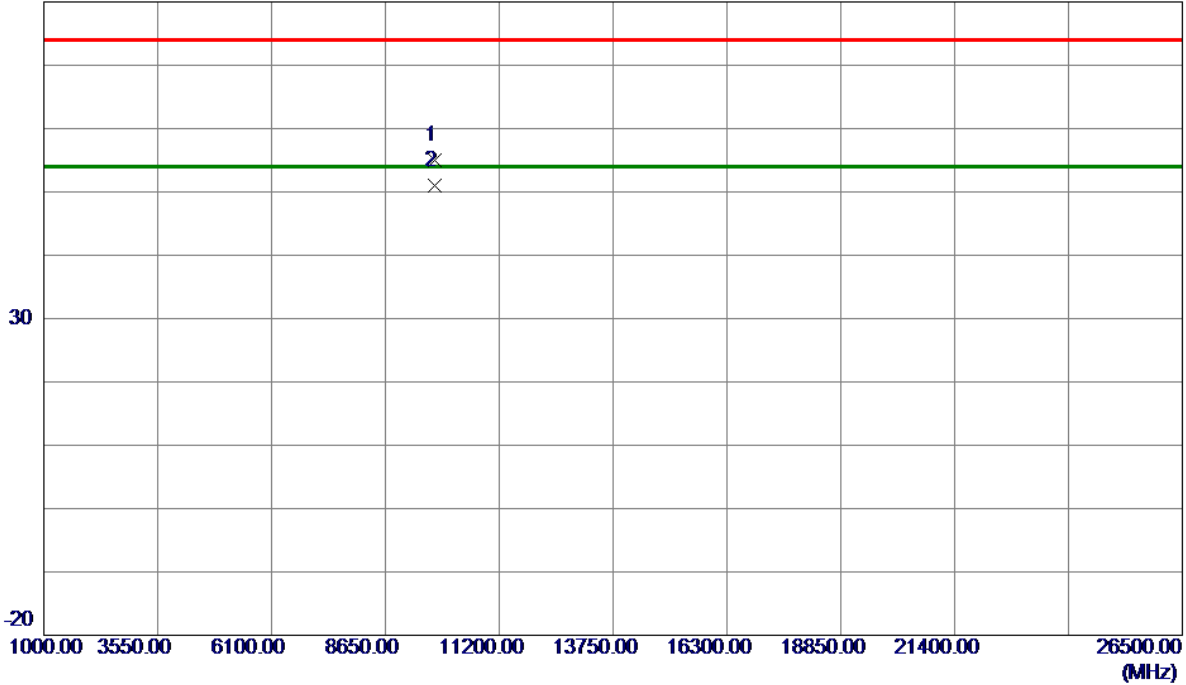

No.	Freq. MHz	Reading Level dBuV/m	Correct Factor dB	Measure ment dBuV/m	Limit dBuV/m	Margin dB	Detector	Comment
1	9746.5000	55.41	-0.44	54.97	74.00	-19.03	Peak	
2 *	9746.5000	51.47	-0.44	51.03	54.00	-2.97	AVG	

REMARKS:

- (1) Measurement Value = Reading Level + Correct Factor.
- (2) Margin Level = Measurement Value - Limit Value.
- (3) "*" is not in restricted band, its limit is 30dBc of the fundamental emission level(111.3dBuV/m) or 15.209 Which is higher.

Test Mode: TX N-40M Mode 2437 MHz

Horizontal

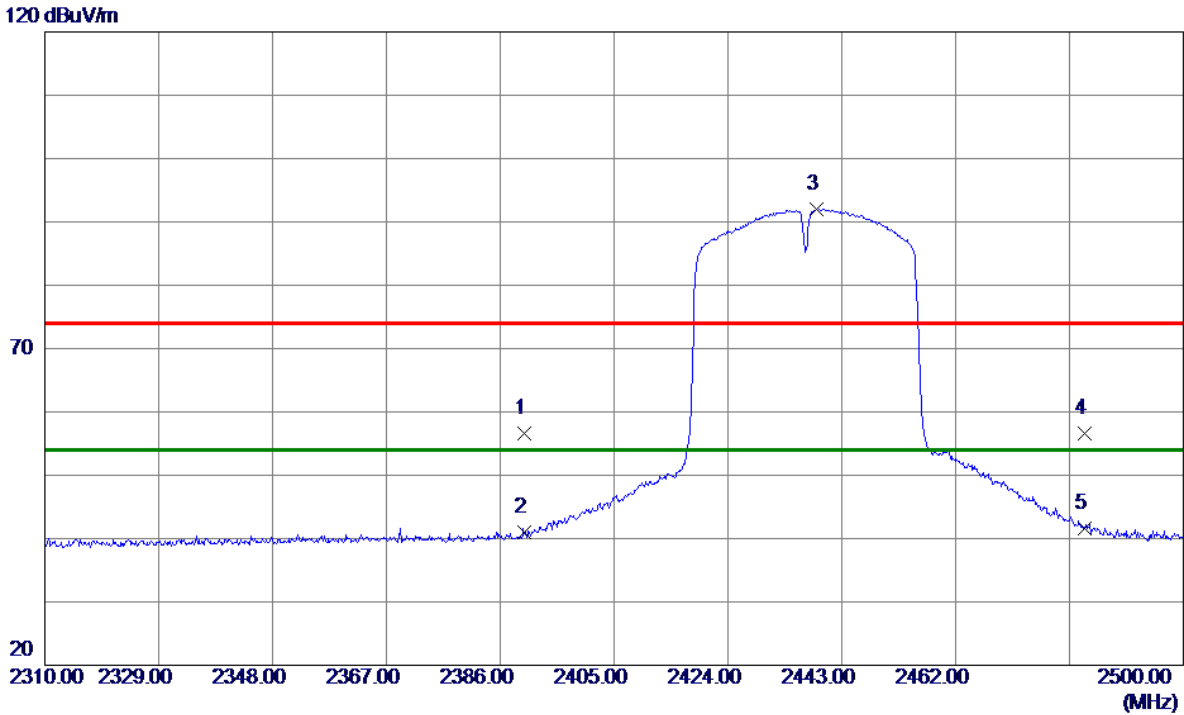

No.	Freq. MHz	Reading Level dBuV/m	Correct Factor dB	Measure ment dBuV/m	Limit dBuV/m	Margin dB	Detector	Comment
1	2390.0000	23.19	33.36	56.55	74.00	-17.45	Peak	
2	2390.0000	7.68	33.36	41.04	54.00	-12.96	AVG	
3 *	2438.7250	58.47	33.57	92.04	54.00	38.04	AVG	No limit
4	2483.5000	22.89	33.76	56.65	74.00	-17.35	Peak	
5	2483.5000	7.82	33.76	41.58	54.00	-12.42	AVG	

REMARKS:

(1) Measurement Value = Reading Level + Correct Factor.

(2) Margin Level = Measurement Value - Limit Value.

Test Mode: TX N-40M Mode 2437 MHz

Horizontal

80 dBuV/m

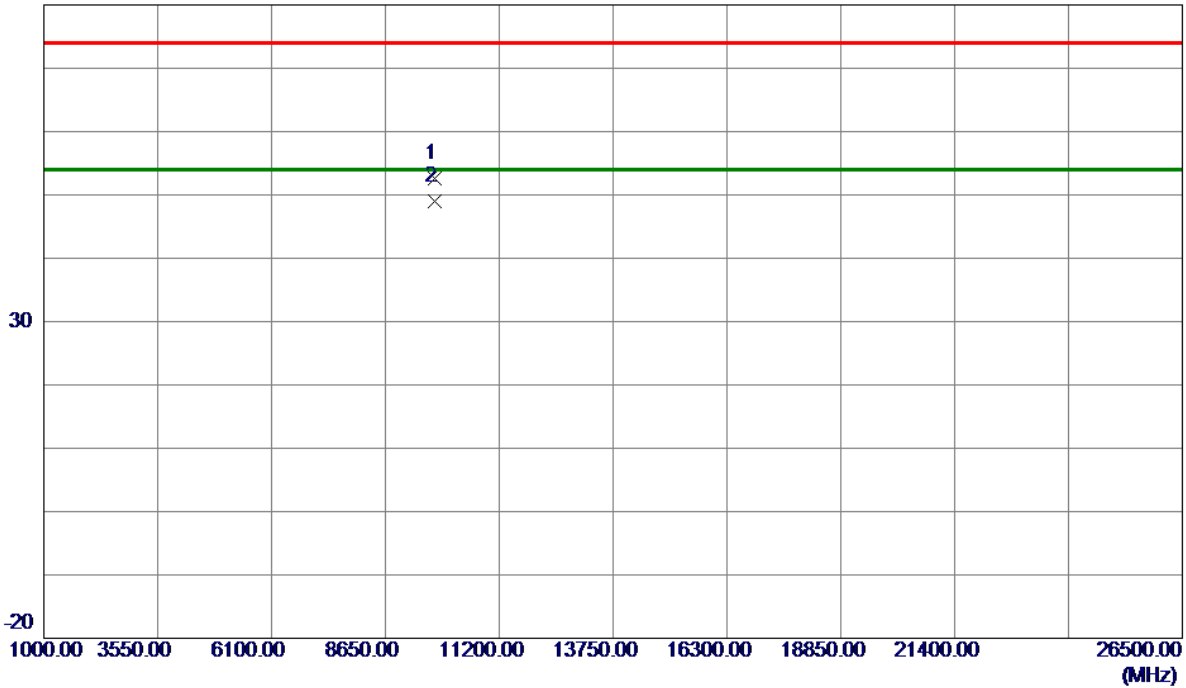

No.	Freq. MHz	Reading Level dBuV/m	Correct Factor dB	Measure ment dBuV/m	Limit dBuV/m	Margin dB	Detector	Comment
1	9746.5000	53.08	-0.44	52.64	74.00	-21.36	Peak	
2 *	9746.5000	49.53	-0.44	49.09	54.00	-4.91	AVG	

REMARKS:

- (1) Measurement Value = Reading Level + Correct Factor.
- (2) Margin Level = Measurement Value - Limit Value.
- (3) "*" is not in restricted band, its limit is 30dBc of the fundamental emission level(111.3dBuV/m) or 15.209 Which is higher.

Test Mode: TX N-40M Mode 2452 MHz

Vertical

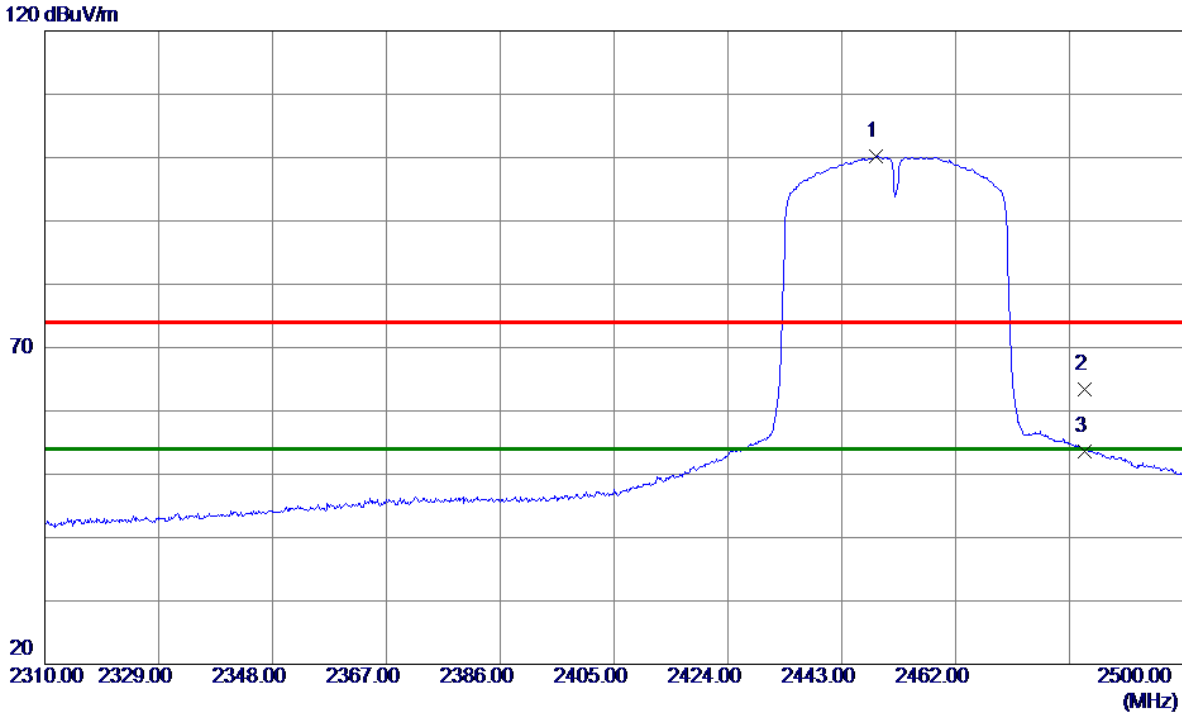

No.	Freq. MHz	Reading Level dBuV/m	Correct Factor dB	Measure ment dBuV/m	Limit dBuV/m	Margin dB	Detector	Comment
1 *	2448.7950	66.54	33.61	100.15	54.00	46.15	AVG	No limit
2	2483.5000	29.69	33.76	63.45	74.00	-10.55	Peak	
3	2483.5000	19.93	33.76	53.69	54.00	-0.31	AVG	

REMARKS:

- (1) Measurement Value = Reading Level + Correct Factor.
- (2) Margin Level = Measurement Value - Limit Value.

Test Mode: TX N-40M Mode 2452 MHz

Vertical

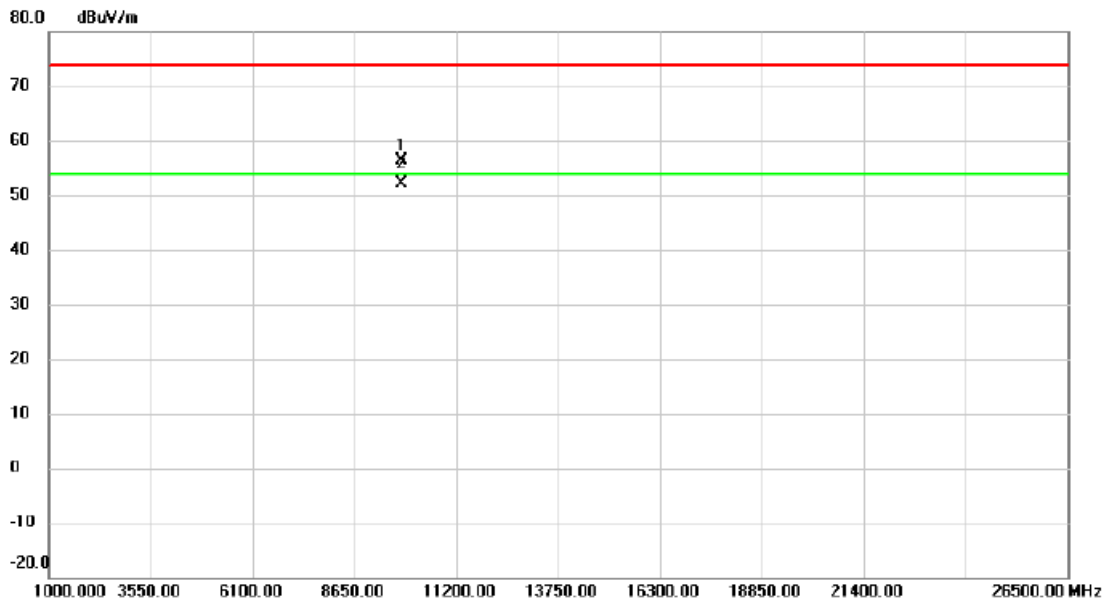

No.	Mk.	Freq. MHz	Reading Level dBuV	Correct Factor dB	Measure- ment dBuV/m	Limit dBuV/m	Margin dB	Detector	Comment
1		9810.250	56.73	-0.44	56.29	74.00	-17.71	peak	
2	*	9810.250	52.47	-0.44	52.03	54.00	-1.97	AVG	

REMARKS:

- (1) Measurement Value = Reading Level + Correct Factor.
- (2) Margin Level = Measurement Value - Limit Value.
- (3) "*" is not in restricted band, its limit is 30dBc of the fundamental emission level(111.3dBuV/m) or 15.209 Which is higher.

Test Mode: TX N-40M Mode 2452 MHz

Horizontal

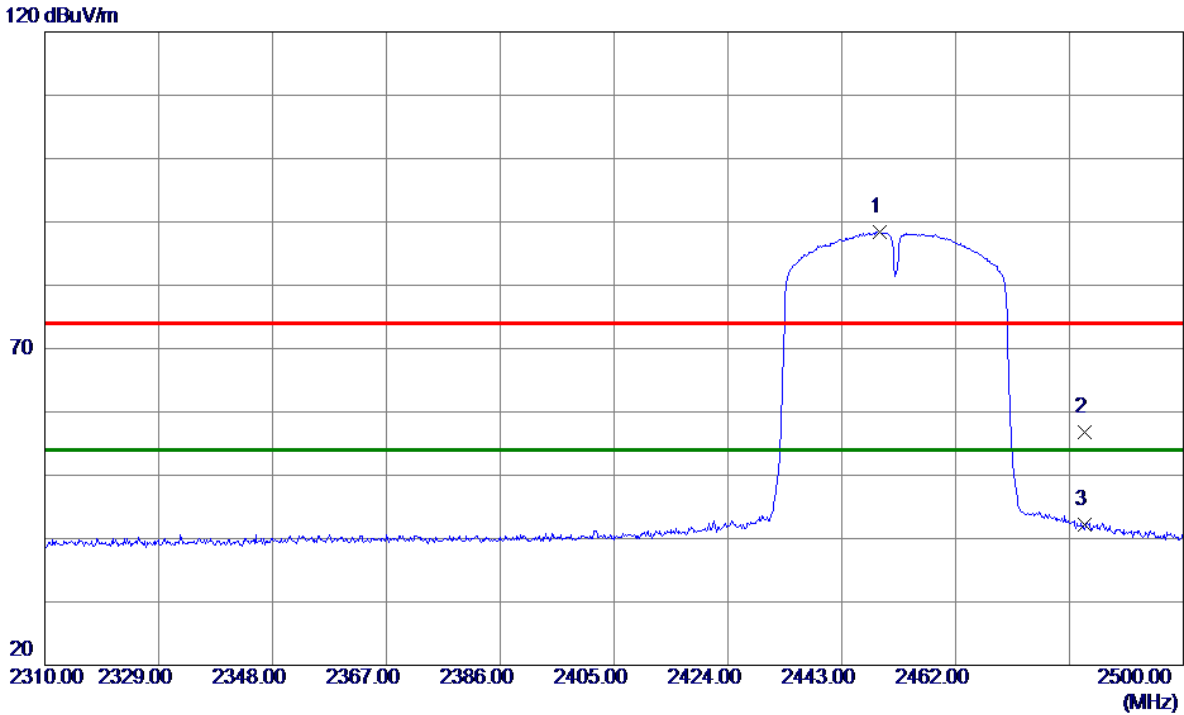

No.	Freq. MHz	Reading Level dBuV/m	Correct Factor dB	Measure ment dBuV/m	Limit dBuV/m	Margin dB	Detector	Comment
1 *	2449.2700	54.81	33.61	88.42	54.00	34.42	AVG	No limit
2	2483.5000	23.07	33.76	56.83	74.00	-17.17	Peak	
3	2483.5000	8.38	33.76	42.14	54.00	-11.86	AVG	

REMARKS:

- (1) Measurement Value = Reading Level + Correct Factor.
- (2) Margin Level = Measurement Value - Limit Value.

Test Mode: TX N-40M Mode 2452 MHz

Horizontal

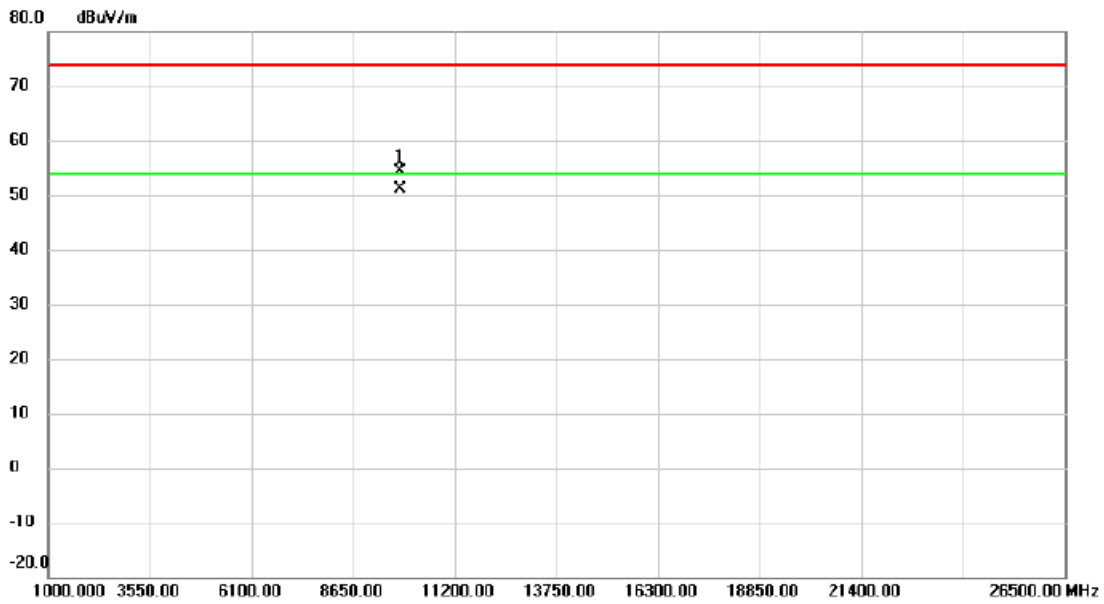

No.	Mk.	Freq. MHz	Reading Level dBuV	Correct Factor dB	Measure- ment dBuV/m	Limit dBuV/m	Margin dB	Detector	Comment
1		9810.250	54.77	-0.44	54.33	74.00	-19.67	peak	
2	*	9810.250	51.57	-0.44	51.13	54.00	-2.87	AVG	

REMARKS:

- (1) Measurement Value = Reading Level + Correct Factor.
- (2) Margin Level = Measurement Value - Limit Value.
- (3) "*" is not in restricted band, its limit is 30dBc of the fundamental emission level(111.3dBuV/m) or 15.209 Which is higher.

APPENDIX E - BANDWIDTH

CDD

Test Mode	TX B Mode
-----------	-----------

Channel	Frequency (MHz)	6 dB Bandwidth (MHz)	6 dB Bandwidth Min. Limit (kHz)	Result
01	2412	10.14	500	Complies
06	2437	10.20	500	Complies
11	2462	10.14	500	Complies

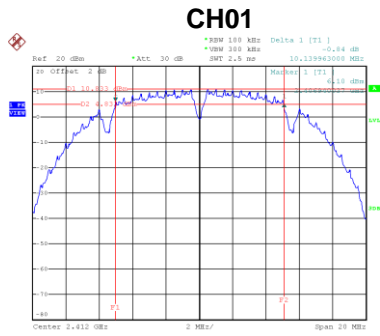

Date: 20_JUN.2020 11:25:55

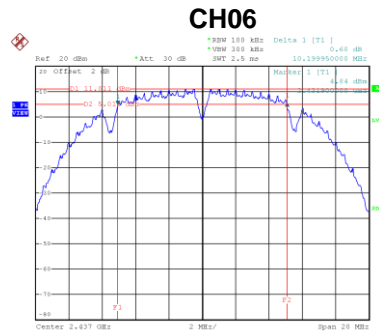

Date: 20_JUN.2020 11:30:14

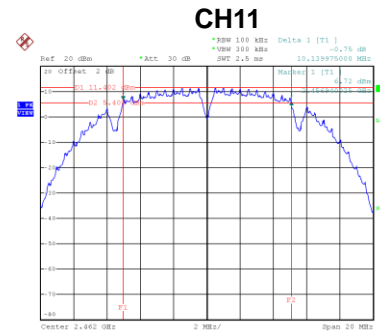

Date: 20_JUN.2020 11:34:45

Channel	Frequency (MHz)	99 % Emission Bandwidth (MHz)	Result
01	2412	13.60	Complies
06	2437	13.60	Complies
11	2462	13.60	Complies

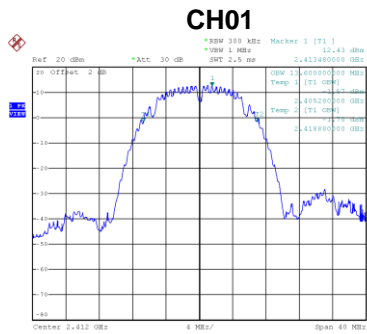

Date: 20_JUN.2020 11:26:02

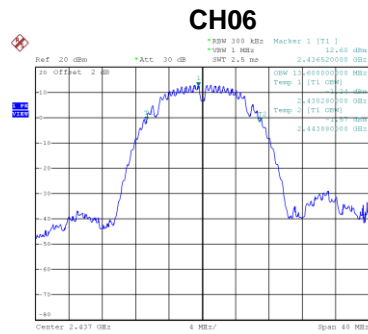

Date: 20_JUN.2020 11:30:20

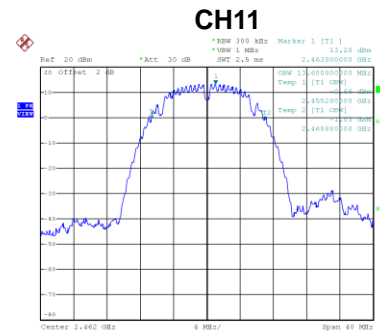

Date: 20_JUN.2020 11:34:52

Test Mode	TX G Mode
-----------	-----------

Channel	Frequency (MHz)	6 dB Bandwidth (MHz)	6 dB Bandwidth Min. Limit (kHz)	Result
01	2412	16.57	500	Complies
06	2437	16.58	500	Complies
11	2462	16.58	500	Complies

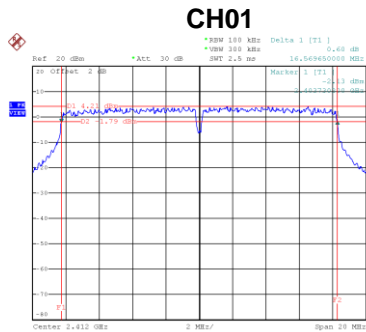

Date: 20_JUN.2020 12:10:4146

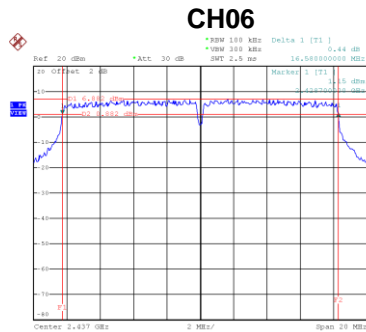

Date: 20_JUN.2020 11:44:110

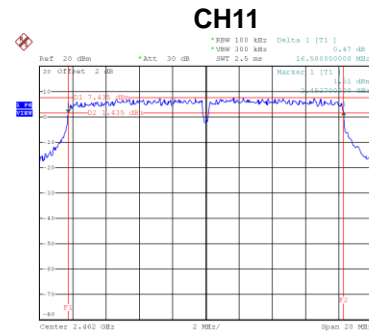

Date: 20_JUN.2020 11:36:135

Channel	Frequency (MHz)	99 % Emission Bandwidth (MHz)	Result
01	2412	16.80	Complies
06	2437	16.96	Complies
11	2462	17.04	Complies

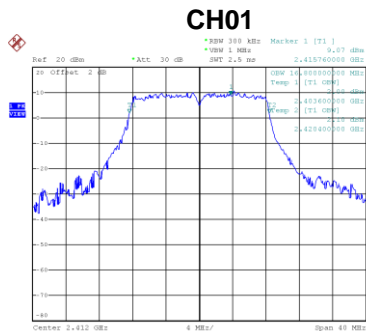

Date: 20_JUN.2020 12:10:4153

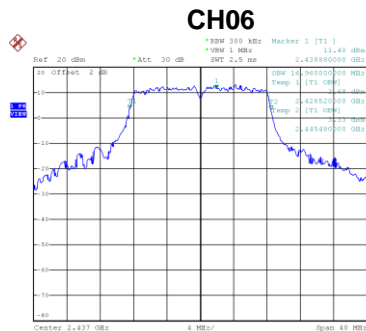

Date: 20_JUN.2020 11:44:116

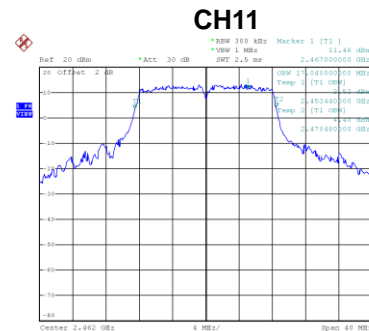

Date: 20_JUN.2020 11:36:142

Test Mode	TX N-20M Mode
-----------	---------------

Channel	Frequency (MHz)	6 dB Bandwidth (MHz)	6 dB Bandwidth Min. Limit (kHz)	Result
01	2412	17.88	500	Complies
06	2437	17.81	500	Complies
11	2462	17.78	500	Complies

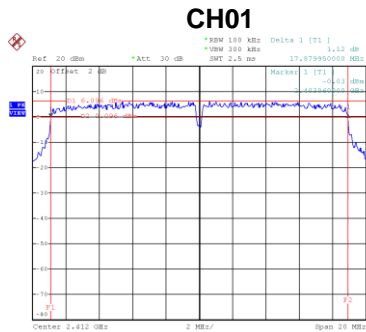

Date: 20_JUN,2020 12:10:110

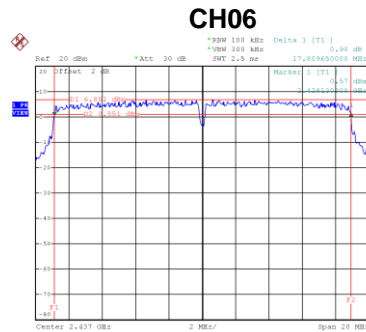

Date: 20_JUN,2020 12:11:135

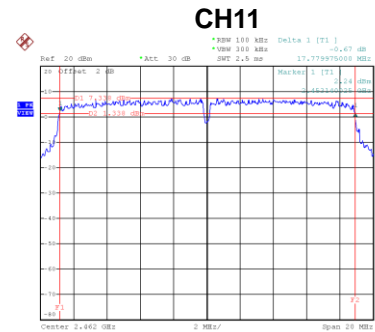

Date: 20_JUN,2020 12:11:142

Channel	Frequency (MHz)	99 % Emission Bandwidth (MHz)	Result
01	2412	18.08	Complies
06	2437	18.00	Complies
11	2462	18.00	Complies

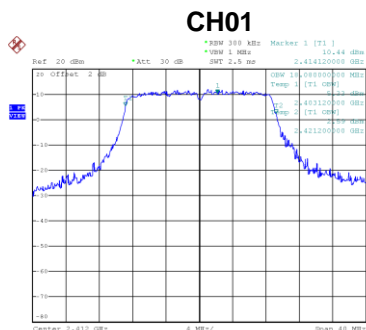

Date: 20_JUN,2020 12:10:117

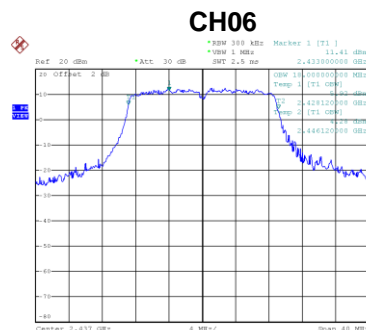

Date: 20_JUN,2020 12:11:142

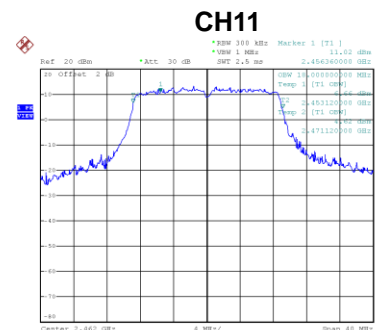

Date: 20_JUN,2020 12:11:149

Test Mode	TX N-40M Mode
-----------	---------------

Channel	Frequency (MHz)	6 dB Bandwidth (MHz)	6 dB Bandwidth Min. Limit (kHz)	Result
03	2422	34.48	500	Complies
06	2437	35.32	500	Complies
09	2452	34.79	500	Complies

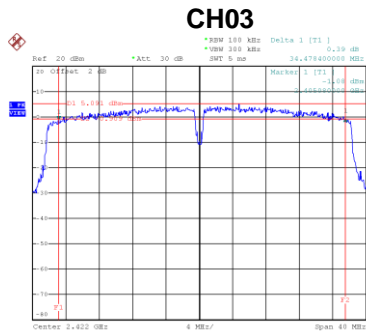

Date: 20_JUN,2020 13:21:52

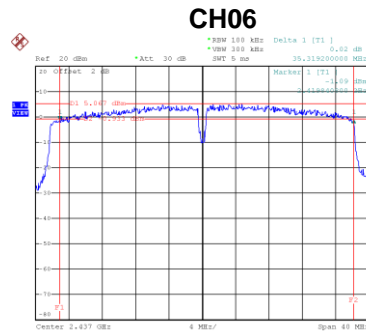

Date: 20_JUN,2020 13:24:51

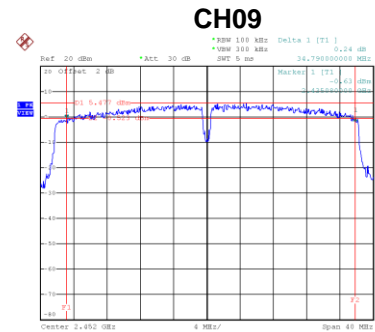

Date: 20_JUN,2020 13:42:12

Channel	Frequency (MHz)	99 % Emission Bandwidth (MHz)	Result
03	2422	35.84	Complies
06	2437	35.84	Complies
09	2452	35.84	Complies

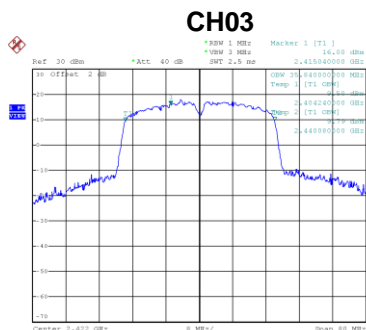

Date: 20_JUN,2020 13:51:40

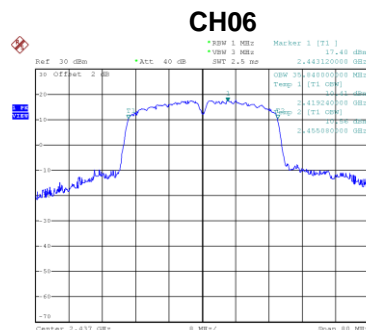

Date: 20_JUN,2020 13:52:35

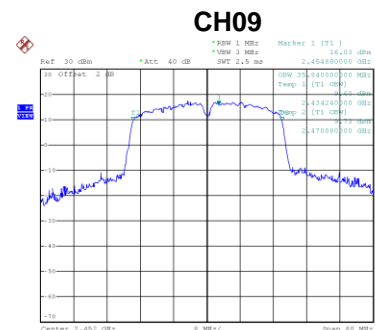

Date: 20_JUN,2020 13:47:11

APPENDIX F - MAXIMUM OUTPUT POWER

CDD

Test Mode	TX B Mode
-----------	-----------

Channel	Frequency (MHz)	Avg Output Power (dBm)	Duty Factor	Output Power + Duty Factor (dBm)	Max. Limit (dBm)	Max. Limit (W)	Result
01	2412	21.32	0.00	21.32	30.00	1.0000	Complies
06	2437	21.77	0.00	21.77	30.00	1.0000	Complies
11	2462	16.32	0.00	16.32	30.00	1.0000	Complies

Test Mode	TX G Mode_Ant. 1
-----------	------------------

Channel	Frequency (MHz)	Avg Output Power (dBm)	Duty Factor	Output Power + Duty Factor (dBm)	Max. Limit (dBm)	Max. Limit (W)	Result
01	2412	15.49	0.00	15.49	30.00	1.0000	Complies
06	2437	21.13	0.00	21.13	30.00	1.0000	Complies
11	2462	15.37	0.00	15.37	30.00	1.0000	Complies

Test Mode	TX G Mode_Ant. 2
-----------	------------------

Channel	Frequency (MHz)	Avg Output Power (dBm)	Duty Factor	Output Power + Duty Factor (dBm)	Max. Limit (dBm)	Max. Limit (W)	Result
01	2412	15.82	0.00	15.82	30.00	1.0000	Complies
06	2437	21.27	0.00	21.27	30.00	1.0000	Complies
11	2462	14.65	0.00	14.65	30.00	1.0000	Complies

Test Mode	TX G Mode_Total
-----------	-----------------

Channel	Frequency (MHz)	Avg Output Power (dBm)	Max. Limit (dBm)	Max. Limit (W)	Result
01	2412	18.67	30.00	1.0000	Complies
06	2437	24.21	30.00	1.0000	Complies
11	2462	18.04	30.00	1.0000	Complies

Test Mode	TX N-20M Mode_Ant. 1
-----------	----------------------

Channel	Frequency (MHz)	Avg Output Power (dBm)	Duty Factor	Output Power + Duty Factor (dBm)	Max. Limit (dBm)	Max. Limit (W)	Result
01	2412	16.29	0.00	16.29	30.00	1.0000	Complies
06	2437	21.42	0.00	21.42	30.00	1.0000	Complies
11	2462	15.38	0.00	15.38	30.00	1.0000	Complies

Test Mode	TX N-20M Mode_Ant. 2
-----------	----------------------

Channel	Frequency (MHz)	Avg Output Power (dBm)	Duty Factor	Output Power + Duty Factor (dBm)	Max. Limit (dBm)	Max. Limit (W)	Result
01	2412	17.02	0.00	17.02	30.00	1.0000	Complies
06	2437	21.16	0.00	21.16	30.00	1.0000	Complies
11	2462	15.33	0.00	15.33	30.00	1.0000	Complies

Test Mode	TX N-20M Mode_Total
-----------	---------------------

Channel	Frequency (MHz)	Avg Output Power (dBm)	Max. Limit (dBm)	Max. Limit (W)	Result
01	2412	19.68	30.00	1.0000	Complies
06	2437	24.30	30.00	1.0000	Complies
11	2462	18.37	30.00	1.0000	Complies

Test Mode	TX N-40M Mode_Ant. 1
-----------	----------------------

Channel	Frequency (MHz)	Avg Output Power (dBm)	Duty Factor	Output Power + Duty Factor (dBm)	Max. Limit (dBm)	Max. Limit (W)	Result
03	2422	15.01	0.00	15.01	30.00	1.0000	Complies
06	2437	17.17	0.00	17.17	30.00	1.0000	Complies
09	2452	14.16	0.00	14.16	30.00	1.0000	Complies

Test Mode	TX N-40M Mode_Ant. 2
-----------	----------------------

Channel	Frequency (MHz)	Avg Output Power (dBm)	Duty Factor	Output Power + Duty Factor (dBm)	Max. Limit (dBm)	Max. Limit (W)	Result
03	2422	15.08	0.00	15.08	30.00	1.0000	Complies
06	2437	17.57	0.00	17.57	30.00	1.0000	Complies
09	2452	14.26	0.00	14.26	30.00	1.0000	Complies

Test Mode	TX N-40M Mode_Total
-----------	---------------------

Channel	Frequency (MHz)	Avg Output Power (dBm)	Max. Limit (dBm)	Max. Limit (W)	Result
03	2422	18.06	30.00	1.0000	Complies
06	2437	20.38	30.00	1.0000	Complies
09	2452	17.22	30.00	1.0000	Complies

APPENDIX G - CONDUCTED SPURIOUS EMISSIONS

CDD

Test Mode TX B Mode

Bandedge-CH01

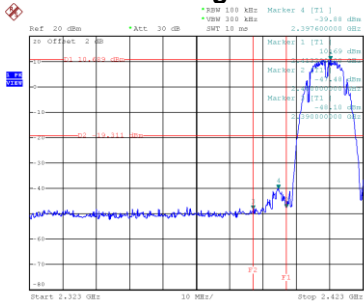

Date: 20.JUN.2020 11:27:00

Bandedge-CH11

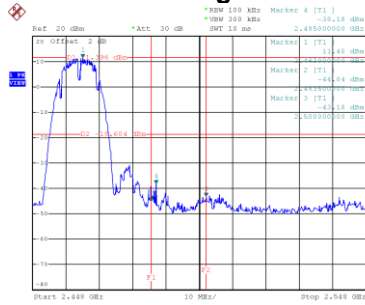

Date: 20.JUN.2020 11:49:28

CH01 – 10th Harmonic of the fundamental frequency

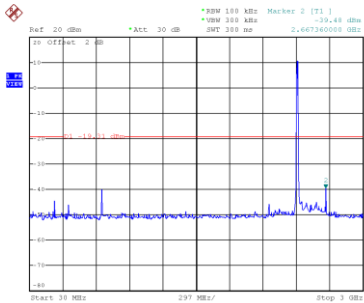

Date: 20.JUN.2020 11:27:13

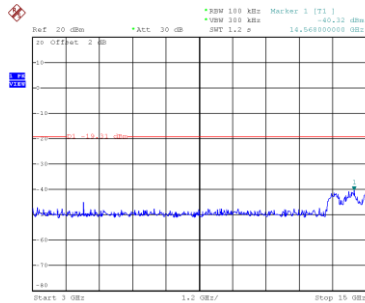

Date: 20.JUN.2020 11:27:20

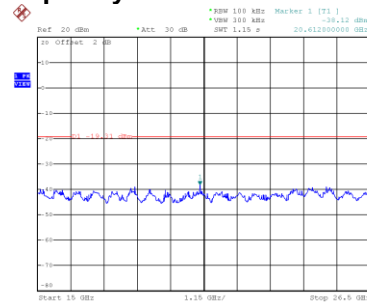

Date: 20.JUN.2020 11:27:27

CH06 – 10th Harmonic of the fundamental frequency

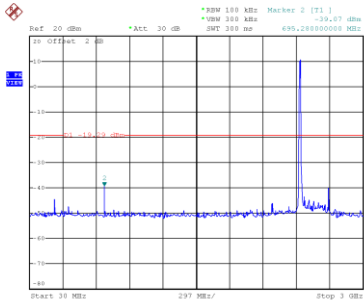

Date: 20.JUN.2020 11:32:12

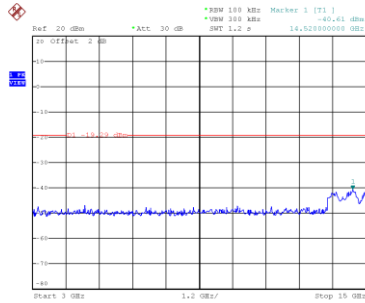

Date: 20.JUN.2020 11:32:50

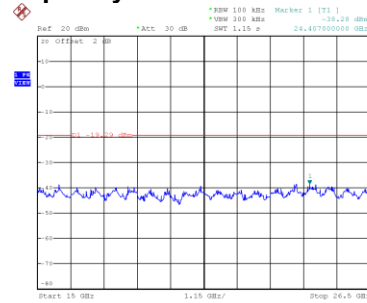

Date: 20.JUN.2020 11:32:57

CH11 – 10th Harmonic of the fundamental frequency

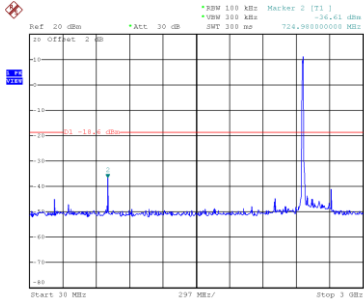

Date: 20.JUN.2020 11:49:42

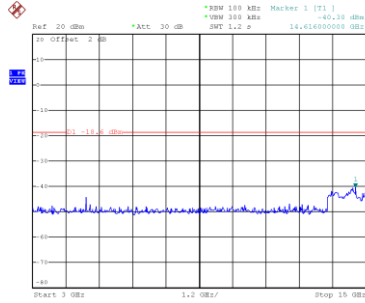

Date: 20.JUN.2020 11:49:49

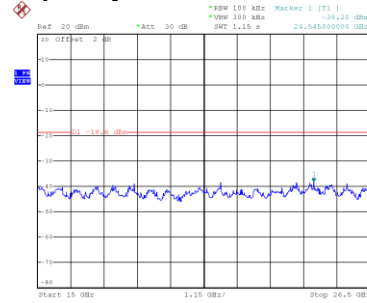

Date: 20.JUN.2020 11:49:56

Test Mode TX G Mode_Ant. 1

Bandedge-CH01

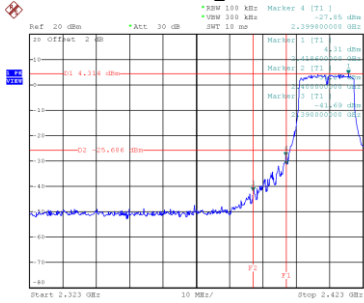

Date: 20.JUN.2020 12:00:29

Bandedge-CH11

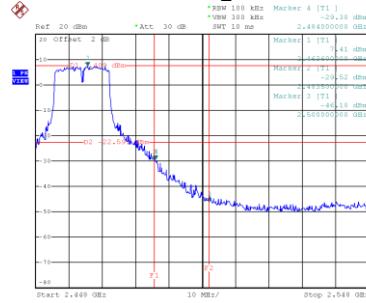

Date: 20.JUN.2020 11:50:58

CH01 – 10th Harmonic of the fundamental frequency

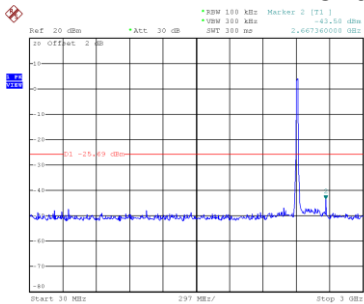

Date: 20.JUN.2020 12:00:42

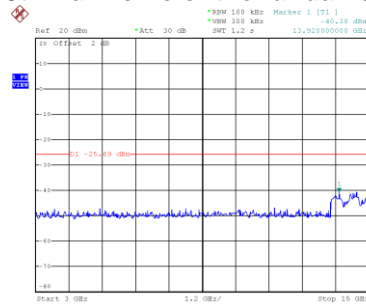

Date: 20.JUN.2020 12:00:49

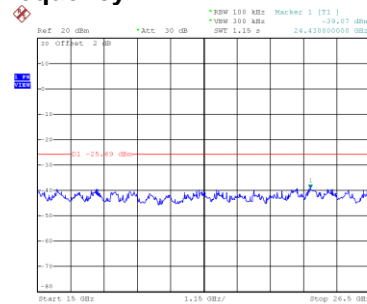

Date: 20.JUN.2020 12:00:56

CH06 – 10th Harmonic of the fundamental frequency

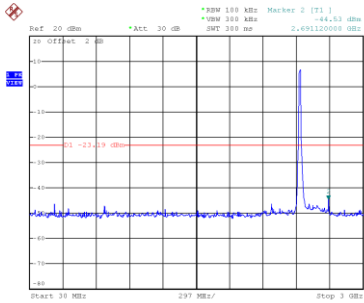

Date: 20.JUN.2020 11:42:43

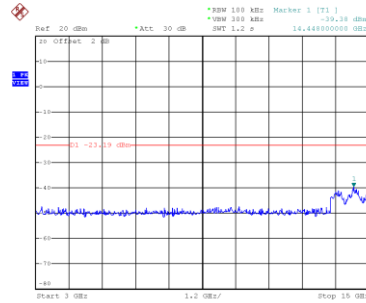

Date: 20.JUN.2020 11:42:50

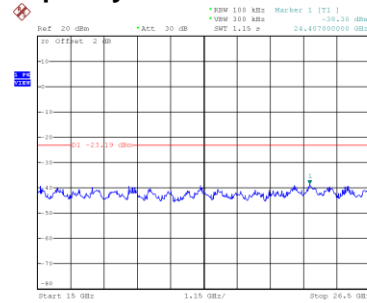

Date: 20.JUN.2020 11:42:57

CH11 – 10th Harmonic of the fundamental frequency

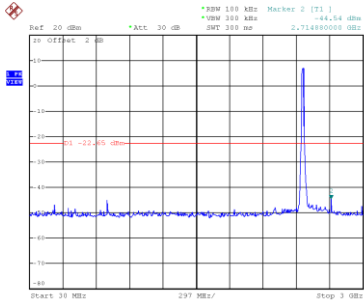

Date: 20.JUN.2020 11:39:37

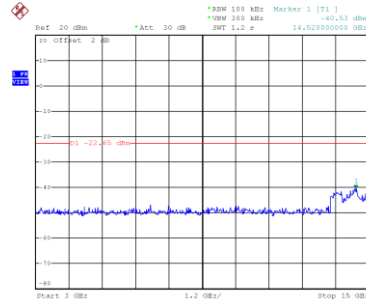

Date: 20.JUN.2020 11:39:44

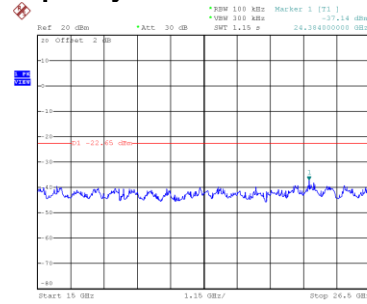

Date: 20.JUN.2020 11:39:51

Test Mode TX G Mode_Ant. 2

Bandedge-CH01

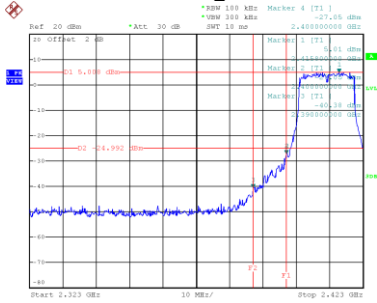

Bandedge-CH11

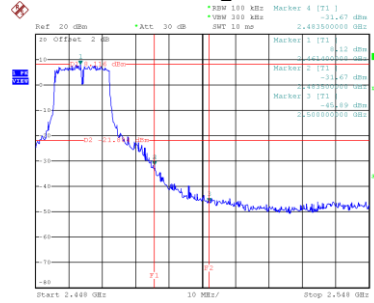

CH01 – 10th Harmonic of the fundamental frequency

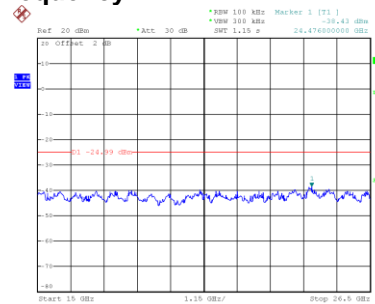
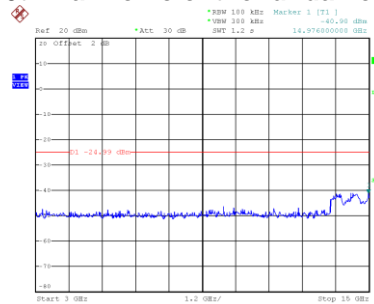
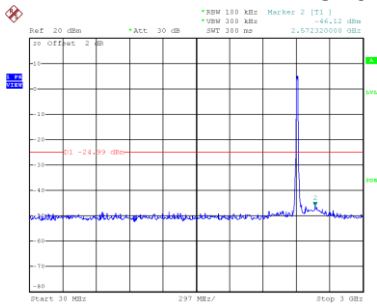

CH06 – 10th Harmonic of the fundamental frequency

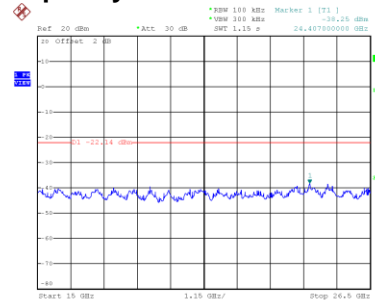
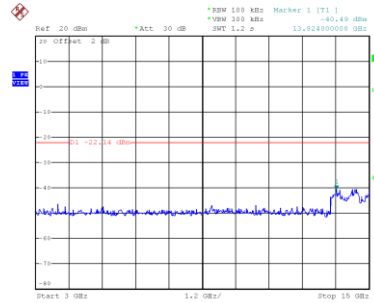
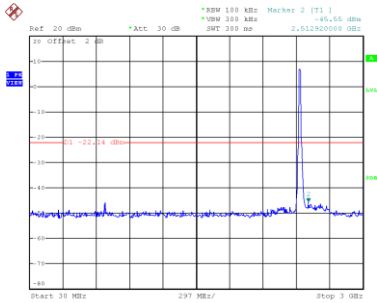

CH11 – 10th Harmonic of the fundamental frequency

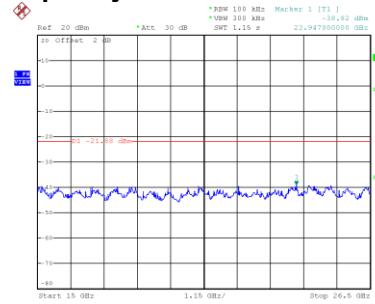
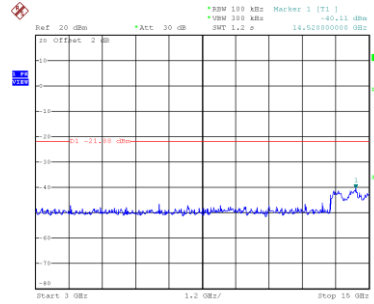
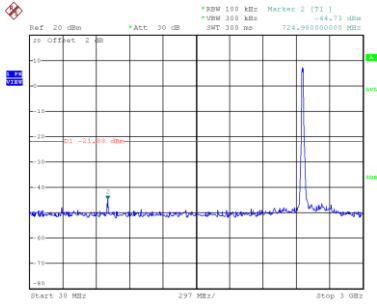

Test Mode TX N-20M Mode_Ant. 1

Bandedge-CH01

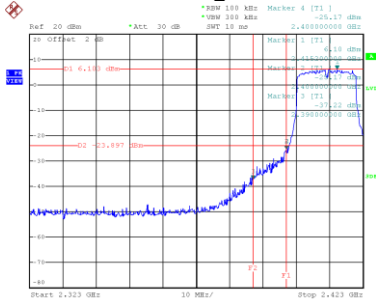

Date: 20.JUN.2020 13:26:18

Bandedge-CH11

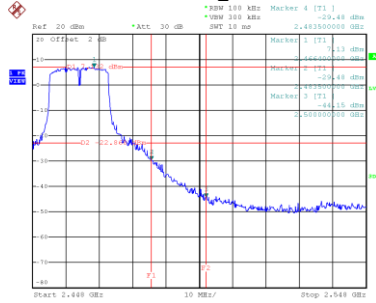

Date: 20.JUN.2020 12:16:29

CH01 – 10th Harmonic of the fundamental frequency

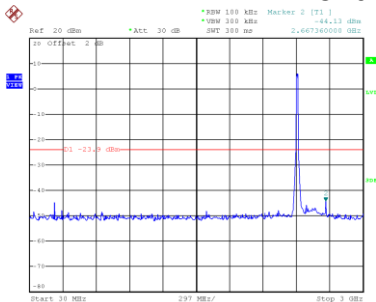

Date: 20.JUN.2020 13:26:13

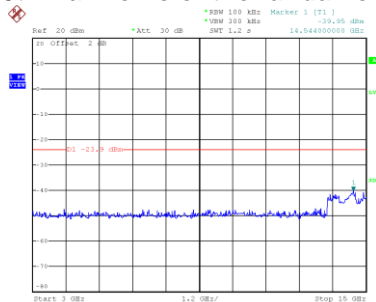

Date: 20.JUN.2020 13:26:38

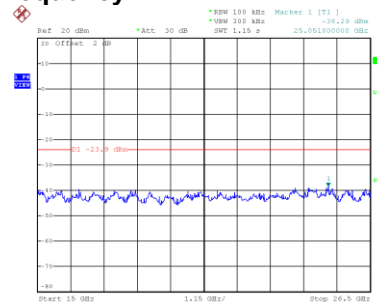

Date: 20.JUN.2020 13:26:45

CH06 – 10th Harmonic of the fundamental frequency

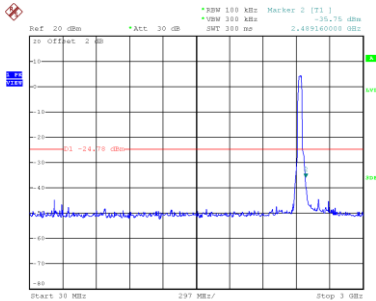

Date: 20.JUN.2020 13:28:45

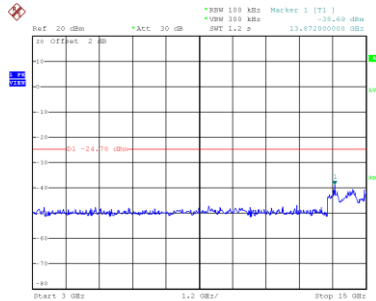

Date: 20.JUN.2020 13:28:52

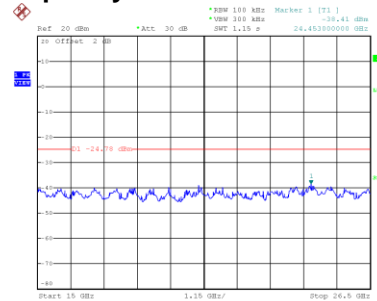

Date: 20.JUN.2020 13:28:59

CH11 – 10th Harmonic of the fundamental frequency

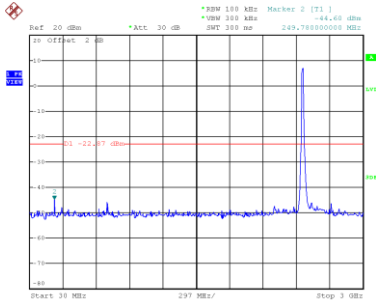

Date: 20.JUN.2020 12:16:42

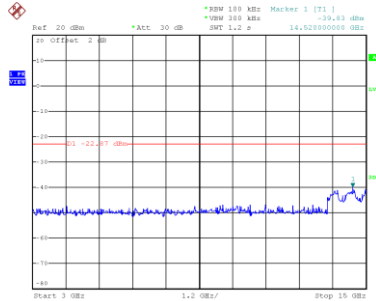

Date: 20.JUN.2020 12:16:49

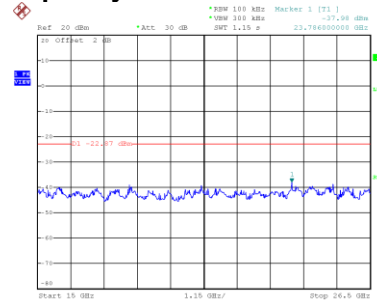

Date: 20.JUN.2020 12:16:57

Test Mode TX N-20M Mode_Ant. 2

Bandedge-CH01

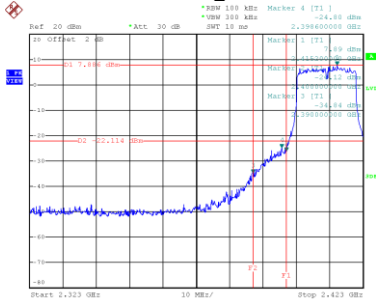

Date: 20.JUN.2020 12:10:26

Bandedge-CH11

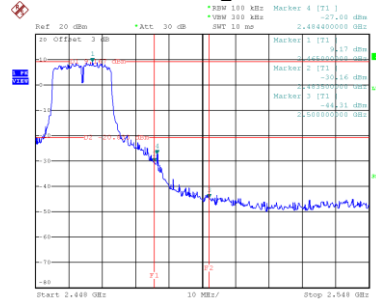

Date: 20.JUN.2020 12:21:03

CH01 – 10th Harmonic of the fundamental frequency

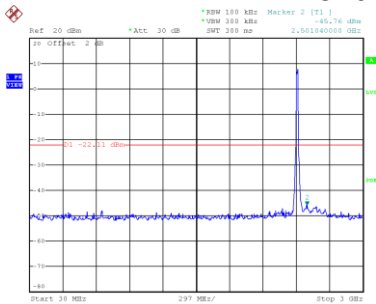

Date: 20.JUN.2020 12:10:39

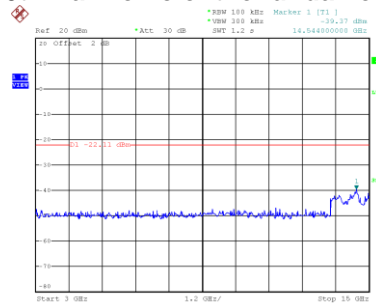

Date: 20.JUN.2020 12:10:46

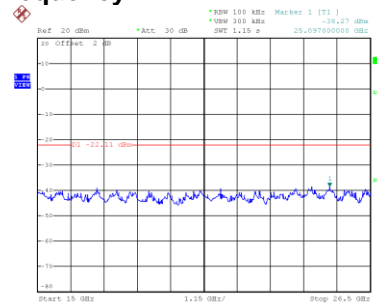

Date: 20.JUN.2020 12:10:53

CH06 – 10th Harmonic of the fundamental frequency

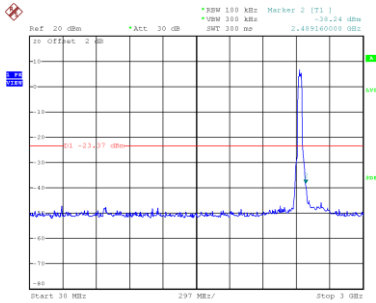

Date: 20.JUN.2020 13:29:44

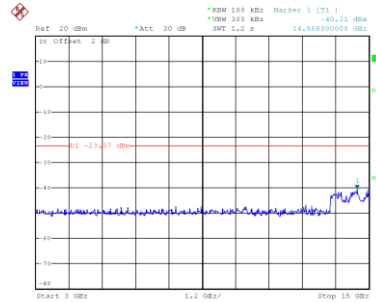

Date: 20.JUN.2020 13:29:51

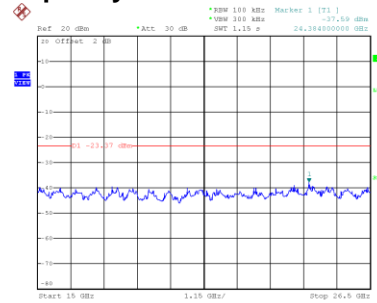

Date: 20.JUN.2020 13:29:58

CH11 – 10th Harmonic of the fundamental frequency

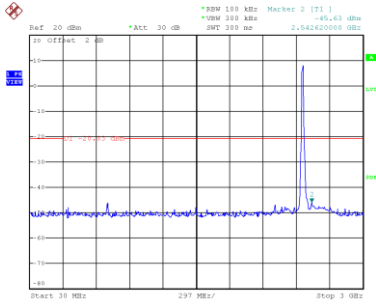

Date: 20.JUN.2020 12:21:17

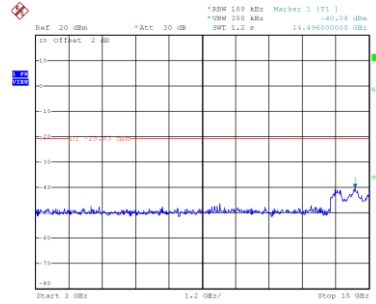

Date: 20.JUN.2020 12:21:24

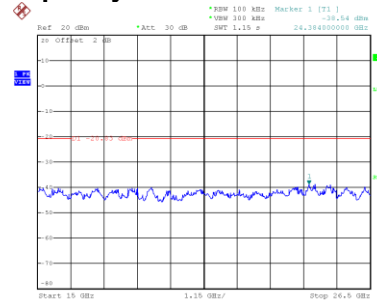

Date: 20.JUN.2020 12:21:31

Test Mode TX N-40M Mode_Ant. 1

Bandedge-CH03

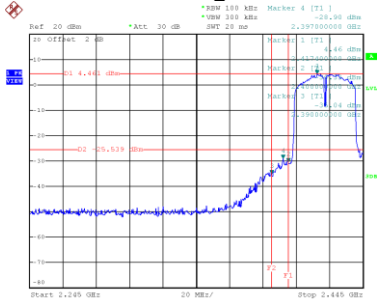

Date: 20.JUN.2020 13:24:49

Bandedge-CH09

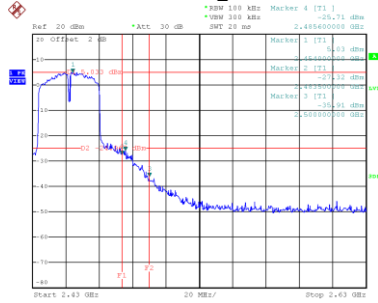

Date: 20.JUN.2020 13:41:04

CH03 – 10th Harmonic of the fundamental frequency

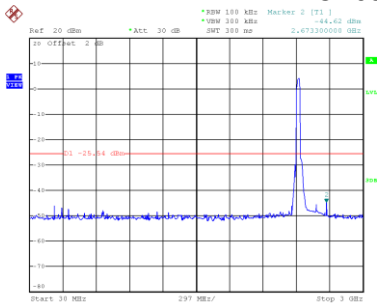

Date: 20.JUN.2020 13:25:02

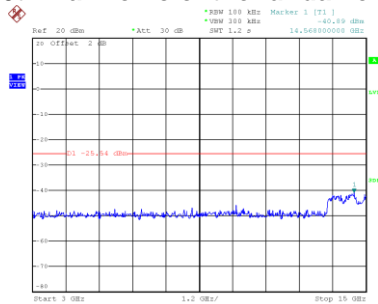

Date: 20.JUN.2020 13:25:09

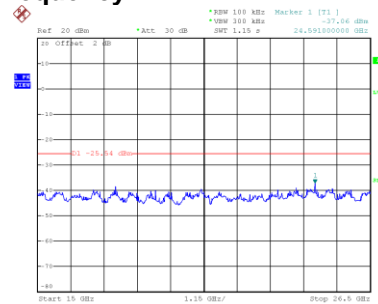

Date: 20.JUN.2020 13:25:16

CH06 – 10th Harmonic of the fundamental frequency

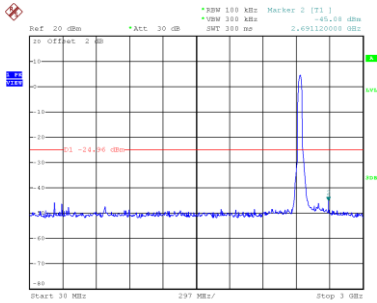

Date: 20.JUN.2020 13:37:58

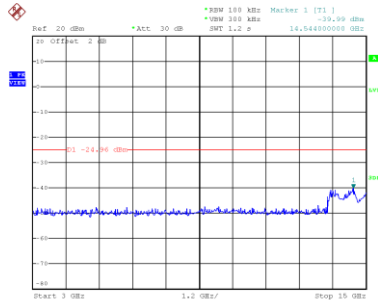

Date: 20.JUN.2020 13:38:05

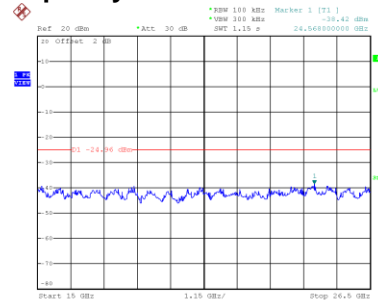

Date: 20.JUN.2020 13:38:12

CH09 – 10th Harmonic of the fundamental frequency

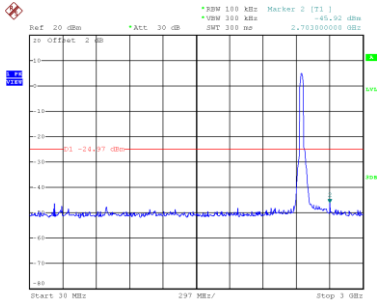

Date: 20.JUN.2020 13:41:17

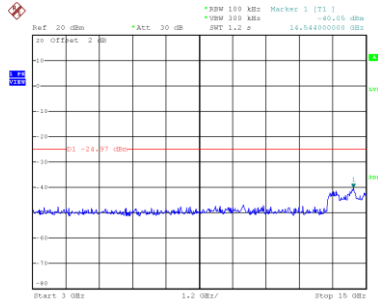

Date: 20.JUN.2020 13:41:24

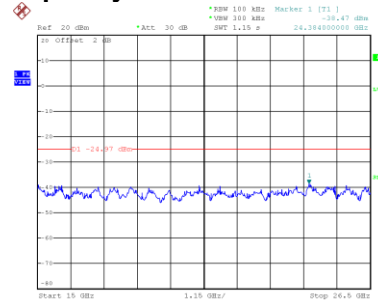

Date: 20.JUN.2020 13:41:31

Test Mode TX N-40M Mode_Ant. 2

Bandedge-CH03

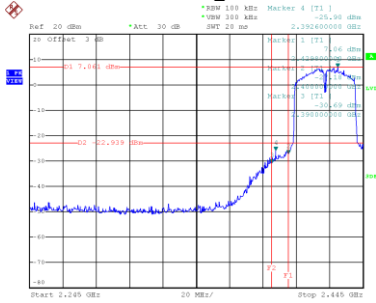

Date: 20.JUN.2020 13:17:01

Bandedge-CH09

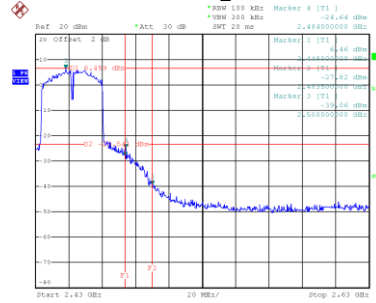

Date: 20.JUN.2020 13:40:03

CH03 – 10th Harmonic of the fundamental frequency

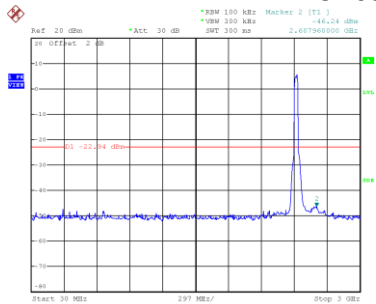

Date: 20.JUN.2020 13:17:14

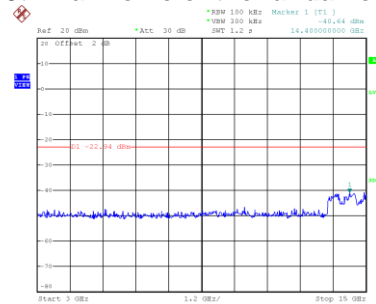

Date: 20.JUN.2020 13:17:22

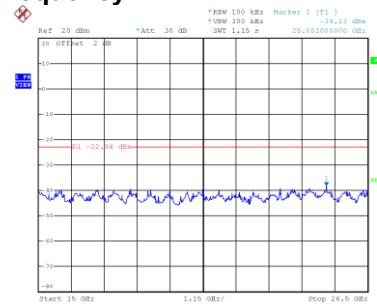

Date: 20.JUN.2020 13:17:29

CH06 – 10th Harmonic of the fundamental frequency

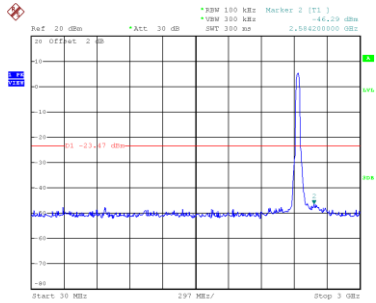

Date: 20.JUN.2020 13:13:05

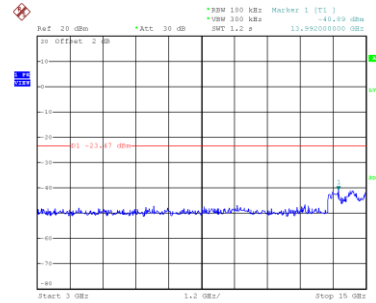

Date: 20.JUN.2020 13:13:12

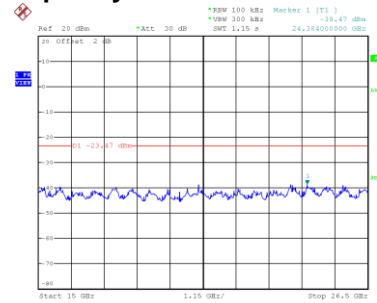

Date: 20.JUN.2020 13:13:19

CH09 – 10th Harmonic of the fundamental frequency

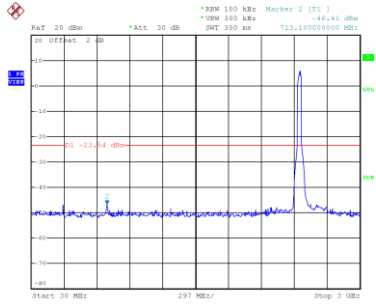

Date: 20.JUN.2020 13:14:16

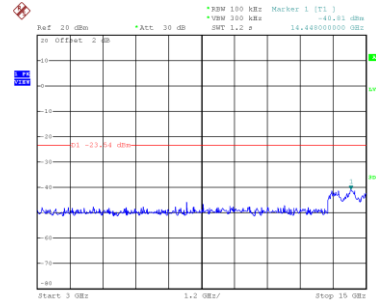

Date: 20.JUN.2020 13:14:23

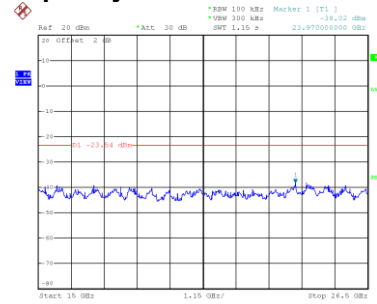

Date: 20.JUN.2020 13:14:30

APPENDIX H - POWER SPECTRAL DENSITY

CDD

Test Mode	TX B Mode
-----------	-----------

Channel	Frequency (MHz)	Power Spectral Density (dBm/3kHz)	Max. Limit (dBm/3kHz)	Result
01	2412	-9.16	8.00	Complies
06	2437	-9.23	8.00	Complies
11	2462	-8.64	8.00	Complies

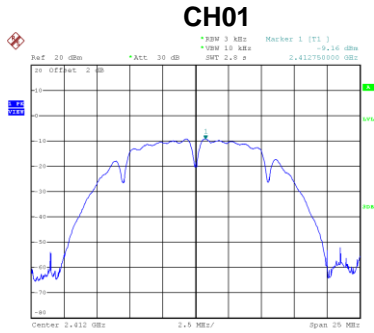

Date: 20_JUN_2020 11:25:00

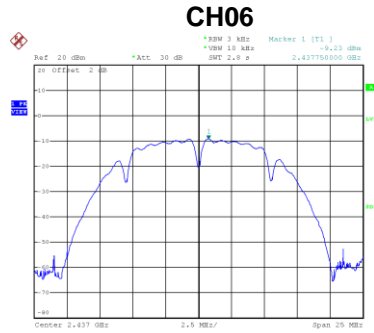

Date: 20_JUN_2020 11:31:56

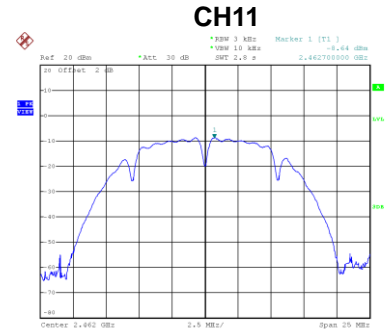

Date: 20_JUN_2020 11:35:00

Test Mode	TX G Mode_Ant. 1
-----------	------------------

Channel	Frequency (MHz)	Power Spectral Density (dBm/3kHz)	Max. Limit (dBm/3kHz)	Result
01	2412	-10.09	5.99	Complies
06	2437	-7.18	5.99	Complies
11	2462	-6.91	5.99	Complies

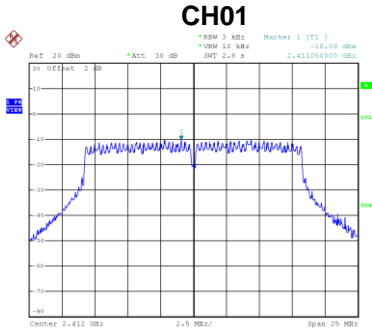

Date: 20_JUN.2020 12:10:129

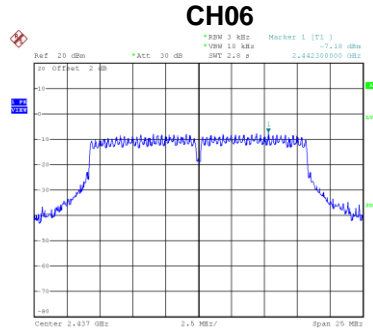

Date: 20_JUN.2020 11:44:125

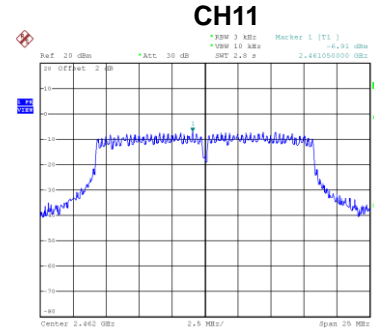

Date: 20_JUN.2020 11:16:150

Test Mode	TX G Mode_Ant. 2
-----------	------------------

Channel	Frequency (MHz)	Power Spectral Density (dBm/3kHz)	Max. Limit (dBm/3kHz)	Result
01	2412	-9.83	5.99	Complies
06	2437	-7.26	5.99	Complies
11	2462	-7.03	5.99	Complies

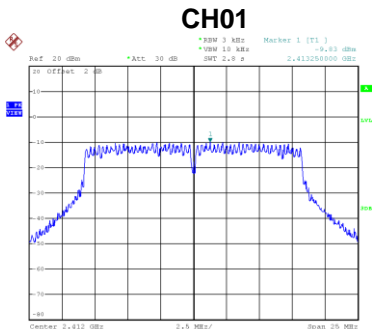

Date: 20_JUN.2020 12:10:153

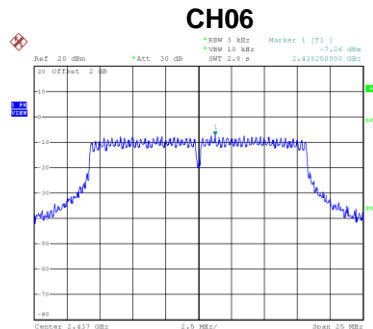

Date: 20_JUN.2020 11:44:150

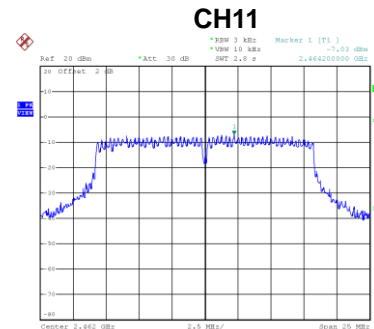

Date: 20_JUN.2020 11:17:140

Test Mode	TX G Mode_Total
-----------	-----------------

Channel	Frequency (MHz)	Power Spectral Density (dBm/3kHz)	Max. Limit (dBm/3kHz)	Result
01	2412	-6.95	5.99	Complies
06	2437	-4.21	5.99	Complies
11	2462	-3.96	5.99	Complies

Test Mode	TX N-20M Mode_Ant. 1
-----------	----------------------

Channel	Frequency (MHz)	Power Spectral Density (dBm/3kHz)	Max. Limit (dBm/3kHz)	Result
01	2412	-7.34	5.99	Complies
06	2437	-6.09	5.99	Complies
11	2462	-5.98	5.99	Complies

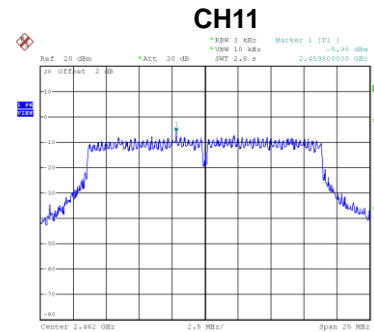
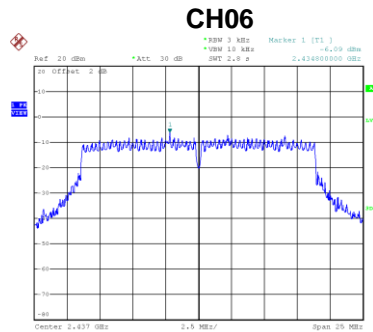
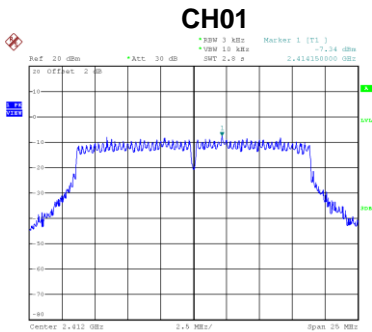

Date: 20_JUN.2020 12:10:25

Date: 20_JUN.2020 12:11:50

Date: 20_JUN.2020 12:11:58

Test Mode	TX N-20M Mode_Ant. 2
-----------	----------------------

Channel	Frequency (MHz)	Power Spectral Density (dBm/3kHz)	Max. Limit (dBm/3kHz)	Result
01	2412	-7.49	5.99	Complies
06	2437	-6.59	5.99	Complies
11	2462	-6.04	5.99	Complies

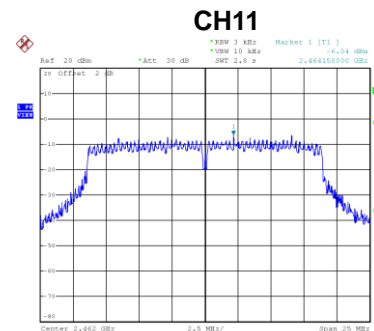
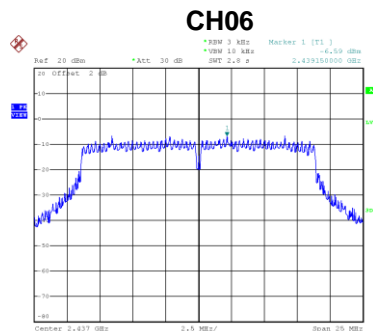
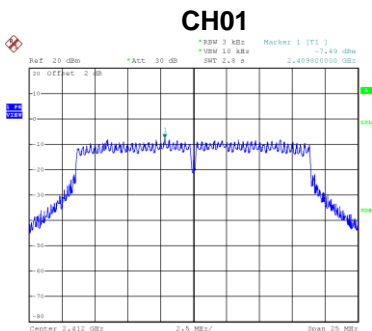

Date: 20_JUN.2020 12:10:01

Date: 20_JUN.2020 12:11:33

Date: 20_JUN.2020 12:10:33

Test Mode	TX N-20M Mode_Total
-----------	---------------------

Channel	Frequency (MHz)	Power Spectral Density (dBm/3kHz)	Max. Limit (dBm/3kHz)	Result
01	2412	-4.40	5.99	Complies
06	2437	-3.32	5.99	Complies
11	2462	-3.00	5.99	Complies

Test Mode	TX N-40M Mode_Ant. 1
-----------	----------------------

Channel	Frequency (MHz)	Power Spectral Density (dBm/3kHz)	Max. Limit (dBm/3kHz)	Result
03	2422	-7.17	5.99	Complies
06	2437	-8.24	5.99	Complies
09	2452	-8.29	5.99	Complies

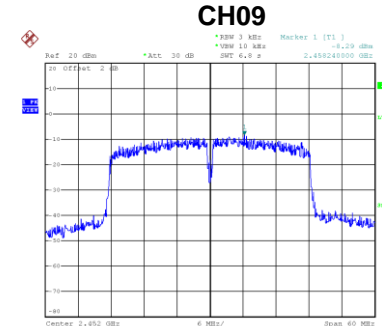
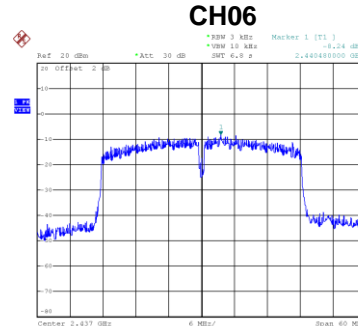
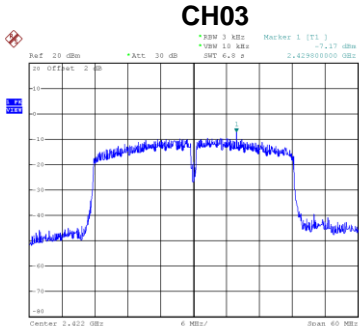

Date: 20_JUN.2020 13:12:110

Date: 20_JUN.2020 13:13:110

Date: 20_JUN.2020 13:14:130

Test Mode	TX N-40M Mode_Ant. 2
-----------	----------------------

Channel	Frequency (MHz)	Power Spectral Density (dBm/3kHz)	Max. Limit (dBm/3kHz)	Result
03	2422	-8.77	5.99	Complies
06	2437	-7.43	5.99	Complies
09	2452	-9.07	5.99	Complies

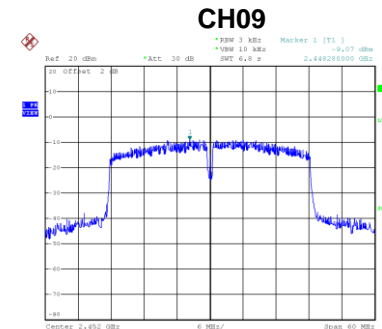
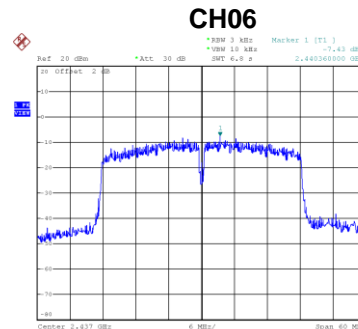
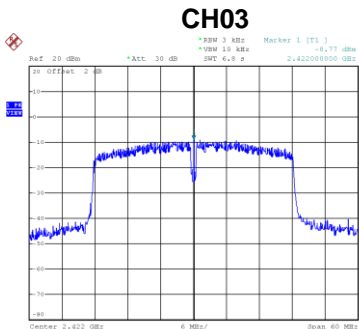

Date: 20_JUN.2020 13:12:102

Date: 20_JUN.2020 13:13:151

Date: 20_JUN.2020 13:14:122

Test Mode	TX N-40M Mode_Total
-----------	---------------------

Channel	Frequency (MHz)	Power Spectral Density (dBm/3kHz)	Max. Limit (dBm/3kHz)	Result
03	2422	-4.89	5.99	Complies
06	2437	-4.81	5.99	Complies
09	2452	-5.65	5.99	Complies

End of Test Report