



A D T

FCC TEST REPORT

REPORT NO.: RF990430E04

MODEL NO.: DIR-600

RECEIVED: Apr. 30, 2010

TESTED: May 05 to 10, 2010

ISSUED: June 21, 2010

APPLICANT: D-Link Corporation

ADDRESS: No.289, Sinhu 3rd Rd., Neihu District, Taipei City
114, Taiwan, R.O.C.

ISSUED BY: Bureau Veritas Consumer Products Services (H.K.)
Ltd., Taoyuan Branch Hsin Chu Laboratory

LAB LOCATION (1): No. 81-1, Lu Liao Keng, 9th Ling,Wu Lung Tsuen,
Chiung Lin Hsiang, Hsin Chu Hsien 307, Taiwan

LAB LOCATION (2): No.49, Ln. 206, Wende Rd., Shangshan Tsuen,
Chiung Lin Hsiang, Hsin Chu Hsien 307, Taiwan

This test report consists of 79 pages in total. It may be duplicated completely for legal use with the approval of the applicant. It should not be reproduced except in full, without the written approval of our laboratory. The client should not use it to claim product endorsement by any government agencies. The test results in the report only apply to the tested sample.



A D T

Table of Contents

1.	CERTIFICATION	4
2.	SUMMARY OF TEST RESULTS	5
2.1	MEASUREMENT UNCERTAINTY	6
3.	GENERAL INFORMATION	7
3.1	GENERAL DESCRIPTION OF EUT	7
3.2	DESCRIPTION OF TEST MODES	9
3.2.1	TEST MODE APPLICABILITY AND TESTED CHANNEL DETAIL	10
3.3	GENERAL DESCRIPTION OF APPLIED STANDARDS	12
3.4	DESCRIPTION OF SUPPORT UNITS.....	13
3.5	CONFIGURATION OF SYSTEM UNDER TEST	15
4.	TEST TYPES AND RESULTS	17
4.1	CONDUCTED EMISSION MEASUREMENT	17
4.1.1	LIMITS OF CONDUCTED EMISSION MEASUREMENT	17
4.1.2	TEST INSTRUMENTS.....	17
4.1.3	TEST PROCEDURES	18
4.1.4	DEVIATION FROM TEST STANDARD	18
4.1.5	TEST SETUP	19
4.1.6	EUT OPERATING CONDITIONS	19
4.1.7	TEST RESULTS	20
4.2	RADIATED EMISSION MEASUREMENT	22
4.2.1	LIMITS OF RADIATED EMISSION MEASUREMENT	22
4.2.2	TEST INSTRUMENTS.....	23
4.2.3	TEST PROCEDURES	25
4.2.4	DEVIATION FROM TEST STANDARD	25
4.2.5	TEST SETUP	26
4.2.6	EUT OPERATING CONDITIONS	26
4.2.7	TEST RESULTS	27
4.3	6dB BANDWIDTH MEASUREMENT	56
4.3.1	LIMITS OF 6dB BANDWIDTH MEASUREMENT	56
4.3.2	TEST INSTRUMENTS.....	56
4.3.3	TEST PROCEDURE.....	56
4.3.4	DEVIATION FROM TEST STANDARD	56
4.3.5	TEST SETUP	56
4.3.6	EUT OPERATING CONDITIONS	56
4.3.7	TEST RESULTS	57
4.4	MAXIMUM PEAK OUTPUT POWER	61
4.4.1	LIMITS OF MAXIMUM PEAK OUTPUT POWER MEASUREMENT	61
4.4.2	INSTRUMENTS.....	61
4.4.3	TEST PROCEDURES	61
4.4.4	DEVIATION FROM TEST STANDARD	61



A D T

4.4.5	TEST SETUP	61
4.4.6	EUT OPERATING CONDITIONS	61
4.4.7	TEST RESULTS	62
4.5	POWER SPECTRAL DENSITY MEASUREMENT.....	64
4.5.1	LIMITS OF POWER SPECTRAL DENSITY MEASUREMENT	64
4.5.2	TEST INSTRUMENTS.....	64
4.5.3	TEST PROCEDURE.....	64
4.5.4	DEVIATION FROM TEST STANDARD	64
4.5.5	TEST SETUP	64
4.5.6	EUT OPERATING CONDITION.....	64
4.5.7	TEST RESULTS	65
4.6	CONDUCTED OUT-BAND EMISSION MEASUREMENT.....	69
4.6.1	LIMITS OF CONDUCTED OUT-BAND EMISSION MEASUREMENT.....	69
4.6.2	TEST INSTRUMENTS.....	69
4.6.3	TEST PROCEDURE.....	69
4.6.4	DEVIATION FROM TEST STANDARD	69
4.6.5	EUT OPERATING CONDITION.....	69
4.6.6	TEST RESULTS	69
5.	INFORMATION ON THE TESTING LABORATORIES	78
6.	APPENDIX A - MODIFICATIONS RECORDERS FOR ENGINEERING CHANGES TO THE EUT BY THE LAB.....	79



1. CERTIFICATION

PRODUCT: WIRELESS N 150 HOME ROUTER
BRAND NAME: D-Link
MODEL NO.: DIR-600
TEST SAMPLE: MASS-PRODUCTION
TESTED: May 05 to 10, 2010
APPLICANT: D-Link Corporation
STANDARDS: FCC Part 15, Subpart C (Section 15.247)
ANSI C63.4-2003

The above equipment (Model: DIR-600) has been tested by **Bureau Veritas Consumer Products Services (H.K.) Ltd., Taoyuan Branch**, and found compliance with the requirement of the above standards. The test record, data evaluation & Equipment Under Test (EUT) configurations represented herein are true and accurate accounts of the measurements of the sample's EMC characteristics under the conditions specified in this report.

PREPARED BY :  , **DATE:** June 21, 2010
(Claire Kuan, Specialist)

TECHNICAL ACCEPTANCE :  , **DATE:** June 21, 2010
(Hank Chung, Deputy Manager)

APPROVED BY :  , **DATE:** June 21, 2010
(May Chen, Deputy Manager)



A D T

2. SUMMARY OF TEST RESULTS

The EUT has been tested according to the following specifications:

APPLIED STANDARD: FCC Part 15, Subpart C			
Standard Section	Test Type and Limit	Result	Remark
15.207	AC Power Conducted Emission	PASS	Meet the requirement of limit. Minimum passing margin is -5.66dB at 2.629MHz
15.247(a)(2)	Spectrum Bandwidth of a Direct Sequence Spread Spectrum System Limit: min. 500kHz	PASS	Meet the requirement of limit.
15.247(b)	Maximum Peak Output Power Limit: max. 30dBm	PASS	Meet the requirement of limit.
15.247(d)	Radiated Emissions Limit: Table 15.209	PASS	Meet the requirement of limit. Minimum passing margin is -0.5dB at 4924.00MHz
15.247(e)	Power Spectral Density Limit: max. 8dBm	PASS	Meet the requirement of limit.
15.247(d)	Conducted Out-Band Emission Measurement Limit: 20dB less than the peak value of fundamental frequency	PASS	Meet the requirement of limit.
15.203	Antenna Requirement	PASS	Antenna connector is SMA Straight Plug Reverse not a standard connector.



A D T

2.1 MEASUREMENT UNCERTAINTY

Where relevant, the following measurement uncertainty levels have been estimated for tests performed on the EUT as specified in CISPR 16-4-2:

This uncertainty represents an expanded uncertainty expressed at approximately the 95% confidence level using a coverage factor of $k=2$.

Measurement	Value
Conducted emissions	2.45 dB
Radiated emissions (30MHz-1GHz)	3.30 dB
Radiated emissions (1GHz -18GHz)	2.19 dB
Radiated emissions (18GHz -40GHz)	2.55 dB



A D T

3. GENERAL INFORMATION

3.1 GENERAL DESCRIPTION OF EUT

PRODUCT	WIRELESS N 150 HOME ROUTER
MODEL NO.	DIR-600
FCC ID	KA2DIR600C2
POWER SUPPLY	DC 5V from power adapter
MODULATION TYPE	CCK, DQPSK, DBPSK for DSSS 64QAM, 16QAM, QPSK, BPSK for OFDM
MODULATION TECHNOLOGY	DSSS, OFDM
TRANSFER RATE	802.11b:11/5.5/2/1Mbps 802.11g: 54/48/36/24/18/12/9/6Mbps HT20 MCS0~7 (800ns GI): 6.5Mbps, 13Mbps, 19.5Mbps, 26Mbps, 39Mbps, 52Mbps, 58.5Mbps, 65Mbps HT40 MCS0~7 (800ns GI): 13.5Mbps, 27Mbps, 40.5Mbps, 54Mbps, 81Mbps, 108Mbps, 121.5Mbps, 135Mbps HT20 MCS0~7 (400ns GI): 7.2Mbps, 14.4Mbps, 21.7Mbps, 28.9Mbps, 43.3Mbps, 57.8Mbps, 65.0Mbps, 72.2Mbps HT40 MCS0~7 (400ns GI): 15.0Mbps, 30.0Mbps, 45.0Mbps, 60.0Mbps, 90.0Mbps, 120.0Mbps, 135.0Mbps, 150.0Mbps
OPERATING FREQUENCY	2412MHz ~ 2462MHz
NUMBER OF CHANNEL	11 for 802.11b, 802.11g, 802.11n (20MHz) 7 for 802.11n (40MHz)
MAXIMUM OUTPUT POWER	802.11b: 131.8mW 802.11g: 478.6mW 802.11n (20MHz): 478.6mW 802.11n (40MHz): 446.7mW
ANTENNA TYPE	Please see note 1
DATA CABLE	Ethernet cable (Unshielded, 1.5m)
I/O PORTS	LAN port x 4 Internet port x 1
ASSOCIATED DEVICES	Adapter x 1

NOTE:

1. There is one antenna provided to this EUT, please refer to the following table:

Manufacture	Model name	Antenna Type	Antenna Connector	Antenna Gain (dBi)
WHA YU GROUP	C037-511078-A (SSR-211352)	Dipole	SMA Straight Plug Reverse	3.5

2. The EUT must be supplied with a power adapter as following information:

Brand:	AMIGO
Model No.:	AMS47-0501000FU
Input power :	AC100-240V, 0.2A, 50/60Hz
Output power :	DC 5V, 1.0A DC output cable (Unshielded, 1.5m)

3. The EUT incorporates a SISO function with 802.11b, 802.11g, 802.11n. Physically, the EUT provides one completed transmitter and one receiver.
4. The EUT is 1 * 1 spatial SISO without beam forming function. The antenna configuration is one transmitter antenna and one receiver antenna, as there is 1 Dipole antenna.
5. The EUT complies with 802.11n standards and backwards compatible with 802.11b, 802.11g products.
6. The EUT, operates in the 2.4GHz frequency range, lets you connect IEEE 802.11g or IEEE 802.11b and 802.11n technique devices to the network.
7. The above EUT information was declared by the manufacturer and for more detailed features description, please refer to the manufacturer's specifications or User's Manual.



A D T

3.2 DESCRIPTION OF TEST MODES

Eleven channels are provided for 802.11b, 802.11g, 802.11n (20MHz):

CHANNEL	FREQUENCY	CHANNEL	FREQUENCY
1	2412MHz	7	2442MHz
2	2417MHz	8	2447MHz
3	2422MHz	9	2452MHz
4	2427MHz	10	2457MHz
5	2432MHz	11	2462MHz
6	2437MHz		

Seven channels are provided for 802.11n (40MHz):

CHANNEL	FREQUENCY	CHANNEL	FREQUENCY
1	2422MHz	5	2442MHz
2	2427MHz	6	2447MHz
3	2432MHz	7	2452MHz
4	2437MHz		

3.2.1 TEST MODE APPLICABILITY AND TESTED CHANNEL DETAIL

EUT CONFIGURE MODE	APPLICABLE TO				DESCRIPTION
	PLC	RE < 1G	RE ≥ 1G	APCM	
-	√	√	√	√	-

Where **PLC**: Power Line Conducted Emission **RE < 1G**: Radiated Emission below 1GHz
RE ≥ 1G: Radiated Emission above 1GHz **APCM**: Antenna Port Conducted Measurement

POWER LINE CONDUCTED EMISSION TEST:

Pre-Scan has been conducted to determine the worst-case mode from all possible combinations between available modulations, data rates and antenna ports (if EUT with antenna diversity architecture).

Following channel(s) was (were) selected for the final test as listed below.

MODE	AVAILABLE CHANNEL	TESTED CHANNEL	MODULATION TECHNOLOGY	MODULATION TYPE	DATA RATE (Mbps)
802.11g	1 to 11	6	OFDM	BPSK	6

RADIATED EMISSION TEST (BELOW 1 GHz):

Pre-Scan has been conducted to determine the worst-case mode from all possible combinations between available modulations, data rates and antenna ports (if EUT with antenna diversity architecture).

Following channel(s) was (were) selected for the final test as listed below.

MODE	AVAILABLE CHANNEL	TESTED CHANNEL	MODULATION TECHNOLOGY	MODULATION TYPE	DATA RATE (Mbps)
802.11g	1 to 11	6	OFDM	BPSK	6

RADIATED EMISSION TEST (ABOVE 1 GHz):

Pre-Scan has been conducted to determine the worst-case mode from all possible combinations between available modulations, data rates and antenna ports (if EUT with antenna diversity architecture).

Following channel(s) was (were) selected for the final test as listed below.

MODE	AVAILABLE CHANNEL	TESTED CHANNEL	MODULATION TECHNOLOGY	MODULATION TYPE	DATA RATE (Mbps)
802.11b	1 to 11	1, 6, 11	DSSS	DBPSK	1
802.11g	1 to 11	1, 6, 11	OFDM	BPSK	6
802.11n (20MHz)	1 to 11	1, 6, 11	OFDM	BPSK	6.5
802.11n (40MHz)	1 to 7	1, 4, 7	OFDM	BPSK	13.5



CONDUCTED OUT-BAND EMISSION MEASUREMENT:

- Pre-Scan has been conducted to determine the worst-case mode from all possible combinations between available modulations, data rates and antenna ports (if EUT with antenna diversity architecture).
- Following channel(s) was (were) selected for the final test as listed below.

MODE	AVAILABLE CHANNEL	TESTED CHANNEL	MODULATION TECHNOLOGY	MODULATION TYPE	DATA RATE (Mbps)
802.11b	1 to 11	1, 11	DSSS	DBPSK	1
802.11g	1 to 11	1, 11	OFDM	BPSK	6
802.11n (20MHz)	1 to 11	1, 11	OFDM	BPSK	6.5
802.11n (40MHz)	1 to 7	1, 7	OFDM	BPSK	13.5

ANTENNA PORT CONDUCTED MEASUREMENT:

- This item includes all test value of each mode, but only includes spectrum plot of worst value of each mode.
- Pre-Scan has been conducted to determine the worst-case mode from all possible combinations between available modulations, data rates and antenna ports (if EUT with antenna diversity architecture).
- Following channel(s) was (were) selected for the final test as listed below.

MODE	AVAILABLE CHANNEL	TESTED CHANNEL	MODULATION TECHNOLOGY	MODULATION TYPE	DATA RATE (Mbps)
802.11b	1 to 11	1, 6, 11	DSSS	DBPSK	1
802.11g	1 to 11	1, 6, 11	OFDM	BPSK	6
802.11n (20MHz)	1 to 11	1, 6, 11	OFDM	BPSK	6.5
802.11n (40MHz)	1 to 7	1, 4, 7	OFDM	BPSK	13.5

※ TEST CONDITION:

APPLICABLE TO	ENVIRONMENTAL CONDITIONS	INPUT POWER (SYSTEM)	TESTED BY
RE ³ 1G	23deg. C, 68%RH, 1012 hPa	120Vac, 60Hz	Duke Tseng
RE<1G	23deg. C, 73%RH, 1012 hPa	120Vac, 60Hz	Eric Lee
PLC	28deg. C, 70%RH, 1012 hPa	120Vac, 60Hz	Leo Peng
APCM	25deg. C, 60%RH, 1012 hPa	120Vac, 60Hz	Rex Huang

3.3 GENERAL DESCRIPTION OF APPLIED STANDARDS

The EUT is a RF product. According to the specifications of the manufacturer, it must comply with the requirements of the following standards:

FCC Part 15, Subpart C. (15.247)

ANSI C63.4-2003

All test items have been performed and recorded as per the above standards.

NOTE: The EUT has been verified to comply with the requirements of FCC Part 15, Subpart B, Class B (DoC). The test report has been issued separately.



A D T

3.4 DESCRIPTION OF SUPPORT UNITS

The EUT has been tested as an independent unit together with other necessary accessories or support units. The following support units or accessories were used to form a representative test configuration during the tests.

For Conducted test					
NO.	PRODUCT	BRAND	MODEL NO.	SERIAL NO.	FCC ID
1	PERSONAL COMPUTER	DELL	DCSM	294QL1S	FCC DoC
2	MONITOR	DELL	E2210Hc	CN-OG337R-6418 0-97S-OQFS	FCC DoC
3	KEYBOARD	DELL	SK-8115	MY-0DJ325-71619- 99B-0479	FCC DoC
4	MOUSE	DELL	MOC5UO	I1401ML5	FCC DoC
5	SWITCH	HP	J9086A	CN737ZQ00S	NA
6	SWITCH	HP	J9086A	CN737ZQ00S	NA
7	NOTEBOOK COMPUTER	DELL	D531	CN-0XM006-48643 -86L-4472	QDS-BRCM1019

For Conducted test	
NO.	SIGNAL CABLE DESCRIPTION OF THE ABOVE SUPPORT UNITS
1	UTP Cable (3m)
2	1.8 m braid shielded wire, VGA connector, with two cores.
3	1.8 m foil shielded wire, USB Connector, , w/o core
4	1.5 m foil shielded wire, USB Connector, w/o core.
5	UTP Cable (10m)
6	UTP Cable (10m)
7	NA

NOTE: 1. All power cords of the above support units are non shielded (1.8m).



A D T

For other test					
NO.	PRODUCT	BRAND	MODEL NO.	SERIAL NO.	FCC ID
1	NOTEBOOK COMPUTER	DELL	PP32LA	FSLB32S	FCC DoC
2	NOTEBOOK COMPUTER	DELL	PP32LA	GSLB32S	FCC DoC
3	HUB	ZyXEL	ES-116P	S060H02000215	FCC DoC

For other test	
NO.	SIGNAL CABLE DESCRIPTION OF THE ABOVE SUPPORT UNITS
1	UTP Cable (10m)
2	UTP Cable (10m)
3	UTP Cable (10m)

NOTE: 1. All power cords of the above support units are non shielded (1.8m).

3.5 CONFIGURATION OF SYSTEM UNDER TEST

For conducted test:

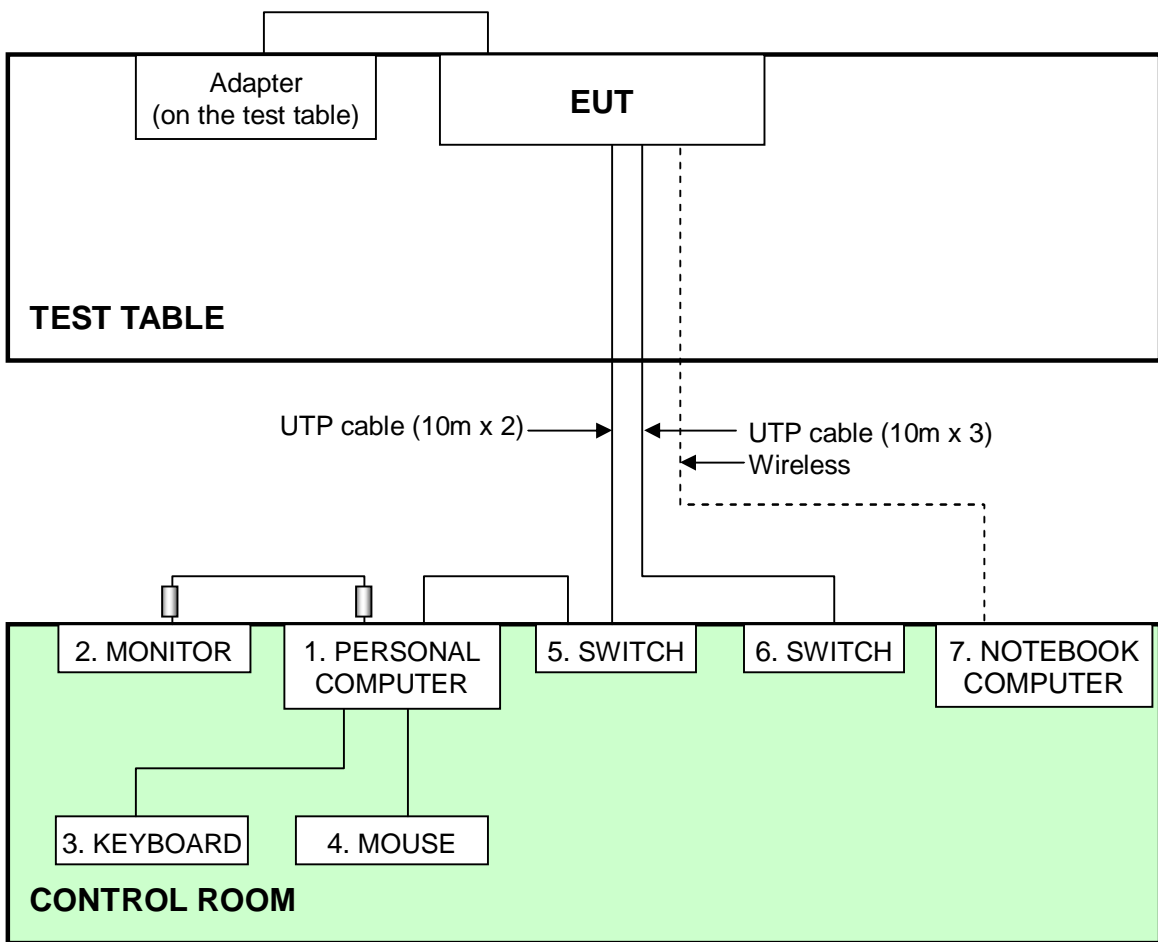

For other test:

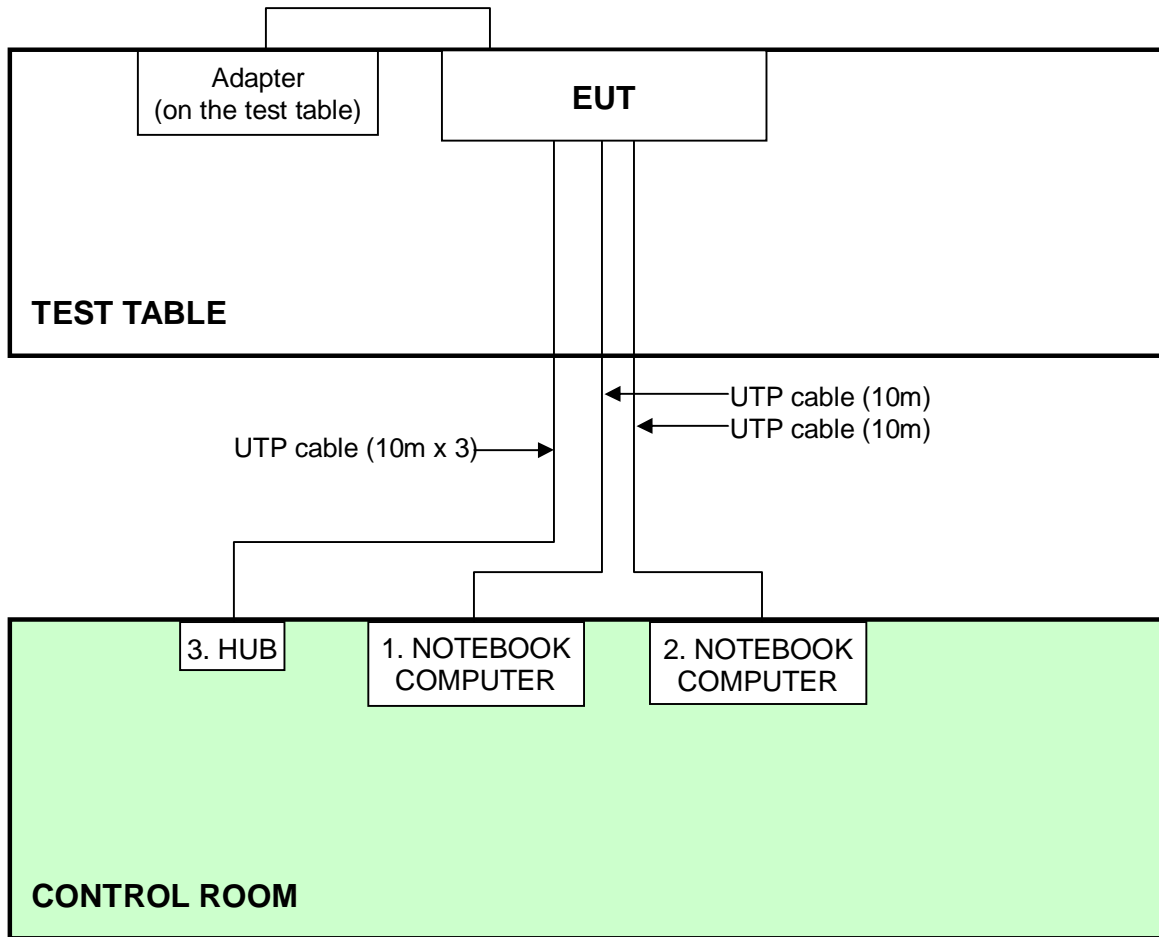

4. TEST TYPES AND RESULTS

4.1 CONDUCTED EMISSION MEASUREMENT

4.1.1 LIMITS OF CONDUCTED EMISSION MEASUREMENT

FREQUENCY OF EMISSION (MHz)	CONDUCTED LIMIT (dB μ V)	
0.15-0.5	Quasi-peak	Average
0.5-5	66 to 56	56 to 46
5-30	56	46
	60	50

- NOTE:**
1. The lower limit shall apply at the transition frequencies.
 2. The limit decreases in line with the logarithm of the frequency in the range of 0.15 to 0.50 MHz.
 3. All emanations from a class A/B digital device or system, including any network of conductors and apparatus connected thereto, shall not exceed the level of field strengths specified above.

4.1.2 TEST INSTRUMENTS

DESCRIPTION & MANUFACTURER	MODEL NO.	SERIAL NO.	CALIBRATED DATE	CALIBRATED UNTIL
ROHDE & SCHWARZ Test Receiver	ESCS 30	100287	Mar. 01, 2010	Feb. 28, 2011
Line-Impedance Stabilization Network (for EUT)	NSLK 8127	8127-523	Sep. 23, 2009	Sep. 22, 2010
Line-Impedance Stabilization Network (for Peripheral)	ENV-216	100072	June 08, 2009	June 07, 2010
RF Cable (JYBAO)	5DFB	COACAB-001	Dec. 14, 2009	Dec. 13, 2010
50 ohms Terminator	50	3	Oct. 28, 2009	Oct. 27, 2010
Software	BV ADT_ Cond_V7.3.7	NA	NA	NA

Note:

1. The calibration interval of the above test instruments is 12 months and the calibrations are traceable to NML/ROC and NIST/USA.
2. The test was performed in Shielded Room No. A.
3. The VCCI Con A Registration No. is C-817.

4.1.3 TEST PROCEDURES

- a. The EUT was placed 0.4 meters from the conducting wall of the shielded room with EUT being connected to the power mains through a line impedance stabilization network (LISN). Other support units were connected to the power mains through another LISN. The two LISNs provide 50 ohm/ 50uH of coupling impedance for the measuring instrument.
- b. Both lines of the power mains connected to the EUT were checked for maximum conducted interference.
- c. The frequency range from 150kHz to 30MHz was searched. Emission levels under (Limit - 20dB) were not recorded.

4.1.4 DEVIATION FROM TEST STANDARD

No deviation

4.1.5 TEST SETUP

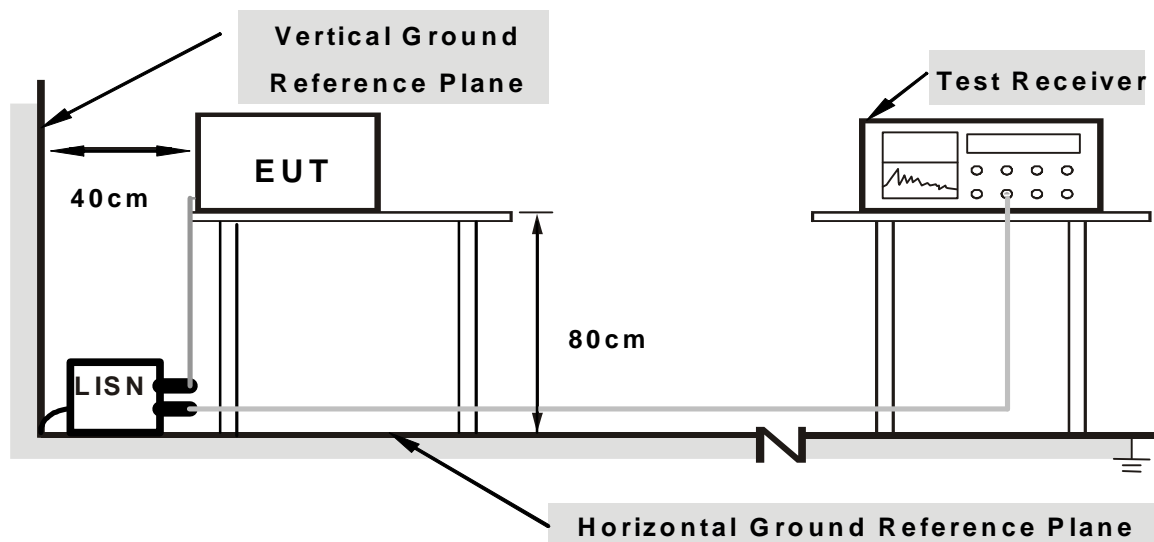

Note: 1. Support units were connected to second LISN.

2. Both of LISNs (AMN) are 80 cm from EUT and at least 80 from other units and other metal planes

For the actual test configuration, please refer to the related item – Photographs of the Test Configuration.

4.1.6 EUT OPERATING CONDITIONS

1. Placed the EUT on testing table.
2. Prepared other computer systems (support units 1 and 7) to act as communication partners and placed them outside of testing area.
3. The communication partners ran test programs “Ping.exe” and “WinTG” to enable EUT under transmission/receiving condition continuously via UTP cables and wireless.

4.1.7 TEST RESULTS

802.11g OFDM MODULATION:

PHASE	Line (L)	6dB BANDWIDTH	9 kHz
--------------	----------	----------------------	-------

No	Freq. [MHz]	Corr. Factor (dB)	Reading Value [dB (uV)]		Emission Level [dB (uV)]		Limit [dB (uV)]		Margin (dB)	
			Q.P.	AV.	Q.P.	AV.	Q.P.	AV.	Q.P.	AV.
1	0.423	0.06	44.49	35.22	44.55	35.28	57.38	47.38	-12.83	-12.10
2	0.560	0.09	41.48	32.33	41.57	32.42	56.00	46.00	-14.43	-13.58
3	0.627	0.11	45.73	35.79	45.84	35.90	56.00	46.00	-10.16	-10.10
4	0.845	0.17	42.85	33.59	43.02	33.76	56.00	46.00	-12.98	-12.24
5	0.978	0.20	40.87	31.84	41.07	32.04	56.00	46.00	-14.93	-13.96
6	1.867	0.23	45.32	36.29	45.55	36.52	56.00	46.00	-10.45	-9.48
7	2.629	0.22	49.78	40.12	50.00	40.34	56.00	46.00	-6.00	-5.66
8	3.539	0.20	42.96	34.12	43.16	34.32	56.00	46.00	-12.84	-11.68
9	4.621	0.23	42.43	33.66	42.66	33.89	56.00	46.00	-13.34	-12.11
10	7.359	0.41	43.53	36.29	43.94	36.70	60.00	50.00	-16.06	-13.30

- REMARKS:**
1. Q.P. and AV. are abbreviations of quasi-peak and average individually.
 2. "-": The Quasi-peak reading value also meets average limit and measurement with the average detector is unnecessary.
 3. The emission levels of other frequencies were very low against the limit.
 4. Margin value = Emission level - Limit value
 5. Correction factor = Insertion loss + Cable loss
 6. Emission Level = Correction Factor + Reading Value.

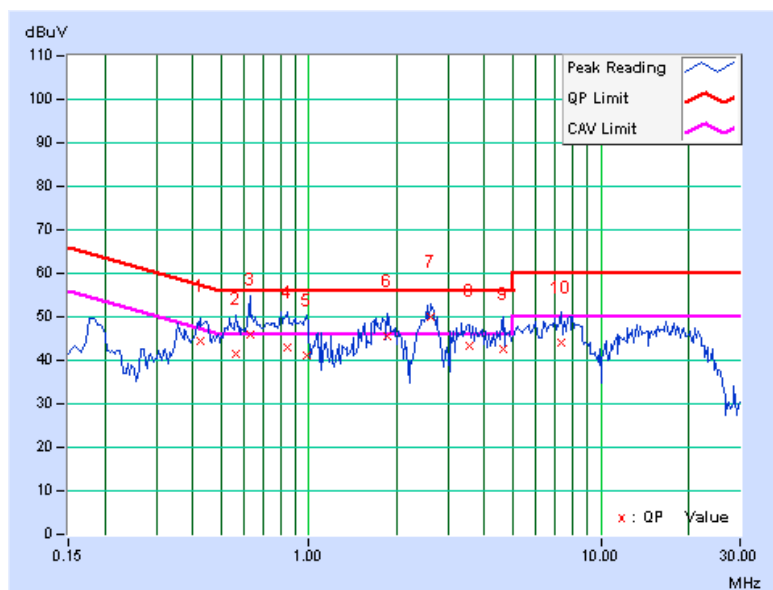

PHASE	Neutral (N)	6dB BANDWIDTH	9 kHz
--------------	-------------	----------------------	-------

No	Freq. [MHz]	Corr. Factor (dB)	Reading Value		Emission Level		Limit		Margin	
			[dB (uV)]		[dB (uV)]		[dB (uV)]		(dB)	
			Q.P.	AV.	Q.P.	AV.	Q.P.	AV.	Q.P.	AV.
1	0.423	0.07	43.64	34.67	43.71	34.74	57.38	47.38	-13.67	-12.64
2	0.451	0.07	41.18	32.90	41.25	32.97	56.86	46.86	-15.61	-13.89
3	0.673	0.13	42.16	33.75	42.29	33.88	56.00	46.00	-13.71	-12.12
4	0.896	0.19	41.74	33.39	41.93	33.58	56.00	46.00	-14.07	-12.42
5	1.453	0.23	40.15	32.05	40.38	32.28	56.00	46.00	-15.62	-13.72
6	1.703	0.23	42.68	35.21	42.91	35.44	56.00	46.00	-13.09	-10.56
7	2.543	0.23	46.56	39.28	46.79	39.51	56.00	46.00	-9.21	-6.49
8	3.281	0.22	41.04	33.42	41.26	33.64	56.00	46.00	-14.74	-12.36
9	7.270	0.42	43.26	34.99	43.68	35.41	60.00	50.00	-16.32	-14.59
10	17.637	0.54	42.90	33.94	43.44	34.48	60.00	50.00	-16.56	-15.52

- REMARKS:**
1. Q.P. and AV. are abbreviations of quasi-peak and average individually.
 2. "-": The Quasi-peak reading value also meets average limit and measurement with the average detector is unnecessary.
 3. The emission levels of other frequencies were very low against the limit.
 4. Margin value = Emission level - Limit value
 5. Correction factor = Insertion loss + Cable loss
 6. Emission Level = Correction Factor + Reading Value.

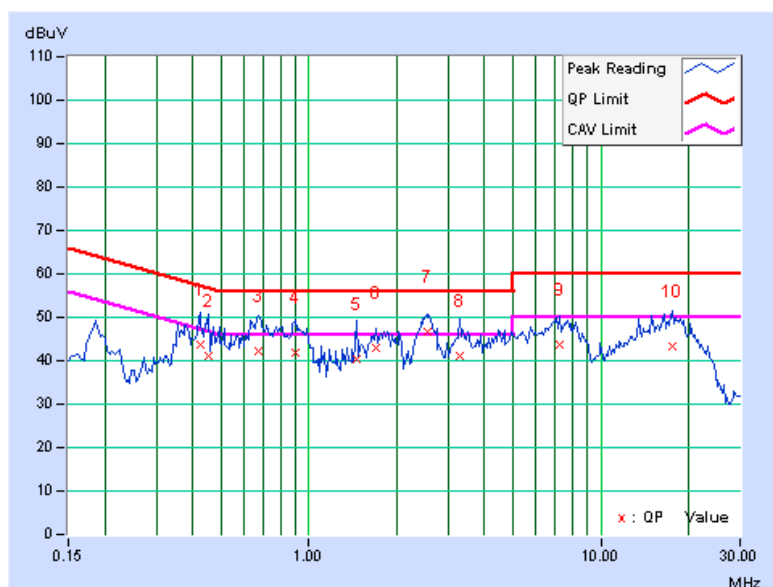

4.2 RADIATED EMISSION MEASUREMENT

4.2.1 LIMITS OF RADIATED EMISSION MEASUREMENT

Emissions radiated outside of the specified bands, shall be according to the general radiated limits in 15.209 as following:

Frequencies (MHz)	Field strength (microvolts/meter)	Measurement distance (meters)
0.009-0.490	2400/F(kHz)	300
0.490-1.705	24000/F(kHz)	30
1.705-30.0	30	30
30-88	100	3
88-216	150	3
216-960	200	3
Above 960	500	3

NOTE:

1. The lower limit shall apply at the transition frequencies.
2. Emission level (dBuV/m) = 20 log Emission level (uV/m).
3. As shown in 15.35(b), for frequencies above 1000MHz, the field strength limits are based on average detector, however, the peak field strength of any emission shall not exceed the maximum permitted average limits, specified above by more than 20dB under any condition of modulation.



A D T

4.2.2 TEST INSTRUMENTS

For below 1GHz test:

DESCRIPTION & MANUFACTURER	MODEL NO.	SERIAL NO.	CALIBRATED DATE	CALIBRATED UNTIL
Agilent Spectrum Analyzer	E4446A	MY48250253	Aug. 03, 2009	Aug. 02, 2010
Agilent Pre-Selector	N9039A	MY46520311	Aug. 17, 2009	Aug. 16, 2010
Agilent Signal Generator	N5181A	MY49060517	July 20, 2009	July 19, 2010
Mini-Circuits Pre-Amplifier	ZFL-1000VH2B	AMP-ZFL-03	Nov. 18, 2009	Nov. 17, 2010
Agilent Pre-Amplifier	8449B	3008A02578	July 06, 2009	July 05, 2010
Miteq Pre-Amplifier	AFS33-1800265 0-30-8P-44	881786	NA	NA
SCHWARZBECK Trilog Broadband Antenna	VULB 9168	9168-360	Sep. 30, 2009	Sep. 29, 2010
AISI Horn_Antenna	AIH.8018	0000320091110	Nov. 16, 2009	Nov. 15, 2010
SCHWARZBECK Horn_Antenna	BBHA 9170	9170-424	Sep. 30, 2009	Sep. 29, 2010
RF CABLE	NA	RF104-201 RF104-203 RF104-204	Dec. 24, 2009	Dec. 23, 2010
RF Cable	NA	CHGCAB_001	NA	NA
Software	ADT_Radiated_ V8.7.06	NA	NA	NA
CT Antenna Tower & Turn Table	NA	NA	NA	NA

Note: 1. The calibration interval of the above test instruments is 12 months and the calibrations are traceable to NML/ROC and NIST/USA.

2. The horn antenna, preamplifier (model: 8449B) are used only for the measurement of emission frequency above 1GHz if tested.

3. The test was performed in 966 Chamber No. G.

4. The FCC Site Registration No. is 656396.

5. The VCCI Site Registration No. is R-1626.

6. The CANADA Site Registration No. is IC 7450G-3.



A D T

For above 1GHz test:

DESCRIPTION & MANUFACTURER	MODEL NO.	SERIAL NO.	CALIBRATED DATE	CALIBRATED UNTIL
Agilent Spectrum Analyzer	E4446A	MY48250254	Aug. 03, 2009	Aug. 02, 2010
Agilent Pre-Selector	N9039A	MY46520310	Aug. 18, 2009	Aug. 17, 2010
Agilent Signal Generator	N5181A	MY49060347	July 18, 2009	July 17, 2010
LIG NEX1 Test Receiver	ER-265	L09068005	Aug. 31, 2009	Aug. 30, 2010
Mini-Circuits Pre-Amplifier	ZFL-1000VH2B	AMP-ZFL-04	Nov. 18, 2009	Nov. 17, 2010
Agilent Pre-Amplifier	8449B	3008A02465	Mar. 01, 2010	Feb. 28, 2011
Miteq Pre-Amplifier	AFS33-1800265 0-30-8P-44	881786	NA	NA
SCHWARZBECK Trilog Broadband Antenna	VULB 9168	9168-361	Sep. 30, 2009	Sep. 29, 2010
AISI Horn_Antenna	AIH.8018	0000220091110	Nov. 16, 2009	Nov. 15, 2010
SCHWARZBECK Horn_Antenna	BBHA 9170	9170-424	Sep. 30, 2009	Sep. 29, 2010
RF CABLE	NA	RF104-205 RF104-207 RF104-208	Dec. 24, 2009	Dec. 23, 2010
RF Cable	NA	CHHCAB_001	NA	NA
Software	ADT_Radiated_V8.7.05	NA	NA	NA
CT Antenna Tower & Turn Table	NA	NA	NA	NA

- Note: 1. The calibration interval of the above test instruments is 12 months and the calibrations are traceable to NML/ROC and NIST/USA.
2. The horn antenna, preamplifier (model: 8449B) are used only for the measurement of emission frequency above 1GHz if tested.
3. The test was performed in 966 Chamber No. H.
4. The FCC Site Registration No. is 656396.
5. The VCCI Site Registration No. is R-1626.
6. The CANADA Site Registration No. is IC 7450G-3.



A D T

4.2.3 TEST PROCEDURES

- a. The EUT was placed on the top of a rotating table 0.8 meters above the ground at a 3 meters chamber room. The table was rotated 360 degrees to determine the position of the highest radiation.
- b. The EUT was set 3 meters away from the interference-receiving antenna, which was mounted on the top of a variable-height antenna tower.
- c. The antenna is a broadband antenna, and its height is varied from one meter to four meters above the ground to determine the maximum value of the field strength. Both horizontal and vertical polarizations of the antenna are set to make the measurement.
- d. For each suspected emission, the EUT was arranged to its worst case and then the antenna was tuned to heights from 1 meter to 4 meters and the rotatable table was turned from 0 degrees to 360 degrees to find the maximum reading.
- e. The test-receiver system was set to quasi-peak detect function and specified bandwidth with maximum hold mode when the test frequency is below 1 GHz.
- f. The test-receiver system was set to peak and average detect function and specified bandwidth with maximum hold mode when the test frequency is above 1 GHz. If the peak reading value also meets average limit, measurement with the average detector is unnecessary.

NOTE:

1. The resolution bandwidth and video bandwidth of test receiver/spectrum analyzer is 120kHz for Quasi-peak detection (QP) at frequency below 1GHz.
2. The resolution bandwidth is 1MHz and video bandwidth of test receiver/spectrum analyzer is 3MHz for Peak detection at frequency above 1GHz. The resolution bandwidth of test receiver/spectrum analyzer is 1 MHz for Average detection (AV) at frequency above 1GHz.
3. For measurement of frequency above 1000 MHz, the EUT was set 3 meters away from the interference-receiving antenna.

4.2.4 DEVIATION FROM TEST STANDARD

No deviation

4.2.5 TEST SETUP

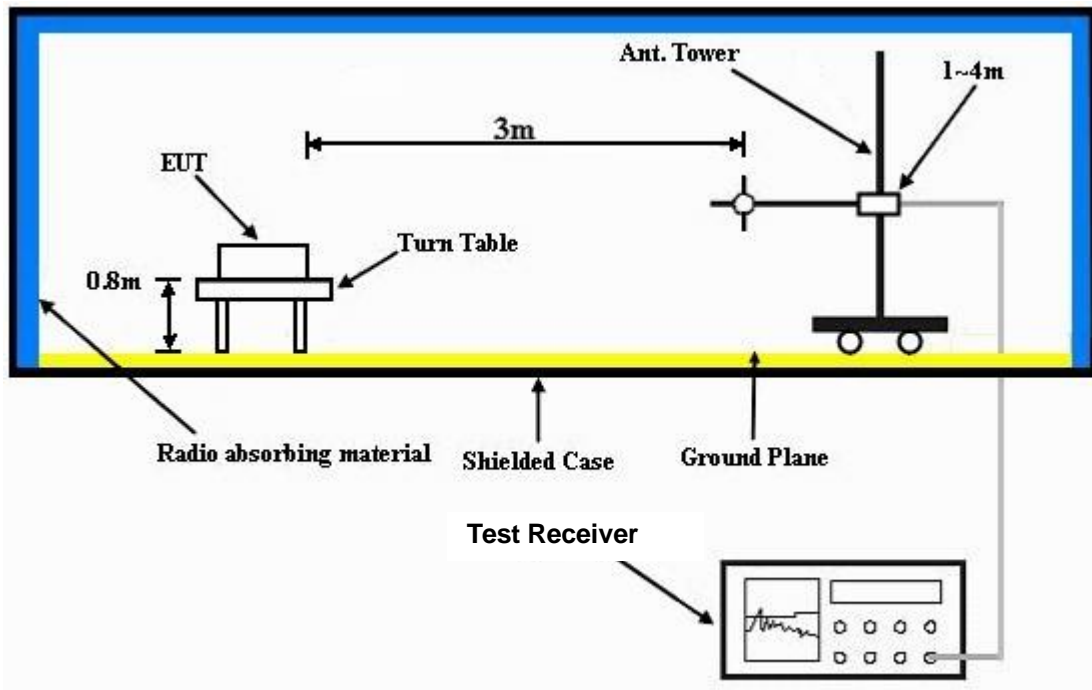

For the actual test configuration, please refer to the related item – Photographs of the Test Configuration.

4.2.6 EUT OPERATING CONDITIONS

1. Placed the EUT on testing table.
2. Prepared other computer systems (support units 1 ~ 2) to act as communication partners and placed them outside of testing area.
3. The communication partners ran test program “QA RT3052 V1.0.0.1” to enable EUT under transmission/receiving condition continuously at specific channel frequency via UTP cables.



A D T

4.2.7 TEST RESULTS

BELOW 1GHz WORST-CASE DATA : 802.11g OFDM MODULATION

EUT TEST CONDITION		MEASUREMENT DETAIL	
CHANNEL	Channel 6	FREQUENCY RANGE	Below 1000MHz
INPUT POWER (SYSTEM)	120Vac, 60 Hz	DETECTOR FUNCTION	Quasi-Peak
ENVIRONMENTAL CONDITIONS	23deg. C, 73%RH 1015 hPa	TESTED BY	Eric Lee

ANTENNA POLARITY & TEST DISTANCE: HORIZONTAL AT 3 M								
NO.	FREQ. (MHz)	EMISSION LEVEL (dBuV/m)	LIMIT (dBuV/m)	MARGIN (dB)	ANTENNA HEIGHT (m)	TABLE ANGLE (Degree)	RAW VALUE (dBuV)	CORRECTION FACTOR (dB/m)
1	139.45	31.1 QP	43.50	-12.4	1.94 H	245	17.78	13.32
2	150.00	30.2 QP	43.50	-13.3	1.24 H	51	16.47	13.77
3	165.00	28.1 QP	43.50	-15.4	1.11 H	69	14.76	13.36
4	215.21	31.2 QP	43.50	-12.3	1.65 H	326	19.96	11.28
5	320.00	35.2 QP	46.00	-10.8	1.11 H	48	20.26	14.98
6	533.33	32.2 QP	46.00	-13.9	1.56 H	62	12.06	20.09
7	746.80	35.2 QP	46.00	-10.8	1.62 H	356	11.32	23.90
8	853.40	36.2 QP	46.00	-9.8	1.99 H	60	10.70	25.51
9	907.65	33.6 QP	46.00	-12.4	1.89 H	2	7.37	26.23
10	960.03	35.5 QP	54.00	-18.5	1.01 H	25	8.92	26.60

ANTENNA POLARITY & TEST DISTANCE: VERTICAL AT 3 M								
NO.	FREQ. (MHz)	EMISSION LEVEL (dBuV/m)	LIMIT (dBuV/m)	MARGIN (dB)	ANTENNA HEIGHT (m)	TABLE ANGLE (Degree)	RAW VALUE (dBuV)	CORRECTION FACTOR (dB/m)
1	60.20	36.8 QP	40.00	-3.2	1.01 V	256	24.14	12.62
2	64.90	35.5 QP	40.00	-4.5	1.54 V	87	23.37	12.10
3	74.56	31.5 QP	40.00	-8.5	1.66 V	25	21.19	10.35
4	104.80	33.9 QP	43.50	-9.6	1.46 V	235	23.45	10.42
5	125.03	34.8 QP	43.50	-8.7	1.10 V	87	22.49	12.32
6	250.01	34.0 QP	46.00	-12.0	1.08 V	250	21.14	12.86
7	499.97	34.2 QP	46.00	-11.8	1.45 V	41	14.93	19.27
8	533.28	33.2 QP	46.00	-12.8	1.84 V	56	13.11	20.09
9	746.80	34.7 QP	46.00	-11.4	1.62 V	253	10.75	23.90
10	960.03	33.5 QP	54.00	-20.5	1.54 V	24	6.94	26.60

- REMARKS:**
1. Emission level (dBuV/m) = Raw Value (dBuV) + Correction Factor (dB/m).
 2. Correction Factor (dB/m) = Antenna Factor (dB/m) + Cable Factor (dB).
 3. The other emission levels were very low against the limit.
 4. Margin value = Emission level – Limit value.



ABOVE 1GHz WORST-CASE DATA

802.11b DSSS MODULATION

EUT TEST CONDITION		MEASUREMENT DETAIL	
CHANNEL	Channel 1	FREQUENCY RANGE	1 ~ 25GHz
INPUT POWER (SYSTEM)	120Vac, 60 Hz	DETECTOR FUNCTION	Peak (PK) Average (AV)
ENVIRONMENTAL CONDITIONS	23deg. C, 68%RH 1015 hPa	TESTED BY	Duke Tseng

ANTENNA POLARITY & TEST DISTANCE: HORIZONTAL AT 3 M								
NO.	FREQ. (MHz)	EMISSION LEVEL (dBuV/m)	LIMIT (dBuV/m)	MARGIN (dB)	ANTENNA HEIGHT (m)	TABLE ANGLE (Degree)	RAW VALUE (dBuV)	CORRECTION FACTOR (dB/m)
1	2386.53	55.9 PK	74.00	-18.1	1.14 H	216	24.71	31.20
2	2386.53	44.3 AV	54.00	-9.8	1.14 H	216	13.05	31.20
3	*2412.00	94.8 PK			1.14 H	216	63.50	31.27
4	*2412.00	92.0 AV			1.14 H	216	60.73	31.27
5	4824.00	53.2 PK	74.00	-20.8	1.26 H	64	13.78	39.42
6	4824.00	50.5 AV	54.00	-3.5	1.26 H	64	11.12	39.42
ANTENNA POLARITY & TEST DISTANCE: VERTICAL AT 3 M								
NO.	FREQ. (MHz)	EMISSION LEVEL (dBuV/m)	LIMIT (dBuV/m)	MARGIN (dB)	ANTENNA HEIGHT (m)	TABLE ANGLE (Degree)	RAW VALUE (dBuV)	CORRECTION FACTOR (dB/m)
1	2386.40	63.7 PK	74.00	-10.3	1.14 V	22	32.48	31.20
2	2386.40	51.4 AV	54.00	-2.6	1.14 V	22	20.23	31.20
3	*2412.00	107.1 PK			1.13 V	21	75.84	31.27
4	*2412.00	104.9 AV			1.13 V	21	73.63	31.27
5	4824.00	53.7 PK	74.00	-20.3	1.01 V	99	14.32	39.42
6	4824.00	52.0 AV	54.00	-2.0	1.01 V	99	12.61	39.42

- REMARKS:**
1. Emission level (dBuV/m) = Raw Value (dBuV) + Correction Factor (dB/m).
 2. Correction Factor (dB/m) = Antenna Factor (dB/m) + Cable Factor (dB).
 3. The other emission levels were very low against the limit.
 4. Margin value = Emission level – Limit value.
 5. “ * “: Fundamental frequency.



A D T

EUT TEST CONDITION		MEASUREMENT DETAIL	
CHANNEL	Channel 6	FREQUENCY RANGE	1 ~ 25GHz
INPUT POWER (SYSTEM)	120Vac, 60 Hz	DETECTOR FUNCTION	Peak (PK) Average (AV)
ENVIRONMENTAL CONDITIONS	23deg. C, 68%RH 1015 hPa	TESTED BY	Duke Tseng

ANTENNA POLARITY & TEST DISTANCE: HORIZONTAL AT 3 M								
NO.	FREQ. (MHz)	EMISSION LEVEL (dBuV/m)	LIMIT (dBuV/m)	MARGIN (dB)	ANTENNA HEIGHT (m)	TABLE ANGLE (Degree)	RAW VALUE (dBuV)	CORRECTION FACTOR (dB/m)
1	*2437.00	97.3 PK			1.11 H	217	65.98	31.34
2	*2437.00	94.9 AV			1.11 H	217	63.60	31.34
3	4874.00	53.8 PK	74.00	-20.2	1.26 H	65	14.15	39.62
4	4874.00	51.2 AV	54.00	-2.8	1.26 H	65	11.61	39.62
5	7311.00	52.1 PK	74.00	-21.9	1.33 H	67	8.01	44.10
6	7311.00	40.1 AV	54.00	-13.9	1.33 H	67	-3.98	44.10
ANTENNA POLARITY & TEST DISTANCE: VERTICAL AT 3 M								
NO.	FREQ. (MHz)	EMISSION LEVEL (dBuV/m)	LIMIT (dBuV/m)	MARGIN (dB)	ANTENNA HEIGHT (m)	TABLE ANGLE (Degree)	RAW VALUE (dBuV)	CORRECTION FACTOR (dB/m)
1	*2437.00	108.1 PK			1.13 V	21	76.76	31.34
2	*2437.00	105.8 AV			1.13 V	21	74.46	31.34
3	4874.00	54.7 PK	74.00	-19.3	1.02 V	99	15.10	39.62
4	4874.00	52.5 AV	54.00	-1.5	1.02 V	99	12.85	39.62
5	7311.00	51.3 PK	74.00	-22.7	1.51 V	130	7.20	44.10
6	7311.00	40.6 AV	54.00	-13.4	1.51 V	130	-3.50	44.10

- REMARKS:**
1. Emission level (dBuV/m) = Raw Value (dBuV) + Correction Factor (dB/m).
 2. Correction Factor (dB/m) = Antenna Factor (dB/m) + Cable Factor (dB).
 3. The other emission levels were very low against the limit.
 4. Margin value = Emission level – Limit value.
 5. “ * “: Fundamental frequency.



A D T

EUT TEST CONDITION		MEASUREMENT DETAIL	
CHANNEL	Channel 11	FREQUENCY RANGE	1 ~ 25GHz
INPUT POWER (SYSTEM)	120Vac, 60 Hz	DETECTOR FUNCTION	Peak (PK) Average (AV)
ENVIRONMENTAL CONDITIONS	23deg. C, 68%RH 1015 hPa	TESTED BY	Duke Tseng

ANTENNA POLARITY & TEST DISTANCE: HORIZONTAL AT 3 M								
NO.	FREQ. (MHz)	EMISSION LEVEL (dBuV/m)	LIMIT (dBuV/m)	MARGIN (dB)	ANTENNA HEIGHT (m)	TABLE ANGLE (Degree)	RAW VALUE (dBuV)	CORRECTION FACTOR (dB/m)
1	*2462.00	99.5 PK			1.12 H	217	68.12	31.40
2	*2462.00	97.3 AV			1.12 H	217	65.86	31.40
3	2487.93	58.6 PK	74.00	-15.4	1.11 H	217	27.14	31.47
4	2487.93	46.4 AV	54.00	-7.6	1.11 H	217	14.91	31.47
5	4924.00	54.5 PK	74.00	-19.5	1.26 H	65	14.66	39.82
6	4924.00	52.2 AV	54.00	-1.9	1.26 H	65	12.33	39.82
7	7386.00	51.6 PK	74.00	-22.4	1.37 H	71	7.45	44.18
8	7386.00	40.1 AV	54.00	-13.9	1.37 H	71	-4.08	44.18
ANTENNA POLARITY & TEST DISTANCE: VERTICAL AT 3 M								
NO.	FREQ. (MHz)	EMISSION LEVEL (dBuV/m)	LIMIT (dBuV/m)	MARGIN (dB)	ANTENNA HEIGHT (m)	TABLE ANGLE (Degree)	RAW VALUE (dBuV)	CORRECTION FACTOR (dB/m)
1	2360.00	60.4 PK	74.00	-13.6	1.16 V	22	29.27	31.13
2	2360.00	52.5 AV	54.00	-1.5	1.16 V	22	21.38	31.13
3	*2462.00	109.1 PK			1.12 V	21	77.70	31.40
4	*2462.00	106.8 AV			1.12 V	21	75.44	31.40
5	2487.82	65.3 PK	74.00	-8.7	1.12 V	24	33.81	31.47
6	2487.82	53.5 AV	54.00	-0.6	1.12 V	24	21.98	31.47
7	4924.00	55.7 PK	74.00	-18.3	1.00 V	99	15.84	39.82
8	4924.00	53.5 AV	54.00	-0.5	1.00 V	99	13.68	39.82
9	7386.00	53.1 PK	74.00	-20.9	1.52 V	96	8.88	44.18
10	7386.00	42.9 AV	54.00	-11.1	1.52 V	96	-1.29	44.18

- REMARKS:**
1. Emission level (dBuV/m) = Raw Value (dBuV) + Correction Factor (dB/m).
 2. Correction Factor (dB/m) = Antenna Factor (dB/m) + Cable Factor (dB).
 3. The other emission levels were very low against the limit.
 4. Margin value = Emission level – Limit value.
 5. “ * “: Fundamental frequency.



A D T

RESTRICTED BANDEDGE (802.11b MODE, CH1, HORIZONTAL)

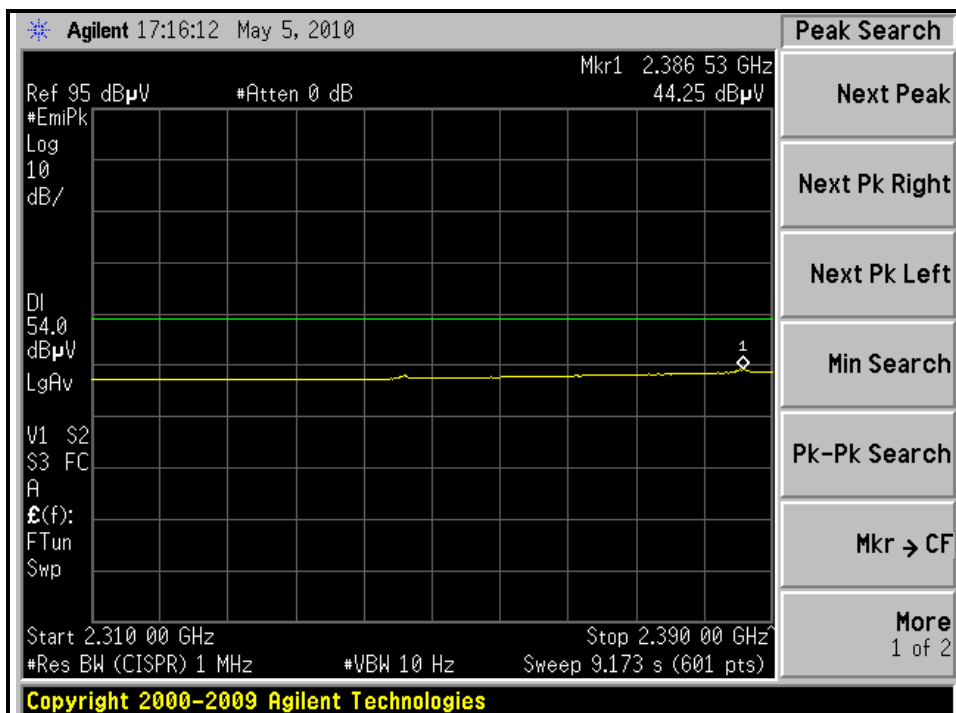
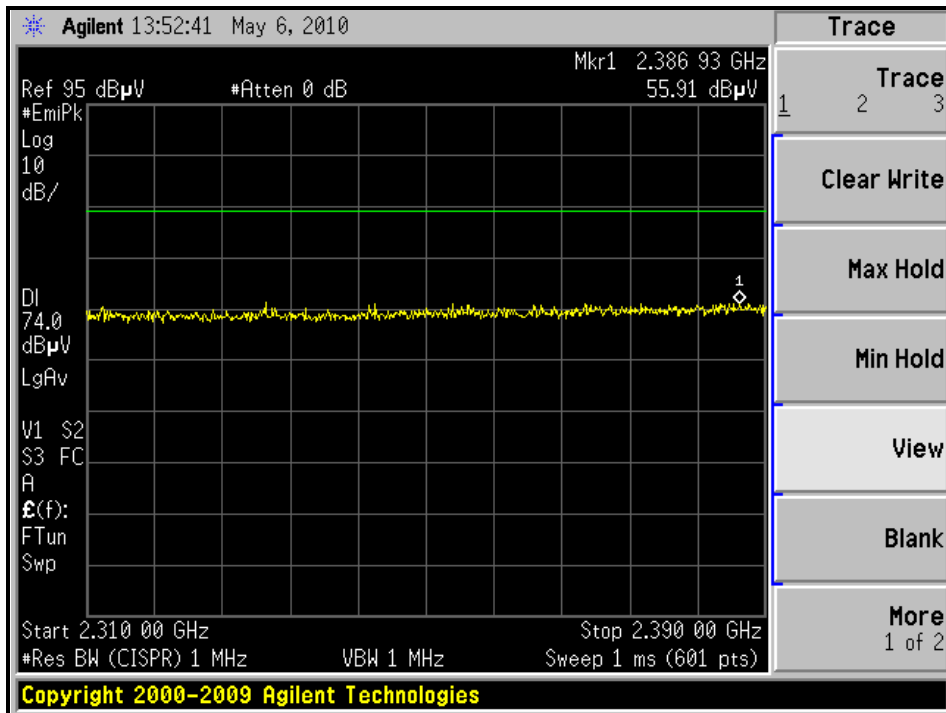



A D T

RESTRICTED BANDEDGE (802.11b MODE, CH1, VERTICAL)

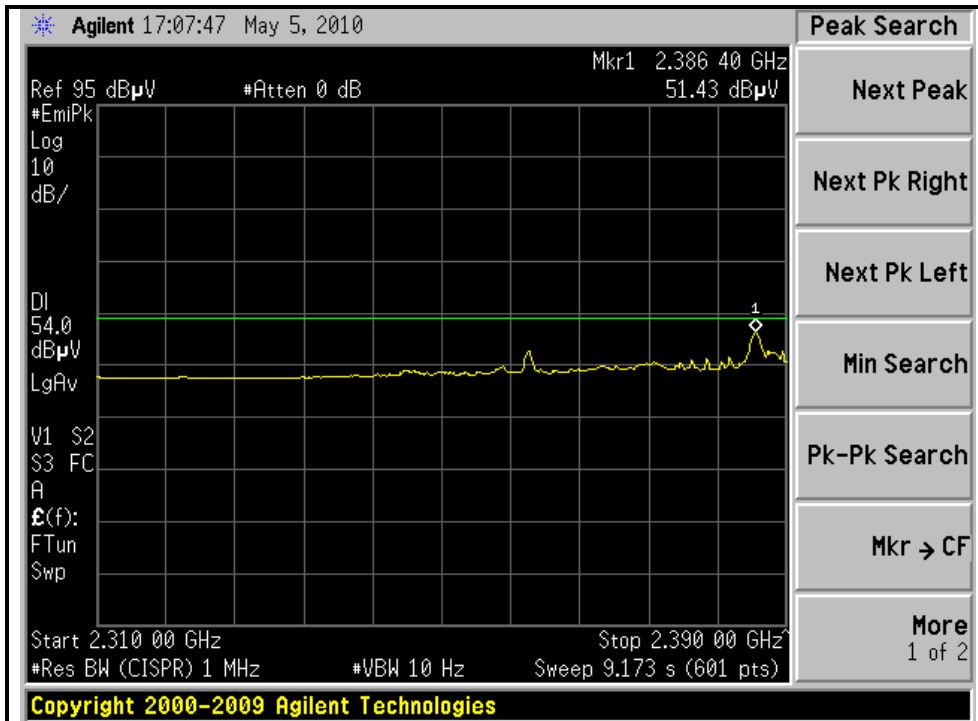
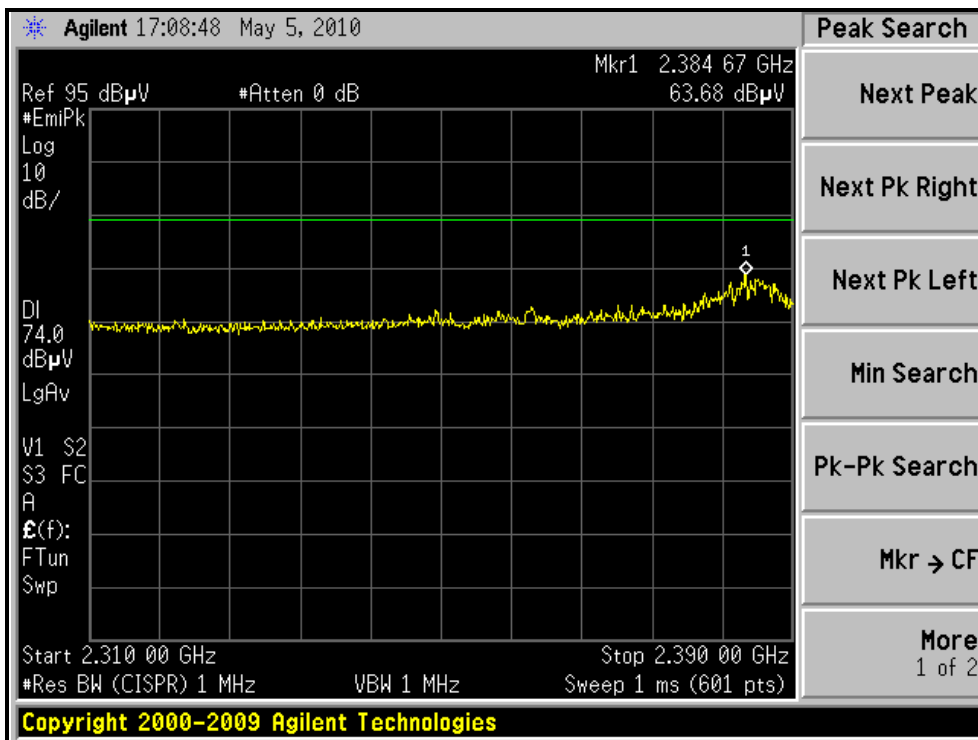



A D T

RESTRICTED BANDEDGE (802.11b MODE,CH11, HORIZONTAL)

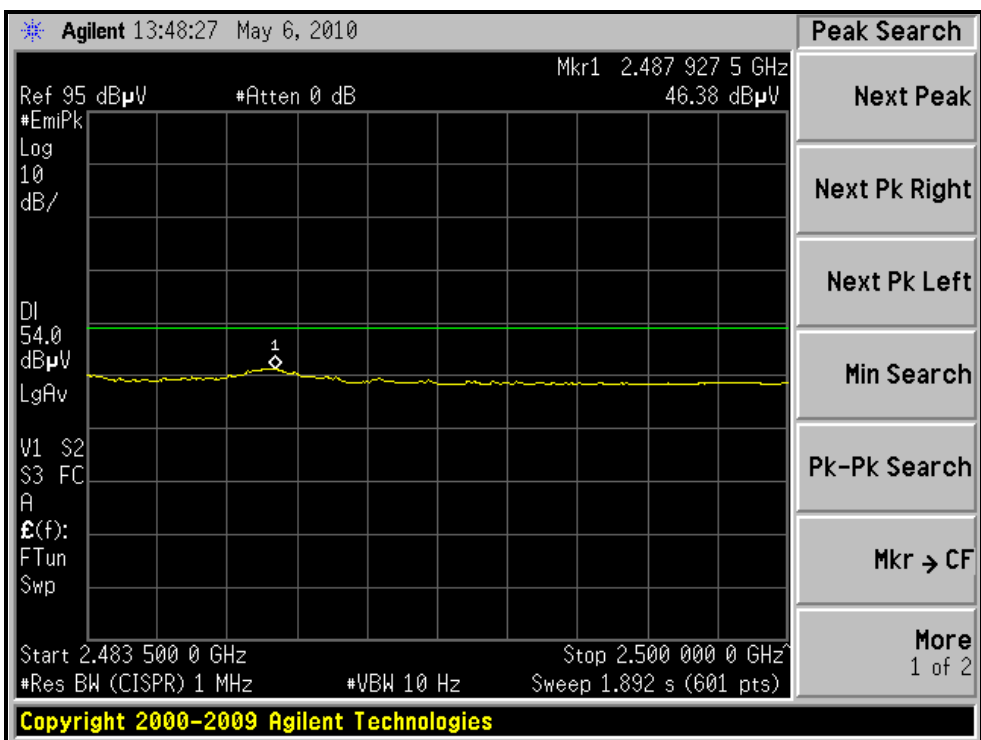
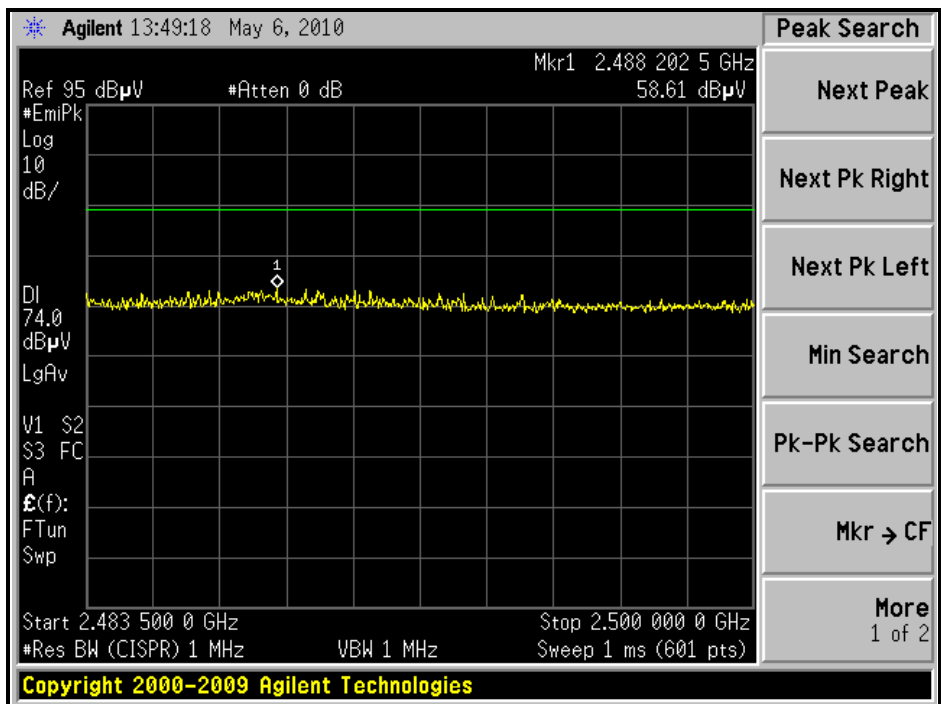



A D T

RESTRICTED BANDEDGE (802.11b MODE, CH11, VERTICAL)

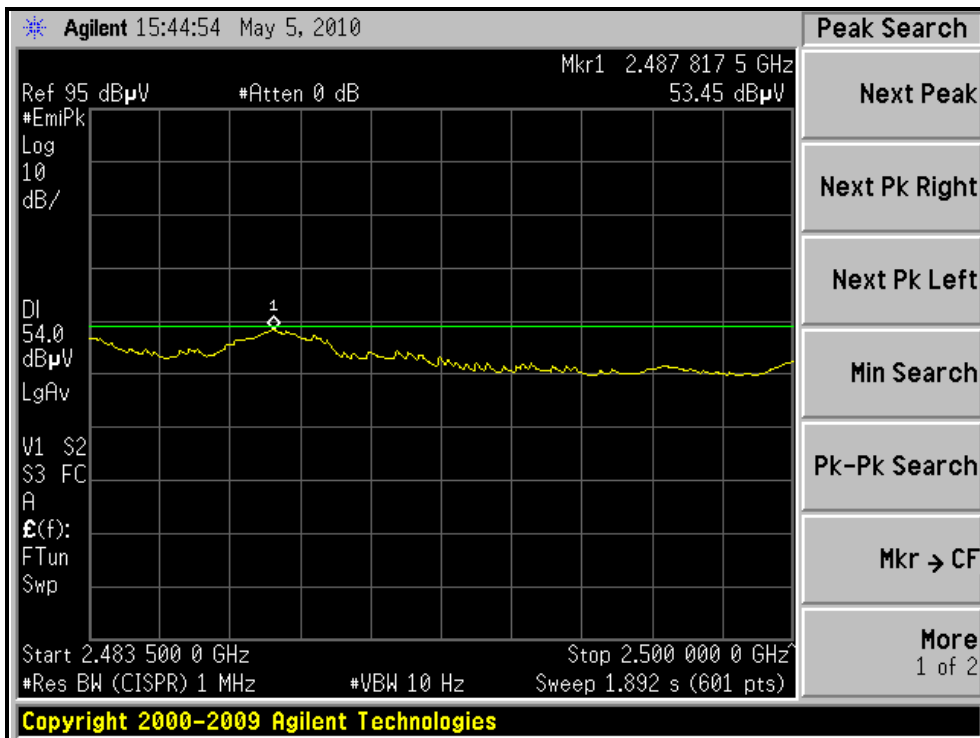
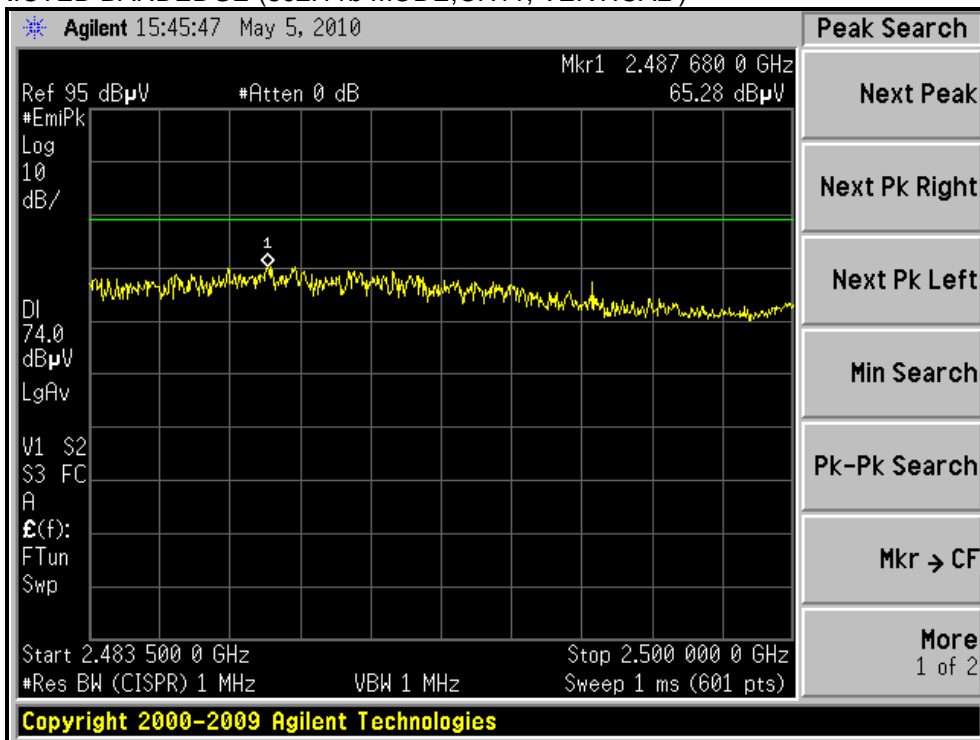



A D T

802.11g OFDM MODULATION

EUT TEST CONDITION		MEASUREMENT DETAIL	
CHANNEL	Channel 1	FREQUENCY RANGE	1 ~ 25GHz
INPUT POWER (SYSTEM)	120Vac, 60 Hz	DETECTOR FUNCTION	Peak (PK) Average (AV)
ENVIRONMENTAL CONDITIONS	23deg. C, 68%RH 1015 hPa	TESTED BY	Duke Tseng

ANTENNA POLARITY & TEST DISTANCE: HORIZONTAL AT 3 M

NO.	FREQ. (MHz)	EMISSION LEVEL (dBuV/m)	LIMIT (dBuV/m)	MARGIN (dB)	ANTENNA HEIGHT (m)	TABLE ANGLE (Degree)	RAW VALUE (dBuV)	CORRECTION FACTOR (dB/m)
1	2390.00	58.7 PK	74.00	-15.3	1.14 H	216	27.50	31.21
2	2390.00	44.7 AV	54.00	-9.3	1.14 H	216	13.45	31.21
3	*2412.00	96.8 PK			1.14 H	216	65.56	31.27
4	*2412.00	87.5 AV			1.14 H	216	56.23	31.27
5	4824.00	50.1 PK	74.00	-23.9	1.32 H	68	10.70	39.42
6	4824.00	37.7 AV	54.00	-16.3	1.32 H	68	-1.73	39.42

ANTENNA POLARITY & TEST DISTANCE: VERTICAL AT 3 M

NO.	FREQ. (MHz)	EMISSION LEVEL (dBuV/m)	LIMIT (dBuV/m)	MARGIN (dB)	ANTENNA HEIGHT (m)	TABLE ANGLE (Degree)	RAW VALUE (dBuV)	CORRECTION FACTOR (dB/m)
1	2390.00	66.4 PK	74.00	-7.6	1.16 V	23	35.22	31.21
2	2390.00	50.8 AV	54.00	-3.3	1.16 V	23	19.54	31.21
3	*2412.00	108.2 PK			1.12 V	22	76.93	31.27
4	*2412.00	99.3 AV			1.12 V	22	67.98	31.27
5	4824.00	48.5 PK	74.00	-25.5	1.00 V	101	9.07	39.42
6	4824.00	35.7 AV	54.00	-18.3	1.00 V	101	-3.72	39.42

- REMARKS:**
1. Emission level (dBuV/m) = Raw Value (dBuV) + Correction Factor (dB/m).
 2. Correction Factor (dB/m) = Antenna Factor (dB/m) + Cable Factor (dB).
 3. The other emission levels were very low against the limit.
 4. Margin value = Emission level – Limit value.
 5. “ * “: Fundamental frequency.



A D T

EUT TEST CONDITION		MEASUREMENT DETAIL	
CHANNEL	Channel 6	FREQUENCY RANGE	1 ~ 25GHz
INPUT POWER (SYSTEM)	120Vac, 60 Hz	DETECTOR FUNCTION	Peak (PK) Average (AV)
ENVIRONMENTAL CONDITIONS	23deg. C, 68%RH 1015 hPa	TESTED BY	Duke Tseng

ANTENNA POLARITY & TEST DISTANCE: HORIZONTAL AT 3 M								
NO.	FREQ. (MHz)	EMISSION LEVEL (dBuV/m)	LIMIT (dBuV/m)	MARGIN (dB)	ANTENNA HEIGHT (m)	TABLE ANGLE (Degree)	RAW VALUE (dBuV)	CORRECTION FACTOR (dB/m)
1	*2437.00	101.8 PK			1.13 H	216	70.42	31.34
2	*2437.00	92.7 AV			1.13 H	216	61.35	31.34
3	4874.00	54.1 PK	74.00	-19.9	1.26 H	67	14.49	39.62
4	4874.00	41.2 AV	54.00	-12.8	1.26 H	67	1.54	39.62
5	7311.00	50.5 PK	74.00	-23.6	1.33 H	80	6.35	44.10
6	7311.00	38.5 AV	54.00	-15.5	1.33 H	80	-5.62	44.10
ANTENNA POLARITY & TEST DISTANCE: VERTICAL AT 3 M								
NO.	FREQ. (MHz)	EMISSION LEVEL (dBuV/m)	LIMIT (dBuV/m)	MARGIN (dB)	ANTENNA HEIGHT (m)	TABLE ANGLE (Degree)	RAW VALUE (dBuV)	CORRECTION FACTOR (dB/m)
1	2384.80	67.6 PK	74.00	-6.4	1.14 V	22	36.42	31.20
2	2384.80	53.2 AV	54.00	-0.8	1.14 V	22	22.03	31.20
3	*2437.00	111.7 PK			1.12 V	22	80.31	31.34
4	*2437.00	102.8 AV			1.12 V	22	71.43	31.34
5	4874.00	52.7 PK	74.00	-21.3	1.04 V	0	13.07	39.62
6	4874.00	39.4 AV	54.00	-14.6	1.04 V	0	-0.18	39.62
7	7311.00	53.1 PK	74.00	-20.9	1.53 V	105	9.04	44.10
8	7311.00	40.6 AV	54.00	-13.4	1.53 V	105	-3.49	44.10

- REMARKS:**
1. Emission level (dBuV/m) = Raw Value (dBuV) + Correction Factor (dB/m).
 2. Correction Factor (dB/m) = Antenna Factor (dB/m) + Cable Factor (dB).
 3. The other emission levels were very low against the limit.
 4. Margin value = Emission level – Limit value.
 5. “ * “: Fundamental frequency.



A D T

EUT TEST CONDITION		MEASUREMENT DETAIL	
CHANNEL	Channel 11	FREQUENCY RANGE	1 ~ 25GHz
INPUT POWER (SYSTEM)	120Vac, 60 Hz	DETECTOR FUNCTION	Peak (PK) Average (AV)
ENVIRONMENTAL CONDITIONS	23deg. C, 68%RH 1015 hPa	TESTED BY	Duke Tseng

ANTENNA POLARITY & TEST DISTANCE: HORIZONTAL AT 3 M								
NO.	FREQ. (MHz)	EMISSION LEVEL (dBuV/m)	LIMIT (dBuV/m)	MARGIN (dB)	ANTENNA HEIGHT (m)	TABLE ANGLE (Degree)	RAW VALUE (dBuV)	CORRECTION FACTOR (dB/m)
1	*2462.00	99.4 PK			1.12 H	217	67.97	31.40
2	*2462.00	90.3 AV			1.12 H	217	58.86	31.40
3	2483.94	63.6 PK	74.00	-10.4	1.13 H	217	32.10	31.46
4	2483.94	44.7 AV	54.00	-9.3	1.13 H	217	13.27	31.46
5	4924.00	50.8 PK	74.00	-23.2	1.26 H	65	10.95	39.82
6	4924.00	38.6 AV	54.00	-15.5	1.26 H	65	-1.27	39.82
7	7386.00	50.6 PK	74.00	-23.4	1.32 H	76	6.46	44.18
8	7386.00	38.6 AV	54.00	-15.4	1.32 H	76	-5.58	44.18
ANTENNA POLARITY & TEST DISTANCE: VERTICAL AT 3 M								
NO.	FREQ. (MHz)	EMISSION LEVEL (dBuV/m)	LIMIT (dBuV/m)	MARGIN (dB)	ANTENNA HEIGHT (m)	TABLE ANGLE (Degree)	RAW VALUE (dBuV)	CORRECTION FACTOR (dB/m)
1	2320.00	58.2 PK	74.00	-15.8	1.19 V	21	27.18	31.02
2	2320.00	50.3 AV	54.00	-3.8	1.19 V	21	19.23	31.02
3	*2462.00	109.6 PK			1.10 V	21	78.23	31.40
4	*2462.00	100.4 AV			1.10 V	21	68.96	31.40
5	2483.50	72.2 PK	74.00	-1.8	1.12 V	23	40.77	31.46
6	2483.50	50.2 AV	54.00	-3.8	1.12 V	23	18.71	31.46
7	4924.00	49.4 PK	74.00	-24.6	1.02 V	101	9.57	39.82
8	4924.00	37.1 AV	54.00	-16.9	1.02 V	101	-2.72	39.82
9	7386.00	52.6 PK	74.00	-21.4	1.54 V	107	8.41	44.18
10	7386.00	39.7 AV	54.00	-14.3	1.54 V	107	-4.47	44.18

- REMARKS:**
1. Emission level (dBuV/m) = Raw Value (dBuV) + Correction Factor (dB/m).
 2. Correction Factor (dB/m) = Antenna Factor (dB/m) + Cable Factor (dB).
 3. The other emission levels were very low against the limit.
 4. Margin value = Emission level – Limit value.
 5. “ * “: Fundamental frequency.



A D T

RESTRICTED BANDEDGE (802.11g MODE, CH1, HORIZONTAL)

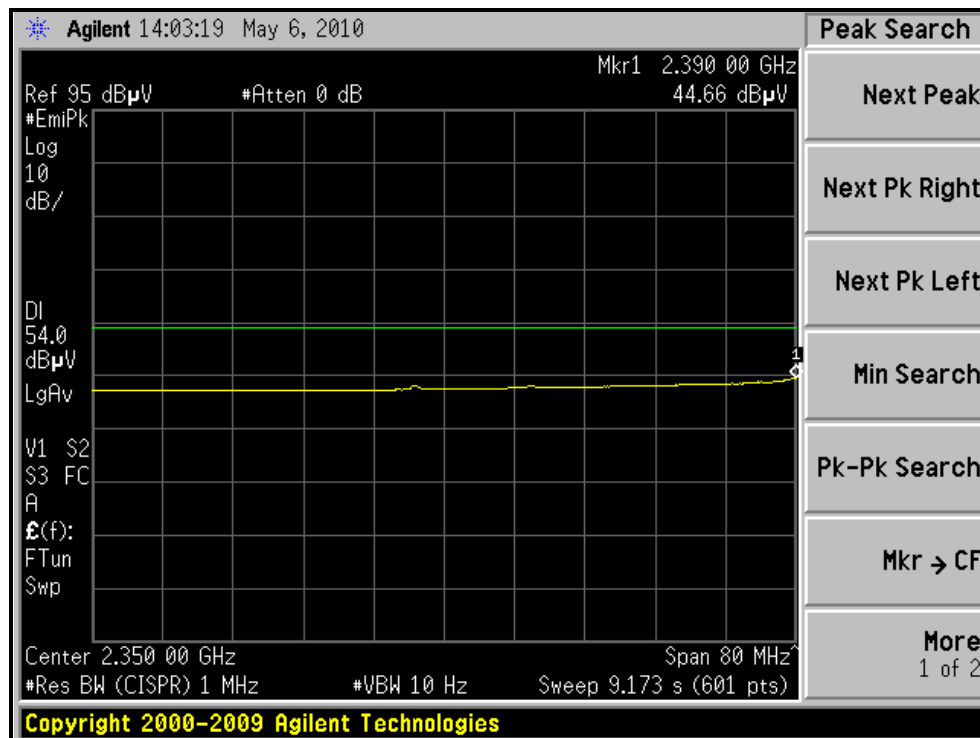
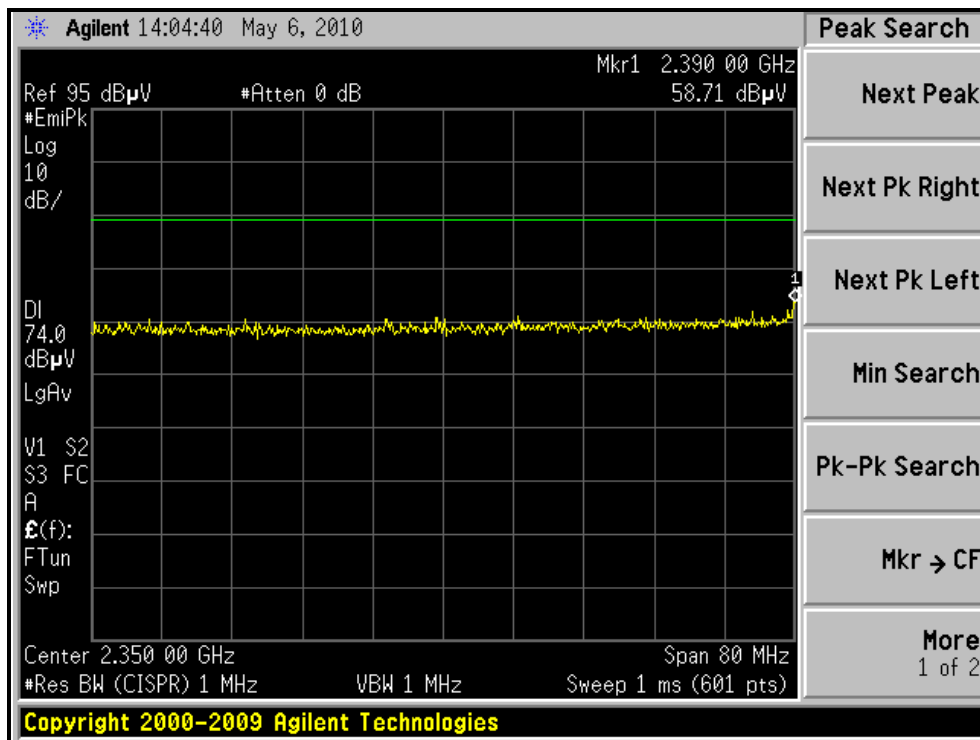



A D T

RESTRICTED BANDEDGE (802.11g MODE, CH1, VERTICAL)

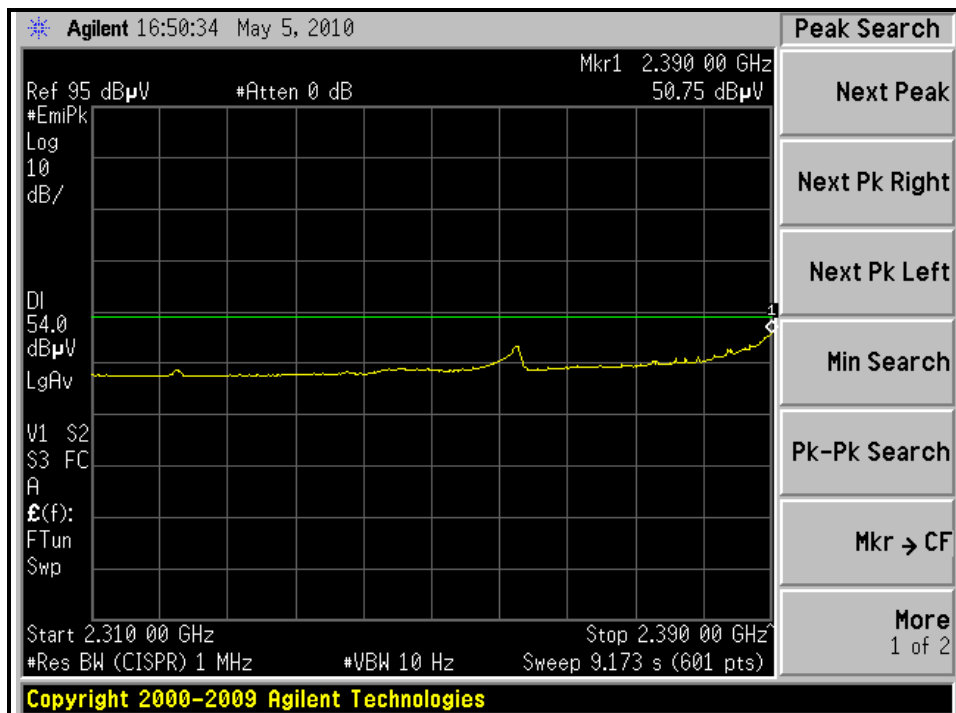
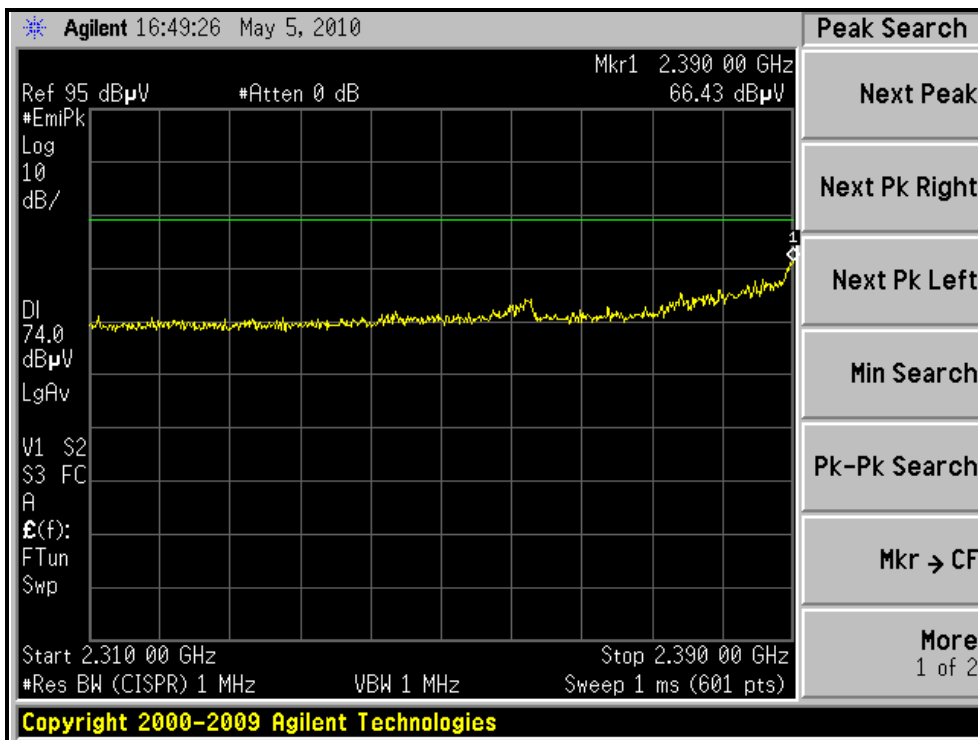



A D T

RESTRICTED BANDEDGE (802.11g MODE,CH11, HORIZONTAL)

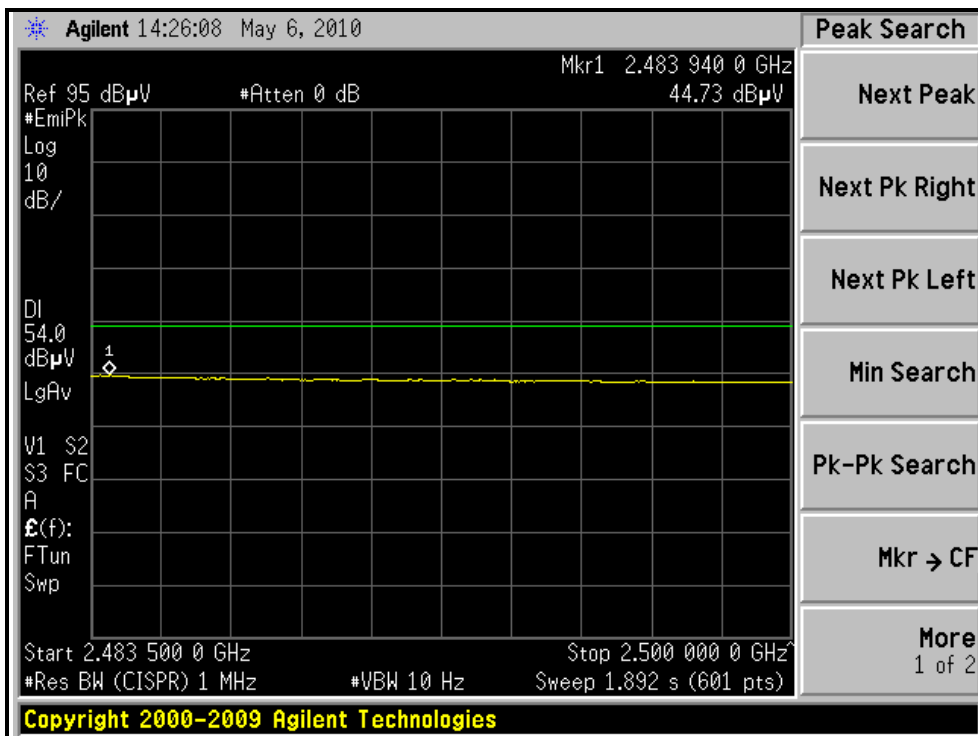
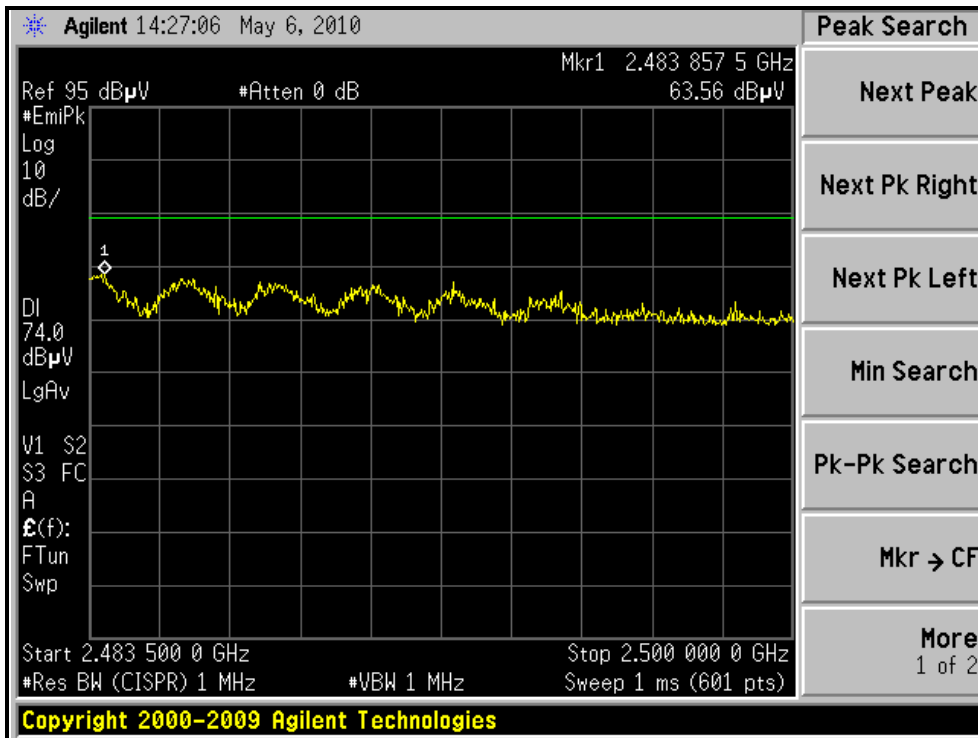



A D T

RESTRICTED BANDEDGE (802.11g MODE, CH11, VERTICAL)

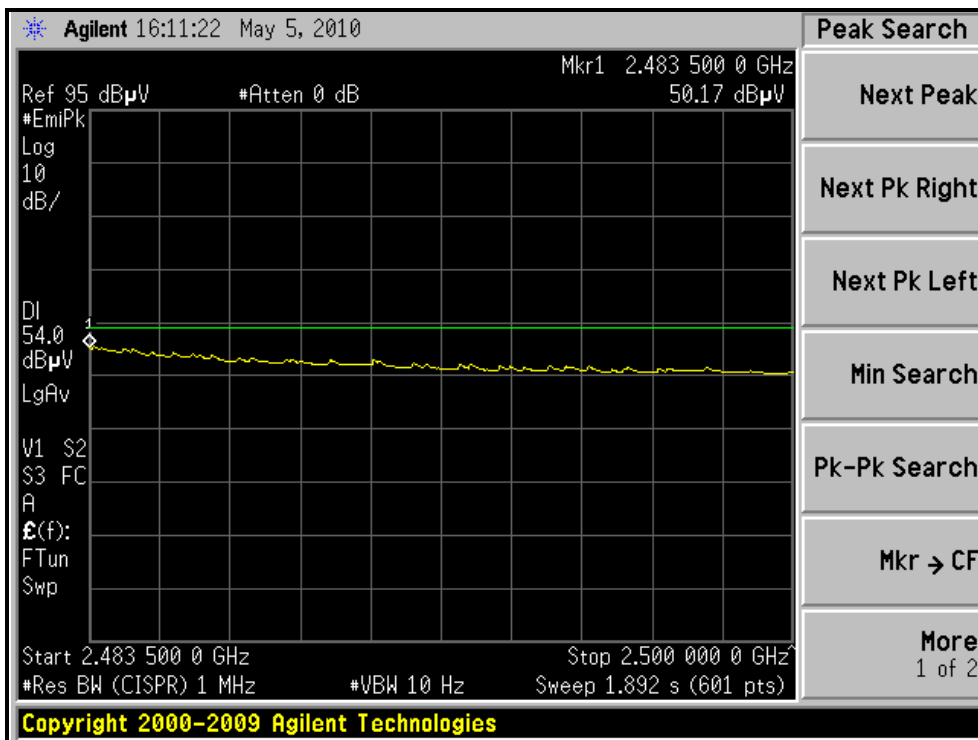
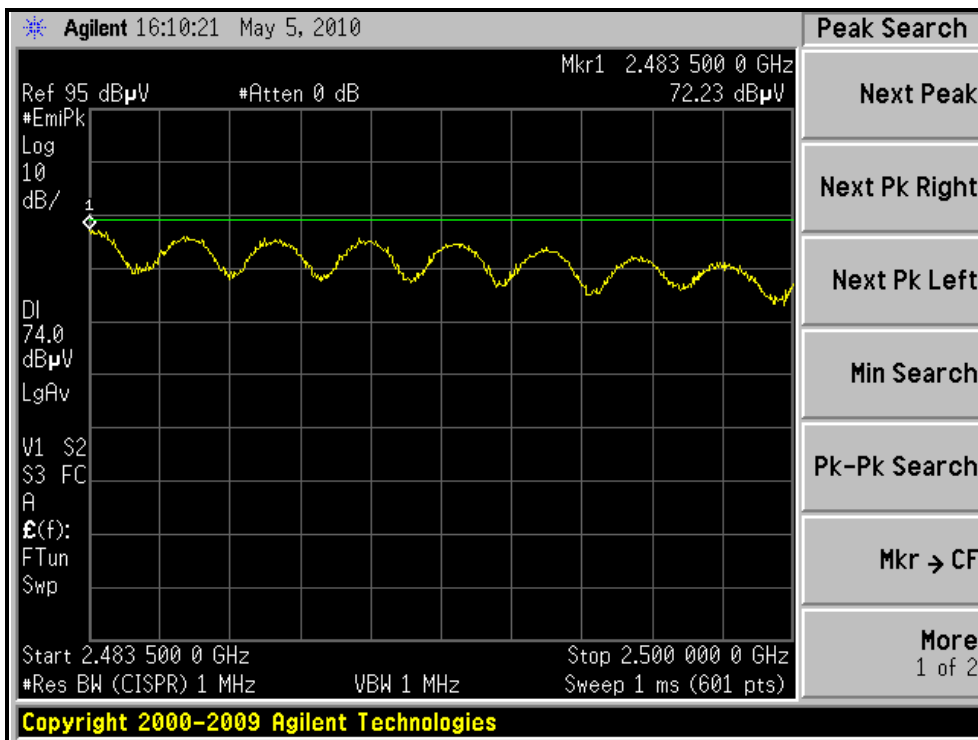



A D T

802.11n (20MHz) OFDM MODULATION

EUT TEST CONDITION		MEASUREMENT DETAIL	
CHANNEL	Channel 1	FREQUENCY RANGE	1 ~ 25GHz
INPUT POWER (SYSTEM)	120Vac, 60 Hz	DETECTOR FUNCTION	Peak (PK) Average (AV)
ENVIRONMENTAL CONDITIONS	23deg. C, 68%RH 1015 hPa	TESTED BY	Duke Tseng

ANTENNA POLARITY & TEST DISTANCE: HORIZONTAL AT 3 M								
NO.	FREQ. (MHz)	EMISSION LEVEL (dBuV/m)	LIMIT (dBuV/m)	MARGIN (dB)	ANTENNA HEIGHT (m)	TABLE ANGLE (Degree)	RAW VALUE (dBuV)	CORRECTION FACTOR (dB/m)
1	2390.00	57.9 PK	74.00	-16.1	1.14 H	217	26.65	31.21
2	2390.00	44.6 AV	54.00	-9.4	1.14 H	217	13.43	31.21
3	*2412.00	96.3 PK			1.14 H	217	65.06	31.27
4	*2412.00	87.2 AV			1.14 H	217	55.93	31.27
5	4824.00	50.1 PK	74.00	-23.9	1.30 H	67	10.70	39.42
6	4824.00	37.7 AV	54.00	-16.3	1.30 H	67	-1.70	39.42
ANTENNA POLARITY & TEST DISTANCE: VERTICAL AT 3 M								
NO.	FREQ. (MHz)	EMISSION LEVEL (dBuV/m)	LIMIT (dBuV/m)	MARGIN (dB)	ANTENNA HEIGHT (m)	TABLE ANGLE (Degree)	RAW VALUE (dBuV)	CORRECTION FACTOR (dB/m)
1	2389.73	66.0 PK	74.00	-8.0	1.16 V	22	34.82	31.21
2	2389.73	50.4 AV	54.00	-3.6	1.16 V	22	19.20	31.21
3	*2412.00	108.4 PK			1.14 V	21	77.13	31.27
4	*2412.00	99.4 AV			1.14 V	21	68.16	31.27
5	4824.00	47.3 PK	74.00	-26.7	1.01 V	101	7.92	39.42
6	4824.00	35.7 AV	54.00	-18.3	1.01 V	101	-3.75	39.42

- REMARKS:**
1. Emission level (dBuV/m) = Raw Value (dBuV) + Correction Factor (dB/m).
 2. Correction Factor (dB/m) = Antenna Factor (dB/m) + Cable Factor (dB).
 3. The other emission levels were very low against the limit.
 4. Margin value = Emission level – Limit value.
 5. “ * ”: Fundamental frequency.



A D T

EUT TEST CONDITION		MEASUREMENT DETAIL	
CHANNEL	Channel 6	FREQUENCY RANGE	1 ~ 25GHz
INPUT POWER (SYSTEM)	120Vac, 60 Hz	DETECTOR FUNCTION	Peak (PK) Average (AV)
ENVIRONMENTAL CONDITIONS	23deg. C, 68%RH 1015 hPa	TESTED BY	Duke Tseng

ANTENNA POLARITY & TEST DISTANCE: HORIZONTAL AT 3 M								
NO.	FREQ. (MHz)	EMISSION LEVEL (dBuV/m)	LIMIT (dBuV/m)	MARGIN (dB)	ANTENNA HEIGHT (m)	TABLE ANGLE (Degree)	RAW VALUE (dBuV)	CORRECTION FACTOR (dB/m)
1	*2437.00	101.6 PK			1.12 H	217	70.22	31.34
2	*2437.00	92.8 AV			1.12 H	217	61.44	31.34
3	4874.00	53.9 PK	74.00	-20.1	1.26 H	65	14.28	39.62
4	4874.00	41.1 AV	54.00	-12.9	1.26 H	65	1.45	39.62
5	7311.00	50.4 PK	74.00	-23.6	1.33 H	81	6.30	44.10
6	7311.00	38.4 AV	54.00	-15.6	1.33 H	81	-5.69	44.10
ANTENNA POLARITY & TEST DISTANCE: VERTICAL AT 3 M								
NO.	FREQ. (MHz)	EMISSION LEVEL (dBuV/m)	LIMIT (dBuV/m)	MARGIN (dB)	ANTENNA HEIGHT (m)	TABLE ANGLE (Degree)	RAW VALUE (dBuV)	CORRECTION FACTOR (dB/m)
1	2384.80	67.8 PK	74.00	-6.2	1.14 V	24	36.59	31.20
2	2384.80	53.1 AV	54.00	-0.9	1.14 V	24	21.93	31.20
3	*2437.00	111.7 PK			1.15 V	20	80.37	31.34
4	*2437.00	102.9 AV			1.15 V	20	71.56	31.34
5	4874.00	51.3 PK	74.00	-22.7	1.03 V	100	11.68	39.62
6	4874.00	39.6 AV	54.00	-14.4	1.03 V	100	-0.04	39.62
7	7311.00	53.2 PK	74.00	-20.8	1.54 V	106	9.12	44.10
8	7311.00	40.6 AV	54.00	-13.4	1.54 V	106	-3.53	44.10

- REMARKS:**
1. Emission level (dBuV/m) = Raw Value (dBuV) + Correction Factor (dB/m).
 2. Correction Factor (dB/m) = Antenna Factor (dB/m) + Cable Factor (dB).
 3. The other emission levels were very low against the limit.
 4. Margin value = Emission level – Limit value.
 5. “ * “: Fundamental frequency.



A D T

EUT TEST CONDITION		MEASUREMENT DETAIL	
CHANNEL	Channel 11	FREQUENCY RANGE	1 ~ 25GHz
INPUT POWER (SYSTEM)	120Vac, 60 Hz	DETECTOR FUNCTION	Peak (PK) Average (AV)
ENVIRONMENTAL CONDITIONS	23deg. C, 68%RH 1015 hPa	TESTED BY	Duke Tseng

ANTENNA POLARITY & TEST DISTANCE: HORIZONTAL AT 3 M

NO.	FREQ. (MHz)	EMISSION LEVEL (dBuV/m)	LIMIT (dBuV/m)	MARGIN (dB)	ANTENNA HEIGHT (m)	TABLE ANGLE (Degree)	RAW VALUE (dBuV)	CORRECTION FACTOR (dB/m)
1	*2462.00	98.9 PK			1.12 H	216	67.45	31.40
2	*2462.00	89.8 AV			1.12 H	216	58.35	31.40
3	2484.19	60.8 PK	74.00	-13.2	1.12 H	217	29.35	31.46
4	2484.19	44.8 AV	54.00	-9.2	1.12 H	217	13.37	31.46
5	4924.00	50.7 PK	74.00	-23.4	1.27 H	66	10.83	39.82
6	4924.00	38.5 AV	54.00	-15.6	1.27 H	66	-1.37	39.82
7	7386.00	50.7 PK	74.00	-23.3	1.31 H	78	6.52	44.18
8	7386.00	38.7 AV	54.00	-15.3	1.31 H	78	-5.51	44.18

ANTENNA POLARITY & TEST DISTANCE: VERTICAL AT 3 M

NO.	FREQ. (MHz)	EMISSION LEVEL (dBuV/m)	LIMIT (dBuV/m)	MARGIN (dB)	ANTENNA HEIGHT (m)	TABLE ANGLE (Degree)	RAW VALUE (dBuV)	CORRECTION FACTOR (dB/m)
1	2320.00	58.6 PK	74.00	-15.4	1.20 V	21	27.55	31.02
2	2320.00	50.4 AV	54.00	-3.6	1.20 V	21	19.40	31.02
3	*2462.00	109.6 PK			1.12 V	28	78.23	31.40
4	*2462.00	100.8 AV			1.12 V	28	69.39	31.40
5	2483.58	73.4 PK	74.00	-0.6	1.12 V	23	41.96	31.46
6	2483.58	50.9 AV	54.00	-3.1	1.12 V	23	19.44	31.46
7	4924.00	48.5 PK	74.00	-25.6	1.02 V	100	8.63	39.82
8	4924.00	37.1 AV	54.00	-16.9	1.02 V	100	-2.76	39.82
9	7386.00	52.2 PK	74.00	-21.8	1.53 V	104	8.04	44.18
10	7386.00	39.7 AV	54.00	-14.3	1.53 V	104	-4.51	44.18

- REMARKS:**
1. Emission level (dBuV/m) = Raw Value (dBuV) + Correction Factor (dB/m).
 2. Correction Factor (dB/m) = Antenna Factor (dB/m) + Cable Factor (dB).
 3. The other emission levels were very low against the limit.
 4. Margin value = Emission level – Limit value.
 5. “ * “: Fundamental frequency.



A D T

RESTRICTED BANDEDGE (802.11n (20MHz) MODE,CH1, HORIZONTAL)

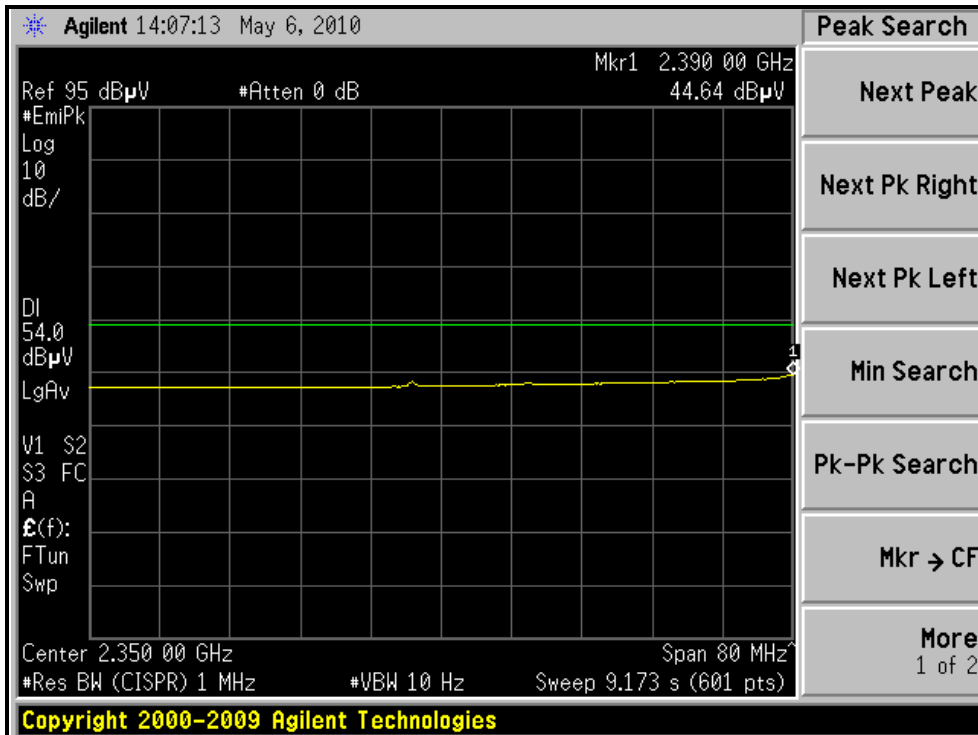
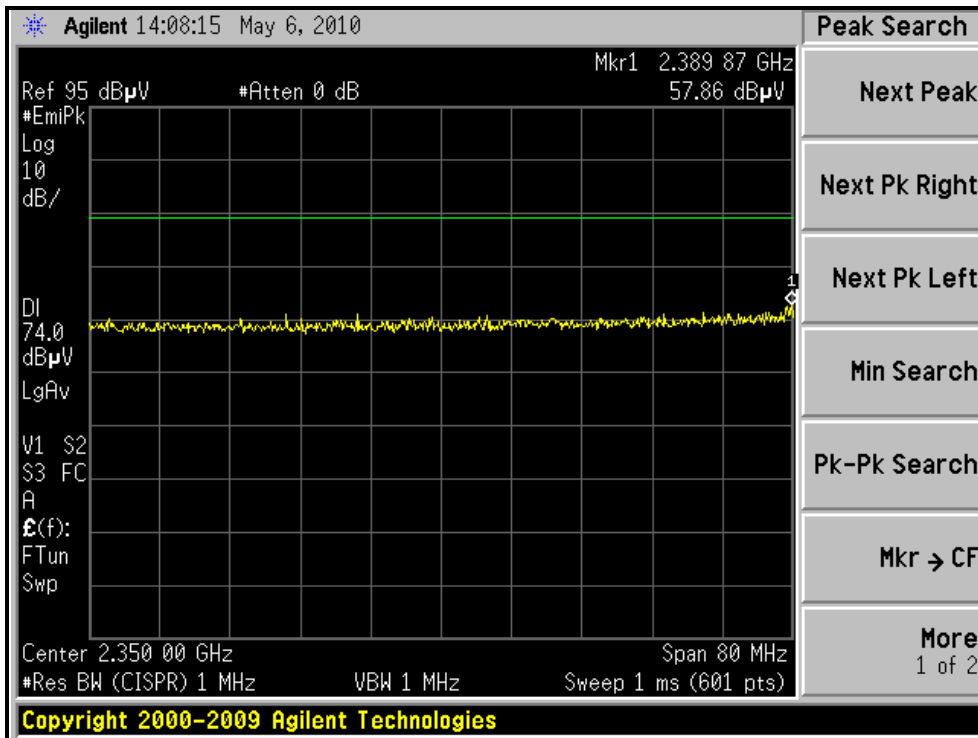



A D T

RESTRICTED BANDEDGE (802.11n (20MHz) MODE,CH1, VERTICAL)

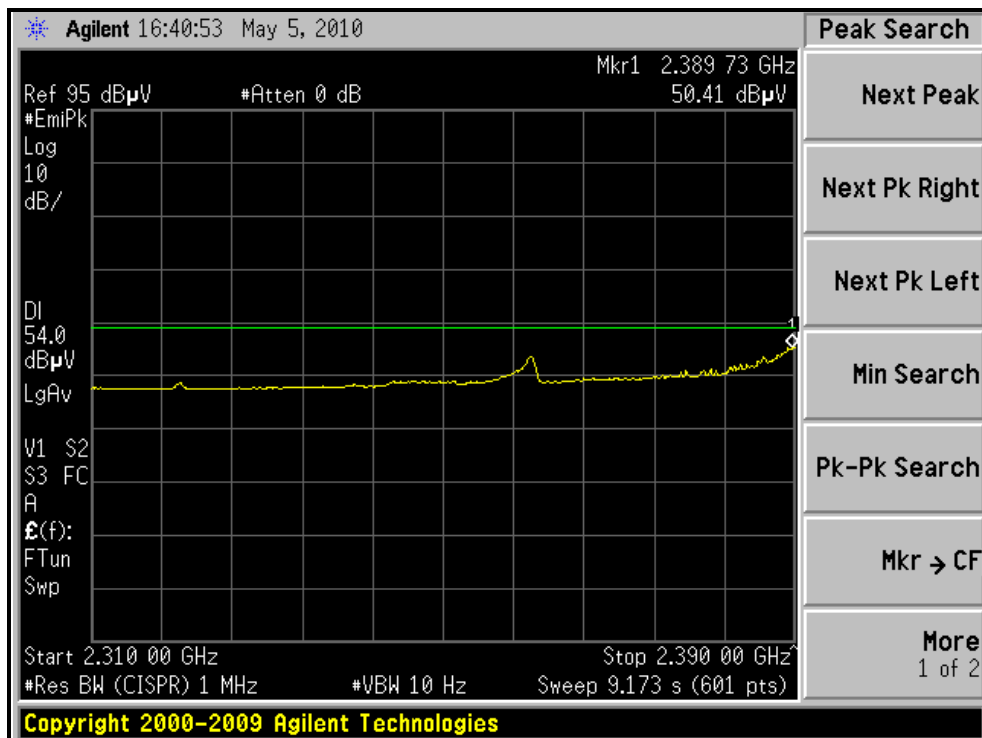
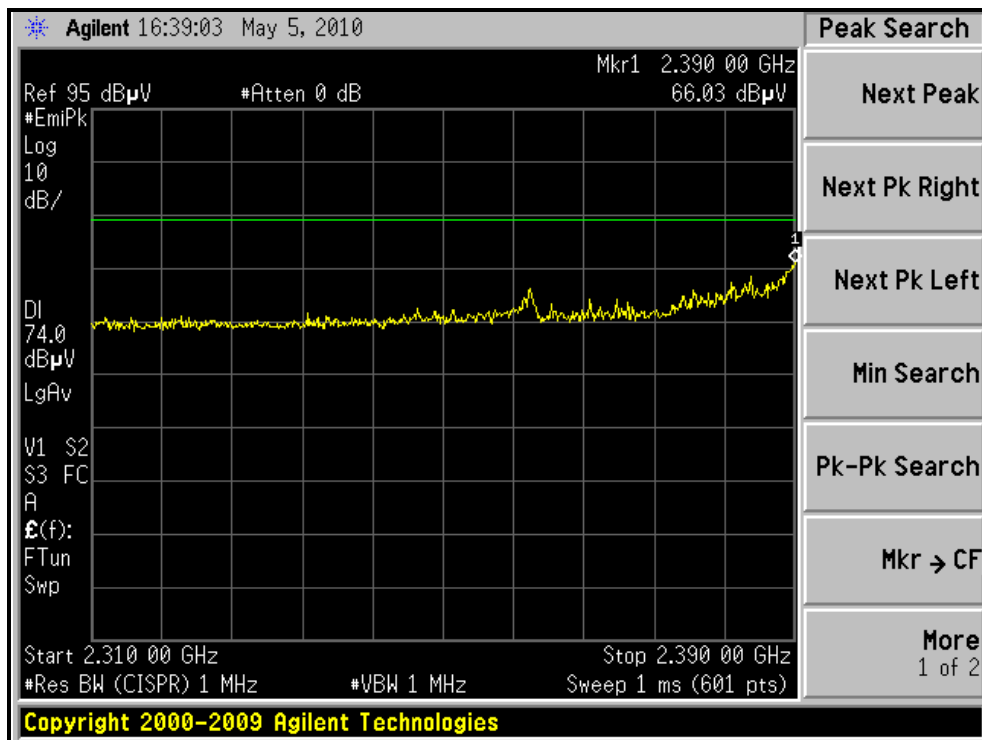



A D T

RESTRICTED BANDEDGE (802.11n (20MHz) MODE,CH11, HORIZONTAL)

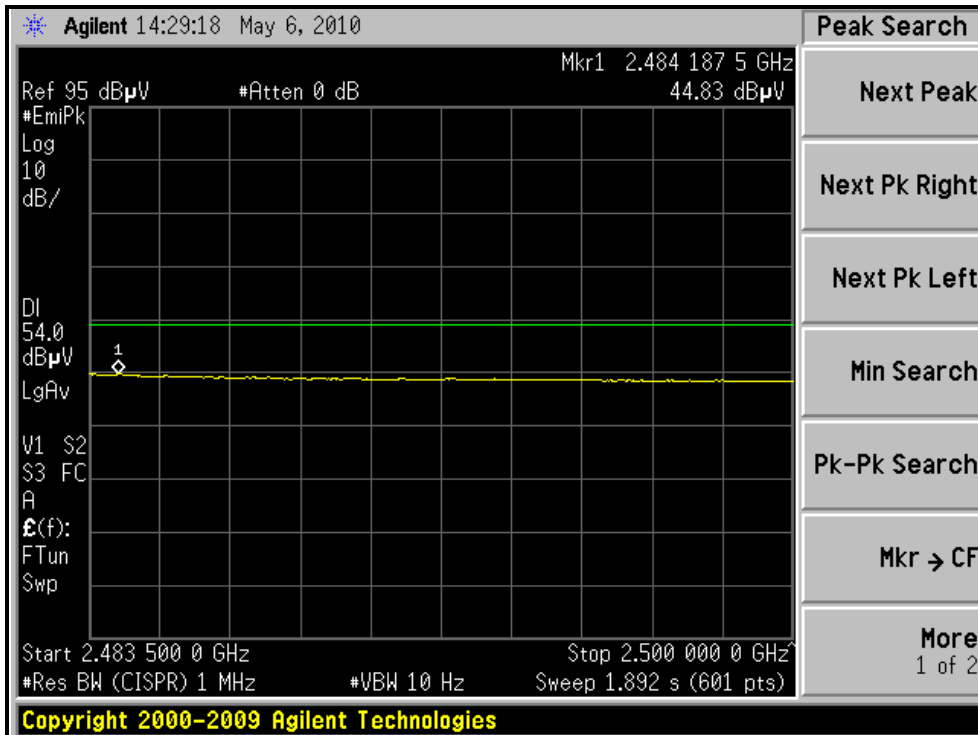
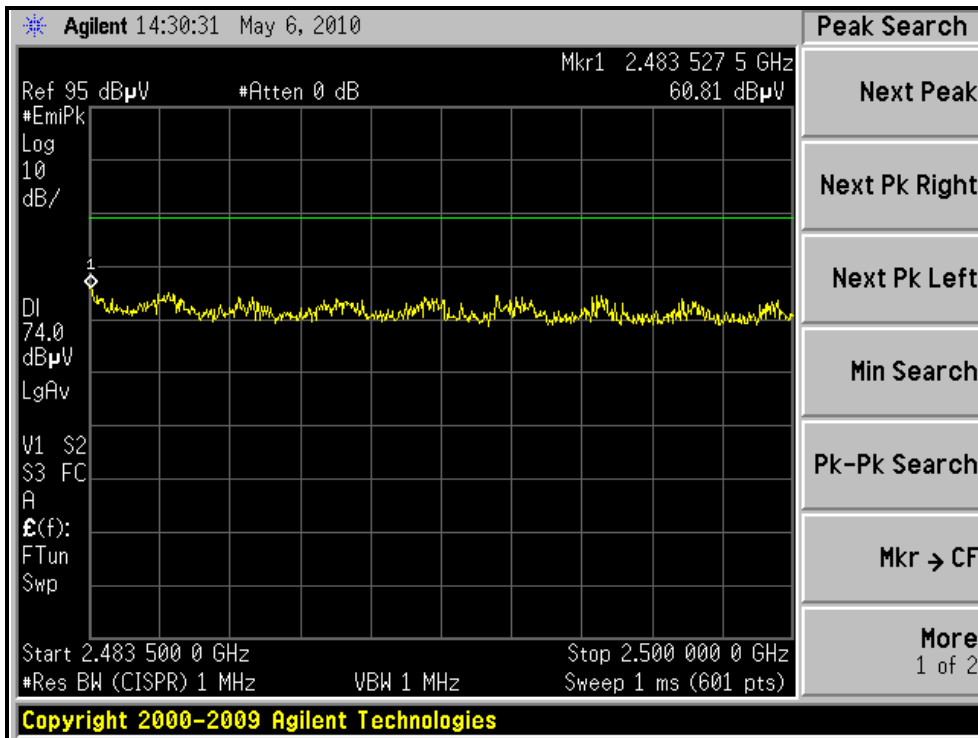



A D T

RESTRICTED BANDEDGE (802.11n (20MHz) MODE,CH11, VERTICAL)

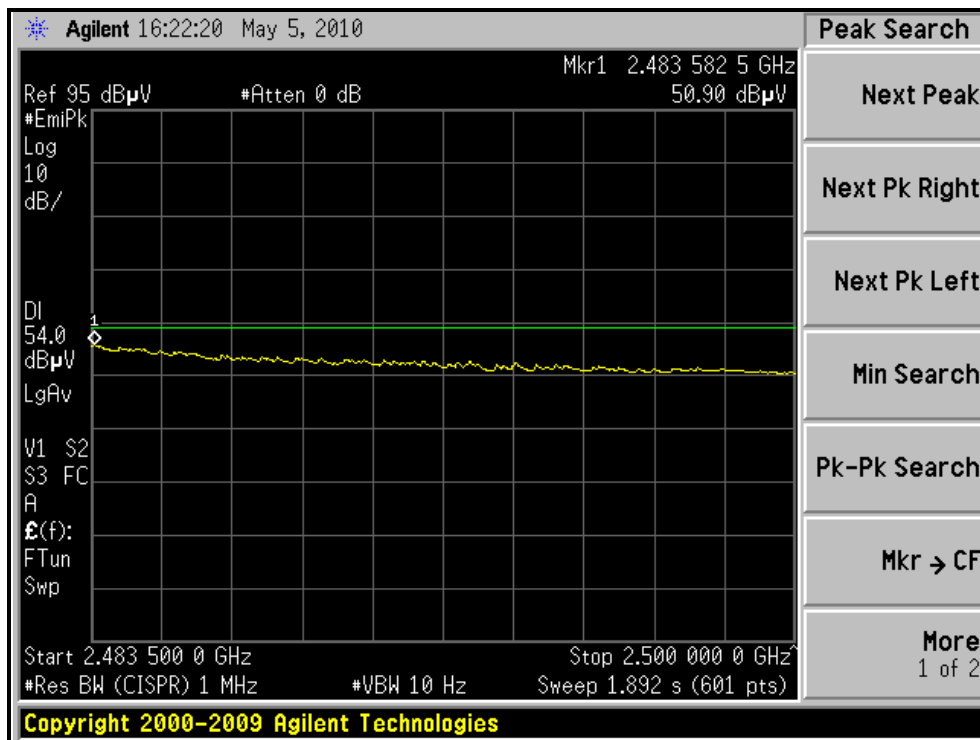
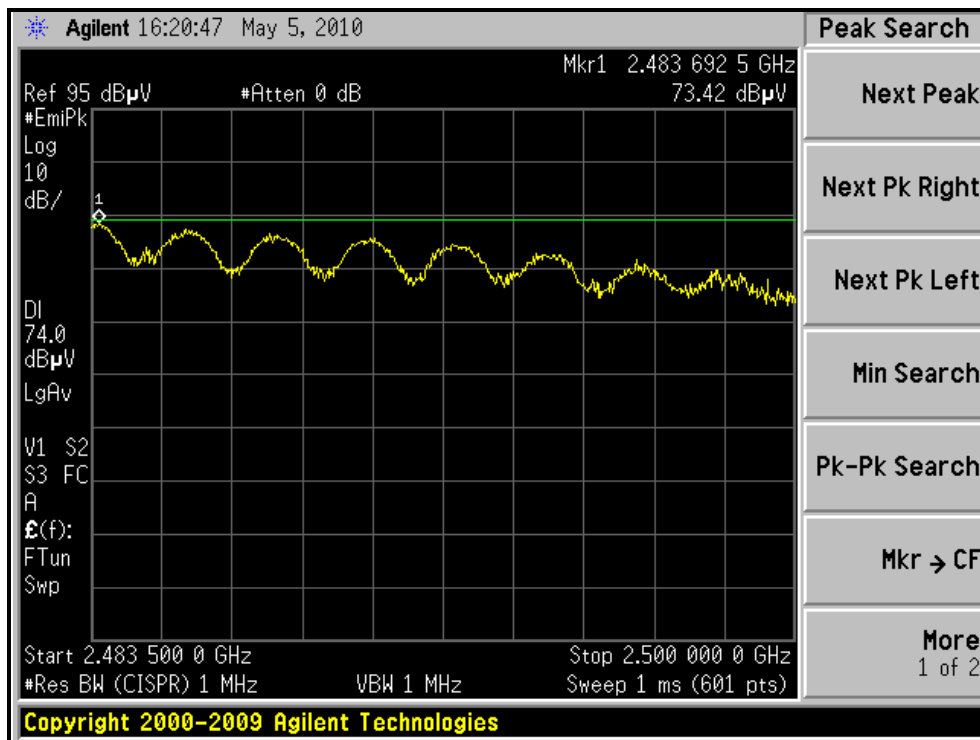



802.11n (40MHz) OFDM MODULATION

EUT TEST CONDITION		MEASUREMENT DETAIL	
CHANNEL	Channel 1	FREQUENCY RANGE	1 ~ 25GHz
INPUT POWER (SYSTEM)	120Vac, 60 Hz	DETECTOR FUNCTION	Peak (PK) Average (AV)
ENVIRONMENTAL CONDITIONS	23deg. C, 68%RH 1015 hPa	TESTED BY	Duke Tseng

ANTENNA POLARITY & TEST DISTANCE: HORIZONTAL AT 3 M								
NO.	FREQ. (MHz)	EMISSION LEVEL (dBuV/m)	LIMIT (dBuV/m)	MARGIN (dB)	ANTENNA HEIGHT (m)	TABLE ANGLE (Degree)	RAW VALUE (dBuV)	CORRECTION FACTOR (dB/m)
1	2390.00	57.6 PK	74.00	-16.4	1.13 H	216	26.40	31.21
2	2390.00	45.3 AV	54.00	-8.7	1.13 H	216	14.13	31.21
3	*2422.00	90.5 PK			1.16 H	218	59.24	31.30
4	*2422.00	81.9 AV			1.16 H	218	50.59	31.30
5	4844.00	46.5 PK	74.00	-27.5	1.29 H	65	7.04	39.50
6	4844.00	34.6 AV	54.00	-19.4	1.29 H	65	-4.89	39.50
7	7266.00	50.4 PK	74.00	-23.6	1.33 H	75	6.30	44.06
8	7266.00	38.3 AV	54.00	-15.7	1.33 H	75	-5.80	44.06

ANTENNA POLARITY & TEST DISTANCE: VERTICAL AT 3 M								
NO.	FREQ. (MHz)	EMISSION LEVEL (dBuV/m)	LIMIT (dBuV/m)	MARGIN (dB)	ANTENNA HEIGHT (m)	TABLE ANGLE (Degree)	RAW VALUE (dBuV)	CORRECTION FACTOR (dB/m)
1	2390.00	67.8 PK	74.00	-6.2	1.16 V	22	36.60	31.21
2	2390.00	53.4 AV	54.00	-0.6	1.16 V	22	22.23	31.21
3	*2422.00	102.5 PK			1.13 V	21	71.20	31.30
4	*2422.00	93.3 AV			1.13 V	21	62.02	31.30
5	4844.00	46.3 PK	74.00	-27.7	1.00 V	105	6.76	39.50
6	4844.00	34.2 AV	54.00	-19.9	1.00 V	105	-5.35	39.50
7	7266.00	50.7 PK	74.00	-23.3	1.54 V	116	6.62	44.06
8	7266.00	38.3 AV	54.00	-15.7	1.54 V	116	-5.72	44.06

- REMARKS:**
1. Emission level (dBuV/m) = Raw Value (dBuV) + Correction Factor (dB/m).
 2. Correction Factor (dB/m) = Antenna Factor (dB/m) + Cable Factor (dB).
 3. The other emission levels were very low against the limit.
 4. Margin value = Emission level – Limit value.
 5. “ * “: Fundamental frequency.



A D T

EUT TEST CONDITION		MEASUREMENT DETAIL	
CHANNEL	Channel 4	FREQUENCY RANGE	1 ~ 25GHz
INPUT POWER (SYSTEM)	120Vac, 60 Hz	DETECTOR FUNCTION	Peak (PK) Average (AV)
ENVIRONMENTAL CONDITIONS	23deg. C, 68%RH 1015 hPa	TESTED BY	Duke Tseng

ANTENNA POLARITY & TEST DISTANCE: HORIZONTAL AT 3 M

NO.	FREQ. (MHz)	EMISSION LEVEL (dBuV/m)	LIMIT (dBuV/m)	MARGIN (dB)	ANTENNA HEIGHT (m)	TABLE ANGLE (Degree)	RAW VALUE (dBuV)	CORRECTION FACTOR (dB/m)
1	*2437.00	97.6 PK			1.15 H	217	66.24	31.34
2	*2437.00	88.0 AV			1.15 H	217	56.70	31.34
3	4874.00	49.7 PK	74.00	-24.4	1.26 H	66	10.03	39.62
4	4874.00	38.3 AV	54.00	-15.7	1.26 H	66	-1.30	39.62
5	7311.00	51.1 PK	74.00	-22.9	1.32 H	78	6.96	44.10
6	7311.00	38.6 AV	54.00	-15.4	1.32 H	78	-5.51	44.10

ANTENNA POLARITY & TEST DISTANCE: VERTICAL AT 3 M

NO.	FREQ. (MHz)	EMISSION LEVEL (dBuV/m)	LIMIT (dBuV/m)	MARGIN (dB)	ANTENNA HEIGHT (m)	TABLE ANGLE (Degree)	RAW VALUE (dBuV)	CORRECTION FACTOR (dB/m)
1	2390.00	73.0 PK	74.00	-1.0	1.16 V	23	41.79	31.21
2	2390.00	53.2 AV	54.00	-0.8	1.16 V	23	21.99	31.21
3	*2437.00	107.3 PK			1.14 V	21	76.00	31.34
4	*2437.00	98.1 AV			1.14 V	21	66.76	31.34
5	2483.50	71.5 PK	74.00	-2.5	1.13 V	27	40.08	31.46
6	2483.50	52.7 AV	54.00	-1.3	1.13 V	27	21.24	31.46
7	4874.00	49.2 PK	74.00	-24.8	1.00 V	109	9.60	39.62
8	4874.00	37.2 AV	54.00	-16.8	1.00 V	109	-2.39	39.62
9	7311.00	51.4 PK	74.00	-22.6	1.53 V	114	7.30	44.10
10	7311.00	39.1 AV	54.00	-14.9	1.53 V	114	-4.98	44.10

- REMARKS:**
1. Emission level (dBuV/m) = Raw Value (dBuV) + Correction Factor (dB/m).
 2. Correction Factor (dB/m) = Antenna Factor (dB/m) + Cable Factor (dB).
 3. The other emission levels were very low against the limit.
 4. Margin value = Emission level – Limit value.
 5. “ * “: Fundamental frequency.



A D T

EUT TEST CONDITION		MEASUREMENT DETAIL	
CHANNEL	Channel 7	FREQUENCY RANGE	1 ~ 25GHz
INPUT POWER (SYSTEM)	120Vac, 60 Hz	DETECTOR FUNCTION	Peak (PK) Average (AV)
ENVIRONMENTAL CONDITIONS	23deg. C, 68%RH 1015 hPa	TESTED BY	Duke Tseng

ANTENNA POLARITY & TEST DISTANCE: HORIZONTAL AT 3 M								
NO.	FREQ. (MHz)	EMISSION LEVEL (dBuV/m)	LIMIT (dBuV/m)	MARGIN (dB)	ANTENNA HEIGHT (m)	TABLE ANGLE (Degree)	RAW VALUE (dBuV)	CORRECTION FACTOR (dB/m)
1	*2452.00	91.1 PK			1.14 H	218	59.72	31.38
2	*2452.00	82.4 AV			1.14 H	218	51.04	31.38
3	2483.50	59.2 PK	74.00	-14.8	1.14 H	218	27.74	31.46
4	2483.50	45.4 AV	54.00	-8.6	1.14 H	218	13.98	31.46
5	4904.00	46.7 PK	74.00	-27.3	1.28 H	67	6.98	39.74
6	4904.00	34.6 AV	54.00	-19.4	1.28 H	67	-5.10	39.74
7	7356.00	50.9 PK	74.00	-23.1	1.32 H	80	6.74	44.15
8	7356.00	38.5 AV	54.00	-15.5	1.32 H	80	-5.65	44.15
ANTENNA POLARITY & TEST DISTANCE: VERTICAL AT 3 M								
NO.	FREQ. (MHz)	EMISSION LEVEL (dBuV/m)	LIMIT (dBuV/m)	MARGIN (dB)	ANTENNA HEIGHT (m)	TABLE ANGLE (Degree)	RAW VALUE (dBuV)	CORRECTION FACTOR (dB/m)
1	*2452.00	101.9 PK			1.12 V	21	70.55	31.38
2	*2452.00	92.8 AV			1.12 V	21	61.46	31.38
3	2483.53	64.8 PK	74.00	-9.2	1.13 V	28	33.34	31.46
4	2483.53	52.4 AV	54.00	-1.6	1.13 V	28	20.98	31.46
5	4904.00	46.4 PK	74.00	-27.6	1.00 V	106	6.68	39.74
6	4904.00	34.4 AV	54.00	-19.6	1.00 V	106	-5.37	39.74
7	7356.00	51.0 PK	74.00	-23.0	1.52 V	113	6.85	44.15
8	7356.00	38.6 AV	54.00	-15.4	1.52 V	113	-5.58	44.15

- REMARKS:**
1. Emission level (dBuV/m) = Raw Value (dBuV) + Correction Factor (dB/m).
 2. Correction Factor (dB/m) = Antenna Factor (dB/m) + Cable Factor (dB).
 3. The other emission levels were very low against the limit.
 4. Margin value = Emission level – Limit value.
 5. “ * “: Fundamental frequency.



A D T

RESTRICTED BANDEDGE (802.11n (40MHz) MODE,CH1, HORIZONTAL)

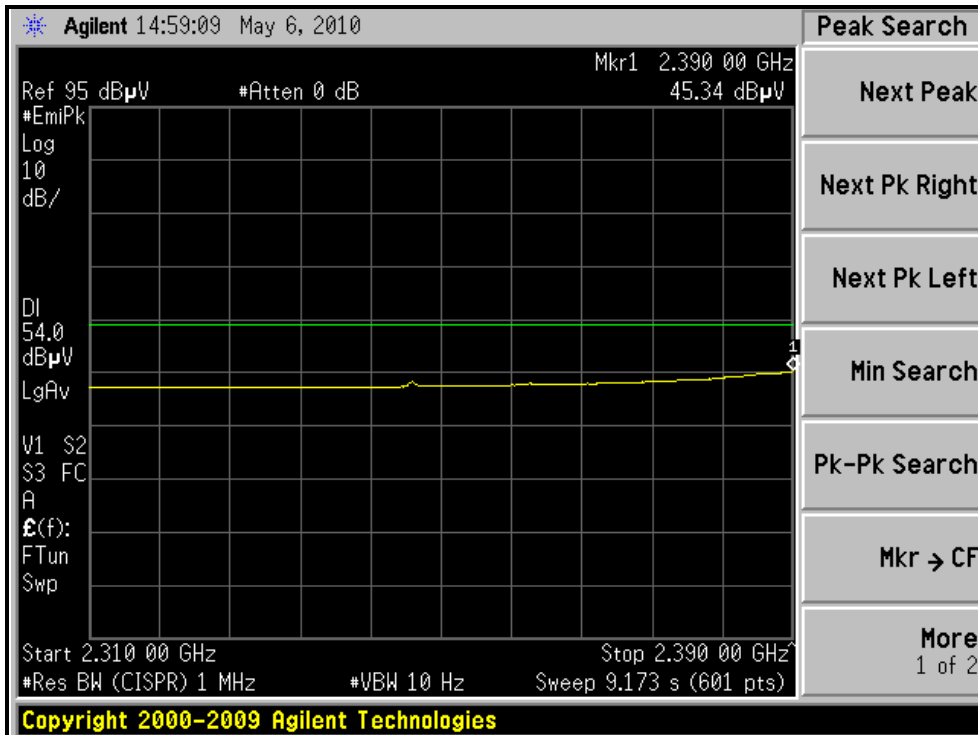
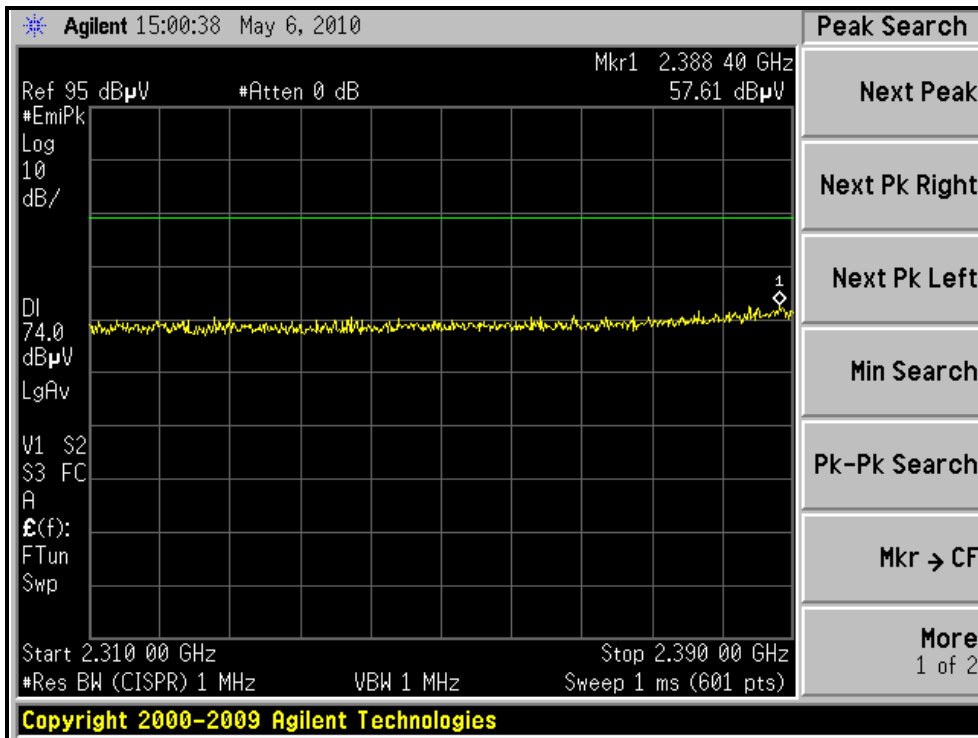



A D T

RESTRICTED BANDEDGE (802.11n (40MHz) MODE,CH1, VERTICAL)

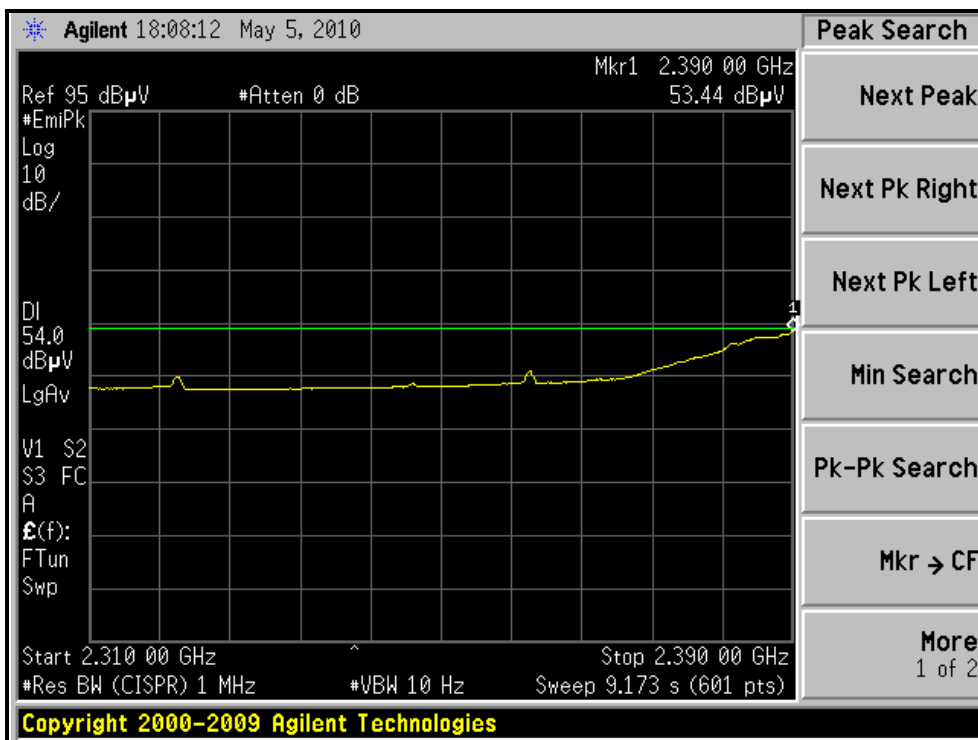
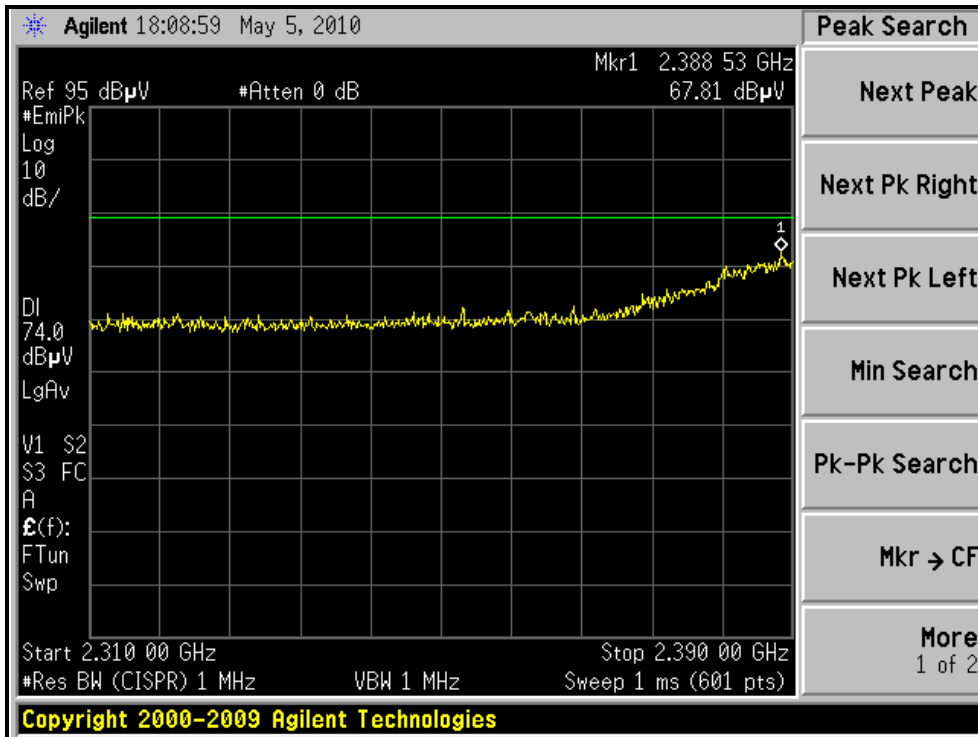



A D T

RESTRICTED BANDEDGE (802.11n (40MHz) MODE,CH7, HORIZONTAL)

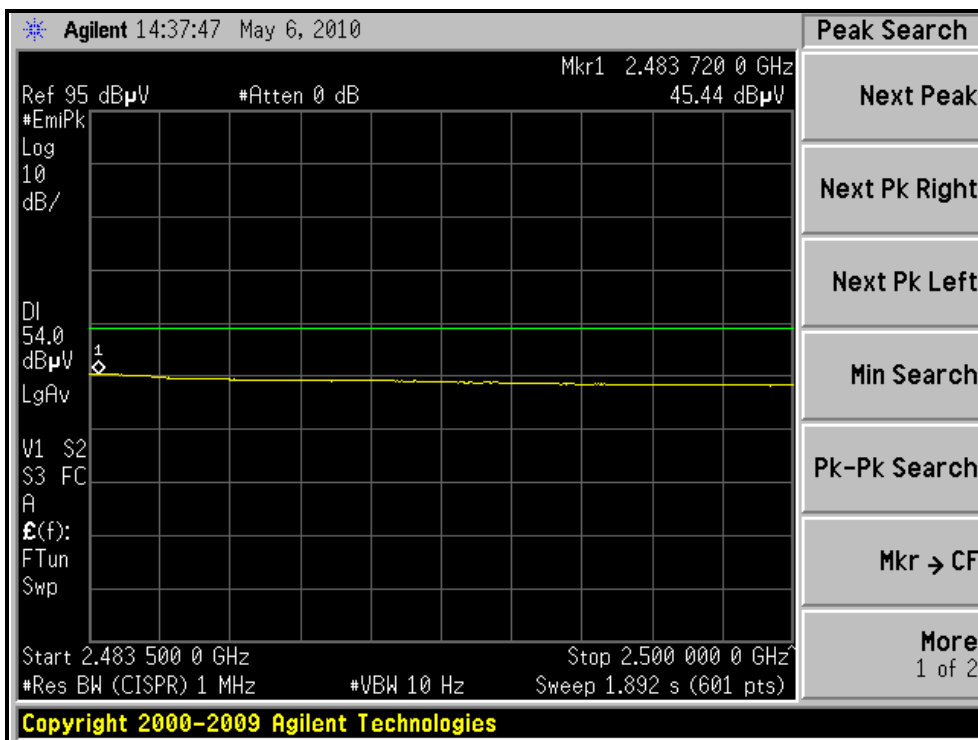
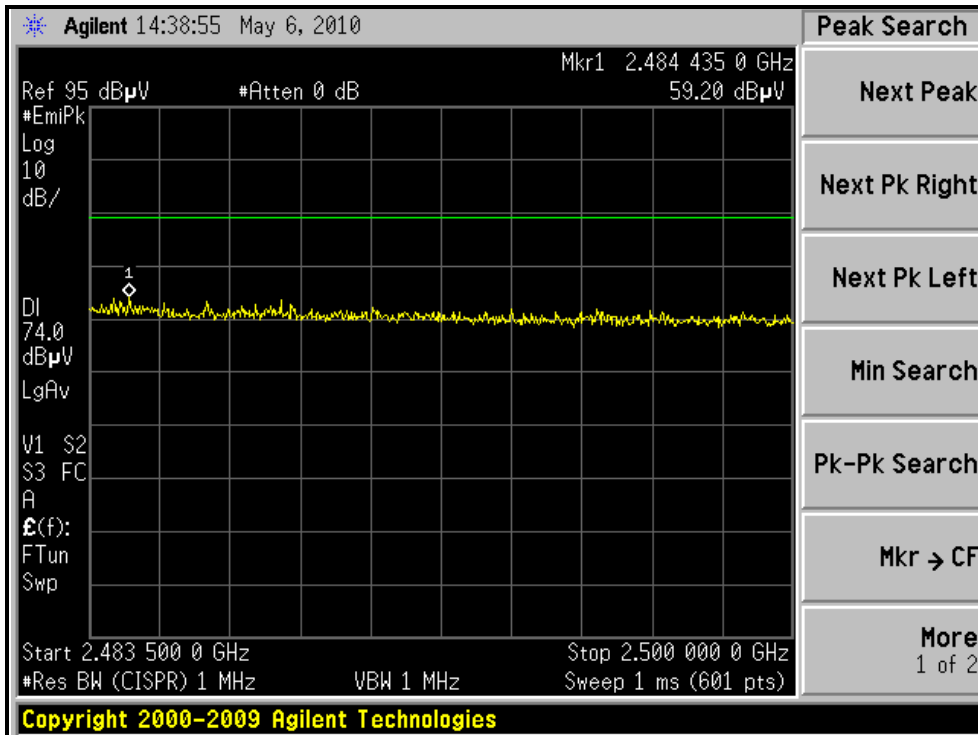



A D T

RESTRICTED BANDEDGE (802.11n (40MHz) MODE,CH7, VERTICAL)

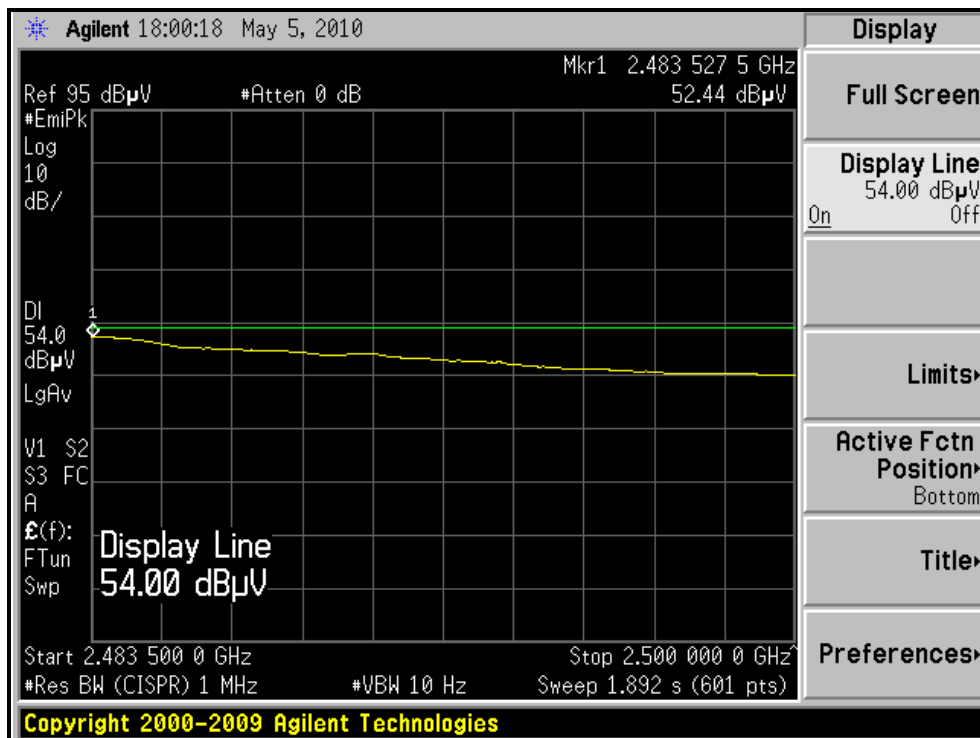
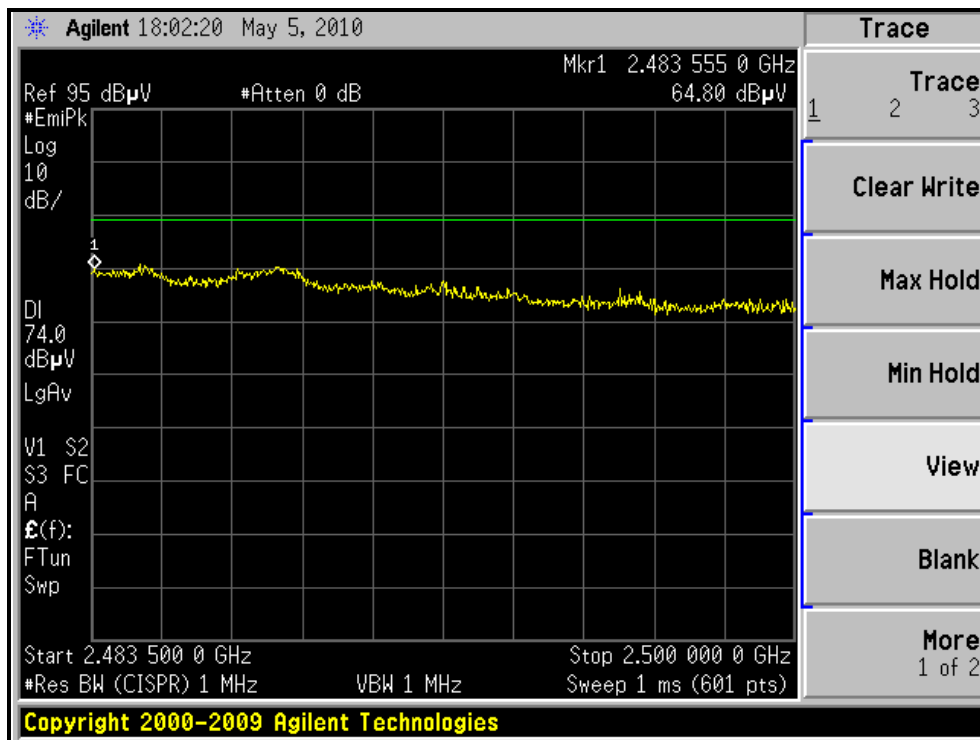

4.3 6dB BANDWIDTH MEASUREMENT

4.3.1 LIMITS OF 6dB BANDWIDTH MEASUREMENT

The minimum of 6dB Bandwidth Measurement is 0.5 MHz.

4.3.2 TEST INSTRUMENTS

DESCRIPTION & MANUFACTURER	MODEL NO.	SERIAL NO.	CALIBRATED DATE	CALIBRATED UNTIL
R&S SPECTRUM ANALYZER	FSP40	100037	Aug. 03, 2009	Aug. 02, 2010

NOTE:

- 1.The calibration interval of the above test instruments is 12 months and the calibrations are traceable to NML/ROC and NIST/USA.

4.3.3 TEST PROCEDURE

The transmitter output was connected to the spectrum analyzer through an attenuator. The bandwidth of the fundamental frequency was measured by spectrum analyzer with 100kHz RBW and 100kHz VBW. The 6dB bandwidth is defined as the total spectrum the power of which is higher than peak power minus 6dB.

4.3.4 DEVIATION FROM TEST STANDARD

No deviation

4.3.5 TEST SETUP



4.3.6 EUT OPERATING CONDITIONS

The software provided by client to enable the EUT under transmission condition continuously at lowest, middle and highest channel frequencies individually.

4.3.7 TEST RESULTS

802.11b DSSS MODULATION:

CHANNEL	CHANNEL FREQUENCY (MHz)	6dB BANDWIDTH (MHz)	MINIMUM LIMIT (MHz)	PASS / FAIL
1	2412	11.58	0.5	PASS
6	2437	11.76	0.5	PASS
11	2462	11.93	0.5	PASS

CH11

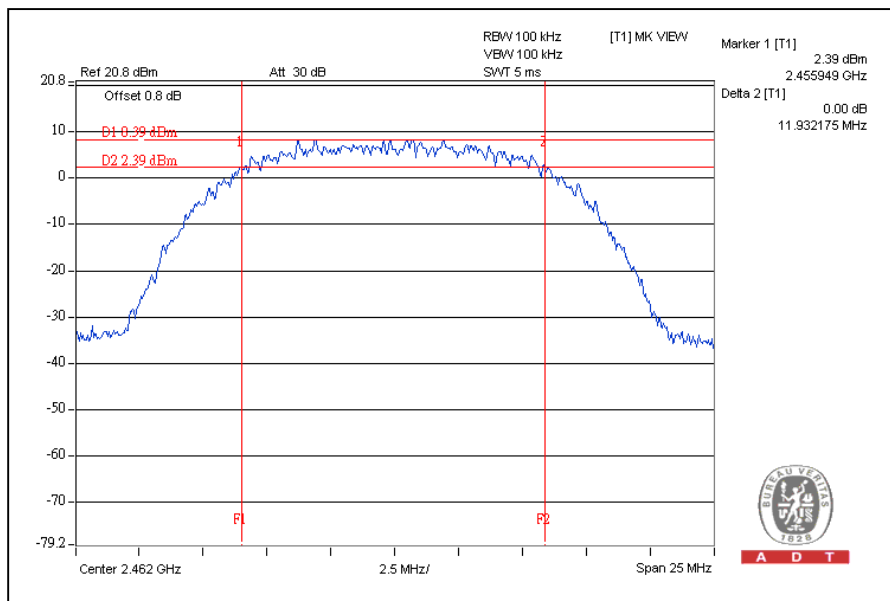

802.11g OFDM MODULATION:

CHANNEL	CHANNEL FREQUENCY (MHz)	6dB BANDWIDTH (MHz)	MINIMUM LIMIT (MHz)	PASS / FAIL
1	2412	16.54	0.5	PASS
6	2437	16.55	0.5	PASS
11	2462	16.55	0.5	PASS

CH11

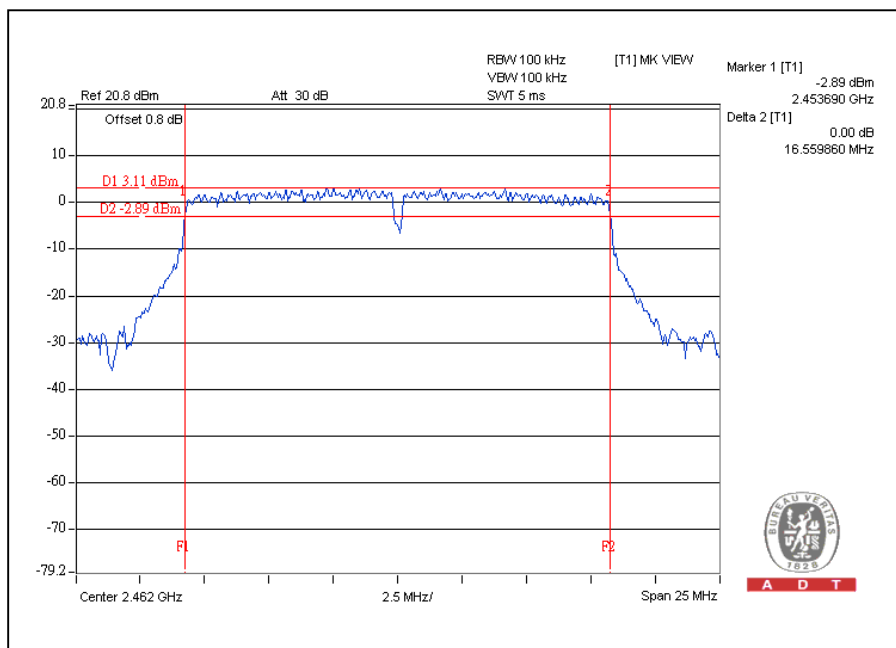



A D T

802.11n (20MHz) OFDM MODULATION:

CHANNEL	CHANNEL FREQUENCY (MHz)	6dB BANDWIDTH (MHz)	MINIMUM LIMIT (MHz)	PASS / FAIL
1	2412	16.56	0.5	PASS
6	2437	16.58	0.5	PASS
11	2462	16.54	0.5	PASS

CH6

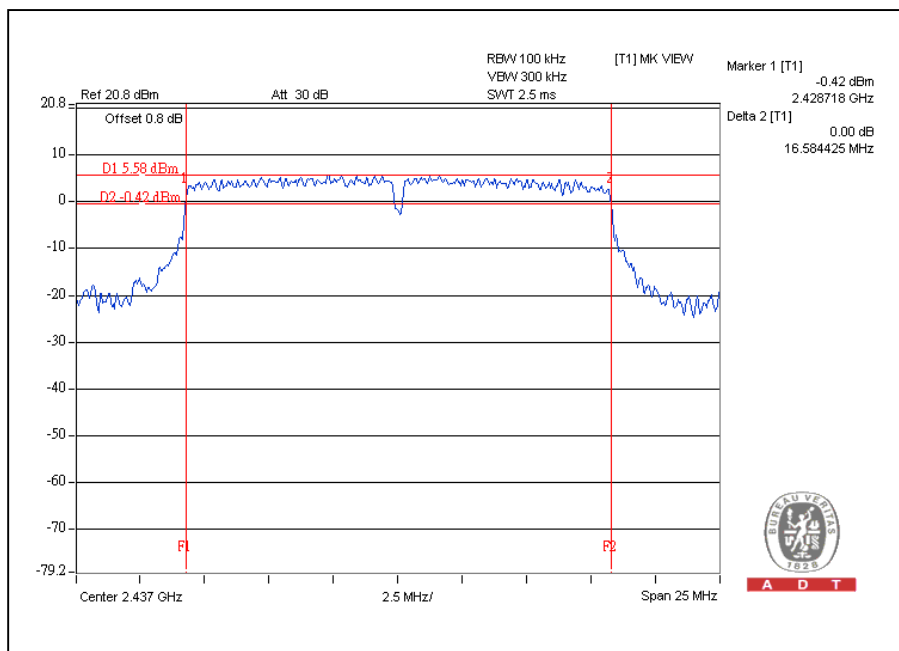

802.11n (40MHz) OFDM MODULATION:

CHANNEL	CHANNEL FREQUENCY (MHz)	6dB BANDWIDTH (MHz)	MINIMUM LIMIT (MHz)	PASS / FAIL
1	2422	36.42	0.5	PASS
4	2437	36.48	0.5	PASS
7	2452	36.49	0.5	PASS

CH7

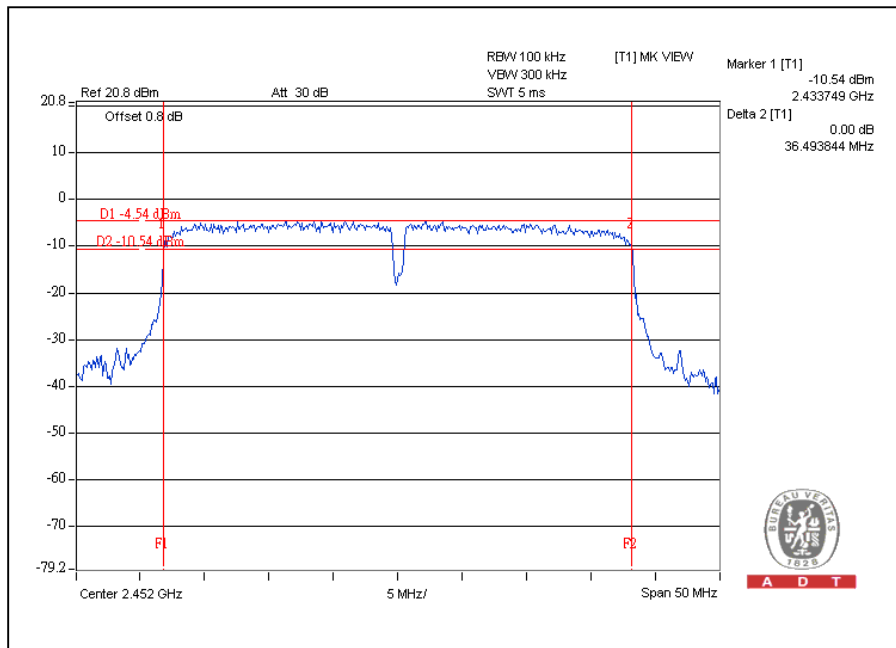

4.4 MAXIMUM PEAK OUTPUT POWER

4.4.1 LIMITS OF MAXIMUM PEAK OUTPUT POWER MEASUREMENT

The Maximum Peak Output Power Measurement is 30dBm.

4.4.2 INSTRUMENTS

DESCRIPTION & MANUFACTURER	MODEL NO.	SERIAL NO.	CALIBRATED DATE	CALIBRATED UNTIL
Anritsu Power Meter	ML2495A	0824006	April 24, 2010	April 23, 2011
Pulse Power Sensor	MA2411B	0738172	April 24, 2010	April 23, 2011

NOTE:

The calibration interval of the above test instruments is 12 months and the calibrations are traceable to NML/ROC and NIST/USA.

4.4.3 TEST PROCEDURES

1. The transmitter output was connected to the power meter through an attenuator; the bandwidth of the fundamental frequency was measured with the power meter.
2. Record the power level.

4.4.4 DEVIATION FROM TEST STANDARD

No deviation

4.4.5 TEST SETUP

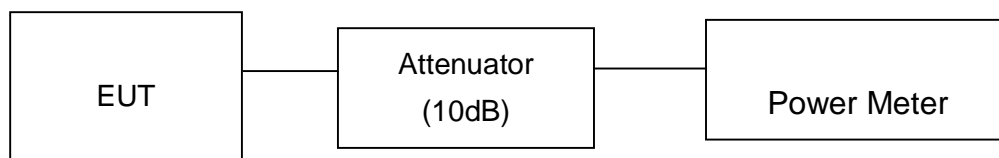

4.4.6 EUT OPERATING CONDITIONS

Same as Item 4.3.6



A D T

4.4.7 TEST RESULTS

802.11b DSSS MODULATION:

CHANNEL	CHANNEL FREQUENCY (MHz)	PEAK POWER OUTPUT (dBm)	PEAK POWER OUTPUT (mW)	PEAK POWER LIMIT (dBm)	PASS / FAIL
1	2412	19.9	97.7	30	PASS
6	2437	21.2	131.8	30	PASS
11	2462	20.5	112.2	30	PASS

802.11g OFDM MODULATION:

CHANNEL	CHANNEL FREQUENCY (MHz)	PEAK POWER OUTPUT (dBm)	PEAK POWER OUTPUT (mW)	PEAK POWER LIMIT (dBm)	PASS / FAIL
1	2412	24.0	251.2	30	PASS
6	2437	26.8	478.6	30	PASS
11	2462	26.2	416.9	30	PASS

802.11n (20MHz) OFDM MODULATION:

CHANNEL	CHANNEL FREQUENCY (MHz)	PEAK POWER OUTPUT (dBm)	PEAK POWER OUTPUT (mW)	PEAK POWER LIMIT (dBm)	PASS / FAIL
1	2412	24.0	251.2	30	PASS
6	2437	26.8	478.6	30	PASS
11	2462	26.0	398.1	30	PASS



A D T

802.11n (40MHz) OFDM MODULATION:

CHANNEL	CHANNEL FREQUENCY (MHz)	PEAK POWER OUTPUT (dBm)	PEAK POWER OUTPUT (mW)	PEAK POWER LIMIT (dBm)	PASS / FAIL
1	2422	22.6	182.0	30	PASS
4	2437	26.5	446.7	30	PASS
7	2452	21.0	125.9	30	PASS

4.5 POWER SPECTRAL DENSITY MEASUREMENT

4.5.1 LIMITS OF POWER SPECTRAL DENSITY MEASUREMENT

The Maximum of Power Spectral Density Measurement is 8dBm.

4.5.2 TEST INSTRUMENTS

DESCRIPTION & MANUFACTURER	MODEL NO.	SERIAL NO.	CALIBRATED DATE	CALIBRATED UNTIL
R&S SPECTRUM ANALYZER	FSP40	100037	Aug. 03, 2009	Aug. 02, 2010

NOTE:

- 1.The calibration interval of the above test instruments is 12 months and the calibrations are traceable to NML/ROC and NIST/USA.

4.5.3 TEST PROCEDURE

The transmitter output was connected to the spectrum analyzer through an attenuator, the bandwidth of the fundamental frequency was measured with the spectrum analyzer using 3kHz RBW and 30kHz VBW, set sweep time = span/3kHz.

The power spectral density was measured and recorded.

The sweep time is allowed to be longer than span/3kHz for a full response of the mixer in the spectrum analyzer.

4.5.4 DEVIATION FROM TEST STANDARD

No deviation

4.5.5 TEST SETUP

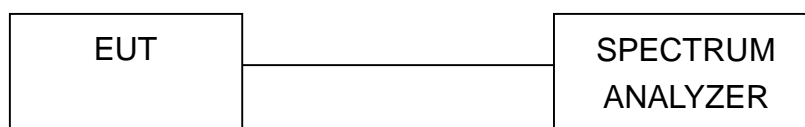

4.5.6 EUT OPERATING CONDITION

Same as Item 4.3.6



A D T

4.5.7 TEST RESULTS

802.11b DSSS MODULATION:

CHANNEL	CHANNEL FREQUENCY (MHz)	RF POWER LEVEL IN 3kHz BW (dBm)	MAXIMUM LIMIT (dBm)	PASS / FAIL
1	2412	-6.4	8	PASS
6	2437	-5.3	8	PASS
11	2462	-4.4	8	PASS

CH11

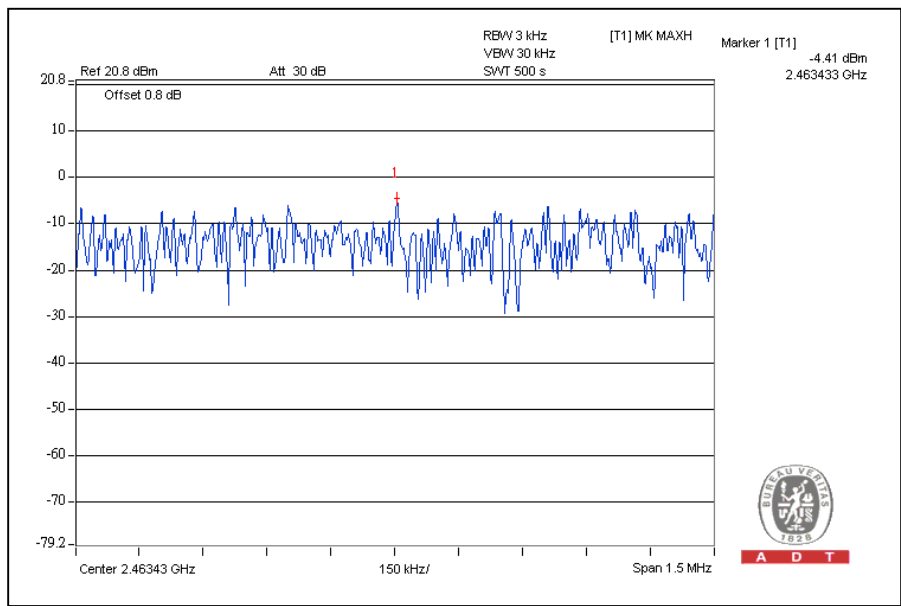



A D T

802.11g OFDM MODULATION:

CHANNEL	CHANNEL FREQUENCY (MHz)	RF POWER LEVEL IN 3kHz BW (dBm)	MAXIMUM LIMIT (dBm)	PASS / FAIL
1	2412	-11.6	8	PASS
6	2437	-8.1	8	PASS
11	2462	-11.2	8	PASS

CH6

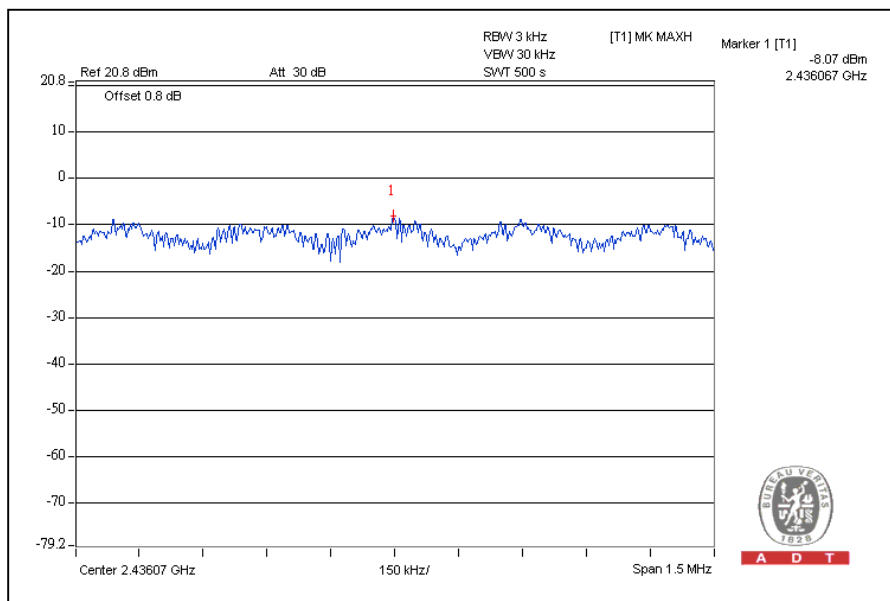



A D T

802.11n (20MHz) OFDM MODULATION:

CHANNEL	CHANNEL FREQUENCY (MHz)	RF POWER LEVEL IN 3kHz BW (dBm)	MAXIMUM LIMIT (dBm)	PASS / FAIL
1	2412	-11.8	8	PASS
6	2437	-8.2	8	PASS
11	2462	-10.8	8	PASS

CH6

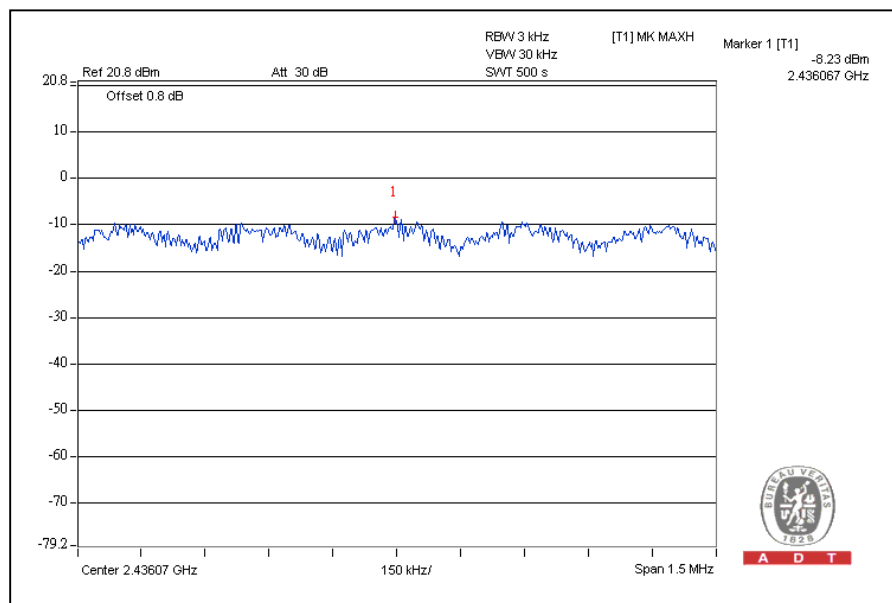



A D T

802.11n (40MHz) OFDM MODULATION:

CHANNEL	CHANNEL FREQUENCY (MHz)	RF POWER LEVEL IN 3kHz BW (dBm)	MAXIMUM LIMIT (dBm)	PASS / FAIL
1	2422	-15.6	8	PASS
4	2437	-11.7	8	PASS
7	2452	-16.3	8	PASS

CH4

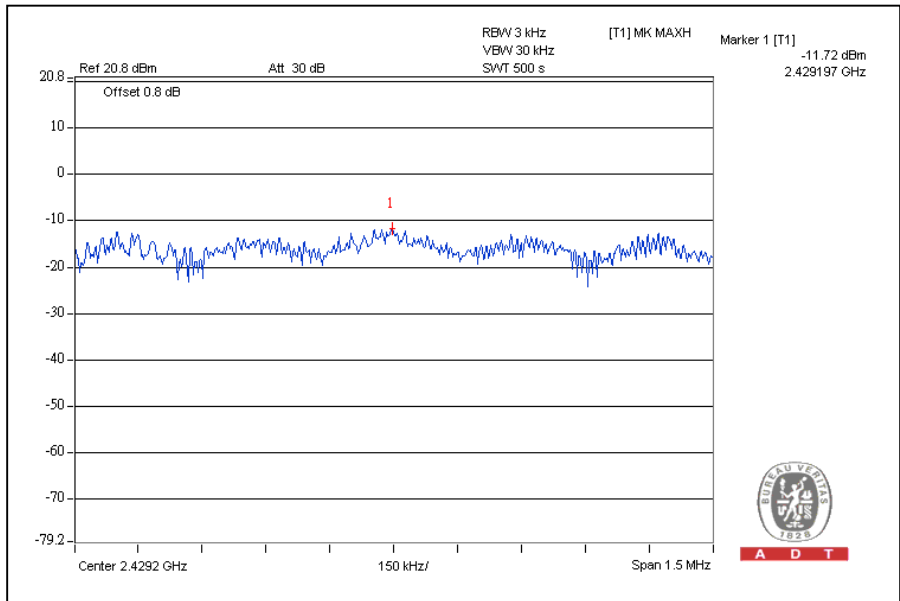

4.6 CONDUCTED OUT-BAND EMISSION MEASUREMENT

4.6.1 LIMITS OF CONDUCTED OUT-BAND EMISSION MEASUREMENT

Below -20dB of the highest emission level of operating band (in 100kHz Resolution Bandwidth).

4.6.2 TEST INSTRUMENTS

DESCRIPTION & MANUFACTURER	MODEL NO.	SERIAL NO.	CALIBRATED DATE	CALIBRATED UNTIL
R&S SPECTRUM ANALYZER	FSP40	100037	Aug. 03, 2009	Aug. 02, 2010

NOTE:

1. The calibration interval of the above test instruments is 12 months and the calibrations are traceable to NML/ROC and NIST/USA.

4.6.3 TEST PROCEDURE

The transmitter output was connected to the spectrum analyzer via a low loss cable. Set RBW of spectrum analyzer to 100kHz and VBW of spectrum analyzer to 300kHz with suitable frequency span including 100 MHz bandwidth from band edge. The band edges was measured and recorded.

The spectrum plots (RBW = 100kHz, VBW = 300kHz) are attached on the following pages.

4.6.4 DEVIATION FROM TEST STANDARD

No deviation

4.6.5 EUT OPERATING CONDITION

Same as Item 4.3.6

4.6.6 TEST RESULTS

The spectrum plots are attached on the following images. D1 line indicates the highest level, and D2 line indicates the 20dB offset below D1. It shows compliance with the requirement in part 15.247(d).

802.11b DSSS MODULATION:

CH1

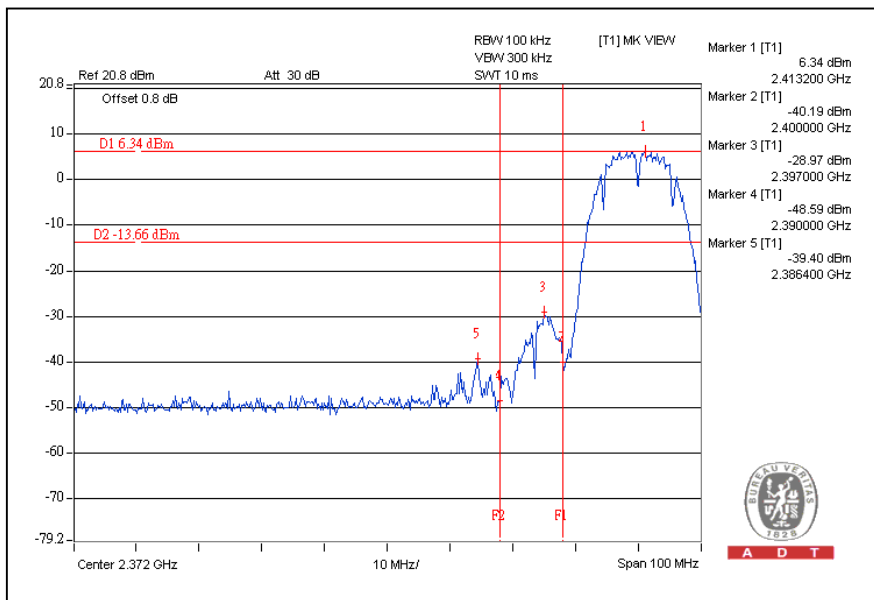

CH11

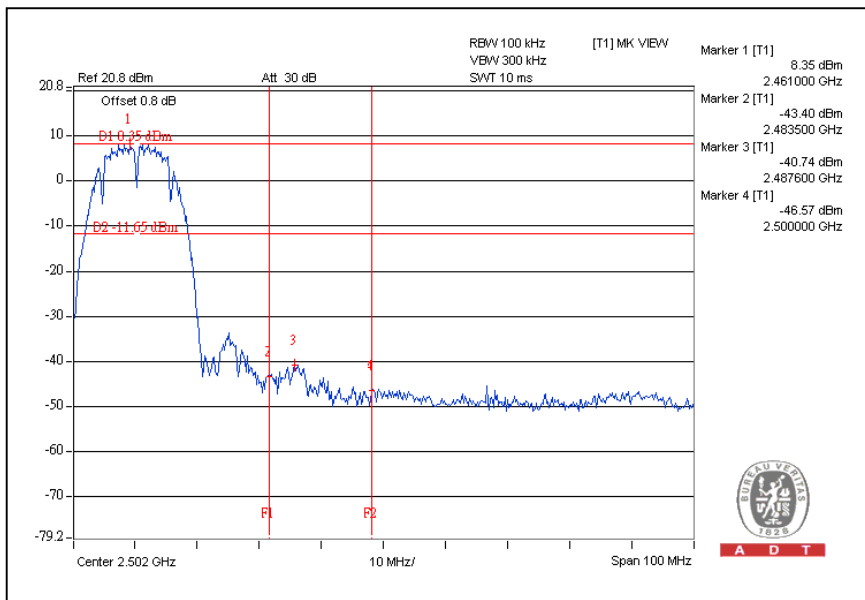



A D T

CH1

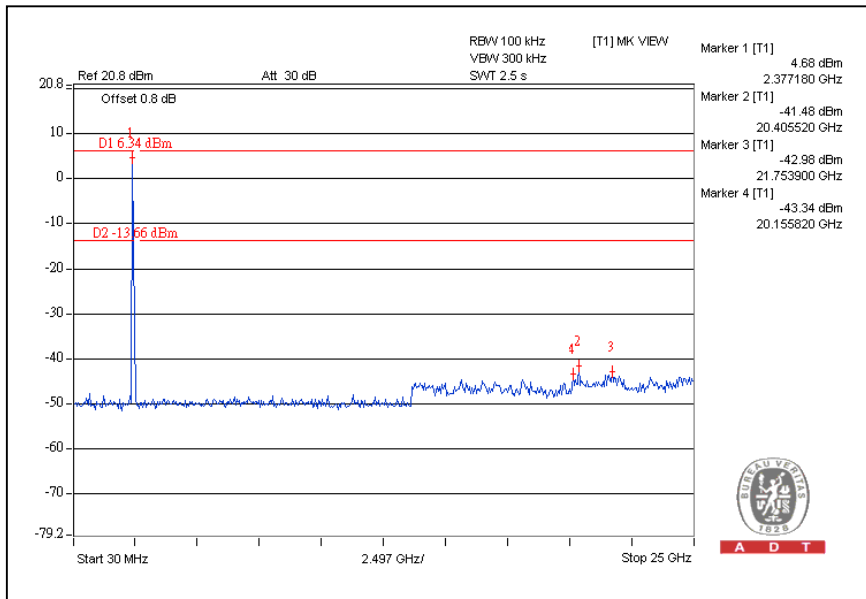

CH11

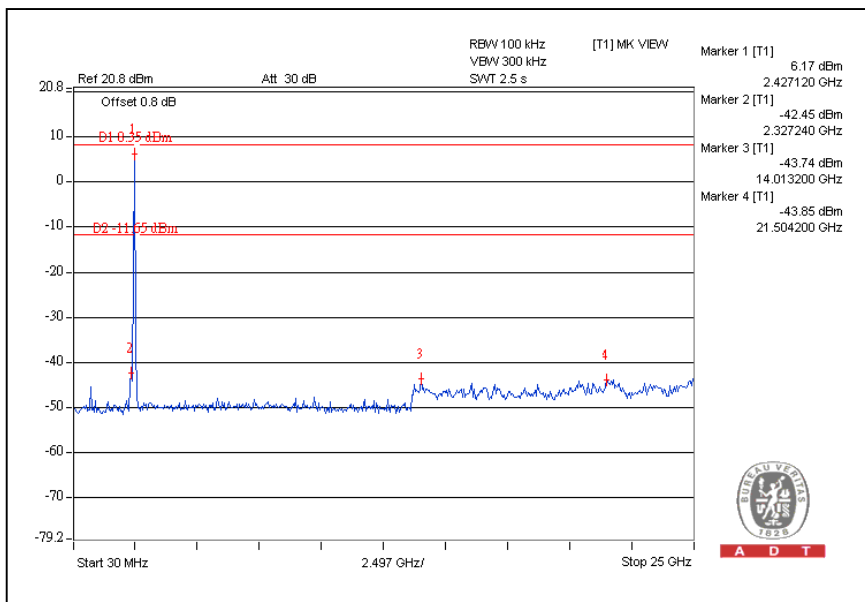

802.11g OFDM MODULATION:

CH1

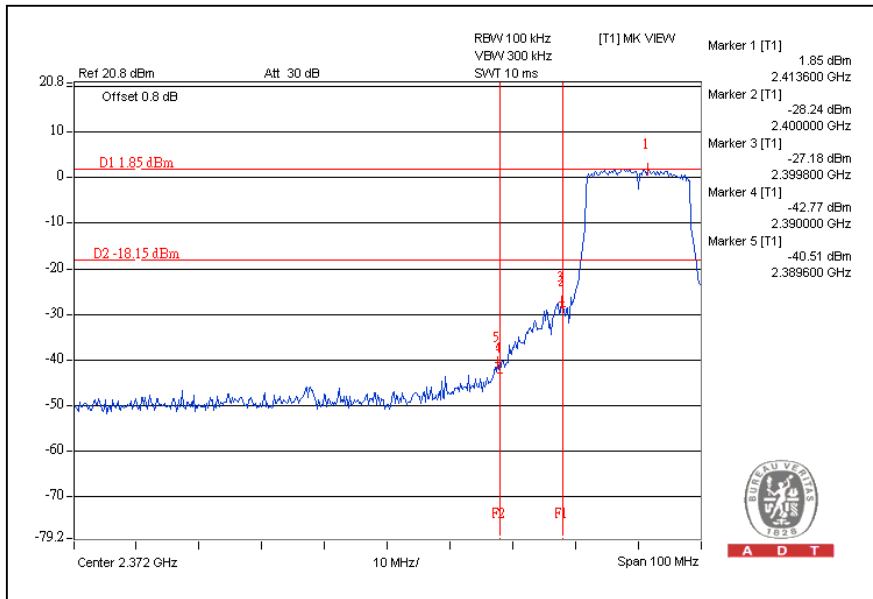

CH11

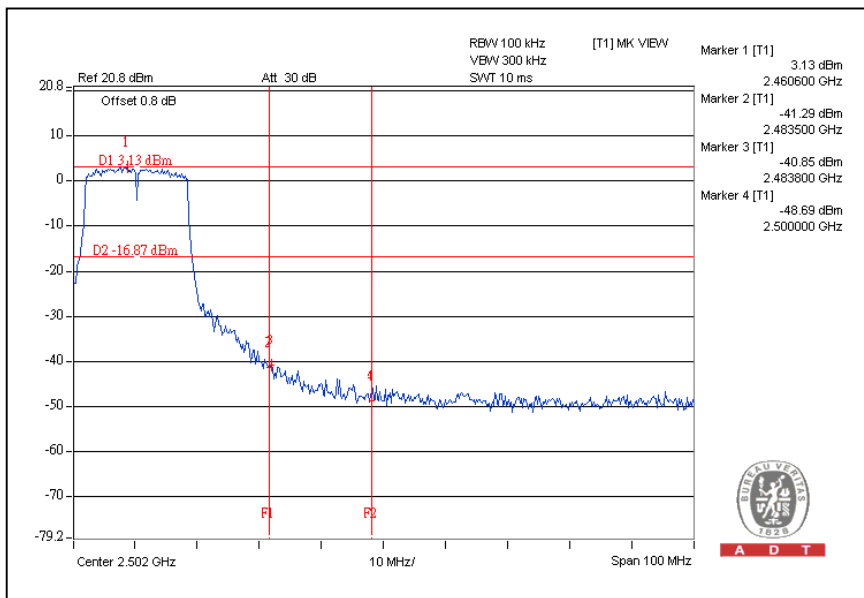



A D T

CH1

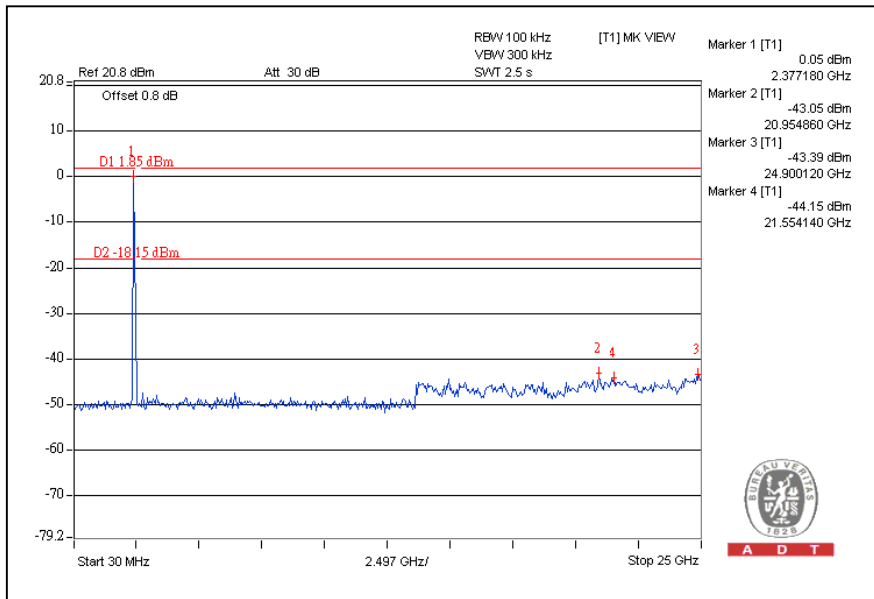

CH11

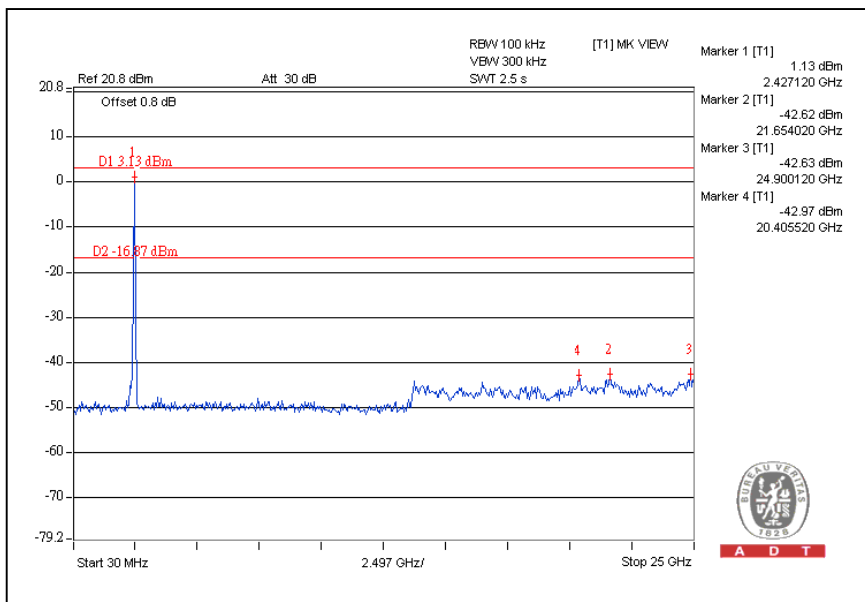

802.11n (20MHz) OFDM MODULATION:

CH1

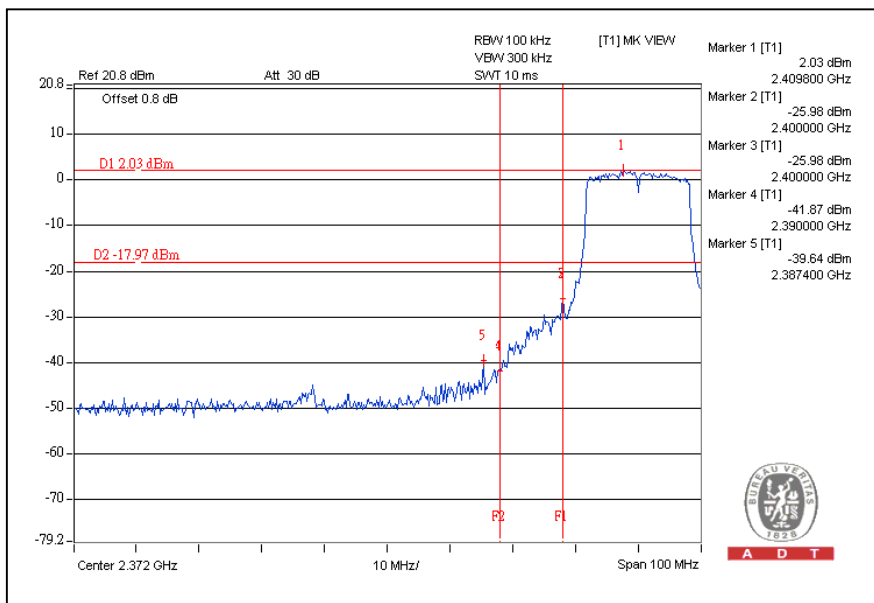

CH11

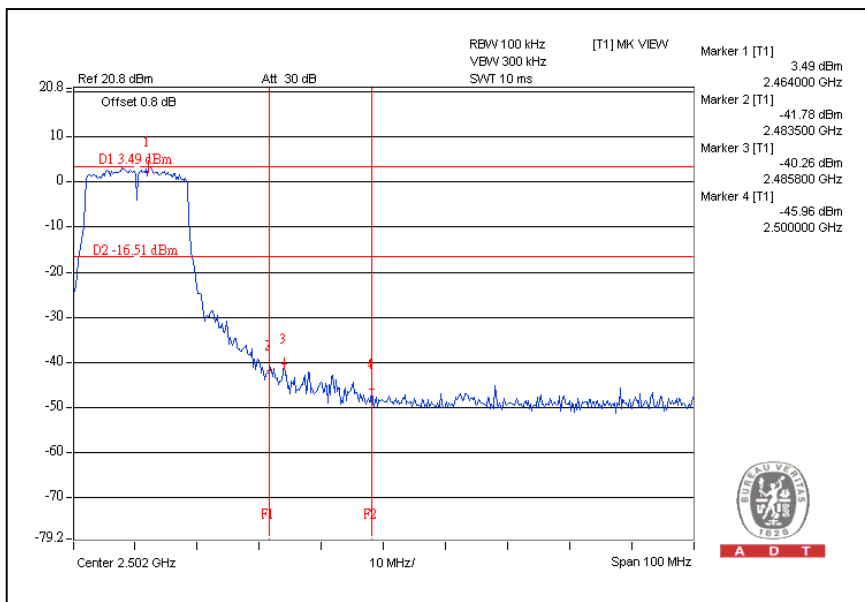



A D T

CH1

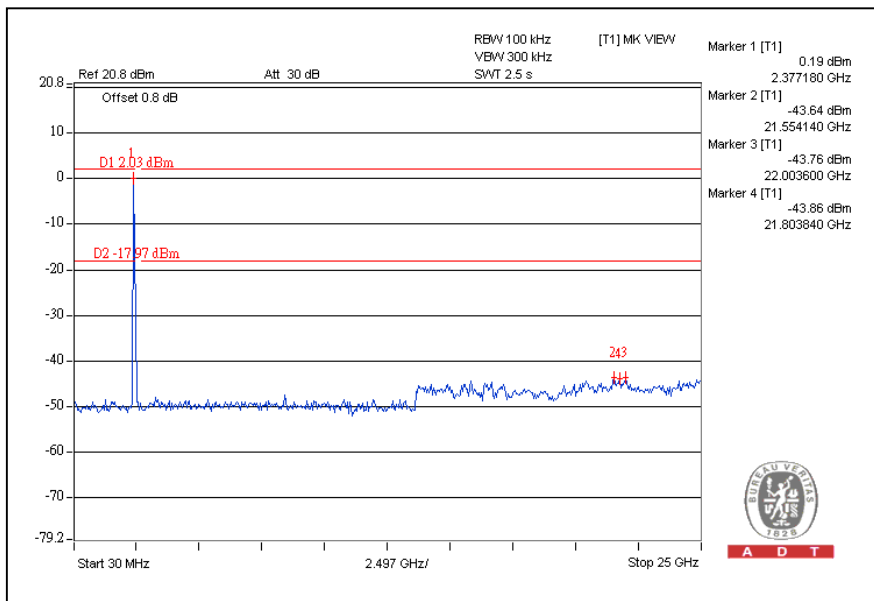

CH11

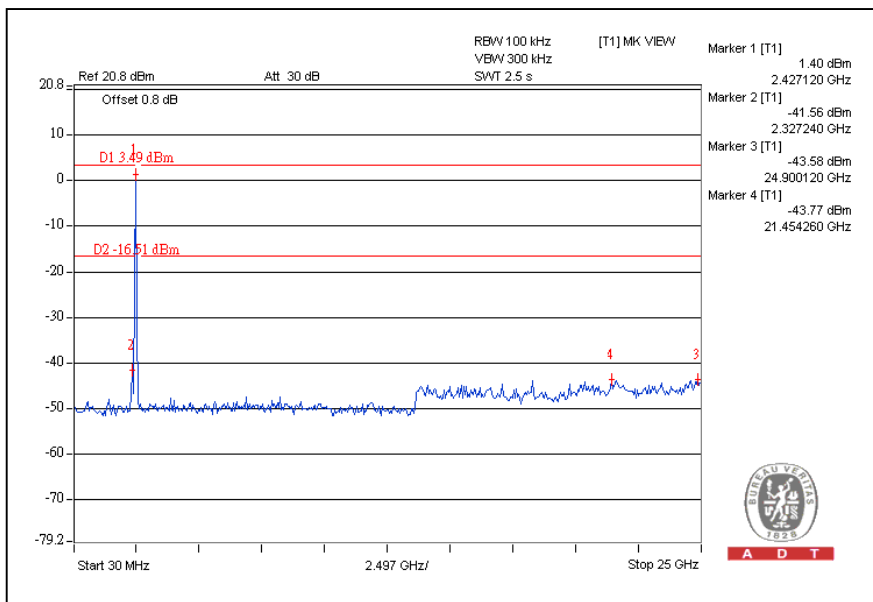

802.11n (40MHz) OFDM MODULATION:

CH1

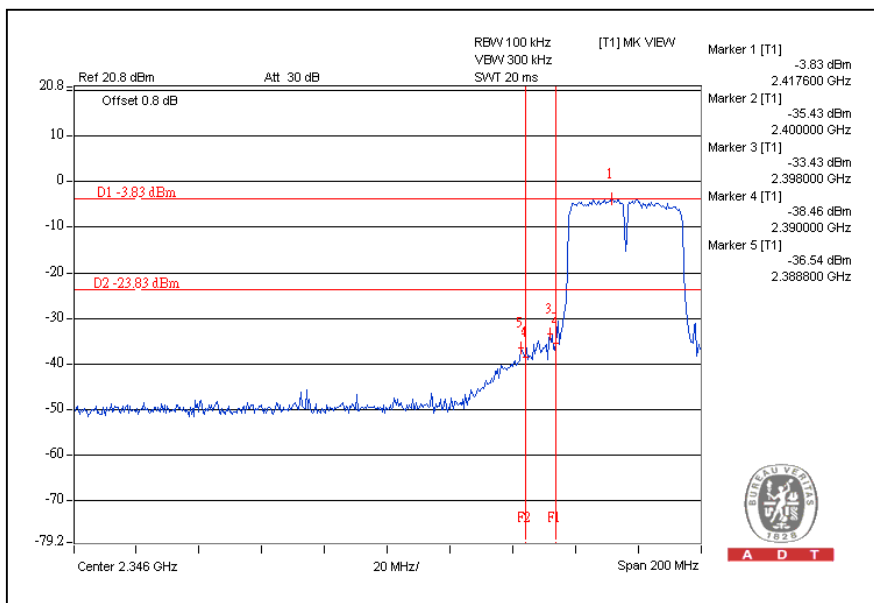

CH7

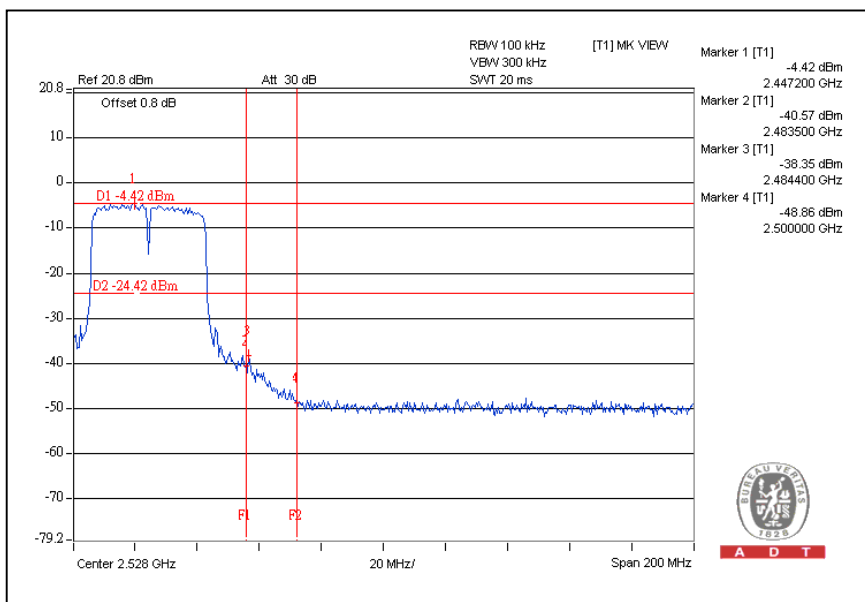



A D T

CH1

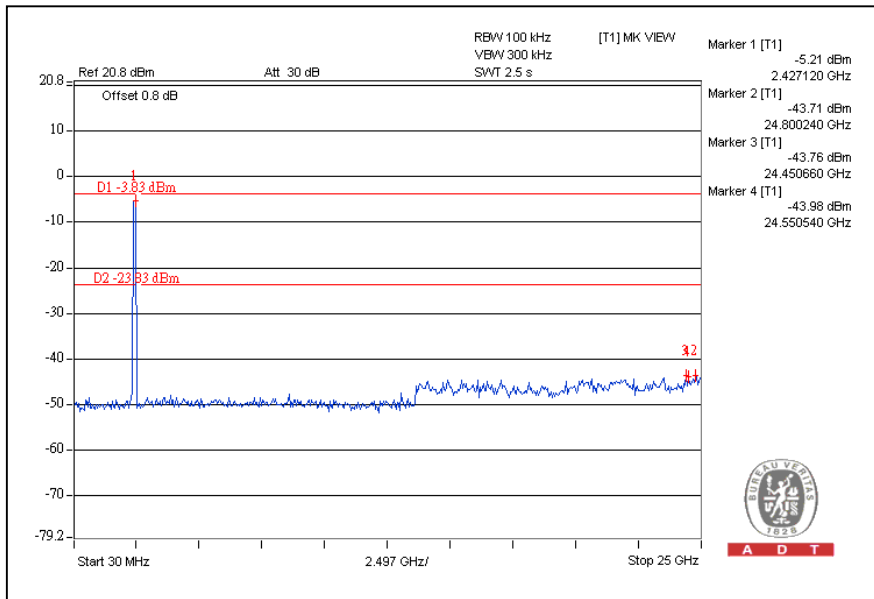

CH7

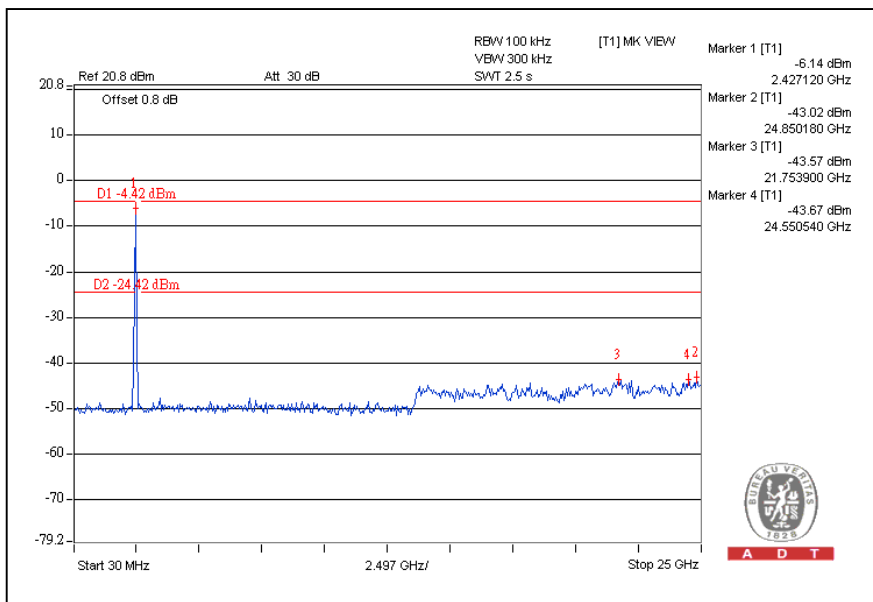



5. INFORMATION ON THE TESTING LABORATORIES

We, Bureau Veritas Consumer Products Services (H.K.) Ltd., Taoyuan Branch, were founded in 1988 to provide our best service in EMC, Radio, Telecom and Safety consultation. Our laboratories are accredited and approved according to ISO/IEC 17025:

Copies of accreditation certificates of our laboratories obtained from approval agencies can be downloaded from our web site: www.adt.com.tw/index.5/phtml.

If you have any comments, please feel free to contact us at the following:

Linko EMC/RF Lab:

Tel: 886-2-26052180

Fax: 886-2-26052943

Hsin Chu EMC/RF Lab:

Tel: 886-3-5935343

Fax: 886-3-5935342

Hwa Ya EMC/RF/Safety/Telecom Lab:

Tel: 886-3-3183232

Fax: 886-3-3185050

Email: service@adt.com.tw

Web Site: www.adt.com.tw

The address and road map of all our labs can be found in our web site also.



A D T

6.APPENDIX A - MODIFICATIONS RECORDERS FOR ENGINEERING CHANGES TO THE EUT BY THE LAB

No any modifications are made to the EUT by the lab during the test.

--- END ---