



## FCC 47 CFR PART 15 SUBPART C

### TEST REPORT

For

**Wireless AC Day/Night HD Mini Bullet Cloud Camera**

**Model: DCS-7000L**

**Trade Name: D-Link**

*Issued to*

**D-Link Corporation**

**NO. 289, Sinhu 3rd Rd., Neihu District, Taipei City 114, Taiwan, R.O.C.**

*Issued by*

**Compliance Certification Services Inc.**

**No.81-1, Lane 210, Bade 2nd Rd., Lujhu Township,**

**Taoyuan County 33841, Taiwan, R.O.C.**

**TEL: 886-3-324-0332**

**FAX: 886-3-324-5235**

**<http://www.ccsrf.com>**

**[service@ccsrf.com](mailto:service@ccsrf.com)**



**Note:** This report shall not be reproduced except in full, without the written approval of Compliance Certification Services Inc. This document may be altered or revised by Compliance Certification Services Inc. personnel only, and shall be noted in the revision section of the document. The client should not use it to claim product endorsement by TAF, A2LA, NIST or any government agencies. The test results in the report only apply to the tested sample.



**Revision History**

Rev.	Issue Date	Revisions	Effect Page	Revised By
00	September 17, 2014	Initial Issue	All	Iren Wang



## TABLE OF CONTENTS

<b>1</b>	<b>TEST RESULT CERTIFICATION</b> .....	<b>4</b>
<b>2</b>	<b>EUT DESCRIPTION</b> .....	<b>5</b>
<b>3</b>	<b>TEST METHODOLOGY</b> .....	<b>6</b>
3.1	EUT CONFIGURATION.....	6
3.2	EUT EXERCISE .....	6
3.3	GENERAL TEST PROCEDURES .....	6
3.4	FCC PART 15.205 RESTRICTED BANDS OF OPERATIONS .....	7
3.5	DESCRIPTION OF TEST MODES.....	8
<b>4</b>	<b>INSTRUMENT CALIBRATION</b> .....	<b>9</b>
4.1	MEASURING INSTRUMENT CALIBRATION.....	9
4.2	MEASUREMENT EQUIPMENT USED .....	9
4.3	MEASUREMENT UNCERTAINTY .....	10
<b>5</b>	<b>FACILITIES AND ACCREDITATIONS</b> .....	<b>11</b>
5.1	FACILITIES.....	11
5.2	LABORATORY ACCREDITATIONS AND LISTING .....	11
5.3	TABLE OF ACCREDITATIONS AND LISTINGS.....	12
<b>6</b>	<b>SETUP OF EQUIPMENT UNDER TEST</b> .....	<b>13</b>
6.1	SETUP CONFIGURATION OF EUT.....	13
6.2	SUPPORT EQUIPMENT .....	13
<b>7</b>	<b>FCC PART 15 REQUIREMENTS</b> .....	<b>14</b>
7.1	6DB BANDWIDTH.....	14
7.2	PEAK POWER .....	22
7.3	AVERAGE POWER.....	24
7.4	BAND EDGES MEASUREMENT .....	26
7.5	PEAK POWER SPECTRAL DENSITY .....	50
7.6	SPURIOUS EMISSIONS.....	58
7.7	POWERLINE CONDUCTED EMISSIONS .....	82
<b>8</b>	<b>APPENDIX I PHOTOGRAPHS OF TEST SETUP</b> .....	<b>85</b>
<b>9</b>	<b>APPENDIX II: PHOTOGRAPHS OF EUT</b> .....	<b>89</b>



# 1 TEST RESULT CERTIFICATION

**Applicant:** **D-Link Corporation**  
NO. 289, Sinhu 3rd Rd., Neihu District, Taipei City114, Taiwan, R.O.C.

**Manufacturer:** **APPRO Technology Inc.**  
13F, No. 66, Zhongzheng Rd., Xinzhuang Dist., New Taipei City, Taiwan.

**Equipment Under Test:** Wireless AC Day/Night HD Mini Bullet Cloud Camera

**Trade Name:** D-Link

**Model:** DCS-7000L

**Date of Test:** May 19 ~ September 9, 2014

APPLICABLE STANDARDS	
STANDARD	TEST RESULT
FCC 47 CFR Part 15 Subpart C	No non-compliance noted

## We hereby certify that:

Compliance Certification Services Inc. tested the above equipment in accordance with the requirements set forth in the above standards. The test results show that the equipment tested is capable of demonstrating compliance with the requirements as documented in this report.

The test results of this report relate only to the tested sample identified in this report.

**Approved by:**

**Reviewed by:**

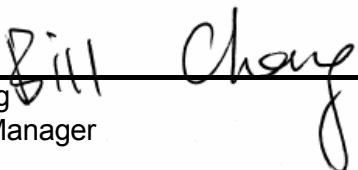
  
 \_\_\_\_\_  
 Bill Cheng  
 Section Manager

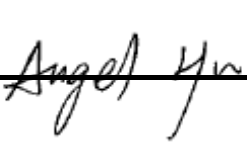
  
 \_\_\_\_\_  
 Angel Hu  
 Section Manager



## 2 EUT DESCRIPTION

<b>Product</b>	Wireless AC Day/Night HD Mini Bullet Cloud Camera		
<b>Trade Name</b>	D-Link		
<b>Model Number</b>	DCS-7000L		
<b>Model Discrepancy</b>	N/A		
<b>EUT Power Rating</b>	5VDC, 1.2A		
<b>Received Date</b>	March 17, 2014		
<b>Power Adapter</b>	D-Link	<b>Model</b>	AMS1-0501200FU
<b>Power Adapter Power Rating</b>	I/P: 100-240VAC, 50/60HZ, 0.2A O/P: 5VDC, 1.2A		
<b>RF Module Manufacturer</b>	Reltek	<b>Model</b>	RTL8811AU
<b>Frequency Range</b>	IEEE 802.11b/g/ IEEE 802.11n HT20 mode: 2412~2462MHz IEEE 802.11n HT40 mode: 2422~2452MHz		
<b>Transmit Power</b>	IEEE 802.11b mode: 15.43 dBm (0.0349W) IEEE 802.11g mode: 21.66 dBm (0.1466W) IEEE 802.11n HT20 mode: 21.35 dBm (0.1365W) IEEE 802.11n HT40 mode: 21.09 dBm (0.1285W)		
<b>Modulation Technique &amp; Transmit Data Rate</b>	IEEE 802.11b mode: DSSS (11, 5.5, 2, 1 Mbps) IEEE 802.11g mode: OFDM (54, 48, 36, 24, 18, 12, 11, 9, 6 Mbps) IEEE 802.11n HT20 mode: OFDM (65, 58.5, 52, 39, 26, 19.5, 13, 6.5 Mbps) IEEE 802.11n HT40 mode: OFDM (135, 121.5, 108, 81, 54, 40.5, 27, 13.5 Mbps)		
<b>Number of Channels</b>	IEEE 802.11b/g mode: 11 Channels IEEE 802.11n HT20 mode: 11 Channels IEEE 802.11n HT40 mode: 7 Channels		
<b>Antenna Specification</b>	PCB Antenna / Gain: 2.28 dBi		

**Remark:**

1. The sample selected for test was production product and was provided by manufacturer.
2. This submittal(s) (test report) is intended for FCC ID: **KA2CS7000LA1** filing to comply with Section 15.207, 15.209 and 15.247 of the FCC Part 15, Subpart C Rules.



### **3 TEST METHODOLOGY**

The tests documented in this report were performed in accordance with ANSI C63.4: 2009 and FCC CFR 47 Part 15.207, 15.209, 15.247.

#### **3.1 EUT CONFIGURATION**

The EUT configuration for testing is installed on RF field strength measurement to meet the Commissions requirement and operating in a manner that intends to maximize its emission characteristics in a continuous normal application.

#### **3.2 EUT EXERCISE**

The EUT was operated in the engineering mode to fix the TX frequency that was for the purpose of the measurements.

According to its specifications, the EUT must comply with the requirements of the Section 15.207, 15.209 and 15.247 under the FCC Rules Part 15 Subpart C.

#### **3.3 GENERAL TEST PROCEDURES**

##### **Conducted Emissions**

The EUT is placed on the turntable, which is 0.8 m above ground plane. According to the requirements in Section 13.1.4.1 of ANSI C63.4 Conducted emissions from the EUT measured in the frequency range between 0.15 MHz and 30MHz using CISPR Quasi-peak and average detector modes.

##### **Radiated Emissions**

The EUT is placed on a turn table, which is 0.8 m above ground plane. The turntable shall rotate 360 degrees to determine the position of maximum emission level. EUT is set 3m away from the receiving antenna, which varied from 1m to 4m to find out the highest emission. And also, each emission was to be maximized by changing the polarization of receiving antenna both horizontal and vertical. In order to find out the maximum emissions, exploratory radiated emission measurements were made according to the requirements in Section 13.1.4.1 of ANSI C63.4.



### 3.4 FCC PART 15.205 RESTRICTED BANDS OF OPERATIONS

(a) Except as shown in paragraph (d) of this section, only spurious emissions are permitted in any of the frequency bands listed below:

MHz	MHz	MHz	GHz
0.090 - 0.110	16.42 - 16.423	399.9 - 410	4.5 - 5.15
<sup>1</sup> 0.495 - 0.505	16.69475 - 16.69525	608 - 614	5.35 - 5.46
2.1735 - 2.1905	16.80425 - 16.80475	960 - 1240	7.25 - 7.75
4.125 - 4.128	25.5 - 25.67	1300 - 1427	8.025 - 8.5
4.17725 - 4.17775	37.5 - 38.25	1435 - 1626.5	9.0 - 9.2
4.20725 - 4.20775	73 - 74.6	1645.5 - 1646.5	9.3 - 9.5
6.215 - 6.218	74.8 - 75.2	1660 - 1710	10.6 - 12.7
6.26775 - 6.26825	108 - 121.94	1718.8 - 1722.2	13.25 - 13.4
6.31175 - 6.31225	123 - 138	2200 - 2300	14.47 - 14.5
8.291 - 8.294	149.9 - 150.05	2310 - 2390	15.35 - 16.2
8.362 - 8.366	156.52475 -	2483.5 - 2500	17.7 - 21.4
8.37625 - 8.38675	156.52525	2655 - 2900	22.01 - 23.12
8.41425 - 8.41475	156.7 - 156.9	3260 - 3267	23.6 - 24.0
12.29 - 12.293	162.0125 - 167.17	3332 - 3339	31.2 - 31.8
12.51975 - 12.52025	167.72 - 173.2	3345.8 - 3358	36.43 - 36.5
12.57675 - 12.57725	240 - 285	3600 - 4400	( <sup>2</sup> )
13.36 - 13.41	322 - 335.4		

<sup>1</sup> Until February 1, 1999, this restricted band shall be 0.490-0.510 MHz.

<sup>2</sup> Above 38.6

(b) Except as provided in paragraphs (d) and (e), the field strength of emissions appearing within these frequency bands shall not exceed the limits shown in Section 15.209. At frequencies equal to or less than 1000 MHz, compliance with the limits in Section 15.209 shall be demonstrated using measurement instrumentation employing a CISPR quasi-peak detector. Above 1000 MHz, compliance with the emission limits in Section 15.209 shall be demonstrated based on the average value of the measured emissions. The provisions in Section 15.35 apply to these measurements.



### **3.5 DESCRIPTION OF TEST MODES**

The EUT (model: DCS-7000L) had been tested under operating condition.

Software used to control the EUT for staying in continuous transmitting was programmed.

The worst case data rate is determined as the data rate with highest output power.

After verification, all tests carried out are with the worst-case test modes as shown below except radiated spurious emission below 1GHz and power line conducted emissions, which worst case was in LAN mode.

The field strength of spurious emission was measured in the following position: EUT stand-up position (Y axis), lie-down position (X, Z axis). The worst emission was found in lie-down position (X axis) and the worst case was recorded.

WIFI Mode & LAN Mode have been pre-scanned during the test, and the LAN Mode was selected as the worst case for final test.

#### **IEEE 802.11b mode:**

Channel Low (2412MHz), Channel Mid (2437MHz) and Channel High (2462MHz) with 1Mbps data rate was chosen for full testing.

#### **IEEE 802.11g mode:**

Channel Low (2412MHz), Channel Mid (2437MHz) and Channel High (2462MHz) with 6Mbps data rate was chosen for full testing.

#### **IEEE 802.11n HT20 mode:**

Channel Low (2412MHz), Channel Mid (2437MHz) and Channel High (2462MHz) with 6.5Mbps data rate were chosen for full testing.

#### **IEEE 802.11n HT40 mode:**

Channel Low (2422MHz), Channel Mid (2437MHz) and Channel High (2452MHz) with 13.5Mbps data rate were chosen for full testing.



## 4 INSTRUMENT CALIBRATION

### 4.1 MEASURING INSTRUMENT CALIBRATION

The measuring equipment, which was utilized in performing the tests documented herein, has been calibrated in accordance with the manufacturer's recommendations for utilizing calibration equipment, which is traceable to recognized national standards.

### 4.2 MEASUREMENT EQUIPMENT USED

#### Equipment Used for Emissions Measurement

Conducted Emissions Test Site				
Name of Equipment	Manufacturer	Model	Serial Number	Calibration Due
Spectrum Analyzer	Agilent	E4446A	MY48250064	01/01/2015
Spectrum Analyzer	Agilent	N9010A	MY52220817	03/20/2015
Spectrum Analyzer	R&S	FSL	100837	11/11/2014
Power meter	Anritsu	ML2495A	1033009	09/29/2014
Power Sensor	Anritsu	MA2411B	0917221	09/29/2014

3M Semi Anechoic Chamber				
Name of Equipment	Manufacturer	Model	Serial Number	Calibration Due
Spectrum Analyzer	Agilent	E4446A	MY48250064	01/01/2015
Spectrum Analyzer	R&S	FSL	100837	11/11/2014
Pre-Amplifier	HP	8447D	2944A06530	05/02/2015
Pre-Amplifier	EMEC	EM01M26G	060570	07/28/2015
Pre-Amplifier	MITEQ	AMF-6F-26040 0-40-8P	985646	06/12/2015
Pre-Amplifier	Agilent	8449B	3008A01738	08/11/2015
EMI Test Receiver	SCHAFFNER	SCR 3501	430	03/30/2015
Loop Antenna	EMCO	6502	8905-2356	08/20/2015
Bilog Antenna	TESEQ	CBL 6112D	35378	08/21/2015
Horn Antenna	EMCO	3115	00022250	08/05/2015
Horn Antenna	EMCO	3116	00026370	12/29/2014
Antenna Tower	CCS	CC-A-1F	N/A	N.C.R
Turn Table	CCS			

**NOTE:** 1. The calibration interval of the above test instruments is 12 months and the calibrations are traceable to NML/ROC and NIST/USA.  
 2. N.C.R = No Calibration Request.



Powerline Conducted Emissions Test Site #4				
Name of Equipment	Manufacturer	Model	Serial Number	Calibration Due
EMI Test Receiver	R&S	ESCI	100782	06/12/2015
LISN	R&S	ENV216	100066	02/06/2015
LISN	R&S	ENV 4200	830326/016	05/22/2015
ISN	FCC	FCC-TLISN-T2-02	20587	07/28/2015
ISN	TESEQ	ISN-T8	30843	08/11/2015
Current Probe	FCC	F-35	506	07/13/2015
ISN	TESEQ	ISN ST08	27907	09/30/2014
Test S/W	EZ-EMC			

**NOTE:** 1. The calibration interval of the above test instruments is 12 months and the calibrations are traceable to NML/ROC and NIST/USA.  
 2. N.C.R = No Calibration Request.

### 4.3 MEASUREMENT UNCERTAINTY

Parameter	Uncertainty
Powerline Conducted Emission #4	±2.0543
3M Semi Anechoic Chamber / 30MHz ~ 200MHz	±3.5921
3M Semi Anechoic Chamber / 200MHz ~ 1GHz	±3.5657
3M Semi Anechoic Chamber / 1 ~ 8GHz	±2.5873
3M Semi Anechoic Chamber / 8 ~ 18GHz	±2.6646
3M Semi Anechoic Chamber / 18 ~ 26GHz	±2.9617
3M Semi Anechoic Chamber / 26 ~ 40GHz	±3.4250

**Remark:** This uncertainty represents an expanded uncertainty expressed at approximately the 95% confidence level using a coverage factor of k=2.



## **5 FACILITIES AND ACCREDITATIONS**

### **5.1 FACILITIES**

All measurement facilities used to collect the measurement data are located at

- No. 163-1, Jhongsheng Rd., Sindien District, Taipei City 23151, Taiwan  
Tel: 886-2-2217-0894 / Fax: 886-2-2217-1029
- No 11, Wugong 6th Rd, Wugu District, New Taipei City 24891, Taiwan (R.O.C)  
Tel: 886-2-2299-9720 / Fax: 886-2-2298-4045
- No.81-1, Lane 210, Bade 2nd Rd., Lujhu Township, Taoyuan County 33841, Taiwan  
Tel: 886-3-324-0332 / Fax: 886-3-324-5235

The sites are constructed in conformance with the requirements of ANSI C63.7, ANSI C63.4 and CISPR Publication 22.





All receiving equipment conforms to CISPR Publication 16-1, "Radio Interference Measuring Apparatus and Measurement Methods."

### **5.2 LABORATORY ACCREDITATIONS AND LISTING**

The test facilities used to perform radiated and conducted emissions tests are accredited by American Association for Laboratory Accreditation Program for the specific scope accreditation under Lab Code: 0824-01 to perform Electromagnetic Interference tests according to FCC Part 15 and CISPR 22 requirements. In addition, the test facilities are listed with Industry Canada, Certification and Engineering Bureau, IC 2324G-1 for 3M Semi Anechoic Chamber A, IC 2324G-2 for 3M Semi Anechoic Chamber B.



**5.3 TABLE OF ACCREDITATIONS AND LISTINGS**

Country	Agency	Scope of Accreditation	Logo
USA	A2LA	CFR 47, FCC Part15/18, CISPR 22, EN 55022, ICES-003, AS/NZS CISPR 22, VCCI V-3, EN 55011, CISPR 11, IEC/EN 61000-4-2/3/4/5/6/8/11, EN 61000-6-1/2/3/4, EN 55024, CISPR 24, AS/NZS CISPR 24, AS/NZS 61000.6.2, EN 55014-1/-2, ETSI EN 300 386 v1.3.2/v1.3.3, IEC/EN 61000-3-2, AS/NZS 61000.3.2, IEC/EN 61000-3-3, AS/NZS 61000.3.3	 TESTING CERT #0824.01
USA	FCC MRA	3 meter Open Area Test Sites to perform FCC Part 15/18 measurements	
Japan	VCCI	3/10 meter Open Area Test Sites and conducted test sites to perform radiated/conducted measurements	<b>VCCI</b> R-2882/2541/2798/725/1868 C-402/747/912 T-1930/1646
Taiwan	TAF	EN 55014-1, CISPR 14, CNS 13781-1, EN 55013, CISPR 13, CNS 13439, EN 55011, CISPR 11, CNS 13803, PLMN09, IS2045-0, LP0002 FCC Part 27/90, Part 15B/C/D/E, RSS-192/193/210/310 ETSI EN 300 328/ 300 220-1/ 300 220-2/ 301 893/ 301 489-01/ 301 489-03/ 301 489-07 / 301 489-17/ 300 440-1/ 300 440-2 AS/NZS 4268, AS/NZS 4771 CISPR 22, EN 55022, CNS 13438, AS/NZS CISPR 22, VCCI, IEC/EN 61000-4-2/3/4/5/6/8/11, CNS 14676-2/3/4/5/6/8, CNS 14934-2/3, CNS 13783-1, CNS 13439, CNS 13803	 Testing Laboratory 0363
Taiwan	BSMI	CNS 13438, CNS 13783-1, CNS 13439, CNS 14115	SL2-IS-E-0014 / IN-E-0014 /A1-E-0014 /R1-E-0014 /R2-E-0014 /L1-E-0014
Canada	Industry Canada	RSS-Gen Issue 3	

\* No part of this report may be used to claim or imply product endorsement by A2LA or any agency of the US Government.



## 6 SETUP OF EQUIPMENT UNDER TEST

### 6.1 SETUP CONFIGURATION OF EUT

See test photographs attached in Appendix II for the actual connections between EUT and support equipment.

### 6.2 SUPPORT EQUIPMENT

**For Powerline Conducted Emission & Radiated Emissions(Below 1GHz)**

No.	Device Type	Model	Series No.	FCC ID	Brand	Data Cable	Power Cord
1	Notebook PC (Remote)	ThinkPad T430u	PB-VZHMR 12/09	FCC DOC	Lenovo	LAN Cable: Unshielded, 10m	AC I/P: Unshielded, 1.8m DC O/P: Unshielded, 1.8m with a core
2	Earphone	ClearChat	N/A	FCC DoC	Logitech	Unshielded, 1.8m	N/A

**For Radiated Emissions(Above 1GHz)**

No.	Device Type	Model	Series No.	FCC ID	Brand	Data Cable	Power Cord
1	Notebook PC (Remote)	ThinkPad T430u	PB-VZLGG 12/09	FCC DOC	Lenovo	LAN Cable: Unshielded, 10m	AC I/P: Unshielded, 1.8m DC O/P: Unshielded, 1.8m with a core

**For Conducted Emission**

No.	Device Type	Model	Series No.	FCC ID	Brand	Data Cable	Power Cord
1	Notebook PC	D400	0932RY	E2K24GBRL	DELL	LAN Cable: Unshielded, 1.8m	AC I/P: Unshielded, 1.8m DC O/P: Unshielded, 1.8m with a core

**Remark:** Grounding was established in accordance with the manufacturer's requirements and conditions for the intended use.



## **7 FCC PART 15 REQUIREMENTS**

### **7.1 6DB BANDWIDTH**

#### **LIMIT**

According to §15.247(a)(2), systems using digital modulation techniques may operate in the 902 - 928 MHz, 2400 - 2483.5 MHz, and 5725 - 5850 MHz bands. The minimum 6dB bandwidth shall be at least 500 kHz.

#### **Test Configuration**

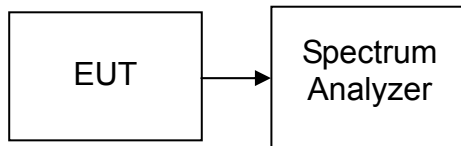

#### **TEST PROCEDURE**

1. Place the EUT on the table and set it in the transmitting mode.
2. Remove the antenna from the EUT and then connect a low loss RF cable from the antenna port to the spectrum analyzer.
3. Set the spectrum analyzer as RBW = 100kHz, VBW = 300kHz, Sweep = auto, Span = 30MHz (IEEE 802.11b, IEEE 802.11g, IEEE 802.11n HT20) or Span = 60MHz (IEEE 802.11n HT40).
4. Mark the peak frequency and -6dB (upper and lower) frequency.
5. Repeat until all the rest channels are investigated.

#### **TEST RESULTS**

*No non-compliance noted*



**Test Data**

**Test mode: IEEE 802.11b mode**

Channel	Frequency (MHz)	Bandwidth (MHz)	Limit (kHz)	Result
Low	2412	10.25	>500	PASS
Mid	2437	10.20		PASS
High	2462	10.20		PASS

**Test mode: IEEE 802.11g mode**

Channel	Frequency (MHz)	Bandwidth (MHz)	Limit (kHz)	Result
Low	2412	16.70	>500	PASS
Mid	2437	16.65		PASS
High	2462	16.60		PASS

**Test mode: IEEE 802.11n HT20 mode**

Channel	Frequency (MHz)	Bandwidth (MHz)	Limit (kHz)	Result
Low	2412	17.90	>500	PASS
Mid	2437	17.85		PASS
High	2462	17.85		PASS

**Test mode: IEEE 802.11n HT40 mode**

Channel	Frequency (MHz)	Bandwidth (MHz)	Limit (kHz)	Result
Low	2422	36.7	>500	PASS
Mid	2437	36.6		PASS
High	2452	38.4		PASS



**Test Plot**

**IEEE 802.11b mode**

**6dB Bandwidth (CH Low)**

Agilent

R L

Mkr1 10.25 MHz  
-0.97 dB

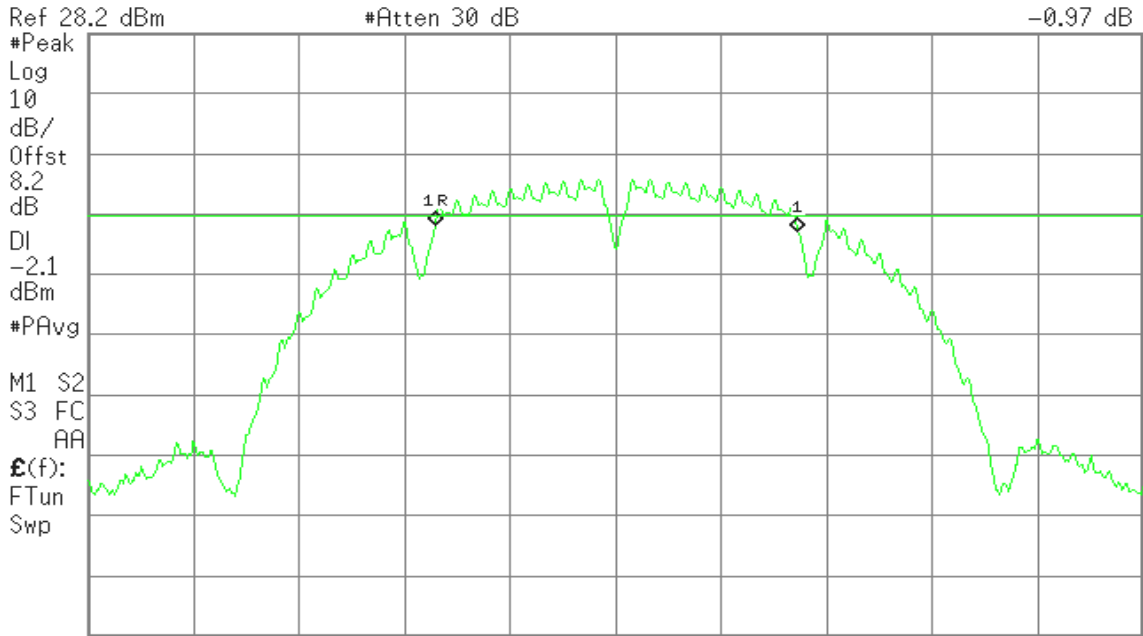

Center 2.412 00 GHz

Span 30 MHz

#Res BW 100 kHz

#VBW 300 kHz

Sweep 2.88 ms (601 pts)

**6dB Bandwidth (CH Mid)**

Agilent

R L

Mkr1 10.20 MHz  
-0.36 dB

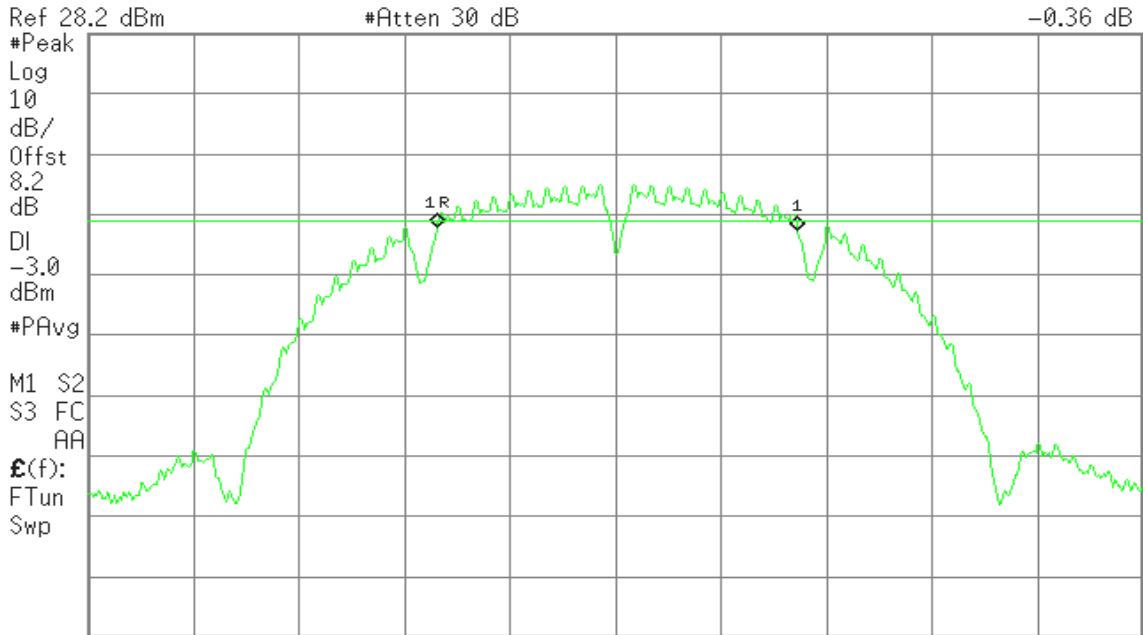

Center 2.437 00 GHz

Span 30 MHz

#Res BW 100 kHz

#VBW 300 kHz

Sweep 2.88 ms (601 pts)



### 6dB Bandwidth (CH High)

Agilent

R L

Mkr1 10.20 MHz  
-1.77 dB

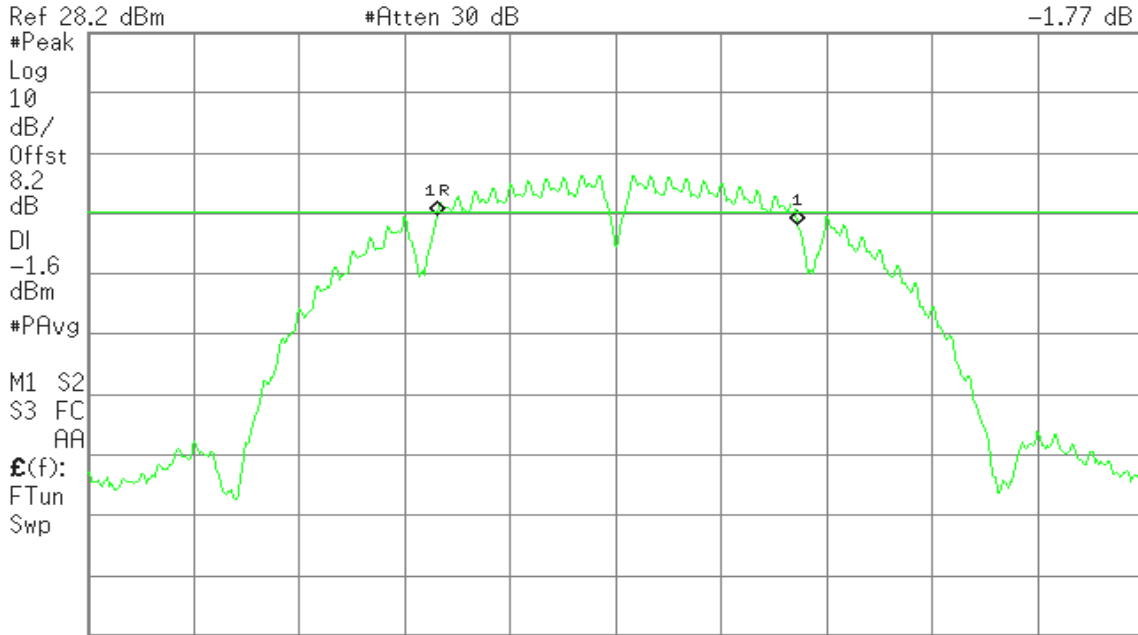

Center 2.462 00 GHz

Span 30 MHz

#Res BW 100 kHz

#VBW 300 kHz

Sweep 2.88 ms (601 pts)

### IEEE 802.11g mode

### 6dB Bandwidth (CH Low)

Agilent

R L

Mkr1 16.70 MHz  
-0.14 dB

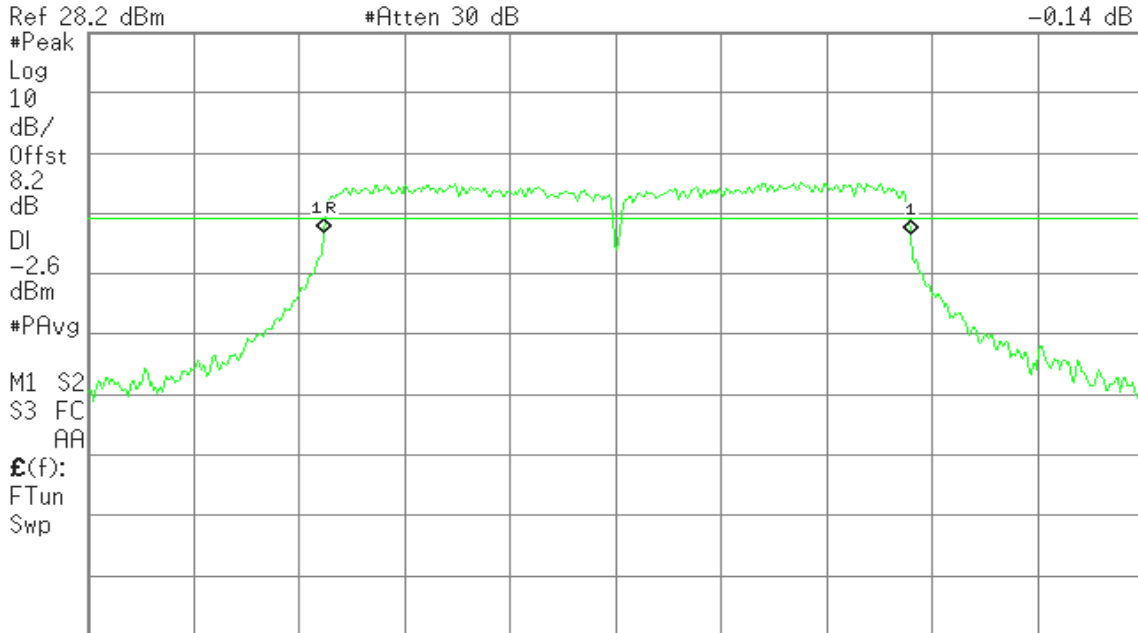

Center 2.412 00 GHz

Span 30 MHz

#Res BW 100 kHz

#VBW 300 kHz

Sweep 2.88 ms (601 pts)



### 6dB Bandwidth (CH Mid)

Agilent

R L

Mkr1 16.65 MHz  
-0.69 dB

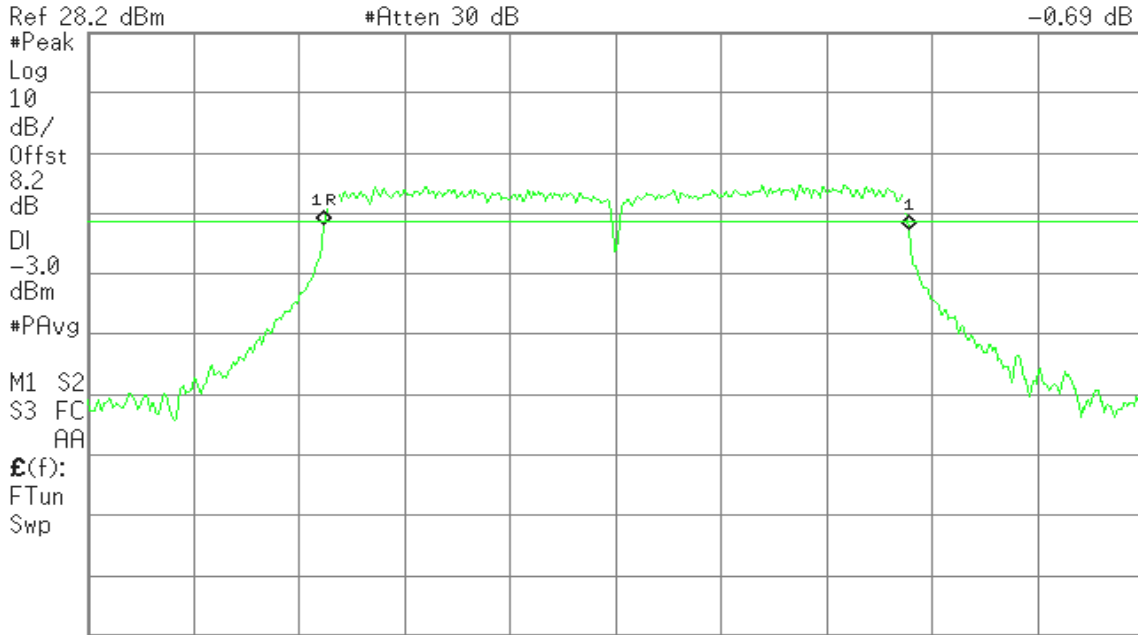

Center 2.437 00 GHz

Span 30 MHz

#Res BW 100 kHz

#VBW 300 kHz

Sweep 2.88 ms (601 pts)

### 6dB 6dB Bandwidth (CH High)

Agilent

R L

Mkr1 16.60 MHz  
-0.05 dB

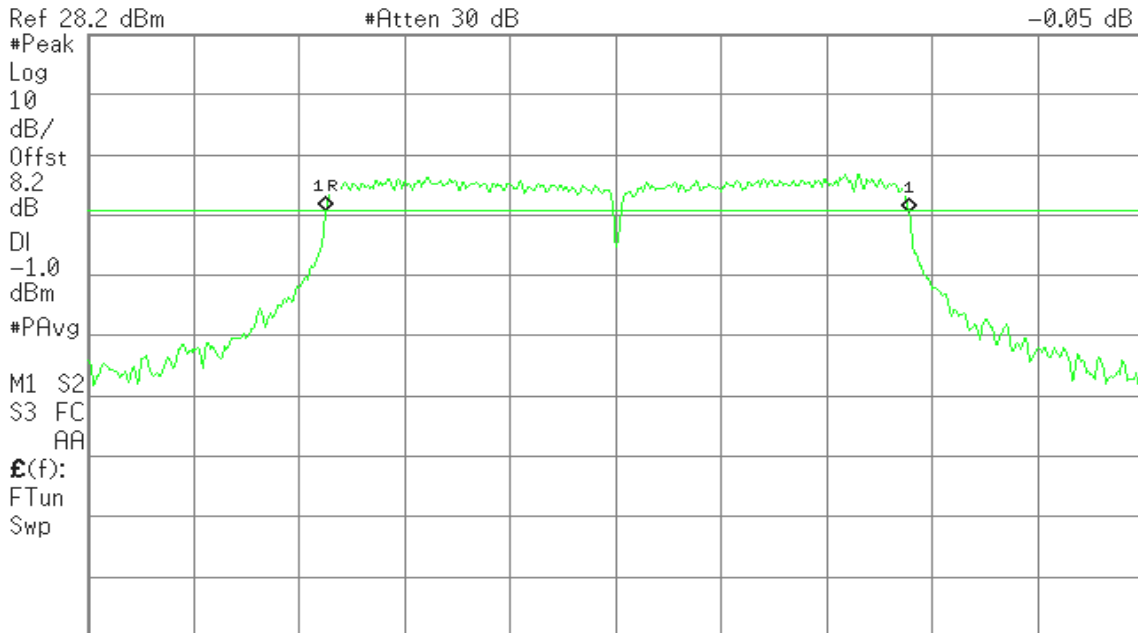

Center 2.462 00 GHz

Span 30 MHz

#Res BW 100 kHz

#VBW 300 kHz

Sweep 2.88 ms (601 pts)



### IEEE 802.11n HT20 mode

### 6dB Bandwidth (CH Low)

Agilent

R L

Mkr1 17.90 MHz  
-1.18 dB

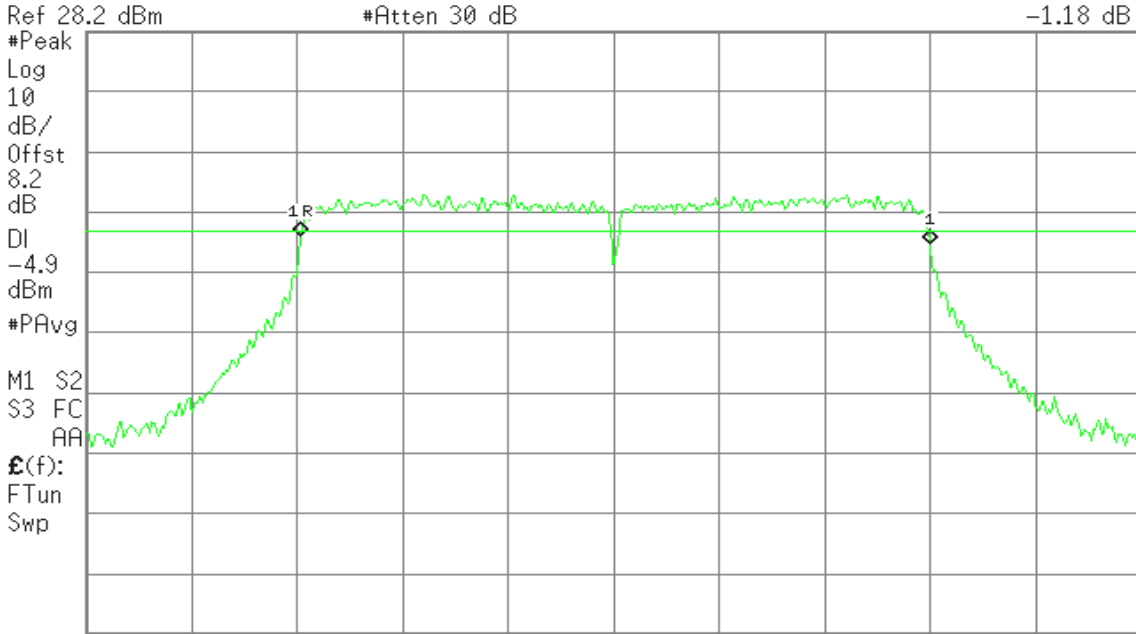

### 6dB Bandwidth (CH Mid)

Agilent

R L

Mkr1 17.85 MHz  
-0.72 dB

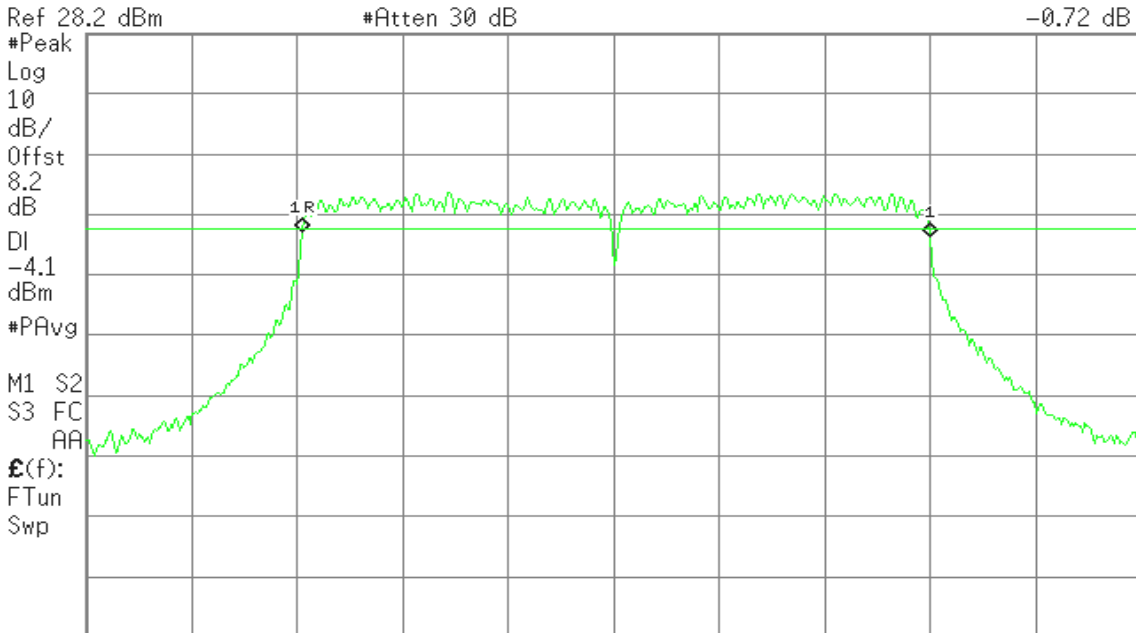



### 6dB Bandwidth (CH High)

Agilent

R L

Mkr1 17.85 MHz  
0.11 dB

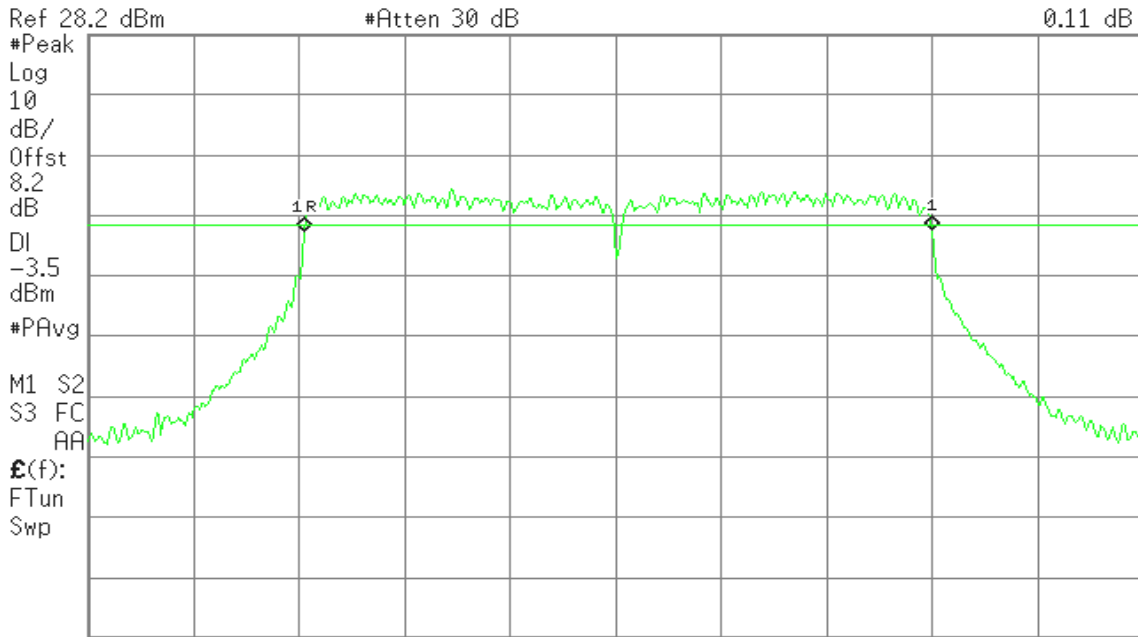

Center 2.462 00 GHz

Span 30 MHz

#Res BW 100 kHz

#VBW 300 kHz

Sweep 2.88 ms (601 pts)

### IEEE 802.11n HT40 mode

### 6dB Bandwidth (CH Low)

Agilent

R L

Mkr1 36.7 MHz  
-0.36 dB

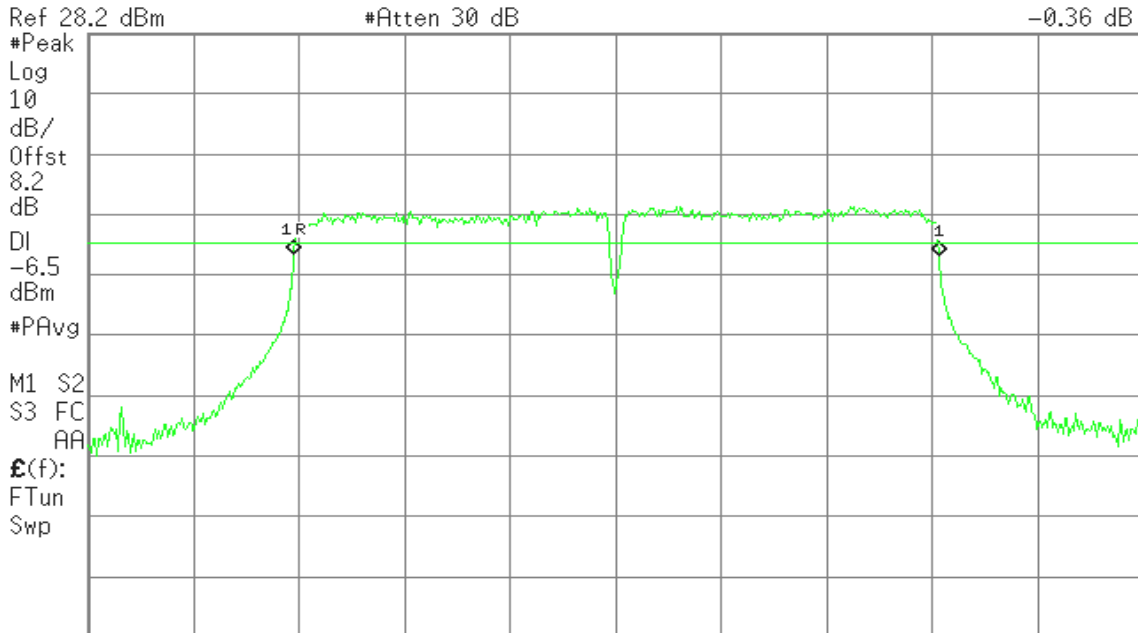

Center 2.422 0 GHz

Span 60 MHz

#Res BW 100 kHz

#VBW 300 kHz

Sweep 5.76 ms (601 pts)



### 6dB Bandwidth (CH Mid)

Agilent

R L

Mkr1 36.6 MHz  
-0.60 dB

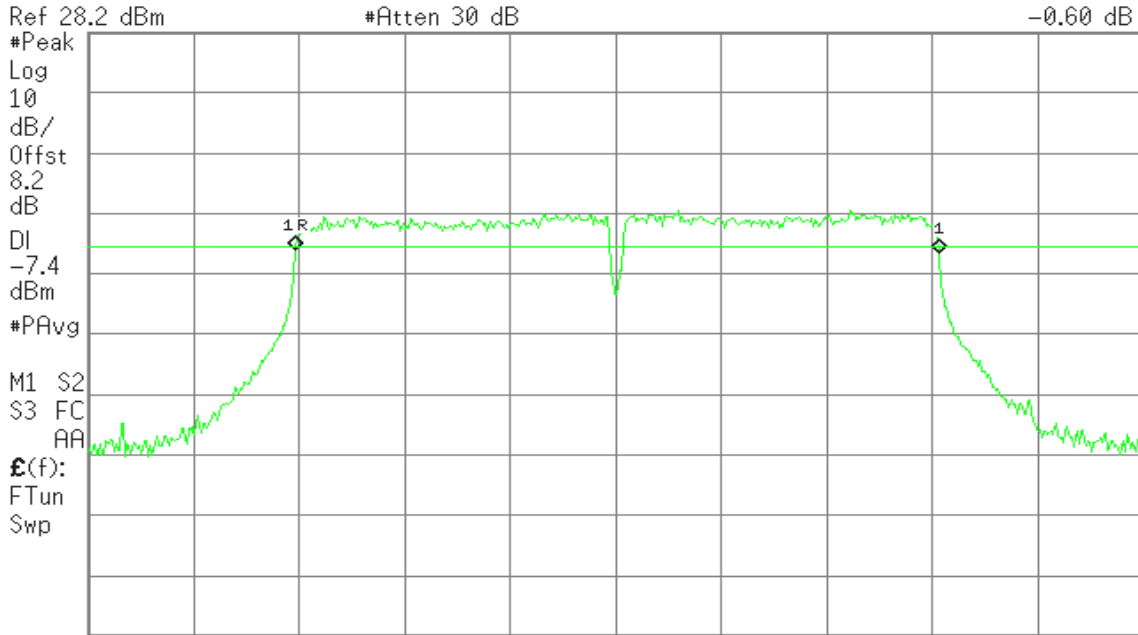

Center 2.437 0 GHz Span 60 MHz  
#Res BW 100 kHz #VBW 300 kHz Sweep 5.76 ms (601 pts)

### 6dB Bandwidth (CH High)

Agilent

R L

Mkr1 38.4 MHz  
-0.25 dB

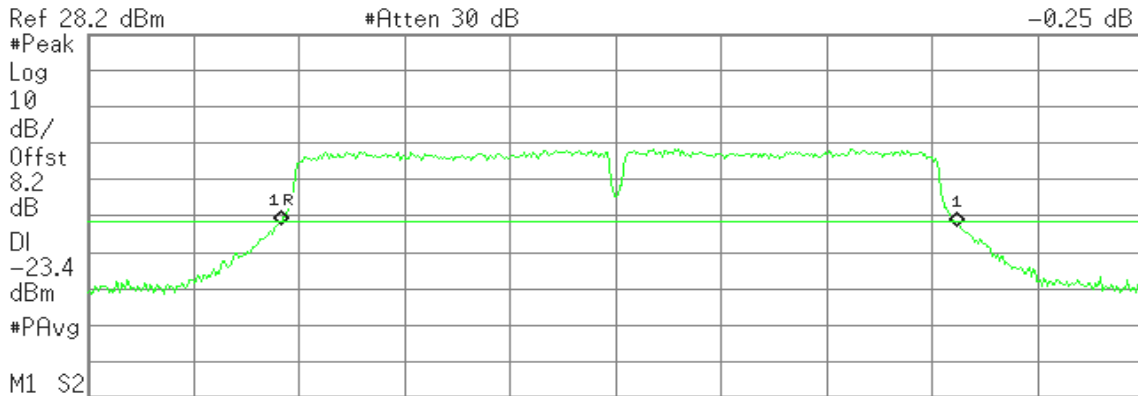

Center 2.452 0 GHz Span 60 MHz  
#Res BW 100 kHz #VBW 300 kHz Sweep 5.76 ms (601 pts)

Marker	Trace	Type	X Axis	Amplitude
1R	(1)	Freq	2.433 0 GHz	-24.28 dBm
1Δ	(1)	Freq	38.4 MHz	-0.25 dB



## **7.2 PEAK POWER**

### **LIMIT**

The maximum peak output power of the intentional radiator shall not exceed the following:

1. According to §15.247(b)(3), for systems using digital modulation in the bands of 902-928 MHz, 2400-2483.5 MHz, and 5725-5850 MHz: 1 Watt.
2. According to §15.247(b)(4), the conducted output power limit specified in paragraph (b) of this section is based on the use of antennas with directional gains that do not exceed 6 dBi. Except as shown in paragraph (c) of this section, if transmitting antennas of directional gain greater than 6 dBi are used, the conducted output power from the intentional radiator shall be reduced below the stated values in paragraphs (b)(1), (b)(2), and (b)(3) of this section, as appropriate, by the amount in dB that the directional gain of the antenna exceeds 6 dBi.

### **Test Configuration**

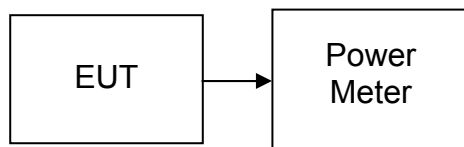

### **TEST PROCEDURE**

#### **Per KDB 558074 v03r02**

The transmitter output is connected to the Power Meter. The Power Meter is set to the peak power detection.

### **TEST RESULTS**

*No non-compliance noted*



**Test Data**

**Test mode: IEEE 802.11b mode**

Channel	Frequency (MHz)	Output Power (dBm)	Output Power (W)	Limit (W)	Test Result
Low	2412	15.15	0.0327	1	PASS
Mid	2437	15.43	0.0349		PASS
High	2462	15.31	0.0340		PASS

**Test mode: IEEE 802.11g mode**

Channel	Frequency (MHz)	Output Power (dBm)	Output Power (W)	Limit (W)	Test Result
Low	2412	21.04	0.1271	1	PASS
Mid	2437	21.66	0.1466		PASS
High	2462	21.26	0.1337		PASS

**Test mode: IEEE 802.11n HT20 mode**

Channel	Frequency (MHz)	Output Power (dBm)	Output Power (W)	Limit (W)	Test Result
Low	2412	21.04	0.1271	1	PASS
Mid	2437	21.35	0.1365		PASS
High	2462	20.85	0.1216		PASS

**Test mode: IEEE 802.11n HT40 mode**

Channel	Frequency (MHz)	Output Power (dBm)	Output Power (W)	Limit (W)	Test Result
Low	2422	20.97	0.1250	1	PASS
Mid	2437	21.09	0.1285		PASS
High	2452	19.23	0.0838		PASS



## **7.3 AVERAGE POWER**

### **LIMIT**

None; for reporting purposes only.

### **Test Configuration**

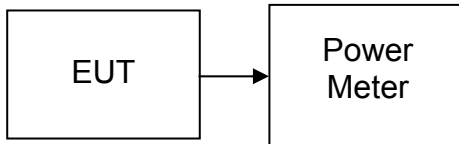

### **TEST PROCEDURE**

**Per KDB 558074 v03r02**

The transmitter output is connected to the Power Meter. The Power Meter is set to the peak power detection.

### **TEST RESULTS**

*No non-compliance noted*



**Test Data**

**Test mode: IEEE 802.11b mode**

Channel	Frequency (MHz)	Output Power (dBm)	Output Power (W)
Low	2412	12.35	0.0172
Mid	2437	11.96	0.0157
High	2462	12.23	0.0167

**Test mode: IEEE 802.11g mode**

Channel	Frequency (MHz)	Output Power (dBm)	Output Power (W)
Low	2412	13.96	0.0249
Mid	2437	14.53	0.0284
High	2462	14.16	0.0261

**Test mode: IEEE 802.11n HT20 mode**

Channel	Frequency (MHz)	Output Power (dBm)	Output Power (W)
Low	2412	13.82	0.0241
Mid	2437	13.79	0.0239
High	2462	13.84	0.0242

**Test mode: IEEE 802.11n HT40 mode**

Channel	Frequency (MHz)	Output Power (dBm)	Output Power (W)
Low	2422	13.84	0.0242
Mid	2437	14.13	0.0259
High	2452	12.25	0.0168



## 7.4 BAND EDGES MEASUREMENT

### LIMIT

According to §15.247(d), in any 100 kHz bandwidth outside the frequency bands in which the spread spectrum intentional radiator is operating, the radio frequency power that is produced by the intentional radiator shall be at least 20 dB below that in the 100 kHz bandwidth within the band that contains the highest level of the desired power, based on either an RF conducted or a radiated measurement, provided the transmitter demonstrates compliance with the peak conducted power limits. In addition, radiated emissions which fall in the restricted bands, as defined in §15.205(a), must also comply with the radiated emission limits specified in 15.209(a) (see Section 15.205(c)).

### Test Configuration

#### For Radiated

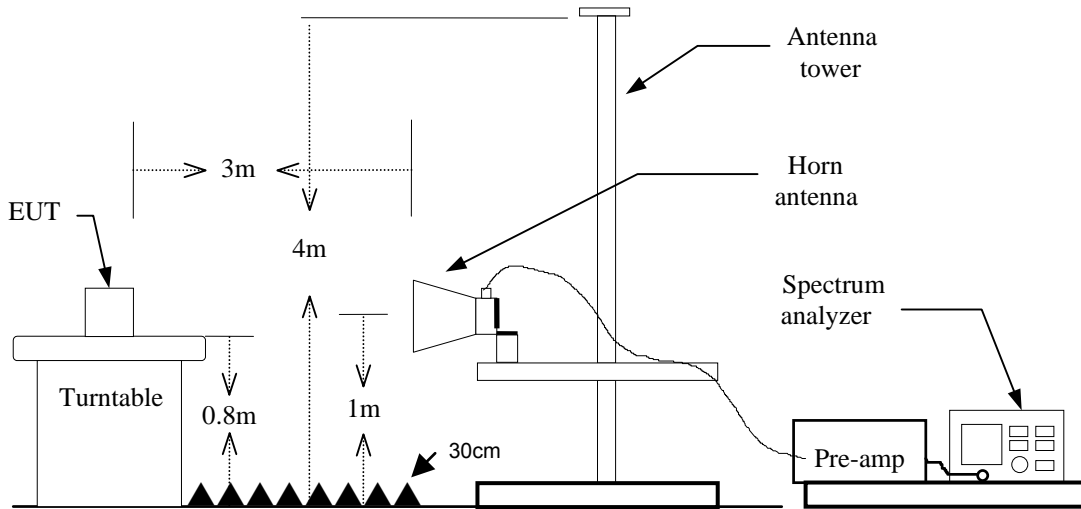

#### For Conducted

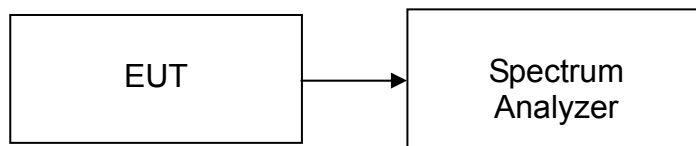



## **TEST PROCEDURE**

### **For Radiated**

1. The EUT is placed on a turntable, which is 0.8m above the ground plane.
2. The turntable shall be rotated for 360 degrees to determine the position of maximum emission level.
3. EUT is set 3m away from the receiving antenna, which is varied from 1m to 4m to find out the highest emission.
4. Set the spectrum analyzer in the following setting in order to capture the lower and upper band-edges of the emission:
  - (a) PEAK: RBW=1MHz / VBW=3MHz / Sweep=AUTO
  - (b) AVERAGE: RBW=1MHz / VBW=300Hz<sup>(1)</sup> / Sweep=AUTO
  - (c) Duty Cycle: RBW=1MHz / VBW=1MHz
5. Repeat the procedures until all the PEAK and AVERAGE versus POLARIZATION are measured.

(1): Because Duty Cycle > 98%, the use of more rigorous testing methods VBW = 300Hz.

### **For Conducted**

Conducted RF measurements of the transmitter output were made to confirm that the EUT antenna port conducted emissions meet the specified limit and to identify any spurious signals that require further investigation or measurements on the radiated emissions site.

The transmitter output is connected to the spectrum analyzer. The resolution bandwidth is set to 100 kHz. The video bandwidth is set to 100 kHz.

## **TEST RESULTS**

Refer to attach spectrum analyzer data chart.



# DUTY CYCLE

## IEEE 802.11b mode

Agilent

R L

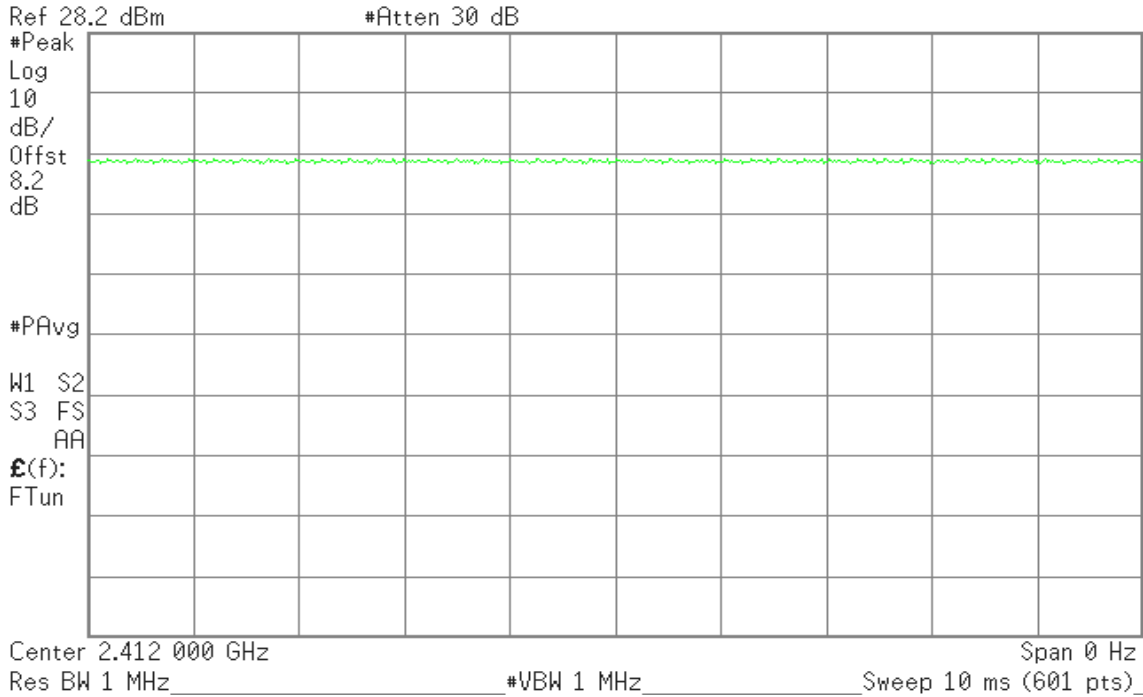

## IEEE 802.11g mode

Agilent

R L

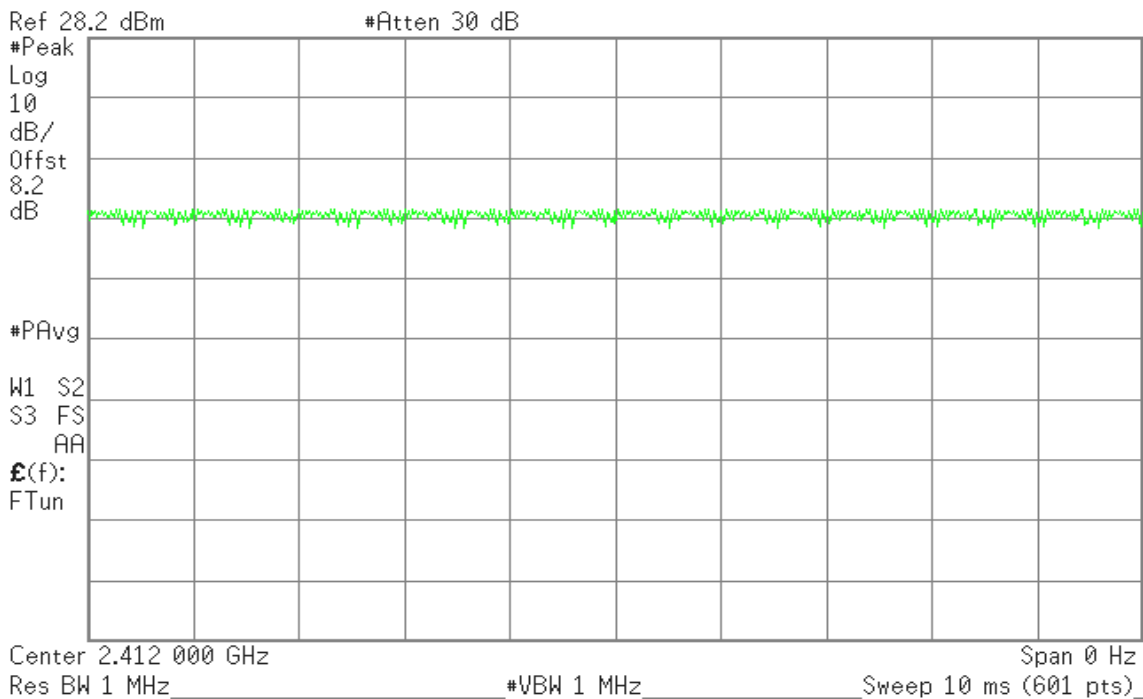



### IEEE 802.11n HT20 mode

Agilent

R L

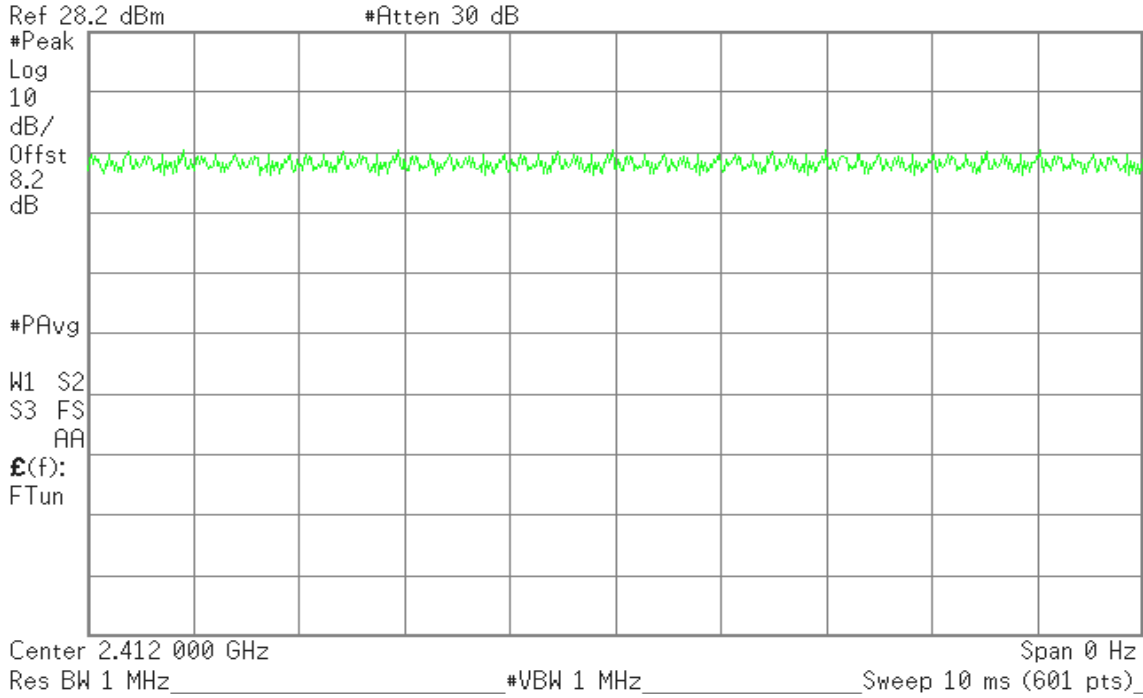

### IEEE 802.11n HT40 mode

Agilent

R L

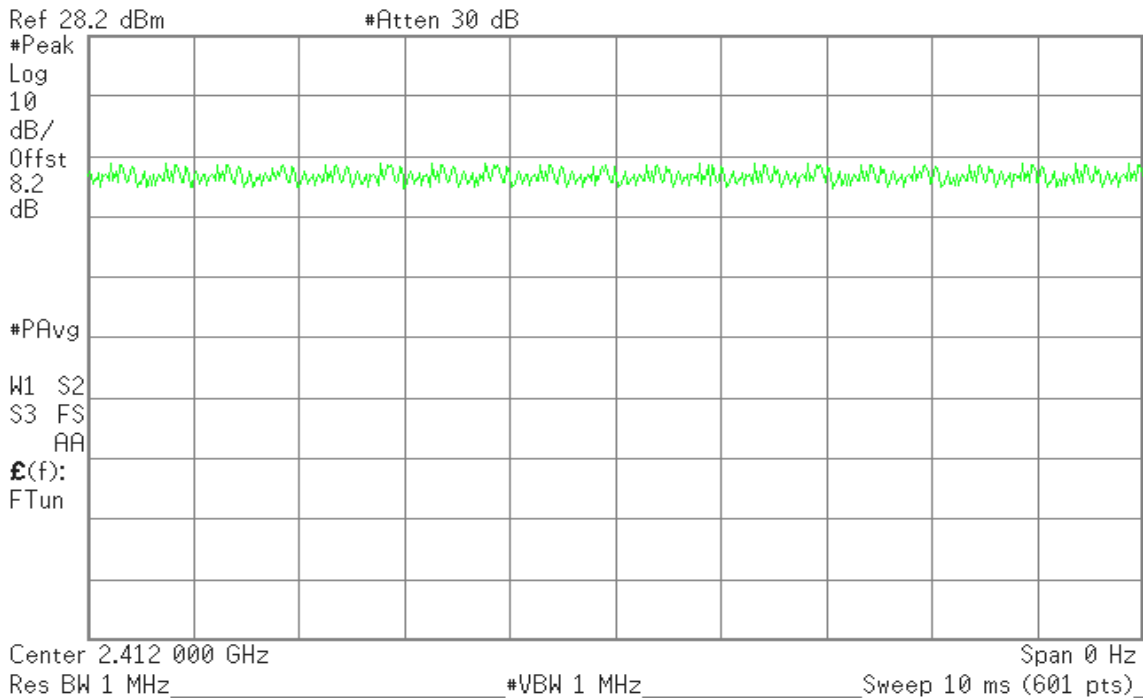



### TEST DATA

Band Edges (IEEE 802.11b mode / CH Low)

Detector mode: Peak

Polarity: Vertical

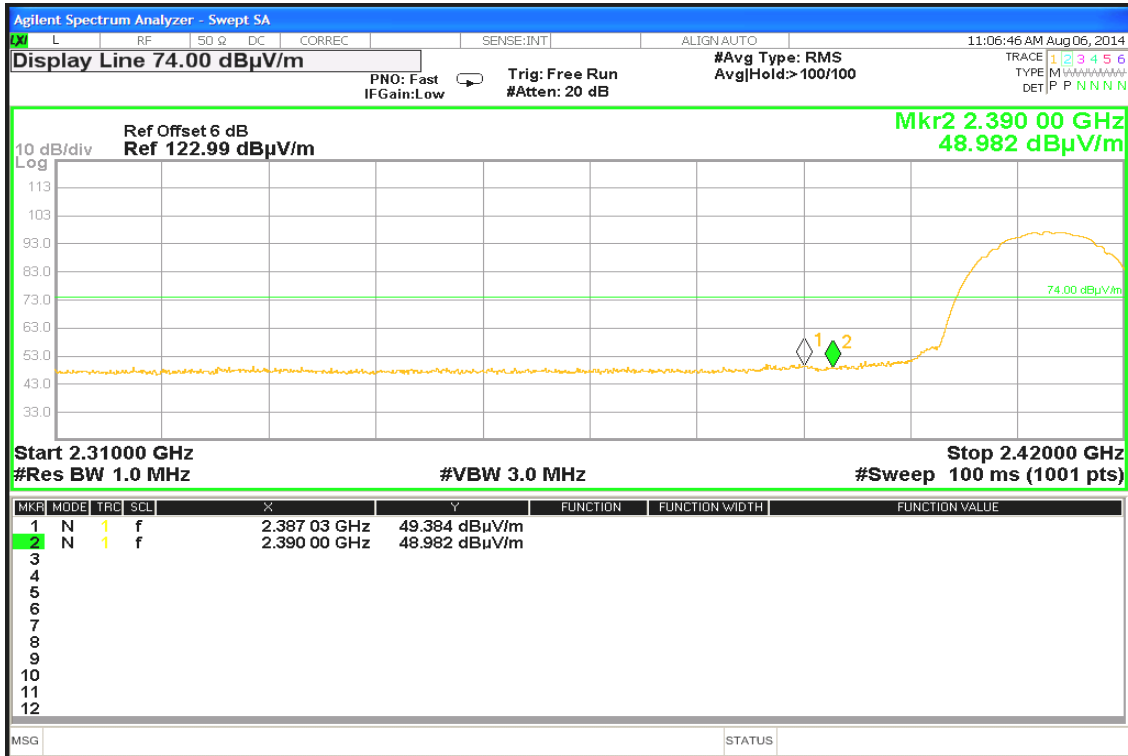

Detector mode: Average

Polarity: Vertical

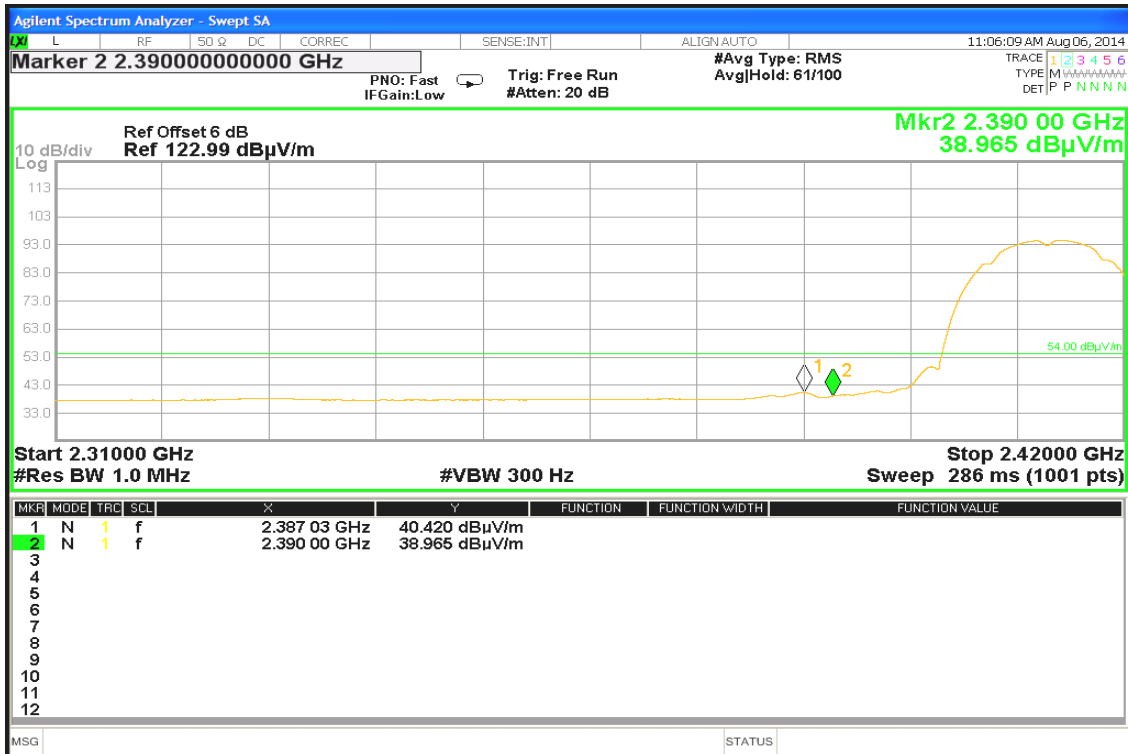



Detector mode: Peak

Polarity: Horizontal

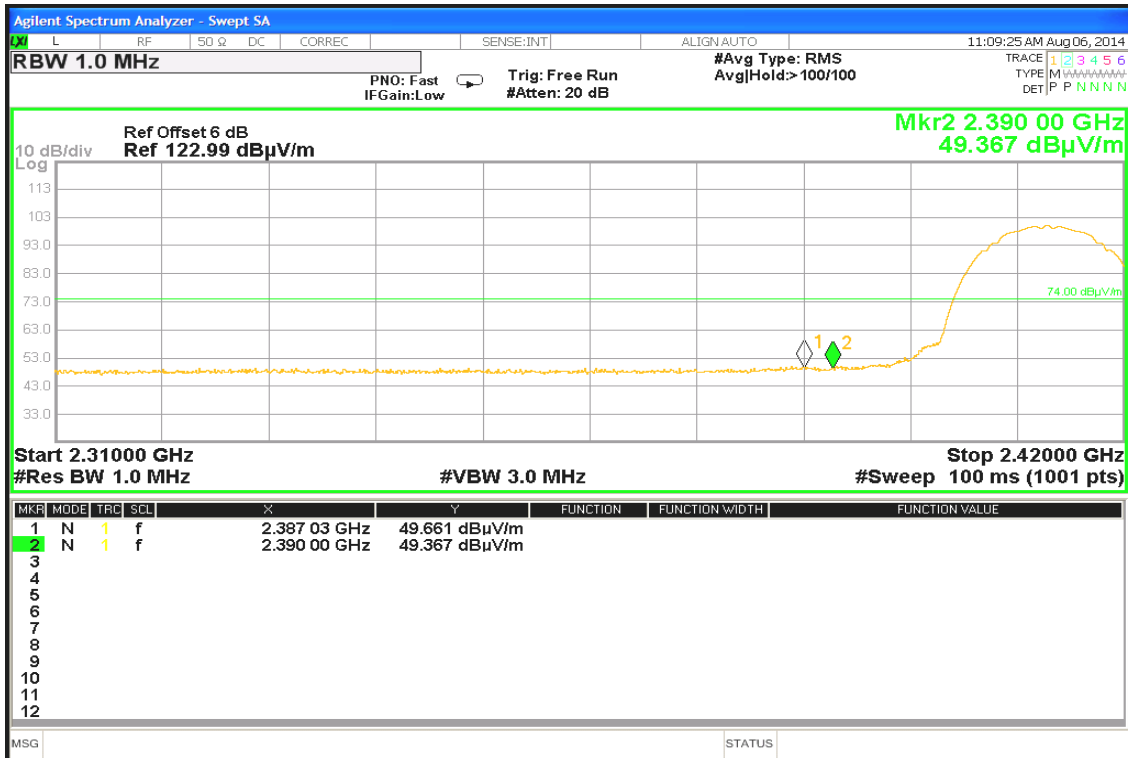

Detector mode: Average

Polarity: Horizontal





Band Edges (IEEE 802.11b mode / CH High)

Detector mode: Peak

Polarity: Vertical

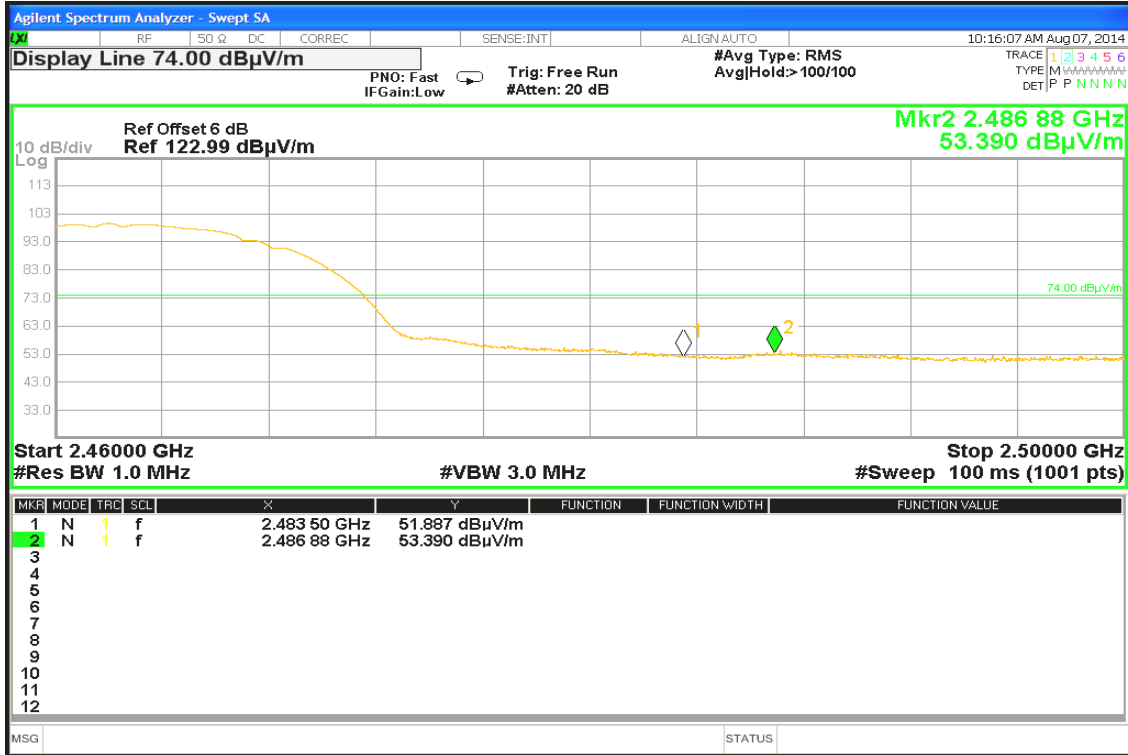

Detector mode: Average

Polarity: Vertical

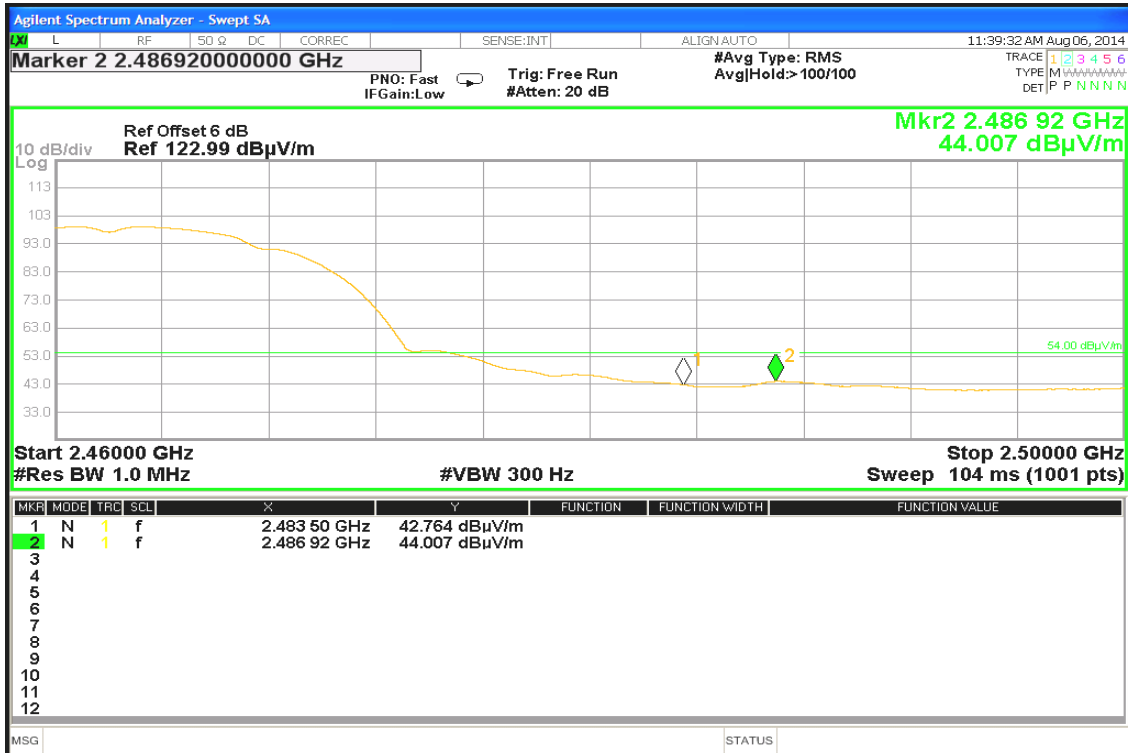



Detector mode: Peak

Polarity: Horizontal

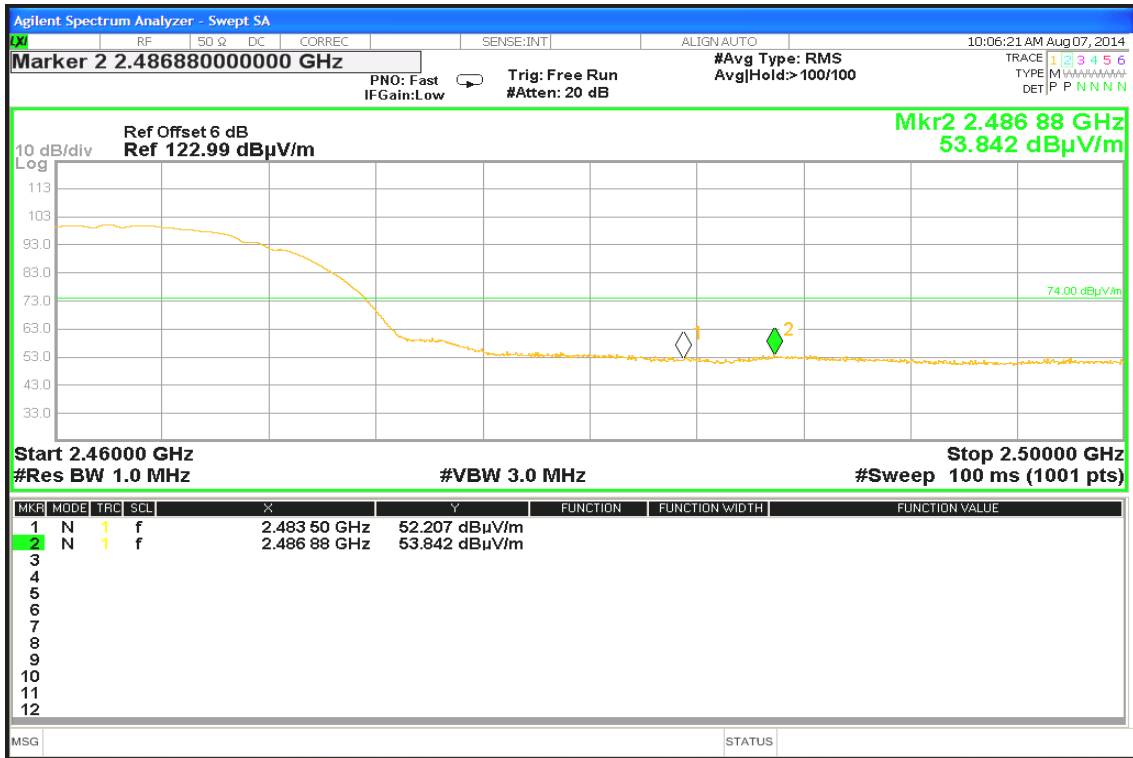

Detector mode: Average

Polarity: Horizontal

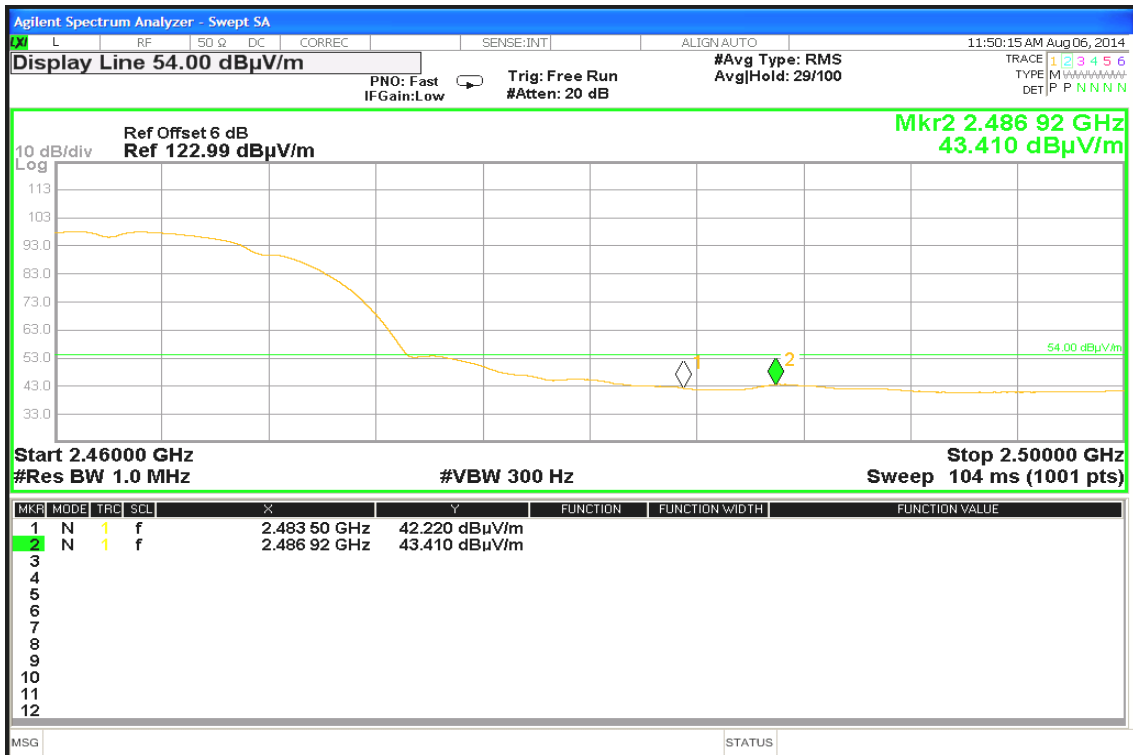



### Band Edges (IEEE 802.11g mode / CH Low)

Detector mode: Peak

Polarity: Vertical

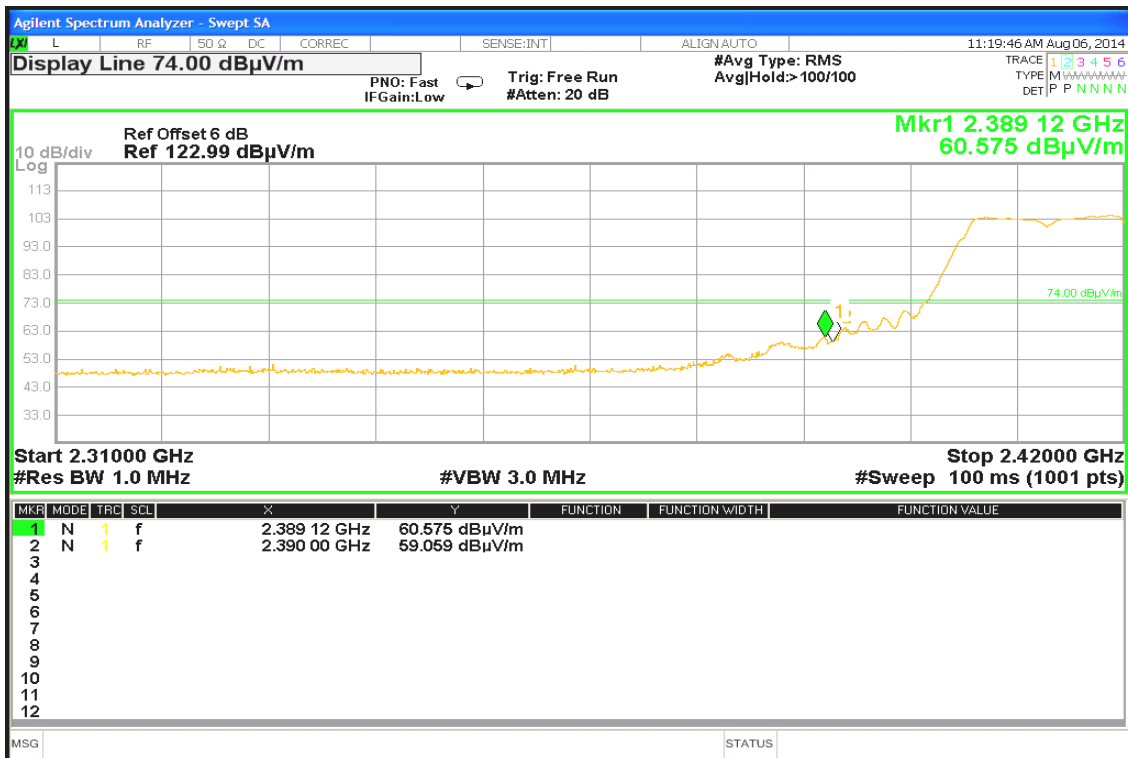

Detector mode: Average

Polarity: Vertical

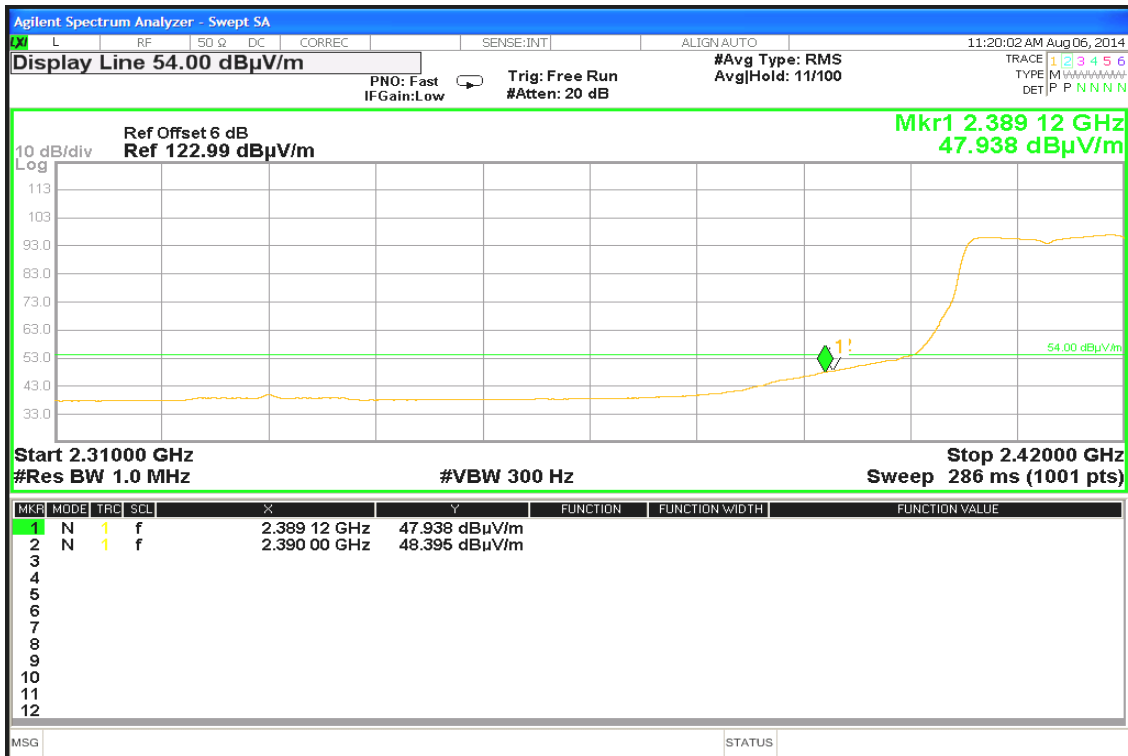



Detector mode: Peak

Polarity: Horizontal

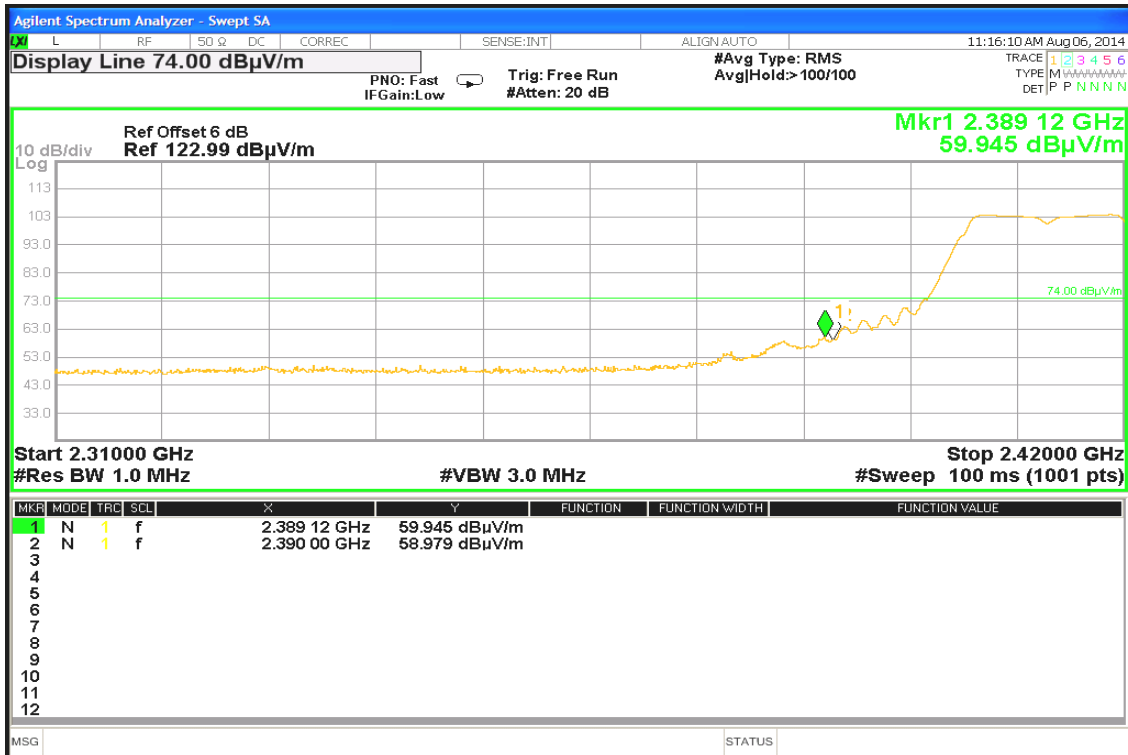

Detector mode: Average

Polarity: Horizontal

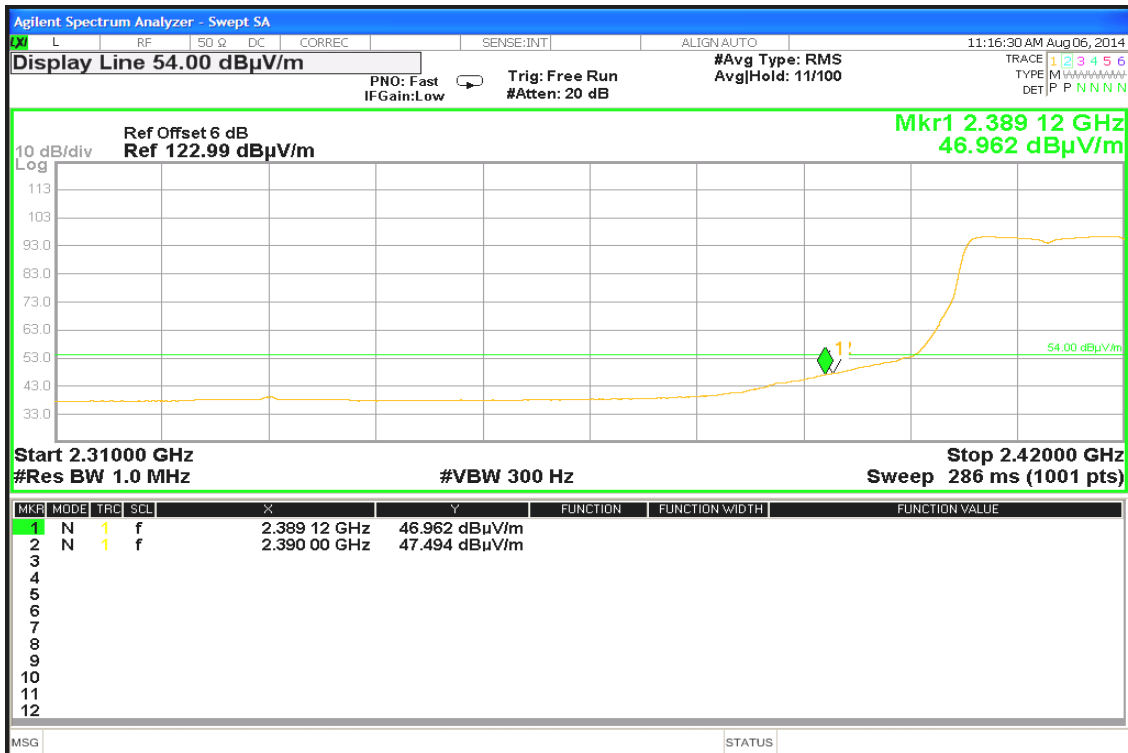



### Band Edges (IEEE 802.11g mode / CH High)

Detector mode: Peak

Polarity: Vertical

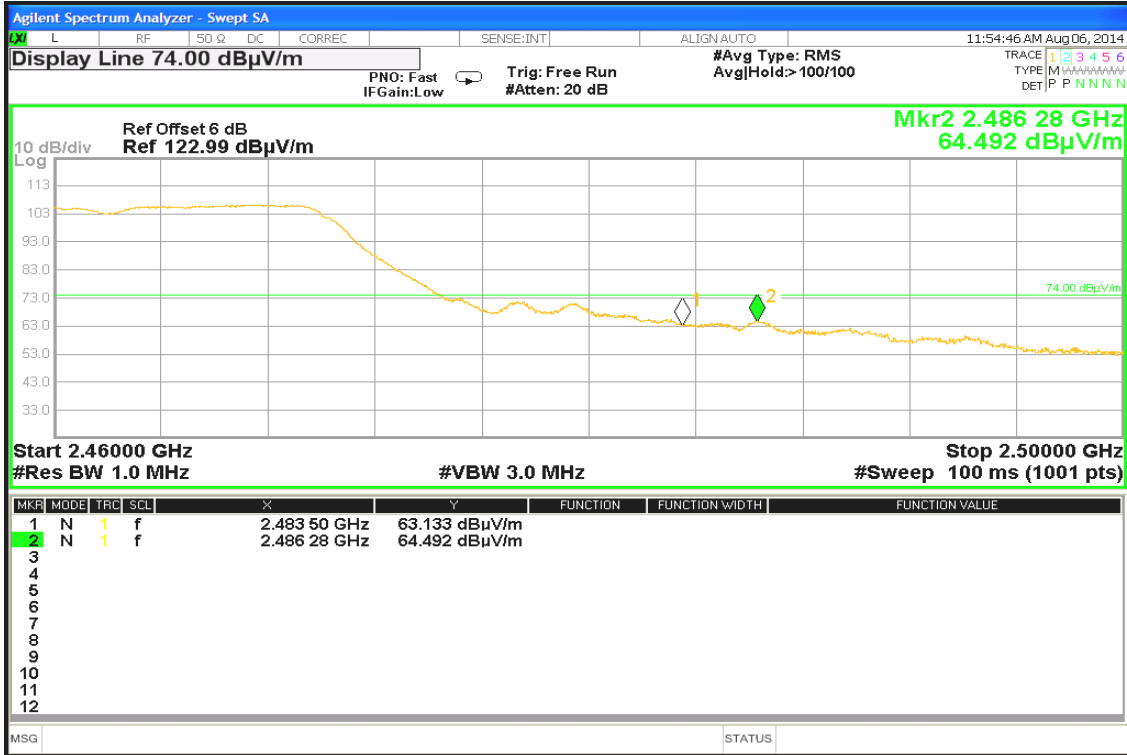

Detector mode: Average

Polarity: Vertical

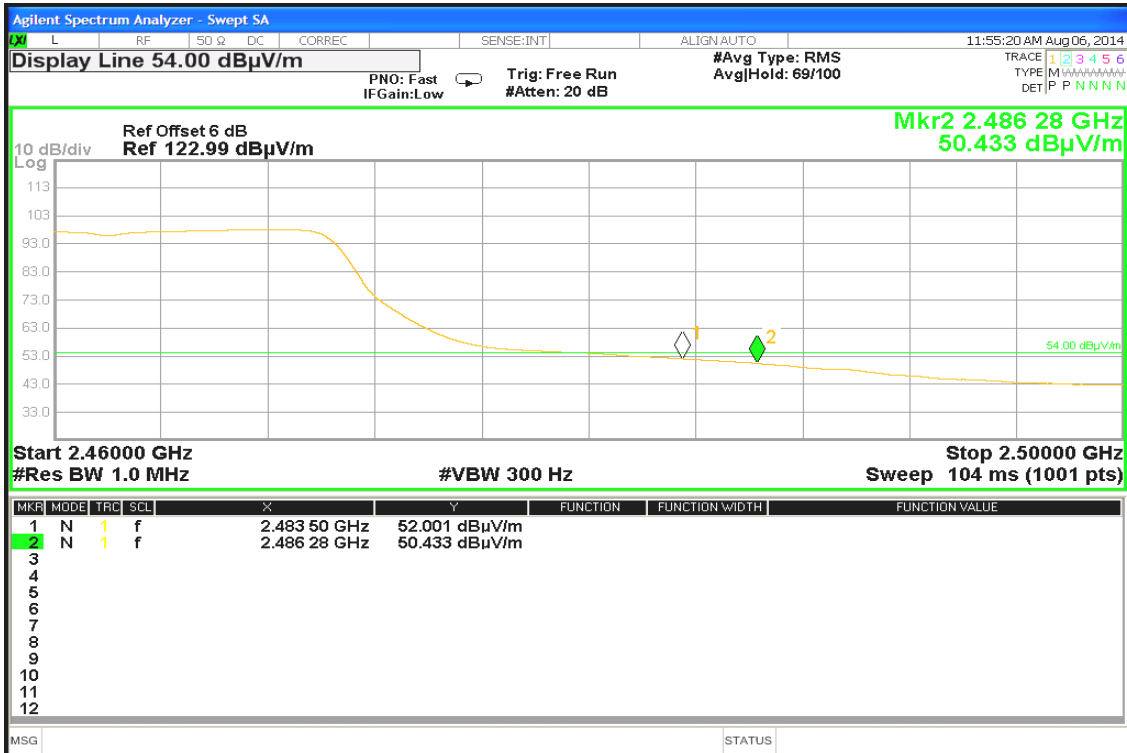



Detector mode: Peak

Polarity: Horizontal

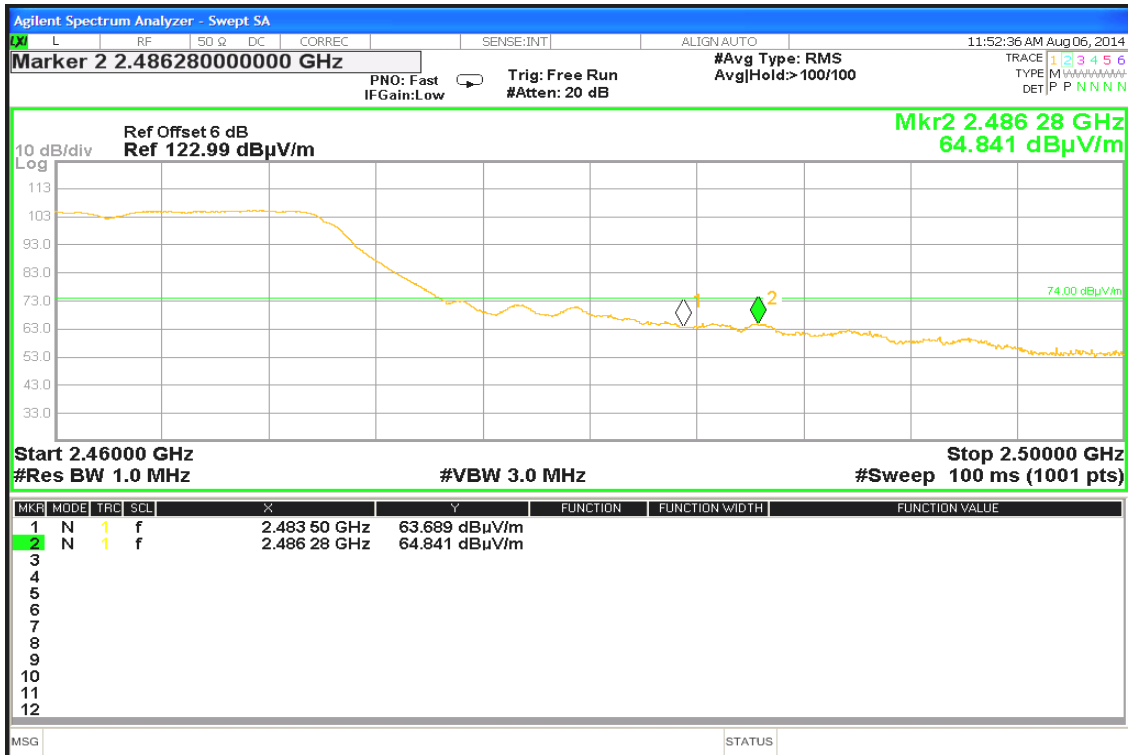

Detector mode: Average

Polarity: Horizontal

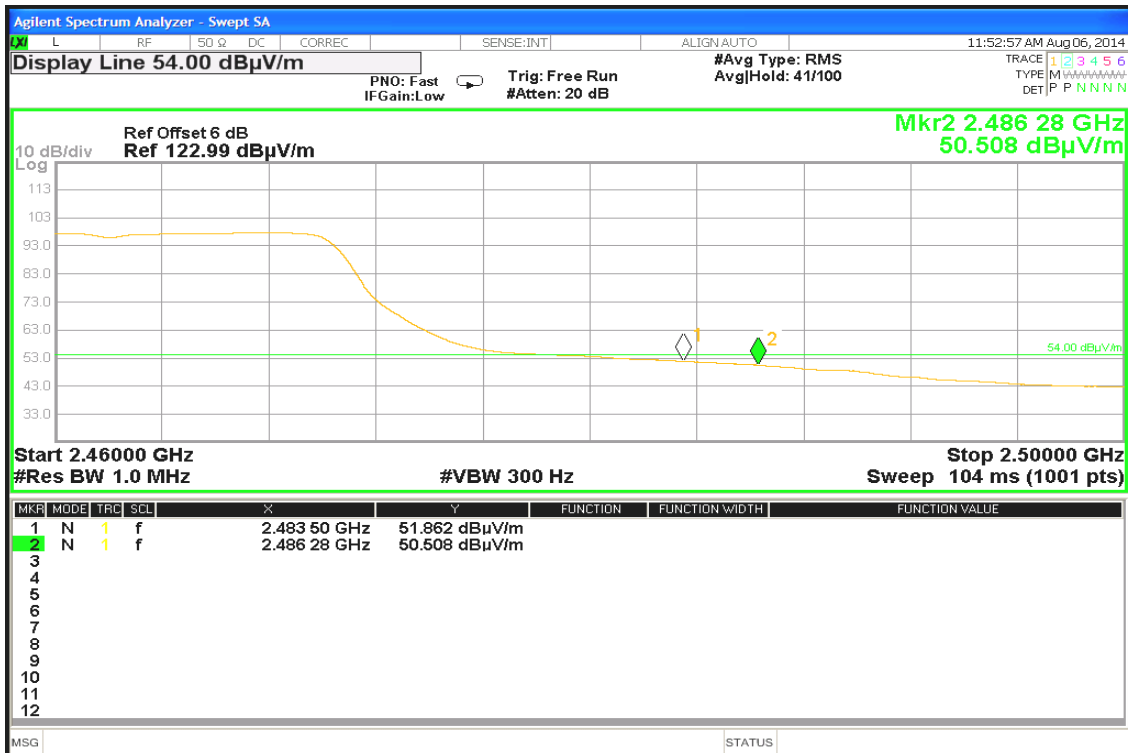



### Band Edges (IEEE 802.11n HT20 mode / CH Low)

Detector mode: Peak

Polarity: Vertical

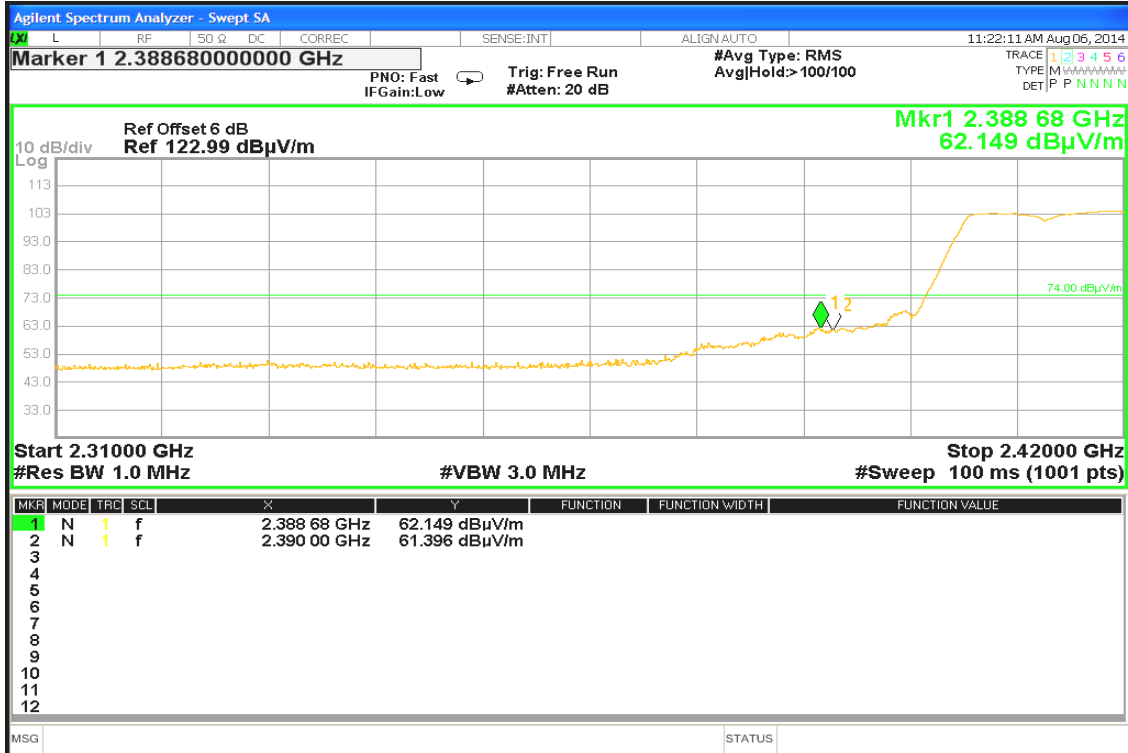

Detector mode: Average

Polarity: Vertical

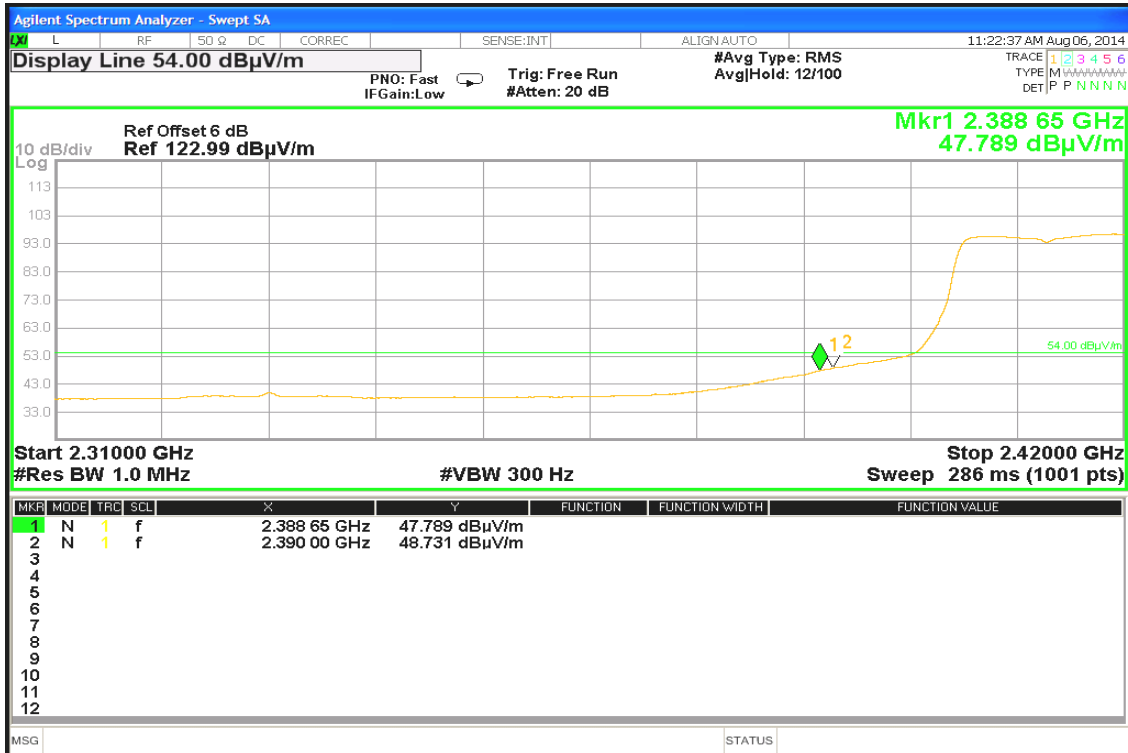



Detector mode: Peak

Polarity: Horizontal

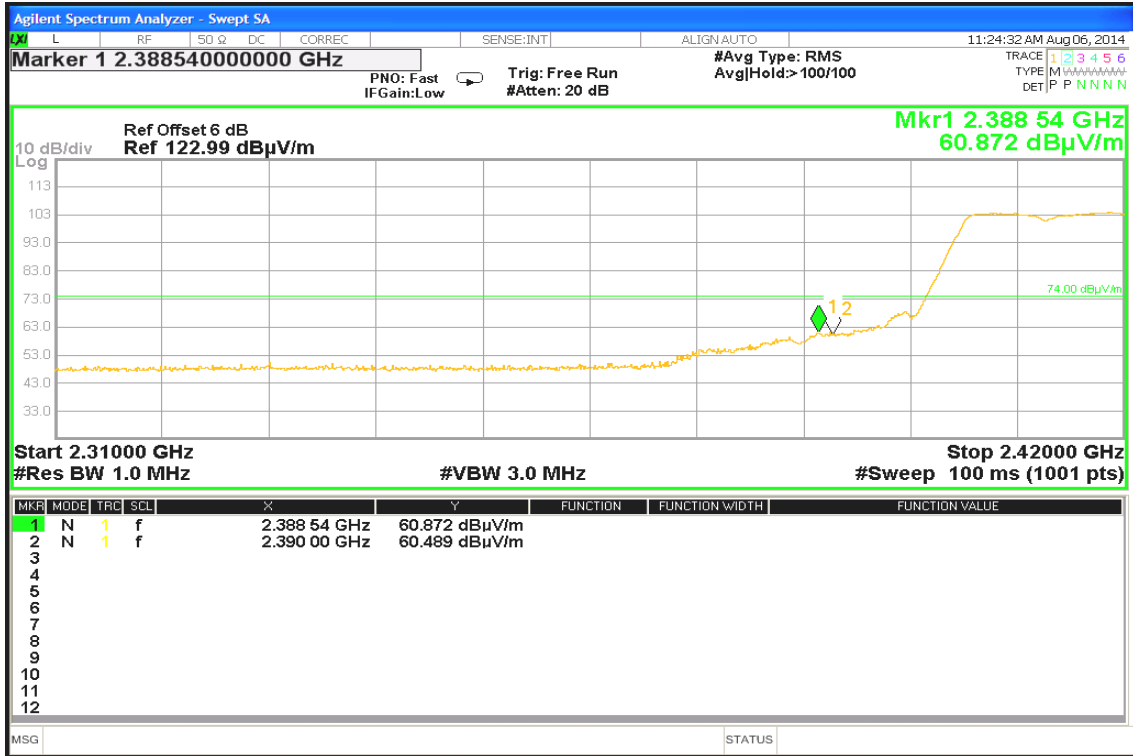

Detector mode: Average

Polarity: Horizontal

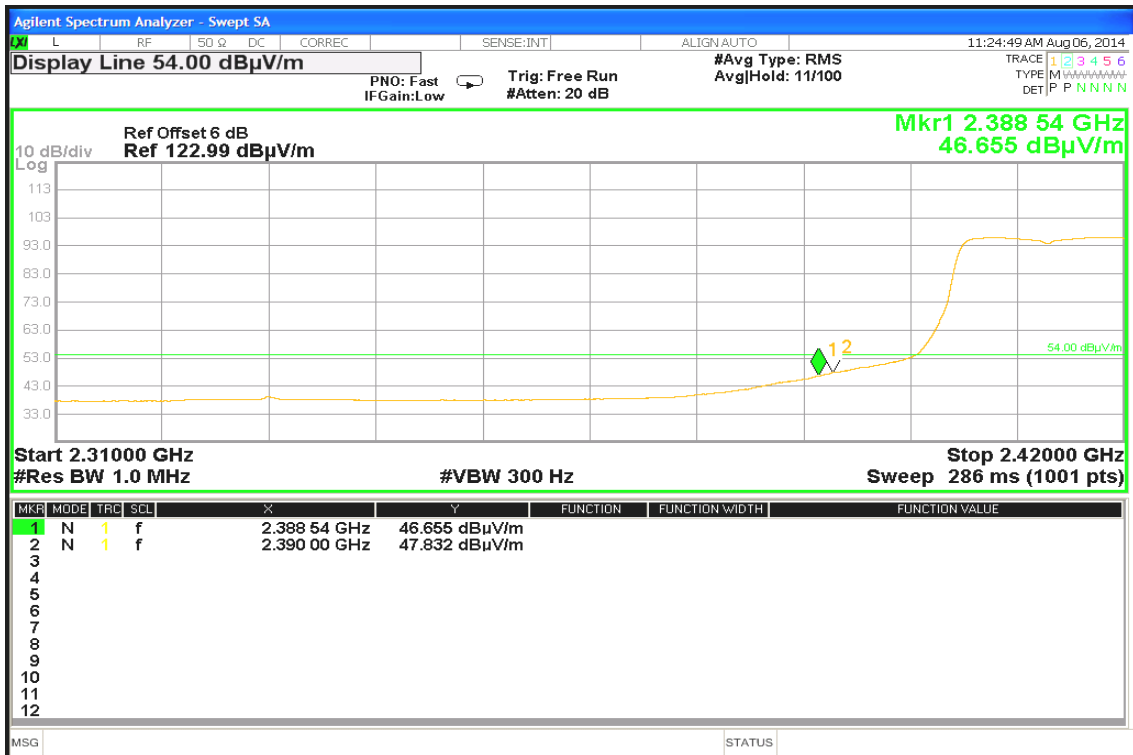



Band Edges (IEEE 802.11n HT20 mode / CH High)

Detector mode: Peak

Polarity: Vertical

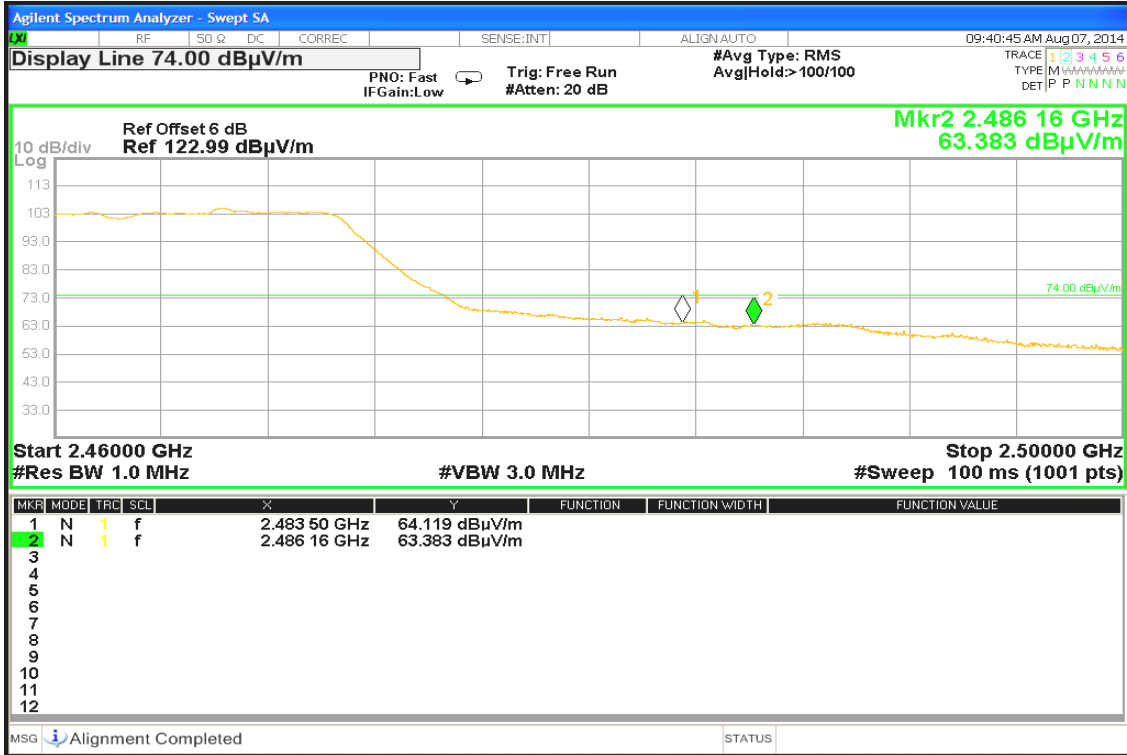

Detector mode: Average

Polarity: Vertical

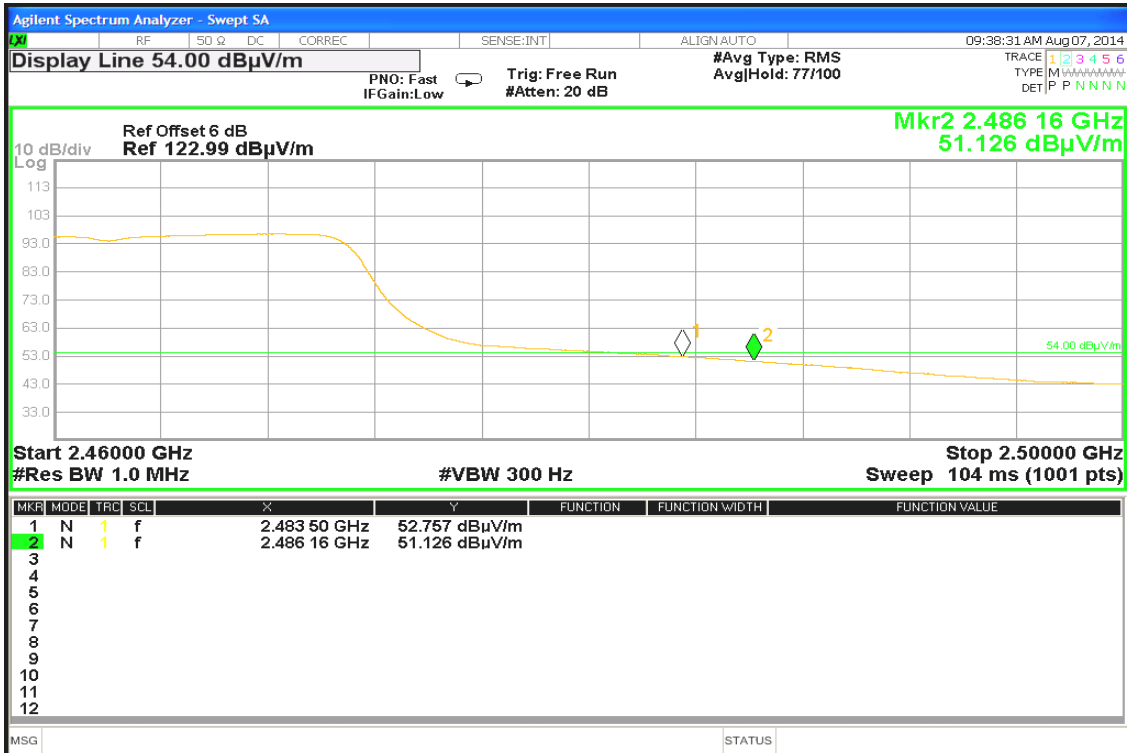



Detector mode: Peak

Polarity: Horizontal

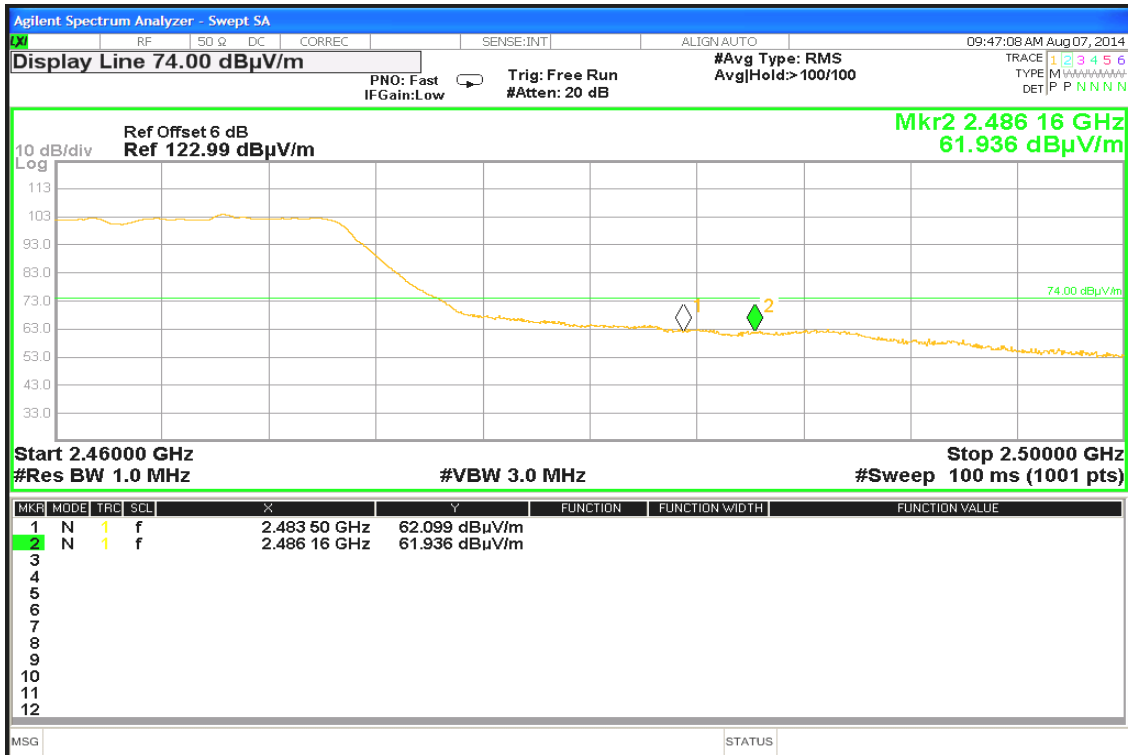

Detector mode: Average

Polarity: Horizontal

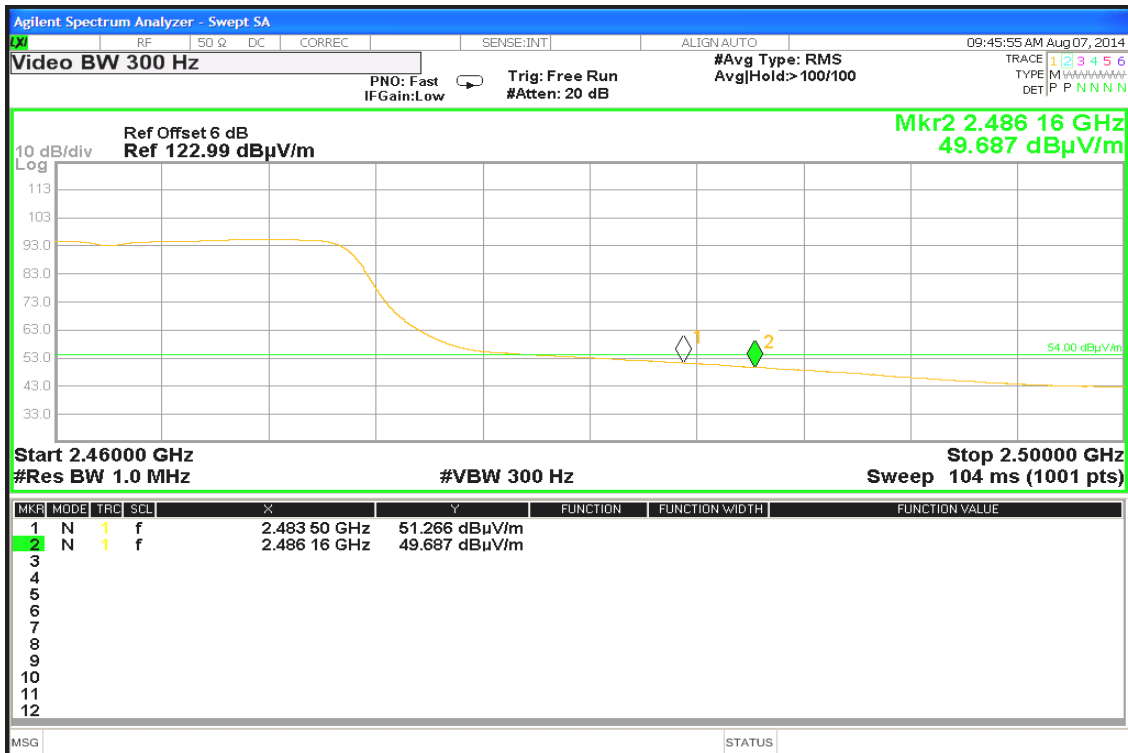



Band Edges (IEEE 802.11n HT40 mode / CH Low)

Detector mode: Peak

Polarity: Vertical

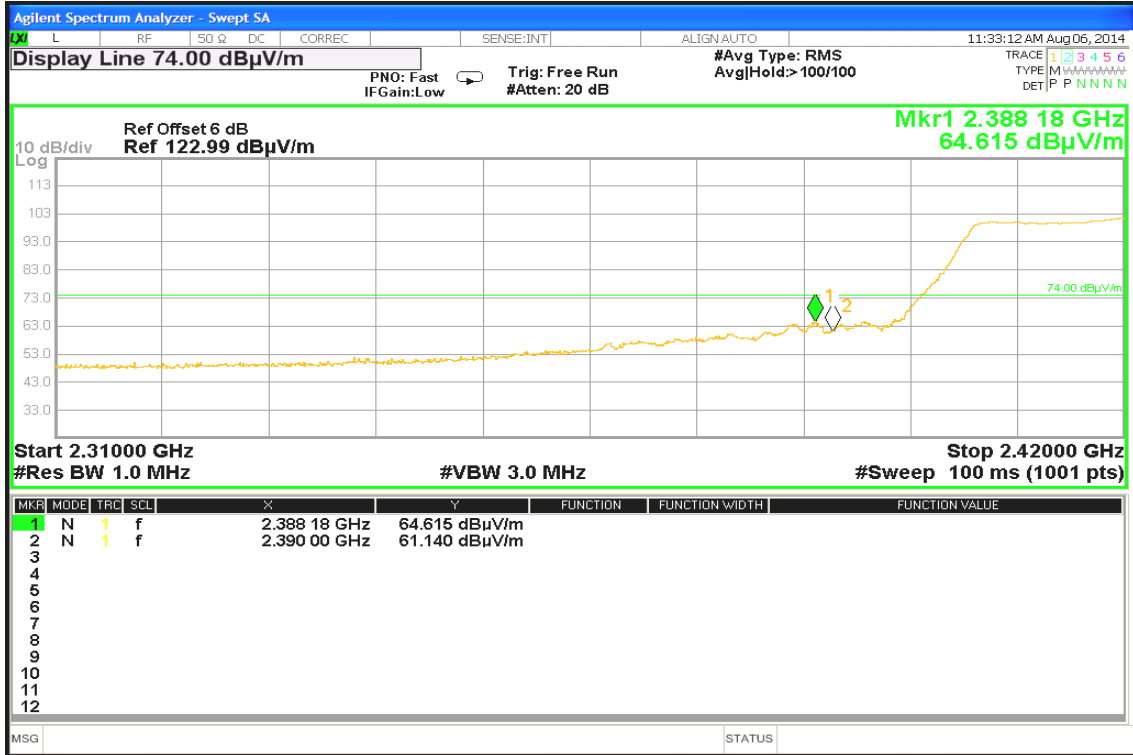

Detector mode: Average

Polarity: Vertical





Detector mode: Peak

Polarity: Horizontal

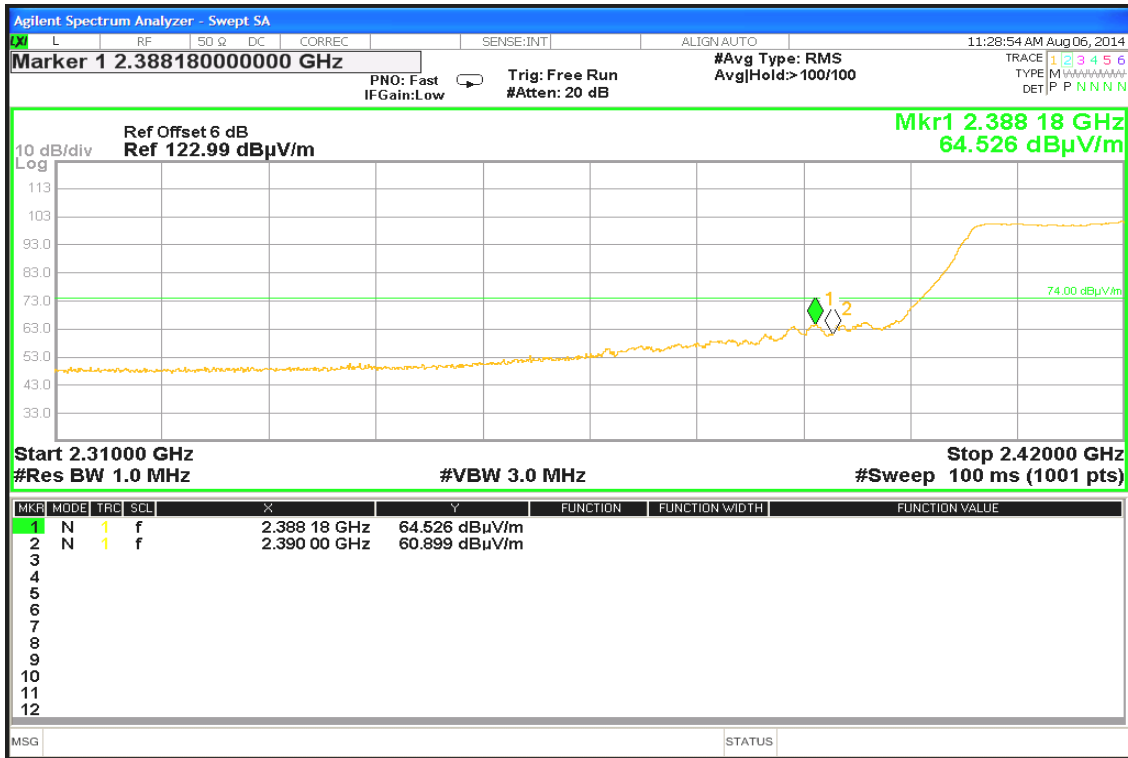

Detector mode: Average

Polarity: Horizontal

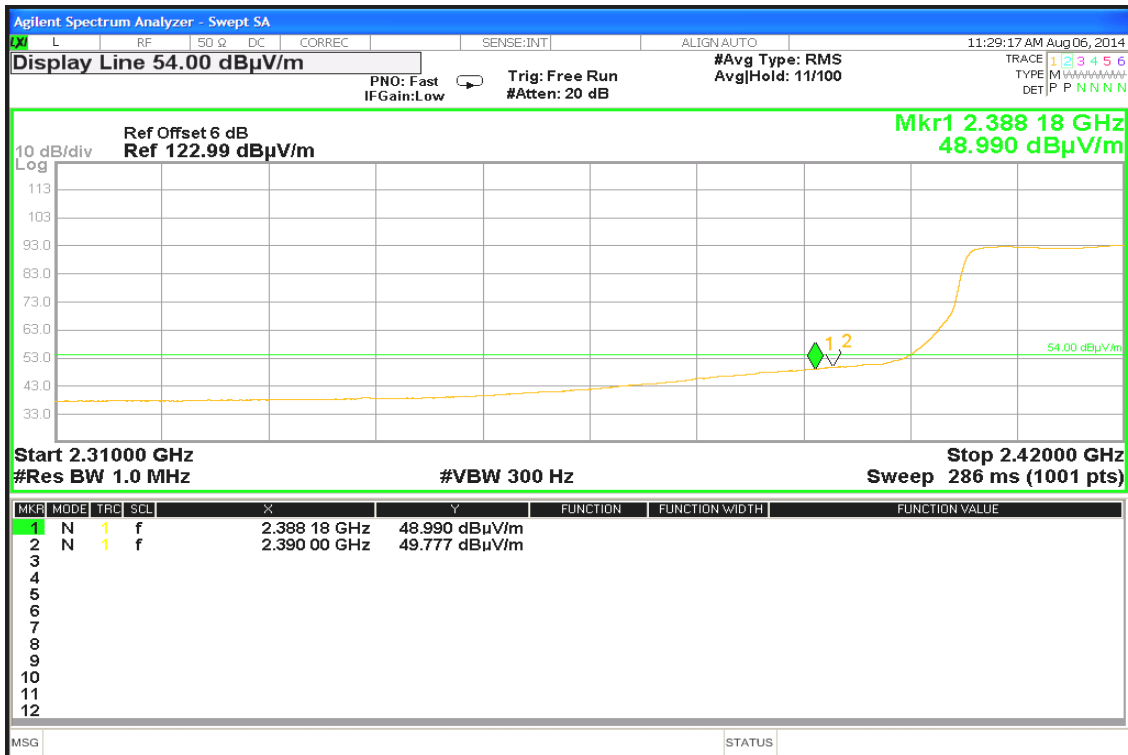



### Band Edges (IEEE 802.11n HT40 mode / CH High)

Detector mode: Peak

Polarity: Vertical

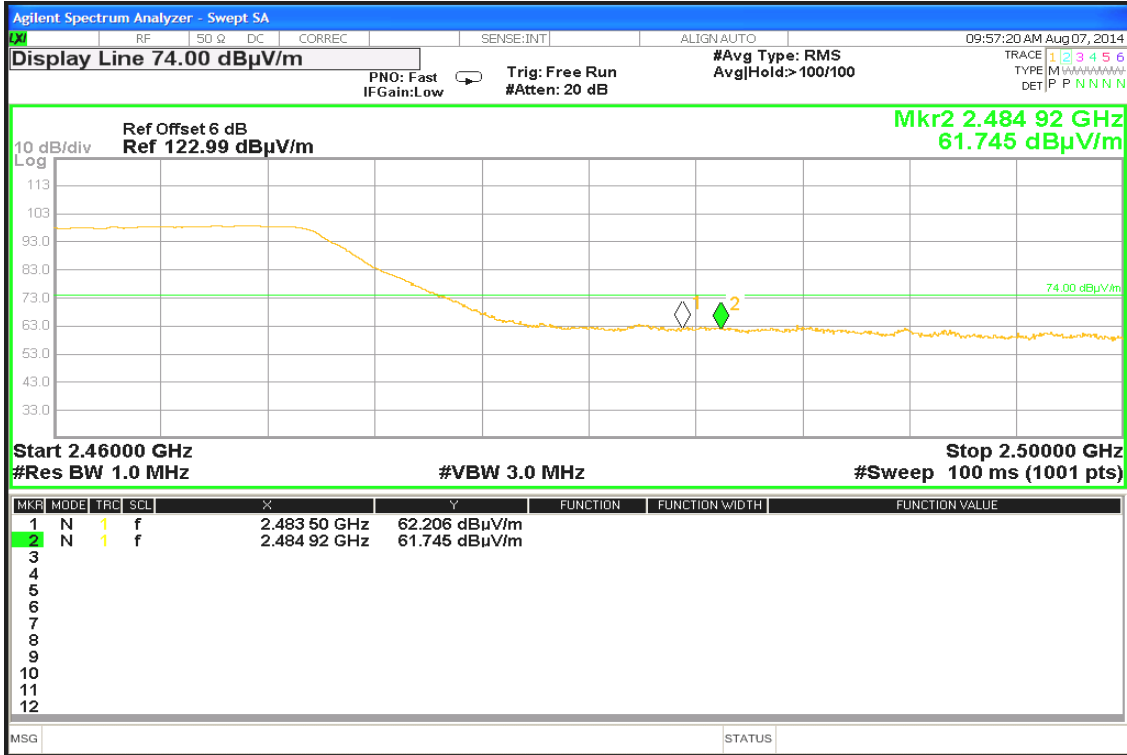

Detector mode: Average

Polarity: Vertical

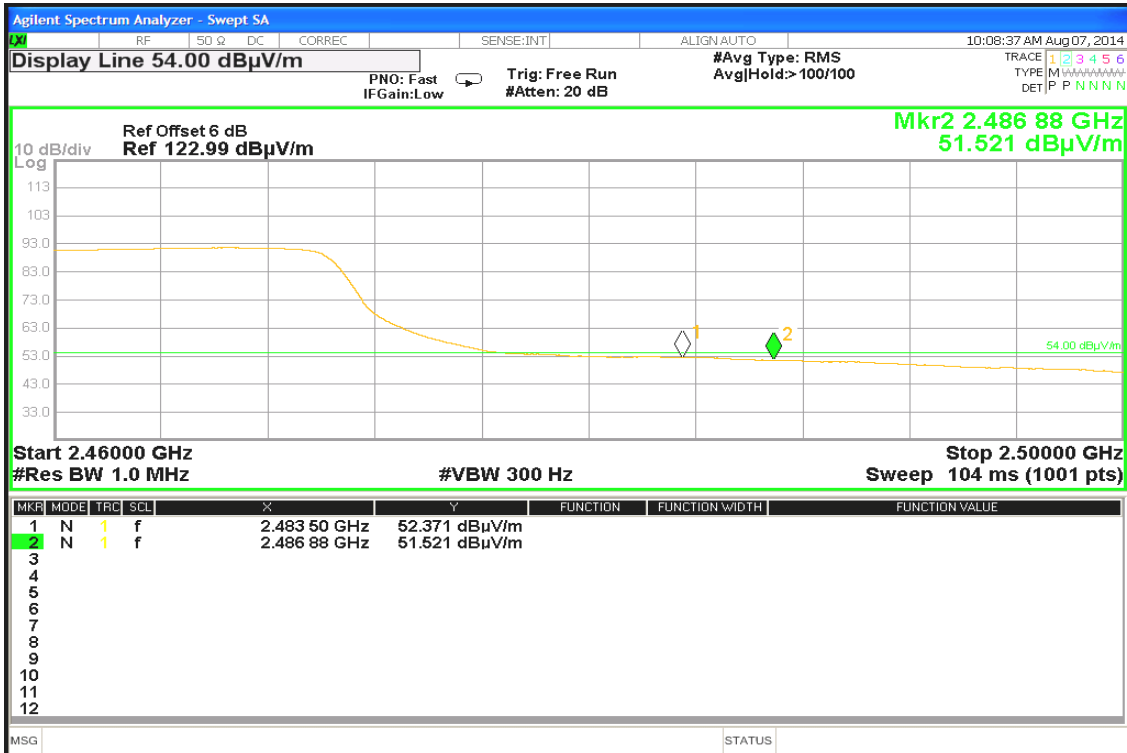



Detector mode: Peak

Polarity: Horizontal

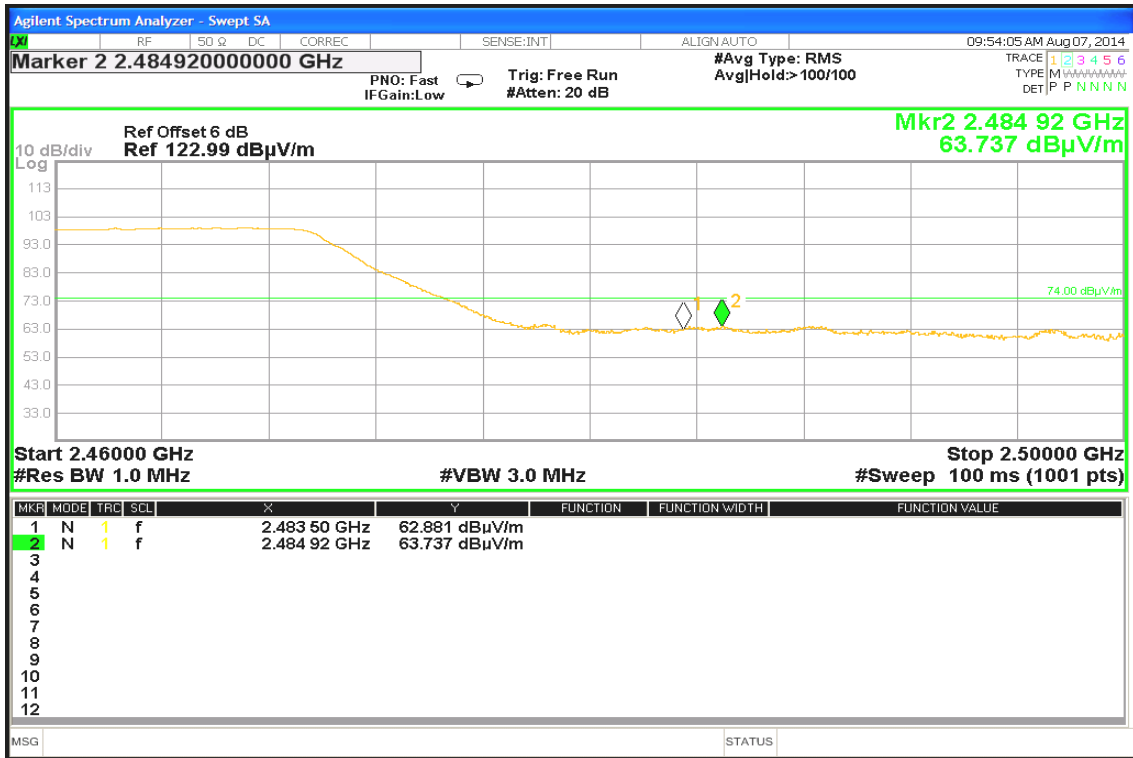

Detector mode: Average

Polarity: Horizontal

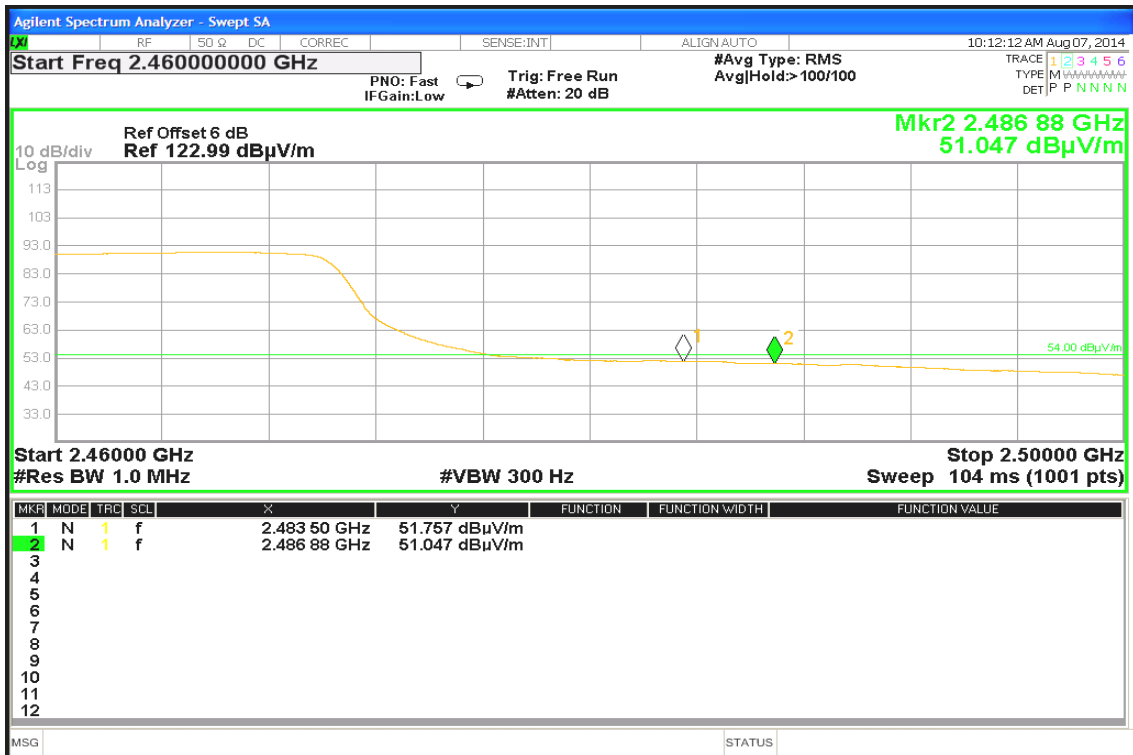



Test Plot

Conducted Band Edges (IEEE 802.11b mode / CH Low)

Agilent

R L

Mkr3 2.411 50 GHz  
3.46 dBm

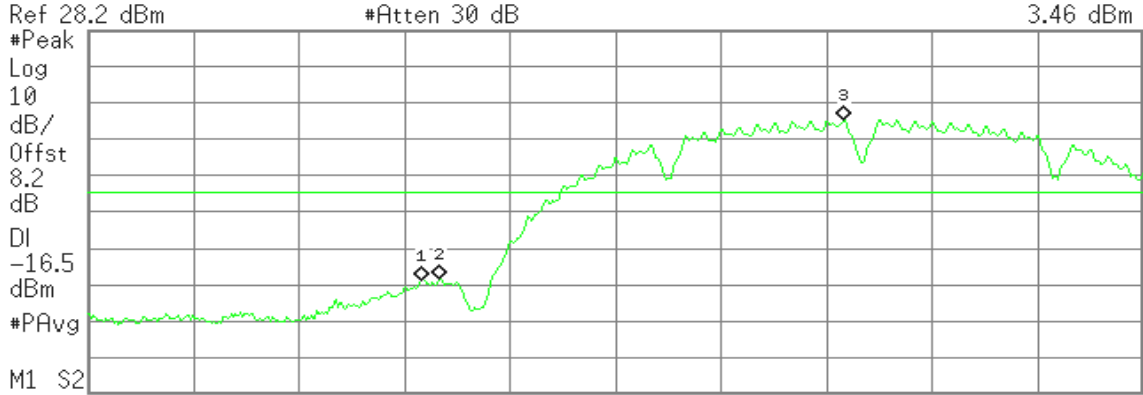

Ref 28.2 dBm #Atten 30 dB Start 2.390 00 GHz Stop 2.420 00 GHz  
#Res BW 100 kHz #VBW 100 kHz Sweep 3.64 ms (601 pts)

Marker	Trace	Type	X Axis	Amplitude
1	(1)	Freq	2.399 50 GHz	-40.55 dBm
2	(1)	Freq	2.400 00 GHz	-40.41 dBm
3	(1)	Freq	2.411 50 GHz	3.46 dBm

Conducted Band Edges (IEEE 802.11b mode / CH High)

Agilent

R L

Mkr1 2.461 53 GHz  
2.95 dBm

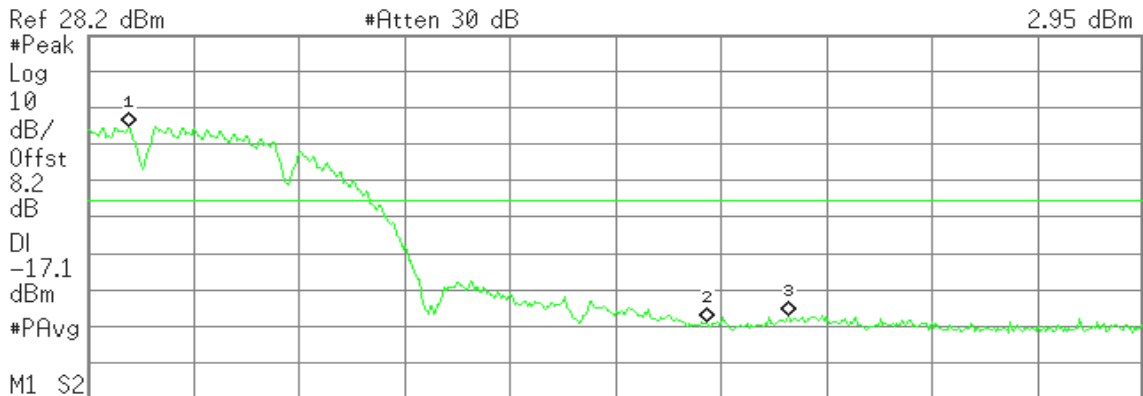

Ref 28.2 dBm #Atten 30 dB Start 2.460 00 GHz Stop 2.500 00 GHz  
#Res BW 100 kHz #VBW 100 kHz Sweep 4.84 ms (601 pts)

Marker	Trace	Type	X Axis	Amplitude
1	(1)	Freq	2.461 53 GHz	2.95 dBm
2	(1)	Freq	2.483 50 GHz	-50.50 dBm
3	(1)	Freq	2.486 53 GHz	-49.02 dBm



### Conducted Band Edges (IEEE 802.11g mode / CH Low)

Agilent

R L

Mkr2 2.405 20 GHz  
0.87 dBm

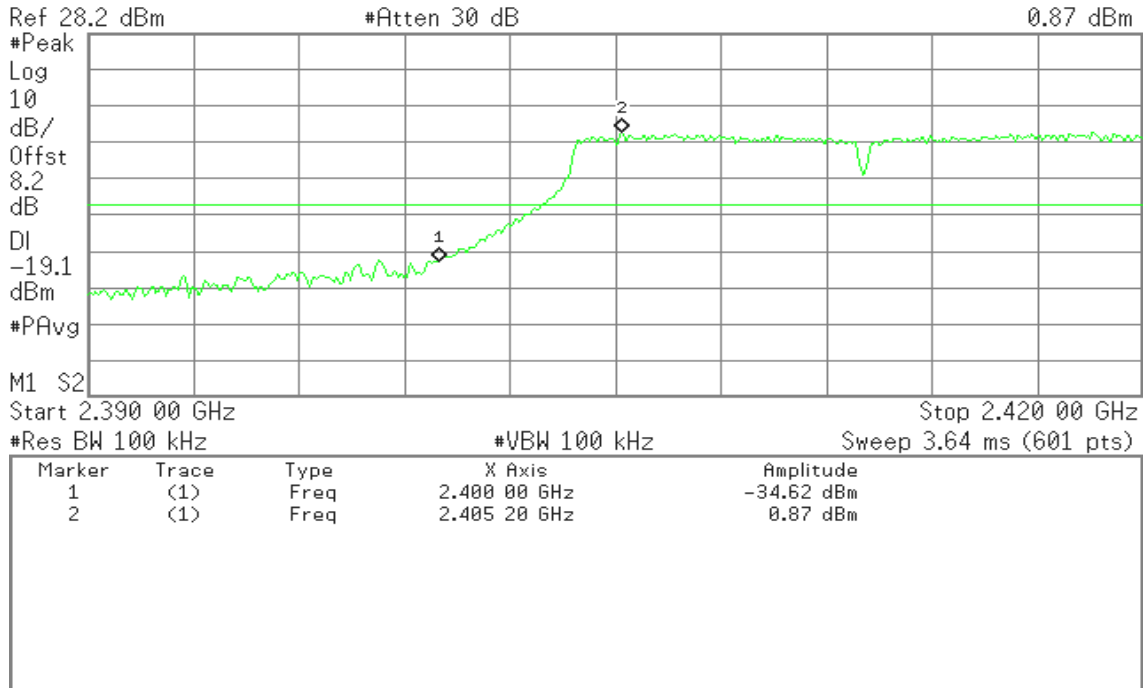

### Conducted Band Edges (IEEE 802.11g mode / CH High)

Agilent

R L

Mkr1 2.466 20 GHz  
1.19 dBm

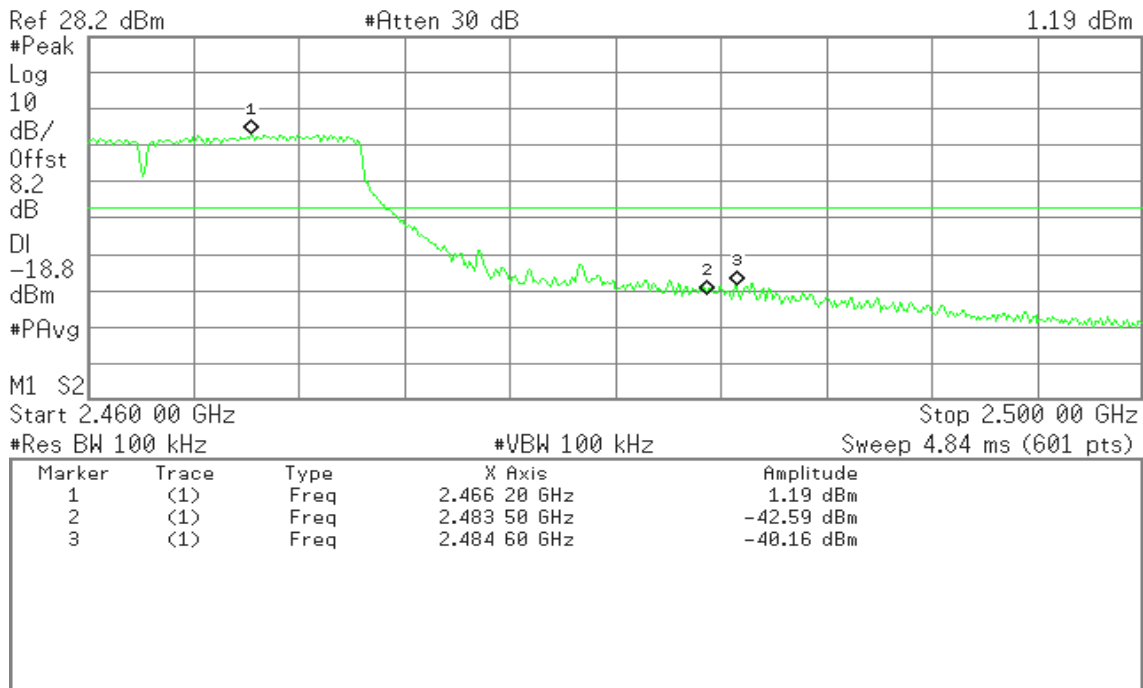



### Conducted Band Edges (IEEE 802.11n HT20 mode / CH Low)

Agilent

R L

Mkr2 2.406 65 GHz

1.29 dBm

Ref 28.2 dBm

#Atten 30 dB

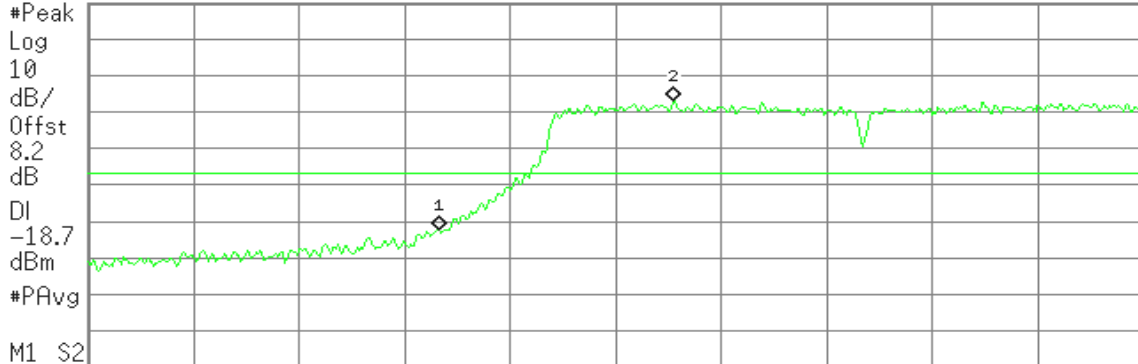

Start 2.390 00 GHz

Stop 2.420 00 GHz

#Res BW 100 kHz

#VBW 100 kHz

Sweep 3.64 ms (601 pts)

Marker	Trace	Type	X Axis	Amplitude
1	(1)	Freq	2.400 00 GHz	-34.31 dBm
2	(1)	Freq	2.406 65 GHz	1.29 dBm

### Conducted Band Edges (IEEE 802.11n HT20 mode / CH High)

Agilent

R L

Mkr1 2.469 60 GHz

0.99 dBm

Ref 28.2 dBm

#Atten 30 dB

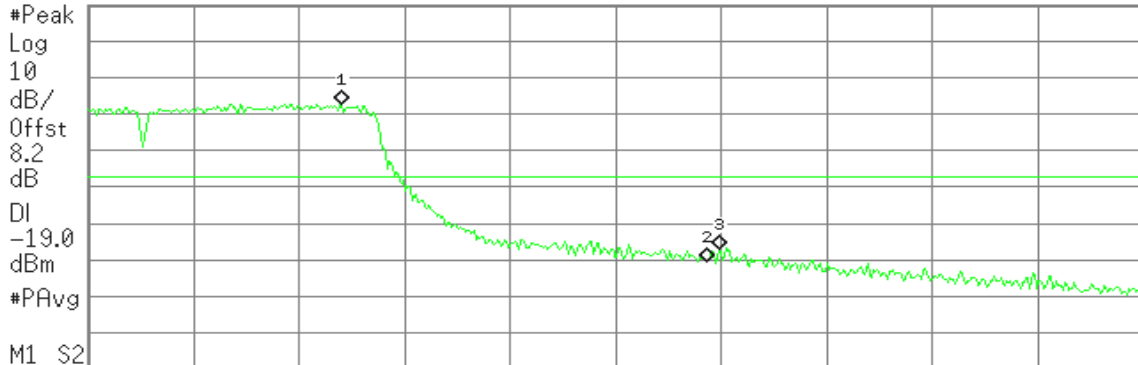

Start 2.460 00 GHz

Stop 2.500 00 GHz

#Res BW 100 kHz

#VBW 100 kHz

Sweep 4.84 ms (601 pts)

Marker	Trace	Type	X Axis	Amplitude
1	(1)	Freq	2.469 60 GHz	0.99 dBm
2	(1)	Freq	2.483 50 GHz	-42.29 dBm
3	(1)	Freq	2.483 93 GHz	-39.05 dBm



### Conducted Band Edges (IEEE 802.11n HT40 mode / CH Low)

Agilent

R L

Mkr2 2.417 90 GHz  
-2.72 dBm

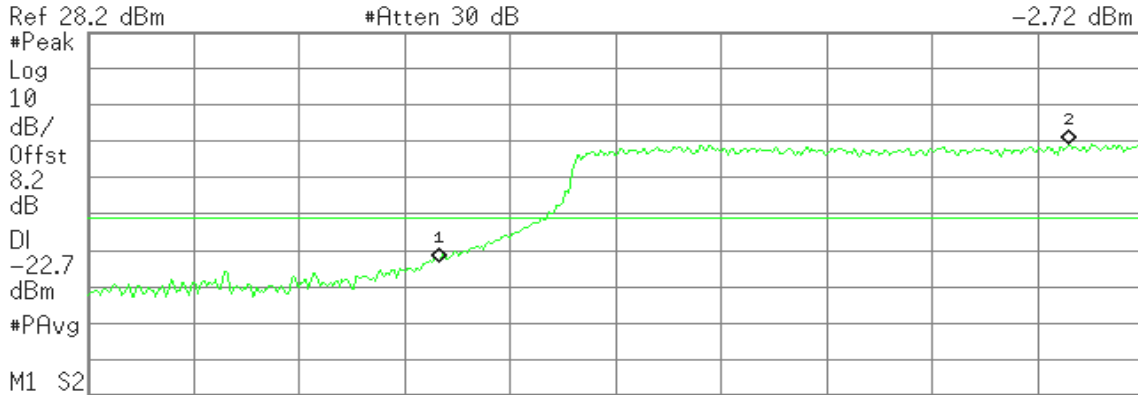

#Res BW 100 kHz #VBW 100 kHz Sweep 3.64 ms (601 pts)

Marker	Trace	Type	X Axis	Amplitude
1	(1)	Freq	2.400 00 GHz	-34.81 dBm
2	(1)	Freq	2.417 90 GHz	-2.72 dBm

### Conducted Band Edges (IEEE 802.11n HT40 mode / CH High)

Agilent

R T

Mkr1 2.465 47 GHz  
-3.74 dBm



#Res BW 100 kHz #VBW 100 kHz Sweep 4.84 ms (601 pts)

Marker	Trace	Type	X Axis	Amplitude
1	(1)	Freq	2.465 47 GHz	-3.74 dBm
2	(1)	Freq	2.483 50 GHz	-41.70 dBm
3	(1)	Freq	2.485 20 GHz	-40.13 dBm



## **7.5 PEAK POWER SPECTRAL DENSITY**

### **LIMIT**

1. According to §15.247(e), for digitally modulated systems, the power spectral density conducted from the intentional radiator to the antenna shall not be greater than 8 dBm in any 3 kHz band during any time interval of continuous transmission.
2. According to §15.247(f), the digital modulation operation of the hybrid system, with the frequency hopping turned off, shall comply with the power density requirements of paragraph (d) of this section.

### **Test Configuration**

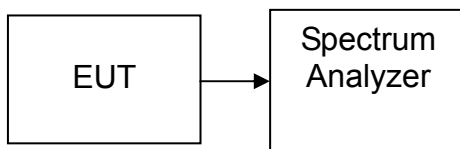

## **TEST PROCEDURE**

### **Per KDB 558074 v03r02**

This procedure must be used if maximum peak conducted output power was used to demonstrate compliance to the fundamental output power limit, and is optional if the maximum (average) conducted output power was used to demonstrate compliance.

1. Set analyzer center frequency to DTS channel center frequency.
2. Set the span to 1.5 times the DTS channel bandwidth.
3. Set the RBW  $\geq$  3 kHz.
4. Set the VBW  $\geq$  3 x RBW.
5. Detector = peak.
6. Sweep time = auto couple.
7. Trace mode = max hold.
8. Allow trace to fully stabilize.

Use the peak marker function to determine the maximum amplitude level.

If measured value exceeds limit, reduce RBW (no less than 3 kHz) and repeat

## **TEST RESULTS**

*No non-compliance noted*



**Test Data**

**Test mode: IEEE 802.11b mode**

Channel	Frequency (MHz)	PPSD (dBm)	Limit (dBm)	Result
Low	2412	-16.59	8.00	PASS
Mid	2437	-16.13		PASS
High	2462	-16.47		PASS

**Test mode: IEEE 802.11g mode**

Channel	Frequency (MHz)	PPSD (dBm)	Limit (dBm)	Result
Low	2412	-12.09	8.00	PASS
Mid	2437	-10.27		PASS
High	2462	-10.10		PASS

**Test mode: IEEE 802.11n HT20 mode**

Channel	Frequency (MHz)	PPSD (dBm)	Limit (dBm)	Result
Low	2412	-11.79	8.00	PASS
Mid	2437	-11.30		PASS
High	2462	-10.82		PASS

**Test mode: IEEE 802.11n HT40 mode**

Channel	Frequency (MHz)	PPSD (dBm)	Limit (dBm)	Result
Low	2422	-14.85	8.00	PASS
Mid	2437	-14.89		PASS
High	2452	-16.88		PASS



**Test Plot**

**IEEE 802.11b mode  
PPSD (CH Low)**

Agilent

R L

Mkr1 2.411 35 GHz  
-16.59 dBm

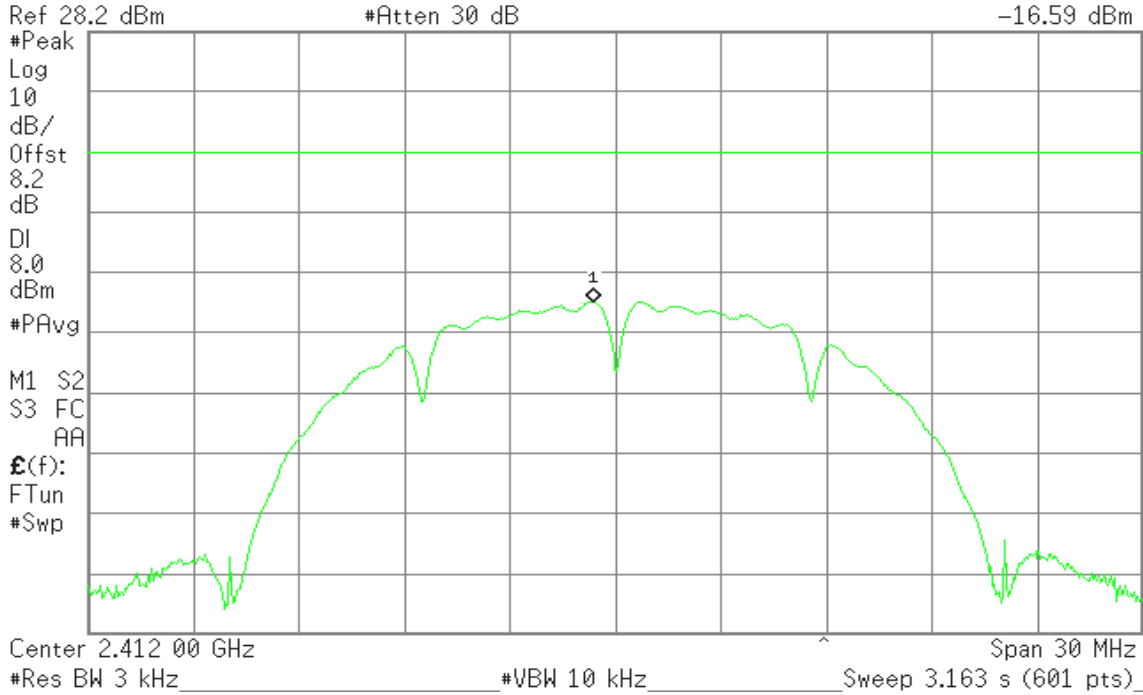

**PPSD (CH Mid)**

Agilent

R L

Mkr1 2.436 35 GHz  
-16.13 dBm

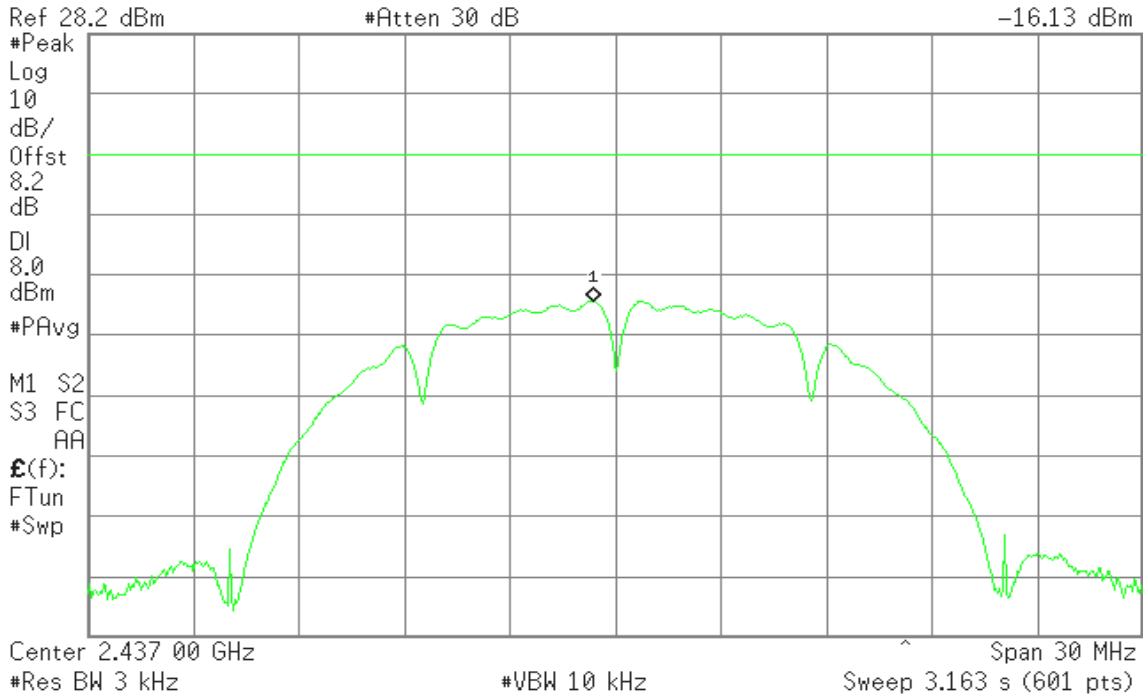



### PPSD (CH High)

Agilent

R L

Mkr1 2.462 80 GHz  
-16.47 dBm

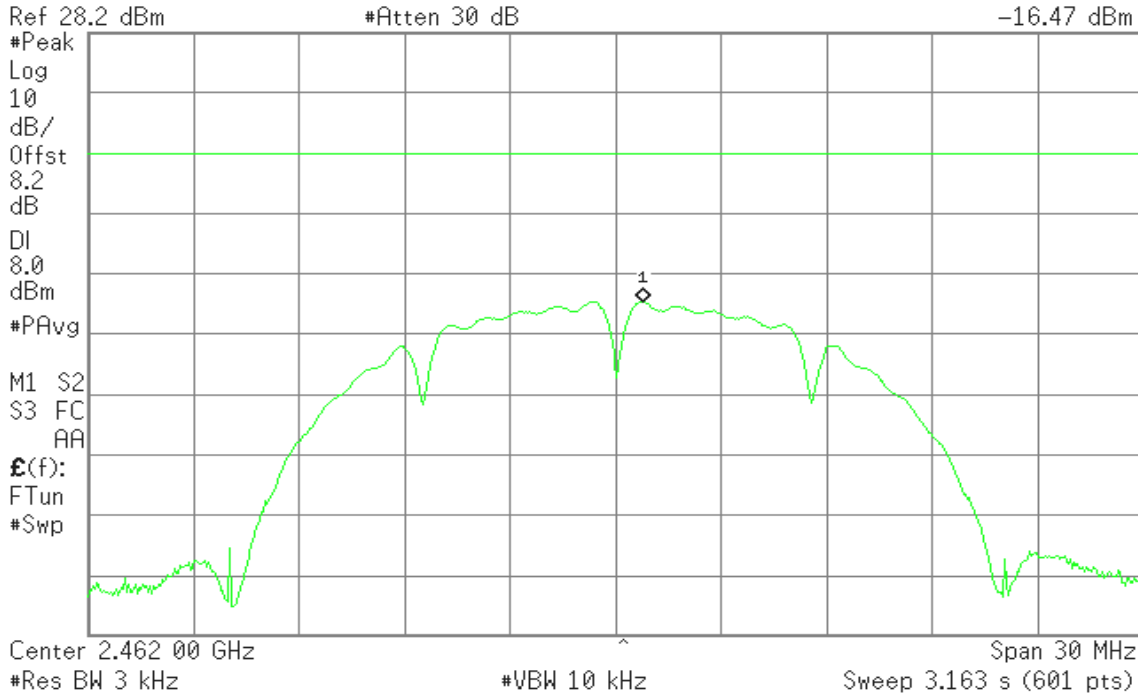

### IEEE 802.11g mode

### PPSD (CH Low)

Agilent

R L

Mkr1 2.417 70 GHz  
-12.09 dBm

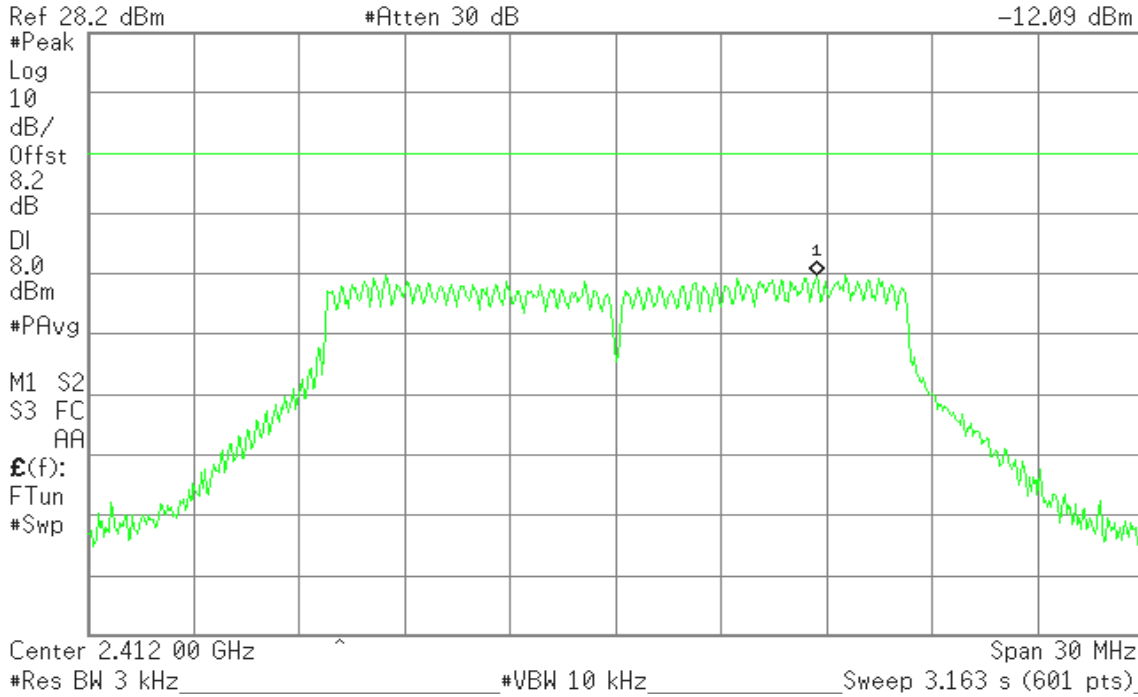



### PPSD (CH Mid)

Agilent

R T

Mkr1 2.443 65 GHz  
-10.27 dBm

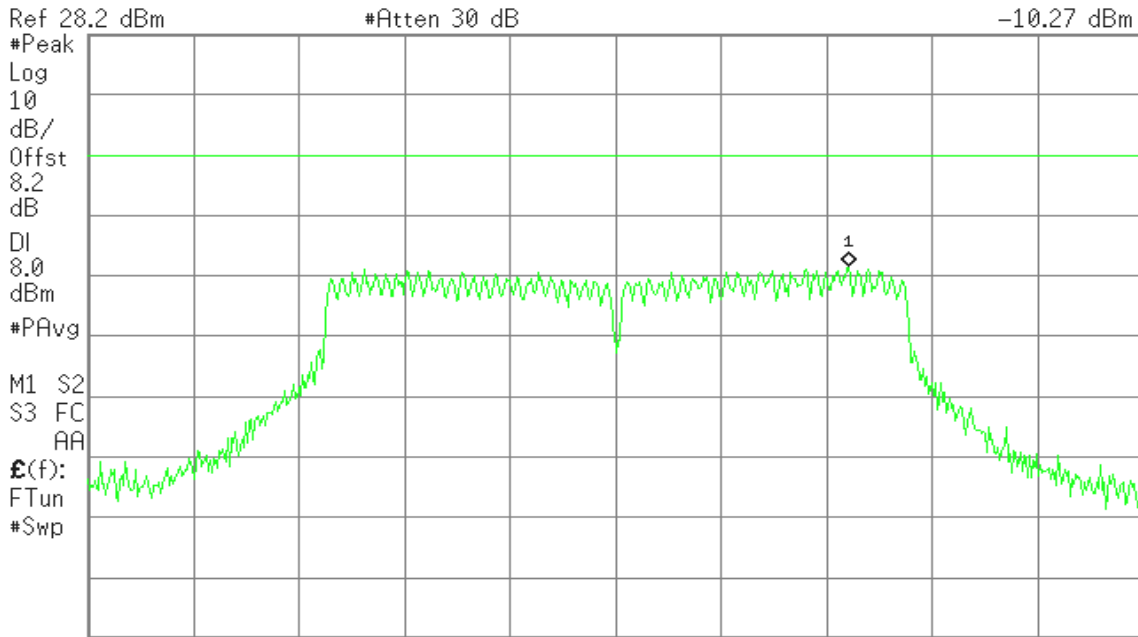

Center 2.437 00 GHz Span 30 MHz  
#Res BW 3 kHz #VBW 10 kHz Sweep 3.163 s (601 pts)

### PPSD (CH High)

Agilent

R L

Mkr1 2.467 65 GHz  
-10.10 dBm

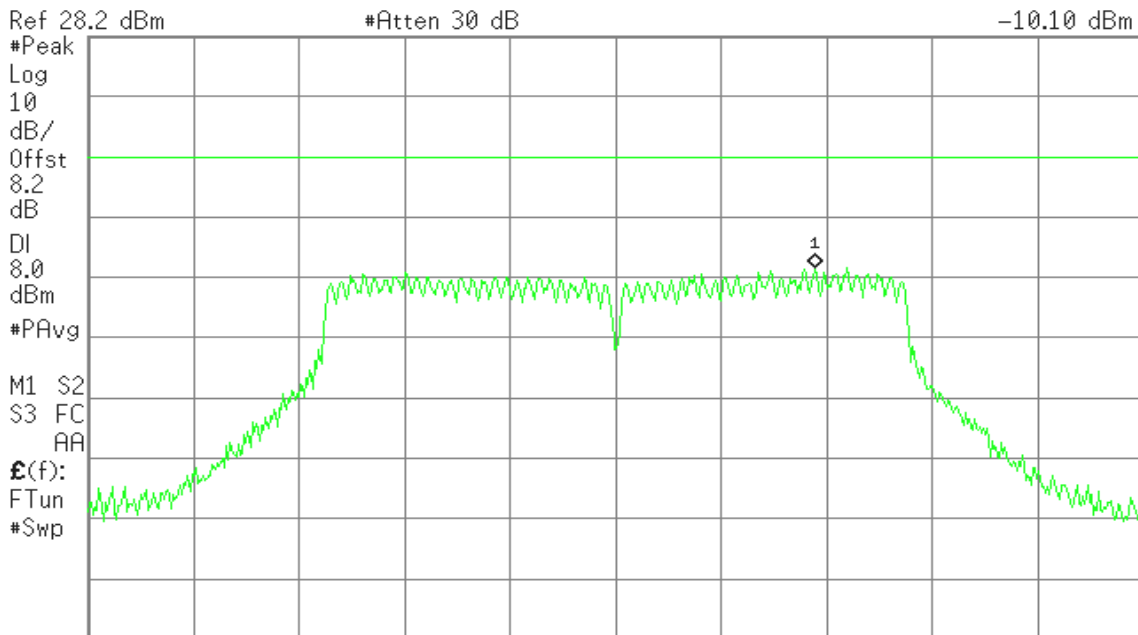

Center 2.462 00 GHz Span 30 MHz  
#Res BW 3 kHz #VBW 10 kHz Sweep 3.163 s (601 pts)



### IEEE 802.11n HT20 mode

### PPSD (CH Low)

Agilent

R L

Mkr1 2.418 60 GHz  
-11.79 dBm

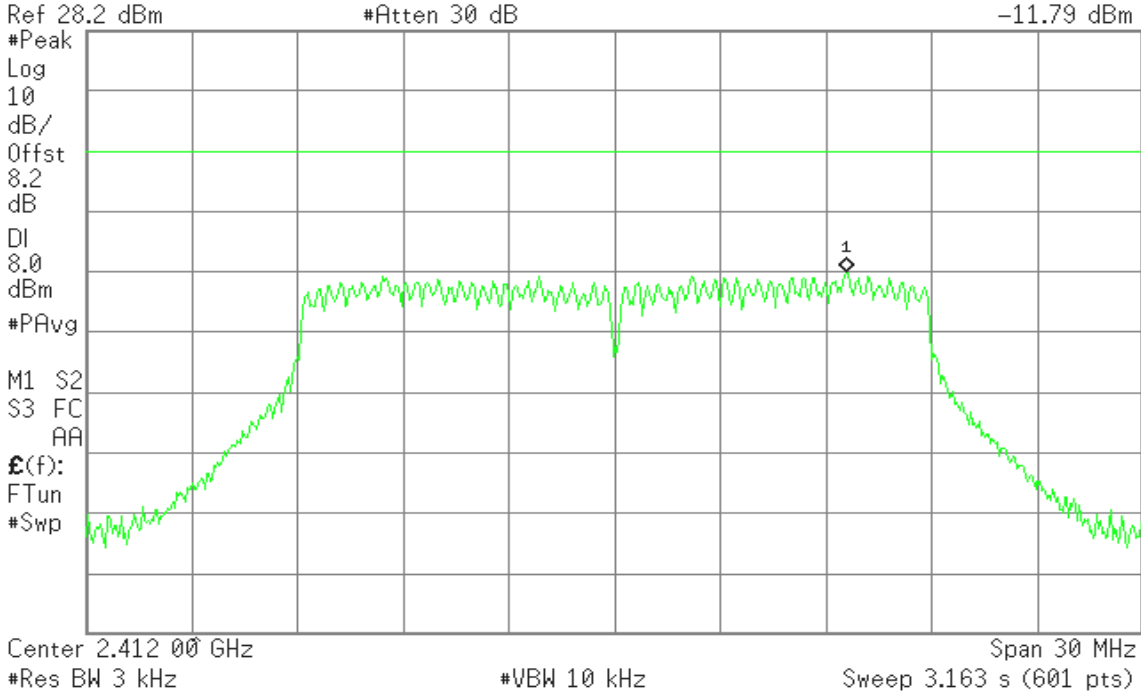

### PPSD (CH Mid)

Agilent

R L

Mkr1 2.443 60 GHz  
-11.30 dBm

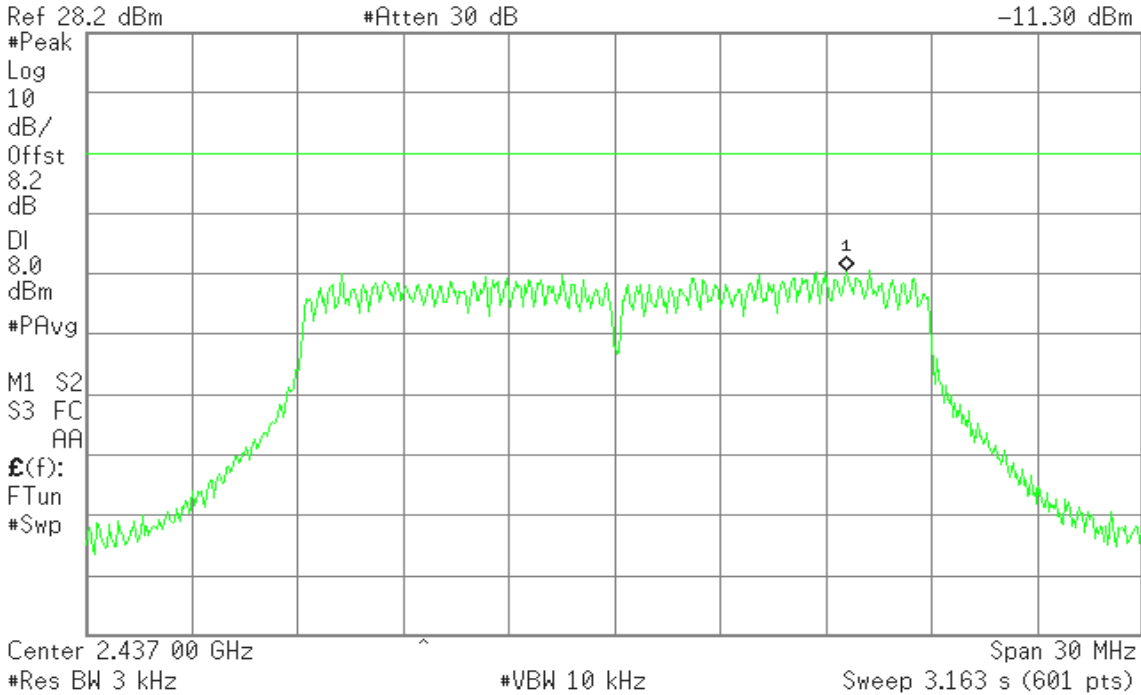



### PPSD (CH High)

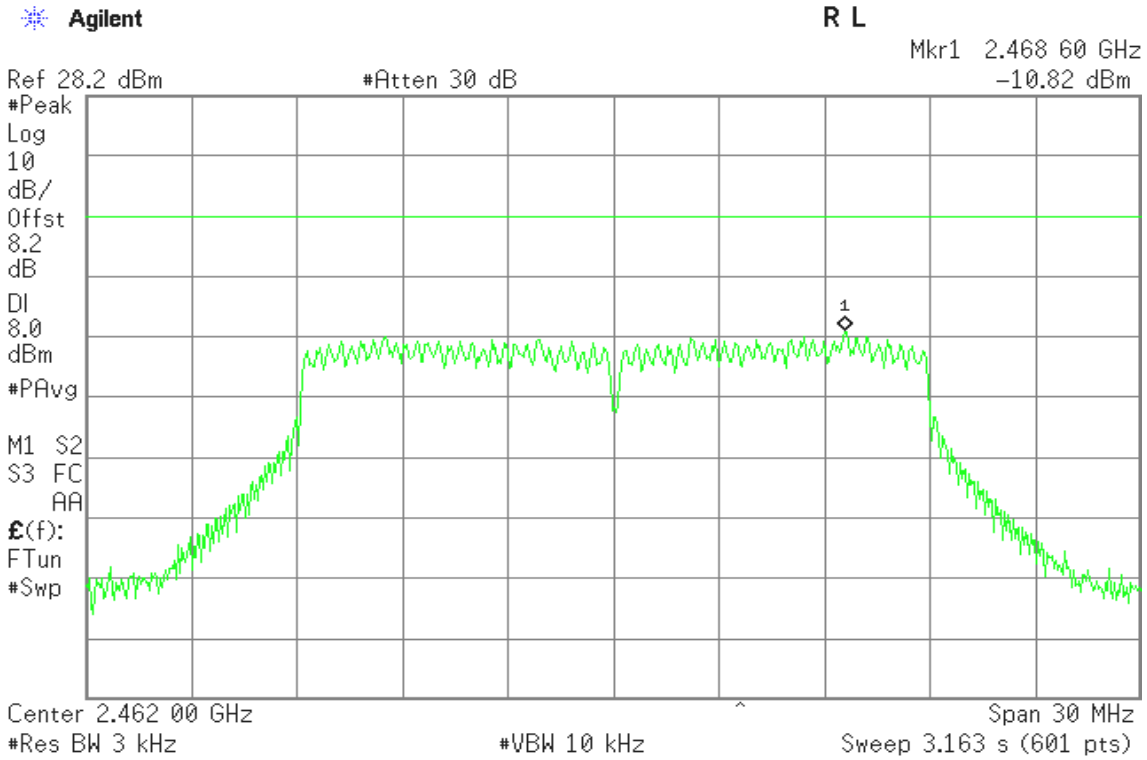

### IEEE 802.11n HT40 mode

### PPSD (CH Low)

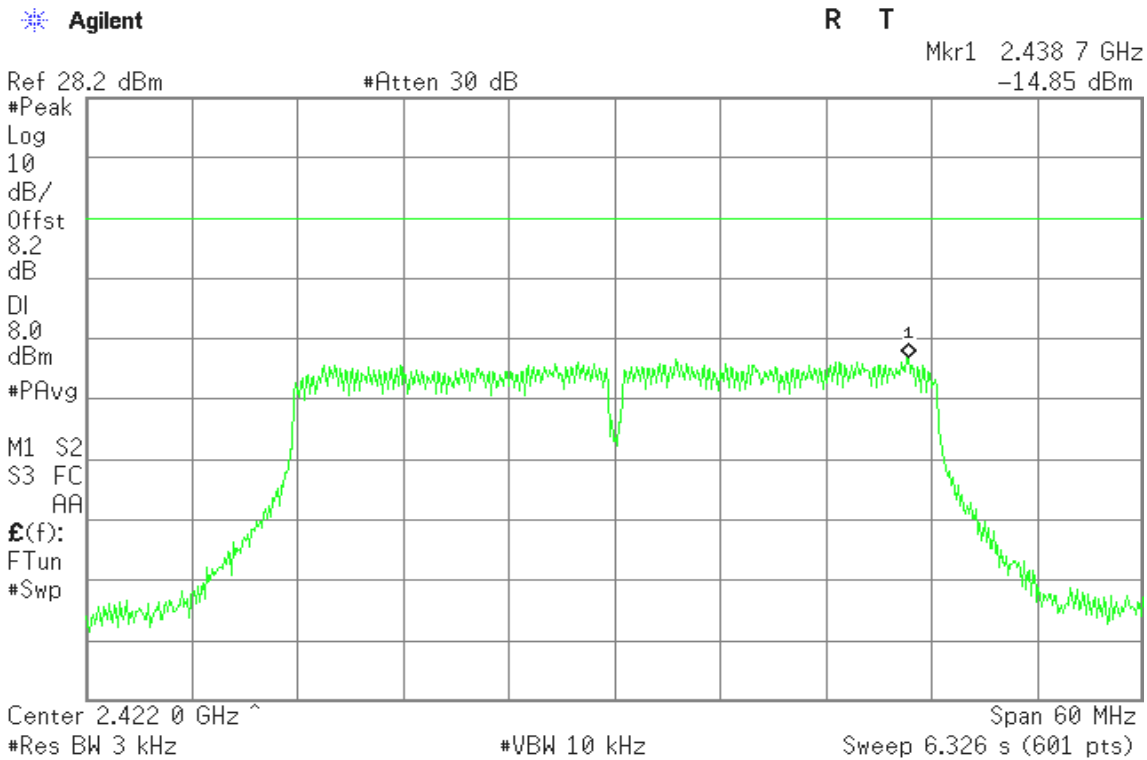



### PPSD (CH Mid)

Agilent

R L

Mkr1 2.453 6 GHz  
-14.89 dBm

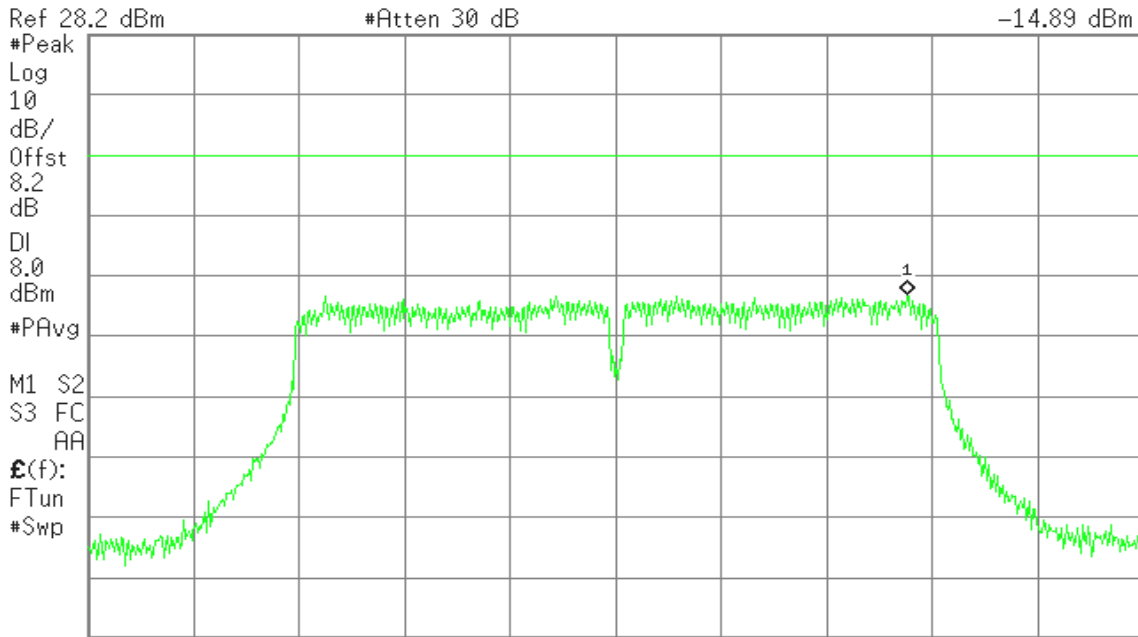

Center 2.437 0 GHz Span 60 MHz  
#Res BW 3 kHz #VBW 10 kHz Sweep 6.326 s (601 pts)

### PPSD (CH High)

Agilent

R L

Mkr1 2.435 5 GHz  
-16.88 dBm

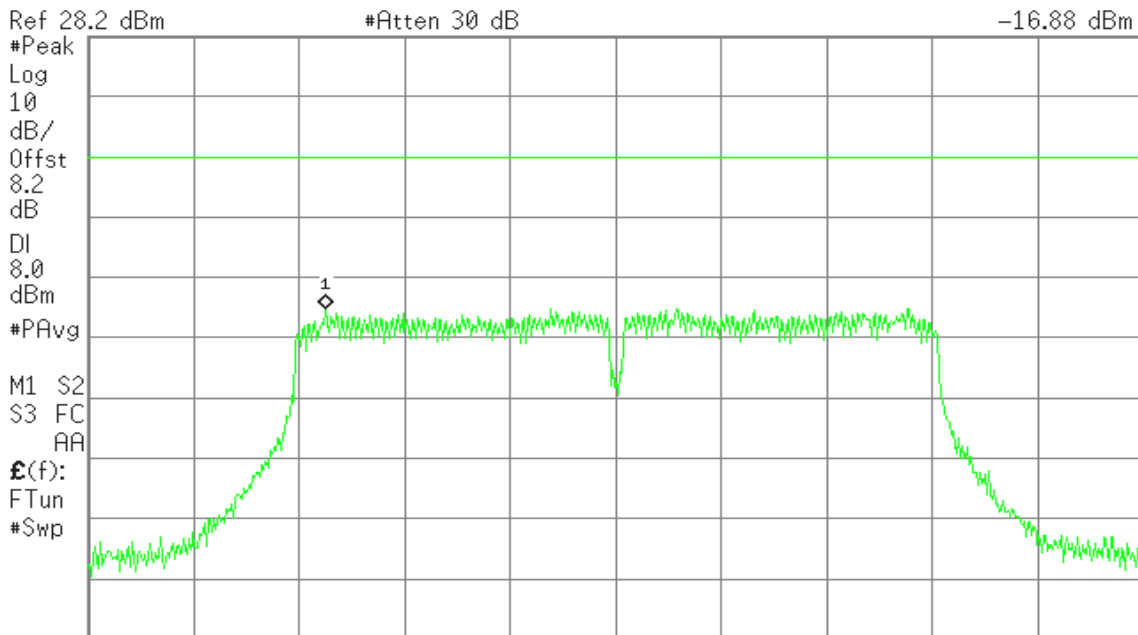

Center 2.452 0 GHz Span 60 MHz  
#Res BW 3 kHz #VBW 10 kHz Sweep 6.326 s (601 pts)



## **7.6 SPURIOUS EMISSIONS**

### **7.6.1 Conducted Measurement**

#### **LIMIT**

According to §15.247(d), in any 100 kHz bandwidth outside the frequency bands in which the spread spectrum intentional radiator is operating, the radio frequency power that is produced by the intentional radiator shall be at least 20 dB below that in the 100 kHz bandwidth within the band that contains the highest level of the desired power, based on either an RF conducted or a radiated measurement, provided the transmitter demonstrates compliance with the peak conducted power limits. In addition, radiated emissions which fall in the restricted bands, as defined in §15.205(a), must also comply with the radiated emission limits specified in 15.209(a) (see Section 15.205(c)).

#### **Test Configuration**

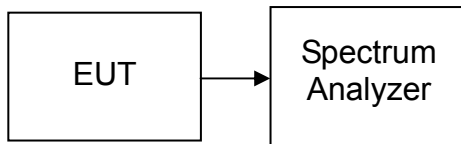

#### **TEST PROCEDURE**

Conducted RF measurements of the transmitter output were made to confirm that the EUT antenna port conducted emissions meet the specified limit and to identify any spurious signals that require further investigation or measurements on the radiated emissions site.

The transmitter output is connected to the spectrum analyzer. The resolution bandwidth is set to 100 kHz. The video bandwidth is set to 100 kHz.

Measurements are made over the 30MHz to 26GHz range for IEEE 802.11b/g, 30MHz to 40GHz range for IEEE 802.11a with the transmitter set to the lowest, middle, and highest channels.

#### **TEST RESULTS**

*No non-compliance noted*



Test Plot

IEEE 802.11b mode

CH Low

Agilent

R L

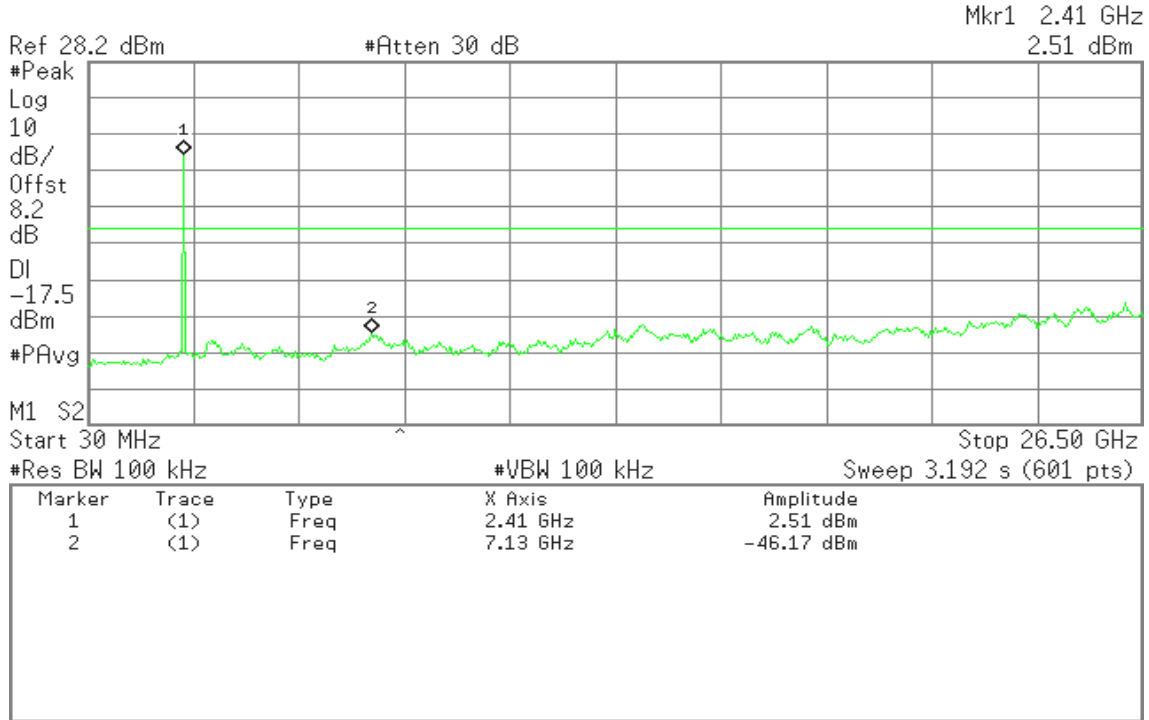

CH Mid

Agilent

R L

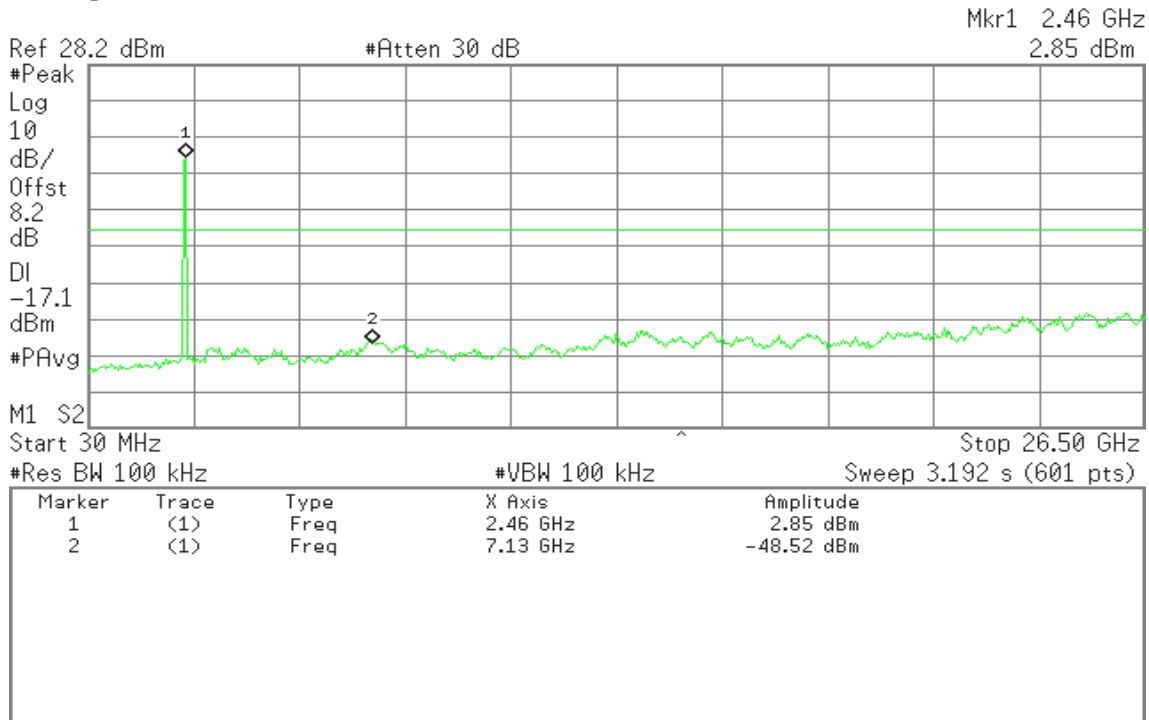



### CH High

Agilent

R L

Mkr1 2.46 GHz  
4.12 dBm

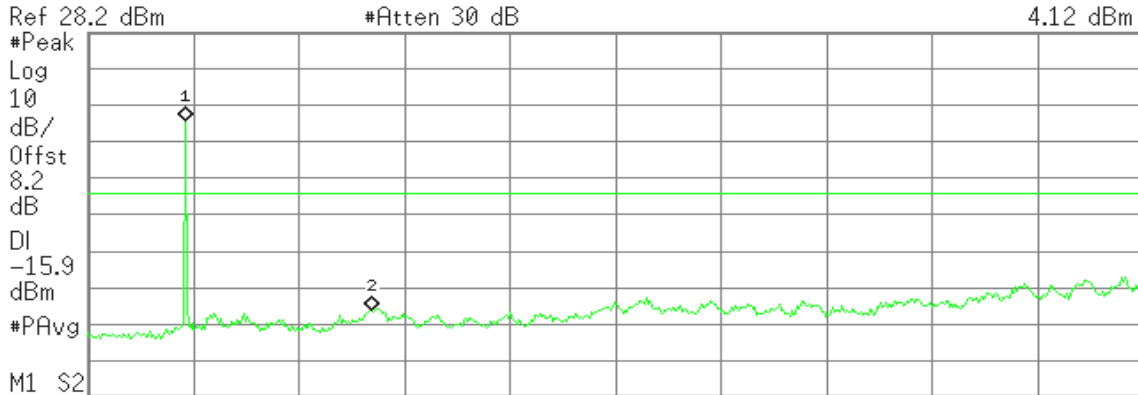

Marker	Trace	Type	X Axis	Amplitude
1	(1)	Freq	2.46 GHz	4.12 dBm
2	(1)	Freq	7.13 GHz	-48.01 dBm

### IEEE 802.11g mode

### CH Low

Agilent

R L

Mkr1 2.41 GHz  
0.57 dBm

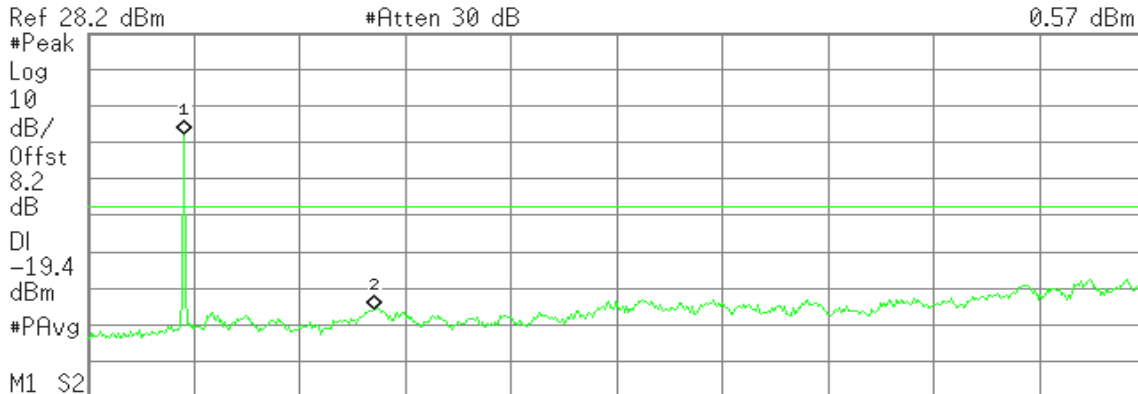

Marker	Trace	Type	X Axis	Amplitude
1	(1)	Freq	2.41 GHz	0.57 dBm
2	(1)	Freq	7.18 GHz	-47.59 dBm



### CH Mid

Agilent

R L

Mkr1 2.46 GHz  
1.33 dBm



Ref 28.2 dBm #Atten 30 dB  
 #Peak Log 10 dB/ Offst 8.2 dB DI -18.7 dBm #PAvg  
 M1 S2 Start 30 MHz Stop 26.50 GHz  
 #Res BW 100 kHz #VBW 100 kHz Sweep 3.192 s (601 pts)

Marker	Trace	Type	X Axis	Amplitude
1	(1)	Freq	2.46 GHz	1.33 dBm
2	(1)	Freq	7.18 GHz	-48.33 dBm

### CH High

Agilent

R L

Mkr1 2.46 GHz  
2.61 dBm

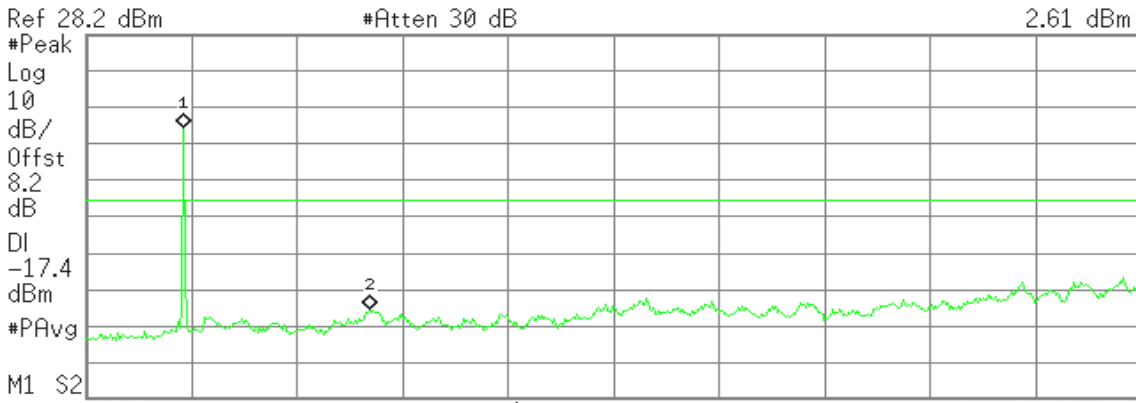

Ref 28.2 dBm #Atten 30 dB  
 #Peak Log 10 dB/ Offst 8.2 dB DI -17.4 dBm #PAvg  
 M1 S2 Start 30 MHz Stop 26.50 GHz  
 #Res BW 100 kHz #VBW 100 kHz Sweep 3.192 s (601 pts)

Marker	Trace	Type	X Axis	Amplitude
1	(1)	Freq	2.46 GHz	2.61 dBm
2	(1)	Freq	7.13 GHz	-47.21 dBm



### IEEE 802.11n HT20 mode

#### CH Low

Agilent

R L

Mkr1 2.41 GHz  
2.88 dBm

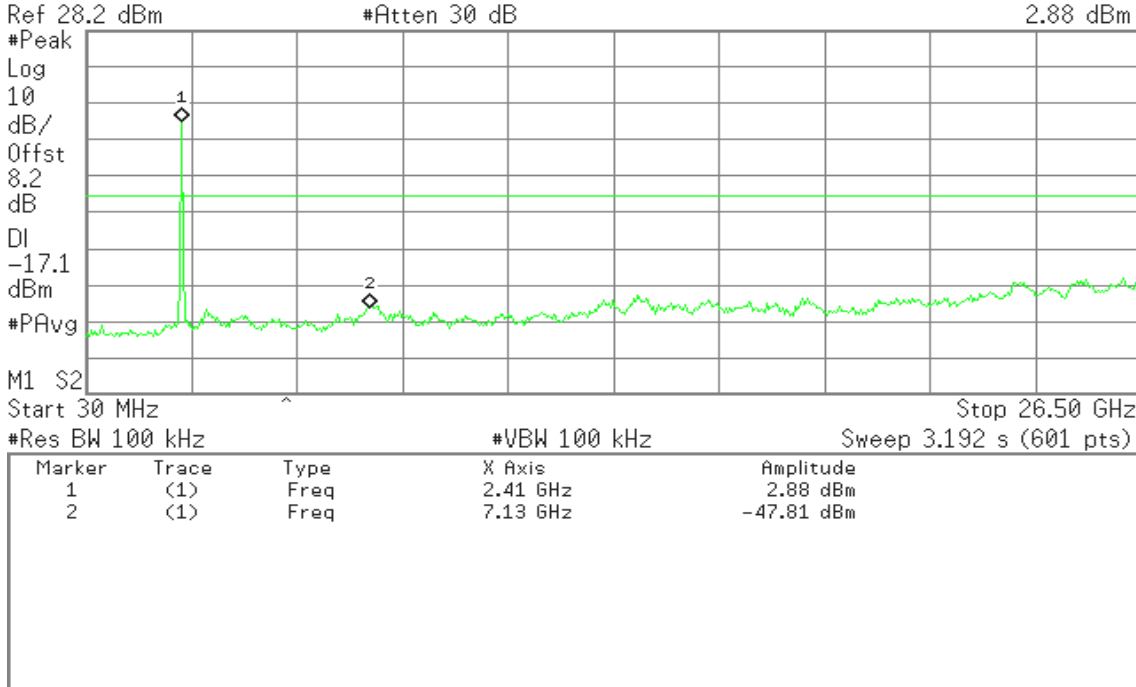

#### CH Mid

Agilent

R L

Mkr1 2.46 GHz  
1.73 dBm

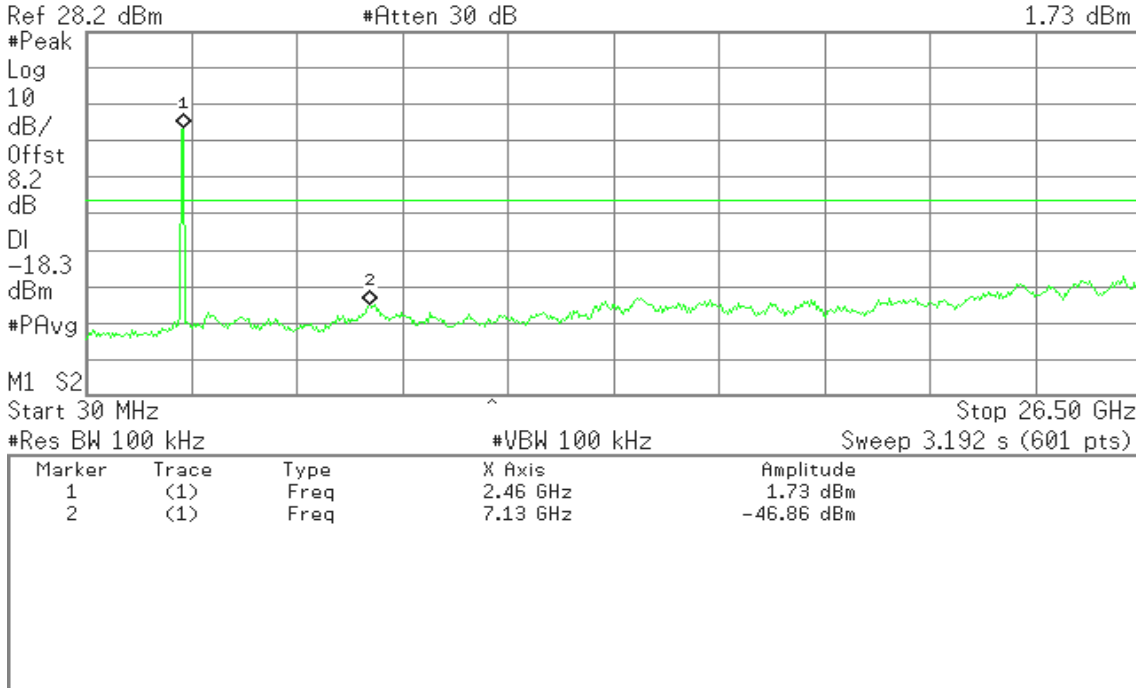



### CH High

Agilent

R T

Mkr1 2.46 GHz  
1.51 dBm

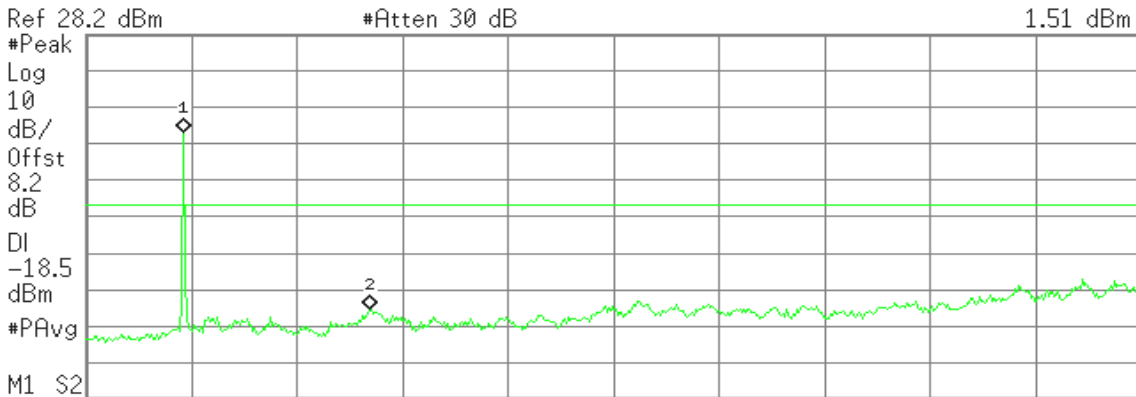

Marker	Trace	Type	X Axis	Amplitude
1	(1)	Freq	2.46 GHz	1.51 dBm
2	(1)	Freq	7.13 GHz	-47.26 dBm

### IEEE 802.11n HT40 mode

### CH Low

Agilent

R L

Mkr1 2.41 GHz  
-2.70 dBm

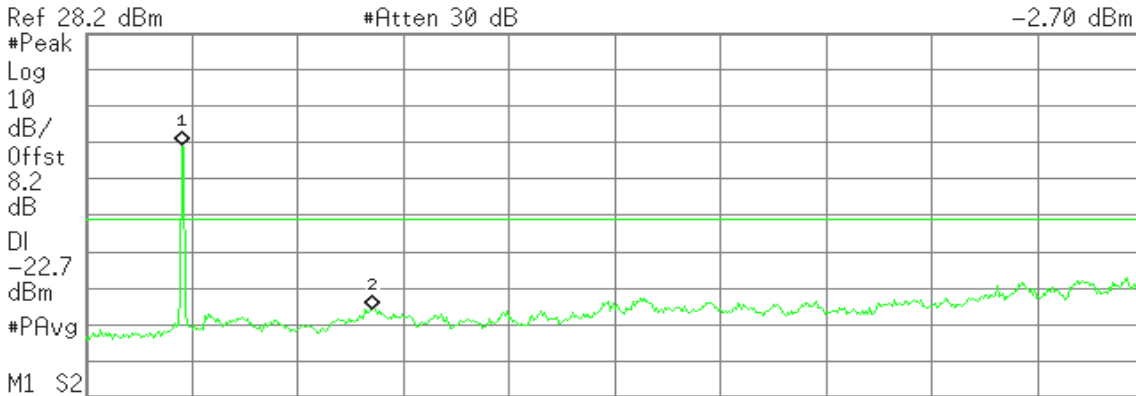

Marker	Trace	Type	X Axis	Amplitude
1	(1)	Freq	2.41 GHz	-2.70 dBm
2	(1)	Freq	7.18 GHz	-47.75 dBm



### CH Mid

Agilent

R L

Mkr1 2.46 GHz  
-1.39 dBm

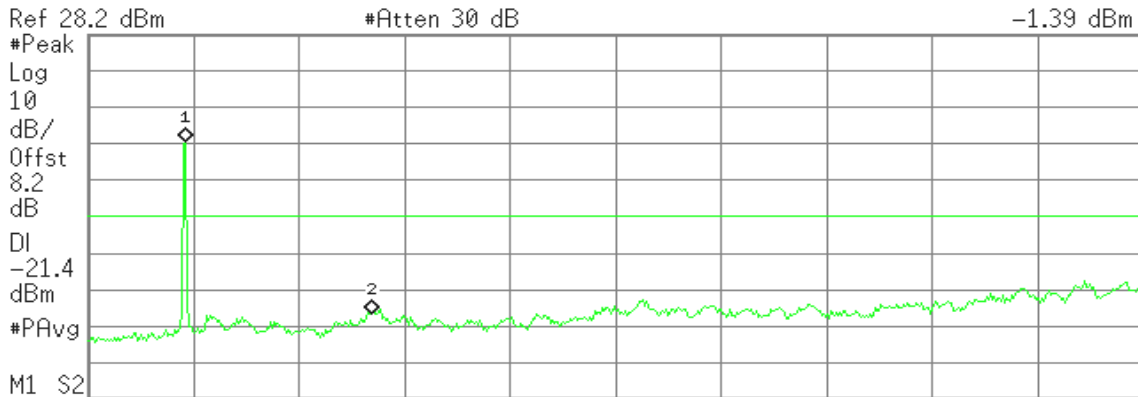

Marker	Trace	Type	X Axis	Amplitude
1	(1)	Freq	2.46 GHz	-1.39 dBm
2	(1)	Freq	7.13 GHz	-48.24 dBm

### CH High

Agilent

R L

Mkr1 2.46 GHz  
-4.00 dBm

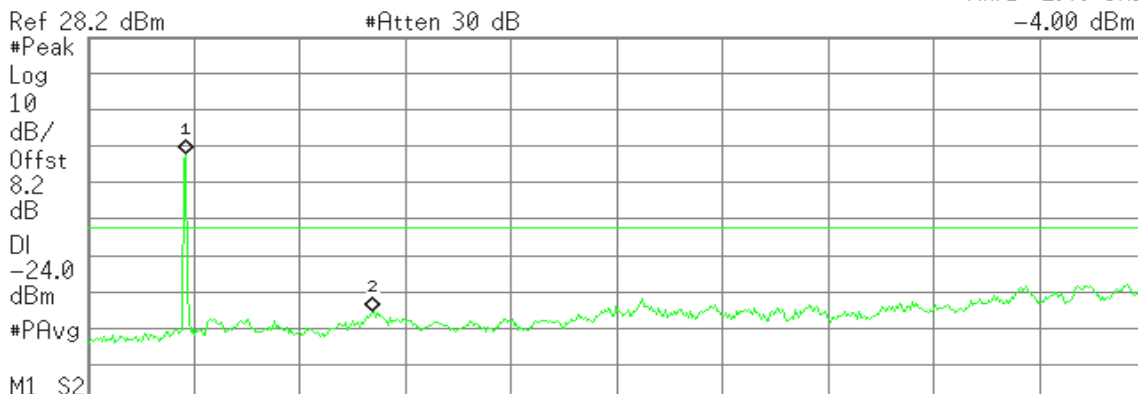

Marker	Trace	Type	X Axis	Amplitude
1	(1)	Freq	2.46 GHz	-4.00 dBm
2	(1)	Freq	7.13 GHz	-46.92 dBm



### 7.6.2 Radiated Emissions

#### LIMIT

1. According to §15.209(a), except as provided elsewhere in this Subpart, the emissions from an intentional radiator shall not exceed the field strength levels specified in the following table:

Frequency (MHz)	Field Strength (µV/m)	Measurement Distance (m)
0.009 - 0.490	2400/F(kHz)	300
0.490 - 1.705	24000/F(kHz)	30
1.705 – 30.0	30	30
30-88	100	3
88-216	150	3
216-960	200	3
Above 960	500	3

**Remark:** Except as provided in paragraph (g), fundamental emissions from intentional radiators operating under this Section shall not be located in the frequency bands 54-72 MHz, 76-88 MHz, 174-216 MHz or 470-806 MHz. However, operation within these frequency bands is permitted under other sections of this Part, e.g., Sections 15.231 and 15.241.

2. In the above emission table, the tighter limit applies at the band edges.

Frequency (MHz)	Field Strength (µV/m at 3-meter)	Field Strength (dBµV/m at 3-meter)
0.009 - 0.490	2400/F(kHz) +80	20LOG((2400/F(kHz))+80)
0.490 - 1.705	24000/F(kHz) +40	20LOG((24000/F(kHz))+40)
1.705 – 30.0	30	69.54
30-88	100	40
88-216	150	43.5
216-960	200	46
Above 960	500	54



**Test Configuration**

**9kHz ~ 30MHz**

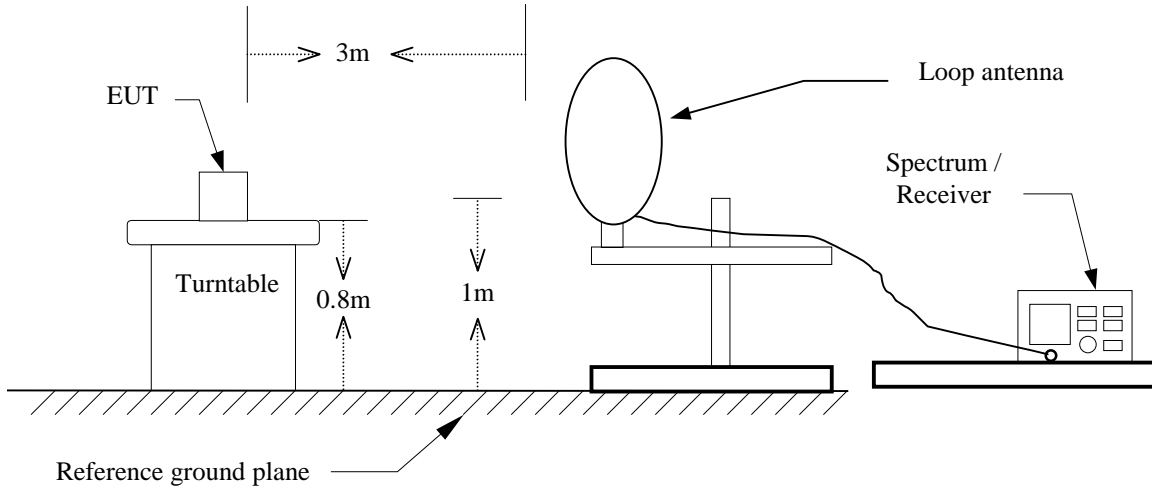

**30MHz ~ 1GHz**

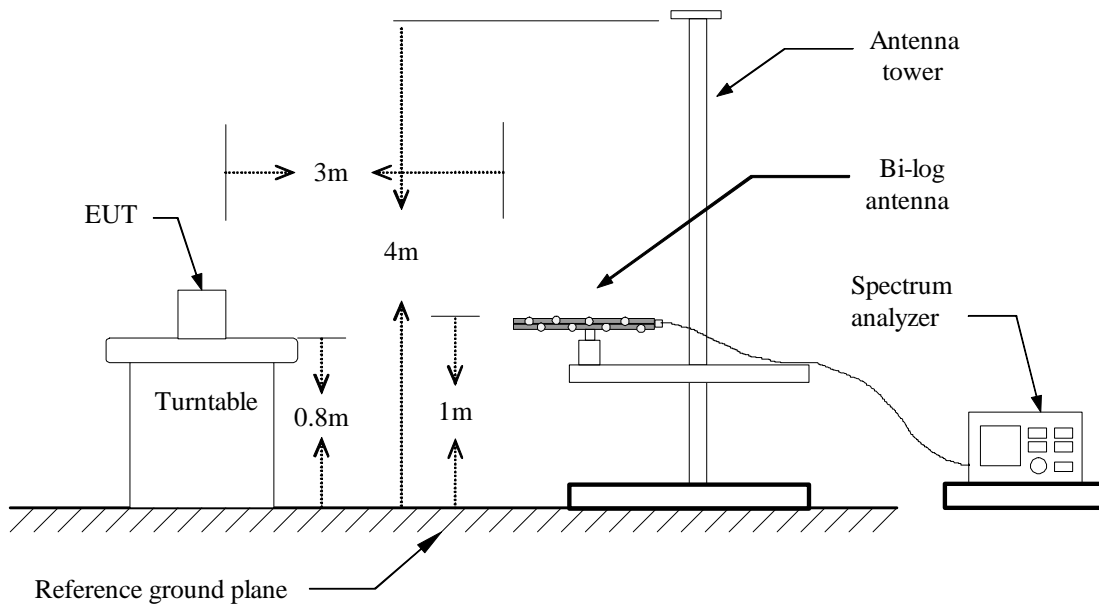



## Above 1 GHz

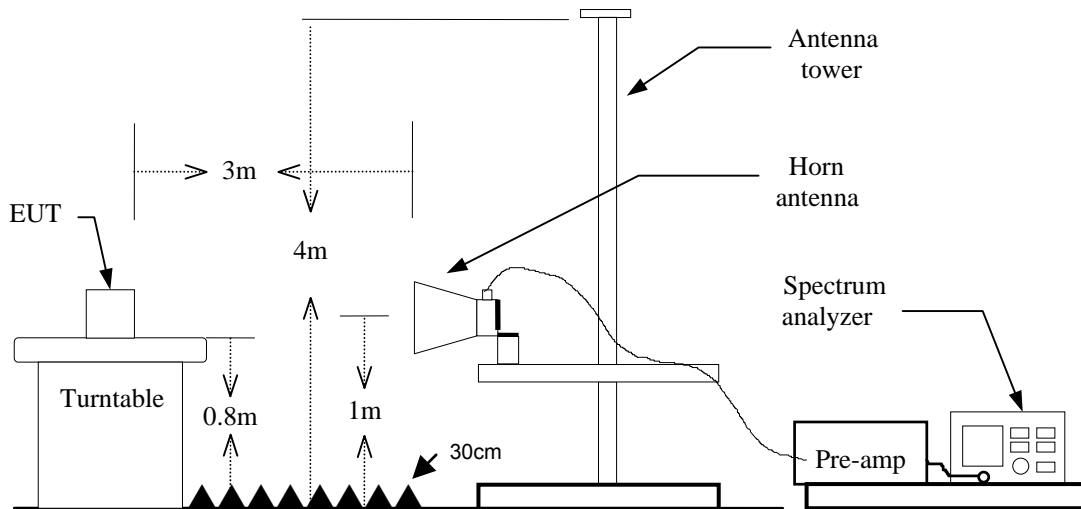

## TEST PROCEDURE

1. The EUT is placed on a turntable, which is 0.8m above ground plane.
2. The turntable shall be rotated for 360 degrees to determine the position of maximum emission level.
3. EUT is set 3m away from the receiving antenna, which is varied from 1m to 4m to find out the highest emissions.
4. Maximum procedure was performed on the six highest emissions to ensure EUT compliance.
5. And also, each emission was to be maximized by changing the polarization of receiving antenna both horizontal and vertical.
6. Set the spectrum analyzer in the following setting as:

### **Below 30MHz**

RBW=10kHz / VBW=30kHz / Sweep=AUTO

### **30 ~ 1000MHz:**

RBW=100kHz / VBW=300KHz / Sweep=AUTO

### **Above 1GHz:**

- a) PEAK: RBW=1MHz / VBW=3MHz / Sweep=AUTO
- b) AVERAGE: RBW=1MHz / VBW=300Hz / Sweep=AUTO

7. Repeat above procedures until the measurements for all frequencies are complete.



## DATA SAMPLE

### Below 1 GHz

Frequency (MHz)	Reading (dBuV)	Correction Factor (dB/m)	Result (dBuV/m)	Limit (dBuV/m)	Margin (dB)	Ant. Pol. (H/V)	Remark
x.xx	43.20	-20.71	22.49	40.00	-17.51	V	QP

Frequency (MHz) = Emission frequency in MHz  
 Reading (dBuV) = Uncorrected Analyzer / Receiver reading  
 Correction Factor (dB/m) = Antenna factor – Amplifier gain + Cable loss  
 Result (dBuV/m) = Reading (dBuV) + Corr. Factor (dB/m)  
 Limit (dBuV/m) = Limit stated in standard  
 Margin (dB) = Result (dBuV/m) – Limit (dBuV/m)  
 Q.P. = Quasi-Peak

### Above 1 GHz

Freq. (MHz)	Reading (dBuV)	Correct Factor (dB/m)	Result (dBuV/m)	Limit (dBuV/m)	Margin (dB)	Ant. Pol. H/V	Remark
x.xx	45.25	6.91	52.16	74.00	-21.84	H	peak
x.xx	32.33	6.91	39.24	54.00	-14.76	H	AVG

Frequency (MHz) = Emission frequency in MHz  
 Reading (dBuV) = Uncorrected Analyzer / Receiver reading  
 Correction Factor (dB/m) = Antenna factor + Cable loss – Amplifier gain  
 Result (dBuV/m) = Reading (dBuV) + Corr. Factor (dB/m)  
 Limit (dBuV/m) = Limit stated in standard  
 Margin (dB) = Result (dBuV/m) – Limit (dBuV/m)



**Below 1 GHz**

**Operation Mode:** LAN Mode

**Test Date:** 2014/9/9

**Temperature:** 26°C

**Tested by:** Eric Liao

**Humidity:** 56% RH

**Polarity:** Ver. / Hor.

Frequency (MHz)	Reading (dBuV)	Correction Factor (dB/m)	Result (dBuV/m)	Limit (dBuV/m)	Margin (dB)	Ant. Pol. (H/V)	Remark
43.5799	43.90	-16.27	27.63	40.00	-12.37	V	QP
126.0300	41.81	-15.32	26.49	43.50	-17.01	V	QP
167.7400	46.60	-16.91	29.69	43.50	-13.81	V	QP
210.4199	48.50	-16.39	32.11	43.50	-11.39	V	QP
377.2599	48.30	-10.67	37.63	46.00	-8.37	V	QP
800.1799	39.80	-5.78	34.02	46.00	-11.98	V	QP
210.4200	49.40	-16.39	33.01	43.50	-10.49	H	QP
240.4900	41.50	-14.22	27.28	46.00	-18.72	H	QP
335.5500	50.30	-11.49	38.81	46.00	-7.19	H	QP
378.2300	53.10	-10.65	42.45	46.00	-3.55	H	QP
480.0800	34.40	-9.55	24.85	46.00	-21.15	H	QP
800.1800	42.70	-5.78	36.92	46.00	-9.08	H	QP

**Remark:**

1. No emission found between lowest internal used/generated frequency to 30MHz (9kHz~30MHz).
2. Radiated emissions measured in frequency range from 30 MHz to 1000MHz were made with an instrument using peak/quasi-peak detector mode.
3. Quasi-peak test would be performed if the peak result were greater than the quasi-peak limit or as required by the applicant.
4. Measurements above show only up to 6 maximum emissions noted, or would be lesser, with " N/A " remark, if no specific emissions from the EUT are recorded (ie: margin>20dB from the applicable limit) and considered that's already beyond the background noise floor.
5. Margin (dB) = Remark result (dBuV/m) – Quasi-peak limit (dBuV/m).



**Above 1 GHz**

**Operation Mode:** TX / IEEE 802.11b mode / CH Low **Test Date:** 2014/5/21

**Temperature:** 26°C

**Tested by:** Francis Lee

**Humidity:** 56%RH

**Polarity:** Ver. / Hor.

Freq. (MHz)	Reading (dBuV)	Correct Factor (dB/m)	Result (dBuV/m)	Limit (dBuV/m)	Margin (dB)	Ant. Pol H/V	Remark
1602.000	51.55	-4.81	46.74	74.00	-27.26	V	peak
1954.000	50.53	-2.03	48.50	74.00	-25.50	V	peak
2906.000	49.65	-0.70	48.95	74.00	-25.05	V	peak
3800.000	40.33	3.69	44.02	74.00	-29.98	V	peak
4825.000	49.69	2.68	52.37	74.00	-21.63	V	peak
4825.000	47.53	2.68	50.21	54.00	-3.79	V	AVG
7595.000	38.62	11.89	50.51	74.00	-23.49	V	peak
1368.000	51.39	-7.72	43.67	74.00	-30.33	H	peak
2202.000	50.38	-3.62	46.76	74.00	-27.24	H	peak
2840.000	49.14	-2.18	46.96	74.00	-27.04	H	peak
4315.000	40.29	7.55	47.84	74.00	-26.16	H	peak
4825.000	47.32	5.88	53.20	74.00	-20.80	H	peak
4825.000	44.83	5.88	50.71	54.00	-3.29	H	AVG
7340.000	39.28	11.62	50.90	74.00	-23.10	H	peak

**Remark:**

1. Measuring frequencies from 1 GHz to the 10th harmonic of highest fundamental frequency.
2. Radiated emissions measured in frequency above 1000MHz were made with an instrument using peak/average detector mode.
3. Average test would be performed if the peak result were greater than the average limit.
4. Data of measurement within this frequency range shown " --- " in the table above means the reading of emissions are attenuated more than 20dB below the permissible limits or the field strength is too small to be measured.
5. Measurements above show only up to 6 maximum emissions noted, or would be lesser, with " N/A " remark, if no specific emissions from the EUT are recorded (ie: margin>20dB from the applicable limit) and considered that's already beyond the background noise floor.
6. Margin (dB) = Remark result (dBuV/m) – Average limit (dBuV/m).



**Operation Mode:** TX / IEEE 802.11b mode / CH Mid **Test Date:** 2014/5/21

**Temperature:** 26°C

**Tested by:** Francis Lee

**Humidity:** 56%RH

**Polarity:** Ver. / Hor.

Freq. (MHz)	Reading (dBuV)	Correct Factor (dB/m)	Result (dBuV/m)	Limit (dBuV/m)	Margin (dB)	Ant. Pol H/V	Remark
1212.000	53.00	-8.45	44.55	74.00	-29.45	V	peak
1976.000	50.15	-1.68	48.47	74.00	-25.53	V	peak
2754.000	50.43	-1.81	48.62	74.00	-25.38	V	peak
3770.000	40.18	3.32	43.50	74.00	-30.50	V	peak
4875.000	48.98	3.81	52.79	74.00	-21.21	V	peak
4875.000	46.21	3.81	50.02	54.00	-3.98	V	AVG
7515.000	38.91	11.60	50.51	74.00	-23.49	V	peak
1400.000	50.96	-6.90	44.06	74.00	-29.94	H	peak
2152.000	50.29	-3.67	46.62	74.00	-27.38	H	peak
2848.000	49.78	-2.12	47.66	74.00	-26.34	H	peak
4335.000	40.70	7.40	48.10	74.00	-25.90	H	peak
4875.000	47.35	6.73	54.08	74.00	-19.92	H	peak
4875.000	43.81	6.73	50.54	54.00	-3.46	H	AVG
7295.000	38.85	11.75	50.60	74.00	-23.40	H	peak

**Remark:**

1. Measuring frequencies from 1 GHz to the 10th harmonic of highest fundamental frequency.
2. Radiated emissions measured in frequency above 1000MHz were made with an instrument using peak/average detector mode.
3. Average test would be performed if the peak result were greater than the average limit.
4. Data of measurement within this frequency range shown " --- " in the table above means the reading of emissions are attenuated more than 20dB below the permissible limits or the field strength is too small to be measured.
5. Measurements above show only up to 6 maximum emissions noted, or would be lesser, with " N/A " remark, if no specific emissions from the EUT are recorded (ie: margin>20dB from the applicable limit) and considered that's already beyond the background noise floor.
6. Margin (dB) = Remark result (dBuV/m) – Average limit (dBuV/m).



**Operation Mode:**TX / IEEE 802.11b mode / CH High **Test Date:** 2014/5/21

**Temperature:** 26°C

**Tested by:** Francis Lee

**Humidity:** 56%RH

**Polarity:** Ver. / Hor.

Freq. (MHz)	Reading (dBuV)	Correct Factor (dB/m)	Result (dBuV/m)	Limit (dBuV/m)	Margin (dB)	Ant. Pol H/V	Remark
1546.000	51.38	-5.04	46.34	74.00	-27.66	V	peak
2222.000	50.26	-1.38	48.88	74.00	-25.12	V	peak
2774.000	50.31	-1.94	48.37	74.00	-25.63	V	peak
4055.000	40.59	3.29	43.88	74.00	-30.12	V	peak
4925.000	47.58	4.61	52.19	74.00	-21.81	V	peak
4925.000	45.66	4.61	50.27	54.00	-3.73	V	AVG
7580.000	38.70	11.84	50.54	74.00	-23.46	V	peak
1392.000	51.23	-7.11	44.12	74.00	-29.88	H	peak
2198.000	49.63	-3.56	46.07	74.00	-27.93	H	peak
2796.000	50.38	-2.52	47.86	74.00	-26.14	H	peak
4925.000	46.85	7.26	54.11	74.00	-19.89	H	peak
4925.000	43.66	7.26	50.92	54.00	-3.08	H	peak
5965.000	39.56	8.97	48.53	74.00	-25.47	H	AVG
7265.000	39.15	11.35	50.50	74.00	-23.50	H	peak

**Remark:**

1. Measuring frequencies from 1 GHz to the 10th harmonic of highest fundamental frequency.
2. Radiated emissions measured in frequency above 1000MHz were made with an instrument using peak/average detector mode.
3. Average test would be performed if the peak result were greater than the average limit.
4. Data of measurement within this frequency range shown " --- " in the table above means the reading of emissions are attenuated more than 20dB below the permissible limits or the field strength is too small to be measured.
5. Measurements above show only up to 6 maximum emissions noted, or would be lesser, with " N/A " remark, if no specific emissions from the EUT are recorded (ie: margin>20dB from the applicable limit) and considered that's already beyond the background noise floor.
6. Margin (dB) = Remark result (dBuV/m) – Average limit (dBuV/m).



**Operation Mode:**TX / IEEE 802.11g mode / CH Low **Test Date:** 2014/5/21

**Temperature:** 26°C

**Tested by:** Francis Lee

**Humidity:** 56%RH

**Polarity:** Ver. / Hor.

Freq. (MHz)	Reading (dBuV)	Correct Factor (dB/m)	Result (dBuV/m)	Limit (dBuV/m)	Margin (dB)	Ant. Pol H/V	Remark
1674.000	51.99	-5.42	46.57	74.00	-27.43	V	peak
2000.000	49.74	-1.30	48.44	74.00	-25.56	V	peak
2864.000	49.63	-1.18	48.45	74.00	-25.55	V	peak
4140.000	40.80	2.87	43.67	74.00	-30.33	V	peak
4825.000	45.49	2.68	48.17	74.00	-25.83	V	peak
7515.000	38.68	11.60	50.28	74.00	-23.72	V	peak
1426.000	51.23	-7.45	43.78	74.00	-30.22	H	peak
2164.000	50.01	-3.64	46.37	74.00	-27.63	H	peak
2840.000	49.54	-2.18	47.36	74.00	-26.64	H	peak
3800.000	40.76	5.10	45.86	74.00	-28.14	H	peak
4820.000	44.73	5.79	50.52	74.00	-23.48	H	peak
7370.000	39.25	11.46	50.71	74.00	-23.29	H	peak

**Remark:**

1. Measuring frequencies from 1 GHz to the 10th harmonic of highest fundamental frequency.
2. Radiated emissions measured in frequency above 1000MHz were made with an instrument using peak/average detector mode.
3. Average test would be performed if the peak result were greater than the average limit.
4. Data of measurement within this frequency range shown " --- " in the table above means the reading of emissions are attenuated more than 20dB below the permissible limits or the field strength is too small to be measured.
5. Measurements above show only up to 6 maximum emissions noted, or would be lesser, with " N/A " remark, if no specific emissions from the EUT are recorded (ie: margin>20dB from the applicable limit) and considered that's already beyond the background noise floor.
6. Margin (dB) = Remark result (dBuV/m) – Average limit (dBuV/m).



**Operation Mode:**TX / IEEE 802.11g mode / CH Mid **Test Date:** 2014/5/21

**Temperature:** 26°C

**Tested by:** Francis Lee

**Humidity:** 56%RH

**Polarity:** Ver. / Hor.

Freq. (MHz)	Reading (dBuV)	Correct Factor (dB/m)	Result (dBuV/m)	Limit (dBuV/m)	Margin (dB)	Ant. Pol H/V	Remark
1436.000	52.18	-6.14	46.04	74.00	-27.96	V	peak
1992.000	50.62	-1.43	49.19	74.00	-24.81	V	peak
2876.000	49.99	-1.01	48.98	74.00	-25.02	V	peak
3595.000	40.49	2.90	43.39	74.00	-30.61	V	peak
4875.000	44.59	3.81	48.40	74.00	-25.60	V	peak
7310.000	39.63	10.56	50.19	74.00	-23.81	V	peak
1404.000	51.28	-6.98	44.30	74.00	-29.70	H	peak
2190.000	50.66	-3.58	47.08	74.00	-26.92	H	peak
2916.000	48.81	-1.56	47.25	74.00	-26.75	H	peak
3930.000	41.44	5.11	46.55	74.00	-27.45	H	peak
4875.000	41.80	6.73	48.53	74.00	-25.47	H	peak
7310.000	38.72	11.77	50.49	74.00	-23.51	H	peak

**Remark:**

1. Measuring frequencies from 1 GHz to the 10th harmonic of highest fundamental frequency.
2. Radiated emissions measured in frequency above 1000MHz were made with an instrument using peak/average detector mode.
3. Average test would be performed if the peak result were greater than the average limit.
4. Data of measurement within this frequency range shown " --- " in the table above means the reading of emissions are attenuated more than 20dB below the permissible limits or the field strength is too small to be measured.
5. Measurements above show only up to 6 maximum emissions noted, or would be lesser, with " N/A " remark, if no specific emissions from the EUT are recorded (ie: margin>20dB from the applicable limit) and considered that's already beyond the background noise floor.
6. Margin (dB) = Remark result (dBuV/m) – Average limit (dBuV/m).



**Operation Mode:**TX / IEEE 802.11g mode / CH High **Test Date:** 2014/5/21

**Temperature:** 26°C

**Tested by:** Francis Lee

**Humidity:** 56%RH

**Polarity:** Ver. / Hor.

Freq. (MHz)	Reading (dBuV)	Correct Factor (dB/m)	Result (dBuV/m)	Limit (dBuV/m)	Margin (dB)	Ant. Pol H/V	Remark
1610.000	51.27	-4.87	46.40	74.00	-27.60	V	peak
2000.000	50.87	-1.30	49.57	74.00	-24.43	V	peak
2928.000	49.15	-0.84	48.31	74.00	-25.69	V	peak
3805.000	40.42	3.58	44.00	74.00	-30.00	V	peak
4925.000	44.44	4.61	49.05	74.00	-24.95	V	peak
7470.000	38.85	11.47	50.32	74.00	-23.68	V	peak
1406.000	51.59	-7.03	44.56	74.00	-29.44	H	peak
2116.000	49.96	-3.74	46.22	74.00	-27.78	H	peak
2950.000	49.35	-1.19	48.16	74.00	-25.84	H	peak
4295.000	40.85	7.58	48.43	74.00	-25.57	H	peak
4920.000	43.69	7.24	50.93	74.00	-23.07	H	peak
7365.000	38.98	11.49	50.47	74.00	-23.53	H	peak

**Remark:**

1. Measuring frequencies from 1 GHz to the 10th harmonic of highest fundamental frequency.
2. Radiated emissions measured in frequency above 1000MHz were made with an instrument using peak/average detector mode.
3. Average test would be performed if the peak result were greater than the average limit.
4. Data of measurement within this frequency range shown " --- " in the table above means the reading of emissions are attenuated more than 20dB below the permissible limits or the field strength is too small to be measured.
5. Measurements above show only up to 6 maximum emissions noted, or would be lesser, with " N/A " remark, if no specific emissions from the EUT are recorded (ie: margin>20dB from the applicable limit) and considered that's already beyond the background noise floor.
6. Margin (dB) = Remark result (dBuV/m) – Average limit (dBuV/m).



**Operation Mode:** TX / IEEE 802.11n HT20 mode / CH Low

**Test Date:** 2014/5/21

**Temperature:** 26°C

**Tested by:** Francis Lee

**Humidity:** 56%RH

**Polarity:** Ver. / Hor.

Freq. (MHz)	Reading (dBuV)	Correct Factor (dB/m)	Result (dBuV/m)	Limit (dBuV/m)	Margin (dB)	Ant. Pol H/V	Remark
1492.000	51.51	-5.37	46.14	74.00	-27.86	V	peak
1974.000	50.30	-1.71	48.59	74.00	-25.41	V	peak
2884.000	49.51	-0.89	48.62	74.00	-25.38	V	peak
3390.000	42.25	1.23	43.48	74.00	-30.52	V	peak
4830.000	46.99	2.79	49.78	74.00	-24.22	V	peak
7410.000	38.79	11.32	50.11	74.00	-23.89	V	peak
1416.000	51.43	-7.24	44.19	74.00	-29.81	H	peak
2108.000	50.97	-3.76	47.21	74.00	-26.79	H	peak
2884.000	49.70	-1.85	47.85	74.00	-26.15	H	peak
4285.000	40.01	7.41	47.42	74.00	-26.58	H	peak
4825.000	44.82	5.88	50.70	74.00	-23.30	H	peak
7315.000	38.99	11.74	50.73	74.00	-23.27	H	peak

**Remark:**

1. Measuring frequencies from 1 GHz to the 10th harmonic of highest fundamental frequency.
2. Radiated emissions measured in frequency above 1000MHz were made with an instrument using peak/average detector mode.
3. Average test would be performed if the peak result were greater than the average limit.
4. Data of measurement within this frequency range shown " --- " in the table above means the reading of emissions are attenuated more than 20dB below the permissible limits or the field strength is too small to be measured.
5. Measurements above show only up to 6 maximum emissions noted, or would be lesser, with " N/A " remark, if no specific emissions from the EUT are recorded (ie: margin>20dB from the applicable limit) and considered that's already beyond the background noise floor.
6. Margin (dB) = Remark result (dBuV/m) – Average limit (dBuV/m).



**Operation Mode:** TX / IEEE 802.11n HT20 mode / CH Mid

**Test Date:** 2014/5/21

**Temperature:** 26°C

**Tested by:** Francis Lee

**Humidity:** 56%RH

**Polarity:** Ver. / Hor.

Freq. (MHz)	Reading (dBuV)	Correct Factor (dB/m)	Result (dBuV/m)	Limit (dBuV/m)	Margin (dB)	Ant. Pol H/V	Remark
1510.000	50.62	-5.21	45.41	74.00	-28.59	V	peak
2000.000	50.01	-1.30	48.71	74.00	-25.29	V	peak
2754.000	49.60	-1.81	47.79	74.00	-26.21	V	peak
3800.000	40.52	3.69	44.21	74.00	-29.79	V	peak
4870.000	44.27	3.70	47.97	74.00	-26.03	V	peak
7430.000	39.19	11.37	50.56	74.00	-23.44	V	peak
1400.000	51.32	-6.90	44.42	74.00	-29.58	H	peak
2188.000	50.68	-3.59	47.09	74.00	-26.91	H	peak
2792.000	49.82	-2.55	47.27	74.00	-26.73	H	peak
3925.000	41.80	5.13	46.93	74.00	-27.07	H	peak
4870.000	43.50	6.64	50.14	74.00	-23.86	H	peak
7320.000	38.81	11.72	50.53	74.00	-23.47	H	peak

**Remark:**

1. Measuring frequencies from 1 GHz to the 10th harmonic of highest fundamental frequency.
2. Radiated emissions measured in frequency above 1000MHz were made with an instrument using peak/average detector mode.
3. Average test would be performed if the peak result were greater than the average limit.
4. Data of measurement within this frequency range shown " --- " in the table above means the reading of emissions are attenuated more than 20dB below the permissible limits or the field strength is too small to be measured.
5. Measurements above show only up to 6 maximum emissions noted, or would be lesser, with " N/A " remark, if no specific emissions from the EUT are recorded (ie: margin>20dB from the applicable limit) and considered that's already beyond the background noise floor.
6. Margin (dB) = Remark result (dBuV/m) – Average limit (dBuV/m).



**Operation Mode:** TX / IEEE 802.11n HT20 mode / CH High

**Test Date:** 2014/5/21

**Temperature:** 26°C

**Tested by:** Francis Lee

**Humidity:** 56%RH

**Polarity:** Ver. / Hor.

Freq. (MHz)	Reading (dBuV)	Correct Factor (dB/m)	Result (dBuV/m)	Limit (dBuV/m)	Margin (dB)	Ant. Pol H/V	Remark
1220.000	51.45	-8.47	42.98	74.00	-31.02	V	peak
2000.000	49.84	-1.30	48.54	74.00	-25.46	V	peak
2888.000	49.11	-0.83	48.28	74.00	-25.72	V	peak
3835.000	41.60	2.91	44.51	74.00	-29.49	V	peak
4930.000	43.97	4.66	48.63	74.00	-25.37	V	peak
7515.000	39.22	11.60	50.82	74.00	-23.18	V	peak
1422.000	50.79	-7.36	43.43	74.00	-30.57	H	peak
2196.000	50.05	-3.57	46.48	74.00	-27.52	H	peak
2778.000	50.74	-2.68	48.06	74.00	-25.94	H	peak
4270.000	41.02	7.16	48.18	74.00	-25.82	H	peak
4920.000	43.44	7.24	50.68	74.00	-23.32	H	peak
7285.000	38.74	11.62	50.36	74.00	-23.64	H	peak

**Remark:**

1. Measuring frequencies from 1 GHz to the 10th harmonic of highest fundamental frequency.
2. Radiated emissions measured in frequency above 1000MHz were made with an instrument using peak/average detector mode.
3. Average test would be performed if the peak result were greater than the average limit.
4. Data of measurement within this frequency range shown " --- " in the table above means the reading of emissions are attenuated more than 20dB below the permissible limits or the field strength is too small to be measured.
5. Measurements above show only up to 6 maximum emissions noted, or would be lesser, with " N/A " remark, if no specific emissions from the EUT are recorded (ie: margin>20dB from the applicable limit) and considered that's already beyond the background noise floor.
6. Margin (dB) = Remark result (dBuV/m) – Average limit (dBuV/m).



**Operation Mode:** TX / IEEE 802.11n HT40 mode  
/ CH Low

**Test Date:** 2014/5/21~22

**Temperature:** 26°C

**Tested by:** Francis Lee

**Humidity:** 56%RH

**Polarity:** Ver. / Hor.

Freq. (MHz)	Reading (dBuV)	Correct Factor (dB/m)	Result (dBuV/m)	Limit (dBuV/m)	Margin (dB)	Ant. Pol H/V	Remark
1540.000	51.94	-5.07	46.87	74.00	-27.13	V	peak
1990.000	50.59	-1.46	49.13	74.00	-24.87	V	peak
2704.000	49.58	-1.50	48.08	74.00	-25.92	V	peak
3600.000	41.79	2.93	44.72	74.00	-29.28	V	peak
4850.000	44.49	3.25	47.74	74.00	-26.26	V	peak
7485.000	39.38	11.50	50.88	74.00	-23.12	V	peak
1422.000	51.90	-7.36	44.54	74.00	-29.46	H	peak
2186.000	50.19	-3.59	46.60	74.00	-27.40	H	peak
2862.000	50.15	-2.01	48.14	74.00	-25.86	H	peak
4310.000	40.27	7.59	47.86	74.00	-26.14	H	peak
4850.000	43.93	6.30	50.23	74.00	-23.77	H	peak
7535.000	39.77	10.79	50.56	74.00	-23.44	H	peak

**Remark:**

1. Measuring frequencies from 1 GHz to the 10th harmonic of highest fundamental frequency.
2. Radiated emissions measured in frequency above 1000MHz were made with an instrument using peak/average detector mode.
3. Average test would be performed if the peak result were greater than the average limit.
4. Data of measurement within this frequency range shown " --- " in the table above means the reading of emissions are attenuated more than 20dB below the permissible limits or the field strength is too small to be measured.
5. Measurements above show only up to 6 maximum emissions noted, or would be lesser, with " N/A " remark, if no specific emissions from the EUT are recorded (ie: margin>20dB from the applicable limit) and considered that's already beyond the background noise floor.
6. Margin (dB) = Remark result (dBuV/m) – Average limit (dBuV/m).



**Operation Mode:** TX / IEEE 802.11n HT40 mode / CH Mid

**Test Date:** 2014/5/21~22

**Temperature:** 26°C

**Tested by:** Francis Lee

**Humidity:** 56%RH

**Polarity:** Ver. / Hor.

Freq. (MHz)	Reading (dBuV)	Correct Factor (dB/m)	Result (dBuV/m)	Limit (dBuV/m)	Margin (dB)	Ant. Pol H/V	Remark
1506.000	51.77	-5.23	46.54	74.00	-27.46	V	peak
2000.000	49.29	-1.30	47.99	74.00	-26.01	V	peak
2946.000	49.61	-0.95	48.66	74.00	-25.34	V	peak
4075.000	40.78	3.21	43.99	74.00	-30.01	V	peak
4885.000	43.43	4.03	47.46	74.00	-26.54	V	peak
7530.000	39.03	11.65	50.68	74.00	-23.32	V	peak
1384.000	51.41	-7.31	44.10	74.00	-29.90	H	peak
2128.000	49.38	-3.72	45.66	74.00	-28.34	H	peak
2868.000	48.89	-1.97	46.92	74.00	-27.08	H	peak
4360.000	41.47	7.22	48.69	74.00	-25.31	H	peak
4875.000	42.61	6.73	49.34	74.00	-24.66	H	peak
5900.000	40.81	9.22	50.03	74.00	-23.97	H	peak

**Remark:**

1. Measuring frequencies from 1 GHz to the 10th harmonic of highest fundamental frequency.
2. Radiated emissions measured in frequency above 1000MHz were made with an instrument using peak/average detector mode.
3. Average test would be performed if the peak result were greater than the average limit.
4. Data of measurement within this frequency range shown " --- " in the table above means the reading of emissions are attenuated more than 20dB below the permissible limits or the field strength is too small to be measured.
5. Measurements above show only up to 6 maximum emissions noted, or would be lesser, with " N/A " remark, if no specific emissions from the EUT are recorded (ie: margin>20dB from the applicable limit) and considered that's already beyond the background noise floor.
6. Margin (dB) = Remark result (dBuV/m) – Average limit (dBuV/m).



**Operation Mode:** TX / IEEE 802.11n HT40 mode / CH High

**Test Date:** 2014/5/21~22

**Temperature:** 26°C

**Tested by:** Francis Lee

**Humidity:** 56%RH

**Polarity:** Ver. / Hor.

Freq. (MHz)	Reading (dBuV)	Correct Factor (dB/m)	Result (dBuV/m)	Limit (dBuV/m)	Margin (dB)	Ant. Pol H/V	Remark
1514.000	51.28	-5.19	46.09	74.00	-27.91	V	peak
1986.000	49.81	-1.52	48.29	74.00	-25.71	V	peak
2888.000	50.38	-0.83	49.55	74.00	-24.45	V	peak
4030.000	40.25	3.38	43.63	74.00	-30.37	V	peak
4850.000	44.41	3.25	47.66	74.00	-26.34	V	peak
7385.000	38.96	11.18	50.14	74.00	-23.86	V	peak
1404.000	51.48	-6.98	44.50	74.00	-29.50	H	peak
2148.000	50.07	-3.67	46.40	74.00	-27.60	H	peak
2580.000	51.55	-3.45	48.10	74.00	-25.90	H	peak
4270.000	41.26	7.16	48.42	74.00	-25.58	H	peak
5600.000	39.56	9.20	48.76	74.00	-25.24	H	peak
7320.000	39.24	11.72	50.96	74.00	-23.04	H	peak

**Remark:**

1. Measuring frequencies from 1 GHz to the 10th harmonic of highest fundamental frequency.
2. Radiated emissions measured in frequency above 1000MHz were made with an instrument using peak/average detector mode.
3. Average test would be performed if the peak result were greater than the average limit.
4. Data of measurement within this frequency range shown " --- " in the table above means the reading of emissions are attenuated more than 20dB below the permissible limits or the field strength is too small to be measured.
5. Measurements above show only up to 6 maximum emissions noted, or would be lesser, with " N/A " remark, if no specific emissions from the EUT are recorded (ie: margin>20dB from the applicable limit) and considered that's already beyond the background noise floor.
6. Margin (dB) = Remark result (dBuV/m) – Average limit (dBuV/m).



## 7.7 POWERLINE CONDUCTED EMISSIONS

### LIMIT

According to §15.207(a), except as shown in paragraphs (b) and (c) of this section, for an intentional radiator that is designed to be connected to the public utility (AC) power line, the radio frequency voltage that is conducted back onto the AC power line on any frequency or frequencies within the band 150 kHz to 30 MHz shall not exceed the limits in the following table, as measured using a 50  $\mu$ H/50 ohms line impedance stabilization network (LISN). Compliance with the provisions of this paragraph shall be based on the measurement of the radio frequency voltage between each power line and ground at the power terminal. The lower limit applies at the boundary between the frequency ranges.

Frequency Range (MHz)	Limits (dB $\mu$ V)	
	Quasi-peak	Average
0.15 to 0.50	66 to 56*	56 to 46*
0.50 to 5	56	46
5 to 30	60	50

\* Decreases with the logarithm of the frequency.

### Test Configuration

See test photographs attached in Appendix 1 for the actual connections between EUT and support equipment.

### TEST PROCEDURE

1. The EUT was placed on a table, which is 0.8m above ground plane.
2. Maximum procedure was performed on the six highest emissions to ensure EUT compliance.
3. Repeat above procedures until all frequency measured were complete.



## TEST RESULTS

The initial step in collecting conducted data is a spectrum analyzer peak scan of the measurement range. Significant peaks are then marked as shown on the following data page, and these signals are then quasi-peaked.

### Test Data

<b>Operation Mode:</b>	LAN Mode	<b>Test Date:</b>	2014/5/19
<b>Temperature:</b>	25°C	<b>Tested by:</b>	Tony Tsai
<b>Humidity:</b>	57% RH		

Freq. (MHz)	QP Reading	AV Reading	Corr. factor	QP Result	AV Result	QP Limit	AV Limit	QP Margin	AV Margin	Note
0.4340	30.60	23.22	9.89	40.49	33.11	57.18	47.18	-16.69	-14.07	L1
4.2300	30.63	14.61	10.17	40.80	24.78	56.00	46.00	-15.20	-21.22	L1
8.7180	36.89	18.50	10.27	47.16	28.77	60.00	50.00	-12.84	-21.23	L1
16.2300	34.55	24.25	10.58	45.13	34.83	60.00	50.00	-14.87	-15.17	L1
18.2460	29.05	11.85	10.65	39.70	22.50	60.00	50.00	-20.30	-27.50	L1
23.1300	36.76	27.62	10.91	47.67	38.53	60.00	50.00	-12.33	-11.47	L1
0.4380	33.19	23.07	9.81	43.00	32.88	57.10	47.10	-14.10	-14.22	L2
2.2260	32.34	20.00	10.00	42.34	30.00	56.00	46.00	-13.66	-16.00	L2
3.6180	34.40	21.47	10.12	44.52	31.59	56.00	46.00	-11.48	-14.41	L2
4.4140	32.89	17.48	10.18	43.07	27.66	56.00	46.00	-12.93	-18.34	L2
8.7180	35.99	22.52	10.31	46.30	32.83	60.00	50.00	-13.70	-17.17	L2
16.2300	34.77	27.56	10.57	45.34	38.13	60.00	50.00	-14.66	-11.87	L2

**Remark:**

1. Measuring frequencies from 0.15 MHz to 30MHz.
2. The emissions measured in frequency range from 0.15 MHz to 30MHz were made with an instrument using Quasi-peak detector and average detector.
3. The IF bandwidth of SPA between 0.15MHz to 30MHz was 10kHz; the IF bandwidth of Test Receiver between 0.15MHz to 30MHz was 9kHz;
4. L1 = Line One (Live Line) / L2 = Line Two (Neutral Line)



**Test Plots**

**Conducted emissions (Line 1)**

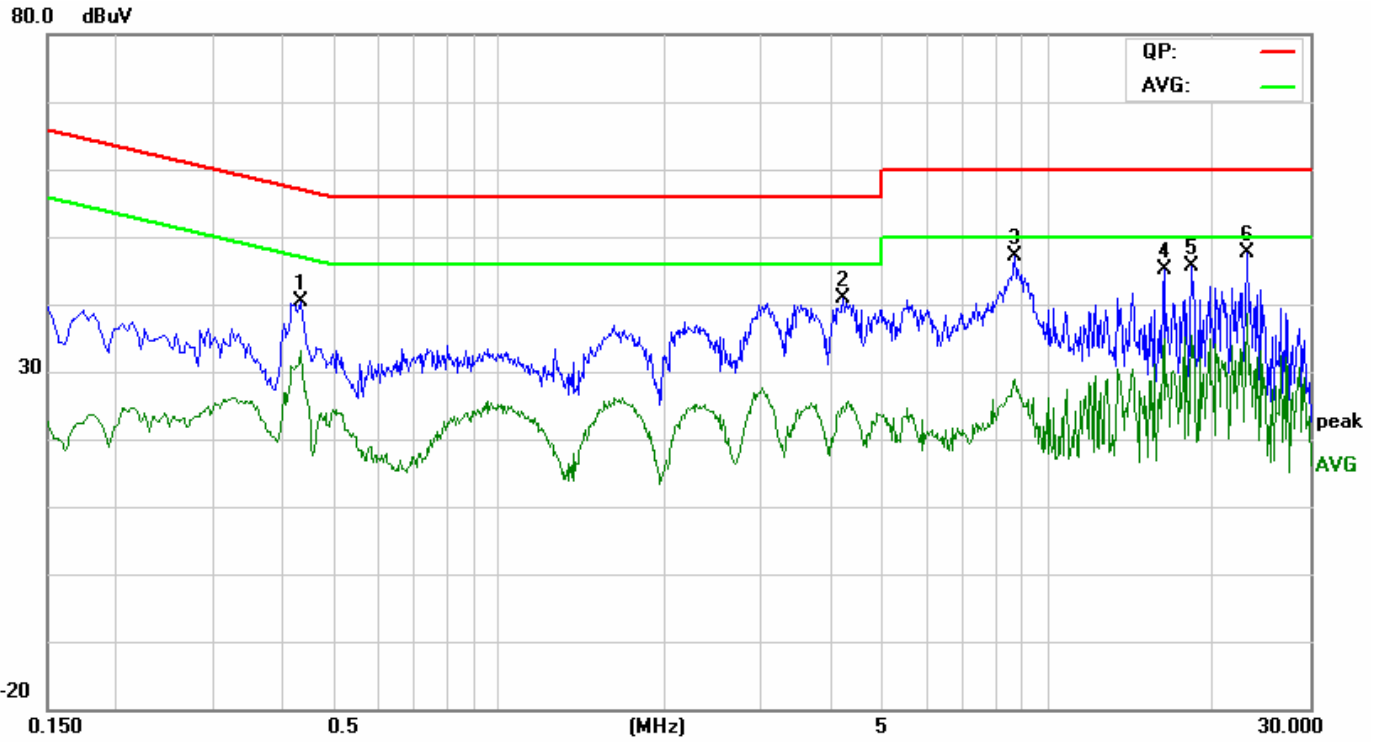

**Conducted emissions (Line 2)**

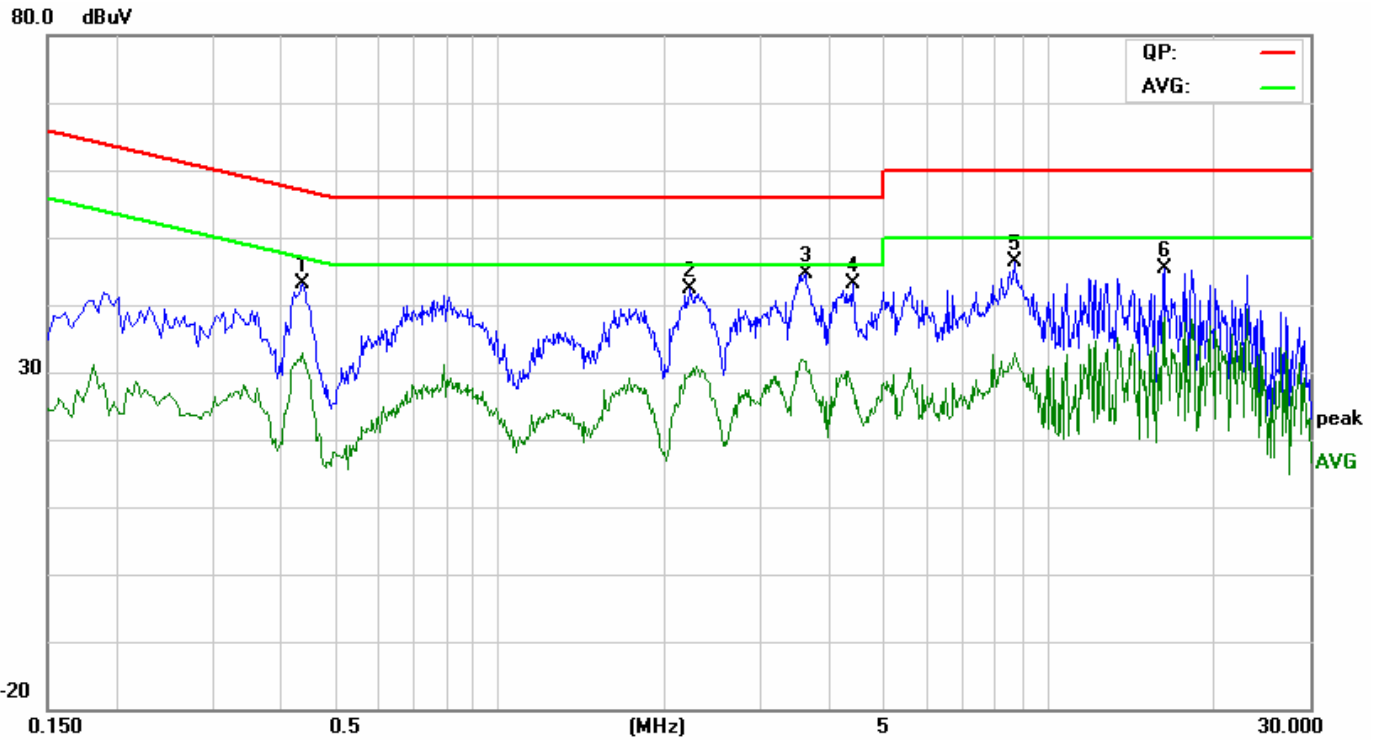



## 8 APPENDIX I PHOTOGRAPHS OF TEST SETUP

### Radiated Emissions Setup Photos Below 1GHz





**Above 1GHz**





## Conducted Emissions Setup Photo





## Powerline Conducted Emissions Setup Photos





## **9 APPENDIX II: PHOTOGRAPHS OF EUT**

**Refer to T140317J01 External Photographs.**