

亞 驪 企 業 股 份 有 限 公 司

ARISTOTLE ENTERPRISES

承 認 申 請 書

ROHS COMPLIANCE

客戶名稱: 永洋科技股份有限公司
Customer
廠商料號: RFA-25-G563-70B-70
Part No.
品名: L=70mm
Description
圖號: RFA-25-G563-70B-70
Drawing No.
客戶料號: 11320Y20ZS003Z1A1
Drawing No.

出廠簽章:

檢 查 TEST BY	核 對 CHECK BY	承 認 APPROVE BY
張家福	張鴻隆	廖煥文

承認簽章:

檢 查 TEST BY	核 對 CHECK BY	承 認 APPROVE BY

地址:新北市中和區莒光路 63 號 8 樓

電話:02-2225-8209

傳真:02-2225-7523

Revision History

Revision	Date	Description
V1	2024/11/27	新發行

NO.	NAME	FINSH	MAT'L	Q'TY	MEMO
1.	ANT	SILVER	SPTe	1	
2.	Cable	BLACK	--	1	ø1.13
3.	IPEX	GOLD PLATED	PHOSPHOR BRONZE	1	MHF1 20278-112R-13

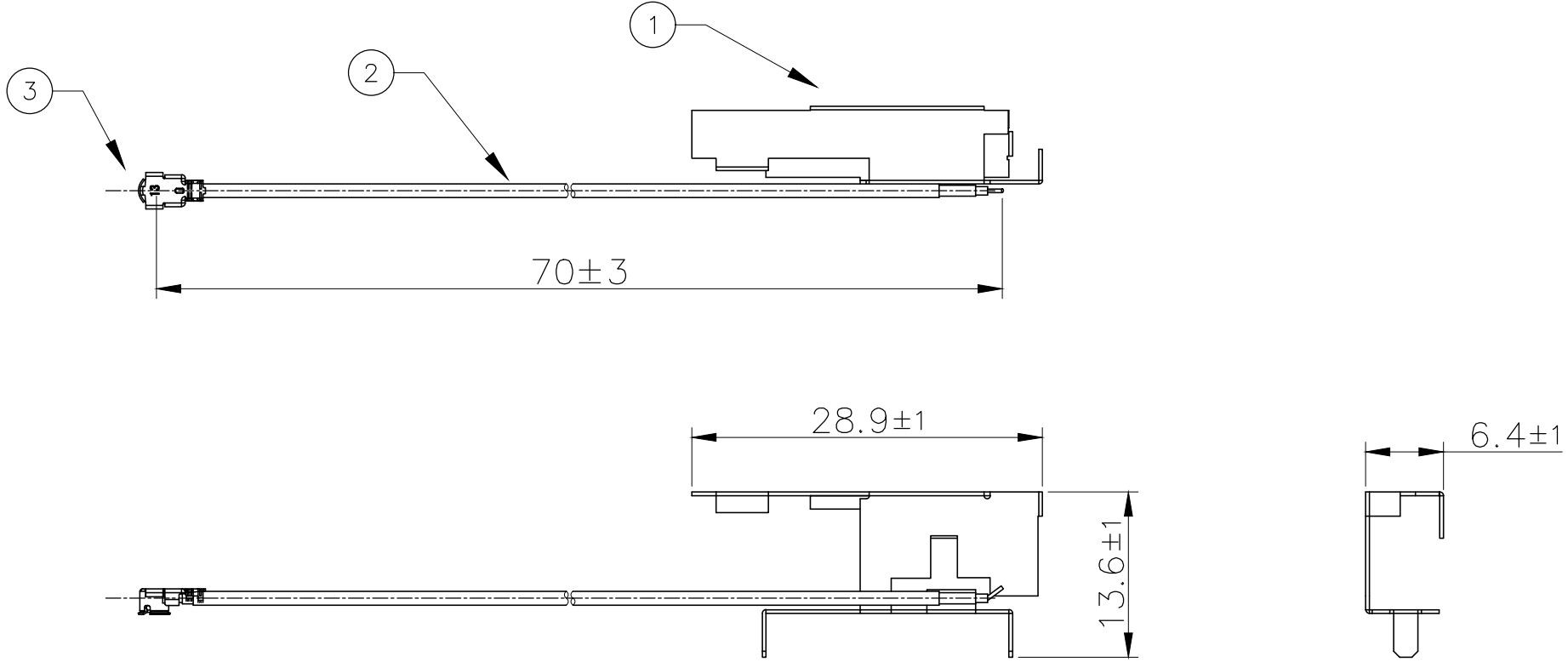

PROJECTION		TOLERANCE UNLESS OTHERWISE SPECIFIED		亞驪企業股份有限公司	
		LINER	ANGLE	ARISTOTLE ENTERPRISES INC.	
UNITS		.X ±1.0	X° ±5°	TITLE	
MM		.XX ±0.5		RFA-25-G563-70B-70	
		.XXX ±0.2		DWG NO.	
				RFA-25-G563-70B-70	

3.				REV.	A		
2.				SHEET	1/1	CHKD.	
1.				SIZE	SCALE		
REV.	ECN.	NAME	DATE	A4	1:1	DRAW	Gino 20241105

亞驪企業股份有限公司

ARISTOTLE ENTERPRISES Inc.

REACH 自我宣告書 (REACH Declaration of Conformity)

亞驪企業股份有限公司(以下稱本公司)特此保證售予貴公司之所有產品,皆符合禁限用危害物質 REACH 法規之要求

ARISTOTLE ENTERPRISES Inc. declares that all products sold to the company, are complied with REACH and restricted and banned substance regulations (Registration, Evaluation, Authorization and Restriction of Chemical substances, REACH!)

敝公司產品狀態符合下列其一:

Our products come meet REACH request as below categories:

符合,沒有使用 SVHC 241 項限用物質 do not use SVHC 241 limited substances

未符合,有使用 SVHC 241 項限用物質 There are SVHC 241 restricted substances
備註:

- 料號: 11320Y20ZS003Z1A1 (RFA-25-G563-70B-70)
11320Y20ZS003Z1B1 (RFA-25-G559-79-210)
11320Y20ZS003Z1C1 (RFA-05-G559-70B-90)

立保證書人

Company name 公司名稱: 亞驪企業股份有限公司

Company Representative 公司代表人: 陳惠珠

Date 日期: 2024/11/26

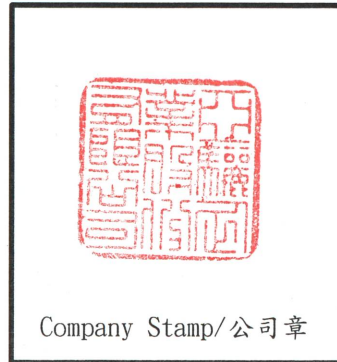
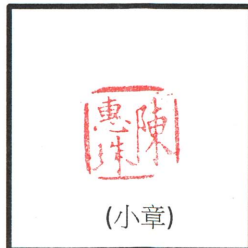

無衝突金屬宣告書

Declaration of Metal Conflict-Free

亞驪企業股份有限公司特此聲明所有提供給客戶之產品和代理皆為無衝突規範之產品：

ARISTOTLE ENTERPRISES INC. herein declare the DRC Conflict-Free on products supplied to customers.

亞驪企業股份有限公司正在將對物料來源盡我最大努力拒絕使用從衝突地區來的衝突礦物。亦正或將致力於詳實調查供應鏈確保金(Au)、鉭(Ta)、鎢(W)、鈷(Co)、錫(Sn)這類金屬並非透過無政府軍團或非法集團，由剛果民主共和國衝突區域之礦區開採或是循非法走私途徑取得。此外，下列國家出口之金屬皆不符合「無衝突規範」：剛果民主共和國(DRC)、盧安達(Rwanda)、烏干達(Uganda)、蒲隆地(Burundi)、坦尚尼亞(Tanzania)、肯亞(Kenya) (聯合國安全理事會認定上述國家皆為剛果礦脈之礦產)。

ARISTOTLE ENTERPRISES INC. is continuing our industry leadership and our efforts to source conflict-free minerals from the DRC where possible. And, is taking and will take due diligence within our supply chain to assure "DRC Conflict-Free" for the metals of gold (Au), tantalum (Ta), tungsten (W), cobalt(Co) and tin (Sn) are not derived from or sourced from mines in conflict areas of the Democratic Republic of Congo (DRC), or illegally taxed on trade routes, either of which are controlled by non-governmental military groups, or unlawful military factions. Trade routes not confirmed to be "Conflict Free" include direct exports from the DRC, as well as exports through Rwanda, Uganda, Burundi, Tanzania and Kenya (countries of whom the U.N. Security Council note are global export routes for DRC-mined minerals).

本公司保證任何出售於之產品及代理所含金屬皆符合無衝突規範 (DRC Conflict-Free)。

We would like to confirm metals used in Products are "DRC Conflict-Free".

Supplier Company (公司名稱): 亞驪企業股份有限公司

Authorized Signature (公司負責或授權人簽章): 陳惠珠



Title (職稱): 董事長

Date (填寫日期): 2024/10/15

RFA-25-G563-70B-70

Electrical Specifications

Frequency range	2400-2500 MHz	5150-5875 MHz
Peak gain	3.26 dBi	4.97 dBi
Average gain	-1.79 dBi	-2.25 dBi
VSWR	2.0 : 1 Max.	2.0 : 1 Max.
Polarization	Linear, vertical	
Impedance	50 Ω	
Connector	IPEX	
Cable	\varnothing 1.13 / Black / L=70mm	

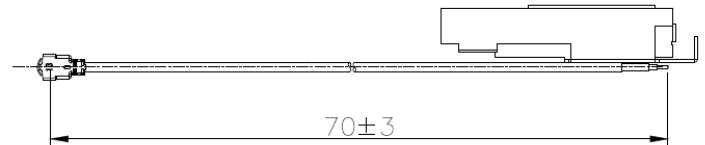

Environmental & Mechanical Characteristics

Temperature	-10°C to +55°C
Humidity	95% @ 25°C

VSWR

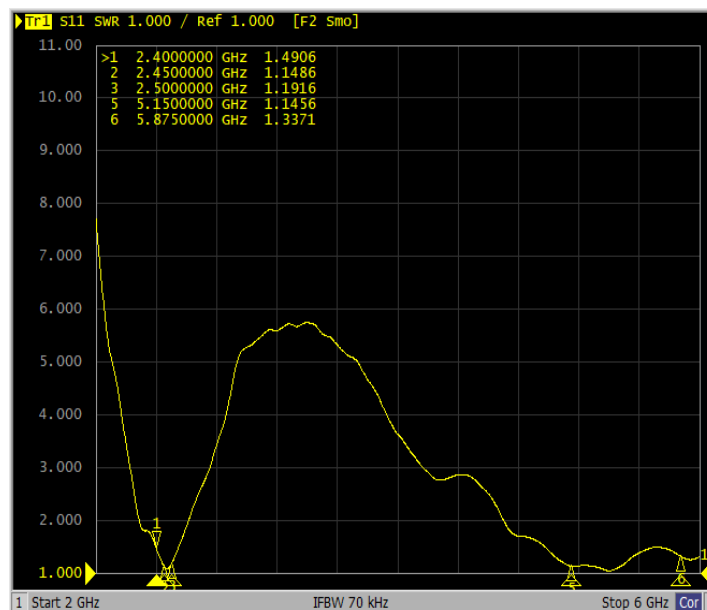

Radiation Pattern

2G Band = 2400 - 2500 MHz % 2G BAND

XY Plane (+X = 0φX, +Y = +90φX) / Elevation = 90 φX

ZX Plane (+Z = 0φX, +X = +90φX) / Azimuth = 0 φX

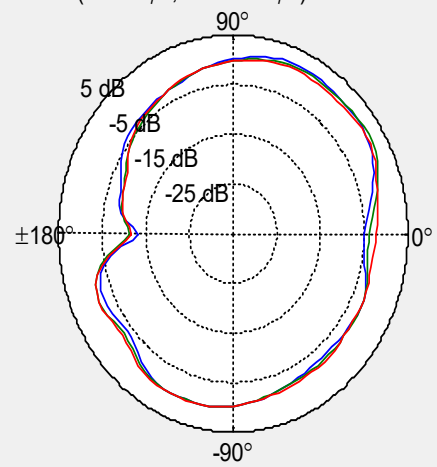
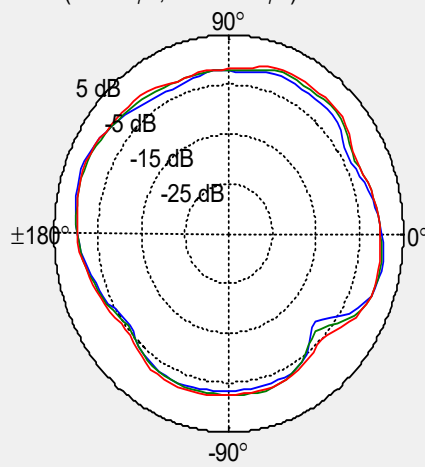
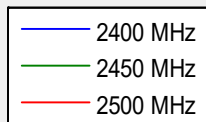

YZ Plane (+Z = 0φX, +Y = +90φX) / Azimuth = 90 φX

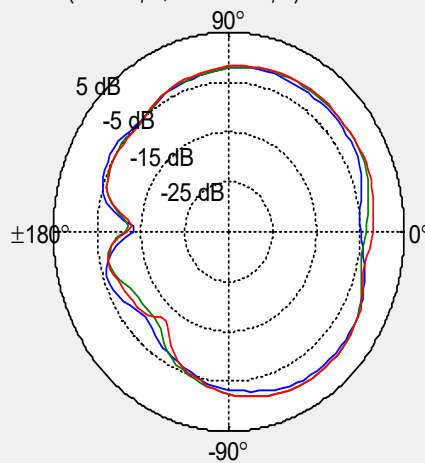

Radiation Pattern

5G Band = 4900 - 5975 MHz

XY Plane (+X = 0°ϕX, +Y = +90°ϕX) / Elevation = 90°ϕX

ZX Plane (+Z = 0°ϕX, +X = +90°ϕX) / Azimuth = 0°ϕX

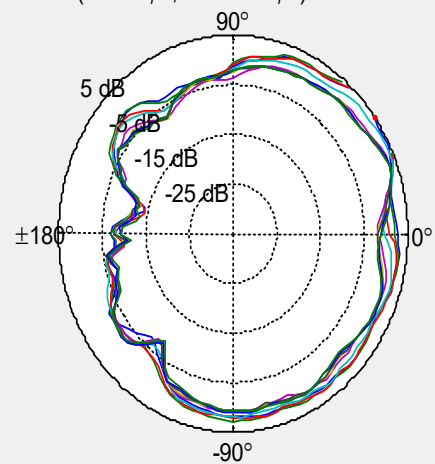
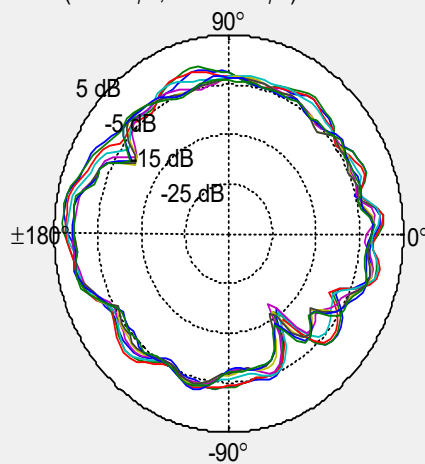
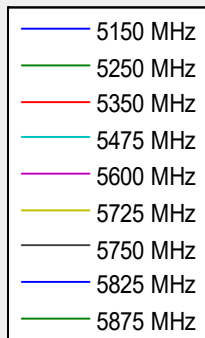

YZ Plane (+Z = 0°ϕX, +Y = +90°ϕX) / Azimuth = 90°ϕX

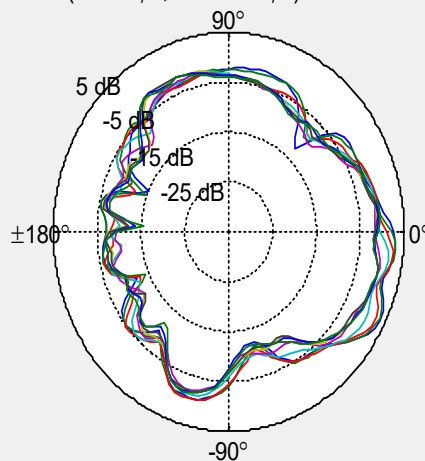

品質證明書
CERTIFICATE OF QUALITY AND MASS



製造商 統一實業股份有限公司
 MANUFACTURER : TON YI INDUSTRIAL CORP.
 證明書編號 頁
 CERTIFICATE NO : 12010151 PAGE : 1
 證明書日期
 DATE OF ISSUE : 2012.01.12

SHIPPING MARK

參考編號
 REFERENCE NO :
 合約編號
 CONTRACT NO :
 品名
 COMMODITY : HIGH SOLDER TINPLATE
 規格
 SPECIFICATION : JIS G 3303 SPTE MR T-4CA S 5.6/5.6 0.280*837.0*1.0

客戶
 CUSTOMER : 廣有金屬企業股份有限公司
 客戶編號
 CUSTOMER CONTROL NO : 00394

註記
 NOTE : KU360S

包裝編號 PACKAGE NO:	檢查號碼 INSPECTION NO:	圈解號碼 COIL NO :	數量 LENGTH /SHEET	淨重 NET MASS	毛量 GROSS MASS	HR 30T	COATING WEIGHT		CHEMICAL COMPOSITION(%)					YP N/mm2	TS N/mm2	EL %
							TOP	BOT	C	Si	Mn	P	S			
							X 100			X 1000						
1	1191322015 TOTAL	B11905CB06 1	4311M 4311	9268 9268	9368	58			4	1	26	13	4			
備註 REMARKS	COIL LENGTH UNIT : Meter / Feet NET MASS UNIT : KG / LB $\text{kgf / mm}^2 = (\text{N/mm}^2) / 9.8$ GROSS MASS UNIT : KG / LB HR-30T : Rockwell Superficial Hardness Test COATION WEIGHT UNIT : TIN : (g/m ²)/(LB/BB) TFS : mg/m ²						茲證明本表所列檢查結果均按本公司存檔資料記載正確無誤。 WE HEREBY CERTIFY THAT THE MATERIAL DESCRIBED HEREIN HAS BEEN TESTED AND INSPECTED WITH SATISFACTORY RESULTS IN ACCORDANCE WITH THE REQUIREMENTS OF THE ABOVE SPECIFICATION.						 MANAGER INSPECTION.			



MHF[®] I Connector

Ground contact gold plating
(Anti-static reel version)

Part No. Plug: 20278-1**R-** Receptacle: 20279-001E-0*

Product Specification

Qualification Test Report No. TR-12044

10	S22224	June 1, 2022	S. Tsuboki	K. Yufu	Y. Hashimoto
9	S21589	November 11, 2021	S. Taguchi		M. Takemoto
8	S20594	November 11, 2020	S. Taguchi	J. Tonai	M. Takemoto
7	S20398	August 6, 2020	K. Ikeshita	J. Tonai	M. Takemoto
Rev.	ECN	Date	Prepared by	Checked by	Approved by

1. Scope

This Product Specification defines the test conditions and the performances of the MHF I Connector.

2. Product Name and Parts No.

2.1 Product Name

MHF I Connector

2.2 Parts No.

Plug: 20278-1**R-08,-13,-32,-18

Receptacle: 20279-001E-0* (Anti-static reel version)

3. Product Shape, Dimensions and Material.

Refer to the drawing

4. Rating

4.1 Applicable cable

4.1.1 Part No. 20278-101R-08, 20278-111R-08, 20278-102R-08, 20278-112R-08

(1) Description

Inner conductor : AWG#36(7/0.05) ,Silver plating copper wire

Dielectric core : Fluoro-plastics , diameter 0.40(+0.04,-0.02)mm

Outer conductor : Braid of 0.05mm, diameter 0.65(±0.1)mm ,
silver plating copper wire or tin plating copper wire

Jacket : Fluoro-plastics , diameter 0.81(+0.04,-0.03)mm

(2) Requirements

Characteristic impedance : 50±3Ω by TDR method

Nominal capacitance(Reference value): 96 pF/m

Dielectric withstand voltage : no breakdown at AC 1,000V for 1 minutes.

4.1.2 Part No. 20278-101R-13, 20278-111R-13, 20278-102R-13, 20278-112R-13

(1) Description

Inner conductor : AWG#32(7/0.08), Silver plating copper wire

Dielectric core : Fluoro-plastics , diameter 0.70(±0.05)mm

Outer conductor : Braid of 0.05mm, diameter0.93(±0.09)mm ,
silver plating copper wire or tin plating copper wire

Jacket : Fluoro-plastics , diameter 1.13(+0.08,-0.05)mm

(2) Requirements

Characteristic impedance : 50±2Ω by TDR method

Nominal capacitance(Reference value) : 97 pF/m

Dielectric withstand voltage : no breakdown at AC 1,000V for 1 minutes.

4.1.3 Part No. 20278-101R-32, 20278-111R-32, 20278-102R-32, 20278-112R-32

(1) Description

Inner conductor : AWG#32(7/0.08), Silver plating copper wire

Dielectric core : Fluoro-plastics , diameter 0.66(±0.05)mm

First outer conductor : Braid of 0.05mm, tin plating copper wire

Second outer conductor : Braid of 0.05mm, diameter 1.12(±0.1)mm , tin plating copper wire

Jacket : Fluoro-plastics , diameter 1.32(±0.1)mm

(2) Requirements

Characteristic impedance : 50±2Ω by TDR method

Nominal capacitance(Reference value): 95 pF/m

Dielectric withstand voltage : no breakdown at AC 1,500V for 1 minutes.

4.1.4 Part No. 20278-101R-18, 20278-111R-18, 20278-102R-18, 20278-112R-18

RG178 B/U

(1) Description

Inner conductor : AWG#30(7/0.102), silver plating copper clad steel wire

Dielectric core : Fluoro-plastics , diameter 0.84(±0.03)mm

Outer conductor : Braid of 0.1mm , diameter 1.35(±0.14)mm , silver plating copper wire

Jacket : Fluoro-plastics , diameter 1.8(±0.1)mm

(2) Requirements

Characteristic impedance : $50 \pm 2 \Omega$ by TDR method

Nominal capacitance(Reference value): 95 pF/m

Dielectric withstand voltage : no breakdown at AC 2,000V for 1 minutes.

4.2 Operating Condition

Voltage : 60V AC (per contact pin)

Operating Temperature : 233~363K(-40°C~+90°C)

(Containing temperature rise by current)

Nominal characteristic impedance : 50Ω

Frequency : DC~9.0GHz

VSWR : Plug: 1.30 MAX. at 0.1~3GHz, 1.50 MAX. at 3~6GHz, 1.90 MAX. at 6~9GHz (0.81 O.D., 1.13 O.D., 1.80 O.D.)

1.30 MAX. at 0.1~3GHz, 1.50 MAX. at 3~6GHz, 1.60 MAX. at 6~9GHz (1.32 O.D.)

Receptacle: 1.30 MAX. at 0.1~3GHz, 1.40 MAX. at 3~6GHz, 1.80 MAX. at 6~9GHz

Storage condition : Temperature 248K~333K(-25°C~+60°C)

Humidity : 85% MAX. (No condensation)

5. Test and Performance

Test Condition

This initial test is equal to it's at shipping condition and unless otherwise specified, all tests and measurements shall be performed under the following conditions in accordance with MIL-STD-202.

Temperature ... 288K~308K (15°C~35°C)

Pressure ... 866hPa~1066hPa (650mmHg~800mmHg)

Relative Humidity ... 45~75%R.H.

5.1. Electrical Performance

1. Contact resistance

Reference standard: MIL-STD-202G, Method 307

Test conditions: Solder the receptacle connector to the test board and mate the plug connector together, then measure the contact resistance as shown in Fig. 1 by the four terminal method.

Open circuit voltage: 20mV MAX
Circuit current: 10mA MAX.

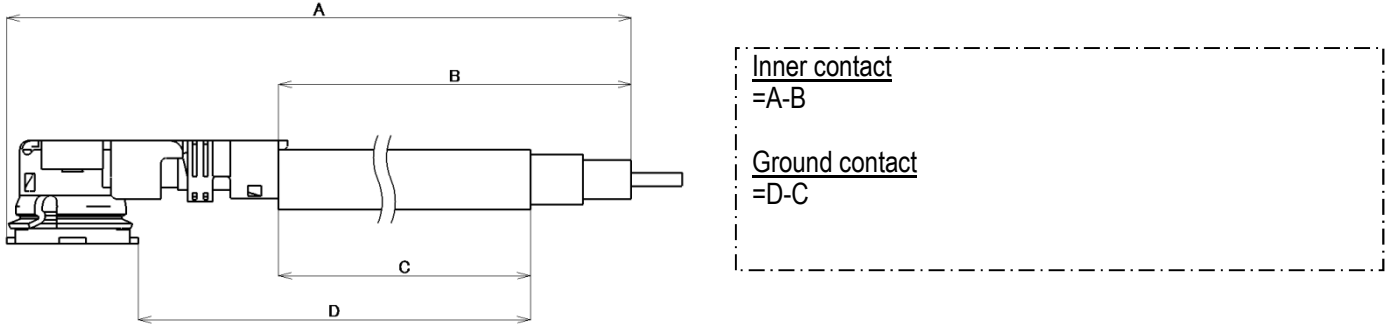

Fig. 1

Pass criteria: Inner contact Initial : 20mΩ MAX. After testing : 25mΩ MAX.
Ground contact Initial : 10mΩ MAX. After testing : 15mΩ MAX.

2. Insulation resistance

Reference standard: MIL-STD-202-302, Test condition A

Test conditions: Mate the plug and receptacle connector together, and then apply DC 100 V between the inner contact and the ground contact.

Pass criteria: Initial : 500 MΩ MIN.
After testing : 100 MΩ MIN.

3. Dielectric withstanding voltage

Reference standard: MIL-STD-202-301

Test conditions: Mate the receptacle and plug connector together, then apply AC 200V(rms) between the neighboring contacts for a minute.

Pass criteria: No abnormalities such as creeping discharge, flashover, insulator breakdown occur.

5.1. Electrical Performance

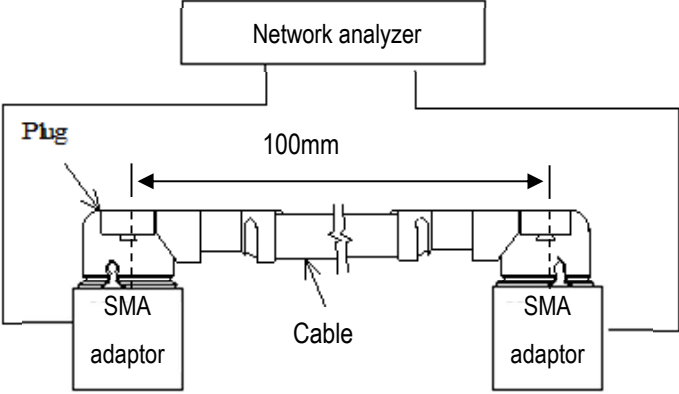
4. VSWR					
Reference standard:					
Test conditions:	Measure the VSWR as shown in Fig. 2 by the network analyzer. Frequency : 100MHz~9.0GHz				
					
Fig. 2					
Pass criteria:	<table border="0"> <tr> <td>Plug</td> <td>0.1~3GHz 1.30 MAX., 3~6GHz 1.50 MAX., 6~9GHz 1.90 MAX. (0.81 O.D., 1.13 O.D., 1.80 O.D.)</td> </tr> <tr> <td>Receptacle</td> <td>0.1~3GHz 1.30 MAX., 3~6GHz 1.40 MAX., 6~9GHz 1.80 MAX.</td> </tr> </table>	Plug	0.1~3GHz 1.30 MAX., 3~6GHz 1.50 MAX., 6~9GHz 1.90 MAX. (0.81 O.D., 1.13 O.D., 1.80 O.D.)	Receptacle	0.1~3GHz 1.30 MAX., 3~6GHz 1.40 MAX., 6~9GHz 1.80 MAX.
Plug	0.1~3GHz 1.30 MAX., 3~6GHz 1.50 MAX., 6~9GHz 1.90 MAX. (0.81 O.D., 1.13 O.D., 1.80 O.D.)				
Receptacle	0.1~3GHz 1.30 MAX., 3~6GHz 1.40 MAX., 6~9GHz 1.80 MAX.				

5.2. Mechanical Performance

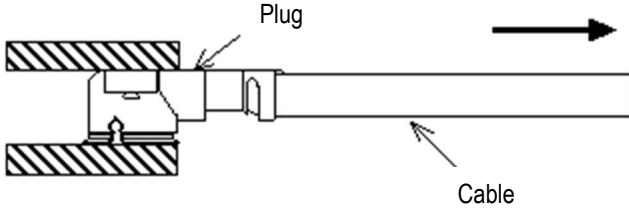
1. Unmating force	
Reference standard:	-
Test conditions:	Solder the receptacle connector to the test board, then place the board and plug on push-on/pull-off machine, measure of initial and mating/un-mating 30 cycles at a speed 25 ± 3 mm/min. along the mating axis.
Pass criteria:	<p>Total unmating force Initial: 5N Min. After 30 cycles: 3N Min.</p> <p>Unmating force of inner contact Initial: 0.15N Min. After 30 cycles: 0.10N Min.</p>
2. Crimp strength	
Reference standard:	-
Test conditions:	Pull the cable as shown in Fig. 3 at a speed 25 ± 3 mm/minutes by tensile strength machine.
	
Fig. 3	
Pass criteria:	<p>20278-1**R-08,13, 32: 10N MIN.</p> <p>20278-1**R-18: 15N MIN.</p>

5.2. Mechanical Performance

3. Durability	
Reference standard:	-
Test conditions:	Solder the receptacle connector to the test board, then place the board and plug on the push-on/pull-off machine, and repeat mating and un-mating 30cycles at a speed $25\pm 3\text{mm/min}$. along the mating axis.
Pass criteria:	[Contact Resistance] Shall meet 5.1.1.

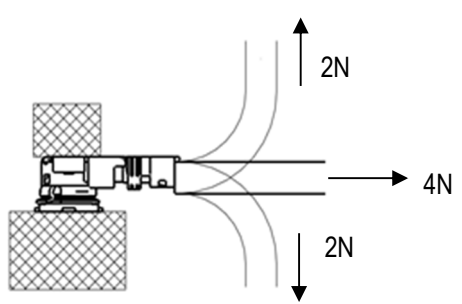
4. Cable retention force	
Reference standard:	-
Test conditions:	Apply force on the cable as shown in Fig. 4. During the testing, run 100mA DC to check electrical discontinuity.
 <p>Fig. 4</p>	
Pass criteria:	[Contact Resistance] Shall meet 5.1.1. [Electrical discontinuity] No electrical discontinuity greater than $1\mu\text{s}$ shall occur. [Appearance] No abnormality adversely affecting the performance shall occur.

5. Vibration	
Reference standard:	-
Test conditions:	Apply the following vibration to the mating connector. During the testing, run 100mA DC to check electrical discontinuity. Frequency: $10\text{Hz}\rightarrow 100\text{Hz}\rightarrow 10\text{Hz}$ / approx. 15 minutes. Half amplitude ,Peak value of acceleration 1.5mm or 59m/s^2 (6G) Directions , cycle 3 mutually perpendicular direction 5 cycles(approx. 75min)about each direction
Pass criteria:	[Contact Resistance] Shall meet 5.1.1. [Electrical discontinuity] No electrical discontinuity greater than $1\mu\text{s}$ shall occur. [Appearance] No abnormality adversely affecting the performance shall occur.

6. Shock	
Reference standard:	-
Test conditions:	Apply the following vibration to the mating connector. During the testing, run 100mA DC to check electrical discontinuity. Peak value of acceleration : 735m/s^2 (75G) Duration: 11msec Wave Form: half sinusoidal Directions, cycle: 6 mutually perpendicular direction, 3 cycles about each direction
Pass criteria:	[Contact Resistance] Shall meet 5.1.1. [Electrical discontinuity] No electrical discontinuity greater than $1\mu\text{s}$ shall occur. [Appearance] No abnormality adversely affecting the performance shall occur.

5.3. Environmental Performance

1. Thermal Shock	
Reference standard:	-
Test conditions:	Apply the following environment to the mating connector. Temperature ,duration: 233K(-40°C)/30 minutes →278~308K(5~35°C)/5 minutes MAX. →363K(90°C)/30 minutes →278~308K(5~35°C)/5 minutes MAX. Number of cycles : 5 cycles
Pass criteria:	[Contact Resistance] Shall meet 5.1.1. [Insulation Resistance] Shall meet 5.1.2. [Appearance] No abnormality adversely affecting the performance shall occur.

2. Humidity (Steady State)	
Reference standard:	MIL-STD-202G, Method 103, Condition B
Test conditions:	Solder the receptacle connector to the test board, then mate plug connector, and expose them to the following environment. Temperature: 313±2 K (40±2°C) Humidity: 90~95%RH Duration: 96 hours
Pass criteria:	[Contact Resistance] Shall meet 5.1.1. [Insulation Resistance] Shall meet 5.1.2. [Appearance] No abnormality adversely affecting the performance shall occur.

3. Salt Water Spray	
Reference standard:	MIL-STD-202G, Method 101, Condition B
Test conditions:	Solder the receptacle connector to the test board, then mate plug connector, and expose them to the following environment. Temperature: 308±2K (35±2°C) Salt water density: 5±1% [by weight] Duration: 48 hours
Pass criteria:	[Contact Resistance] Shall meet 5.1.1. [Appearance] No abnormality adversely affecting the performance shall occur.

4. High Temperature Life	
Reference standard:	-
Test conditions:	Apply the following environment to the mating connector. Temperature: 363±2K (90±2°C) Duration: 96 hours
Pass criteria:	[Contact Resistance] Shall meet 5.1.1. [[Appearance] No abnormality adversely affecting the performance shall occur.

5.4. Others

1. Solder ability	
Reference standard:	-
Test conditions:	Dip the solder tine of the contact in the solder bath at $518 \pm 5\text{K}$ ($245 \pm 5^\circ\text{C}$) for 5 ± 0.5 seconds after immersing the tine in the flux of RMA or R type for 5 to 10 seconds.
Pass criteria:	More than 95% of the dipped surface shall be evenly wet.

2. Soldering Heat Resistance	
Reference standard:	-
Test conditions:	Put on the receptacle connector to PCB, apply the heat 2 cycles as shown in Fig. 5.
<p>The graph plots Temperature on the vertical axis and Time on the horizontal axis. It shows a thermal cycle with three main segments:</p> <ul style="list-style-type: none"> Initial Ramp: A linear increase in temperature with a gradient of 1~4 K/sec. Plateau: A horizontal segment at a temperature range of 433~473K (160~200°C) lasting for 1~2 minutes. Final Ramp: A linear decrease in temperature with a gradient of -3 ~ -6 K/sec. <p>At the peak of the final ramp, there is a specific condition: 533K (260°C) for a duration of 10±0.5 sec.</p>	
Pass criteria:	[Appearance] No abnormality adversely affecting the performance shall occur.

Fig. 5

5.5 Test Sequence and Sample Quantity

Table 1 Test Sequence and Sample Quantity

Test Item	Group														
	A	B	C	D	E	F	G	H	J	K	L	M	N	P	
Contact Resistance					1,3	1,3	1,3	1,3	1,4	1,4	1,3	1,3			
Insulation Resistance									2,5	2,5					
Dielectric Withstanding Voltage	1														
VSWR		1													
Unmating Force			1												
Crimp Strength				1											
Durability					2										
Cable Retention Force						2									
Vibration							2								
Shock								2							
Thermal Shock									3						
Humidity (Steady State)										3					
Salt Water Spray											2				
High Temperature Life												2			
Solder ability													1		
Soldering Heat Resistance														1	
Sample Quantity	Plug	10	10	10	10	10	10	10	10	10	10	10	10	-	-
	Receptacle		5		-									10	10

Numbers indicate sequence in which tests are performed.

6. Recommended Metal Mask

Refer to drawing for the recommended metal mask thickness and opening dimension.

SPECIFICATION FOR APPROVAL

DOCUMENT: A3132TS001

STYLE : COAXIAL CABLE
105°C 30V

SIZE: 32AWG×1C
BRAID : TS

RECOGNIZED: UL 1979
MEET VW-1



WONDERFUL HI-TECH CO.,LTD.

OFFICE : 72WU KONG 6TH ROAD,
WU KU IND. DISTRICT
TAIPEI HSIEN,TAIWAN

FACTORY : 17 PEI YUAN ROAD,
CHUNG-LI IND. PARK
TAIWAN, R.O.C.

TEL : (02)22988033
FAX : (02)22988031-2

TEL : (03)4527777
FAX : (03)4622419

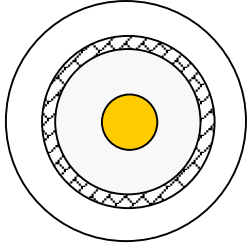

WONDERFUL HI-TECH CO., LTD. SPECIFICATION

STYLE	105°C 30V UL 1979	DOCUMENT NO : A3132TS001	
SIZE	32AWG	ESTABLISHED DATE: Mar/16/2005	
STANDARD :			
Conductor	Size	AWG	32
	Material	----	Silver Cover Copper
	Conductors No.	----	7
	Conductors Size	mm	0.085± 0.008
	O.D.	mm	0.26± 0.03
Insulation	Average Thickness	mm	0.22± 0.03
	Diameter	mm	0.70 ± 0.03
	Material	----	FEP
	Color	----	Clear
Braid	Material	----	Tinned Copper
	Construction	mm	16 / 4 / 0.05
	Coverage	%	90
Jacket	Average Thickness	mm	0.12±0.05
	Diameter	mm	1.13±0.1
	Material	----	FEP
	Color	----	According to customer
Marking	Non		
Drawing			



WONDERFUL HI-TECH CO., LTD.

SPECIFICATION

Electrical & Physical Properties			
Item		32AWG	
Rating Temp. Voltage		105°C 30V	
Conductor Resistance		497 OHM/KM/20°C MAX.	
Insulation Resistance		3000 MEGA OHM-KM MIN.	
Dielectric Strength		AC 500 V/Minute	
Spark Test		1 KV	
Insulation	Unaged	Tensile Strength	2500 PSI MIN.(1.76 Kg / m m ²)
		Elongation	200% MIN.
	Aged	Tensile Strength	UNAGED MIN. 75%(168HRS×232°C)
		Elongation	UNAGED MIN. 75%(168HRS×232°C)
Jacket	Unaged	Tensile Strength	2500 PSI MIN.(1.76 Kg / m m ²)
		Elongation	200% MIN.
	Aged	Tensile Strength	UNAGED MIN.75%(168HRS×232°C)
		Elongation	UNAGED MIN.75%(168HRS×232°C)
Nom. Impedance		50 ± 3 Ohms	
Nom. Capacitance		96 ± 3 pF/m	
Nom. Vel. of Prop.		69%	
VSWR Test (0 – 6 GHZ)		Max 1.35	
VSWR Test (6 – 8 GHZ)		Max 1.45	
Flame Test		VW-1 OK	
BEND RADIUS		Min. 5mm	
Operation Temperature		-40~200°C	
Storage Temperature		-40~200°C	

AK001/210X297/1.0

PAGE : 2

EDITION : 1.6

MAKER : Talis Huang

CONFIRM : W.J. Wang

APPROVAL : Glen Lin



WONDERFUL HI-TECH CO., LTD. SPECIFICATION

Attenuation	dB/1m	Frequency	Reference value
		1.0GHz	2.20
		2.0GHz	3.10
		3.0GHz	3.90
		4.0GHz	4.50
		5.0GHz	5.00
		6.0 GHz	5.50
		7.0 GHz	6.10
		8.0 GHz	6.70

The above values may be affected by processing and connector itself, the information is for engineering reference only.

AK001/210X297/1.0

PAGE : 3

EDITION : 1.6

MAKER : Talis Huang

CONFIRM : W.J. Wang

APPROVAL : Glen Lin

RoHS REPORT INDEX

	NAME	供應商	RoHS report
1	馬口鐵	統一實業股份有限公司	ETR24201868M01
2	IPEX		
2-1	HOUSING	POLYPLASTICS TAIWAN CO., LTD.	EKR24400496
2-2	CONTACT	JX ADVANCED METALS CORPORATION	ETR24802273M01
2-3	GROUND CONTACT	JX ADVANCED METALS CORPORATION	ETR24802272M01
3	Cable		
3-1	色母	WONDERFUL HI-TECH CO., LTD.	TWNC01231369
3-2	FEP	大金氟化工(中國)有限公司	SHAEC24018665305
3-3	裸銅線/鍍銀/鍍錫	WONDERFUL HI-TECH CO., LTD.	TWNC01231370

測試報告

Test Report

號碼(No.): ETR24201868M01

日期(Date): 23-Feb-2024

頁數(Page): 1 of 8

統一實業股份有限公司 (TON YI INDUSTRIAL CORP.)

台南市永康區中正北路837號 (NO. 837, ZHONGZHENG N. RD., YONGKANG DIST., TAINAN CITY 710002, TAIWAN)

以下測試樣品係由申請廠商所提供及確認 (The following sample(s) was/were submitted and identified by the applicant as) :

送樣廠商(Sample Submitted By) : 統一實業股份有限公司 (TON YI INDUSTRIAL CORP.)
樣品名稱(Sample Name) : ELECTROLYTIC TIN PLATE (電鍍鍍錫鋼片(馬口鐵))
樣品型號(Style/Item No.) : 1410523003

=====
收件日(Sample Receiving Date) : 16-Feb-2024
測試期間(Testing Period) : 16-Feb-2024 to 23-Feb-2024

測試需求(Test Requested) : 依據客戶指定，參考RoHS 2011/65/EU Annex II及其修訂指令(EU) 2015/863測試鎘、鉛、汞、六價鉻、多溴聯苯、多溴聯苯醚, DBP, BBP, DEHP, DIBP。 (As specified by client, with reference to RoHS 2011/65/EU Annex II and amending Directive (EU) 2015/863 to determine Cadmium, Lead, Mercury, Cr(VI), PBBs, PBDEs, DBP, BBP, DEHP, DIBP contents in the submitted sample(s).)

測試結果(Test Results) : 請參閱下一頁 (Please refer to following pages.)

結論(Conclusion) : 根據客戶所選擇的部位測試，其鎘、鉛、汞、六價鉻、多溴聯苯、多溴聯苯醚, DBP, BBP, DEHP, DIBP的測試結果符合RoHS 2011/65/EU Annex II暨其修訂指令(EU) 2015/863之限值要求。 (Based on the performed tests on selected part of submitted sample(s), the test results of Cadmium, Lead, Mercury, Cr(VI), PBBs, PBDEs, DBP, BBP, DEHP, DIBP comply with the limits as set by RoHS Directive (EU) 2015/863 amending Annex II to Directive 2011/65/EU.)

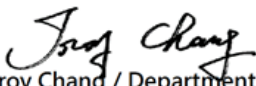
Troy Chang / Department Manager
Signed for and on behalf of
SGS TAIWAN LTD.
Chemical Laboratory - Taipei



PIN CODE: B58BADF5

This document is issued by the Company subject to its General Conditions of Service printed overleaf, available on request or accessible at <https://www.sgs.com.tw/terms-of-service> and, for electronic format documents, subject to Terms and Conditions for Electronic Documents at <https://www.sgs.com.tw/terms-of-service>. Attention is drawn to the limitation of liability, indemnification and jurisdiction issues defined therein. Any holder of this document is advised that information contained hereon reflects the Company's findings at the time of its intervention only and within the limits of client's instruction, if any. The Company's sole responsibility is to its Client and this document does not exonerate parties to a transaction from exercising all their rights and obligations under the transaction documents. This document cannot be reproduced, except in full, without prior written approval of the Company. Any unauthorized alteration, forgery or falsification of the content or appearance of this document is unlawful and offenders may be prosecuted to the fullest extent of the law. Unless otherwise stated the results shown in this test report refer only to the sample(s) tested.

測試報告

Test Report

號碼(No.): ETR24201868M01

日期(Date): 23-Feb-2024

頁數(Page): 2 of 8

統一實業股份有限公司 (TON YI INDUSTRIAL CORP.)

台南市永康區中正北路837號 (NO. 837, ZHONGZHENG N. RD., YONGKANG DIST., TAINAN CITY 710002, TAIWAN)

測試部位敘述 (Test Part Description)

No.1 : 銀色金屬鍍層 (PLATING LAYER OF SILVER COLORED METAL)

No.2 : 銀色金屬 (含鍍層) (SILVER COLORED METAL (INCLUDING THE PLATING LAYER))

測試結果 (Test Results)

測試項目 (Test Items)	測試方法 (Method)	單位 (Unit)	MDL	結果 (Result)		限值 (Limit)
				No.1	No.2	
鎘 (Cd) (Cadmium (Cd))	酸洗脫鍍層 · 參考IEC 62321-5: 2013 · 以感應耦合電漿發射光譜儀分析。(IEC 62321-5: 2013	mg/kg	2	n.d.	---	100
鉛 (Pb) (Lead (Pb))	application of modified digestion by surface etching, analysis was performed by ICP-OES.)	mg/kg	2	16.5	---	1000
汞 (Hg) (Mercury (Hg))	酸洗脫鍍層 · 參考IEC 62321-4: 2013+ AMD1: 2017 · 以感應耦合電漿發射光譜儀分析。(IEC 62321-4: 2013+AMD1: 2017 application of modified digestion by surface etching, analysis was performed by ICP-OES.)	mg/kg	2	n.d.	---	1000
六價鉻 (Hexavalent Chromium) Cr(VI) (#2)	參考IEC 62321-7-1: 2015 · 以紫外光-可見光分光光度計分析。(With reference to IEC 62321-7-1: 2015, analysis was performed by UV-VIS.)	µg/cm ²	0.1	n.d.	---	-
一溴聯苯 (Monobromobiphenyl)	參考IEC 62321-6: 2015 · 以氣相層析儀/質譜儀分析。(With reference to IEC 62321-6: 2015, analysis was performed by GC/MS.)	mg/kg	5	---	n.d.	-
二溴聯苯 (Dibromobiphenyl)		mg/kg	5	---	n.d.	-
三溴聯苯 (Tribromobiphenyl)		mg/kg	5	---	n.d.	-
四溴聯苯 (Tetrabromobiphenyl)		mg/kg	5	---	n.d.	-
五溴聯苯 (Pentabromobiphenyl)		mg/kg	5	---	n.d.	-
六溴聯苯 (Hexabromobiphenyl)		mg/kg	5	---	n.d.	-
七溴聯苯 (Heptabromobiphenyl)		mg/kg	5	---	n.d.	-
八溴聯苯 (Octabromobiphenyl)		mg/kg	5	---	n.d.	-
九溴聯苯 (Nonabromobiphenyl)		mg/kg	5	---	n.d.	-
十溴聯苯 (Decabromobiphenyl)		mg/kg	5	---	n.d.	-
多溴聯苯總和 (Sum of PBBs)		mg/kg	-	---	n.d.	1000

This document is issued by the Company subject to its General Conditions of Service printed overleaf, available on request or accessible at <https://www.sgs.com.tw/terms-of-service> and, for electronic format documents, subject to Terms and Conditions for Electronic Documents at <https://www.sgs.com.tw/terms-of-service>. Attention is drawn to the limitation of liability, indemnification and jurisdiction issues defined therein. Any holder of this document is advised that information contained hereon reflects the Company's findings at the time of its intervention only and within the limits of client's instruction, if any. The Company's sole responsibility is to its Client and this document does not exonerate parties to a transaction from exercising all their rights and obligations under the transaction documents. This document cannot be reproduced, except in full, without prior written approval of the Company. Any unauthorized alteration, forgery or falsification of the content or appearance of this document is unlawful and offenders may be prosecuted to the fullest extent of the law. Unless otherwise stated the results shown in this test report refer only to the sample(s) tested.

測試報告

Test Report

號碼(No.): ETR24201868M01

日期(Date): 23-Feb-2024

頁數(Page): 3 of 8

統一實業股份有限公司 (TON YI INDUSTRIAL CORP.)

台南市永康區中正北路837號 (NO. 837, ZHONGZHENG N. RD., YONGKANG DIST., TAINAN CITY 710002, TAIWAN)

測試項目 (Test Items)	測試方法 (Method)	單位 (Unit)	MDL	結果 (Result)		限值 (Limit)
				No.1	No.2	
一溴聯苯醚 (Monobromodiphenyl ether)	參考IEC 62321-6: 2015，以氣相層析儀/質譜儀分析。(With reference to IEC 62321-6: 2015, analysis was performed by GC/MS.)	mg/kg	5	---	n.d.	-
二溴聯苯醚 (Dibromodiphenyl ether)		mg/kg	5	---	n.d.	-
三溴聯苯醚 (Tribromodiphenyl ether)		mg/kg	5	---	n.d.	-
四溴聯苯醚 (Tetrabromodiphenyl ether)		mg/kg	5	---	n.d.	-
五溴聯苯醚 (Pentabromodiphenyl ether)		mg/kg	5	---	n.d.	-
六溴聯苯醚 (Hexabromodiphenyl ether)		mg/kg	5	---	n.d.	-
七溴聯苯醚 (Heptabromodiphenyl ether)		mg/kg	5	---	n.d.	-
八溴聯苯醚 (Octabromodiphenyl ether)		mg/kg	5	---	n.d.	-
九溴聯苯醚 (Nonabromodiphenyl ether)		mg/kg	5	---	n.d.	-
十溴聯苯醚 (Decabromodiphenyl ether)		mg/kg	5	---	n.d.	-
多溴聯苯醚總和 (Sum of PBDEs)		mg/kg	-	---	n.d.	1000
鄰苯二甲酸丁苯甲酯 (BBP) (Butyl benzyl phthalate (BBP))	參考IEC 62321-8: 2017，以氣相層析儀/質譜儀分析。(With reference to IEC 62321-8: 2017, analysis was performed by GC/MS.)	mg/kg	50	---	n.d.	1000
鄰苯二甲酸二丁酯 (DBP) (Dibutyl phthalate (DBP))		mg/kg	50	---	n.d.	1000
鄰苯二甲酸二(2-乙基己基)酯 (DEHP) (Di-(2-ethylhexyl) phthalate (DEHP))		mg/kg	50	---	n.d.	1000
鄰苯二甲酸二異丁酯 (DIBP) (Diisobutyl phthalate (DIBP))		mg/kg	50	---	n.d.	1000

This document is issued by the Company subject to its General Conditions of Service printed overleaf, available on request or accessible at <https://www.sgs.com.tw/terms-of-service> and, for electronic format documents, subject to Terms and Conditions for Electronic Documents at <https://www.sgs.com.tw/terms-of-service>. Attention is drawn to the limitation of liability, indemnification and jurisdiction issues defined therein. Any holder of this document is advised that information contained hereon reflects the Company's findings at the time of its intervention only and within the limits of client's instruction, if any. The Company's sole responsibility is to its Client and this document does not exonerate parties to a transaction from exercising all their rights and obligations under the transaction documents. This document cannot be reproduced, except in full, without prior written approval of the Company. Any unauthorized alteration, forgery or falsification of the content or appearance of this document is unlawful and offenders may be prosecuted to the fullest extent of the law. Unless otherwise stated the results shown in this test report refer only to the sample(s) tested.

測試報告

Test Report

號碼(No.): ETR24201868M01

日期(Date): 23-Feb-2024

頁數(Page): 4 of 8

統一實業股份有限公司 (TON YI INDUSTRIAL CORP.)

台南市永康區中正北路837號 (NO. 837, ZHONGZHENG N. RD., YONGKANG DIST., TAINAN CITY 710002, TAIWAN)

備註(Note) :

1. mg/kg = ppm ; 0.1wt% = 0.1% = 1000ppm
2. MDL = Method Detection Limit (方法偵測極限值)
3. n.d. = Not Detected (未檢出) ; 小於MDL / Less than MDL
4. "-" = Not Regulated (無規格值)
5. "---" = Not Conducted (未測試項目)
6. (#2) =
 - a. 當六價鉻結果大於 $0.13 \mu\text{g}/\text{cm}^2$ · 表示樣品表層含有六價鉻。(The sample is positive for Cr(VI) if the Cr(VI) concentration is greater than $0.13 \mu\text{g}/\text{cm}^2$. The sample coating is considered to contain Cr(VI).)
 - b. 當六價鉻結果為n.d. (濃度小於 $0.10 \mu\text{g}/\text{cm}^2$) · 表示表層不含六價鉻。(The sample is negative for Cr(VI) if Cr(VI) is n.d. (concentration less than $0.10 \mu\text{g}/\text{cm}^2$). The coating is considered a non-Cr(VI) based coating)
 - c. 當六價鉻結果介於 0.10 及 $0.13 \mu\text{g}/\text{cm}^2$ 時 · 無法確定塗層是否含有六價鉻。(The result between $0.10 \mu\text{g}/\text{cm}^2$ and $0.13 \mu\text{g}/\text{cm}^2$ is considered to be inconclusive - unavoidable coating variations may influence the determination.)
7. 除非另有說明 · 參照ILAC-G8:09/2019 · 採用簡單二元(w=0)允收規則進行符合性判定 ; 根據此規則 · 符合性結果之判定係以測試結果與限值做比較。(Unless otherwise stated , the decision rule for conformity reporting is based on Binary Statement for Simple Acceptance Rule (w=0) stated in ILAC-G8:09/2019. According to this rule, the judgement of conformity is based on the comparing test results with limits.)
8. 本報告為 ETR24201868 之異動報告。(This is the additional test report of ETR24201868.)

This document is issued by the Company subject to its General Conditions of Service printed overleaf, available on request or accessible at <https://www.sgs.com.tw/terms-of-service> and, for electronic format documents, subject to Terms and Conditions for Electronic Documents at <https://www.sgs.com.tw/terms-of-service>. Attention is drawn to the limitation of liability, indemnification and jurisdiction issues defined therein. Any holder of this document is advised that information contained hereon reflects the Company's findings at the time of its intervention only and within the limits of client's instruction, if any. The Company's sole responsibility is to its Client and this document does not exonerate parties to a transaction from exercising all their rights and obligations under the transaction documents. This document cannot be reproduced, except in full, without prior written approval of the Company. Any unauthorized alteration, forgery or falsification of the content or appearance of this document is unlawful and offenders may be prosecuted to the fullest extent of the law. Unless otherwise stated the results shown in this test report refer only to the sample(s) tested.

測試報告

Test Report

號碼(No.): ETR24201868M01

日期(Date): 23-Feb-2024

頁數(Page): 5 of 8

統一實業股份有限公司 (TON YI INDUSTRIAL CORP.)

台南市永康區中正北路837號 (NO. 837, ZHONGZHENG N. RD., YONGKANG DIST., TAINAN CITY 710002, TAIWAN)

鍍層重金屬測試流程圖 / Flow chart of stripping method for metal analysis

根據以下的流程圖之條件，樣品之外部鍍層已完全溶解。(六價鉻測試方法除外) / The plating layer of samples were dissolved totally by pre-conditioning method according to below flow chart. (Cr⁶⁺ test method excluded)

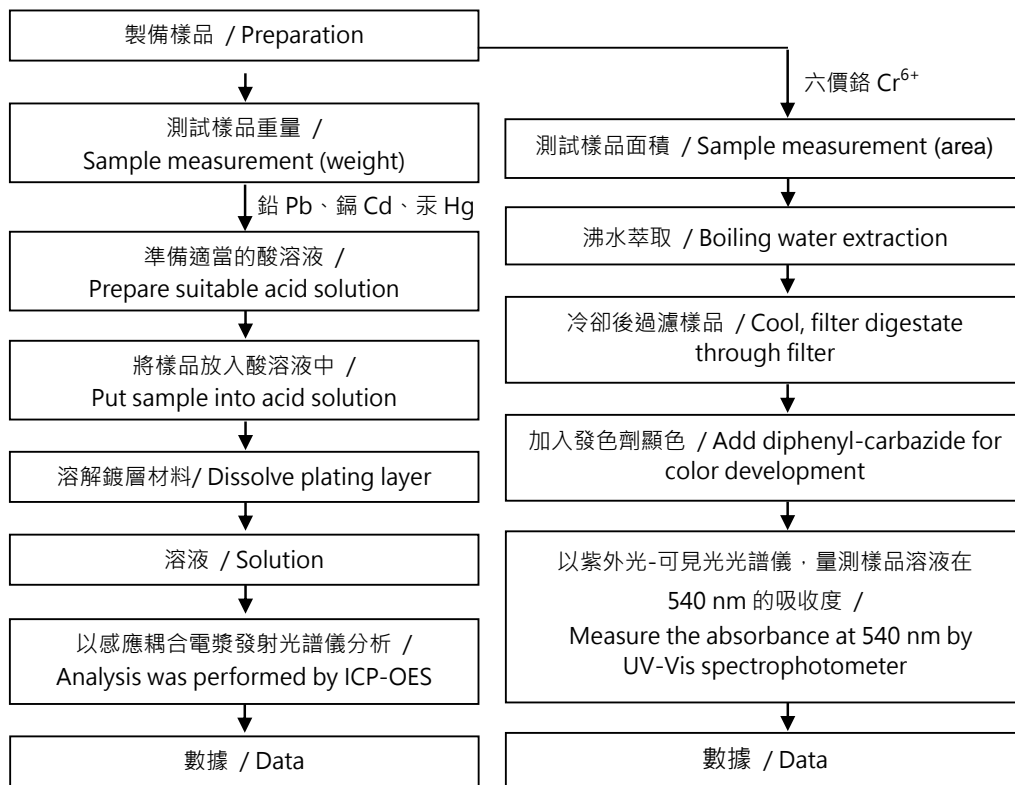

This document is issued by the Company subject to its General Conditions of Service printed overleaf, available on request or accessible at <https://www.sgs.com.tw/terms-of-service> and, for electronic format documents, subject to Terms and Conditions for Electronic Documents at <https://www.sgs.com.tw/terms-of-service>. Attention is drawn to the limitation of liability, indemnification and jurisdiction issues defined therein. Any holder of this document is advised that information contained hereon reflects the Company's findings at the time of its intervention only and within the limits of client's instruction, if any. The Company's sole responsibility is to its Client and this document does not exonerate parties to a transaction from exercising all their rights and obligations under the transaction documents. This document cannot be reproduced, except in full, without prior written approval of the Company. Any unauthorized alteration, forgery or falsification of the content or appearance of this document is unlawful and offenders may be prosecuted to the fullest extent of the law. Unless otherwise stated the results shown in this test report refer only to the sample(s) tested.

測試報告

Test Report

號碼(No.): ETR24201868M01

日期(Date): 23-Feb-2024

頁數(Page): 6 of 8

統一實業股份有限公司 (TON YI INDUSTRIAL CORP.)

台南市永康區中正北路837號 (NO. 837, ZHONGZHENG N. RD., YONGKANG DIST., TAINAN CITY 710002, TAIWAN)

多溴聯苯/多溴聯苯醚分析流程圖 / Analytical flow chart - PBBs/PBDEs

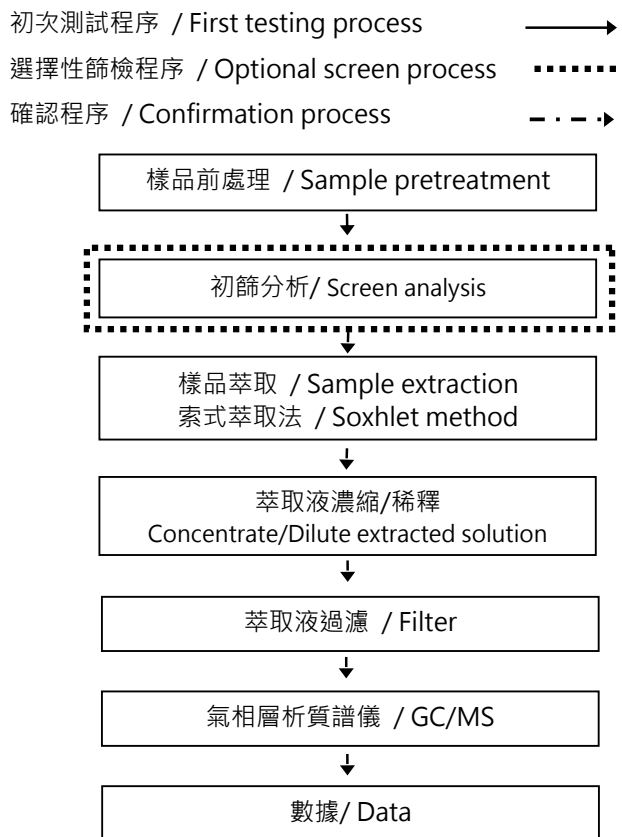

This document is issued by the Company subject to its General Conditions of Service printed overleaf, available on request or accessible at <https://www.sgs.com.tw/terms-of-service> and, for electronic format documents, subject to Terms and Conditions for Electronic Documents at <https://www.sgs.com.tw/terms-of-service>. Attention is drawn to the limitation of liability, indemnification and jurisdiction issues defined therein. Any holder of this document is advised that information contained hereon reflects the Company's findings at the time of its intervention only and within the limits of client's instruction, if any. The Company's sole responsibility is to its Client and this document does not exonerate parties to a transaction from exercising all their rights and obligations under the transaction documents. This document cannot be reproduced, except in full, without prior written approval of the Company. Any unauthorized alteration, forgery or falsification of the content or appearance of this document is unlawful and offenders may be prosecuted to the fullest extent of the law. Unless otherwise stated the results shown in this test report refer only to the sample(s) tested.

統一實業股份有限公司 (TON YI INDUSTRIAL CORP.)

台南市永康區中正北路837號 (NO. 837, ZHONGZHENG N. RD., YONGKANG DIST., TAINAN CITY 710002, TAIWAN)

可塑劑分析流程圖 / Analytical flow chart - Phthalate

【測試方法/Test method: IEC 62321-8】

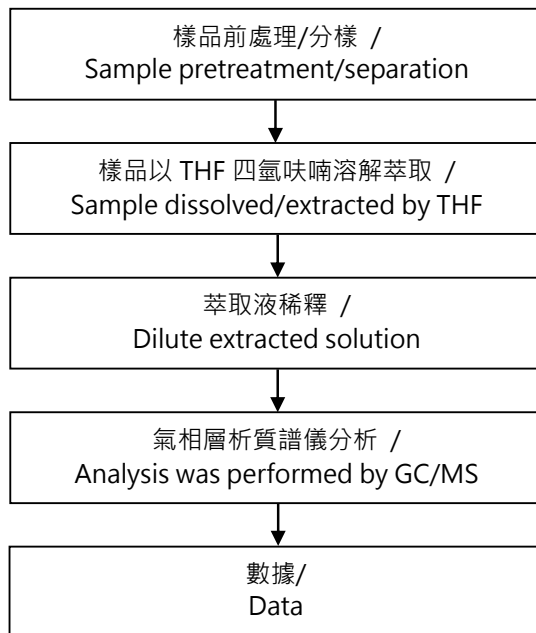

This document is issued by the Company subject to its General Conditions of Service printed overleaf, available on request or accessible at <https://www.sgs.com.tw/terms-of-service> and, for electronic format documents, subject to Terms and Conditions for Electronic Documents at <https://www.sgs.com.tw/terms-of-service>. Attention is drawn to the limitation of liability, indemnification and jurisdiction issues defined therein. Any holder of this document is advised that information contained hereon reflects the Company's findings at the time of its intervention only and within the limits of client's instruction, if any. The Company's sole responsibility is to its Client and this document does not exonerate parties to a transaction from exercising all their rights and obligations under the transaction documents. This document cannot be reproduced, except in full, without prior written approval of the Company. Any unauthorized alteration, forgery or falsification of the content or appearance of this document is unlawful and offenders may be prosecuted to the fullest extent of the law. Unless otherwise stated the results shown in this test report refer only to the sample(s) tested.

測試報告

Test Report

號碼(No.): ETR24201868M01

日期(Date): 23-Feb-2024

頁數(Page): 8 of 8

統一實業股份有限公司 (TON YI INDUSTRIAL CORP.)

台南市永康區中正北路837號 (NO. 837, ZHONGZHENG N. RD., YONGKANG DIST., TAINAN CITY 710002, TAIWAN)

* 照片中如有箭頭標示，則表示為實際檢測之樣品/部位。
(The tested sample / part is marked by an arrow if it's shown on the photo.)

ETR24201868 NO.1

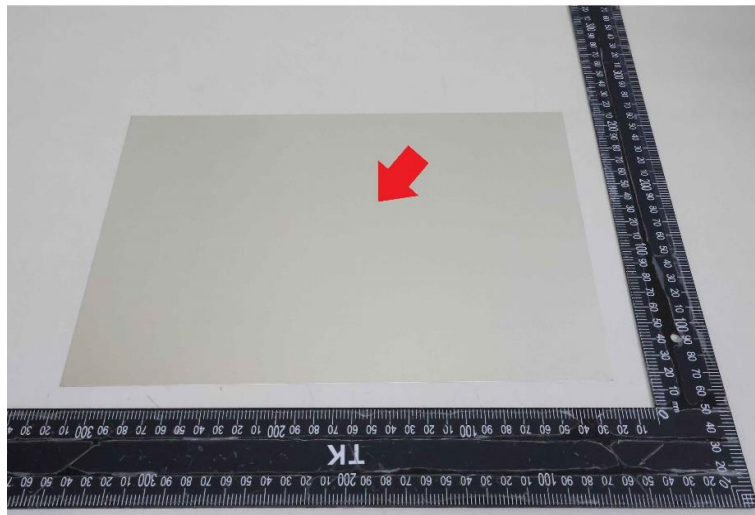

ETR24201868 NO.2



** 報告結尾 (End of Report) **

This document is issued by the Company subject to its General Conditions of Service printed overleaf, available on request or accessible at <https://www.sgs.com.tw/terms-of-service> and, for electronic format documents, subject to Terms and Conditions for Electronic Documents at <https://www.sgs.com.tw/terms-of-service>. Attention is drawn to the limitation of liability, indemnification and jurisdiction issues defined therein. Any holder of this document is advised that information contained hereon reflects the Company's findings at the time of its intervention only and within the limits of client's instruction, if any. The Company's sole responsibility is to its Client and this document does not exonerate parties to a transaction from exercising all their rights and obligations under the transaction documents. This document cannot be reproduced, except in full, without prior written approval of the Company. Any unauthorized alteration, forgery or falsification of the content or appearance of this document is unlawful and offenders may be prosecuted to the fullest extent of the law. Unless otherwise stated the results shown in this test report refer only to the sample(s) tested.



Test Report

No.: EKR24400496

Date: 17-Apr-2024

Page: 1 of 8

POLYPLASTICS TAIWAN CO., LTD.

NO. 13, JIANYE RD., DALIAO DIST., KAOHSIUNG CITY 831, TAIWAN (R.O.C.)

The following sample(s) was/were submitted and identified by the applicant as:

Sample Submitted By : POLYPLASTICS TAIWAN CO., LTD.
Sample Name : PBT
Style/Item No. : 310NF ED3002 / Lot No.3Z75300

=====
Sample Receiving Date : 10-Apr-2024
Testing Period : 10-Apr-2024 to 17-Apr-2024

Test Requested : (1) As specified by client, with reference to RoHS 2011/65/EU Annex II and amending Directive (EU) 2015/863 to determine Cadmium, Lead, Mercury, Cr(VI), PBBs, PBDEs, DBP, BBP, DEHP, DIBP contents in the submitted sample(s).
(2) As specified by client, to test Halogen-Fluorine, Chlorine, Bromine, Iodine in the submitted sample.

Test Results : Please refer to following pages.

Ray Chang, Ph.D./Department Manager
Signed for and on behalf of
SGS TAIWAN LTD.
Chemical Laboratory-Kaohsiung



This document is issued by the Company subject to its General Conditions of Service printed overleaf, available on request or accessible at <https://www.sgs.com.tw/terms-of-service> and, for electronic format documents, subject to Terms and Conditions for Electronic Documents at <https://www.sgs.com.tw/terms-of-service>. Attention is drawn to the limitation of liability, indemnification and jurisdiction issues defined therein. Any holder of this document is advised that information contained hereon reflects the Company's findings at the time of its intervention only and within the limits of client's instruction, if any. The Company's sole responsibility is to its Client and this document does not exonerate parties to a transaction from exercising all their rights and obligations under the transaction documents. This document cannot be reproduced, except in full, without prior written approval of the Company. Any unauthorized alteration, forgery or falsification of the content or appearance of this document is unlawful and offenders may be prosecuted to the fullest extent of the law. Unless otherwise stated the results shown in this test report refer only to the sample(s) tested.

Test Report

No.: EKR24400496

Date: 17-Apr-2024

Page: 2 of 8

POLYPLASTICS TAIWAN CO., LTD.

NO. 13, JIANYE RD., DALIAO DIST., KAOHSIUNG CITY 831, TAIWAN (R.O.C.)

Test Part Description

No.1 : ED3002 PBT

Test Result(s)

Test Item(s)	Method	Unit	MDL	Result
				No.1
Cadmium (Cd)	With reference to IEC 62321-5: 2013, analysis was performed by ICP-OES.	mg/kg	2	n.d.
Lead (Pb)	With reference to IEC 62321-5: 2013, analysis was performed by ICP-OES.	mg/kg	2	n.d.
Mercury (Hg)	With reference to IEC 62321-4: 2013+ AMD1: 2017, analysis was performed by ICP-OES.	mg/kg	2	n.d.
Hexavalent Chromium Cr(VI)	With reference to IEC 62321-7-2: 2017, analysis was performed by UV-VIS.	mg/kg	8	n.d.
Monobromobiphenyl	With reference to IEC 62321-6: 2015, analysis was performed by GC/MS.	mg/kg	5	n.d.
Dibromobiphenyl		mg/kg	5	n.d.
Tribromobiphenyl		mg/kg	5	n.d.
Tetrabromobiphenyl		mg/kg	5	n.d.
Pentabromobiphenyl		mg/kg	5	n.d.
Hexabromobiphenyl		mg/kg	5	n.d.
Heptabromobiphenyl		mg/kg	5	n.d.
Octabromobiphenyl		mg/kg	5	n.d.
Nonabromobiphenyl		mg/kg	5	n.d.
Decabromobiphenyl		mg/kg	5	n.d.
Sum of PBBs		mg/kg	-	n.d.
Monobromodiphenyl ether		mg/kg	5	n.d.
Dibromodiphenyl ether		mg/kg	5	n.d.
Tribromodiphenyl ether		mg/kg	5	n.d.
Tetrabromodiphenyl ether		mg/kg	5	n.d.
Pentabromodiphenyl ether		mg/kg	5	n.d.
Hexabromodiphenyl ether		mg/kg	5	n.d.
Heptabromodiphenyl ether		mg/kg	5	n.d.
Octabromodiphenyl ether		mg/kg	5	n.d.
Nonabromodiphenyl ether		mg/kg	5	n.d.
Decabromodiphenyl ether	mg/kg	5	n.d.	
Sum of PBDEs	mg/kg	-	n.d.	

This document is issued by the Company subject to its General Conditions of Service printed overleaf, available on request or accessible at <https://www.sgs.com.tw/terms-of-service> and, for electronic format documents, subject to Terms and Conditions for Electronic Documents at <https://www.sgs.com.tw/terms-of-service>. Attention is drawn to the limitation of liability, indemnification and jurisdiction issues defined therein. Any holder of this document is advised that information contained hereon reflects the Company's findings at the time of its intervention only and within the limits of client's instruction, if any. The Company's sole responsibility is to its Client and this document does not exonerate parties to a transaction from exercising all their rights and obligations under the transaction documents. This document cannot be reproduced, except in full, without prior written approval of the Company. Any unauthorized alteration, forgery or falsification of the content or appearance of this document is unlawful and offenders may be prosecuted to the fullest extent of the law. Unless otherwise stated the results shown in this test report refer only to the sample(s) tested.

Test Report

No.: EKR24400496

Date: 17-Apr-2024

Page: 3 of 8

POLYPLASTICS TAIWAN CO., LTD.

NO. 13, JIANYE RD., DALIAO DIST., KAOHSIUNG CITY 831, TAIWAN (R.O.C.)

Test Item(s)	Method	Unit	MDL	Result
				No.1
Butyl benzyl phthalate (BBP)	With reference to IEC 62321-8: 2017, analysis was performed by GC/MS.	mg/kg	50	n.d.
Dibutyl phthalate (DBP)		mg/kg	50	n.d.
Diisobutyl phthalate (DIBP)		mg/kg	50	n.d.
Di-(2-ethylhexyl) phthalate (DEHP)		mg/kg	50	n.d.
Fluorine (F) (CAS No.: 14762-94-8)	With reference to BS EN 14582: 2016, analysis was performed by IC.	mg/kg	50	918
Chlorine (Cl) (CAS No.: 22537-15-1)		mg/kg	50	n.d.
Bromine (Br) (CAS No.: 10097-32-2)		mg/kg	50	n.d.
Iodine (I) (CAS No.: 14362-44-8)		mg/kg	50	n.d.

Note :

1. mg/kg = ppm ; 0.1wt% = 0.1% = 1000ppm
2. MDL = Method Detection Limit
3. n.d. = Not Detected (Less than MDL)
4. "-" = Not Regulated

This document is issued by the Company subject to its General Conditions of Service printed overleaf, available on request or accessible at <https://www.sgs.com.tw/terms-of-service> and, for electronic format documents, subject to Terms and Conditions for Electronic Documents at <https://www.sgs.com.tw/terms-of-service>. Attention is drawn to the limitation of liability, indemnification and jurisdiction issues defined therein. Any holder of this document is advised that information contained hereon reflects the Company's findings at the time of its intervention only and within the limits of client's instruction, if any. The Company's sole responsibility is to its Client and this document does not exonerate parties to a transaction from exercising all their rights and obligations under the transaction documents. This document cannot be reproduced, except in full, without prior written approval of the Company. Any unauthorized alteration, forgery or falsification of the content or appearance of this document is unlawful and offenders may be prosecuted to the fullest extent of the law. Unless otherwise stated the results shown in this test report refer only to the sample(s) tested.

Analytical flow chart of Heavy Metal

These samples were dissolved totally by pre-conditioning method according to below flow chart.
(Cr⁶⁺ test method excluded)

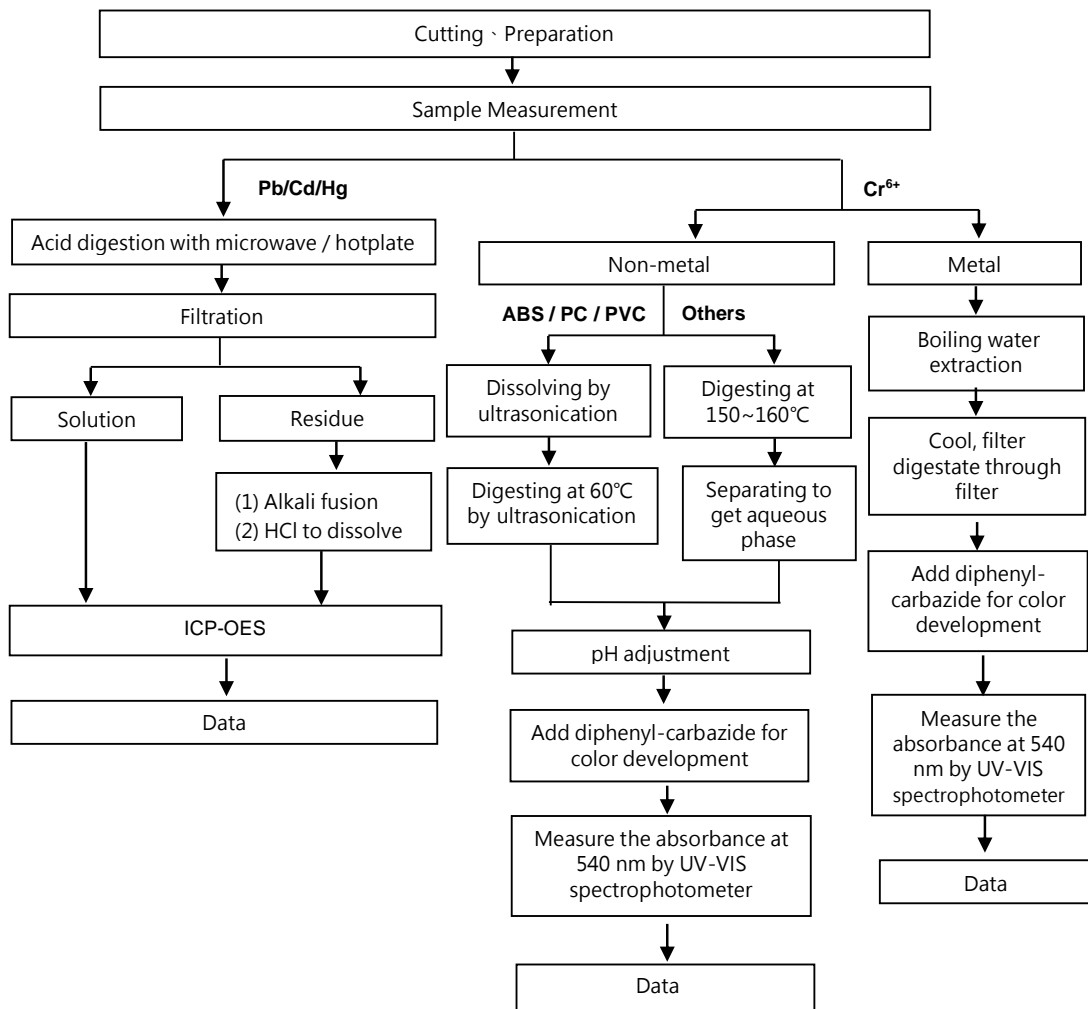

This document is issued by the Company subject to its General Conditions of Service printed overleaf, available on request or accessible at <https://www.sgs.com.tw/terms-of-service> and, for electronic format documents, subject to Terms and Conditions for Electronic Documents at <https://www.sgs.com.tw/terms-of-service>. Attention is drawn to the limitation of liability, indemnification and jurisdiction issues defined therein. Any holder of this document is advised that information contained hereon reflects the Company's findings at the time of its intervention only and within the limits of client's instruction, if any. The Company's sole responsibility is to its Client and this document does not exonerate parties to a transaction from exercising all their rights and obligations under the transaction documents. This document cannot be reproduced, except in full, without prior written approval of the Company. Any unauthorized alteration, forgery or falsification of the content or appearance of this document is unlawful and offenders may be prosecuted to the fullest extent of the law. Unless otherwise stated the results shown in this test report refer only to the sample(s) tested.

POLYPLASTICS TAIWAN CO., LTD.

NO. 13, JIANYE RD., DALIAO DIST., KAOHSIUNG CITY 831, TAIWAN (R.O.C.)

PBB/PBDE analytical FLOW CHART

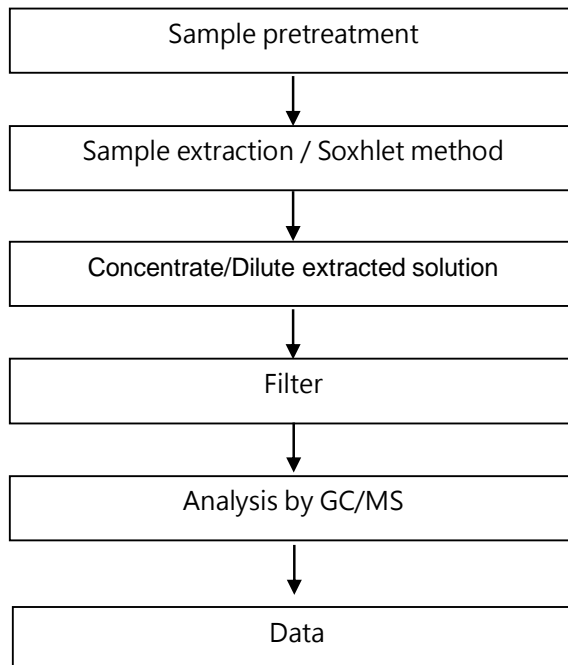

This document is issued by the Company subject to its General Conditions of Service printed overleaf, available on request or accessible at <https://www.sgs.com.tw/terms-of-service> and, for electronic format documents, subject to Terms and Conditions for Electronic Documents at <https://www.sgs.com.tw/terms-of-service>. Attention is drawn to the limitation of liability, indemnification and jurisdiction issues defined therein. Any holder of this document is advised that information contained hereon reflects the Company's findings at the time of its intervention only and within the limits of client's instruction, if any. The Company's sole responsibility is to its Client and this document does not exonerate parties to a transaction from exercising all their rights and obligations under the transaction documents. This document cannot be reproduced, except in full, without prior written approval of the Company. Any unauthorized alteration, forgery or falsification of the content or appearance of this document is unlawful and offenders may be prosecuted to the fullest extent of the law. Unless otherwise stated the results shown in this test report refer only to the sample(s) tested.

POLYPLASTICS TAIWAN CO., LTD.

NO. 13, JIANYE RD., DALIAO DIST., KAOHSIUNG CITY 831, TAIWAN (R.O.C.)

Analytical flow chart of phthalate content

【Test method: IEC 62321-8】

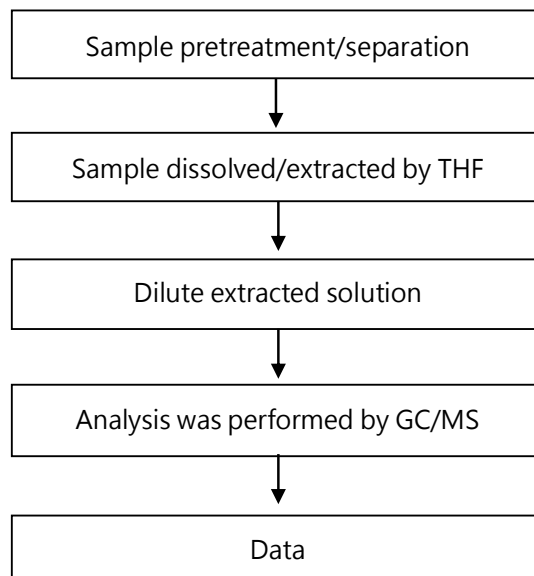

This document is issued by the Company subject to its General Conditions of Service printed overleaf, available on request or accessible at <https://www.sgs.com.tw/terms-of-service> and, for electronic format documents, subject to Terms and Conditions for Electronic Documents at <https://www.sgs.com.tw/terms-of-service>. Attention is drawn to the limitation of liability, indemnification and jurisdiction issues defined therein. Any holder of this document is advised that information contained hereon reflects the Company's findings at the time of its intervention only and within the limits of client's instruction, if any. The Company's sole responsibility is to its Client and this document does not exonerate parties to a transaction from exercising all their rights and obligations under the transaction documents. This document cannot be reproduced, except in full, without prior written approval of the Company. Any unauthorized alteration, forgery or falsification of the content or appearance of this document is unlawful and offenders may be prosecuted to the fullest extent of the law. Unless otherwise stated the results shown in this test report refer only to the sample(s) tested.

POLYPLASTICS TAIWAN CO., LTD.

NO. 13, JIANYE RD., DALIAO DIST., KAOHSIUNG CITY 831, TAIWAN (R.O.C.)

Analytical flow chart of Halogen

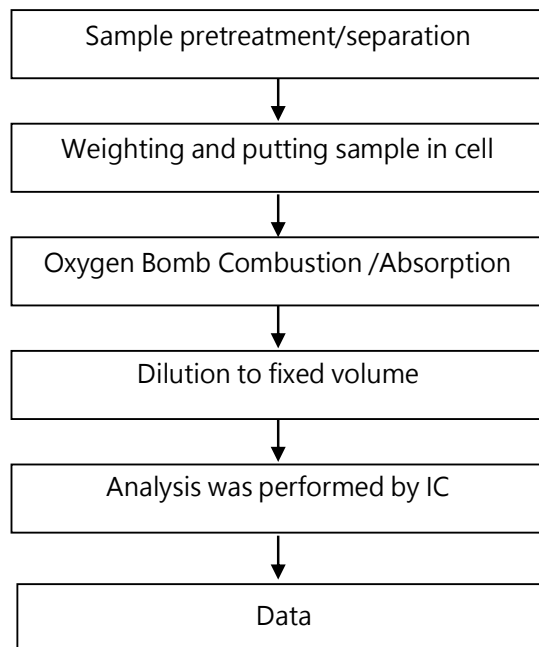

This document is issued by the Company subject to its General Conditions of Service printed overleaf, available on request or accessible at <https://www.sgs.com.tw/terms-of-service> and, for electronic format documents, subject to Terms and Conditions for Electronic Documents at <https://www.sgs.com.tw/terms-of-service>. Attention is drawn to the limitation of liability, indemnification and jurisdiction issues defined therein. Any holder of this document is advised that information contained hereon reflects the Company's findings at the time of its intervention only and within the limits of client's instruction, if any. The Company's sole responsibility is to its Client and this document does not exonerate parties to a transaction from exercising all their rights and obligations under the transaction documents. This document cannot be reproduced, except in full, without prior written approval of the Company. Any unauthorized alteration, forgery or falsification of the content or appearance of this document is unlawful and offenders may be prosecuted to the fullest extent of the law. Unless otherwise stated the results shown in this test report refer only to the sample(s) tested.

Test Report

No.: EKR24400496

Date: 17-Apr-2024

Page: 8 of 8

POLYPLASTICS TAIWAN CO., LTD.

NO. 13, JIANYE RD., DALIAO DIST., KAOHSIUNG CITY 831, TAIWAN (R.O.C.)

* The tested sample / part is marked by an arrow if it's shown on the photo. *

EKR24400496



** End of Report **

This document is issued by the Company subject to its General Conditions of Service printed overleaf, available on request or accessible at <https://www.sgs.com.tw/terms-of-service> and, for electronic format documents, subject to Terms and Conditions for Electronic Documents at <https://www.sgs.com.tw/terms-of-service>. Attention is drawn to the limitation of liability, indemnification and jurisdiction issues defined therein. Any holder of this document is advised that information contained hereon reflects the Company's findings at the time of its intervention only and within the limits of client's instruction, if any. The Company's sole responsibility is to its Client and this document does not exonerate parties to a transaction from exercising all their rights and obligations under the transaction documents. This document cannot be reproduced, except in full, without prior written approval of the Company. Any unauthorized alteration, forgery or falsification of the content or appearance of this document is unlawful and offenders may be prosecuted to the fullest extent of the law. Unless otherwise stated the results shown in this test report refer only to the sample(s) tested.



Test Report

No.: ETR24802273M01

Date: 30-Aug-2024

Page: 1 of 4

JX ADVANCED METALS CORPORATION
3 KURAMI, SAMUKAWA, KOZA, KANAGAWA 253-0101, JAPAN

The following sample(s) was/were submitted and identified by the applicant as:

Sample Submitted By : JX ADVANCED METALS CORPORATION
Sample Name : COPPER ALLOY
Style/Item No. : C5210

=====
Sample Receiving Date : 14-Aug-2024
Testing Period : 14-Aug-2024 to 30-Aug-2024

Test Requested : As specified by client, with reference to RoHS Directive 2011/65/EU Annex II to determine Cadmium, Lead, Mercury, Cr(VI) contents in the submitted sample(s).

Test Results : Please refer to following pages.

Troy Chang / Department Manager
Signed for and on behalf of
SGS TAIWAN LTD.
Chemical Laboratory - Taipei



PIN CODE: 4D9B5442

This document is issued by the Company subject to its General Conditions of Service printed overleaf, available on request or accessible at <https://www.sgs.com.tw/terms-of-service> and, for electronic format documents, subject to Terms and Conditions for Electronic Documents at <https://www.sgs.com.tw/terms-of-service>. Attention is drawn to the limitation of liability, indemnification and jurisdiction issues defined therein. Any holder of this document is advised that information contained hereon reflects the Company's findings at the time of its intervention only and within the limits of client's instruction, if any. The Company's sole responsibility is to its Client and this document does not exonerate parties to a transaction from exercising all their rights and obligations under the transaction documents. This document cannot be reproduced, except in full, without prior written approval of the Company. Any unauthorized alteration, forgery or falsification of the content or appearance of this document is unlawful and offenders may be prosecuted to the fullest extent of the law. Unless otherwise stated the results shown in this test report refer only to the sample(s) tested.

Test Report

No.: ETR24802273M01

Date: 30-Aug-2024

Page: 2 of 4

JX ADVANCED METALS CORPORATION
3 KURAMI, SAMUKAWA, KOZA, KANAGAWA 253-0101, JAPAN

Test Part Description

No.1 : COPPER COLORED METAL

Test Result(s)

Test Item(s)	Method	Unit	MDL	Result
				No.1
Cadmium (Cd)	With reference to IEC 62321-5: 2013, analysis was performed by ICP-OES.	mg/kg	2	n.d.
Lead (Pb)	With reference to IEC 62321-5: 2013, analysis was performed by ICP-OES.	mg/kg	2	19.4
Mercury (Hg)	With reference to IEC 62321-4: 2013+ AMD1: 2017, analysis was performed by ICP-OES.	mg/kg	2	n.d.
Hexavalent Chromium Cr(VI) (#2)	With reference to IEC 62321-7-1: 2015, analysis was performed by UV-VIS.	µg/cm ²	0.1	n.d.

Note :

1. mg/kg = ppm ; 0.1wt% = 0.1% = 1000ppm
2. MDL = Method Detection Limit
3. n.d. = Not Detected (Less than MDL)
4. (#2) =
 - a. The sample is positive for Cr(VI) if the Cr(VI) concentration is greater than 0.13 µg/cm². The sample coating is considered to contain Cr(VI).
 - b. The sample is negative for Cr(VI) if Cr(VI) is n.d. (concentration less than 0.10 µg/cm²). The coating is considered a non-Cr(VI) based coating
 - c. The result between 0.10 µg/cm² and 0.13 µg/cm² is considered to be inconclusive - unavoidable coating variations may influence the determination.
5. This is the additional test report of ETR24802273.

This document is issued by the Company subject to its General Conditions of Service printed overleaf, available on request or accessible at <https://www.sgs.com.tw/terms-of-service> and, for electronic format documents, subject to Terms and Conditions for Electronic Documents at <https://www.sgs.com.tw/terms-of-service>. Attention is drawn to the limitation of liability, indemnification and jurisdiction issues defined therein. Any holder of this document is advised that information contained hereon reflects the Company's findings at the time of its intervention only and within the limits of client's instruction, if any. The Company's sole responsibility is to its Client and this document does not exonerate parties to a transaction from exercising all their rights and obligations under the transaction documents. This document cannot be reproduced, except in full, without prior written approval of the Company. Any unauthorized alteration, forgery or falsification of the content or appearance of this document is unlawful and offenders may be prosecuted to the fullest extent of the law. Unless otherwise stated the results shown in this test report refer only to the sample(s) tested.

JX ADVANCED METALS CORPORATION
 3 KURAMI, SAMUKAWA, KOZA, KANAGAWA 253-0101, JAPAN

Analytical flow chart of heavy metal

These samples were dissolved totally by pre-conditioning method according to below flow chart.

(Cr⁶⁺ test method excluded)

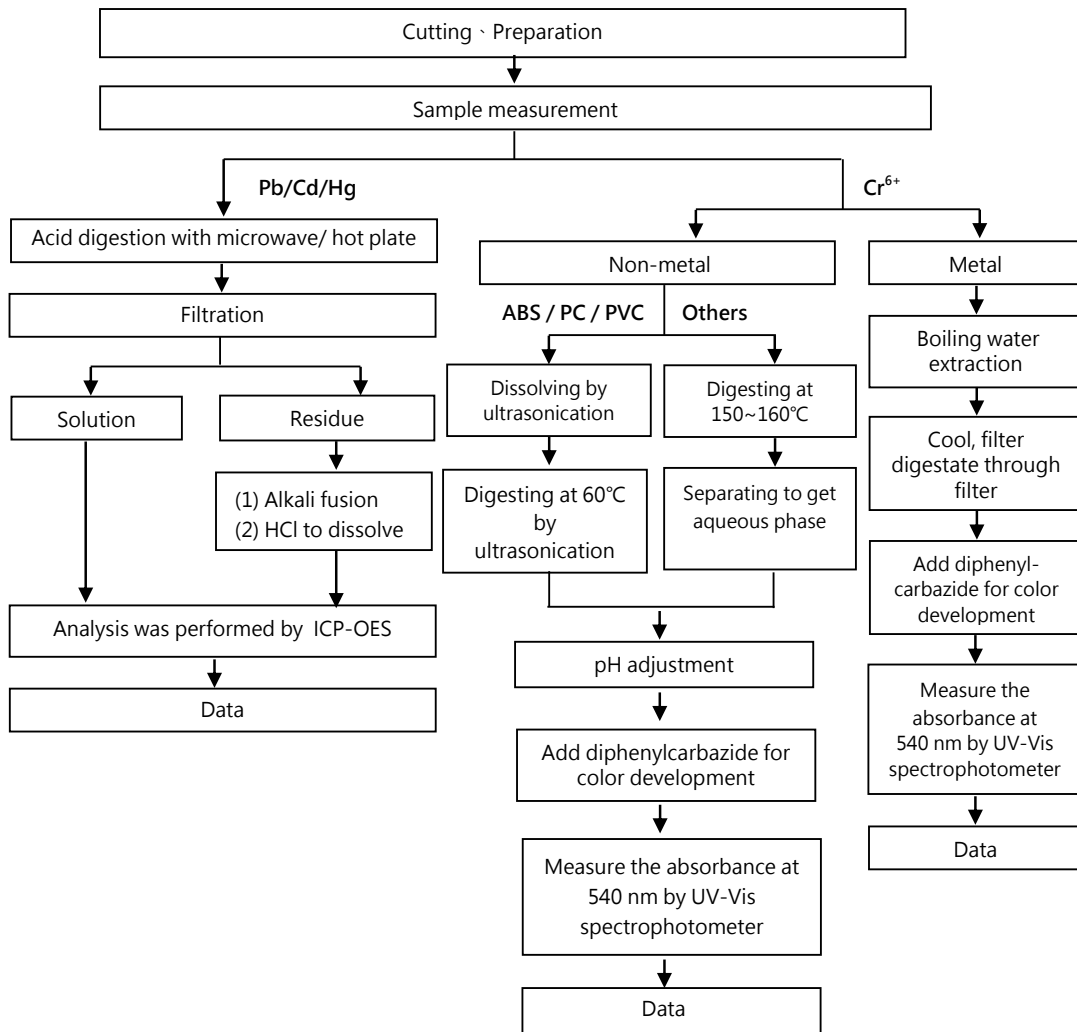

This document is issued by the Company subject to its General Conditions of Service printed overleaf, available on request or accessible at <https://www.sgs.com.tw/terms-of-service> and, for electronic format documents, subject to Terms and Conditions for Electronic Documents at <https://www.sgs.com.tw/terms-of-service>. Attention is drawn to the limitation of liability, indemnification and jurisdiction issues defined therein. Any holder of this document is advised that information contained hereon reflects the Company's findings at the time of its intervention only and within the limits of client's instruction, if any. The Company's sole responsibility is to its Client and this document does not exonerate parties to a transaction from exercising all their rights and obligations under the transaction documents. This document cannot be reproduced, except in full, without prior written approval of the Company. Any unauthorized alteration, forgery or falsification of the content or appearance of this document is unlawful and offenders may be prosecuted to the fullest extent of the law. Unless otherwise stated the results shown in this test report refer only to the sample(s) tested.

Test Report

No.: ETR24802273M01

Date: 30-Aug-2024

Page: 4 of 4

JX ADVANCED METALS CORPORATION

3 KURAMI, SAMUKAWA, KOZA, KANAGAWA 253-0101, JAPAN

* The tested sample / part is marked by an arrow if it's shown on the photo. *

ETR24802273

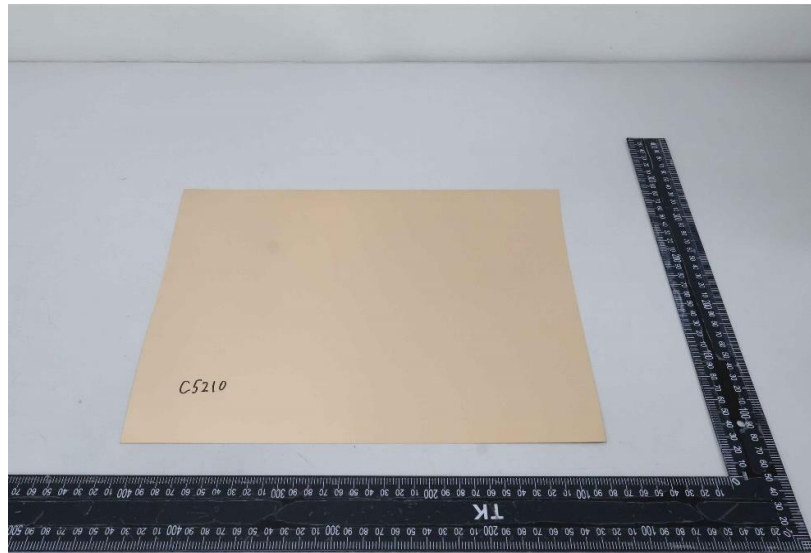

** End of Report **

This document is issued by the Company subject to its General Conditions of Service printed overleaf, available on request or accessible at <https://www.sgs.com.tw/terms-of-service> and, for electronic format documents, subject to Terms and Conditions for Electronic Documents at <https://www.sgs.com.tw/terms-of-service>. Attention is drawn to the limitation of liability, indemnification and jurisdiction issues defined therein. Any holder of this document is advised that information contained hereon reflects the Company's findings at the time of its intervention only and within the limits of client's instruction, if any. The Company's sole responsibility is to its Client and this document does not exonerate parties to a transaction from exercising all their rights and obligations under the transaction documents. This document cannot be reproduced, except in full, without prior written approval of the Company. Any unauthorized alteration, forgery or falsification of the content or appearance of this document is unlawful and offenders may be prosecuted to the fullest extent of the law. Unless otherwise stated the results shown in this test report refer only to the sample(s) tested.



Test Report

No.: ETR24802272M01

Date: 30-Aug-2024

Page: 1 of 4

JX ADVANCED METALS CORPORATION
3 KURAMI, SAMUKAWA, KOZA, KANAGAWA 253-0101, JAPAN

The following sample(s) was/were submitted and identified by the applicant as:

Sample Submitted By : JX ADVANCED METALS CORPORATION
Sample Name : COPPER ALLOY
Style/Item No. : C5191

=====
Sample Receiving Date : 14-Aug-2024
Testing Period : 14-Aug-2024 to 30-Aug-2024

Test Requested : As specified by client, with reference to RoHS 2011/65/EU Annex II and amending Directive (EU) 2015/863 to determine Cadmium, Lead, Mercury, Cr(VI), PBBs, PBDEs, DBP, BBP, DEHP, DIBP contents in the submitted

Test Results : Please refer to following pages.

Troy Chang / Department Manager
Signed for and on behalf of
SGS TAIWAN LTD.
Chemical Laboratory - Taipei



PIN CODE: 2C0034B4

This document is issued by the Company subject to its General Conditions of Service printed overleaf, available on request or accessible at <https://www.sgs.com.tw/terms-of-service> and, for electronic format documents, subject to Terms and Conditions for Electronic Documents at <https://www.sgs.com.tw/terms-of-service>. Attention is drawn to the limitation of liability, indemnification and jurisdiction issues defined therein. Any holder of this document is advised that information contained hereon reflects the Company's findings at the time of its intervention only and within the limits of client's instruction, if any. The Company's sole responsibility is to its Client and this document does not exonerate parties to a transaction from exercising all their rights and obligations under the transaction documents. This document cannot be reproduced, except in full, without prior written approval of the Company. Any unauthorized alteration, forgery or falsification of the content or appearance of this document is unlawful and offenders may be prosecuted to the fullest extent of the law. Unless otherwise stated the results shown in this test report refer only to the sample(s) tested.

Test Report

No.: ETR24802272M01

Date: 30-Aug-2024

Page: 2 of 4

JX ADVANCED METALS CORPORATION
3 KURAMI, SAMUKAWA, KOZA, KANAGAWA 253-0101, JAPAN

Test Part Description

No.1 : COPPER COLORED METAL

Test Result(s)

Test Item(s)	Method	Unit	MDL	Result
				No.1
Cadmium (Cd)	With reference to IEC 62321-5: 2013, analysis was performed by ICP-OES.	mg/kg	2	n.d.
Lead (Pb)	With reference to IEC 62321-5: 2013, analysis was performed by ICP-OES.	mg/kg	2	12.9
Mercury (Hg)	With reference to IEC 62321-4: 2013+ AMD1: 2017, analysis was performed by ICP-OES.	mg/kg	2	n.d.
Hexavalent Chromium Cr(VI) (#2)	With reference to IEC 62321-7-1: 2015, analysis was performed by UV-VIS.	µg/cm ²	0.1	n.d.

Note :

1. mg/kg = ppm ; 0.1wt% = 0.1% = 1000ppm
2. MDL = Method Detection Limit
3. n.d. = Not Detected (Less than MDL)
4. (#2) =
 - a. The sample is positive for Cr(VI) if the Cr(VI) concentration is greater than 0.13 µg/cm². The sample coating is considered to contain Cr(VI).
 - b. The sample is negative for Cr(VI) if Cr(VI) is n.d. (concentration less than 0.10 µg/cm²). The coating is considered a non-Cr(VI) based coating
 - c. The result between 0.10 µg/cm² and 0.13 µg/cm² is considered to be inconclusive - unavoidable coating variations may influence the determination.
5. This is the additional test report of ETR24802272.

This document is issued by the Company subject to its General Conditions of Service printed overleaf, available on request or accessible at <https://www.sgs.com.tw/terms-of-service> and, for electronic format documents, subject to Terms and Conditions for Electronic Documents at <https://www.sgs.com.tw/terms-of-service>. Attention is drawn to the limitation of liability, indemnification and jurisdiction issues defined therein. Any holder of this document is advised that information contained hereon reflects the Company's findings at the time of its intervention only and within the limits of client's instruction, if any. The Company's sole responsibility is to its Client and this document does not exonerate parties to a transaction from exercising all their rights and obligations under the transaction documents. This document cannot be reproduced, except in full, without prior written approval of the Company. Any unauthorized alteration, forgery or falsification of the content or appearance of this document is unlawful and offenders may be prosecuted to the fullest extent of the law. Unless otherwise stated the results shown in this test report refer only to the sample(s) tested.

JX ADVANCED METALS CORPORATION
 3 KURAMI, SAMUKAWA, KOZA, KANAGAWA 253-0101, JAPAN

Analytical flow chart of heavy metal

These samples were dissolved totally by pre-conditioning method according to below flow chart.

(Cr⁶⁺ test method excluded)

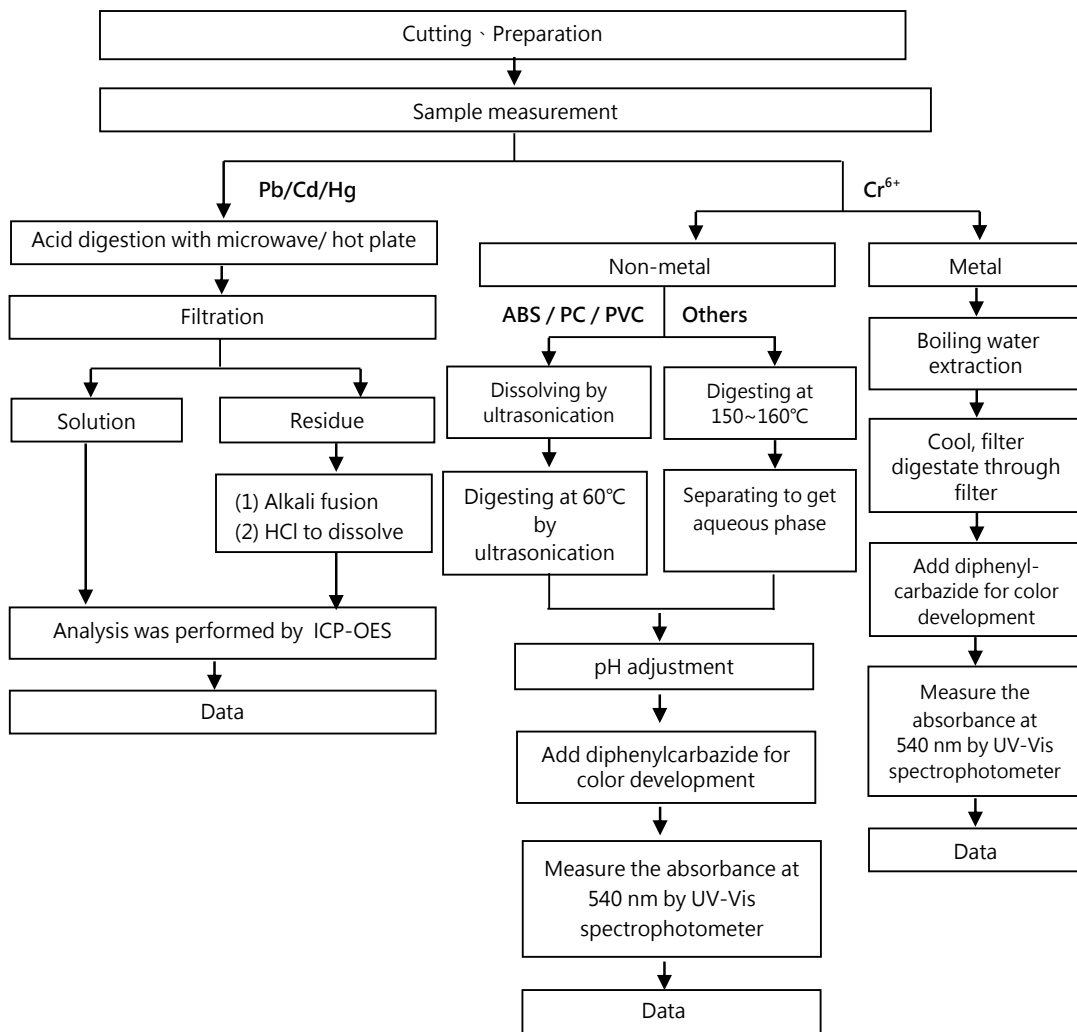

This document is issued by the Company subject to its General Conditions of Service printed overleaf, available on request or accessible at <https://www.sgs.com.tw/terms-of-service> and, for electronic format documents, subject to Terms and Conditions for Electronic Documents at <https://www.sgs.com.tw/terms-of-service>. Attention is drawn to the limitation of liability, indemnification and jurisdiction issues defined therein. Any holder of this document is advised that information contained hereon reflects the Company's findings at the time of its intervention only and within the limits of client's instruction, if any. The Company's sole responsibility is to its Client and this document does not exonerate parties to a transaction from exercising all their rights and obligations under the transaction documents. This document cannot be reproduced, except in full, without prior written approval of the Company. Any unauthorized alteration, forgery or falsification of the content or appearance of this document is unlawful and offenders may be prosecuted to the fullest extent of the law. Unless otherwise stated the results shown in this test report refer only to the sample(s) tested.

Test Report

No.: ETR24802272M01

Date: 30-Aug-2024

Page: 4 of 4

JX ADVANCED METALS CORPORATION

3 KURAMI, SAMUKAWA, KOZA, KANAGAWA 253-0101, JAPAN

* The tested sample / part is marked by an arrow if it's shown on the photo. *

ETR24802272

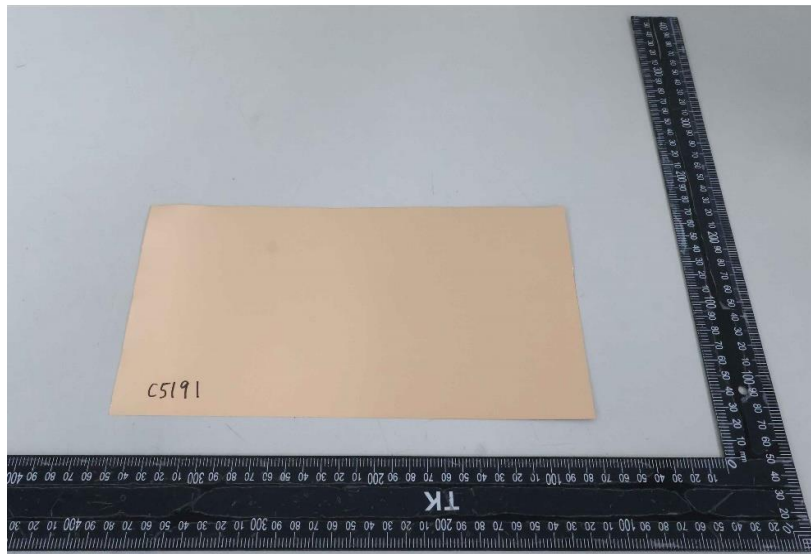

** End of Report **

This document is issued by the Company subject to its General Conditions of Service printed overleaf, available on request or accessible at <https://www.sgs.com.tw/terms-of-service> and, for electronic format documents, subject to Terms and Conditions for Electronic Documents at <https://www.sgs.com.tw/terms-of-service>. Attention is drawn to the limitation of liability, indemnification and jurisdiction issues defined therein. Any holder of this document is advised that information contained hereon reflects the Company's findings at the time of its intervention only and within the limits of client's instruction, if any. The Company's sole responsibility is to its Client and this document does not exonerate parties to a transaction from exercising all their rights and obligations under the transaction documents. This document cannot be reproduced, except in full, without prior written approval of the Company. Any unauthorized alteration, forgery or falsification of the content or appearance of this document is unlawful and offenders may be prosecuted to the fullest extent of the law. Unless otherwise stated the results shown in this test report refer only to the sample(s) tested.

Test Report 測試報告

Applicant: WONDERFUL HI-TECH CO., LTD.
申請廠商 萬泰科技股份有限公司
No.17, Beiyuan Rd., Zhongli Dist.,
Taoyuan City 320, Taiwan (R.O.C.)
桃園市中壢區工業區北園路 17 號

Number : TWNC01231369
報告號碼

Issue Date : Jan 12, 2024
報告發行日期

Sample Description 樣品敘述:

One (1) Group of Submitted Samples Said To Be :

以下測試樣品乃供應商所提供及確認:

Sample Submitted By : WONDERFUL HI-TECH CO., LTD.

送樣廠商 萬泰科技股份有限公司

Sample Description : RF COAXIAL CABLE

樣品名稱 RG-6U, RG-59, RG-11, RG-58A/U, RG-142/U, RG-178 B/U, RG-179/U, RG-316U, MINI
0.8mm, 0.98mm, 1.13mm, 1.27mm, 1.32mm, 1.37mm, 1.48mm, 1.13LL, 1.37LL,
RF405A, UL 1330, 1331, 1332, 1333, 1726, 1727, 1867, 1979, 10231, 10064, 10362

Style / Item No. : BLACK, BROWN, RED, ORANGE, YELLOW, GREEN, BLUE, PURPLE, GRAY, WHITE

產品型號

Date Sample Received : Dec 13, 2023

收件日期

Date Test Started : Dec 13, 2023

開始測試日期

Test Conducted 測試執行:

As requested by the applicant, for details please refer to attached pages.

依申請商之要求, 細節請參考附頁。

Conclusion 結論:

Please see page two.

請見第二頁。

Authorized By:
On behalf of Intertek Testing Services
Taiwan Limited

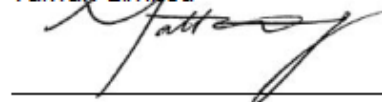

Matt Wang
General Manager



Signed by:

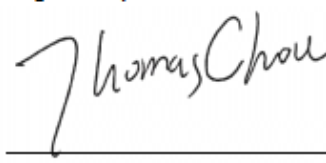

Thomas Chou
Manager



報告查詢 Report Verification



Test Report 測試報告

Number : TWNC01231369
報告號碼

Conclusion 結論:

Tested Sample 測試樣品
Test Components of
Submitted Samples
測試部位

Standard 標準

Restriction of Hazardous Substances (RoHS) 危害物質限制
— As per applicant's request with reference to 2011/65/EU
and amendment (EU) 2015/863
依據客戶要求參考歐盟指令 2011/65/EU 及其更新指令
(EU) 2015/863

Result 結果

Pass 合格

As per applicant's request 依據客戶要求

— Antimony (Sb) Content
銻含量

See Test Conducted
請見測試內容

— Phthalates Content
可塑劑含量

See Test Conducted
請見測試內容

— Halogen Content
鹵素含量

See Test Conducted
請見測試內容

— Perfluorooctane Sulfonates (PFOS) Content
全氟辛磺酸含量

See Test Conducted
請見測試內容

— Perfluorooctanoic Acid (PFOA) Content
全氟辛酸含量

See Test Conducted
請見測試內容

Tested Components 測試元件:

- (1) Black plastic pellets
- (2) Brown plastic pellets
- (3) Red plastic pellets
- (4) Orange plastic pellets
- (5) Yellow plastic pellets
- (6) Green plastic pellets
- (7) Blue plastic pellets
- (8) Purple plastic pellets
- (9) Grey plastic pellets
- (10) White plastic pellets

Authorized By:
On behalf of Intertek Testing Services
Taiwan Limited

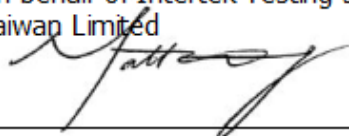

Matt Wang
General Manager



Signed by:

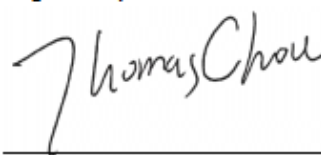

Thomas Chou
Manager



Test Conducted 測試內容 :

Test Result Summary 測試結果 :

Test Item 測試項目	Unit 單位	Test Method 測試方法	Result 結果			RL
			(1)	(2)	(3)	
Heavy Metal 重金屬						
Cadmium (Cd) Content 鎘含量	ppm	With reference to IEC 62321-5: 2013, by microwave or acid digestion and determined by ICP-OES. 參考 IEC 62321-5: 2013，以微波或酸液消化法消化樣品並用感應耦合電漿原子發射光譜儀分析。	ND	ND	ND	2
Lead (Pb) Content 鉛含量	ppm	With reference to IEC 62321-5: 2013, by microwave or acid digestion and determined by ICP-OES. 參考 IEC 62321-5: 2013，以微波或酸液消化法消化樣品並用感應耦合電漿原子發射光譜儀分析。	ND	ND	ND	2
Mercury (Hg) Content 汞含量	ppm	With reference to IEC 62321-4:2013+AMD1:2017, by microwave or acid digestion and determined by ICP-OES. 參考 IEC 62321-4:2013+AMD 1:2017，以微波或酸液消化法消化樣品並用感應耦合電漿原子發射光譜儀分析。	ND	ND	ND	2
Antimony (Sb) Content 銻含量	ppm	With reference to USEPA 3052, by microwave digestion and determined by ICP-OES. 參考 USEPA 3052，以微波消化法並用感應耦合電漿原子發射光譜儀分析。	ND	ND	ND	2
Chromium VI (Cr(VI)) Content 六價鉻含量	ppm	With reference to IEC 62321-7-2: 2017, organic solvent was used to dissolve or swell sample matrix, followed by alkaline digestion and determined by UV-Vis Spectrophotometer. 參考 IEC 62321-7-2:2017，以有機溶劑溶解或使樣品基質膨脹，再進行鹼液消化，用紫外光-可見光分光光度計分析。	ND	ND	ND	8



Test Conducted 測試內容 :

Test Item 測試項目	Unit 單位	Test Method 測試方法	Result 結果			RL
			(1)	(2)	(3)	
Polybrominated Biphenyls (PBBs) 多溴聯苯						
Monobrominated Biphenyls (MonoBB) 單溴聯苯	ppm	With reference to IEC 62321-6: 2015, by solvent extraction and determined by GC-MS and further HPLC-DAD confirmation when necessary. 參考 IEC 62321-6: 2015, 以溶劑萃取並用氣相層析質譜儀分析, 必要時會以高效液相層析儀光二極體陣列偵測儀進行確認。	ND	ND	ND	5
Dibrominated Biphenyls (DiBB) 二溴聯苯	ppm		ND	ND	ND	5
Tribrominated Biphenyls (TriBB) 三溴聯苯	ppm		ND	ND	ND	5
Tetrabrominated Biphenyls (TetraBB) 四溴聯苯	ppm		ND	ND	ND	5
Pentabrominated Biphenyls (PentaBB) 五溴聯苯	ppm		ND	ND	ND	5
Hexabrominated Biphenyls (HexaBB) 六溴聯苯	ppm		ND	ND	ND	5
Heptabrominated Biphenyls (HeptaBB) 七溴聯苯	ppm		ND	ND	ND	5
Octabrominated Biphenyls (OctaBB) 八溴聯苯	ppm		ND	ND	ND	5
Nonabrominated Biphenyls (NonaBB) 九溴聯苯	ppm		ND	ND	ND	5
Decabrominated Biphenyl (DecaBB) 十溴聯苯	ppm		ND	ND	ND	5
Polybrominated Diphenyl Ethers (PBDEs) 多溴聯苯醚						
Monobrominated Diphenyl Ethers (MonoBDE) 單溴聯苯醚	ppm	With reference to IEC 62321-6: 2015, by solvent extraction and determined by GC-MS and further HPLC-DAD confirmation when necessary. 參考 IEC 62321-6: 2015, 以溶劑萃取並用氣相層析質譜儀分析, 必要時會以高效液相層析儀光二極體陣列偵測儀進行確認。	ND	ND	ND	5
Dibrominated Diphenyl Ethers (DiBDE) 二溴聯苯醚	ppm		ND	ND	ND	5
Tribrominated Diphenyl Ethers (TriBDE) 三溴聯苯醚	ppm		ND	ND	ND	5
Tetrabrominated Diphenyl Ethers (TetraBDE) 四溴聯苯醚	ppm		ND	ND	ND	5
Pentabrominated Diphenyl Ethers (PentaBDE) 五溴聯苯醚	ppm		ND	ND	ND	5
Hexabrominated Diphenyl Ethers (HexaBDE) 六溴聯苯醚	ppm		ND	ND	ND	5
Heptabrominated Diphenyl Ethers (HeptaBDE) 七溴聯苯醚	ppm		ND	ND	ND	5
Octabrominated Diphenyl Ethers (OctaBDE) 八溴聯苯醚	ppm		ND	ND	ND	5
Nonabrominated Diphenyl Ethers (NonaBDE) 九溴聯苯醚	ppm		ND	ND	ND	5
Decabrominated Diphenyl Ether (DecaBDE) 十溴聯苯醚	ppm		ND	ND	ND	5



Test Conducted 測試內容 :

Test Item 測試項目	Unit 單位	Test Method 測試方法	Result 結果			RL
			(1)	(2)	(3)	
Phthalates 鄰苯二甲酸酯						
Di(2-ethylhexyl) Phthalate (DEHP) 鄰苯二甲酸二(2-乙基己基)酯	ppm	With reference to IEC 62321-8:2017, by solvent extraction and determined by GC-MS. 參考 IEC 62321-8:2017, 以溶劑萃取並用氣相層析質譜儀分析。	ND	ND	ND	50
Dibutyl Phthalate (DBP) 鄰苯二甲酸二丁酯	ppm		ND	ND	ND	50
Benzyl Butyl Phthalate (BBP) 鄰苯二甲酸苯基丁酯	ppm		ND	ND	ND	50
Di-(Iso-Nonyl) Phthalate (DINP) 鄰苯二甲酸二異壬酯	ppm		ND	ND	ND	50
Di-(Iso-Decyl) Phthalate (DIDP) 鄰苯二甲酸二異癸酯	ppm		ND	ND	ND	50
Di-(N-Octyl) Phthalate (DNOP) 鄰苯二甲酸二辛酯	ppm		ND	ND	ND	50
Di-n-hexyl Phthalate (DNHP) 鄰苯二甲酸二正己酯	ppm		ND	ND	ND	50
Diisobutyl Phthalate (DIBP) 鄰苯二甲酸二異丁酯	ppm		ND	ND	ND	50
Halogen Content 鹵素含量						
Fluorine (F) 氟	ppm	With reference to EN 14582:2016 by combustion bomb with oxygen and determined by Ion Chromatography. 參考 EN 14582:2016, 以氧彈燃燒集氣法並用離子層析儀分析。	541750	534748	520948	50
Chlorine (Cl) 氯	ppm		ND	ND	ND	50
Bromine (Br) 溴	ppm		ND	ND	ND	50
Iodine (I) 碘	ppm		ND	ND	ND	50
Others 其他						
Perfluorooctane Sulfonates Including PFOS, PFOSA, N-Me-FOSA, N-Et-FOSA, N-Me-FOSE, N-Et-FOSE 全氟辛磺酸含 PFOS, PFOSA, N-Me-FOSA, N-Et-FOSA, N-Me-FOSE, N-Et-FOSE	ppm	With reference to CEN/TS 15968:2010, by solvent extraction and determined by LC-MS-MS. 參考 CEN/TS 15968:2010, 以溶劑萃取並用液相層析串聯質譜儀分析。	ND	ND	ND	0.01
Perfluorooctanoic Acid (PFOA) 全氟辛酸	ppm	With reference to CEN/TS 15968:2010, by solvent extraction and determined by LC-MS-MS. 參考 CEN/TS 15968:2010, 以溶劑萃取並用液相層析串聯質譜儀分析。	ND	ND	ND	0.01



Test Conducted 測試內容 :

Test Item 測試項目	Unit 單位	Test Method 測試方法	Result 結果			RL
			(4)	(5)	(6)	
Heavy Metal 重金屬						
Cadmium (Cd) Content 鎘含量	ppm	With reference to IEC 62321-5: 2013, by microwave or acid digestion and determined by ICP-OES. 參考 IEC 62321-5: 2013，以微波或酸液消化法消化樣品並用感應耦合電漿原子發射光譜儀分析。	ND	ND	ND	2
Lead (Pb) Content 鉛含量	ppm	With reference to IEC 62321-5: 2013, by microwave or acid digestion and determined by ICP-OES. 參考 IEC 62321-5: 2013，以微波或酸液消化法消化樣品並用感應耦合電漿原子發射光譜儀分析。	ND	ND	ND	2
Mercury (Hg) Content 汞含量	ppm	With reference to IEC 62321-4:2013+AMD1:2017, by microwave or acid digestion and determined by ICP-OES. 參考 IEC 62321-4:2013+AMD 1:2017，以微波或酸液消化法消化樣品並用感應耦合電漿原子發射光譜儀分析。	ND	ND	ND	2
Antimony (Sb) Content 銻含量	ppm	With reference to USEPA 3052, by microwave digestion and determined by ICP-OES. 參考 USEPA 3052，以微波消化法並用感應耦合電漿原子發射光譜儀分析。	ND	ND	ND	2
Chromium VI (Cr(VI)) Content 六價鉻含量	ppm	With reference to IEC 62321-7-2: 2017, organic solvent was used to dissolve or swell sample matrix, followed by alkaline digestion and determined by UV-Vis Spectrophotometer. 參考 IEC 62321-7-2:2017，以有機溶劑溶解或使樣品基質膨脹，再進行鹼液消化，用紫外光-可見光分光光度計分析。	ND	ND	ND	8



Test Conducted 測試內容 :

Test Item 測試項目	Unit 單位	Test Method 測試方法	Result 結果			RL
			(4)	(5)	(6)	
Polybrominated Biphenyls (PBBs) 多溴聯苯						
Monobrominated Biphenyls (MonoBB) 單溴聯苯	ppm	With reference to IEC 62321-6: 2015, by solvent extraction and determined by GC-MS and further HPLC-DAD confirmation when necessary. 參考 IEC 62321-6: 2015, 以溶劑萃取並用氣相層析質譜儀分析, 必要時會以高效液相層析儀光二極體陣列偵測儀進行確認。	ND	ND	ND	5
Dibrominated Biphenyls (DiBB) 二溴聯苯	ppm		ND	ND	ND	5
Tribrominated Biphenyls (TriBB) 三溴聯苯	ppm		ND	ND	ND	5
Tetrabrominated Biphenyls (TetraBB) 四溴聯苯	ppm		ND	ND	ND	5
Pentabrominated Biphenyls (PentaBB) 五溴聯苯	ppm		ND	ND	ND	5
Hexabrominated Biphenyls (HexaBB) 六溴聯苯	ppm		ND	ND	ND	5
Heptabrominated Biphenyls (HeptaBB) 七溴聯苯	ppm		ND	ND	ND	5
Octabrominated Biphenyls (OctaBB) 八溴聯苯	ppm		ND	ND	ND	5
Nonabrominated Biphenyls (NonaBB) 九溴聯苯	ppm		ND	ND	ND	5
Decabrominated Biphenyl (DecaBB) 十溴聯苯	ppm		ND	ND	ND	5
Polybrominated Diphenyl Ethers (PBDEs) 多溴聯苯醚						
Monobrominated Diphenyl Ethers (MonoBDE) 單溴聯苯醚	ppm	With reference to IEC 62321-6: 2015, by solvent extraction and determined by GC-MS and further HPLC-DAD confirmation when necessary. 參考 IEC 62321-6: 2015, 以溶劑萃取並用氣相層析質譜儀分析, 必要時會以高效液相層析儀光二極體陣列偵測儀進行確認。	ND	ND	ND	5
Dibrominated Diphenyl Ethers (DiBDE) 二溴聯苯醚	ppm		ND	ND	ND	5
Tribrominated Diphenyl Ethers (TriBDE) 三溴聯苯醚	ppm		ND	ND	ND	5
Tetrabrominated Diphenyl Ethers (TetraBDE) 四溴聯苯醚	ppm		ND	ND	ND	5
Pentabrominated Diphenyl Ethers (PentaBDE) 五溴聯苯醚	ppm		ND	ND	ND	5
Hexabrominated Diphenyl Ethers (HexaBDE) 六溴聯苯醚	ppm		ND	ND	ND	5
Heptabrominated Diphenyl Ethers (HeptaBDE) 七溴聯苯醚	ppm		ND	ND	ND	5
Octabrominated Diphenyl Ethers (OctaBDE) 八溴聯苯醚	ppm		ND	ND	ND	5
Nonabrominated Diphenyl Ethers (NonaBDE) 九溴聯苯醚	ppm		ND	ND	ND	5
Decabrominated Diphenyl Ether (DecaBDE) 十溴聯苯醚	ppm		ND	ND	ND	5



Test Conducted 測試內容 :

Test Item 測試項目	Unit 單位	Test Method 測試方法	Result 結果			RL
			(4)	(5)	(6)	
Phthalates 鄰苯二甲酸酯						
Di(2-ethylhexyl) Phthalate (DEHP) 鄰苯二甲酸二(2-乙基己基)酯	ppm	With reference to IEC 62321-8:2017, by solvent extraction and determined by GC-MS. 參考 IEC 62321-8:2017, 以溶劑萃取並用氣相層析質譜儀分析。	ND	ND	ND	50
Dibutyl Phthalate (DBP) 鄰苯二甲酸二丁酯	ppm		ND	ND	ND	50
Benzyl Butyl Phthalate (BBP) 鄰苯二甲酸苯基丁酯	ppm		ND	ND	ND	50
Di-(Iso-Nonyl) Phthalate (DINP) 鄰苯二甲酸二異壬酯	ppm		ND	ND	ND	50
Di-(Iso-Decyl) Phthalate (DIDP) 鄰苯二甲酸二異癸酯	ppm		ND	ND	ND	50
Di-(N-Octyl) Phthalate (DNOP) 鄰苯二甲酸二辛酯	ppm		ND	ND	ND	50
Di-n-hexyl Phthalate (DNHP) 鄰苯二甲酸二正己酯	ppm		ND	ND	ND	50
Diisobutyl Phthalate (DIBP) 鄰苯二甲酸二異丁酯	ppm		ND	ND	ND	50
Halogen Content 鹵素含量						
Fluorine (F) 氟	ppm	With reference to EN 14582:2016 by combustion bomb with oxygen and determined by Ion Chromatography. 參考 EN 14582:2016, 以氧彈燃燒集氣法並用離子層析儀分析。	508989	513312	434823	50
Chlorine (Cl) 氯	ppm		ND	ND	ND	50
Bromine (Br) 溴	ppm		ND	ND	ND	50
Iodine (I) 碘	ppm		ND	ND	ND	50
Others 其他						
Perfluorooctane Sulfonates Including PFOS, PFOSA, N-Me-FOSA, N-Et-FOSA, N-Me-FOSE, N-Et-FOSE 全氟辛磺酸含 PFOS, PFOSA, N-Me-FOSA, N-Et-FOSA, N-Me-FOSE, N-Et-FOSE	ppm	With reference to CEN/TS 15968:2010, by solvent extraction and determined by LC-MS-MS. 參考 CEN/TS 15968:2010, 以溶劑萃取並用液相層析串聯質譜儀分析。	ND	ND	ND	0.01
Perfluorooctanoic Acid (PFOA) 全氟辛酸	ppm	With reference to CEN/TS 15968:2010, by solvent extraction and determined by LC-MS-MS. 參考 CEN/TS 15968:2010, 以溶劑萃取並用液相層析串聯質譜儀分析。	ND	ND	ND	0.01



Test Conducted 測試內容 :

Test Item 測試項目	Unit 單位	Test Method 測試方法	Result 結果		RL
			(7)	(8)	
Heavy Metal 重金屬					
Cadmium (Cd) Content 鎘含量	ppm	With reference to IEC 62321-5: 2013, by microwave or acid digestion and determined by ICP-OES. 參考 IEC 62321-5: 2013，以微波或酸液消化法消化樣品並用感應耦合電漿原子發射光譜儀分析。	ND	ND	2
Lead (Pb) Content 鉛含量	ppm	With reference to IEC 62321-5: 2013, by microwave or acid digestion and determined by ICP-OES. 參考 IEC 62321-5: 2013，以微波或酸液消化法消化樣品並用感應耦合電漿原子發射光譜儀分析。	ND	ND	2
Mercury (Hg) Content 汞含量	ppm	With reference to IEC 62321-4:2013+AMD1:2017, by microwave or acid digestion and determined by ICP-OES. 參考 IEC 62321-4:2013+AMD 1:2017，以微波或酸液消化法消化樣品並用感應耦合電漿原子發射光譜儀分析。	ND	ND	2
Antimony (Sb) Content 銻含量	ppm	With reference to USEPA 3052, by microwave digestion and determined by ICP-OES. 參考 USEPA 3052，以微波消化法並用感應耦合電漿原子發射光譜儀分析。	ND	ND	2
Chromium VI (Cr(VI)) Content 六價鉻含量	ppm	With reference to IEC 62321-7-2: 2017, organic solvent was used to dissolve or swell sample matrix, followed by alkaline digestion and determined by UV-Vis Spectrophotometer. 參考 IEC 62321-7-2:2017，以有機溶劑溶解或使樣品基質膨脹，再進行鹼液消化，用紫外光-可見分光光度計分析。	ND	ND	8



Test Conducted 測試內容 :

Test Item 測試項目	Unit 單位	Test Method 測試方法	Result 結果		RL
			(7)	(8)	
Polybrominated Biphenyls (PBBs) 多溴聯苯					
Monobrominated Biphenyls (MonoBB) 單溴聯苯	ppm	With reference to IEC 62321-6: 2015, by solvent extraction and determined by GC-MS and further HPLC-DAD confirmation when necessary. 參考 IEC 62321-6: 2015，以溶劑萃取並用氣相層析質譜儀分析，必要時會以高效液相層析儀光二極體陣列偵測儀進行確認。	ND	ND	5
Dibrominated Biphenyls (DiBB) 二溴聯苯	ppm		ND	ND	5
Tribrominated Biphenyls (TriBB) 三溴聯苯	ppm		ND	ND	5
Tetrabrominated Biphenyls (TetraBB) 四溴聯苯	ppm		ND	ND	5
Pentabrominated Biphenyls (PentaBB) 五溴聯苯	ppm		ND	ND	5
Hexabrominated Biphenyls (HexaBB) 六溴聯苯	ppm		ND	ND	5
Heptabrominated Biphenyls (HeptaBB) 七溴聯苯	ppm		ND	ND	5
Octabrominated Biphenyls (OctaBB) 八溴聯苯	ppm		ND	ND	5
Nonabrominated Biphenyls (NonaBB) 九溴聯苯	ppm		ND	ND	5
Decabrominated Biphenyl (DecaBB) 十溴聯苯	ppm		ND	ND	5
Polybrominated Diphenyl Ethers (PBDEs) 多溴聯苯醚					
Monobrominated Diphenyl Ethers (MonoBDE) 單溴聯苯醚	ppm	With reference to IEC 62321-6: 2015, by solvent extraction and determined by GC-MS and further HPLC-DAD confirmation when necessary. 參考 IEC 62321-6: 2015，以溶劑萃取並用氣相層析質譜儀分析，必要時會以高效液相層析儀光二極體陣列偵測儀進行確認。	ND	ND	5
Dibrominated Diphenyl Ethers (DiBDE) 二溴聯苯醚	ppm		ND	ND	5
Tribrominated Diphenyl Ethers (TriBDE) 三溴聯苯醚	ppm		ND	ND	5
Tetrabrominated Diphenyl Ethers (TetraBDE) 四溴聯苯醚	ppm		ND	ND	5
Pentabrominated Diphenyl Ethers (PentaBDE) 五溴聯苯醚	ppm		ND	ND	5
Hexabrominated Diphenyl Ethers (HexaBDE) 六溴聯苯醚	ppm		ND	ND	5
Heptabrominated Diphenyl Ethers (HeptaBDE) 七溴聯苯醚	ppm		ND	ND	5
Octabrominated Diphenyl Ethers (OctaBDE) 八溴聯苯醚	ppm		ND	ND	5
Nonabrominated Diphenyl Ethers (NonaBDE) 九溴聯苯醚	ppm		ND	ND	5
Decabrominated Diphenyl Ether (DecaBDE) 十溴聯苯醚	ppm		ND	ND	5



Test Conducted 測試內容 :

Test Item 測試項目	Unit 單位	Test Method 測試方法	Result 結果		RL
			(7)	(8)	
Phthalates 鄰苯二甲酸酯					
Di(2-ethylhexyl) Phthalate (DEHP) 鄰苯二甲酸二(2-乙基己基)酯	ppm	With reference to IEC 62321-8:2017, by solvent extraction and determined by GC-MS. 參考 IEC 62321-8:2017, 以溶劑萃取並用氣相層析質譜儀分析。	ND	ND	50
Dibutyl Phthalate (DBP) 鄰苯二甲酸二丁酯	ppm		ND	ND	50
Benzyl Butyl Phthalate (BBP) 鄰苯二甲酸苯基丁酯	ppm		ND	ND	50
Di-(Iso-Nonyl) Phthalate (DINP) 鄰苯二甲酸二異壬酯	ppm		ND	ND	50
Di-(Iso-Decyl) Phthalate (DIDP) 鄰苯二甲酸二異癸酯	ppm		ND	ND	50
Di-(N-Octyl) Phthalate (DNOP) 鄰苯二甲酸二辛酯	ppm		ND	ND	50
Di-n-hexyl Phthalate (DNHP) 鄰苯二甲酸二正己酯	ppm		ND	ND	50
Diisobutyl Phthalate (DIBP) 鄰苯二甲酸二異丁酯	ppm		ND	ND	50
Halogen Content 鹵素含量					
Fluorine (F) 氟	ppm	With reference to EN 14582:2016 by combustion bomb with oxygen and determined by Ion Chromatography. 參考 EN 14582:2016, 以氧彈燃燒集氣法並用離子層析儀分析。	508082	433764	50
Chlorine (Cl) 氯	ppm		ND	ND	50
Bromine (Br) 溴	ppm		ND	ND	50
Iodine (I) 碘	ppm		ND	ND	50
Others 其他					
Perfluorooctane Sulfonates Including PFOS, PFOSA, N-Me-FOSA, N-Et-FOSA, N-Me-FOSE, N-Et-FOSE 全氟辛磺酸含 PFOS, PFOSA, N-Me-FOSA, N-Et-FOSA, N-Me-FOSE, N-Et-FOSE	ppm	With reference to CEN/TS 15968:2010, by solvent extraction and determined by LC-MS-MS. 參考 CEN/TS 15968:2010, 以溶劑萃取並用液相層析串聯質譜儀分析。	ND	ND	0.01
Perfluorooctanoic Acid (PFOA) 全氟辛酸	ppm	With reference to CEN/TS 15968:2010, by solvent extraction and determined by LC-MS-MS. 參考 CEN/TS 15968:2010, 以溶劑萃取並用液相層析串聯質譜儀分析。	ND	ND	0.01



Test Conducted 測試內容 :

Test Item 測試項目	Unit 單位	Test Method 測試方法	Result 結果		RL
			(9)	(10)	
Heavy Metal 重金屬					
Cadmium (Cd) Content 鎘含量	ppm	With reference to IEC 62321-5: 2013, by microwave or acid digestion and determined by ICP-OES. 參考 IEC 62321-5: 2013，以微波或酸液消化法消化樣品並用感應耦合電漿原子發射光譜儀分析。	ND	ND	2
Lead (Pb) Content 鉛含量	ppm	With reference to IEC 62321-5: 2013, by microwave or acid digestion and determined by ICP-OES. 參考 IEC 62321-5: 2013，以微波或酸液消化法消化樣品並用感應耦合電漿原子發射光譜儀分析。	ND	ND	2
Mercury (Hg) Content 汞含量	ppm	With reference to IEC 62321-4:2013+AMD1:2017, by microwave or acid digestion and determined by ICP-OES. 參考 IEC 62321-4:2013+AMD 1:2017，以微波或酸液消化法消化樣品並用感應耦合電漿原子發射光譜儀分析。	ND	ND	2
Antimony (Sb) Content 銻含量	ppm	With reference to USEPA 3052, by microwave digestion and determined by ICP-OES. 參考 USEPA 3052，以微波消化法並用感應耦合電漿原子發射光譜儀分析。	ND	ND	2
Chromium VI (Cr(VI)) Content 六價鉻含量	ppm	With reference to IEC 62321-7-2: 2017, organic solvent was used to dissolve or swell sample matrix, followed by alkaline digestion and determined by UV-Vis Spectrophotometer. 參考 IEC 62321-7-2:2017，以有機溶劑溶解或使樣品基質膨脹，再進行鹼液消化，用紫外光-可見光分光光度計分析。	ND	ND	8



Test Conducted 測試內容 :

Test Item 測試項目	Unit 單位	Test Method 測試方法	Result 結果		RL
			(9)	(10)	
Polybrominated Biphenyls (PBBs) 多溴聯苯					
Monobrominated Biphenyls (MonoBB) 單溴聯苯	ppm	With reference to IEC 62321-6: 2015, by solvent extraction and determined by GC-MS and further HPLC-DAD confirmation when necessary. 參考 IEC 62321-6: 2015, 以溶劑萃取並用氣相層析質譜儀分析, 必要時會以高效液相層析儀光二極體陣列偵測儀進行確認。	ND	ND	5
Dibrominated Biphenyls (DiBB) 二溴聯苯	ppm		ND	ND	5
Tribrominated Biphenyls (TriBB) 三溴聯苯	ppm		ND	ND	5
Tetrabrominated Biphenyls (TetraBB) 四溴聯苯	ppm		ND	ND	5
Pentabrominated Biphenyls (PentaBB) 五溴聯苯	ppm		ND	ND	5
Hexabrominated Biphenyls (HexaBB) 六溴聯苯	ppm		ND	ND	5
Heptabrominated Biphenyls (HeptaBB) 七溴聯苯	ppm		ND	ND	5
Octabrominated Biphenyls (OctaBB) 八溴聯苯	ppm		ND	ND	5
Nonabrominated Biphenyls (NonaBB) 九溴聯苯	ppm		ND	ND	5
Decabrominated Biphenyl (DecaBB) 十溴聯苯	ppm		ND	ND	5
Polybrominated Diphenyl Ethers (PBDEs) 多溴聯苯醚					
Monobrominated Diphenyl Ethers (MonoBDE) 單溴聯苯醚	ppm	With reference to IEC 62321-6: 2015, by solvent extraction and determined by GC-MS and further HPLC-DAD confirmation when necessary. 參考 IEC 62321-6: 2015, 以溶劑萃取並用氣相層析質譜儀分析, 必要時會以高效液相層析儀光二極體陣列偵測儀進行確認。	ND	ND	5
Dibrominated Diphenyl Ethers (DiBDE) 二溴聯苯醚	ppm		ND	ND	5
Tribrominated Diphenyl Ethers (TriBDE) 三溴聯苯醚	ppm		ND	ND	5
Tetrabrominated Diphenyl Ethers (TetraBDE) 四溴聯苯醚	ppm		ND	ND	5
Pentabrominated Diphenyl Ethers (PentaBDE) 五溴聯苯醚	ppm		ND	ND	5
Hexabrominated Diphenyl Ethers (HexaBDE) 六溴聯苯醚	ppm		ND	ND	5
Heptabrominated Diphenyl Ethers (HeptaBDE) 七溴聯苯醚	ppm		ND	ND	5
Octabrominated Diphenyl Ethers (OctaBDE) 八溴聯苯醚	ppm		ND	ND	5
Nonabrominated Diphenyl Ethers (NonaBDE) 九溴聯苯醚	ppm		ND	ND	5
Decabrominated Diphenyl Ether (DecaBDE) 十溴聯苯醚	ppm		ND	ND	5



Test Conducted 測試內容 :

Test Item 測試項目	Unit 單位	Test Method 測試方法	Result 結果		RL
			(9)	(10)	
Phthalates 鄰苯二甲酸酯					
Di(2-ethylhexyl) Phthalate (DEHP) 鄰苯二甲酸二(2-乙基己基)酯	ppm	With reference to IEC 62321-8:2017, by solvent extraction and determined by GC-MS. 參考 IEC 62321-8:2017, 以溶劑萃取並用氣相層析質譜儀分析。	ND	ND	50
Dibutyl Phthalate (DBP) 鄰苯二甲酸二丁酯	ppm		ND	ND	50
Benzyl Butyl Phthalate (BBP) 鄰苯二甲酸苯基丁酯	ppm		ND	ND	50
Di-(Iso-Nonyl) Phthalate (DINP) 鄰苯二甲酸二異壬酯	ppm		ND	ND	50
Di-(Iso-Decyl) Phthalate (DIDP) 鄰苯二甲酸二異癸酯	ppm		ND	ND	50
Di-(N-Octyl) Phthalate (DNOP) 鄰苯二甲酸二辛酯	ppm		ND	ND	50
Di-n-hexyl Phthalate (DNHP) 鄰苯二甲酸二正己酯	ppm		ND	ND	50
Diisobutyl Phthalate (DIBP) 鄰苯二甲酸二異丁酯	ppm		ND	ND	50
Halogen Content 鹵素含量					
Fluorine (F) 氟	ppm	With reference to EN 14582:2016 by combustion bomb with oxygen and determined by Ion Chromatography. 參考 EN 14582:2016, 以氧彈燃燒集氣法並用離子層析儀分析。	550579	490593	50
Chlorine (Cl) 氯	ppm		ND	ND	50
Bromine (Br) 溴	ppm		ND	ND	50
Iodine (I) 碘	ppm		ND	ND	50
Others 其他					
Perfluorooctane Sulfonates Including PFOS, PFOSA, N-Me-FOSA, N-Et-FOSA, N-Me-FOSE, N-Et-FOSE 全氟辛磺酸含 PFOS, PFOSA, N-Me-FOSA, N-Et-FOSA, N-Me-FOSE, N-Et-FOSE	ppm	With reference to CEN/TS 15968:2010, by solvent extraction and determined by LC-MS-MS. 參考 CEN/TS 15968:2010, 以溶劑萃取並用液相層析串聯質譜儀分析。	ND	ND	0.01
Perfluorooctanoic Acid (PFOA) 全氟辛酸	ppm	With reference to CEN/TS 15968:2010, by solvent extraction and determined by LC-MS-MS. 參考 CEN/TS 15968:2010, 以溶劑萃取並用液相層析串聯質譜儀分析。	ND	ND	0.01



Test Conducted 測試內容 :

Remarks: ppm = Parts per million based on weight of tested sample = mg/kg
備註 百萬分之一，依據測試樣品重量計算 = 毫克/公斤
ND = Not detected 未檢測出
RL = Reporting limit, quantitation limit of analyte in sample
報告極限，測試樣品之定量偵測極限

Responsibility of Chemist 分析人員 : Cloud Hsu/ Vita Fu

Date Sample Received 樣品收件日期 : Dec 13, 2023
Test Period 樣品測試期間 : Dec 13, 2023 to Jan 02, 2023

RoHS Limit RoHS 限值

Restricted Substances 限用物質	Limits 限值
Cadmium (Cd) content 鎘含量	0.01% (100ppm)
Lead (Pb) content 鉛含量	0.1% (1000ppm)
Mercury (Hg) content 汞含量	0.1% (1000ppm)
Chromium VI (Cr(VI)) content 六價鉻含量	0.1% (1000ppm)
Polybrominated Biphenyls (PBBs) 多溴聯苯	0.1% (1000ppm)
Polybrominated Diphenyl Ethers (PBDEs) 多溴聯苯醚	0.1% (1000ppm)
Di(2-ethylhexyl) Phthalate (DEHP) 鄰苯二甲酸二(2-乙基己基)酯	0.1% (1000ppm)
Dibutyl Phthalate (DBP) 鄰苯二甲酸二丁酯	0.1% (1000ppm)
Benzyl Butyl Phthalate (BBP) 鄰苯二甲酸苯基丁酯	0.1% (1000ppm)
Diisobutyl Phthalate (DIBP) 鄰苯二甲酸二異丁酯	0.1% (1000ppm)

The limits were quoted from Annex II of 2011/65/EU and Amendment (EU) 2015/863 for homogeneous material.
本限值是依據歐盟指令 2011/65/EU 及其更新指令(EU) 2015/863 之附錄二針對均質材質所訂定。



Test Conducted 測試內容 :

Measurement Flowchart 測試流程圖:

Test for Cd/Pb/Hg/Chromium (VI)/PBBs/PBDEs Content RoHS 六項測試

Reference Method 參考方法: Cd/Pb: IEC 62321-5:2013; Hg: IEC 62321-4:2013+AMD1:2017;
Chromium (VI): IEC 62321-7-1:2015 (boiling water extraction);
Chromium (VI): IEC 62321-7-2:2017 (solvent and alkaline extraction);
PBBs/PBDEs: IEC 62321-6:2015

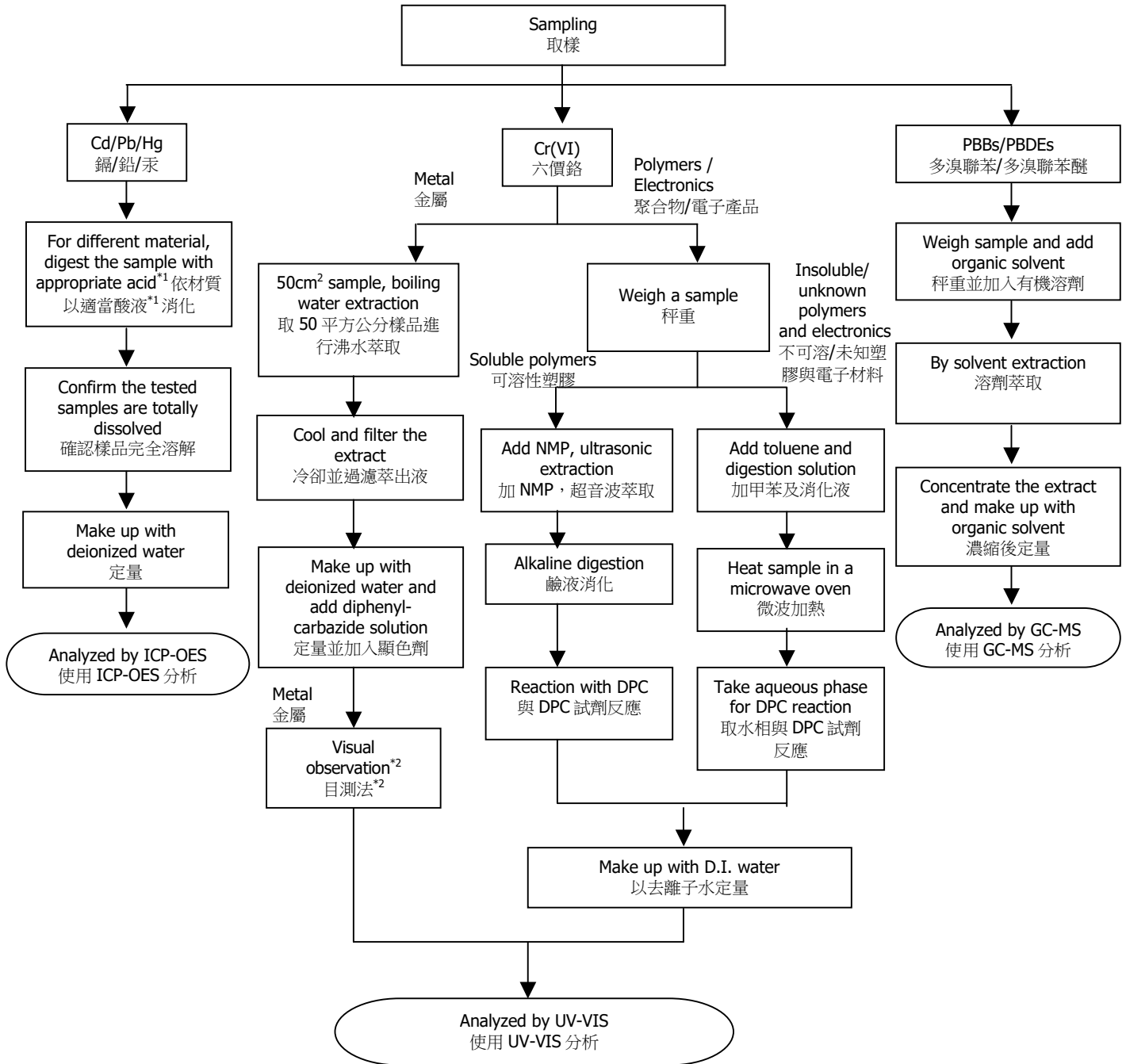

Test Conducted 測試內容 :

Remarks 備註:

*1: List of Appropriate Acid 各材質添加酸液如下表 :

Material 材質	Acid Added for Digestion 添加酸液種類
Polymers 聚合物	HNO ₃ ,HCl,HF,H ₂ O ₂ ,H ₃ BO ₃ 硝酸、鹽酸、氫氟酸、雙氧水、硼酸
Metals 金屬	HNO ₃ ,HCl,HF 硝酸、鹽酸、氫氟酸
Electronics 電子產品	HNO ₃ ,HCl,H ₂ O ₂ ,HBF ₄ 硝酸、鹽酸、雙氧水、氟硼酸

*2: If sample solution is significantly more intense than 0.13 µg/cm² equivalent comparison standard, Chromium VI would be determined as detected, the result of visual observation is positive.

當待測樣品溶液顏色明顯比 0.13 µg/cm² 深，採用目測法判定六價鉻結果為陽性。



Test Conducted 測試內容 :

Measurement Flowchart 測試流程圖:

Test for Heavy Metal (Sb) Content 重金屬(銻)

Reference Method 參考方法 : USEPA 3052

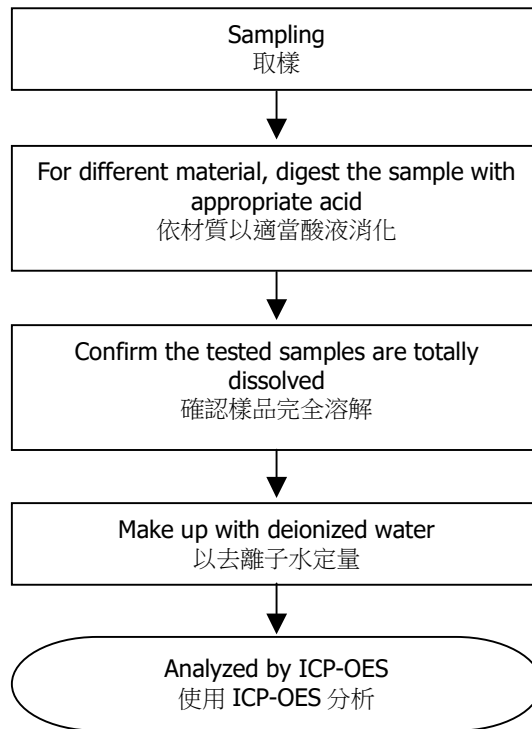

Test Conducted 測試內容 :

Measurement Flowchart 測試流程圖:

Test for Phthalates Content 鄰苯二甲酸酯測試

Reference Method 參考方法: IEC 62321-8:2017

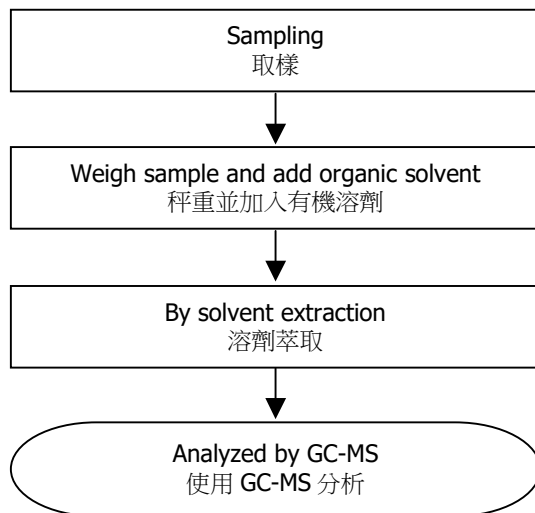

Test Conducted 測試內容 :

Measurement Flowchart 測試流程圖:

Test for Halogen Content 鹵素測試

Reference Method 參考方法 : EN 14582:2016

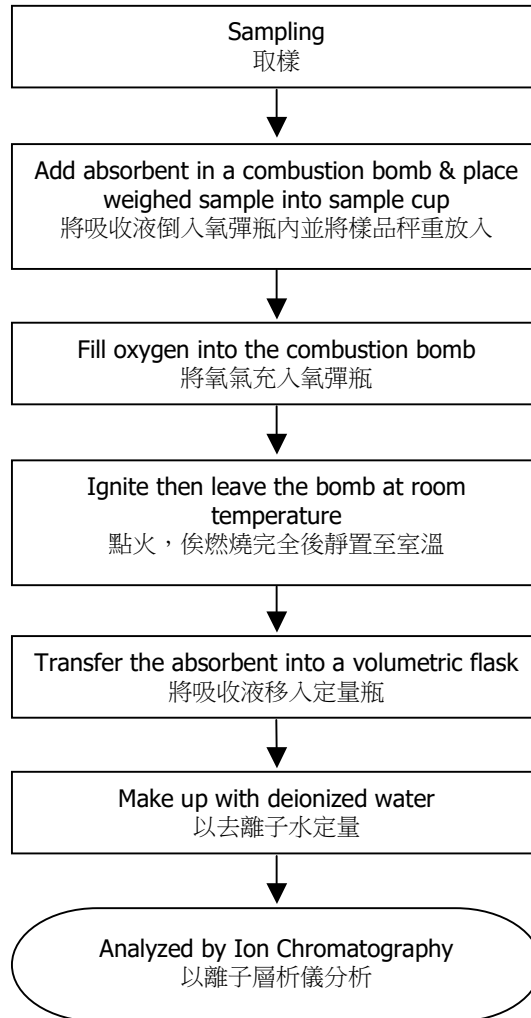

Test Conducted 測試內容 :

Measurement Flowchart 測試流程圖:

Test for Perfluorooctane Sulfonates (PFOS) / Perfluorooctanoic Acid (PFOA) Content 全氟辛磺酸 / 全氟辛酸測試
Reference Method 參考方法 : CEN/TS 15968:2010

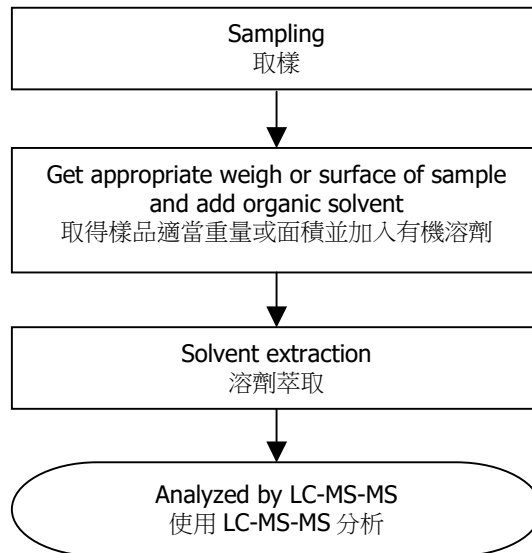

Sample photo 樣品照片 :



Sample photo 樣品照片 :



End of Report

Except where explicitly agreed in writing, all work and services performed by Intertek is subject to our standard Terms and Conditions which can be obtained at our website: <http://www.intertek-twn.com/terms/>. Intertek's responsibility and liability are limited to the terms and conditions of the agreement.

This report is made solely on the basis of your instructions and / or information and materials supplied by you and provide no warranty on the tested sample(s) be truly representative of the sample source. The report is not intended to be a recommendation for any particular course of action, you are responsible for acting as you see fit on the basis of the report results. Intertek is under no obligation to refer to or report upon any facts or circumstances which are outside the specific instructions received and accepts no responsibility to any parties whatsoever, following the issue of the report, for any matters arising outside the agreed scope of the works. This report does not discharge or release you from your legal obligations and duties to any other person. You are the only one authorized to permit copying or distribution of this report (and then only in its entirety). Any such third parties to whom this report may be circulated rely on the content of the report solely at their own risk.

Reporting Statements of Conformity: Please note that the test results contain statement of conformity with the decision rules which are based on the specifications of customers, regulations and standards, and does not consider measurement uncertainty.



Sample Name: NEOFLON FEP

Model No.:

The above sample(s) and information were provided by the client.

SGS Job No.: SHP24-026988

Sample Receiving Date: Aug 15, 2024

Testing Period: Aug 15, 2024 ~ Aug 21, 2024

Test Requested: Select test(s) as requested by the client.

Test Method(s): Please refer to next page(s).

Test Result(s): Please refer to next page(s).

Test Requirement	Conclusion
EU RoHS Directive (EU) 2015/863 amending Annex II to Directive 2011/65/EU - Lead, Mercury, Cadmium, Hexavalent chromium, Polybrominated biphenyls (PBB), Polybrominated diphenyl ethers (PBDE), Bis(2-ethylhexyl) phthalate (DEHP), Butyl benzyl phthalate (BBP), Dibutyl phthalate (DBP) and Diisobutyl phthalate (DIBP)	Pass
Alkanes C10-C13, chloro (short chain-chlorinated paraffins) (SCCPs)	See Results
Element(s)	See Results
Phthalates	See Results
Sulfur (S)	See Results
Hexabromocyclododecane (HBCDD)	See Results
Perfluorooctane sulfonic acid (PFOS) and its derivatives	See Results
AfPS GS 2019:01 PAK-Polycyclic Aromatic Hydrocarbons (PAHs)	See Results

Signed for and on behalf of
SGS-CSTC Standards Technical Services (Shanghai) Co., Ltd.

Jenny Lan
Approved Signatory

scan to see the report



BA4EC555



Unless otherwise agreed in writing, this document is issued by the Company subject to its General Conditions of Service printed overleaf, available on request or accessible at <http://www.sgs.com/en/Terms-and-Conditions.aspx> and, for electronic format documents, subject to Terms and Conditions for Electronic Documents at <http://www.sgs.com/en/Terms-and-Conditions/Terms-e-Documents.aspx>. Attention is drawn to the limitation of liability, indemnification and jurisdiction issues defined therein. Any holder of this document is advised that information contained hereon reflects the Company's findings at the time of its intervention only and within the limits of Client's instructions, if any. The Company's sole responsibility is to its Client and this document does not exonerate parties to a transaction from exercising all their rights and obligations under the transaction documents. This document cannot be reproduced except in full, without prior written approval of the Company. Any unauthorized alteration, forgery or falsification of the content or appearance of this document is unlawful and offenders may be prosecuted to the fullest extent of the law. Unless otherwise stated the results shown in this test report refer only to the sample(s) tested.

Attention: To check the authenticity of testing/inspection report & certificate, please contact us at telephone: (86-755) 8307 1443, or email: CN.Doccheck@sgs.com

SGS-CSTC Standards Technical Services (Shanghai) Co., Ltd.
Testing Center - China

3rd Building, No. 889 Yishan Road Xuhui District, Shanghai China 200233 t E&E (86-21) 61402553 f E&E (86-21) 64953679 www.sgsgroup.com.cn
中国·上海·徐汇区宜山路889号3号楼 邮编: 200233 t HL (86-21) 61402594 f HL (86-21) 61156899 e sgs.china@sgs.com

Test Result(s):

Test Part Description:

SN ID	Sample No.	SGS Sample ID	Description
SN1	A1	SHA24-0186653-0001.C001	Colorless transparent solid pellet

Remarks:

- (1) 1 mg/kg = 1 ppm = 0.0001%
- (2) MDL = Method Detection Limit
- (3) ND = Not Detected (< MDL)
- (4) “-” = Not Regulated

EU RoHS Directive (EU) 2015/863 amending Annex II to Directive 2011/65/EU - Lead, Mercury, Cadmium, Hexavalent chromium, Polybrominated biphenyls (PBB), Polybrominated diphenyl ethers (PBDE), Bis(2-ethylhexyl) phthalate (DEHP), Butyl benzyl phthalate (BBP), Dibutyl phthalate (DBP) and Diisobutyl phthalate (DIBP)

Test Method: With reference to IEC 62321-4:2013+AMD1:2017, IEC 62321-5:2013, IEC 62321-7-2:2017 and IEC 62321-12:2023, analysis was performed by ICP-OES/AAS, Hg analyzer, UV-Vis and GC-MS.

Test Item(s)	Limit	Unit(s)	MDL	A1
Lead (Pb)	1000	mg/kg	2	ND
Mercury (Hg)	1000	mg/kg	2	ND
Cadmium (Cd)	100	mg/kg	2	ND
Hexavalent Chromium (Cr(VI))	1000	mg/kg	8	ND
Polybrominated biphenyls (PBB)	1000	mg/kg	-	ND
Monobrominated biphenyl (MonoBB)	-	mg/kg	25	ND
Dibrominated biphenyl (DiBB)	-	mg/kg	25	ND
Tribrominated biphenyl (TriBB)	-	mg/kg	25	ND
Tetrabrominated biphenyl (TetraBB)	-	mg/kg	25	ND
Pentabrominated biphenyl (PentaBB)	-	mg/kg	25	ND
Hexabrominated biphenyl (HexaBB)	-	mg/kg	25	ND
Heptabrominated biphenyl (HeptaBB)	-	mg/kg	25	ND
Octabrominated biphenyl (OctaBB)	-	mg/kg	25	ND
Nonabrominated biphenyl (NonaBB)	-	mg/kg	25	ND
Decabrominated biphenyl (DecaBB)	-	mg/kg	25	ND
Polybrominated diphenyl ethers (PBDE)	1000	mg/kg	-	ND
Monobrominated diphenyl ether (MonoBDE)	-	mg/kg	25	ND
Dibrominated diphenyl ether (DiBDE)	-	mg/kg	25	ND
Tribrominated diphenyl ether (TriBDE)	-	mg/kg	25	ND
Tetrabrominated diphenyl ether (TetraBDE)	-	mg/kg	25	ND
Pentabrominated diphenyl ether (PentaBDE)	-	mg/kg	25	ND
Hexabrominated diphenyl ether (HexaBDE)	-	mg/kg	25	ND
Heptabrominated diphenyl ether (HeptaBDE)	-	mg/kg	25	ND



Unless otherwise agreed in writing, this document is issued by the Company subject to its General Conditions of Service printed overleaf, available on request or accessible at <http://www.sgs.com/en/Terms-and-Conditions.aspx> and, for electronic format documents, subject to Terms and Conditions for Electronic Documents at <http://www.sgs.com/en/Terms-and-Conditions/Terms-e-Documents.aspx>. Attention is drawn to the limitation of liability, indemnification and jurisdiction issues defined therein. Any holder of this document is advised that information contained hereon reflects the Company's findings at the time of its intervention only and within the limits of Client's instructions, if any. The Company's sole responsibility is to its Client and this document does not exonerate parties to a transaction from exercising all their rights and obligations under the transaction documents. This document cannot be reproduced except in full, without prior written approval of the Company. Any unauthorized alteration, forgery or falsification of the content or appearance of this document is unlawful and offenders may be prosecuted to the fullest extent of the law. Unless otherwise stated the results shown in this test report refer only to the sample(s) tested.

Attention: To check the authenticity of testing /inspection report & certificate, please contact us at telephone: (86-755) 8307 1443, or email: CN.Doccheck@sgs.com

SGS-CSTC (Shanghai) Technical Services (Shanghai) Co., Ltd.
Testing Center - Client's Laboratory

3rd Building, No. 889 Yishan Road Xuhui District, Shanghai China 200233
中国·上海·徐汇区宜山路889号3号楼 邮编: 200233

t E&E (86-21) 61402553 f E&E (86-21) 64953679 www.sgsgroup.com.cn
t HL (86-21) 61402594 f HL (86-21) 61156899 e sgs.china@sgs.com

Test Report

No.: SHAEC24018665305

Date: Aug 21, 2024

Page 3 of 18

Test Item(s)	Limit	Unit(s)	MDL	A1
Octabrominated diphenyl ether (OctaBDE)	-	mg/kg	25	ND
Nonabrominated diphenyl ether (NonaBDE)	-	mg/kg	25	ND
Decabrominated diphenyl ether (DecaBDE)	-	mg/kg	25	ND
Di-2-Ethyl Hexyl Phthalate (DEHP)	1000	mg/kg	50	ND
Benzyl Butyl Phthalate (BBP)	1000	mg/kg	50	ND
Dibutyl Phthalate (DBP)	1000	mg/kg	50	ND
Diisobutyl Phthalate (DIBP)	1000	mg/kg	50	ND

Notes:

- (1) The maximum permissible limit is quoted from RoHS Directive (EU) 2015/863.
- (2) IEC 62321 series is equivalent to EN 62321 series.
- (3) The restriction of DEHP, BBP, DBP and DIBP shall apply to medical devices, including in vitro medical devices, and monitoring and control instruments, including industrial monitoring and control instruments, from 22 July 2021.

Alkanes C10-C13, chloro (short chain-chlorinated paraffins) (SCCPs)

Test Method: With reference to ISO 18219-1:2021, analysis was performed by GC-NCI-MS.

Test Item(s)	CAS No.	Unit(s)	MDL	A1
Short Chain Chlorinated Paraffin(C ₁₀ -C ₁₃)(SCCP)	85535-84-8	mg/kg	50	ND

Element(s)

Test Method: With reference to US EPA 3052:1996, analysis was performed by ICP-OES/AAS.

Test Item(s)	Unit(s)	MDL	A1
Phosphorus(P)	mg/kg	20	ND
Antimony(Sb)	mg/kg	10	ND

Phthalates

Test Method: With reference to EN 14372:2004, analysis was performed by GC-MS.

Test Item(s)	CAS No.	Unit(s)	MDL	A1
Diisononyl Phthalate (DINP)	28553-12-0 /68515-48-0	%	0.010	ND
Di-n-octyl Phthalate (DNOP)	117-84-0	%	0.003	ND
Diisodecyl Phthalate (DIDP)	26761-40-0 /68515-49-1	%	0.010	ND
Dimethyl Phthalates (DMP)	131-11-3	%	0.003	ND
Diethyl Phthalates (DEP)	84-66-2	%	0.003	ND
Di-n-pentyl Phthalates (DnPP)	131-18-0	%	0.003	ND
Di-n-hexyl Phthalates (DnHP)	84-75-3	%	0.003	ND
Bis(2-methoxyethyl) Phthalate (DMEP)	117-82-8	%	0.003	ND



Unless otherwise agreed in writing, this document is issued by the Company subject to its General Conditions of Service printed overleaf, available on request or accessible at <http://www.sgs.com/en/Terms-and-Conditions.aspx> and, for electronic format documents, subject to Terms and Conditions for Electronic Documents at <http://www.sgs.com/en/Terms-and-Conditions/Terms-e-Documents.aspx>. Attention is drawn to the limitation of liability, indemnification and jurisdiction issues defined therein. Any holder of this document is advised that information contained hereon reflects the Company's findings at the time of its intervention only and within the limits of Client's instructions, if any. The Company's sole responsibility is to its Client and this document does not exonerate parties to a transaction from exercising all their rights and obligations under the transaction documents. This document cannot be reproduced except in full, without prior written approval of the Company. Any unauthorized alteration, forgery or falsification of the content or appearance of this document is unlawful and offenders may be prosecuted to the fullest extent of the law. Unless otherwise stated the results shown in this test report refer only to the sample(s) tested.

Attention: To check the authenticity of testing /inspection report & certificate, please contact us at telephone: (86-755) 8307 1443, or email: CN.Doccheck@sgs.com

31st Building, No.889 Yishan Road Xuhui District, Shanghai China 200233 t E&E (86-21) 61402553 f E&E (86-21) 64953679 www.sgsgroup.com.cn
 中国·上海·徐汇区宜山路889号3号楼 邮编: 200233 t HL (86-21) 61402594 f HL (86-21) 61156899 e sgs.china@sgs.com

Test Report

No.: SHAEC24018665305

Date: Aug 21, 2024

Page 4 of 18

Test Item(s)	CAS No.	Unit(s)	MDL	A1
Diisopentylphthalate (DiIPP)	605-50-5	%	0.003	ND
Diisooheptyl phthalate (DIHP)	71888-89-6	%	0.010	ND
1,2-Benzenedicarboxylic acid, di-C7-11-branched and linear alkyl esters(DHNUP)	68515-42-4	%	0.010	ND

Sulfur (S)

Test Method: With reference to EN 14582:2016, analysis was performed by IC.

Test Item(s)	Unit(s)	MDL	A1
Sulfur(S)	mg/kg	50	ND

Hexabromocyclododecane (HBCDD)

Test Method: With reference to US EPA 3550C:2007, analysis was performed by GC-MS.

Test Item(s)	CAS No.	Unit(s)	MDL	A1
Hexabromocyclododecane (HBCDD)	134237-50-6 /134237-51-7 /134237-52-8 /25637-99-4 /3194-55-6	mg/kg	10	ND

Perfluorooctane sulfonic acid (PFOS) and its derivatives

Test Method: Modified EN 17681-1:2022, analysis was performed by LC-MS or LC-MS/MS.

Test Item(s)	CAS No.	Unit(s)	MDL	A1
PFOS, its salts and related compounds				
Perfluorooctane sulfonic acid (PFOS), its salts [^]	1763-23-1	mg/kg	0.010	ND
N-ethylperfluoro-1-octanesulfonamide (N-EtFOSA)	4151-50-2	mg/kg	0.010	ND
N-methylperfluoro-1-octanesulfonamide (N-MeFOSA)	31506-32-8	mg/kg	0.010	ND
2-(N-ethylperfluoro-1-octanesulfonamido)-ethanol (N-EtFOSE)	1691-99-2	mg/kg	0.010	ND
2-(N-methylperfluoro-1-octanesulfonamido)-ethanol (N-MeFOSE)	24448-09-7	mg/kg	0.010	ND
Perfluorooctane Sulfonamide (PFOSA), its salts [^]	754-91-6	mg/kg	0.010	ND
Perfluorooctane sulfonamidoacetic Acid (FOSAA), its salts [^]	2806-24-8	mg/kg	0.010	ND
N-Methylperfluoro-1-octanesulfonamidoacetic Acid (N-MeFOSAA), its salts [^]	2355-31-9	mg/kg	0.010	ND



Unless otherwise agreed in writing, this document is issued by the Company subject to its General Conditions of Service printed overleaf, available on request or accessible at <http://www.sgs.com/en/Terms-and-Conditions.aspx> and, for electronic format documents, subject to Terms and Conditions for Electronic Documents at <http://www.sgs.com/en/Terms-and-Conditions/Terms-e-Documents.aspx>. Attention is drawn to the limitation of liability, indemnification and jurisdiction issues defined therein. Any holder of this document is advised that information contained hereon reflects the Company's findings at the time of its intervention only and within the limits of Client's instructions, if any. The Company's sole responsibility is to its Client and this document does not exonerate parties to a transaction from exercising all their rights and obligations under the transaction documents. This document cannot be reproduced except in full, without prior written approval of the Company. Any unauthorized alteration, forgery or falsification of the content or appearance of this document is unlawful and offenders may be prosecuted to the fullest extent of the law. Unless otherwise stated the results shown in this test report refer only to the sample(s) tested.

Attention: To check the authenticity of testing /inspection report & certificate, please contact us at telephone: (86-755) 8307 1443, or email: CN.Doccheck@sgs.com

SGS-CSTC (Shanghai) Technical Services (Shanghai) Co., Ltd.
Testing Center-Chemical Laboratory

31st Building, No.889 Yishan Road Xuhui District, Shanghai China 200233
中国·上海·徐汇区宜山路889号3号楼 邮编: 200233

t E&E (86-21) 61402553 f E&E (86-21) 64953679 www.sgsgroup.com.cn
t HL (86-21) 61402594 f HL (86-21) 61156899 e sgs.china@sgs.com

Test Report

No.: SHAEC24018665305

Date: Aug 21, 2024

Page 5 of 18

Test Item(s)	CAS No.	Unit(s)	MDL	A1
N-Ethylperfluorooctane sulfonamidoacetic Acid (N-EtFOSAA), its salts [^]	2991-50-6	mg/kg	0.010	ND
Sum of Perfluorooctane sulfonic acid (PFOS) and its derivatives	-	mg/kg	-	ND

Notes:

1. [^]=Substances refer to its salts/derivative listed in below table.

Substance Name	CAS No.
PFOS, its salts & derivatives	
Perfluorooctane sulfonic acid (PFOS)	1763-23-1
Potassium Perfluorooctanesulfonate (PFOS-K)	2795-39-3
Perfluorooctanesulfonic acid, lithium salt (PFOS-Li)	29457-72-5
Sodium perfluorooctanesulfonate (PFOS-Na)	4021-47-0
Ammonium perfluorooctanesulfonate (PFOS-NH ₄)	29081-56-9
Perfluorooctane sulfonate diethanolamine salt (PFOS-NH ₂ (C ₂ H ₄ OH) ₂)	70225-14-8
Perfluorooctanesulfonic acid,tetraethylammonium salt (PFOS-N(C ₂ H ₅) ₄)	56773-42-3
N-decyl-N,N-dimethyldecane-1-aminium 1,1,2,2,3,3,4,4,5,5,6,6,7,7,8,8,8-heptadecafluorooctane-1-sulfonate (PFOS-N(C ₁₀ H ₂₁) ₂ (CH ₃) ₂)	251099-16-8
TetrabutylAmmonium perfluorooctanesulfonate (PFOS-N(C ₄ H ₉) ₄)	111873-33-7
Perfluorooctane Sulfonyl fluoride (PFOS-F)	307-35-7
Magnesium bis(heptadecafluorooctanesulphonate) (PFOS-Mg)	91036-71-4
Piperidine 1,1,2,2,3,3,4,4,5,5,6,6,7,7,8,8,8-heptadecafluorooctanesulfonate	71463-74-6
Perfluorooctanesulfonate	45298-90-6
Triethylammonium perfluorooctane sulfonate (PFOS-N(C ₂ H ₅) ₃)	54439-46-2
Tetramethylammonium perfluorooctane sulfonate (PFOS-N(CH ₃) ₄)	56773-44-5
N,N,N-Tripropylpentan-1-aminium heptadecafluorooctane-1-sulfonate (PFOS-N(C ₃ H ₇) ₃ (C ₅ H ₁₁))	56773-56-9
N,N-Dibutyl-N-methylbutan-1-aminium heptadecafluorooctane-1-sulfonate (PFOS-N(C ₄ H ₉) ₃ (CH ₃))	124472-68-0
Iodonium, bis[4-(1,1-dimethylethyl)phenyl]-, salt with perfluoro-1-octanesulfonic acid (1:1)	213740-80-8
Diphenyl(2,4,6-trimethylphenyl)sulfonium perfluoro-1-octanesulfonate	258341-99-0
1-Hexadecylpyridinium perfluoro-1-octanesulfonate	334529-63-4
N,N,N-Triethyldecane-1-aminium heptadecafluorooctane-1-sulfonate	773895-92-4
Tetrabutylphosphonium perfluorooctane sulfonate (PFOS-P (C ₄ H ₉) ₄)	2185049-59-4
Perfluorooctanesulfonic acid diethylamine salt (PFOS-C ₄ H ₁₁ N)	2205029-08-7
heptyldimethyl{2-[(2-methylprop-2-enoyl)oxy]ethyl}azanium heptadecafluorooctane-1-sulfonate (PFOS-C ₁₅ H ₃₀ NO ₂)	1203998-97-3
Perfluorooctane sulfonic anhydride (PFOSAN)	423-92-7



Unless otherwise agreed in writing, this document is issued by the Company subject to its General Conditions of Service printed overleaf, available on request or accessible at <http://www.sgs.com/en/Terms-and-Conditions.aspx> and, for electronic format documents, subject to Terms and Conditions for Electronic Documents at <http://www.sgs.com/en/Terms-and-Conditions/Terms-e-Documents.aspx>. Attention is drawn to the limitation of liability, indemnification and jurisdiction issues defined therein. Any holder of this document is advised that information contained hereon reflects the Company's findings at the time of its intervention only and within the limits of Client's instructions, if any. The Company's sole responsibility is to its Client and this document does not exonerate parties to a transaction from exercising all their rights and obligations under the transaction documents. This document cannot be reproduced except in full, without prior written approval of the Company. Any unauthorized alteration, forgery or falsification of the content or appearance of this document is unlawful and offenders may be prosecuted to the fullest extent of the law. Unless otherwise stated the results shown in this test report refer only to the sample(s) tested.

Attention: To check the authenticity of testing /inspection report & certificate, please contact us at telephone: (86-755) 8307 1443, or email: CN.Doccheck@sgs.com

SGS-CSTC (Shanghai) Technical Services (Shanghai) Co., Ltd. 31st Building, No.889 Yishan Road Xuhui District, Shanghai China 200233 t E&E (86-21) 61402553 f E&E (86-21) 64953679 www.sgsgroup.com.cn
 中国·上海·徐汇区宜山路889号3号楼 邮编: 200233 t HL (86-21) 61402594 f HL (86-21) 61156899 e sgs.china@sgs.com

FOSAA, its salts	
Perfluorooctane sulfonamidoacetic Acid (FOSAA)	2806-24-8
N-[(Perfluorooctyl)sulfonyl]glycinate (FOSAA(anion))	909405-47-6
N-[(Perfluorooctyl)sulfonyl]glycine potassium salt (1:1) (FOSAA-K)	75260-69-4
N-[(Perfluorooctyl)sulfonyl]glycine sodium salt (1:1) (FOSAA-Na)	115716-87-5
N-MeFOSAA, its salts	
N-Methylperfluoro-1-octanesulfonamidoacetic Acid (N-MeFOSAA)	2355-31-9
2-(N-Methylperfluorooctanesulfonamido)acetate (N-Me-FOSAA(anion))	909405-48-7
Potassium N-((heptadecafluorooctyl)sulphonyl)-N-methylglycinate (N-Me-FOSAA-K)	70281-93-5
N-EtFOSAA, its salts	
N-Ethylperfluorooctane sulfonamidoacetic Acid (N-EtFOSAA)	2991-50-6
Glycine, N-ethyl-N-[(heptadecafluorooctyl)sulfonyl]-, potassium salt (N-Et-FOSAA-K)	2991-51-7
2-(N-Ethyl-perfluorooctanesulfonamido)acetate (N-Et-FOSAA(anion))	909405-49-8
Ammonium 2-(N-ethylperfluorooctanesulfonamido)acetate (N-Et-FOSAA-NH ₄)	2991-52-8
Sodium 2-(N-ethylperfluorooctanesulfonamido)acetate (N-Et-FOSAA-Na)	3871-50-9
PFOSA, its salts	
Perfluorooctane Sulfonamide (PFOSA)	754-91-6
Perfluorooctanesulfonamide lithium salt (1:1) (PFOSA-Li)	76752-79-9
Perfluorooctanesulfonamide Sodium salt (1:1) (PFOSA-Na)	76752-78-8
Perfluorooctanesulfonamide Potassium salt (1:1) (PFOSA-K)	76752-70-0
Perfluorooctanesulfonamide Ammonium salt (1:1) (PFOSA-NH ₄)	76752-72-2
Heptadecafluorooctane-1-sulphonamide, compound with triethylamine (1:1) (PFOSA-C ₆ H ₁₅ N)	76752-82-4

AfPS GS 2019:01 PAK-Polycyclic Aromatic Hydrocarbons (PAHs)

Test Method: With reference to AfPS GS 2019:01 PAK, analysis was performed by GC-MS.

Test Item(s)	CAS No.	Unit(s)	MDL	A1
Benzo(a)pyrene(BaP)	50-32-8	mg/kg	0.1	ND
Benzo(e)pyrene(BeP)	192-97-2	mg/kg	0.1	ND
Benzo(a)anthracene(BaA)	56-55-3	mg/kg	0.1	ND
Benzo(b)Fluoranthene(BbF)	205-99-2	mg/kg	0.1	ND
Benzo(j)fluoranthene(BjF)	205-82-3	mg/kg	0.1	ND
Benzo(k)Fluoranthene(BkF)	207-08-9	mg/kg	0.1	ND
Chrysene(CHR)	218-01-9	mg/kg	0.1	ND
Dibenzo(a,h)Anthracene(DBA)	53-70-3	mg/kg	0.1	ND
Benzo(g,h,i)perylene(BPE)	191-24-2	mg/kg	0.1	ND
Indeno(1,2,3-c,d)pyrene(IPY)	193-39-5	mg/kg	0.1	ND
Phenanthrene(PHE)	85-01-8	mg/kg	0.1	ND
Pyrene(PYR)	129-00-0	mg/kg	0.1	ND
Anthracene(ANT)	120-12-7	mg/kg	0.1	ND



Unless otherwise agreed in writing, this document is issued by the Company subject to its General Conditions of Service printed overleaf, available on request or accessible at <http://www.sgs.com/en/Terms-and-Conditions.aspx> and, for electronic format documents, subject to Terms and Conditions for Electronic Documents at <http://www.sgs.com/en/Terms-and-Conditions/Terms-e-Documents.aspx>. Attention is drawn to the limitation of liability, indemnification and jurisdiction issues defined therein. Any holder of this document is advised that information contained hereon reflects the Company's findings at the time of its intervention only and within the limits of Client's instructions, if any. The Company's sole responsibility is to its Client and this document does not exonerate parties to a transaction from exercising all their rights and obligations under the transaction documents. This document cannot be reproduced except in full, without prior written approval of the Company. Any unauthorized alteration, forgery or falsification of the content or appearance of this document is unlawful and offenders may be prosecuted to the fullest extent of the law. Unless otherwise stated the results shown in this test report refer only to the sample(s) tested.

Attention: To check the authenticity of testing /inspection report & certificate, please contact us at telephone: (86-755) 8307 1443, or email: CN.Doccheck@sgs.com

SGS-CSTC Technical Services (Shanghai) Co., Ltd. 3rd Building, No.889 Yishan Road Xuhui District, Shanghai China 200233 t E&E (86-21) 61402553 f E&E (86-21) 64953679 www.sgsgroup.com.cn
 中国·上海·徐汇区宜山路889号3号楼 邮编: 200233 t HL (86-21) 61402594 f HL (86-21) 61156899 e sgs.china@sgs.com

Test Report

No.: SHAEC24018665305

Date: Aug 21, 2024

Page 7 of 18

Test Item(s)	CAS No.	Unit(s)	MDL	A1
Fluoranthene(FLT)	206-44-0	mg/kg	0.1	ND
Sum of Phenanthrene(PHE), Pyrene(PYR), Anthracene(ANT), Fluoranthene(FLT)	-	mg/kg	-	ND
Naphthalene(NAP)	91-20-3	mg/kg	0.1	ND
Sum of 15 PAHs	-	mg/kg	-	ND
Material Category	-	-	-	-

Notes:

AfPS (German commission for Product Safety) : PAHs requirements

Parameter	Category 1	Category 2		Category 3	
	Materials intended to be placed in the mouth, or materials coming into long-term contact with skin (more than 30s) during the intended use -in toys according to Directive 2009/48/EC or -for the use by children ^{a,b} up to 3 years of age.	Materials not covered by category 1, coming into long-term contact (more than 30s) or short-term repetitive contact ^c with skin during the intended or foreseeable use ^d .		Materials covered neither by category 1 nor by category 2, coming into short-term contact (up to 30s) with skin during the intended or foreseeable use.	
		a. use by children	b. other consumer products	a. use by children	b. other consumer products
Benzo(a)pyrene (BaP) mg/kg	< 0.2	< 0.2	< 0.5	< 0.5	< 1
Benzo(e)pyrene (BeP) mg/kg	< 0.2	< 0.2	< 0.5	< 0.5	< 1
Benzo(a)anthracene (BaA) mg/kg	< 0.2	< 0.2	< 0.5	< 0.5	< 1
Benzo(b)fluoranthene (BbF) mg/kg	< 0.2	< 0.2	< 0.5	< 0.5	< 1
Benzo(j)fluoranthene (BjF) mg/kg	< 0.2	< 0.2	< 0.5	< 0.5	< 1
Benzo(k)fluoranthene (BkF)mg/kg	< 0.2	< 0.2	< 0.5	< 0.5	< 1
Chrysene (CHR) mg/kg	< 0.2	< 0.2	< 0.5	< 0.5	< 1
Dibenzo(a,h)anthracene (DBA) mg/kg	< 0.2	< 0.2	< 0.5	< 0.5	< 1



Unless otherwise agreed in writing, this document is issued by the Company subject to its General Conditions of Service printed overleaf, available on request or accessible at <http://www.sgs.com/en/Terms-and-Conditions.aspx> and, for electronic format documents, subject to Terms and Conditions for Electronic Documents at <http://www.sgs.com/en/Terms-and-Conditions/Terms-e-Documents.aspx>. Attention is drawn to the limitation of liability, indemnification and jurisdiction issues defined therein. Any holder of this document is advised that information contained hereon reflects the Company's findings at the time of its intervention only and within the limits of Client's instructions, if any. The Company's sole responsibility is to its Client and this document does not exonerate parties to a transaction from exercising all their rights and obligations under the transaction documents. This document cannot be reproduced except in full, without prior written approval of the Company. Any unauthorized alteration, forgery or falsification of the content or appearance of this document is unlawful and offenders may be prosecuted to the fullest extent of the law. Unless otherwise stated the results shown in this test report refer only to the sample(s) tested.

Attention: To check the authenticity of testing /inspection report & certificate, please contact us at telephone: (86-755) 8307 1443, or email: CN.Doccheck@sgs.com

SGS-CSTC (Shanghai) Technical Services (Shanghai) Co., Ltd.
Testing Center-Chemical Laboratory

31st Building, No. 889 Yishan Road Xuhui District, Shanghai China 200233
中国·上海·徐汇区宜山路889号3号楼 邮编: 200233

t E&E (86-21) 61402553 f E&E (86-21) 64953679 www.sgsgroup.com.cn
t HL (86-21) 61402594 f HL (86-21) 61156899 e sgs.china@sgs.com

Test Report

No.: SHAEC24018665305

Date: Aug 21, 2024

Page 8 of 18

Benzo(g,h,i)perylene (BPE) mg/kg	< 0.2	< 0.2	< 0.5	< 0.5	< 1
Indeno(1,2,3-cd)pyrene (IPY) mg/kg	< 0.2	< 0.2	< 0.5	< 0.5	< 1
Phenanthrene (PHE), pyrene (PYR), anthracene (ANT), fluoranthene (FLT), mg/kg	< 1 Sum	< 5 Sum	< 10 Sum	< 20 Sum	< 50 Sum
Naphthalene (NAP) mg/kg	< 1	< 2		< 10	
Sum of 15 PAHs	<1	< 5	< 10	< 20	< 50

Notes:

- ^a A “Child” is legally defined as a person before reaching the age of 14 years.
- ^b Use by children includes both active and passive contact by children.
- ^c Definition “short-term repetitive contact” taken from REACH Annex XVII entry 50 amendment (Regulation (EC) No.1272/2013)
- ^d According to the definition of the German Product Safety Act (ProdSG) (chapter 1 Article 2 No. 28) “foreseeable use” shall mean the use of a product in a manner that the person placing it on the market, has not intended, but which could be reasonably foreseeable.

Remark:

The German committee on Product Safety (AfPS) published a new PAHs document (AfPS GS 2019:01 PAK) on April 10, 2020, which will be binding for the issue of GS mark certificate from July 1, 2020.

Unless otherwise stated, the decision rule for conformity reporting is based on Binary Statement for Simple Acceptance Rule (w=0) stated in ILAC-G8:09/2019.



SGS-CSTC (Shanghai) Inspection & Testing Services Co., Ltd.
 Testing Center-Chemical Laboratory

Unless otherwise agreed in writing, this document is issued by the Company subject to its General Conditions of Service printed overleaf, available on request or accessible at <http://www.sgs.com/en/Terms-and-Conditions.aspx> and, for electronic format documents, subject to Terms and Conditions for Electronic Documents at <http://www.sgs.com/en/Terms-and-Conditions/Terms-e-Documents.aspx>. Attention is drawn to the limitation of liability, indemnification and jurisdiction issues defined therein. Any holder of this document is advised that information contained hereon reflects the Company's findings at the time of its intervention only and within the limits of Client's instructions, if any. The Company's sole responsibility is to its Client and this document does not exonerate parties to a transaction from exercising all their rights and obligations under the transaction documents. This document cannot be reproduced except in full, without prior written approval of the Company. Any unauthorized alteration, forgery or falsification of the content or appearance of this document is unlawful and offenders may be prosecuted to the fullest extent of the law. Unless otherwise stated the results shown in this test report refer only to the sample(s) tested.

Attention: To check the authenticity of testing /inspection report & certificate, please contact us at telephone: (86-755) 8307 1443, or email: CN.Doccheck@sgs.com

3rd Building, No.889 Yishan Road Xuhui District, Shanghai China 200233 t E&E (86-21) 61402553 f E&E (86-21) 64953679 www.sgsgroup.com.cn
 中国·上海·徐汇区宜山路889号3号楼 邮编: 200233 t HL (86-21) 61402594 f HL (86-21) 61156899 e sgs.china@sgs.com

ATTACHMENTS

Elements Testing Flow Chart

These samples were dissolved totally by pre-conditioning method according to below flow chart.

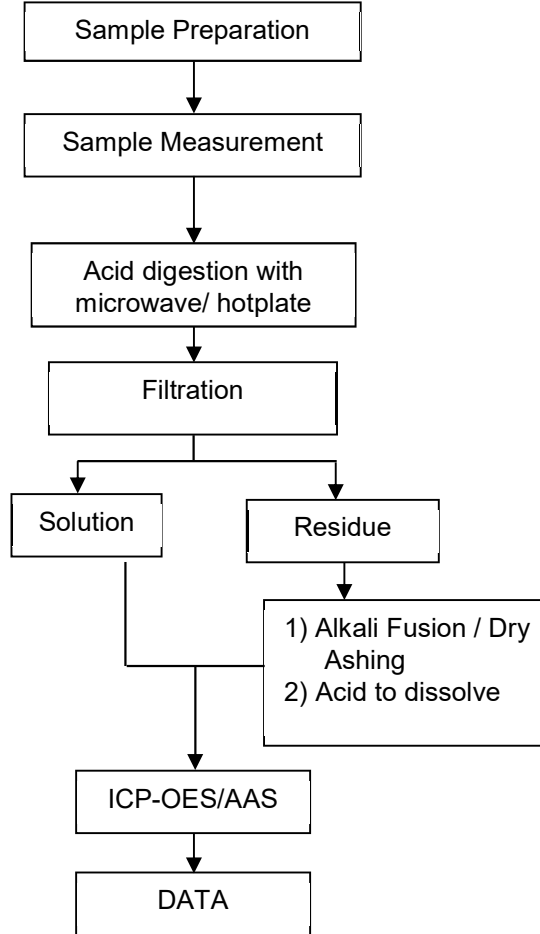

Unless otherwise agreed in writing, this document is issued by the Company subject to its General Conditions of Service printed overleaf, available on request or accessible at <http://www.sgs.com/en/Terms-and-Conditions.aspx> and, for electronic format documents, subject to Terms and Conditions for Electronic Documents at <http://www.sgs.com/en/Terms-and-Conditions/Terms-e-Documents.aspx>. Attention is drawn to the limitation of liability, indemnification and jurisdiction issues defined therein. Any holder of this document is advised that information contained hereon reflects the Company's findings at the time of its intervention only and within the limits of Client's instructions, if any. The Company's sole responsibility is to its Client and this document does not exonerate parties to a transaction from exercising all their rights and obligations under the transaction documents. This document cannot be reproduced except in full, without prior written approval of the Company. Any unauthorized alteration, forgery or falsification of the content or appearance of this document is unlawful and offenders may be prosecuted to the fullest extent of the law. Unless otherwise stated the results shown in this test report refer only to the sample(s) tested.

Attention: To check the authenticity of testing /inspection report & certificate, please contact us at telephone: (86-755) 8307 1443, or email: CN.Doccheck@sgs.com

SGS-CSTC Shanghai Technical Services (Shanghai) Co., Ltd. 31st Building, No. 889 Yishan Road Xuhui District, Shanghai China 200233 t E&E (86-21) 61402553 f E&E (86-21) 64953679 www.sgsgroup.com.cn
 中国·上海·徐汇区宜山路889号3号楼 邮编: 200233 t HL (86-21) 61402594 f HL (86-21) 61156899 e sgs.china@sgs.com

Hexavalent Chromium (Cr(VI)) Testing Flow Chart

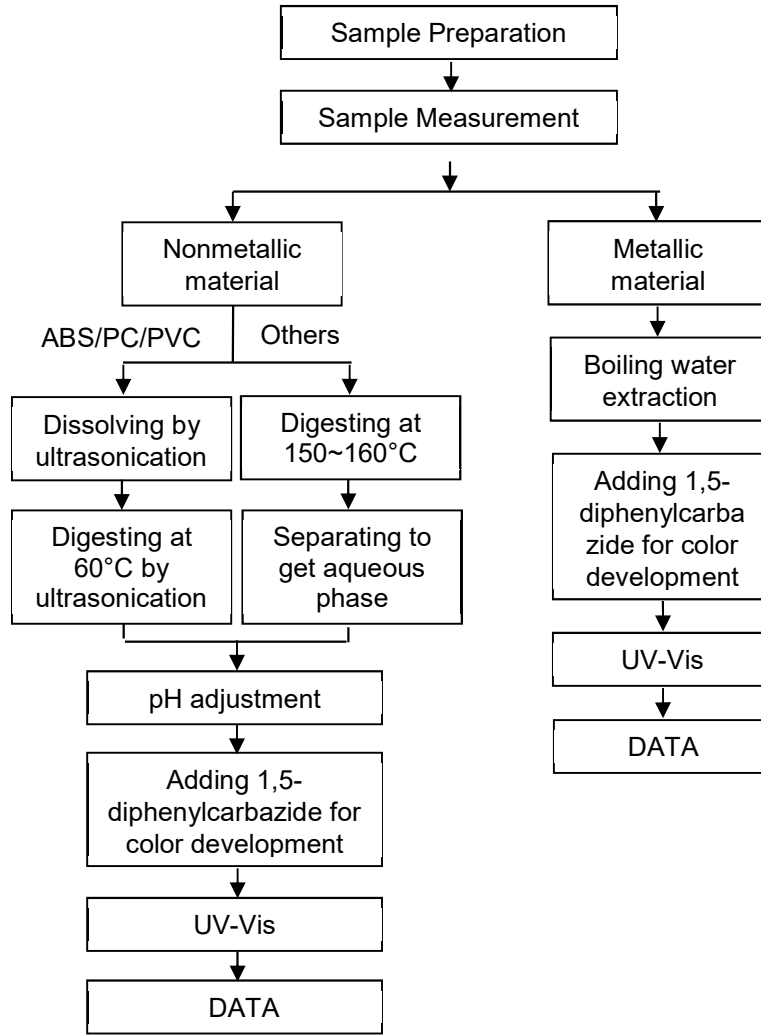

Unless otherwise agreed in writing, this document is issued by the Company subject to its General Conditions of Service printed overleaf, available on request or accessible at <http://www.sgs.com/en/Terms-and-Conditions.aspx> and, for electronic format documents, subject to Terms and Conditions for Electronic Documents at <http://www.sgs.com/en/Terms-and-Conditions/Terms-e-Documents.aspx>. Attention is drawn to the limitation of liability, indemnification and jurisdiction issues defined therein. Any holder of this document is advised that information contained hereon reflects the Company's findings at the time of its intervention only and within the limits of Client's instructions, if any. The Company's sole responsibility is to its Client and this document does not exonerate parties to a transaction from exercising all their rights and obligations under the transaction documents. This document cannot be reproduced except in full, without prior written approval of the Company. Any unauthorized alteration, forgery or falsification of the content or appearance of this document is unlawful and offenders may be prosecuted to the fullest extent of the law. Unless otherwise stated the results shown in this test report refer only to the sample(s) tested.

Attention: To check the authenticity of testing / inspection report & certificate, please contact us at telephone: (86-755) 8307 1443, or email: CN.Doccheck@sgs.com

PBBs/PBDEs/Phthalates Testing Flow Chart

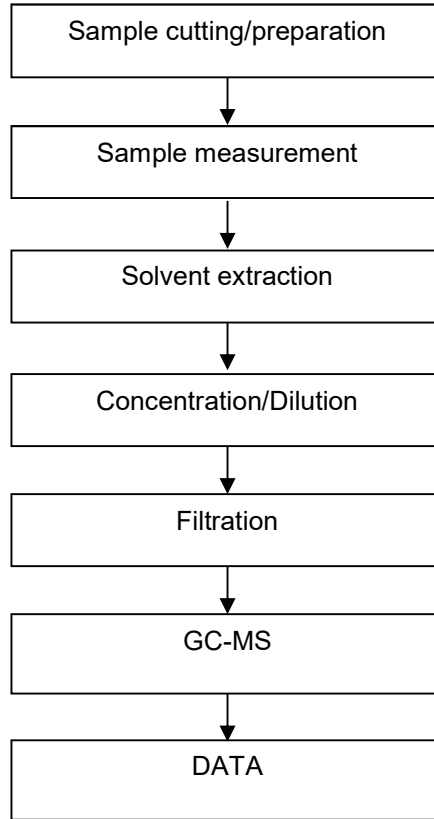

Unless otherwise agreed in writing, this document is issued by the Company subject to its General Conditions of Service printed overleaf, available on request or accessible at <http://www.sgs.com/en/Terms-and-Conditions.aspx> and, for electronic format documents, subject to Terms and Conditions for Electronic Documents at <http://www.sgs.com/en/Terms-and-Conditions/Terms-e-Documents.aspx>. Attention is drawn to the limitation of liability, indemnification and jurisdiction issues defined therein. Any holder of this document is advised that information contained hereon reflects the Company's findings at the time of its intervention only and within the limits of Client's instructions, if any. The Company's sole responsibility is to its Client and this document does not exonerate parties to a transaction from exercising all their rights and obligations under the transaction documents. This document cannot be reproduced except in full, without prior written approval of the Company. Any unauthorized alteration, forgery or falsification of the content or appearance of this document is unlawful and offenders may be prosecuted to the fullest extent of the law. Unless otherwise stated the results shown in this test report refer only to the sample(s) tested.

Attention: To check the authenticity of testing /inspection report & certificate, please contact us at telephone: (86-755) 8307 1443, or email: CN.Doccheck@sgs.com

Chlorinated Paraffin Testing Flow Chart

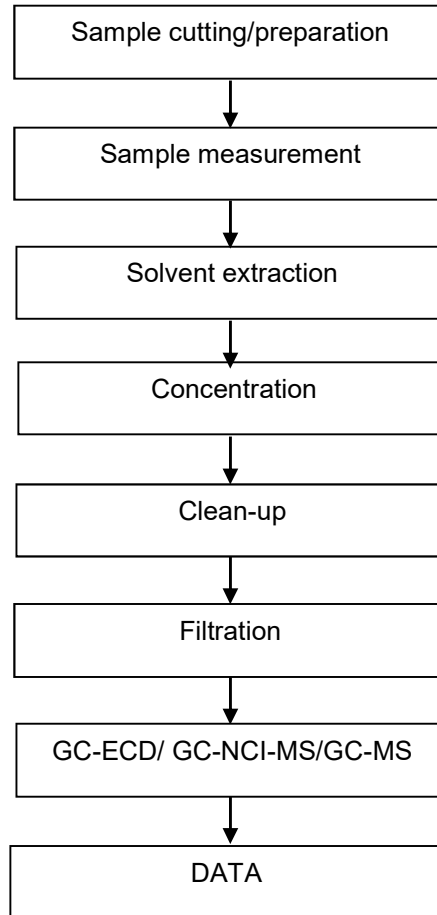

Elements Testing Flow Chart

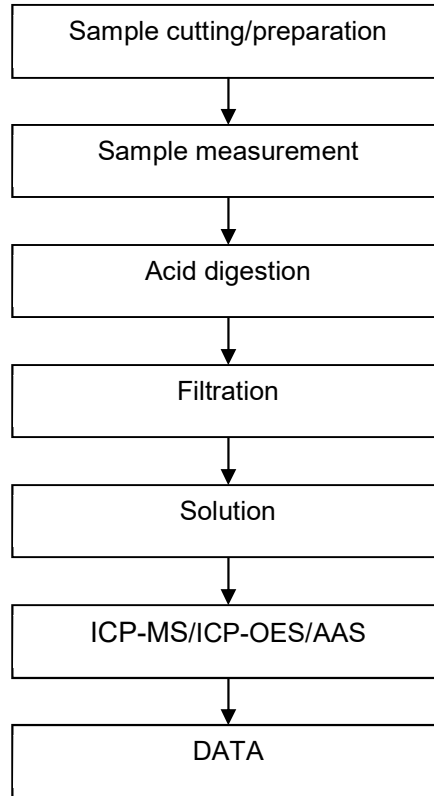

Unless otherwise agreed in writing, this document is issued by the Company subject to its General Conditions of Service printed overleaf, available on request or accessible at <http://www.sgs.com/en/Terms-and-Conditions.aspx> and, for electronic format documents, subject to Terms and Conditions for Electronic Documents at <http://www.sgs.com/en/Terms-and-Conditions/Terms-e-Documents.aspx>. Attention is drawn to the limitation of liability, indemnification and jurisdiction issues defined therein. Any holder of this document is advised that information contained hereon reflects the Company's findings at the time of its intervention only and within the limits of Client's instructions, if any. The Company's sole responsibility is to its Client and this document does not exonerate parties to a transaction from exercising all their rights and obligations under the transaction documents. This document cannot be reproduced except in full, without prior written approval of the Company. Any unauthorized alteration, forgery or falsification of the content or appearance of this document is unlawful and offenders may be prosecuted to the fullest extent of the law. Unless otherwise stated the results shown in this test report refer only to the sample(s) tested.

Attention: To check the authenticity of testing /inspection report & certificate, please contact us at telephone: (86-755) 8307 1443, or email: CN.Doccheck@sgs.com

Phthalates Testing Flow Chart

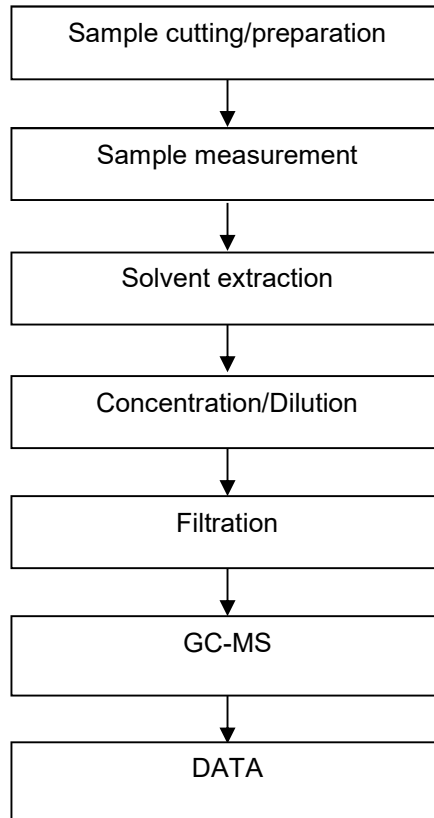

Unless otherwise agreed in writing, this document is issued by the Company subject to its General Conditions of Service printed overleaf, available on request or accessible at <http://www.sgs.com/en/Terms-and-Conditions.aspx> and, for electronic format documents, subject to Terms and Conditions for Electronic Documents at <http://www.sgs.com/en/Terms-and-Conditions/Terms-e-Documents.aspx>. Attention is drawn to the limitation of liability, indemnification and jurisdiction issues defined therein. Any holder of this document is advised that information contained hereon reflects the Company's findings at the time of its intervention only and within the limits of Client's instructions, if any. The Company's sole responsibility is to its Client and this document does not exonerate parties to a transaction from exercising all their rights and obligations under the transaction documents. This document cannot be reproduced except in full, without prior written approval of the Company. Any unauthorized alteration, forgery or falsification of the content or appearance of this document is unlawful and offenders may be prosecuted to the fullest extent of the law. Unless otherwise stated the results shown in this test report refer only to the sample(s) tested.

Attention: To check the authenticity of testing /inspection report & certificate, please contact us at telephone: (86-755) 8307 1443, or email: CN.Doccheck@sgs.com

HBCDD Testing Flow Chart

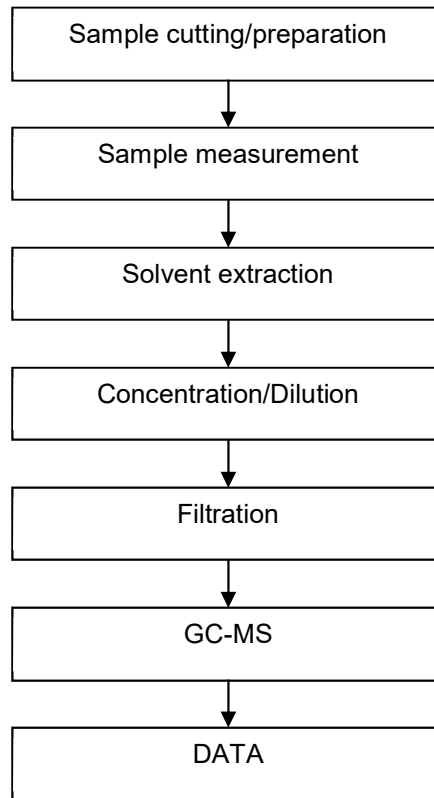

Unless otherwise agreed in writing, this document is issued by the Company subject to its General Conditions of Service printed overleaf, available on request or accessible at <http://www.sgs.com/en/Terms-and-Conditions.aspx> and, for electronic format documents, subject to Terms and Conditions for Electronic Documents at <http://www.sgs.com/en/Terms-and-Conditions/Terms-e-Documents.aspx>. Attention is drawn to the limitation of liability, indemnification and jurisdiction issues defined therein. Any holder of this document is advised that information contained hereon reflects the Company's findings at the time of its intervention only and within the limits of Client's instructions, if any. The Company's sole responsibility is to its Client and this document does not exonerate parties to a transaction from exercising all their rights and obligations under the transaction documents. This document cannot be reproduced except in full, without prior written approval of the Company. Any unauthorized alteration, forgery or falsification of the content or appearance of this document is unlawful and offenders may be prosecuted to the fullest extent of the law. Unless otherwise stated the results shown in this test report refer only to the sample(s) tested.

Attention: To check the authenticity of testing /inspection report & certificate, please contact us at telephone: (86-755) 8307 1443, or email: CN.Doccheck@sgs.com

PFASs/ PFOS/PFOA Testing Flow Chart

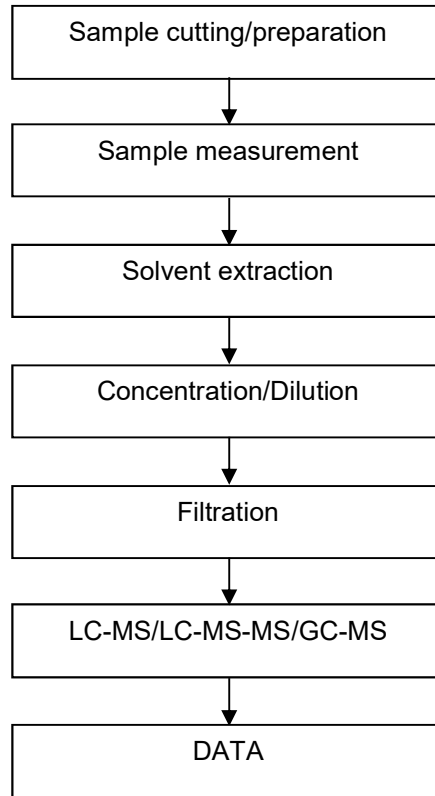

Unless otherwise agreed in writing, this document is issued by the Company subject to its General Conditions of Service printed overleaf, available on request or accessible at <http://www.sgs.com/en/Terms-and-Conditions.aspx> and, for electronic format documents, subject to Terms and Conditions for Electronic Documents at <http://www.sgs.com/en/Terms-and-Conditions/Terms-e-Documents.aspx>. Attention is drawn to the limitation of liability, indemnification and jurisdiction issues defined therein. Any holder of this document is advised that information contained hereon reflects the Company's findings at the time of its intervention only and within the limits of Client's instructions, if any. The Company's sole responsibility is to its Client and this document does not exonerate parties to a transaction from exercising all their rights and obligations under the transaction documents. This document cannot be reproduced except in full, without prior written approval of the Company. Any unauthorized alteration, forgery or falsification of the content or appearance of this document is unlawful and offenders may be prosecuted to the fullest extent of the law. Unless otherwise stated the results shown in this test report refer only to the sample(s) tested.

Attention: To check the authenticity of testing /inspection report & certificate, please contact us at telephone: (86-755) 8307 1443, or email: CN.Doccheck@sgs.com

PAHs Testing Flow Chart

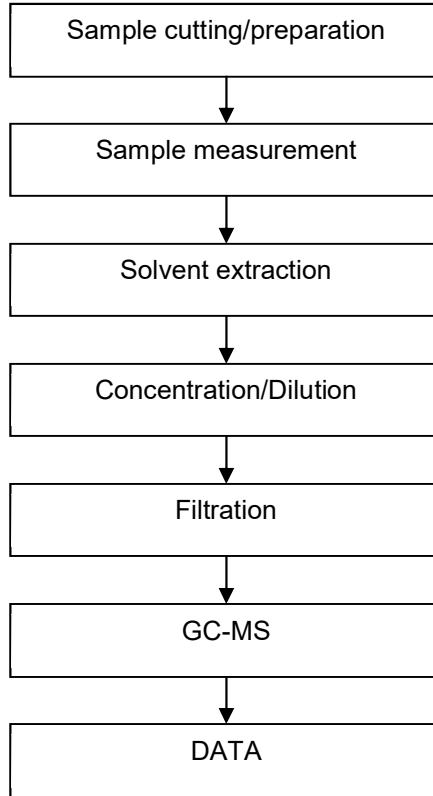

Unless otherwise agreed in writing, this document is issued by the Company subject to its General Conditions of Service printed overleaf, available on request or accessible at <http://www.sgs.com/en/Terms-and-Conditions.aspx> and, for electronic format documents, subject to Terms and Conditions for Electronic Documents at <http://www.sgs.com/en/Terms-and-Conditions/Terms-e-Documents.aspx>. Attention is drawn to the limitation of liability, indemnification and jurisdiction issues defined therein. Any holder of this document is advised that information contained hereon reflects the Company's findings at the time of its intervention only and within the limits of Client's instructions, if any. The Company's sole responsibility is to its Client and this document does not exonerate parties to a transaction from exercising all their rights and obligations under the transaction documents. This document cannot be reproduced except in full, without prior written approval of the Company. Any unauthorized alteration, forgery or falsification of the content or appearance of this document is unlawful and offenders may be prosecuted to the fullest extent of the law. Unless otherwise stated the results shown in this test report refer only to the sample(s) tested.

Attention: To check the authenticity of testing /inspection report & certificate, please contact us at telephone: (86-755) 8307 1443, or email: CN.Doccheck@sgs.com

Test Report

No.: SHAEC24018665305

Date: Aug 21, 2024

Page 18 of 18

Sample Photo:



SGS authenticate the photo on original report only
*** End of Report ***



Unless otherwise agreed in writing, this document is issued by the Company subject to its General Conditions of Service printed overleaf, available on request or accessible at <http://www.sgs.com/en/Terms-and-Conditions.aspx> and, for electronic format documents, subject to Terms and Conditions for Electronic Documents at <http://www.sgs.com/en/Terms-and-Conditions/Terms-e-Documents.aspx>. Attention is drawn to the limitation of liability, indemnification and jurisdiction issues defined therein. Any holder of this document is advised that information contained hereon reflects the Company's findings at the time of its intervention only and within the limits of Client's instructions, if any. The Company's sole responsibility is to its Client and this document does not exonerate parties to a transaction from exercising all their rights and obligations under the transaction documents. This document cannot be reproduced except in full, without prior written approval of the Company. Any unauthorized alteration, forgery or falsification of the content or appearance of this document is unlawful and offenders may be prosecuted to the fullest extent of the law. Unless otherwise stated the results shown in this test report refer only to the sample(s) tested.

Attention: To check the authenticity of testing / inspection report & certificate, please contact us at telephone: (86-755) 8307 1443, or email: CN.Doccheck@sgs.com

31st Building, No. 889 Yishan Road Xuhui District, Shanghai China 200233 t E&E (86-21) 61402553 f E&E (86-21) 64953679 www.sgsgroup.com.cn
中国·上海·徐汇区宜山路889号3号楼 邮编: 200233 t HL (86-21) 61402594 f HL (86-21) 61156899 e sgs.china@sgs.com

Test Report 測試報告

Applicant: WONDERFUL HI-TECH CO., LTD.
申請廠商 萬泰科技股份有限公司
No.17, Beiyuan Rd., Zhongli Dist.,
Taoyuan City 320, Taiwan (R.O.C.)
桃園市中壢區工業區北園路 17 號

Number : TWNC01231370
報告號碼

Issue Date : Jan 12, 2024
報告發行日期

Sample Description 樣品敘述:

One (1) Group of Submitted Samples Said To Be :

以下測試樣品乃供應商所提供及確認:

Sample Submitted By : WONDERFUL HI-TECH CO., LTD.

送樣廠商 萬泰科技股份有限公司

Sample Description : 裸銅線, 鍍銀銅包鋼線, 鍍銀銅線, 鍍錫銅線 (COPPER, SILVER-PLATED COPPER CLAD)

樣品名稱

Style / Item No. : 裸銅 COPPER/銅包鋼 SILVER-PLATED COPPER CLAD STEEL/鍍銀層 SILVER-PLATED/

產品型號 鍍錫層 TIN-PLATED

Date Sample Received : Dec 13, 2023

收件日期

Date Test Started : Dec 13, 2023

開始測試日期

Test Conducted 測試執行:

As requested by the applicant, for details please refer to attached pages.

依申請商之要求, 細節請參考附頁.

Conclusion 結論:

Tested Sample 測試樣品

Test Components of
Submitted Samples

測試部位

Standard 標準

Restriction of Hazardous Substances (RoHS)

危害物質限制

— As per applicant's request with reference to 2011/65/EU and
amendment (EU) 2015/863

依據客戶要求參考歐盟指令 2011/65/EU 及其更新指令(EU)
2015/863

Result 結果

Pass 合格

Tested Components 測試元件:

(1) Coppery metal wire

(2) Silvery metal wire

(3) Silvery metal wire

(4) Silvery metal wire

Authorized By:

On behalf of Intertek Testing Services
Taiwan Limited

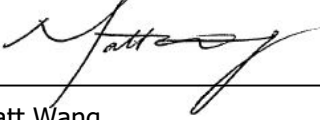

Matt Wang
General Manager



Signed by:



Thomas Chou
Manager



報告查詢 Report Verification



Test Conducted 測試內容 :

Test Result Summary 測試結果 :

Test Item 測試項目	Unit 單位	Test Method 測試方法	Result 結果		RL
			(1)	(2)	
Heavy Metal 重金屬					
Cadmium (Cd) Content 鎘含量	ppm	With reference to IEC 62321-5: 2013, by microwave or acid digestion and determined by ICP-OES. 參考 IEC 62321-5: 2013，以微波或酸液消化法消化樣品並用感應耦合電漿原子發射光譜儀分析。	ND	ND	2
Lead (Pb) Content 鉛含量	ppm	With reference to IEC 62321-5: 2013, by microwave or acid digestion and determined by ICP-OES. 參考 IEC 62321-5: 2013，以微波或酸液消化法消化樣品並用感應耦合電漿原子發射光譜儀分析。	ND	ND	2
Mercury (Hg) Content 汞含量	ppm	With reference to IEC 62321-4:2013+AMD1:2017, by microwave or acid digestion and determined by ICP-OES. 參考 IEC 62321-4:2013+AMD 1:2017，以微波或酸液消化法消化樣品並用感應耦合電漿原子發射光譜儀分析。	ND	ND	2
Chromium VI (Cr(VI)) Content 六價鉻含量 @	µg/ cm ²	With reference to IEC 62321-7-1: 2015, by boiling water extraction and determined by UV-Vis Spectrophotometer or visual observation. 參考 IEC 62321-7-1: 2015，以沸水萃取並用紫外光-可見光分光光度計分析或目測法判定。	Negative	Negative	0.10



Test Conducted 測試內容 :

Test Item 測試項目	Unit 單位	Test Method 測試方法	Result 結果		RL
			(1)	(2)	
Polybrominated Biphenyls (PBBs) 多溴聯苯					
Monobrominated Biphenyls (MonoBB) 單溴聯苯	ppm	With reference to IEC 62321-6: 2015, by solvent extraction and determined by GC-MS and further HPLC-DAD confirmation when necessary. 參考 IEC 62321-6: 2015, 以溶劑萃取並用氣相層析質譜儀分析, 必要時會以高效液相層析儀光二極體陣列偵測儀進行確認。	ND	ND	5
Dibrominated Biphenyls (DiBB) 二溴聯苯	ppm		ND	ND	5
Tribrominated Biphenyls (TriBB) 三溴聯苯	ppm		ND	ND	5
Tetrabrominated Biphenyls (TetraBB) 四溴聯苯	ppm		ND	ND	5
Pentabrominated Biphenyls (PentaBB) 五溴聯苯	ppm		ND	ND	5
Hexabrominated Biphenyls (HexaBB) 六溴聯苯	ppm		ND	ND	5
Heptabrominated Biphenyls (HeptaBB) 七溴聯苯	ppm		ND	ND	5
Octabrominated Biphenyls (OctaBB) 八溴聯苯	ppm		ND	ND	5
Nonabrominated Biphenyls (NonaBB) 九溴聯苯	ppm		ND	ND	5
Decabrominated Biphenyl (DecaBB) 十溴聯苯	ppm		ND	ND	5
Polybrominated Diphenyl Ethers (PBDEs) 多溴聯苯醚					
Monobrominated Diphenyl Ethers (MonoBDE) 單溴聯苯醚	ppm	With reference to IEC 62321-6: 2015, by solvent extraction and determined by GC-MS and further HPLC-DAD confirmation when necessary. 參考 IEC 62321-6: 2015, 以溶劑萃取並用氣相層析質譜儀分析, 必要時會以高效液相層析儀光二極體陣列偵測儀進行確認。	ND	ND	5
Dibrominated Diphenyl Ethers (DiBDE) 二溴聯苯醚	ppm		ND	ND	5
Tribrominated Diphenyl Ethers (TriBDE) 三溴聯苯醚	ppm		ND	ND	5
Tetrabrominated Diphenyl Ethers (TetraBDE) 四溴聯苯醚	ppm		ND	ND	5
Pentabrominated Diphenyl Ethers (PentaBDE) 五溴聯苯醚	ppm		ND	ND	5
Hexabrominated Diphenyl Ethers (HexaBDE) 六溴聯苯醚	ppm		ND	ND	5
Heptabrominated Diphenyl Ethers (HeptaBDE) 七溴聯苯醚	ppm		ND	ND	5
Octabrominated Diphenyl Ethers (OctaBDE) 八溴聯苯醚	ppm		ND	ND	5
Nonabrominated Diphenyl Ethers (NonaBDE) 九溴聯苯醚	ppm		ND	ND	5
Decabrominated Diphenyl Ether (DecaBDE) 十溴聯苯醚	ppm		ND	ND	5



Test Conducted 測試內容 :

Test Item 測試項目	Unit 單位	Test Method 測試方法	Result 結果		RL
			(1)	(2)	
Phthalates 鄰苯二甲酸酯					
Di(2-ethylhexyl) Phthalate (DEHP) 鄰苯二甲酸二(2-乙基己基)酯	ppm	With reference to IEC 62321-8:2017, by solvent extraction and determined by GC-MS. 參考 IEC 62321-8:2017, 以溶劑萃取並用氣相層析質譜儀分析。	ND	ND	50
Dibutyl Phthalate (DBP) 鄰苯二甲酸二丁酯	ppm		ND	ND	50
Benzyl Butyl Phthalate (BBP) 鄰苯二甲酸苯基丁酯	ppm		ND	ND	50
Diisobutyl Phthalate (DIBP) 鄰苯二甲酸二異丁酯	ppm		ND	ND	50

Test Item 測試項目	Unit 單位	Test Method 測試方法	Result 結果		RL
			(3)	(4)	
Heavy Metal 重金屬					
Cadmium (Cd) Content 鎘含量	ppm	With reference to IEC 62321-5: 2013, by microwave or acid digestion and determined by ICP-OES. 參考 IEC 62321-5: 2013, 以微波或酸液消化法消化樣品並用感應耦合電漿原子發射光譜儀分析。	ND	ND	2
Lead (Pb) Content 鉛含量	ppm	With reference to IEC 62321-5: 2013, by microwave or acid digestion and determined by ICP-OES. 參考 IEC 62321-5: 2013, 以微波或酸液消化法消化樣品並用感應耦合電漿原子發射光譜儀分析。	ND	ND	2
Mercury (Hg) Content 汞含量	ppm	With reference to IEC 62321-4:2013+AMD1:2017, by microwave or acid digestion and determined by ICP-OES. 參考 IEC 62321-4:2013+AMD 1:2017, 以微波或酸液消化法消化樣品並用感應耦合電漿原子發射光譜儀分析。	ND	ND	2
Chromium VI (Cr(VI)) Content 六價鉻含量 @	µg/cm ²	With reference to IEC 62321-7-1: 2015, by boiling water extraction and determined by UV-Vis Spectrophotometer or visual observation. 參考 IEC 62321-7-1: 2015, 以沸水萃取並用紫外光-可見光分光光度計分析或目測法判定。	Negative	Negative	0.10



Test Conducted 測試內容 :

Test Item 測試項目	Unit 單位	Test Method 測試方法	Result 結果		RL
			(3)	(4)	
Polybrominated Biphenyls (PBBs) 多溴聯苯					
Monobrominated Biphenyls (MonoBB) 單溴聯苯	ppm	With reference to IEC 62321-6: 2015, by solvent extraction and determined by GC-MS and further HPLC-DAD confirmation when necessary. 參考 IEC 62321-6: 2015，以溶劑萃取並用氣相層析質譜儀分析，必要時會以高效液相層析儀光二極體陣列偵測儀進行確認。	ND	ND	5
Dibrominated Biphenyls (DiBB) 二溴聯苯	ppm		ND	ND	5
Tribrominated Biphenyls (TriBB) 三溴聯苯	ppm		ND	ND	5
Tetrabrominated Biphenyls (TetraBB) 四溴聯苯	ppm		ND	ND	5
Pentabrominated Biphenyls (PentaBB) 五溴聯苯	ppm		ND	ND	5
Hexabrominated Biphenyls (HexaBB) 六溴聯苯	ppm		ND	ND	5
Heptabrominated Biphenyls (HeptaBB) 七溴聯苯	ppm		ND	ND	5
Octabrominated Biphenyls (OctaBB) 八溴聯苯	ppm		ND	ND	5
Nonabrominated Biphenyls (NonaBB) 九溴聯苯	ppm		ND	ND	5
Decabrominated Biphenyl (DecaBB) 十溴聯苯	ppm		ND	ND	5
Polybrominated Diphenyl Ethers (PBDEs) 多溴聯苯醚					
Monobrominated Diphenyl Ethers (MonoBDE) 單溴聯苯醚	ppm	With reference to IEC 62321-6: 2015, by solvent extraction and determined by GC-MS and further HPLC-DAD confirmation when necessary. 參考 IEC 62321-6: 2015，以溶劑萃取並用氣相層析質譜儀分析，必要時會以高效液相層析儀光二極體陣列偵測儀進行確認。	ND	ND	5
Dibrominated Diphenyl Ethers (DiBDE) 二溴聯苯醚	ppm		ND	ND	5
Tribrominated Diphenyl Ethers (TriBDE) 三溴聯苯醚	ppm		ND	ND	5
Tetrabrominated Diphenyl Ethers (TetraBDE) 四溴聯苯醚	ppm		ND	ND	5
Pentabrominated Diphenyl Ethers (PentaBDE) 五溴聯苯醚	ppm		ND	ND	5
Hexabrominated Diphenyl Ethers (HexaBDE) 六溴聯苯醚	ppm		ND	ND	5
Heptabrominated Diphenyl Ethers (HeptaBDE) 七溴聯苯醚	ppm		ND	ND	5
Octabrominated Diphenyl Ethers (OctaBDE) 八溴聯苯醚	ppm		ND	ND	5
Nonabrominated Diphenyl Ethers (NonaBDE) 九溴聯苯醚	ppm		ND	ND	5
Decabrominated Diphenyl Ether (DecaBDE) 十溴聯苯醚	ppm		ND	ND	5



Test Conducted 測試內容 :

Test Item 測試項目	Unit 單位	Test Method 測試方法	Result 結果		RL
			(3)	(4)	
Phthalates 鄰苯二甲酸酯					
Di(2-ethylhexyl) Phthalate (DEHP) 鄰苯二甲酸二(2-乙基己基)酯	ppm	With reference to IEC 62321-8:2017, by solvent extraction and determined by GC-MS. 參考 IEC 62321-8:2017，以溶劑萃取並用氣相層析質譜儀分析。	ND	ND	50
Dibutyl Phthalate (DBP) 鄰苯二甲酸二丁酯	ppm		ND	ND	50
Benzyl Butyl Phthalate (BBP) 鄰苯二甲酸苯基丁酯	ppm		ND	ND	50
Diisobutyl Phthalate (DIBP) 鄰苯二甲酸二異丁酯	ppm		ND	ND	50

Remarks: ppm = Parts per million based on weight of tested sample = mg/kg
備註 百萬分之一，依據測試樣品重量計算 = 毫克/公斤
ND = Not detected 未檢測出
RL = Reporting limit, quantitation limit of analyte in sample
報告極限，測試樣品之定量偵測極限

@ The explanation of Chromium VI (Cr(VI)) analysis results 六價鉻分析結果說明

Colorimetric result 比色結果	Qualitative Result 定性結果	Explanation 說明
< 0.10 µg/cm ²	Negative 陰性	The result of sample is negative for Cr(VI). The sample coating is considered a non-Cr(VI) based coating. 六價鉻結果為陰性。樣品之鍍層可視為不含六價鉻。
≥ 0.10 µg/cm ² and ≤ 0.13 µg/cm ²	Inconclusive 不確定	The result of sample is considered to be inconclusive. If addition samples are available, recommend to add trials and get the average result for the final determination. 六價鉻結果為不確定。若可取得較多樣品，建議增加測試次數並取得其平均值，以評估最後結果。
> 0.13 µg/cm ²	Positive 陽性	The result of sample is positive for Cr(VI). The sample coating is considered to contain Cr(VI). 六價鉻結果為陽性。樣品之鍍層可視為含有六價鉻。 A result expresses as Positive, while not an actual value, which indicates a visual observation was used. 當結果以陽性表示，而非數值時，為使用目測法判定。

Responsibility of Chemist 分析人員 : Cloud Hsu/ Vita Fu

Date Sample Received 樣品收件日期 : Dec 13, 2023

Test Period 樣品測試期間 : Dec 13, 2023 to Jan 02, 2024



Test Conducted 測試內容 :

RoHS Limit RoHS 限值

Restricted Substances 限用物質	Limits 限值
Cadmium (Cd) content 鎘含量	0.01% (100ppm)
Lead (Pb) content 鉛含量	0.1% (1000ppm)
Mercury (Hg) content 汞含量	0.1% (1000ppm)
Chromium VI (Cr(VI)) content 六價鉻含量	0.1% (1000ppm)
Polybrominated Biphenyls (PBBs) 多溴聯苯	0.1% (1000ppm)
Polybrominated Diphenyl Ethers (PBDEs) 多溴聯苯醚	0.1% (1000ppm)
Di(2-ethylhexyl) Phthalate (DEHP) 鄰苯二甲酸二(2-乙基己基)酯	0.1% (1000ppm)
Dibutyl Phthalate (DBP) 鄰苯二甲酸二丁酯	0.1% (1000ppm)
Benzyl Butyl Phthalate (BBP) 鄰苯二甲酸苯基丁酯	0.1% (1000ppm)
Diisobutyl Phthalate (DIBP) 鄰苯二甲酸二異丁酯	0.1% (1000ppm)

The limits were quoted from Annex II of 2011/65/EU and Amendment (EU) 2015/863 for homogeneous material.
本限值是依據歐盟指令 2011/65/EU 及其更新指令(EU) 2015/863 之附錄二針對均質材質所訂定。



Test Conducted 測試內容 :

Measurement Flowchart 測試流程圖:

Test for Cd/Pb/Hg/Chromium (VI)/PBBs/PBDEs Content RoHS 六項測試

Reference Method 參考方法: Cd/Pb: IEC 62321-5:2013; Hg: IEC 62321-4:2013+AMD1:2017;
Chromium (VI): IEC 62321-7-1:2015 (boiling water extraction);
Chromium (VI): IEC 62321-7-2:2015 (solvent and alkaline extraction);
PBBs/PBDEs: IEC 62321-6:2015

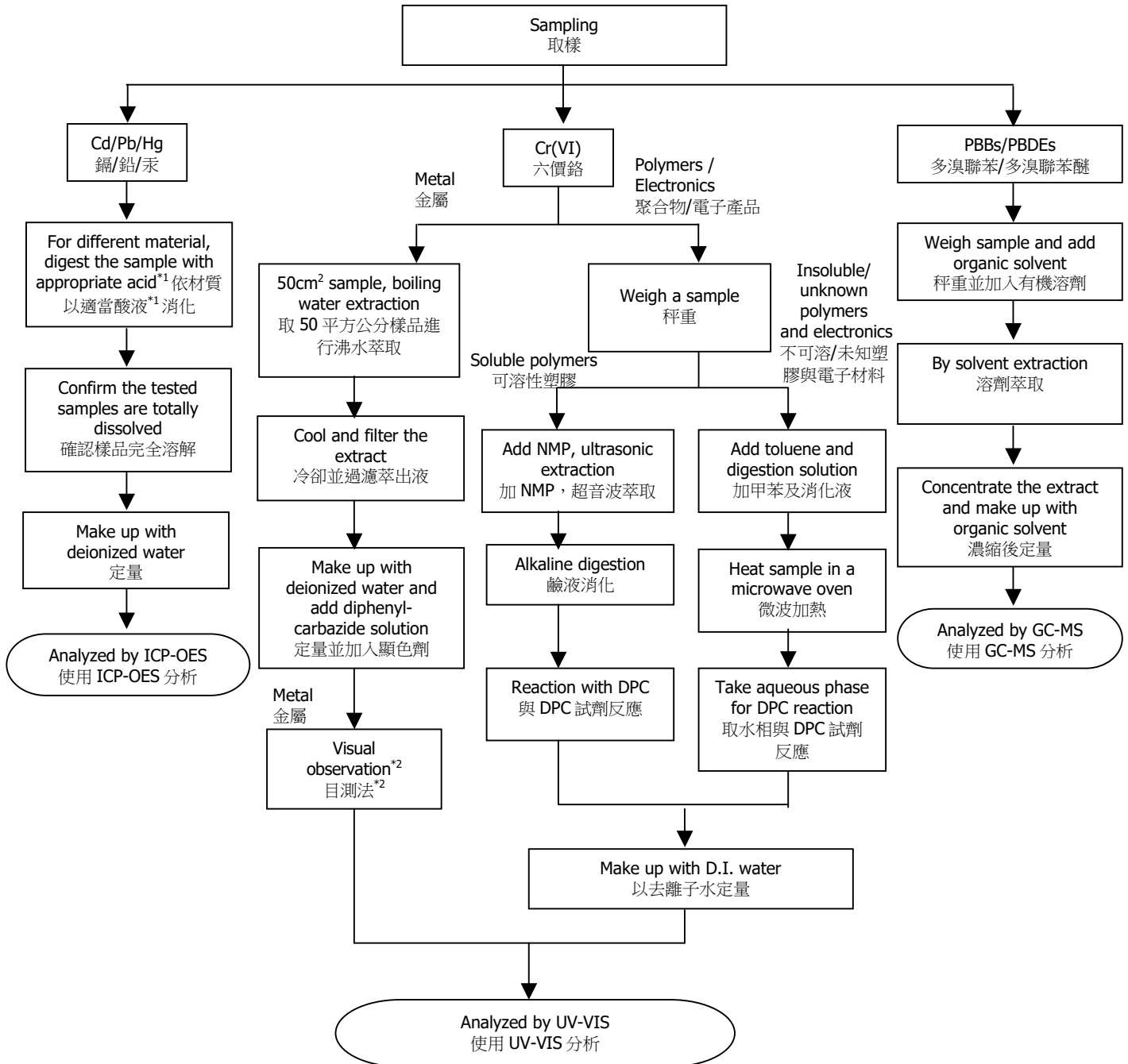

Test Conducted 測試內容 :

Remarks 備註:

*1: List of Appropriate Acid 各材質添加酸液如下表 :

Material 材質	Acid Added for Digestion 添加酸液種類
Polymers 聚合物	HNO ₃ , HCl, HF, H ₂ O ₂ , H ₃ BO ₃ 硝酸、鹽酸、氫氟酸、雙氧水、硼酸
Metals 金屬	HNO ₃ , HCl, HF 硝酸、鹽酸、氫氟酸
Electronics 電子產品	HNO ₃ , HCl, H ₂ O ₂ , HBF ₄ 硝酸、鹽酸、雙氧水、氟硼酸

*2: If sample solution is significantly more intense than 0.13 µg/cm² equivalent comparison standard, Chromium VI would be determined as detected, the result of visual observation is positive.

當待測樣品溶液顏色明顯比 0.13 µg/cm² 深，採用目測法判定六價鉻結果為陽性。



Test Conducted 測試內容 :

Measurement Flowchart 測試流程圖:

Test for Phthalates Content 鄰苯二甲酸酯測試

Reference Method 參考方法: IEC 62321-8:2017

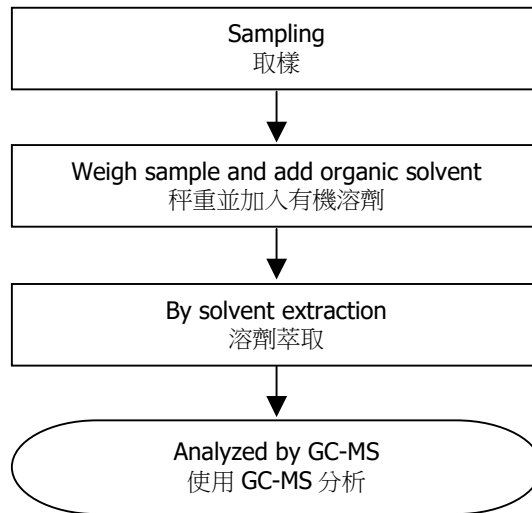

Sample photo 樣品照片 :



End of Report

Except where explicitly agreed in writing, all work and services performed by Intertek is subject to our standard Terms and Conditions which can be obtained at our website: <http://www.intertek-twn.com/terms/>. Intertek's responsibility and liability are limited to the terms and conditions of the agreement.

This report is made solely on the basis of your instructions and / or information and materials supplied by you and provide no warranty on the tested sample(s) be truly representative of the sample source. The report is not intended to be a recommendation for any particular course of action, you are responsible for acting as you see fit on the basis of the report results. Intertek is under no obligation to refer to or report upon any facts or circumstances which are outside the specific instructions received and accepts no responsibility to any parties whatsoever, following the issue of the report, for any matters arising outside the agreed scope of the works. This report does not discharge or release you from your legal obligations and duties to any other person. You are the only one authorized to permit copying or distribution of this report (and then only in its entirety). Any such third parties to whom this report may be circulated rely on the content of the report solely at their own risk.

Reporting Statements of Conformity: Please note that the test results contain statement of conformity with the decision rules which are based on the specifications of customers, regulations and standards, and does not consider measurement uncertainty.

