

## FCC Test Report

**Report No.:** RF190726C11A

**FCC ID:** KA2BA2520PA1

**Test Model:** DBA-2520P

**Received Date:** Jul. 26, 2019

**Test Date:** Nov. 11 ~ Dec. 24, 2019

**Issued Date:** Dec. 25, 2019

**Applicant:** D-Link Corporation

**Address:** 17595 Mt. Herrmann, Fountain Valley, California, United States, 92708

**Issued By:** Bureau Veritas Consumer Products Services (H.K.) Ltd., Taoyuan Branch  
Lin Kou Laboratories

**Lab Address:** No. 47-2, 14th Ling, Chia Pau Vil., Lin Kou Dist., New Taipei City, Taiwan

**Test Location:** No. 19, Hwa Ya 2nd Rd., Wen Hwa Vil., Kwei Shan Dist., Taoyuan City  
33383, TAIWAN

**FCC Registration /  
Designation Number:** 788550 / TW0003



This report is for your exclusive use. Any copying or replication of this report to or for any other person or entity, or use of our name or trademark, is permitted only with our prior written permission. This report sets forth our findings solely with respect to the test samples identified herein. The results set forth in this report are not indicative or representative of the quality or characteristics of the lot from which a test sample was taken or any similar or identical product unless specifically and expressly noted. Our report includes all of the tests requested by you and the results thereof based upon the information that you provided to us. You have 60 days from date of issuance of this report to notify us of any material error or omission caused by our negligence, provided, however, that such notice shall be in writing and shall specifically address the issue you wish to raise. A failure to raise such issue within the prescribed time shall constitute your unqualified acceptance of the completeness of this report, the tests conducted and the correctness of the report contents. Unless specifically mentioned, the uncertainty of measurement has been explicitly taken into account to declare the compliance or non-compliance to the specification. The report must not be used by the client to claim product certification, approval, or endorsement by TAF or any government agencies.

## Table of Contents

<b>Release Control Record</b> .....	<b>4</b>
<b>1 Certificate of Conformity</b> .....	<b>5</b>
<b>2 Summary of Test Results</b> .....	<b>6</b>
2.1 Measurement Uncertainty.....	6
2.2 Modification Record.....	6
<b>3 General Information</b> .....	<b>7</b>
3.1 General Description of EUT.....	7
3.2 Description of Test Modes.....	9
3.2.1 Test Mode Applicability and Tested Channel Detail.....	10
3.3 Duty Cycle of Test Signal.....	12
3.4 Description of Support Units.....	13
3.4.1 Configuration of System under Test.....	13
3.5 General Description of Applied Standards and References.....	14
<b>4 Test Types and Results</b> .....	<b>15</b>
4.1 Radiated Emission and Bandedge Measurement.....	15
4.1.1 Limits of Radiated Emission and Bandedge Measurement.....	15
4.1.2 Test Instruments.....	16
4.1.3 Test Procedures.....	17
4.1.4 Deviation from Test Standard.....	17
4.1.5 Test Setup.....	18
4.1.6 EUT Operating Conditions.....	19
4.1.7 Test Results.....	20
4.2 Conducted Emission Measurement.....	50
4.2.1 Limits of Conducted Emission Measurement.....	50
4.2.2 Test Instruments.....	50
4.2.3 Test Procedures.....	51
4.2.4 Deviation from Test Standard.....	51
4.2.5 Test Setup.....	51
4.2.6 EUT Operating Conditions.....	51
4.2.7 Test Results.....	52
4.3 Transmit Power Measurement.....	58
4.3.1 Limits of Transmit Power Measurement.....	58
4.3.2 Test Setup.....	58
4.3.3 Test Instruments.....	58
4.3.4 Test Procedure.....	59
4.3.5 Deviation from Test Standard.....	59
4.3.6 EUT Operating Conditions.....	59
4.3.7 Test Result.....	60
4.4 Occupied Bandwidth Measurement.....	71
4.4.1 Test Setup.....	71
4.4.2 Test Instruments.....	71
4.4.3 Test Procedure.....	71
4.4.4 Test Result.....	72
4.5 Peak Power Spectral Density Measurement.....	74
4.5.1 Limits of Peak Power Spectral Density Measurement.....	74
4.5.2 Test Setup.....	74
4.5.3 Test Instruments.....	74
4.5.4 Test Procedures.....	74
4.5.5 Deviation from Test Standard.....	75
4.5.6 EUT Operating Conditions.....	75
4.5.7 Test Results.....	76
4.6 Frequency Stability.....	81
4.6.1 Limits of Frequency Stability Measurement.....	81

4.6.2	Test Setup.....	81
4.6.3	Test Instruments .....	81
4.6.4	Test Procedure .....	81
4.6.5	Deviation from Test Standard .....	82
4.6.6	EUT Operating Condition .....	82
4.6.7	Test Results .....	82
4.7	6dB Bandwidth Measurement.....	83
4.7.1	Limits of 6dB Bandwidth Measurement.....	83
4.7.2	Test Setup.....	83
4.7.3	Test Instruments .....	83
4.7.4	Test Procedure .....	83
4.7.5	Deviation from Test Standard .....	83
4.7.6	EUT Operating Condition .....	83
4.7.7	Test Results .....	84
<b>5</b>	<b>Pictures of Test Arrangements.....</b>	<b>86</b>
	<b>Appendix – Information of the Testing Laboratories .....</b>	<b>87</b>

### Release Control Record

Issue No.	Description	Date Issued
RF190726C11A	Original release	Dec. 25, 2019

## 1 Certificate of Conformity

**Product:** Nuclias Cloud-Managed AC1900 Wave 2 Access Point

**Brand:** D-Link Corporation

**Test Model:** DBA-2520P

**Sample Status:** Engineering sample

**Applicant:** D-Link Corporation

**Test Date:** Nov. 11 ~ Dec. 24, 2019

**Standards:** 47 CFR FCC Part 15, Subpart E (Section 15.407)  
ANSI C63.10:2013

The above equipment has been tested by **Bureau Veritas Consumer Products Services (H.K.) Ltd., Taoyuan Branch**, and found compliance with the requirement of the above standards. The test record, data evaluation & Equipment Under Test (EUT) configurations represented herein are true and accurate accounts of the measurements of the sample's RF characteristics under the conditions specified in this report.

**Prepared by :** , **Date:** Dec. 25, 2019  
Polly Chien / Specialist

**Approved by :** , **Date:** Dec. 25, 2019  
Bruce Chen / Senior Project Engineer

## 2 Summary of Test Results

47 CFR FCC Part 15, Subpart E (Section 15.407)			
FCC Clause	Test Item	Result	Remarks
15.407(b)(6)	AC Power Conducted Emissions	Pass	Meet the requirement of limit. Minimum passing margin is -4.43dB at 17.86621MHz.
15.407(b) (1/2/3/4(i/ii)/6)	Radiated Emissions & Band Edge Measurement	Pass	Meet the requirement of limit. Minimum passing margin is -1.0dB at 5725.00MHz.
15.407(a)(1/2/3)	Max Average Transmit Power	Pass	Meet the requirement of limit.
---	Occupied Bandwidth Measurement	-	Reference only.
15.407(a)(1/2/3)	Peak Power Spectral Density	Pass	Meet the requirement of limit.
15.407(e)	6dB bandwidth	Pass	Meet the requirement of limit. (U-NII-3 Band only)
15.407(g)	Frequency Stability	Pass	Meet the requirement of limit.
15.203	Antenna Requirement	Pass	Antenna connector is i-pex(MHF) not a standard connector.

Note: Determining compliance based on the results of the compliance measurement, not taking into account measurement instrumentation uncertainty.

### 2.1 Measurement Uncertainty

Where relevant, the following measurement uncertainty levels have been estimated for tests performed on the EUT as specified in CISPR 16-4-2:

Measurement	Frequency	Expanded Uncertainty (k=2) ( $\pm$ )
Conducted Emissions at mains ports	150kHz ~ 30MHz	2.79 dB
Radiated Emissions up to 1 GHz	9kHz ~ 30MHz	3.04 dB
	30MHz ~ 200MHz	3.59 dB
	200MHz ~ 1000MHz	3.60 dB
Radiated Emissions above 1 GHz	1GHz ~ 18GHz	2.29 dB
	18GHz ~ 40GHz	2.29 dB

### 2.2 Modification Record

There were no modifications required for compliance.

### 3 General Information

#### 3.1 General Description of EUT

Product	Nuclias Cloud-Managed AC1900 Wave 2 Access Point
Brand	D-Link Corporation
Test Model	DBA-2520P
Sample Status	Engineering sample
Power Supply Rating	12Vdc (From adapter) 54Vdc (From PoE)
Modulation Type	256QAM, 64QAM, 16QAM, QPSK, BPSK
Modulation Technology	OFDM
Transfer Rate	802.11a: 54/48/36/24/18/12/9/6Mbps 802.11n: up to 450Mbps 802.11ac: up to 1300Mbps
Operating Frequency	5260 ~ 5320MHz, 5500 ~ 5720MHz
Number of Channel	5260 ~ 5320MHz: 802.11a, 802.11n (HT20), 802.11ac (VHT20): 4 802.11n (HT40), 802.11ac (VHT40): 2 802.11ac (VHT80): 1 5500 ~ 5720MHz: 802.11a, 802.11n (HT20), 802.11ac (VHT20): 12 802.11n (HT40), 802.11ac (VHT40): 6 802.11ac (VHT80): 3
Output Power	CDD Mode: 5260 ~ 5320MHz: 222.574mW 5500 ~ 5720MHz: 241.857mW Beamforming Mode: 5260 ~ 5320MHz: 74.212mW 5500 ~ 5720MHz: 80.642mW
Antenna Type	Refer to Note
Antenna Connector	Refer to Note
Accessory Device	Adapter
Cable Supplied	NA

**Note:**

1. This report is prepared for FCC class II permissive change. The differences compared with the original report (BV CPS report no.: RF190726C11-1) are adding 5.26GHz to 5.32GHz and 5.50GHz to 5.72GHz by software.
2. The EUT incorporates a MIMO function. Physically, the EUT provides 3 completed transmitter and 3 receivers.

Modulation Mode	Beamforming Mode	TX Function
802.11a	Not Support	3TX
802.11n (HT20)	Support	3TX
802.11n (HT40)	Support	3TX
802.11ac (VHT20)	Support	3TX
802.11ac (VHT40)	Support	3TX
802.11ac (VHT80)	Support	3TX

\* The modulation and bandwidth are similar for 802.11n mode for HT20/HT40 and 802.11ac mode for VHT20/VHT40. After pre-testing, 802.11ac (VHT20/VHT40) power is lower than 802.11n (HT20/HT40), therefore 802.11n (HT20/HT40) is the worst case to representative mode in test report. (Final test mode refer section 3.2.1)

\* For 802.11n, CDD mode and Beamforming mode are presented in power output test item. For other test items, CDD mode is the worst case for final tests after pretesting.

3. The EUT uses following antennas.

Type	Connector	Ant. Gain (dBi)						
		2400 MHz	2450 MHz	2500 MHz	5150 MHz	5350 MHz	5725 MHz	5825 MHz
PIFA	I-pex(MHF)	3	3	3	4	4	4	4

4. The EUT consumes power from the following Adapters and PoE.

Adapter 1	
Brand	Channel Well Technology
Model	2ABL030F US
Input Power	100-240Vac, 50-60Hz, 1.0A
Output Power	12Vdc / 2.5A
Power Cord	1.2m non-shielded power cord without core

Adapter 2	
Brand	Asian Power Devices Inc.
Model	WA-30J12R
Input Power	100-240Vac~, 50-60Hz, 0.9A
Output Power	12Vdc / 2.5A
Power Cord	1.2m non-shielded power cord without core

PoE (Support unit)	
Brand	LEADER ELECTRONICS INC.
Model	NU90-J540167-I1
Input Power	100-240Vac~, 50-60Hz, 1.2A
Output Power	54Vdc / 1.67A

### 3.2 Description of Test Modes

For 5260 ~ 5320MHz:

4 channels are provided for 802.11a, 802.11n (HT20), 802.11ac (VHT20):

Channel	Frequency	Channel	Frequency
52	5260 MHz	60	5300 MHz
56	5280 MHz	64	5320 MHz

2 channels are provided for 802.11n (HT40), 802.11ac (VHT40):

Channel	Frequency	Channel	Frequency
54	5270 MHz	62	5310 MHz

1 channel is provided for 802.11ac (VHT80):

Channel	Frequency
58	5290MHz

For 5500 ~ 5720MHz:

12 channels are provided for 802.11a, 802.11n (HT20), 802.11ac (VHT20):

Channel	Frequency	Channel	Frequency
100	5500 MHz	124	5620 MHz
104	5520 MHz	128	5640 MHz
108	5540 MHz	132	5660 MHz
112	5560 MHz	136	5680 MHz
116	5580 MHz	140	5700 MHz
120	5600 MHz	144	5720 MHz

6 channels are provided for 802.11n (HT40), 802.11ac (VHT40):

Channel	Frequency	Channel	Frequency
102	5510 MHz	126	5630 MHz
110	5550 MHz	134	5670 MHz
118	5590 MHz	142	5710 MHz

3 channels are provided for 802.11ac (VHT80):

Channel	Frequency	Channel	Frequency
106	5530 MHz	122	5610 MHz
138	5690 MHz		

### 3.2.1 Test Mode Applicability and Tested Channel Detail

EUT Configure Mode	Applicable to				Description
	RE $\geq$ 1G	RE<1G	PLC	APCM	
A	√	√	√	√	Power from adapter 1
B	-	√	√	-	Power from adapter 2
C	-	√	√	-	Power from PoE

Where RE $\geq$ 1G: Radiated Emission above 1GHz & Bandedge Measurement  
 RE<1G: Radiated Emission below 1GHz  
 PLC: Power Line Conducted Emission  
 APCM: Antenna Port Conducted Measurement

Note:

1. The EUT had been pre-tested on the positioned of each 3 axis. The worst case was found when positioned on **Z-plane**.
2. "-": Means no effect.
3. Radiated emission (below 1GHz) and power line conducted emission test items chosen the worst maximum power.

#### **Radiated Emission Test (Above 1GHz):**

- Pre-Scan has been conducted to determine the worst-case mode from all possible combinations between available modulations, data rates and antenna ports (if EUT with antenna diversity architecture).
- Following channel(s) was (were) selected for the final test as listed below.

EUT Configure Mode	Mode	Frequency Band (MHz)	Available Channel	Tested Channel	Modulation Technology	Data Rate (Mbps)
A	802.11a	5260-5320	52 to 64	52, 60, 64	OFDM	6.0
	802.11n (HT20)		52 to 64	52, 60, 64	OFDM	6.5
	802.11n (HT40)		54 to 62	54, 62	OFDM	13.5
	802.11ac (VHT80)		58	58	OFDM	29.3
A	802.11a	5500-5720	100 to 144	100, 116, 140, 144	OFDM	6.0
	802.11n (HT20)		100 to 144	100, 116, 140, 144	OFDM	6.5
	802.11n (HT40)		102 to 142	102, 110, 134, 142	OFDM	13.5
	802.11ac (VHT80)		106 to 138	106, 122, 138	OFDM	29.3

#### **Radiated Emission Test (Below 1GHz):**

- Pre-Scan has been conducted to determine the worst-case mode from all possible combinations between available modulations, data rates and antenna ports (if EUT with antenna diversity architecture).
- Following channel(s) was (were) selected for the final test as listed below.

EUT Configure Mode	Mode	Frequency Band (MHz)	Available Channel	Tested Channel	Modulation Technology	Data Rate (Mbps)
A, B, C	802.11n (HT40)	5260-5320	54 to 62	102	OFDM	13.5
	802.11n (HT40)	5500-5720	102 to 142		OFDM	13.5

#### **Power Line Conducted Emission Test:**

- Pre-Scan has been conducted to determine the worst-case mode from all possible combinations between available modulations, data rates and antenna ports (if EUT with antenna diversity architecture).
- Following channel(s) was (were) selected for the final test as listed below.

EUT Configure Mode	Mode	Frequency Band (MHz)	Available Channel	Tested Channel	Modulation Technology	Data Rate (Mbps)
A, B, C	802.11n (HT40)	5260-5320	54 to 62	102	OFDM	13.5
	802.11n (HT40)	5500-5720	102 to 142		OFDM	13.5

**Antenna Port Conducted Measurement:**

- This item includes all test value of each mode, but only includes spectrum plot of worst value of each mode.
- Pre-Scan has been conducted to determine the worst-case mode from all possible combinations between available modulations, data rates and antenna ports (if EUT with antenna diversity architecture).
- Following channel(s) was (were) selected for the final test as listed below.

EUT Configure Mode	Mode	Frequency Band (MHz)	Available Channel	Tested Channel	Modulation Technology	Data Rate (Mbps)
A	802.11a	5260-5320	52 to 64	52, 60, 64	OFDM	6.0
	802.11n (HT20)		52 to 64	52, 60, 64	OFDM	6.5
	802.11n (HT40)		54 to 62	54, 62	OFDM	13.5
	802.11ac (VHT80)		58	58	OFDM	29.3
A	802.11a	5500-5720	100 to 144	100, 116, 140, 144	OFDM	6.0
	802.11n (HT20)		100 to 144	100, 116, 140, 144	OFDM	6.5
	802.11n (HT40)		102 to 142	102, 110, 134, 142	OFDM	13.5
	802.11ac (VHT80)		106 to 138	106, 122, 138	OFDM	29.3

**Test Condition:**

Applicable to	Environmental Conditions	Input Power	Tested by
RE $\geq$ 1G	25 deg. C, 70% RH	120Vac, 60Hz	Noah Chang
RE<1G	25 deg. C, 70% RH 24 deg. C, 68% RH	120Vac, 60Hz 54Vdc	Noah Chang, Greg Lin
PLC	25 deg. C, 75% RH	120Vac, 60Hz 54Vdc	Noah Chang, Jones Chang
APCM	25 deg. C, 60% RH	120Vac, 60Hz	Jisyong Wang

### 3.3 Duty Cycle of Test Signal

Duty cycle of test signal is < 98%, duty factor is required.

802.11a: Duty cycle =  $2.035/2.140 = 0.951$ , Duty factor =  $10 * \log(1/0.951) = 0.22$

802.11n (HT20): Duty cycle =  $4.963/5.075 = 0.978$ , Duty factor =  $10 * \log(1/0.978) = 0.10$

802.11n (HT40): Duty cycle =  $2.410/2.520 = 0.956$ , Duty factor =  $10 * \log(1/0.956) = 0.19$

802.11ac (VHT80): Duty cycle =  $1.130/1.217 = 0.929$ , Duty factor =  $10 * \log(1/0.929) = 0.32$

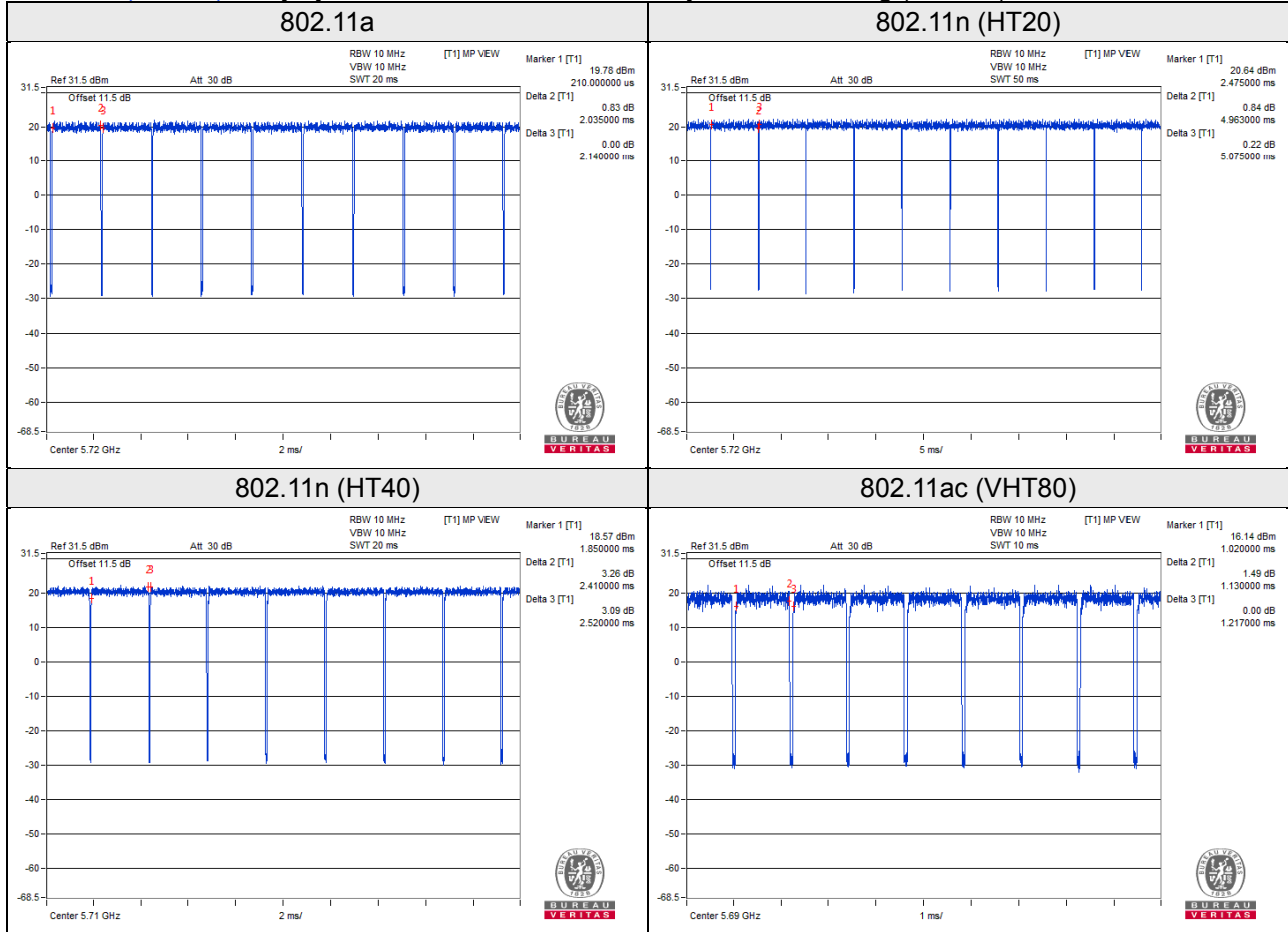

### 3.4 Description of Support Units

The EUT has been tested as an independent unit together with other necessary accessories or support units. The following support units or accessories were used to form a representative test configuration during the tests.

ID	Product	Brand	Model No.	Serial No.	FCC ID	Remarks
A.	PoE	LEADER ELECTRONICS INC.	NU90-J540167-11	NA	NA	Provided by client

ID	Descriptions	Qty.	Length (m)	Shielding (Yes/No)	Cores (Qty.)	Remarks
1.	RJ45 cable	1	10	N	0	Cat5e

#### 3.4.1 Configuration of System under Test

Mode A, B

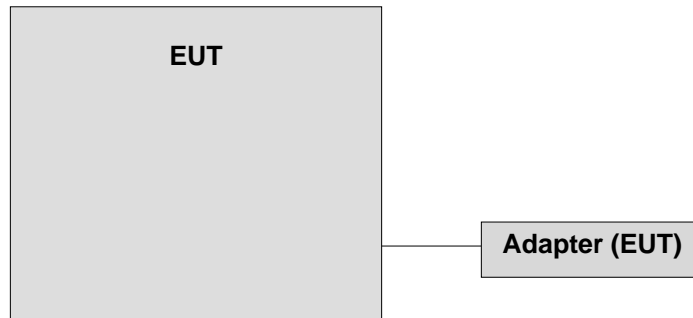

Mode C

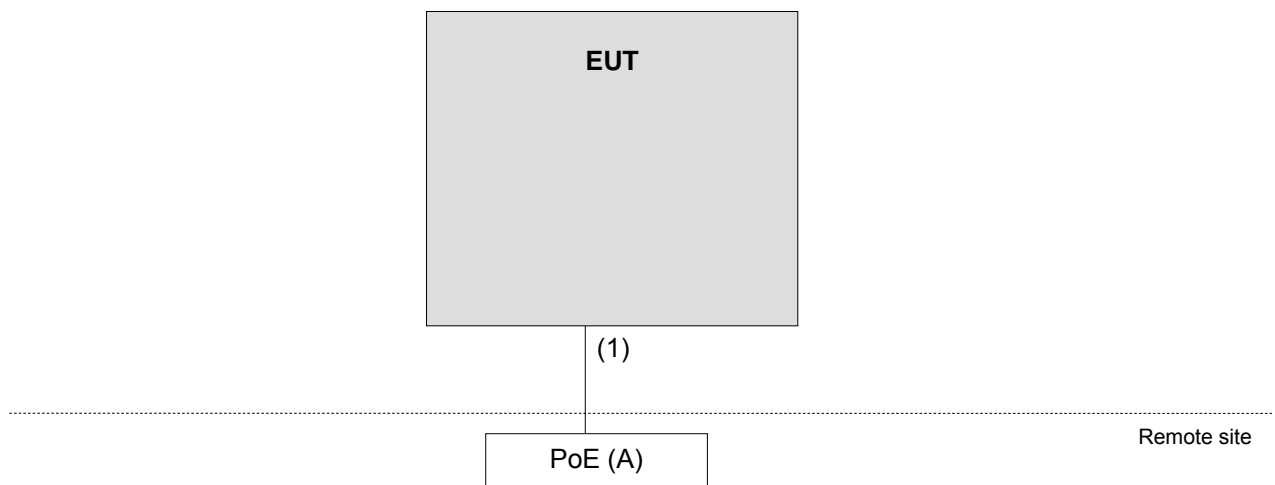

### 3.5 General Description of Applied Standards and References

The EUT is a RF Product. According to the specifications of the manufacturer, it must comply with the requirements of the following standards and references:

**Test standard:**

**FCC Part 15, Subpart E (15.407)**

ANSI C63.10:2013

All test items have been performed and recorded as per the above standards.

**References Test Guidance:**

**KDB 789033 D02 General UNII Test Procedure New Rules v02r01**

**KDB 662911 D01 Multiple Transmitter Output v02r01**

All test items have been performed as a reference to the above KDB test guidance.

## 4 Test Types and Results

### 4.1 Radiated Emission and Bandedge Measurement

#### 4.1.1 Limits of Radiated Emission and Bandedge Measurement

Radiated emissions which fall in the restricted bands must comply with the radiated emission limits specified as below table.

Frequencies (MHz)	Field Strength (microvolts/meter)	Measurement Distance (meters)
0.009 ~ 0.490	2400/F(kHz)	300
0.490 ~ 1.705	24000/F(kHz)	30
1.705 ~ 30.0	30	30
30 ~ 88	100	3
88 ~ 216	150	3
216 ~ 960	200	3
Above 960	500	3

Note:

1. The lower limit shall apply at the transition frequencies.
2. Emission level (dBuV/m) = 20 log Emission level (uV/m).
3. For frequencies above 1000MHz, the field strength limits are based on average detector, however, the peak field strength of any emission shall not exceed the maximum permitted average limits, specified above by more than 20dB under any condition of modulation.

Limits of unwanted emission out of the restricted bands

Applicable To		Limit	
789033 D02 General UNII Test Procedure New Rules v02r01		Field Strength at 3m	
		PK: 74 (dBuV/m)	AV: 54 (dBuV/m)
Frequency Band	Applicable To	EIRP Limit	Equivalent Field Strength at 3m
5150~5250 MHz	15.407(b)(1)	PK: -27 (dBm/MHz)	PK: 68.2(dBuV/m)
5250~5350 MHz	15.407(b)(2)		
5470~5725 MHz	15.407(b)(3)		
5725~5850 MHz	<input checked="" type="checkbox"/> 15.407(b)(4)(i)	PK: -27 (dBm/MHz) <sup>*1</sup> PK: 10 (dBm/MHz) <sup>*2</sup> PK: 15.6 (dBm/MHz) <sup>*3</sup> PK: 27 (dBm/MHz) <sup>*4</sup>	PK: 68.2(dBuV/m) <sup>*1</sup> PK: 105.2 (dBuV/m) <sup>*2</sup> PK: 110.8(dBuV/m) <sup>*3</sup> PK: 122.2 (dBuV/m) <sup>*4</sup>
	<input type="checkbox"/> 15.407(b)(4)(ii)	Emission limits in section 15.247(d)	
<sup>*1</sup> beyond 75 MHz or more above of the band edge.		<sup>*2</sup> below the band edge increasing linearly to 10 dBm/MHz at 25 MHz above.	
<sup>*3</sup> below the band edge increasing linearly to a level of 15.6 dBm/MHz at 5 MHz above.		<sup>*4</sup> from 5 MHz above or below the band edge increasing linearly to a level of 27 dBm/MHz at the band edge.	

Note: The following formula is used to convert the equipment isotropic radiated power (eirp) to field strength:

$$E = \frac{1000000 \sqrt{30 P}}{3} \quad \mu\text{V/m, where } P \text{ is the eirp (Watts).}$$

#### 4.1.2 Test Instruments

Description & Manufacturer	Model No.	Serial No.	Date of Calibration	Due Date of Calibration
Test Receiver KEYSIGHT	N9038A	MY55420137	Apr. 15, 2019	Apr. 14, 2020
Spectrum Analyzer ROHDE & SCHWARZ	FSP40	100039	Jun. 12, 2019	Jun. 11, 2020
Spectrum Analyzer ROHDE & SCHWARZ	FSV40	100980	May 07, 2019	May 06, 2020
BILOG Antenna SCHWARZBECK	VULB9168	9168-160	Nov. 07, 2019	Nov. 06, 2020
HORN Antenna SCHWARZBECK	BBHA 9120 D	9120D-1169	Nov. 25, 2018	Nov. 24, 2019
			Nov. 24, 2019	Nov. 23, 2020
HORN Antenna SCHWARZBECK	BBHA 9170	BBHA9170241	Nov. 25, 2018	Nov. 24, 2019
			Nov. 24, 2019	Nov. 23, 2020
Loop Antenna TESEQ	HLA 6121	45745	Jul. 01, 2019	Jun. 30, 2020
Preamplifier Agilent (Below 1GHz)	8447D	2944A10638	Jul. 11, 2019	Jul. 10, 2020
Preamplifier Agilent (Above 1GHz)	8449B	3008A02367	Feb. 19, 2019	Feb. 18, 2020
RF signal cable HUBER+SUHNER&EMCI	SUCOFLEX 104 & EMC104-SM-SM80 00	CABLE-CH9-02 (248780+171006)	Jan. 19, 2019	Jan. 18, 2020
RF signal cable HUBER+SUHNER	SUCOFLEX 104	CABLE-CH9-(2507 95/4)	Jul. 11, 2019	Jul. 10, 2020
RF signal cable WOKEN	8D-FB	Cable-CH9-01	Jul. 30, 2019	Jul. 29, 2020
Software BV ADT	ADT_Radiated_ V7.6.15.9.5	NA	NA	NA
Antenna Tower EMCO	2070/2080	512.835.4684	NA	NA
Turn Table EMCO	2087-2.03	NA	NA	NA
Antenna Tower & Turn BV ADT	AT100	AT93021705	NA	NA
Turn Table BV ADT	TT100	TT93021705	NA	NA
Turn Table Controller BV ADT	SC100	SC93021705	NA	NA
Boresight Antenna Fixture	FBA-01	FBA-SIP01	NA	NA
Pre-amplifier (18GHz-40GHz) EMC	EMC184045B	980175	Sep. 05, 2019	Sep. 04, 2020
USB Wideband Power Sensor KEYSIGHT	U2021XA	MY55050005/MY5 5190004/MY55190 007/MY55210005	Jul. 15, 2019	Jul. 14, 2020
Peak Power Analyzer KEYSIGHT (Support 8TX and 160MHz Bandwidth)	8990B	MY51000485	Jan. 14, 2019	Jan. 13, 2020

Note: 1. The calibration interval of the above test instruments is 12 months and the calibrations are traceable to NML/ROC and NIST/USA.  
2. The test was performed in HwaYa Chamber 9.

### 4.1.3 Test Procedures

#### For Radiated emission below 30MHz

- a. The EUT was placed on the top of a rotating table 0.8 meters above the ground at a 3 meter chamber room. The table was rotated 360 degrees to determine the position of the highest radiation.
- b. The EUT was set 3 meters away from the interference-receiving antenna, which was mounted on the top of a variable-height antenna tower.
- c. Parallel, perpendicular, and ground-parallel orientations of the antenna are set to make the measurement.
- d. For each suspected emission, the EUT was arranged to its worst case and the rotatable table was turned from 0 degrees to 360 degrees to find the maximum reading.
- e. The test-receiver system was set to Quasi-Peak Detect Function and Specified Bandwidth with Maximum Hold Mode.

Note:

1. The resolution bandwidth and video bandwidth of test receiver/spectrum analyzer is 9kHz at frequency below 30MHz.

#### For Radiated emission above 30MHz

- a. The EUT was placed on the top of a rotating table 0.8 meters (for 30MHz ~ 1GHz) / 1.5 meters (for above 1GHz) above the ground at 3 meter chamber room for test. The table was rotated 360 degrees to determine the position of the highest radiation.
- b. The EUT was set 3 meters away from the interference-receiving antenna, which was mounted on the top of a variable-height antenna tower.
- c. The height of antenna is varied from one meter to four meters above the ground to determine the maximum value of the field strength. Both horizontal and vertical polarizations of the antenna are set to make the measurement.
- d. For each suspected emission, the EUT was arranged to its worst case and then the antenna was tuned to heights from 1 meter to 4 meters and the rotatable table was turned from 0 degrees to 360 degrees to find the maximum reading.
- e. The test-receiver system was set to quasi-peak detect function and specified bandwidth with maximum hold mode when the test frequency is below 1 GHz.
- f. The test-receiver system was set to peak and average detect function and specified bandwidth with maximum hold mode when the test frequency is above 1 GHz. If the peak reading value also meets average limit, measurement with the average detector is unnecessary.

Note:

1. The resolution bandwidth and video bandwidth of test receiver/spectrum analyzer is 120kHz for Quasi-peak detection (QP) at frequency below 1GHz.
2. The resolution bandwidth of test receiver/spectrum analyzer is 1 MHz and the video bandwidth is 3 MHz for Peak detection (PK) at frequency above 1GHz.
3. The resolution bandwidth of test receiver/spectrum analyzer is 1MHz and the video bandwidth is  $\geq 1/T$  (Duty cycle < 98%) or 10Hz (Duty cycle  $\geq 98\%$ ) for Average detection (AV) at frequency above 1GHz. (802.11a: RBW = 1MHz, VBW = 1kHz; 802.11n (HT20): RBW = 1MHz, VBW = 1kHz; 802.11n (HT40): RBW = 1MHz, VBW = 1kHz; 802.11ac (VHT80): RBW = 1MHz, VBW = 1kHz)
4. All modes of operation were investigated and the worst-case emissions are reported.

### 4.1.4 Deviation from Test Standard

No deviation.

#### 4.1.5 Test Setup

##### For Radiated emission below 30MHz

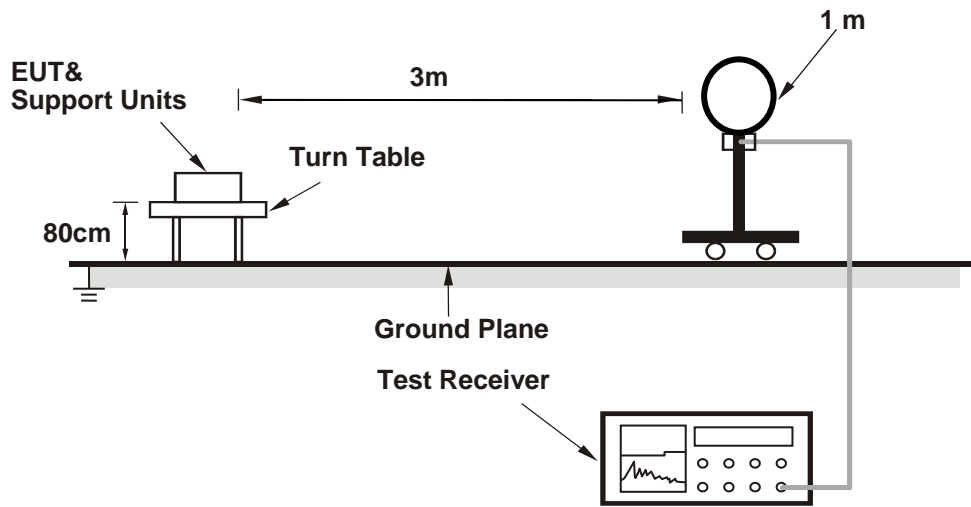

##### For Radiated emission 30MHz to 1GHz

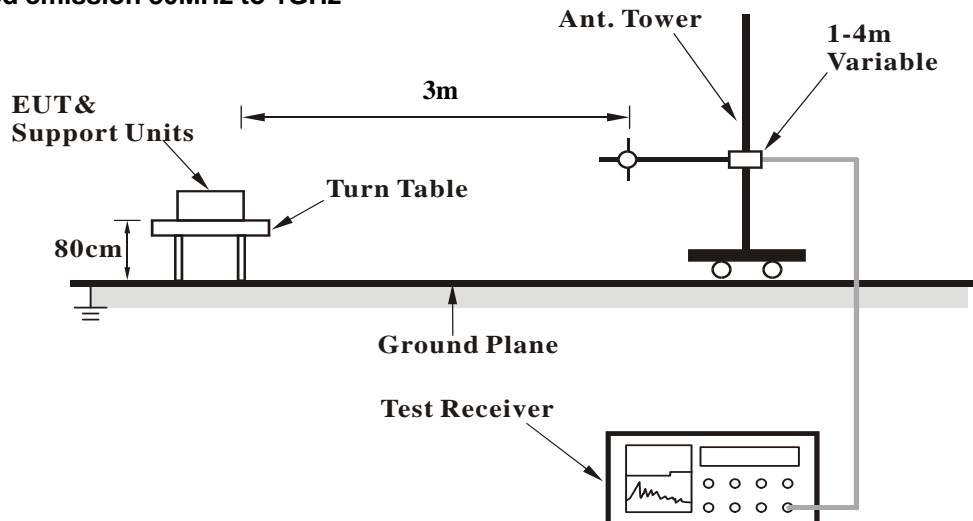

### For Radiated emission above 1GHz

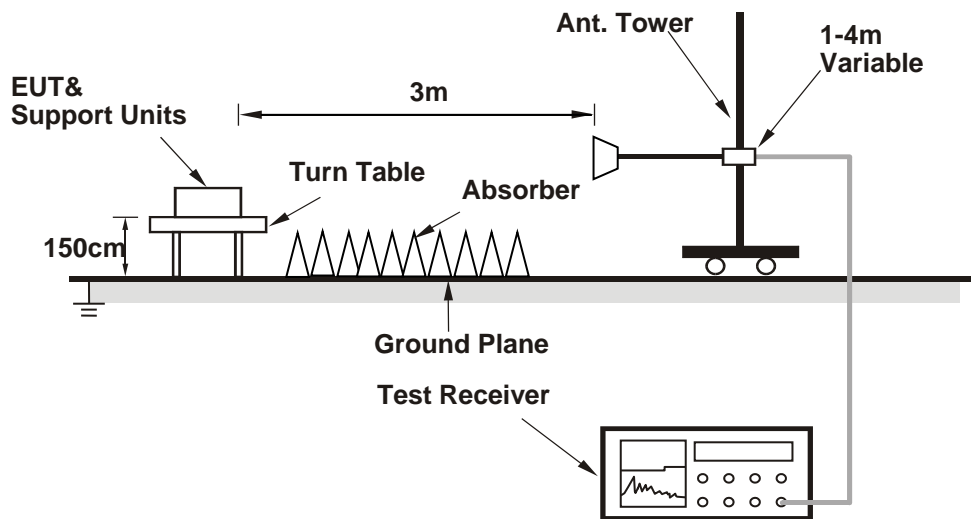

For the actual test configuration, please refer to the attached file (Test Setup Photo).

#### 4.1.6 EUT Operating Conditions

- a. Placed the EUT on the testing table.
- b. The EUT ran a test program (QRCT 3.0.303.0) to enable EUT under transmission condition continuously at specific channel frequency.

#### 4.1.7 Test Results

Above 1GHz data:

802.11a

CHANNEL	TX Channel 52	DETECTOR FUNCTION	Peak (PK) Average (AV)
FREQUENCY RANGE	1GHz ~ 40GHz		

ANTENNA POLARITY & TEST DISTANCE: HORIZONTAL AT 3 M								
NO.	FREQ. (MHz)	EMISSION LEVEL (dBuV/m)	LIMIT (dBuV/m)	MARGIN (dB)	ANTENNA HEIGHT (m)	TABLE ANGLE (Degree)	RAW VALUE (dBuV)	CORRECTION FACTOR (dB/m)
1	5150.00	55.5 PK	74.0	-18.5	2.15 H	302	49.1	6.4
2	5150.00	41.8 AV	54.0	-12.2	2.15 H	302	35.4	6.4
3	*5260.00	119.4 PK			2.06 H	298	82.0	37.4
4	*5260.00	109.0 AV			2.06 H	298	71.6	37.4
5	#10520.00	56.8 PK	68.2	-11.4	2.11 H	159	39.8	17.0
ANTENNA POLARITY & TEST DISTANCE: VERTICAL AT 3 M								
NO.	FREQ. (MHz)	EMISSION LEVEL (dBuV/m)	LIMIT (dBuV/m)	MARGIN (dB)	ANTENNA HEIGHT (m)	TABLE ANGLE (Degree)	RAW VALUE (dBuV)	CORRECTION FACTOR (dB/m)
1	5150.00	55.3 PK	74.0	-18.7	1.52 V	352	48.9	6.4
2	5150.00	41.6 AV	54.0	-12.4	1.52 V	352	35.2	6.4
3	*5260.00	113.8 PK			1.11 V	356	76.4	37.4
4	*5260.00	103.7 AV			1.11 V	356	66.3	37.4
5	#10520.00	56.5 PK	68.2	-11.7	1.50 V	32	39.5	17.0

Remarks:

1. Emission Level(dBuV/m) = Raw Value(dBuV) + Correction Factor(dB/m).
2. Correction Factor(dB/m) = Antenna Factor(dB/m) + Cable Factor(dB) – Pre-Amplifier Factor(dB).
3. Margin value = Emission Level – Limit value.
4. The other emission levels were very low against the limit.
5. " \* ": Fundamental frequency.
6. " # ": The radiated frequency is out of the restricted band.

CHANNEL	TX Channel 60	DETECTOR FUNCTION	Peak (PK) Average (AV)
FREQUENCY RANGE	1GHz ~ 40GHz		

**ANTENNA POLARITY & TEST DISTANCE: HORIZONTAL AT 3 M**

NO.	FREQ. (MHz)	EMISSION LEVEL (dBuV/m)	LIMIT (dBuV/m)	MARGIN (dB)	ANTENNA HEIGHT (m)	TABLE ANGLE (Degree)	RAW VALUE (dBuV)	CORRECTION FACTOR (dB/m)
1	*5300.00	119.7 PK			1.82 H	308	82.3	37.4
2	*5300.00	109.3 AV			1.82 H	308	71.9	37.4
3	10600.00	57.9 PK	74.0	-16.1	2.12 H	256	40.5	17.4
4	10600.00	44.7 AV	54.0	-9.3	2.12 H	256	27.3	17.4

**ANTENNA POLARITY & TEST DISTANCE: VERTICAL AT 3 M**

NO.	FREQ. (MHz)	EMISSION LEVEL (dBuV/m)	LIMIT (dBuV/m)	MARGIN (dB)	ANTENNA HEIGHT (m)	TABLE ANGLE (Degree)	RAW VALUE (dBuV)	CORRECTION FACTOR (dB/m)
1	*5300.00	114.7 PK			2.00 V	358	77.3	37.4
2	*5300.00	104.3 AV			2.00 V	358	66.9	37.4
3	10600.00	57.6 PK	74.0	-16.4	2.35 V	258	40.2	17.4
4	10600.00	44.5 AV	54.0	-9.5	2.35 V	258	27.1	17.4

**Remarks:**

1. Emission Level(dBuV/m) = Raw Value(dBuV) + Correction Factor(dB/m).
2. Correction Factor(dB/m) = Antenna Factor(dB/m) + Cable Factor(dB) – Pre-Amplifier Factor(dB).
3. Margin value = Emission Level – Limit value.
4. The other emission levels were very low against the limit.
5. " \* ": Fundamental frequency.

CHANNEL	TX Channel 64	DETECTOR FUNCTION	Peak (PK) Average (AV)
FREQUENCY RANGE	1GHz ~ 40GHz		

**ANTENNA POLARITY & TEST DISTANCE: HORIZONTAL AT 3 M**

NO.	FREQ. (MHz)	EMISSION LEVEL (dBuV/m)	LIMIT (dBuV/m)	MARGIN (dB)	ANTENNA HEIGHT (m)	TABLE ANGLE (Degree)	RAW VALUE (dBuV)	CORRECTION FACTOR (dB/m)
1	*5320.00	119.8 PK			1.55 H	308	82.4	37.4
2	*5320.00	109.6 AV			1.55 H	308	72.2	37.4
3	5350.00	63.4 PK	74.0	-10.6	2.30 H	318	57.1	6.3
4	5350.00	52.0 AV	54.0	-2.0	2.30 H	318	45.7	6.3
5	10640.00	58.0 PK	74.0	-16.0	1.52 H	221	40.5	17.5
6	10640.00	44.7 AV	54.0	-9.3	1.52 H	221	27.2	17.5

**ANTENNA POLARITY & TEST DISTANCE: VERTICAL AT 3 M**

NO.	FREQ. (MHz)	EMISSION LEVEL (dBuV/m)	LIMIT (dBuV/m)	MARGIN (dB)	ANTENNA HEIGHT (m)	TABLE ANGLE (Degree)	RAW VALUE (dBuV)	CORRECTION FACTOR (dB/m)
1	*5320.00	114.8 PK			1.51 V	352	77.4	37.4
2	*5320.00	104.6 AV			1.51 V	352	67.2	37.4
3	5350.00	57.8 PK	74.0	-16.2	1.59 V	359	51.5	6.3
4	5350.00	46.5 AV	54.0	-7.5	1.59 V	359	40.2	6.3
5	10640.00	57.7 PK	74.0	-16.3	2.50 V	156	40.2	17.5
6	10640.00	44.5 AV	54.0	-9.5	2.50 V	156	27.0	17.5

Remarks:

1. Emission Level(dBuV/m) = Raw Value(dBuV) + Correction Factor(dB/m).
2. Correction Factor(dB/m) = Antenna Factor(dB/m) + Cable Factor(dB) – Pre-Amplifier Factor(dB).
3. Margin value = Emission Level – Limit value.
4. The other emission levels were very low against the limit.
5. " \* ": Fundamental frequency.

CHANNEL	TX Channel 100	DETECTOR FUNCTION	Peak (PK) Average (AV)
FREQUENCY RANGE	1GHz ~ 40GHz		

**ANTENNA POLARITY & TEST DISTANCE: HORIZONTAL AT 3 M**

NO.	FREQ. (MHz)	EMISSION LEVEL (dBuV/m)	LIMIT (dBuV/m)	MARGIN (dB)	ANTENNA HEIGHT (m)	TABLE ANGLE (Degree)	RAW VALUE (dBuV)	CORRECTION FACTOR (dB/m)
1	5460.00	58.5 PK	74.0	-15.5	1.30 H	309	52.0	6.5
2	5460.00	44.8 AV	54.0	-9.2	1.30 H	309	38.3	6.5
3	#5470.00	63.9 PK	68.2	-4.3	1.50 H	302	57.3	6.6
4	*5500.00	119.0 PK			1.36 H	303	81.1	37.9
5	*5500.00	109.1 AV			1.36 H	303	71.2	37.9
6	11000.00	58.6 PK	74.0	-15.4	2.05 H	211	40.5	18.1
7	11000.00	45.3 AV	54.0	-8.7	2.05 H	211	27.2	18.1

**ANTENNA POLARITY & TEST DISTANCE: VERTICAL AT 3 M**

NO.	FREQ. (MHz)	EMISSION LEVEL (dBuV/m)	LIMIT (dBuV/m)	MARGIN (dB)	ANTENNA HEIGHT (m)	TABLE ANGLE (Degree)	RAW VALUE (dBuV)	CORRECTION FACTOR (dB/m)
1	5460.00	56.3 PK	74.0	-17.7	2.10 V	359	49.8	6.5
2	5460.00	44.0 AV	54.0	-10.0	2.10 V	359	37.5	6.5
3	#5470.00	56.8 PK	68.2	-11.4	1.44 V	353	50.2	6.6
4	*5500.00	114.0 PK			1.56 V	350	76.1	37.9
5	*5500.00	104.1 AV			1.56 V	350	66.2	37.9
6	11000.00	58.3 PK	74.0	-15.7	3.05 V	100	40.2	18.1
7	11000.00	45.1 AV	54.0	-8.9	3.05 V	100	27.0	18.1

Remarks:

1. Emission Level(dBuV/m) = Raw Value(dBuV) + Correction Factor(dB/m).
2. Correction Factor(dB/m) = Antenna Factor(dB/m) + Cable Factor(dB) – Pre-Amplifier Factor(dB).
3. Margin value = Emission Level – Limit value.
4. The other emission levels were very low against the limit.
5. " \* ": Fundamental frequency.
6. " # ": The radiated frequency is out of the restricted band.

CHANNEL	TX Channel 116	DETECTOR FUNCTION	Peak (PK) Average (AV)
FREQUENCY RANGE	1GHz ~ 40GHz		

**ANTENNA POLARITY & TEST DISTANCE: HORIZONTAL AT 3 M**

NO.	FREQ. (MHz)	EMISSION LEVEL (dBuV/m)	LIMIT (dBuV/m)	MARGIN (dB)	ANTENNA HEIGHT (m)	TABLE ANGLE (Degree)	RAW VALUE (dBuV)	CORRECTION FACTOR (dB/m)
1	*5580.00	118.1 PK			1.37 H	326	80.2	37.9
2	*5580.00	107.8 AV			1.37 H	326	69.9	37.9
3	11160.00	58.4 PK	74.0	-15.6	3.15 H	333	40.5	17.9
4	11160.00	45.2 AV	54.0	-8.8	3.15 H	333	27.3	17.9

**ANTENNA POLARITY & TEST DISTANCE: VERTICAL AT 3 M**

NO.	FREQ. (MHz)	EMISSION LEVEL (dBuV/m)	LIMIT (dBuV/m)	MARGIN (dB)	ANTENNA HEIGHT (m)	TABLE ANGLE (Degree)	RAW VALUE (dBuV)	CORRECTION FACTOR (dB/m)
1	*5580.00	113.1 PK			2.00 V	356	75.2	37.9
2	*5580.00	103.0 AV			2.00 V	356	65.1	37.9
3	11160.00	58.1 PK	74.0	-15.9	2.05 V	159	40.2	17.9
4	11160.00	45.0 AV	54.0	-9.0	2.05 V	159	27.1	17.9

**Remarks:**

1. Emission Level(dBuV/m) = Raw Value(dBuV) + Correction Factor(dB/m).
2. Correction Factor(dB/m) = Antenna Factor(dB/m) + Cable Factor(dB) – Pre-Amplifier Factor(dB).
3. Margin value = Emission Level – Limit value.
4. The other emission levels were very low against the limit.
5. " \* ": Fundamental frequency.

CHANNEL	TX Channel 140	DETECTOR FUNCTION	Peak (PK) Average (AV)
FREQUENCY RANGE	1GHz ~ 40GHz		

**ANTENNA POLARITY & TEST DISTANCE: HORIZONTAL AT 3 M**

NO.	FREQ. (MHz)	EMISSION LEVEL (dBuV/m)	LIMIT (dBuV/m)	MARGIN (dB)	ANTENNA HEIGHT (m)	TABLE ANGLE (Degree)	RAW VALUE (dBuV)	CORRECTION FACTOR (dB/m)
1	*5700.00	118.0 PK			1.44 H	301	79.9	38.1
2	*5700.00	107.8 AV			1.44 H	301	69.7	38.1
3	#5725.00	63.3 PK	68.2	-4.9	1.49 H	300	56.3	7.0
4	11400.00	59.0 PK	74.0	-15.0	2.09 H	316	40.2	18.8
5	11400.00	45.9 AV	54.0	-8.1	2.09 H	316	27.1	18.8

**ANTENNA POLARITY & TEST DISTANCE: VERTICAL AT 3 M**

NO.	FREQ. (MHz)	EMISSION LEVEL (dBuV/m)	LIMIT (dBuV/m)	MARGIN (dB)	ANTENNA HEIGHT (m)	TABLE ANGLE (Degree)	RAW VALUE (dBuV)	CORRECTION FACTOR (dB/m)
1	*5700.00	113.0 PK			1.50 V	356	74.9	38.1
2	*5700.00	102.8 AV			1.50 V	356	64.7	38.1
3	#5725.00	56.5 PK	68.2	-11.7	2.15 V	352	49.5	7.0
4	11400.00	58.7 PK	74.0	-15.3	3.15 V	302	39.9	18.8
5	11400.00	45.7 AV	54.0	-8.3	3.15 V	302	26.9	18.8

Remarks:

1. Emission Level(dBuV/m) = Raw Value(dBuV) + Correction Factor(dB/m).
2. Correction Factor(dB/m) = Antenna Factor(dB/m) + Cable Factor(dB) – Pre-Amplifier Factor(dB).
3. Margin value = Emission Level – Limit value.
4. The other emission levels were very low against the limit.
5. " \* " : Fundamental frequency.
6. " # " : The radiated frequency is out of the restricted band.

CHANNEL	TX Channel 144	DETECTOR FUNCTION	Peak (PK) Average (AV)
FREQUENCY RANGE	1GHz ~ 40GHz		

**ANTENNA POLARITY & TEST DISTANCE: HORIZONTAL AT 3 M**

NO.	FREQ. (MHz)	EMISSION LEVEL (dBuV/m)	LIMIT (dBuV/m)	MARGIN (dB)	ANTENNA HEIGHT (m)	TABLE ANGLE (Degree)	RAW VALUE (dBuV)	CORRECTION FACTOR (dB/m)
1	#5470.00	55.0 PK	68.2	-13.2	1.50 H	305	48.4	6.6
2	*5720.00	117.4 PK			1.29 H	305	79.2	38.2
3	*5720.00	106.6 AV			1.29 H	305	68.4	38.2
4	#5850.00	55.8 PK	68.2	-12.4	1.05 H	309	48.6	7.2
5	11440.00	59.1 PK	74.0	-14.9	3.16 H	152	40.4	18.7
6	11440.00	45.8 AV	54.0	-8.2	3.16 H	152	27.1	18.7

**ANTENNA POLARITY & TEST DISTANCE: VERTICAL AT 3 M**

NO.	FREQ. (MHz)	EMISSION LEVEL (dBuV/m)	LIMIT (dBuV/m)	MARGIN (dB)	ANTENNA HEIGHT (m)	TABLE ANGLE (Degree)	RAW VALUE (dBuV)	CORRECTION FACTOR (dB/m)
1	#5470.00	54.8 PK	68.2	-13.4	1.00 V	356	48.2	6.6
2	*5720.00	112.4 PK			2.10 V	359	74.2	38.2
3	*5720.00	102.3 AV			2.10 V	359	64.1	38.2
4	#5850.00	55.6 PK	68.2	-12.6	1.05 V	339	48.4	7.2
5	11440.00	58.9 PK	74.0	-15.1	1.15 V	105	40.2	18.7
6	11440.00	45.5 AV	54.0	-8.5	1.15 V	105	26.8	18.7

Remarks:

1. Emission Level(dBuV/m) = Raw Value(dBuV) + Correction Factor(dB/m).
2. Correction Factor(dB/m) = Antenna Factor(dB/m) + Cable Factor(dB) – Pre-Amplifier Factor(dB).
3. Margin value = Emission Level – Limit value.
4. The other emission levels were very low against the limit.
5. " \* " : Fundamental frequency.
6. " # " : The radiated frequency is out of the restricted band.

802.11n (HT20)

CHANNEL	TX Channel 52	DETECTOR FUNCTION	Peak (PK) Average (AV)
FREQUENCY RANGE	1GHz ~ 40GHz		

ANTENNA POLARITY & TEST DISTANCE: HORIZONTAL AT 3 M								
NO.	FREQ. (MHz)	EMISSION LEVEL (dBuV/m)	LIMIT (dBuV/m)	MARGIN (dB)	ANTENNA HEIGHT (m)	TABLE ANGLE (Degree)	RAW VALUE (dBuV)	CORRECTION FACTOR (dB/m)
1	5150.00	54.9 PK	74.0	-19.1	2.10 H	315	48.5	6.4
2	5150.00	42.1 AV	54.0	-11.9	2.10 H	315	35.7	6.4
3	*5260.00	120.0 PK			1.75 H	314	82.6	37.4
4	*5260.00	109.0 AV			1.75 H	314	71.6	37.4
5	#10520.00	57.3 PK	68.2	-10.9	2.18 H	211	40.3	17.0

ANTENNA POLARITY & TEST DISTANCE: VERTICAL AT 3 M								
NO.	FREQ. (MHz)	EMISSION LEVEL (dBuV/m)	LIMIT (dBuV/m)	MARGIN (dB)	ANTENNA HEIGHT (m)	TABLE ANGLE (Degree)	RAW VALUE (dBuV)	CORRECTION FACTOR (dB/m)
1	5150.00	54.8 PK	74.0	-19.2	3.21 V	350	48.4	6.4
2	5150.00	42.0 AV	54.0	-12.0	3.21 V	350	35.6	6.4
3	*5260.00	115.0 PK			1.59 V	356	77.6	37.4
4	*5260.00	104.0 AV			1.59 V	356	66.6	37.4
5	#10520.00	57.2 PK	68.2	-11.0	2.11 V	210	40.2	17.0

Remarks:

1. Emission Level(dBuV/m) = Raw Value(dBuV) + Correction Factor(dB/m).
2. Correction Factor(dB/m) = Antenna Factor(dB/m) + Cable Factor(dB) – Pre-Amplifier Factor(dB).
3. Margin value = Emission Level – Limit value.
4. The other emission levels were very low against the limit.
5. " \* ": Fundamental frequency.
6. " # ": The radiated frequency is out of the restricted band.

CHANNEL	TX Channel 60	DETECTOR FUNCTION	Peak (PK) Average (AV)
FREQUENCY RANGE	1GHz ~ 40GHz		

**ANTENNA POLARITY & TEST DISTANCE: HORIZONTAL AT 3 M**

NO.	FREQ. (MHz)	EMISSION LEVEL (dBuV/m)	LIMIT (dBuV/m)	MARGIN (dB)	ANTENNA HEIGHT (m)	TABLE ANGLE (Degree)	RAW VALUE (dBuV)	CORRECTION FACTOR (dB/m)
1	*5300.00	119.6 PK			1.96 H	313	82.2	37.4
2	*5300.00	108.9 AV			1.96 H	313	71.5	37.4
3	10600.00	57.9 PK	74.0	-16.1	3.11 H	152	40.5	17.4
4	10600.00	44.6 AV	54.0	-9.4	3.11 H	152	27.2	17.4

**ANTENNA POLARITY & TEST DISTANCE: VERTICAL AT 3 M**

NO.	FREQ. (MHz)	EMISSION LEVEL (dBuV/m)	LIMIT (dBuV/m)	MARGIN (dB)	ANTENNA HEIGHT (m)	TABLE ANGLE (Degree)	RAW VALUE (dBuV)	CORRECTION FACTOR (dB/m)
1	*5300.00	114.6 PK			1.95 V	352	77.2	37.4
2	*5300.00	102.9 AV			1.95 V	352	65.5	37.4
3	10600.00	57.6 PK	74.0	-16.4	3.02 V	319	40.2	17.4
4	10600.00	44.2 AV	54.0	-9.8	3.02 V	319	26.8	17.4

**Remarks:**

1. Emission Level(dBuV/m) = Raw Value(dBuV) + Correction Factor(dB/m).
2. Correction Factor(dB/m) = Antenna Factor(dB/m) + Cable Factor(dB) – Pre-Amplifier Factor(dB).
3. Margin value = Emission Level – Limit value.
4. The other emission levels were very low against the limit.
5. " \* ": Fundamental frequency.

CHANNEL	TX Channel 64	DETECTOR FUNCTION	Peak (PK) Average (AV)
FREQUENCY RANGE	1GHz ~ 40GHz		

**ANTENNA POLARITY & TEST DISTANCE: HORIZONTAL AT 3 M**

NO.	FREQ. (MHz)	EMISSION LEVEL (dBuV/m)	LIMIT (dBuV/m)	MARGIN (dB)	ANTENNA HEIGHT (m)	TABLE ANGLE (Degree)	RAW VALUE (dBuV)	CORRECTION FACTOR (dB/m)
1	*5320.00	119.9 PK			1.92 H	308	82.5	37.4
2	*5320.00	109.1 AV			1.92 H	308	71.7	37.4
3	5350.00	64.7 PK	74.0	-9.3	1.55 H	310	58.4	6.3
4	5350.00	51.5 AV	54.0	-2.5	1.55 H	310	45.2	6.3
5	10640.00	58.1 PK	74.0	-15.9	1.55 H	159	40.6	17.5
6	10640.00	44.8 AV	54.0	-9.2	1.55 H	159	27.3	17.5

**ANTENNA POLARITY & TEST DISTANCE: VERTICAL AT 3 M**

NO.	FREQ. (MHz)	EMISSION LEVEL (dBuV/m)	LIMIT (dBuV/m)	MARGIN (dB)	ANTENNA HEIGHT (m)	TABLE ANGLE (Degree)	RAW VALUE (dBuV)	CORRECTION FACTOR (dB/m)
1	*5320.00	114.9 PK			1.89 V	356	77.5	37.4
2	*5320.00	104.1 AV			1.89 V	356	66.7	37.4
3	5350.00	55.4 PK	74.0	-18.6	3.15 V	356	49.1	6.3
4	5350.00	43.8 AV	54.0	-10.2	3.15 V	356	37.5	6.3
5	10640.00	57.7 PK	74.0	-16.3	2.52 V	326	40.2	17.5
6	10640.00	44.3 AV	54.0	-9.7	2.52 V	326	26.8	17.5

Remarks:

1. Emission Level(dBuV/m) = Raw Value(dBuV) + Correction Factor(dB/m).
2. Correction Factor(dB/m) = Antenna Factor(dB/m) + Cable Factor(dB) – Pre-Amplifier Factor(dB).
3. Margin value = Emission Level – Limit value.
4. The other emission levels were very low against the limit.
5. " \* ": Fundamental frequency.

CHANNEL	TX Channel 100	DETECTOR FUNCTION	Peak (PK) Average (AV)
FREQUENCY RANGE	1GHz ~ 40GHz		

**ANTENNA POLARITY & TEST DISTANCE: HORIZONTAL AT 3 M**

NO.	FREQ. (MHz)	EMISSION LEVEL (dBuV/m)	LIMIT (dBuV/m)	MARGIN (dB)	ANTENNA HEIGHT (m)	TABLE ANGLE (Degree)	RAW VALUE (dBuV)	CORRECTION FACTOR (dB/m)
1	5460.00	57.5 PK	74.0	-16.5	1.77 H	309	51.0	6.5
2	5460.00	44.6 AV	54.0	-9.4	1.77 H	309	38.1	6.5
3	#5470.00	60.1 PK	68.2	-8.1	1.71 H	298	53.5	6.6
4	*5500.00	118.7 PK			1.73 H	300	80.8	37.9
5	*5500.00	108.2 AV			1.73 H	300	70.3	37.9
6	11000.00	58.4 PK	74.0	-15.6	2.11 H	259	40.3	18.1
7	11000.00	45.2 AV	54.0	-8.8	2.11 H	259	27.1	18.1

**ANTENNA POLARITY & TEST DISTANCE: VERTICAL AT 3 M**

NO.	FREQ. (MHz)	EMISSION LEVEL (dBuV/m)	LIMIT (dBuV/m)	MARGIN (dB)	ANTENNA HEIGHT (m)	TABLE ANGLE (Degree)	RAW VALUE (dBuV)	CORRECTION FACTOR (dB/m)
1	5460.00	56.0 PK	74.0	-18.0	1.77 V	350	49.5	6.5
2	5460.00	43.5 AV	54.0	-10.5	1.77 V	350	37.0	6.5
3	#5470.00	56.7 PK	68.2	-11.5	2.15 V	330	50.1	6.6
4	*5500.00	113.7 PK			1.50 V	356	75.8	37.9
5	*5500.00	103.2 AV			1.50 V	356	65.3	37.9
6	11000.00	58.1 PK	74.0	-15.9	1.52 V	105	40.0	18.1
7	11000.00	44.9 AV	54.0	-9.1	1.52 V	105	26.8	18.1

Remarks:

1. Emission Level(dBuV/m) = Raw Value(dBuV) + Correction Factor(dB/m).
2. Correction Factor(dB/m) = Antenna Factor(dB/m) + Cable Factor(dB) – Pre-Amplifier Factor(dB).
3. Margin value = Emission Level – Limit value.
4. The other emission levels were very low against the limit.
5. " \* ": Fundamental frequency.
6. " # ": The radiated frequency is out of the restricted band.

CHANNEL	TX Channel 116	DETECTOR FUNCTION	Peak (PK) Average (AV)
FREQUENCY RANGE	1GHz ~ 40GHz		

**ANTENNA POLARITY & TEST DISTANCE: HORIZONTAL AT 3 M**

NO.	FREQ. (MHz)	EMISSION LEVEL (dBuV/m)	LIMIT (dBuV/m)	MARGIN (dB)	ANTENNA HEIGHT (m)	TABLE ANGLE (Degree)	RAW VALUE (dBuV)	CORRECTION FACTOR (dB/m)
1	*5580.00	118.8 PK			1.65 H	305	80.9	37.9
2	*5580.00	107.9 AV			1.65 H	305	70.0	37.9
3	11160.00	58.4 PK	74.0	-15.6	3.11 H	152	40.5	17.9
4	11160.00	45.2 AV	54.0	-8.8	3.11 H	152	27.3	17.9

**ANTENNA POLARITY & TEST DISTANCE: VERTICAL AT 3 M**

NO.	FREQ. (MHz)	EMISSION LEVEL (dBuV/m)	LIMIT (dBuV/m)	MARGIN (dB)	ANTENNA HEIGHT (m)	TABLE ANGLE (Degree)	RAW VALUE (dBuV)	CORRECTION FACTOR (dB/m)
1	*5580.00	113.8 PK			1.02 V	352	75.9	37.9
2	*5580.00	102.9 AV			1.02 V	352	65.0	37.9
3	11160.00	58.0 PK	74.0	-16.0	2.15 V	207	40.1	17.9
4	11160.00	45.0 AV	54.0	-9.0	2.15 V	207	27.1	17.9

**Remarks:**

1. Emission Level(dBuV/m) = Raw Value(dBuV) + Correction Factor(dB/m).
2. Correction Factor(dB/m) = Antenna Factor(dB/m) + Cable Factor(dB) – Pre-Amplifier Factor(dB).
3. Margin value = Emission Level – Limit value.
4. The other emission levels were very low against the limit.
5. " \* ": Fundamental frequency.

CHANNEL	TX Channel 140	DETECTOR FUNCTION	Peak (PK) Average (AV)
FREQUENCY RANGE	1GHz ~ 40GHz		

ANTENNA POLARITY & TEST DISTANCE: HORIZONTAL AT 3 M								
NO.	FREQ. (MHz)	EMISSION LEVEL (dBuV/m)	LIMIT (dBuV/m)	MARGIN (dB)	ANTENNA HEIGHT (m)	TABLE ANGLE (Degree)	RAW VALUE (dBuV)	CORRECTION FACTOR (dB/m)
1	*5700.00	118.2 PK			1.63 H	306	80.1	38.1
2	*5700.00	107.5 AV			1.63 H	306	69.4	38.1
3	#5725.00	63.0 PK	68.2	-5.2	1.66 H	302	56.0	7.0
4	11400.00	59.0 PK	74.0	-15.0	2.00 H	210	40.2	18.8
5	11400.00	45.9 AV	54.0	-8.1	2.00 H	210	27.1	18.8

ANTENNA POLARITY & TEST DISTANCE: VERTICAL AT 3 M								
NO.	FREQ. (MHz)	EMISSION LEVEL (dBuV/m)	LIMIT (dBuV/m)	MARGIN (dB)	ANTENNA HEIGHT (m)	TABLE ANGLE (Degree)	RAW VALUE (dBuV)	CORRECTION FACTOR (dB/m)
1	*5700.00	113.2 PK			1.45 V	353	75.1	38.1
2	*5700.00	102.5 AV			1.45 V	353	64.4	38.1
3	#5725.00	56.8 PK	68.2	-11.4	2.11 V	354	49.8	7.0
4	11400.00	58.8 PK	74.0	-15.2	1.08 V	100	40.0	18.8
5	11400.00	45.7 AV	54.0	-8.3	1.08 V	100	26.9	18.8

Remarks:

1. Emission Level(dBuV/m) = Raw Value(dBuV) + Correction Factor(dB/m).
2. Correction Factor(dB/m) = Antenna Factor(dB/m) + Cable Factor(dB) – Pre-Amplifier Factor(dB).
3. Margin value = Emission Level – Limit value.
4. The other emission levels were very low against the limit.
5. " \* " : Fundamental frequency.
6. " # " : The radiated frequency is out of the restricted band.

CHANNEL	TX Channel 144	DETECTOR FUNCTION	Peak (PK) Average (AV)
FREQUENCY RANGE	1GHz ~ 40GHz		

ANTENNA POLARITY & TEST DISTANCE: HORIZONTAL AT 3 M								
NO.	FREQ. (MHz)	EMISSION LEVEL (dBuV/m)	LIMIT (dBuV/m)	MARGIN (dB)	ANTENNA HEIGHT (m)	TABLE ANGLE (Degree)	RAW VALUE (dBuV)	CORRECTION FACTOR (dB/m)
1	#5470.00	55.2 PK	68.2	-13.0	1.55 H	316	48.6	6.6
2	*5720.00	116.9 PK			1.25 H	309	78.7	38.2
3	*5720.00	106.8 AV			1.25 H	309	68.6	38.2
4	#5850.00	55.7 PK	68.2	-12.5	1.35 H	310	48.5	7.2
5	11440.00	59.2 PK	74.0	-14.8	2.22 H	215	40.5	18.7
6	11440.00	45.9 AV	54.0	-8.1	2.22 H	215	27.2	18.7

ANTENNA POLARITY & TEST DISTANCE: VERTICAL AT 3 M								
NO.	FREQ. (MHz)	EMISSION LEVEL (dBuV/m)	LIMIT (dBuV/m)	MARGIN (dB)	ANTENNA HEIGHT (m)	TABLE ANGLE (Degree)	RAW VALUE (dBuV)	CORRECTION FACTOR (dB/m)
1	#5470.00	54.8 PK	68.2	-13.4	1.59 V	352	48.2	6.6
2	*5720.00	111.9 PK			2.00 V	355	73.7	38.2
3	*5720.00	101.8 AV			2.00 V	355	63.6	38.2
4	#5850.00	55.6 PK	68.2	-12.6	1.22 V	354	48.4	7.2
5	11440.00	58.9 PK	74.0	-15.1	1.59 V	102	40.2	18.7
6	11440.00	45.7 AV	54.0	-8.3	1.59 V	102	27.0	18.7

Remarks:

1. Emission Level(dBuV/m) = Raw Value(dBuV) + Correction Factor(dB/m).
2. Correction Factor(dB/m) = Antenna Factor(dB/m) + Cable Factor(dB) – Pre-Amplifier Factor(dB).
3. Margin value = Emission Level – Limit value.
4. The other emission levels were very low against the limit.
5. " \* " : Fundamental frequency.
6. " # " : The radiated frequency is out of the restricted band.

802.11n (HT40)

CHANNEL	TX Channel 54	DETECTOR FUNCTION	Peak (PK) Average (AV)
FREQUENCY RANGE	1GHz ~ 40GHz		

ANTENNA POLARITY & TEST DISTANCE: HORIZONTAL AT 3 M								
NO.	FREQ. (MHz)	EMISSION LEVEL (dBuV/m)	LIMIT (dBuV/m)	MARGIN (dB)	ANTENNA HEIGHT (m)	TABLE ANGLE (Degree)	RAW VALUE (dBuV)	CORRECTION FACTOR (dB/m)
1	5150.00	55.8 PK	74.0	-18.2	1.85 H	302	49.4	6.4
2	5150.00	41.9 AV	54.0	-12.1	1.85 H	302	35.5	6.4
3	*5270.00	116.6 PK			1.88 H	306	79.2	37.4
4	*5270.00	106.6 AV			1.88 H	306	69.2	37.4
5	#10540.00	57.8 PK	68.2	-10.4	2.15 H	209	40.7	17.1

ANTENNA POLARITY & TEST DISTANCE: VERTICAL AT 3 M								
NO.	FREQ. (MHz)	EMISSION LEVEL (dBuV/m)	LIMIT (dBuV/m)	MARGIN (dB)	ANTENNA HEIGHT (m)	TABLE ANGLE (Degree)	RAW VALUE (dBuV)	CORRECTION FACTOR (dB/m)
1	5150.00	55.5 PK	74.0	-18.5	1.89 V	352	49.1	6.4
2	5150.00	41.6 AV	54.0	-12.4	1.89 V	352	35.2	6.4
3	*5270.00	111.6 PK			2.56 V	352	74.2	37.4
4	*5270.00	101.5 AV			2.56 V	352	64.1	37.4
5	#10540.00	57.3 PK	68.2	-10.9	2.52 V	100	40.2	17.1

Remarks:

1. Emission Level(dBuV/m) = Raw Value(dBuV) + Correction Factor(dB/m).
2. Correction Factor(dB/m) = Antenna Factor(dB/m) + Cable Factor(dB) – Pre-Amplifier Factor(dB).
3. Margin value = Emission Level – Limit value.
4. The other emission levels were very low against the limit.
5. " \* ": Fundamental frequency.
6. " # ": The radiated frequency is out of the restricted band.

CHANNEL	TX Channel 62	DETECTOR FUNCTION	Peak (PK) Average (AV)
FREQUENCY RANGE	1GHz ~ 40GHz		

**ANTENNA POLARITY & TEST DISTANCE: HORIZONTAL AT 3 M**

NO.	FREQ. (MHz)	EMISSION LEVEL (dBuV/m)	LIMIT (dBuV/m)	MARGIN (dB)	ANTENNA HEIGHT (m)	TABLE ANGLE (Degree)	RAW VALUE (dBuV)	CORRECTION FACTOR (dB/m)
1	*5310.00	116.4 PK			1.52 H	308	79.0	37.4
2	*5310.00	106.6 AV			1.52 H	308	69.2	37.4
3	5350.00	63.1 PK	74.0	-10.9	2.17 H	321	56.8	6.3
4	5350.00	51.3 AV	54.0	-2.7	2.17 H	321	45.0	6.3
5	10620.00	57.7 PK	74.0	-16.3	2.11 H	218	40.3	17.4
6	10620.00	44.6 AV	54.0	-9.4	2.11 H	218	27.2	17.4

**ANTENNA POLARITY & TEST DISTANCE: VERTICAL AT 3 M**

NO.	FREQ. (MHz)	EMISSION LEVEL (dBuV/m)	LIMIT (dBuV/m)	MARGIN (dB)	ANTENNA HEIGHT (m)	TABLE ANGLE (Degree)	RAW VALUE (dBuV)	CORRECTION FACTOR (dB/m)
1	*5310.00	111.4 PK			2.19 V	358	74.0	37.4
2	*5310.00	101.6 AV			2.19 V	358	64.2	37.4
3	5350.00	55.8 PK	74.0	-18.2	2.11 V	316	49.5	6.3
4	5350.00	45.5 AV	54.0	-8.5	2.11 V	316	39.2	6.3
5	10620.00	57.5 PK	74.0	-16.5	3.19 V	115	40.1	17.4
6	10620.00	44.4 AV	54.0	-9.6	3.19 V	115	27.0	17.4

Remarks:

1. Emission Level(dBuV/m) = Raw Value(dBuV) + Correction Factor(dB/m).
2. Correction Factor(dB/m) = Antenna Factor(dB/m) + Cable Factor(dB) – Pre-Amplifier Factor(dB).
3. Margin value = Emission Level – Limit value.
4. The other emission levels were very low against the limit.
5. " \* ": Fundamental frequency.

CHANNEL	TX Channel 102	DETECTOR FUNCTION	Peak (PK) Average (AV)
FREQUENCY RANGE	1GHz ~ 40GHz		

**ANTENNA POLARITY & TEST DISTANCE: HORIZONTAL AT 3 M**

NO.	FREQ. (MHz)	EMISSION LEVEL (dBuV/m)	LIMIT (dBuV/m)	MARGIN (dB)	ANTENNA HEIGHT (m)	TABLE ANGLE (Degree)	RAW VALUE (dBuV)	CORRECTION FACTOR (dB/m)
1	5460.00	60.5 PK	74.0	-13.5	1.44 H	309	54.0	6.5
2	5460.00	48.1 AV	54.0	-5.9	1.44 H	309	41.6	6.5
3	#5470.00	64.8 PK	68.2	-3.4	1.47 H	301	58.2	6.6
4	*5510.00	116.2 PK			1.33 H	301	78.3	37.9
5	*5510.00	106.3 AV			1.33 H	301	68.4	37.9
6	11020.00	58.2 PK	74.0	-15.8	3.11 H	105	40.2	18.0
7	11020.00	45.0 AV	54.0	-9.0	3.11 H	105	27.0	18.0

**ANTENNA POLARITY & TEST DISTANCE: VERTICAL AT 3 M**

NO.	FREQ. (MHz)	EMISSION LEVEL (dBuV/m)	LIMIT (dBuV/m)	MARGIN (dB)	ANTENNA HEIGHT (m)	TABLE ANGLE (Degree)	RAW VALUE (dBuV)	CORRECTION FACTOR (dB/m)
1	5460.00	55.7 PK	74.0	-18.3	1.29 V	359	49.2	6.5
2	5460.00	43.7 AV	54.0	-10.3	1.29 V	359	37.2	6.5
3	#5470.00	57.1 PK	68.2	-11.1	1.06 V	352	50.5	6.6
4	*5510.00	111.2 PK			1.50 V	356	73.3	37.9
5	*5510.00	101.3 AV			1.50 V	356	63.4	37.9
6	11020.00	57.8 PK	74.0	-16.2	2.51 V	150	39.8	18.0
7	11020.00	44.8 AV	54.0	-9.2	2.51 V	150	26.8	18.0

Remarks:

1. Emission Level(dBuV/m) = Raw Value(dBuV) + Correction Factor(dB/m).
2. Correction Factor(dB/m) = Antenna Factor(dB/m) + Cable Factor(dB) – Pre-Amplifier Factor(dB).
3. Margin value = Emission Level – Limit value.
4. The other emission levels were very low against the limit.
5. " # ": The radiated frequency is out of the restricted band.

CHANNEL	TX Channel 110	DETECTOR FUNCTION	Peak (PK) Average (AV)
FREQUENCY RANGE	1GHz ~ 40GHz		

**ANTENNA POLARITY & TEST DISTANCE: HORIZONTAL AT 3 M**

NO.	FREQ. (MHz)	EMISSION LEVEL (dBuV/m)	LIMIT (dBuV/m)	MARGIN (dB)	ANTENNA HEIGHT (m)	TABLE ANGLE (Degree)	RAW VALUE (dBuV)	CORRECTION FACTOR (dB/m)
1	*5550.00	115.3 PK			1.65 H	304	77.5	37.8
2	*5550.00	105.3 AV			1.65 H	304	67.5	37.8
3	11100.00	57.8 PK	74.0	-16.2	3.15 H	200	40.0	17.8
4	11100.00	44.7 AV	54.0	-9.3	3.15 H	200	26.9	17.8

**ANTENNA POLARITY & TEST DISTANCE: VERTICAL AT 3 M**

NO.	FREQ. (MHz)	EMISSION LEVEL (dBuV/m)	LIMIT (dBuV/m)	MARGIN (dB)	ANTENNA HEIGHT (m)	TABLE ANGLE (Degree)	RAW VALUE (dBuV)	CORRECTION FACTOR (dB/m)
1	*5550.00	110.3 PK			1.70 V	352	72.5	37.8
2	*5550.00	100.3 AV			1.70 V	352	62.5	37.8
3	11100.00	57.6 PK	74.0	-16.4	2.11 V	170	39.8	17.8
4	11100.00	44.6 AV	54.0	-9.4	2.11 V	170	26.8	17.8

**Remarks:**

1. Emission Level(dBuV/m) = Raw Value(dBuV) + Correction Factor(dB/m).
2. Correction Factor(dB/m) = Antenna Factor(dB/m) + Cable Factor(dB) – Pre-Amplifier Factor(dB).
3. Margin value = Emission Level – Limit value.
4. The other emission levels were very low against the limit.
5. " \* " : Fundamental frequency.

CHANNEL	TX Channel 134	DETECTOR FUNCTION	Peak (PK) Average (AV)
FREQUENCY RANGE	1GHz ~ 40GHz		

ANTENNA POLARITY & TEST DISTANCE: HORIZONTAL AT 3 M								
NO.	FREQ. (MHz)	EMISSION LEVEL (dBuV/m)	LIMIT (dBuV/m)	MARGIN (dB)	ANTENNA HEIGHT (m)	TABLE ANGLE (Degree)	RAW VALUE (dBuV)	CORRECTION FACTOR (dB/m)
1	*5670.00	114.2 PK			1.50 H	304	76.2	38.0
2	*5670.00	104.6 AV			1.50 H	304	66.6	38.0
3	#5725.00	61.6 PK	68.2	-6.6	1.56 H	302	54.6	7.0
4	11340.00	58.5 PK	74.0	-15.5	3.00 H	158	40.1	18.4
5	11340.00	45.3 AV	54.0	-8.7	3.00 H	158	26.9	18.4

ANTENNA POLARITY & TEST DISTANCE: VERTICAL AT 3 M								
NO.	FREQ. (MHz)	EMISSION LEVEL (dBuV/m)	LIMIT (dBuV/m)	MARGIN (dB)	ANTENNA HEIGHT (m)	TABLE ANGLE (Degree)	RAW VALUE (dBuV)	CORRECTION FACTOR (dB/m)
1	*5670.00	109.2 PK			1.04 V	351	71.2	38.0
2	*5670.00	99.6 AV			1.04 V	351	61.6	38.0
3	#5725.00	56.5 PK	68.2	-11.7	2.05 V	350	49.5	7.0
4	11340.00	58.2 PK	74.0	-15.8	1.55 V	152	39.8	18.4
5	11340.00	45.1 AV	54.0	-8.9	1.55 V	152	26.7	18.4

Remarks:

1. Emission Level(dBuV/m) = Raw Value(dBuV) + Correction Factor(dB/m).
2. Correction Factor(dB/m) = Antenna Factor(dB/m) + Cable Factor(dB) – Pre-Amplifier Factor(dB).
3. Margin value = Emission Level – Limit value.
4. The other emission levels were very low against the limit.
5. " \* " : Fundamental frequency.
6. " # " : The radiated frequency is out of the restricted band.

CHANNEL	TX Channel 142	DETECTOR FUNCTION	Peak (PK) Average (AV)
FREQUENCY RANGE	1GHz ~ 40GHz		

**ANTENNA POLARITY & TEST DISTANCE: HORIZONTAL AT 3 M**

NO.	FREQ. (MHz)	EMISSION LEVEL (dBuV/m)	LIMIT (dBuV/m)	MARGIN (dB)	ANTENNA HEIGHT (m)	TABLE ANGLE (Degree)	RAW VALUE (dBuV)	CORRECTION FACTOR (dB/m)
1	*5710.00	114.9 PK			1.24 H	312	76.8	38.1
2	*5710.00	105.2 AV			1.24 H	312	67.1	38.1
3	#5850.00	55.4 PK	68.2	-12.8	2.55 H	312	48.2	7.2
4	11420.00	59.4 PK	74.0	-14.6	2.66 H	215	40.6	18.8
5	11420.00	46.4 AV	54.0	-7.6	2.66 H	215	27.6	18.8

**ANTENNA POLARITY & TEST DISTANCE: VERTICAL AT 3 M**

NO.	FREQ. (MHz)	EMISSION LEVEL (dBuV/m)	LIMIT (dBuV/m)	MARGIN (dB)	ANTENNA HEIGHT (m)	TABLE ANGLE (Degree)	RAW VALUE (dBuV)	CORRECTION FACTOR (dB/m)
1	*5710.00	109.9 PK			1.29 V	359	71.8	38.1
2	*5710.00	100.2 AV			1.29 V	359	62.1	38.1
3	#5850.00	55.2 PK	68.2	-13.0	2.15 V	358	48.0	7.2
4	11420.00	59.2 PK	74.0	-14.8	2.15 V	100	40.4	18.8
5	11420.00	46.0 AV	54.0	-8.0	2.15 V	100	27.2	18.8

Remarks:

1. Emission Level(dBuV/m) = Raw Value(dBuV) + Correction Factor(dB/m).
2. Correction Factor(dB/m) = Antenna Factor(dB/m) + Cable Factor(dB) – Pre-Amplifier Factor(dB).
3. Margin value = Emission Level – Limit value.
4. The other emission levels were very low against the limit.
5. " \* " : Fundamental frequency.
6. " # " : The radiated frequency is out of the restricted band.

802.11ac (VHT80)

CHANNEL	TX Channel 58	DETECTOR FUNCTION	Peak (PK) Average (AV)
FREQUENCY RANGE	1GHz ~ 40GHz		

ANTENNA POLARITY & TEST DISTANCE: HORIZONTAL AT 3 M

NO.	FREQ. (MHz)	EMISSION LEVEL (dBuV/m)	LIMIT (dBuV/m)	MARGIN (dB)	ANTENNA HEIGHT (m)	TABLE ANGLE (Degree)	RAW VALUE (dBuV)	CORRECTION FACTOR (dB/m)
1	5150.00	58.8 PK	74.0	-15.2	1.89 H	301	52.4	6.4
2	5150.00	45.2 AV	54.0	-8.8	1.89 H	301	38.8	6.4
3	*5290.00	112.9 PK			1.73 H	307	75.5	37.4
4	*5290.00	103.4 AV			1.73 H	307	66.0	37.4
5	5350.00	65.6 PK	74.0	-8.4	1.71 H	305	59.3	6.3
6	5350.00	52.7 AV	54.0	-1.3	1.71 H	305	46.4	6.3
7	#10580.00	57.9 PK	68.2	-10.3	2.11 H	205	40.5	17.4

ANTENNA POLARITY & TEST DISTANCE: VERTICAL AT 3 M

NO.	FREQ. (MHz)	EMISSION LEVEL (dBuV/m)	LIMIT (dBuV/m)	MARGIN (dB)	ANTENNA HEIGHT (m)	TABLE ANGLE (Degree)	RAW VALUE (dBuV)	CORRECTION FACTOR (dB/m)
1	5150.00	56.2 PK	74.0	-17.8	1.56 V	353	49.8	6.4
2	5150.00	43.9 AV	54.0	-10.1	1.56 V	353	37.5	6.4
3	*5290.00	107.9 PK			1.58 V	352	70.5	37.4
4	*5290.00	98.4 AV			1.58 V	352	61.0	37.4
5	5350.00	56.5 PK	74.0	-17.5	2.15 V	358	50.2	6.3
6	5350.00	46.1 AV	54.0	-7.9	2.15 V	358	39.8	6.3
7	#10580.00	57.5 PK	68.2	-10.7	2.15 V	155	40.1	17.4

Remarks:

1. Emission Level(dBuV/m) = Raw Value(dBuV) + Correction Factor(dB/m).
2. Correction Factor(dB/m) = Antenna Factor(dB/m) + Cable Factor(dB) – Pre-Amplifier Factor(dB).
3. Margin value = Emission Level – Limit value.
4. The other emission levels were very low against the limit.
5. " \* ": Fundamental frequency.
6. " # ": The radiated frequency is out of the restricted band.

CHANNEL	TX Channel 106	DETECTOR FUNCTION	Peak (PK) Average (AV)
FREQUENCY RANGE	1GHz ~ 40GHz		

**ANTENNA POLARITY & TEST DISTANCE: HORIZONTAL AT 3 M**

NO.	FREQ. (MHz)	EMISSION LEVEL (dBuV/m)	LIMIT (dBuV/m)	MARGIN (dB)	ANTENNA HEIGHT (m)	TABLE ANGLE (Degree)	RAW VALUE (dBuV)	CORRECTION FACTOR (dB/m)
1	5460.00	66.9 PK	74.0	-7.1	1.50 H	305	60.4	6.5
2	5460.00	52.2 AV	54.0	-1.8	1.50 H	305	45.7	6.5
3	#5470.00	66.8 PK	68.2	-1.4	1.70 H	303	60.2	6.6
4	*5530.00	111.2 PK			1.66 H	305	73.3	37.9
5	*5530.00	101.5 AV			1.66 H	305	63.6	37.9
6	#5725.00	57.2 PK	68.2	-11.0	1.63 H	310	50.2	7.0
7	11060.00	58.7 PK	74.0	-15.3	3.15 H	105	40.8	17.9
8	11060.00	45.2 AV	54.0	-8.8	3.15 H	105	27.3	17.9

**ANTENNA POLARITY & TEST DISTANCE: VERTICAL AT 3 M**

NO.	FREQ. (MHz)	EMISSION LEVEL (dBuV/m)	LIMIT (dBuV/m)	MARGIN (dB)	ANTENNA HEIGHT (m)	TABLE ANGLE (Degree)	RAW VALUE (dBuV)	CORRECTION FACTOR (dB/m)
1	5460.00	56.0 PK	74.0	-18.0	1.23 V	358	49.5	6.5
2	5460.00	44.6 AV	54.0	-9.4	1.23 V	358	38.1	6.5
3	#5470.00	60.1 PK	68.2	-8.1	1.00 V	356	53.5	6.6
4	*5530.00	106.2 PK			2.10 V	350	68.3	37.9
5	*5530.00	96.5 AV			2.10 V	350	58.6	37.9
6	#5725.00	56.8 PK	68.2	-11.4	1.05 V	352	49.8	7.0
7	11060.00	58.4 PK	74.0	-15.6	2.00 V	210	40.5	17.9
8	11060.00	44.9 AV	54.0	-9.1	2.00 V	210	27.0	17.9

Remarks:

1. Emission Level(dBuV/m) = Raw Value(dBuV) + Correction Factor(dB/m).
2. Correction Factor(dB/m) = Antenna Factor(dB/m) + Cable Factor(dB) – Pre-Amplifier Factor(dB).
3. Margin value = Emission Level – Limit value.
4. The other emission levels were very low against the limit.
5. " \* ": Fundamental frequency.
6. " # ": The radiated frequency is out of the restricted band.

CHANNEL	TX Channel 122	DETECTOR FUNCTION	Peak (PK) Average (AV)
FREQUENCY RANGE	1GHz ~ 40GHz		

**ANTENNA POLARITY & TEST DISTANCE: HORIZONTAL AT 3 M**

NO.	FREQ. (MHz)	EMISSION LEVEL (dBuV/m)	LIMIT (dBuV/m)	MARGIN (dB)	ANTENNA HEIGHT (m)	TABLE ANGLE (Degree)	RAW VALUE (dBuV)	CORRECTION FACTOR (dB/m)
1	5460.00	60.4 PK	74.0	-13.6	1.35 H	305	53.9	6.5
2	5460.00	46.1 AV	54.0	-7.9	1.35 H	305	39.6	6.5
3	#5470.00	63.7 PK	68.2	-4.5	1.52 H	305	57.1	6.6
4	*5610.00	110.0 PK			1.52 H	307	72.1	37.9
5	*5610.00	100.7 AV			1.52 H	307	62.8	37.9
<b>6</b>	<b>#5725.00</b>	<b>67.2 PK</b>	<b>68.2</b>	<b>-1.0</b>	<b>1.56 H</b>	<b>311</b>	<b>60.2</b>	<b>7.0</b>
7	11220.00	58.0 PK	74.0	-16.0	2.15 H	205	40.1	17.9
8	11220.00	44.9 AV	54.0	-9.1	2.15 H	205	27.0	17.9

**ANTENNA POLARITY & TEST DISTANCE: VERTICAL AT 3 M**

NO.	FREQ. (MHz)	EMISSION LEVEL (dBuV/m)	LIMIT (dBuV/m)	MARGIN (dB)	ANTENNA HEIGHT (m)	TABLE ANGLE (Degree)	RAW VALUE (dBuV)	CORRECTION FACTOR (dB/m)
1	5460.00	56.3 PK	74.0	-17.7	1.21 V	330	49.8	6.5
2	5460.00	44.0 AV	54.0	-10.0	1.21 V	330	37.5	6.5
3	#5470.00	56.8 PK	68.2	-11.4	1.52 V	332	50.2	6.6
4	*5610.00	105.0 PK			1.11 V	356	67.1	37.9
5	*5610.00	95.7 AV			1.11 V	356	57.8	37.9
6	#5725.00	57.0 PK	68.2	-11.2	1.59 V	335	50.0	7.0
7	11220.00	57.9 PK	74.0	-16.1	1.52 V	158	40.0	17.9
8	11220.00	44.7 AV	54.0	-9.3	1.52 V	158	26.8	17.9

Remarks:

1. Emission Level(dBuV/m) = Raw Value(dBuV) + Correction Factor(dB/m).
2. Correction Factor(dB/m) = Antenna Factor(dB/m) + Cable Factor(dB) – Pre-Amplifier Factor(dB).
3. Margin value = Emission Level – Limit value.
4. The other emission levels were very low against the limit.
5. " \* ": Fundamental frequency.
6. " # ": The radiated frequency is out of the restricted band.

CHANNEL	TX Channel 138	DETECTOR FUNCTION	Peak (PK) Average (AV)
FREQUENCY RANGE	1GHz ~ 40GHz		

**ANTENNA POLARITY & TEST DISTANCE: HORIZONTAL AT 3 M**

NO.	FREQ. (MHz)	EMISSION LEVEL (dBuV/m)	LIMIT (dBuV/m)	MARGIN (dB)	ANTENNA HEIGHT (m)	TABLE ANGLE (Degree)	RAW VALUE (dBuV)	CORRECTION FACTOR (dB/m)
1	#5470.00	55.9 PK	68.2	-12.3	1.29 H	326	49.3	6.6
2	*5690.00	112.3 PK			1.22 H	311	74.3	38.0
3	*5690.00	102.2 AV			1.22 H	311	64.2	38.0
4	#5850.00	64.7 PK	68.2	-3.5	1.25 H	325	57.5	7.2
5	11380.00	59.2 PK	74.0	-14.8	2.52 H	152	40.5	18.7
6	11380.00	46.5 AV	54.0	-7.5	2.52 H	152	27.8	18.7

**ANTENNA POLARITY & TEST DISTANCE: VERTICAL AT 3 M**

NO.	FREQ. (MHz)	EMISSION LEVEL (dBuV/m)	LIMIT (dBuV/m)	MARGIN (dB)	ANTENNA HEIGHT (m)	TABLE ANGLE (Degree)	RAW VALUE (dBuV)	CORRECTION FACTOR (dB/m)
1	#5470.00	55.1 PK	68.2	-13.1	2.22 V	359	48.5	6.6
2	*5690.00	107.3 PK			1.25 V	353	69.3	38.0
3	*5690.00	97.2 AV			1.25 V	353	59.2	38.0
4	#5850.00	57.3 PK	68.2	-10.9	2.15 V	354	50.1	7.2
5	11380.00	58.8 PK	74.0	-15.2	2.22 V	25	40.1	18.7
6	11380.00	46.2 AV	54.0	-7.8	2.22 V	25	27.5	18.7

Remarks:

1. Emission Level(dBuV/m) = Raw Value(dBuV) + Correction Factor(dB/m).
2. Correction Factor(dB/m) = Antenna Factor(dB/m) + Cable Factor(dB) – Pre-Amplifier Factor(dB).
3. Margin value = Emission Level – Limit value.
4. The other emission levels were very low against the limit.
5. " \* " : Fundamental frequency.
6. " # " : The radiated frequency is out of the restricted band.

Below 1GHz Worst-Case Data:

802.11n (HT40)

CHANNEL	TX Channel 102	DETECTOR FUNCTION	Quasi-Peak (QP)
FREQUENCY RANGE	9kHz ~ 1GHz		
TEST MODE	A		

ANTENNA POLARITY & TEST DISTANCE: HORIZONTAL AT 3 M

NO.	FREQ. (MHz)	EMISSION LEVEL (dBuV/m)	LIMIT (dBuV/m)	MARGIN (dB)	ANTENNA HEIGHT (m)	TABLE ANGLE (Degree)	RAW VALUE (dBuV)	CORRECTION FACTOR (dB/m)
1	49.37	27.4 QP	40.0	-12.6	1.00 H	111	37.2	-9.8
2	166.77	29.9 QP	43.5	-13.6	1.50 H	271	39.2	-9.3
3	249.13	38.6 QP	46.0	-7.4	1.00 H	171	48.3	-9.7
4	375.32	40.2 QP	46.0	-5.8	1.00 H	269	46.9	-6.7
5	624.61	39.3 QP	46.0	-6.7	1.00 H	188	41.0	-1.7
6	889.64	39.8 QP	46.0	-6.2	1.00 H	126	37.0	2.8

Remarks:

1. Emission Level(dBuV/m) = Raw Value(dBuV) + Correction Factor(dB/m).
2. Correction Factor(dB/m) = Antenna Factor(dB/m) + Cable Factor(dB) – Pre-Amplifier Factor(dB).
3. The other emission levels were very low against the limit of frequency range 30MHz ~ 1000MHz.
4. Margin value = Emission Level – Limit value.
5. The emission levels were very low against the limit of frequency range 9kHz ~ 30MHz: the amplitude of spurious emissions attenuated more than 20 dB below the permissible value to be report.

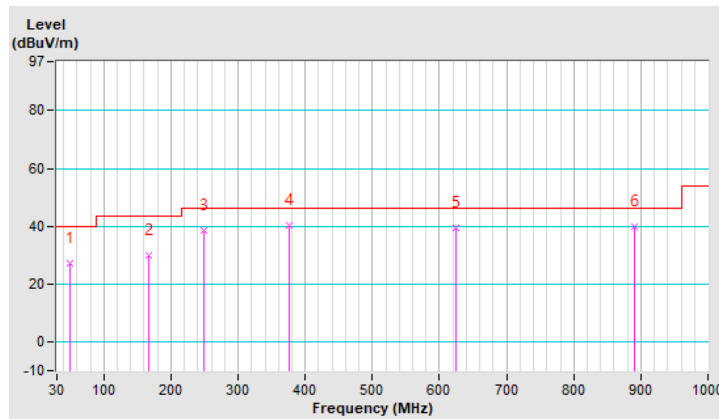

CHANNEL	TX Channel 102	DETECTOR FUNCTION	Quasi-Peak (QP)
FREQUENCY RANGE	9kHz ~ 1GHz		
TEST MODE	A		

ANTENNA POLARITY & TEST DISTANCE: VERTICAL AT 3 M								
NO.	FREQ. (MHz)	EMISSION LEVEL (dBuV/m)	LIMIT (dBuV/m)	MARGIN (dB)	ANTENNA HEIGHT (m)	TABLE ANGLE (Degree)	RAW VALUE (dBuV)	CORRECTION FACTOR (dB/m)
1	35.82	31.2 QP	40.0	-8.8	1.00 V	2	41.9	-10.7
2	72.68	35.7 QP	40.0	-4.3	1.50 V	251	48.1	-12.4
3	243.40	29.5 QP	46.0	-16.5	1.00 V	66	39.4	-9.9
4	460.68	34.1 QP	46.0	-11.9	1.00 V	29	39.2	-5.1
5	624.61	39.0 QP	46.0	-7.0	2.00 V	28	40.7	-1.7
6	874.87	37.9 QP	46.0	-8.1	1.00 V	208	35.3	2.6

Remarks:

1. Emission Level(dBuV/m) = Raw Value(dBuV) + Correction Factor(dB/m).
2. Correction Factor(dB/m) = Antenna Factor(dB/m) + Cable Factor(dB) – Pre-Amplifier Factor(dB).
3. The other emission levels were very low against the limit of frequency range 30MHz ~ 1000MHz.
4. Margin value = Emission Level – Limit value.
5. The emission levels were very low against the limit of frequency range 9kHz ~ 30MHz: the amplitude of spurious emissions attenuated more than 20 dB below the permissible value to be report.

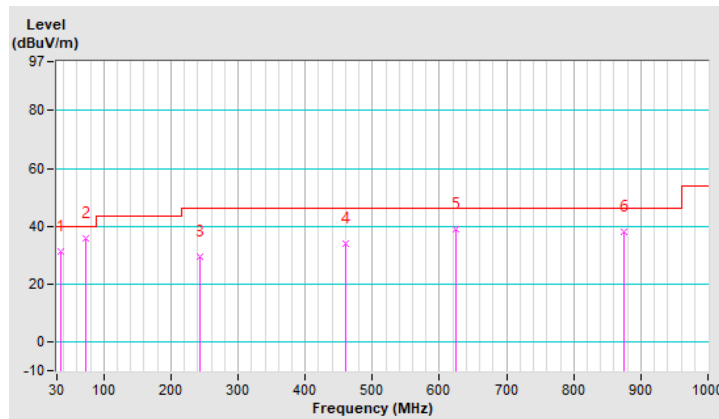

CHANNEL	TX Channel 102	DETECTOR FUNCTION	Quasi-Peak (QP)
FREQUENCY RANGE	9kHz ~ 1GHz		
TEST MODE	B		

ANTENNA POLARITY & TEST DISTANCE: HORIZONTAL AT 3 M								
NO.	FREQ. (MHz)	EMISSION LEVEL (dBuV/m)	LIMIT (dBuV/m)	MARGIN (dB)	ANTENNA HEIGHT (m)	TABLE ANGLE (Degree)	RAW VALUE (dBuV)	CORRECTION FACTOR (dB/m)
1	92.53	38.7 QP	43.5	-4.8	1.00 H	6	52.5	-13.8
2	249.17	40.5 QP	46.0	-5.5	1.01 H	278	49.6	-9.1
3	375.29	38.0 QP	46.0	-8.0	1.01 H	177	43.5	-5.5
4	493.66	42.8 QP	46.0	-3.2	1.50 H	343	45.7	-2.9
5	625.60	43.7 QP	46.0	-2.3	1.50 H	115	43.2	0.5
6	875.91	38.4 QP	46.0	-7.6	1.50 H	70	32.2	6.2

Remarks:

1. Emission Level(dBuV/m) = Raw Value(dBuV) + Correction Factor(dB/m).
2. Correction Factor(dB/m) = Antenna Factor(dB/m) + Cable Factor(dB) – Pre-Amplifier Factor(dB).
3. The other emission levels were very low against the limit of frequency range 30MHz ~ 1000MHz.
4. Margin value = Emission Level – Limit value.
5. The emission levels were very low against the limit of frequency range 9kHz ~ 30MHz: the amplitude of spurious emissions attenuated more than 20 dB below the permissible value to be report.

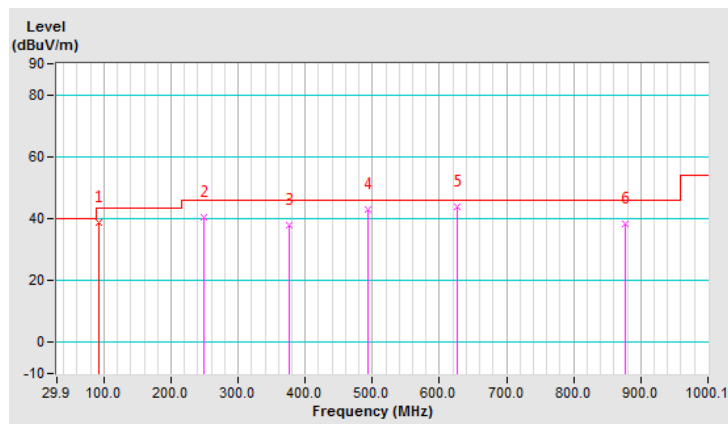

CHANNEL	TX Channel 102	DETECTOR FUNCTION	Quasi-Peak (QP)
FREQUENCY RANGE	9kHz ~ 1GHz		
TEST MODE	B		

ANTENNA POLARITY & TEST DISTANCE: VERTICAL AT 3 M								
NO.	FREQ. (MHz)	EMISSION LEVEL (dBuV/m)	LIMIT (dBuV/m)	MARGIN (dB)	ANTENNA HEIGHT (m)	TABLE ANGLE (Degree)	RAW VALUE (dBuV)	CORRECTION FACTOR (dB/m)
1	165.73	38.0 QP	43.5	-5.5	1.50 V	308	46.9	-8.9
2	282.15	40.5 QP	46.0	-5.5	1.00 V	168	48.3	-7.8
3	289.91	36.9 QP	46.0	-9.1	1.00 V	168	44.6	-7.7
4	491.07	41.9 QP	46.0	-4.1	1.54 V	310	44.9	-3.0
5	608.14	41.2 QP	46.0	-4.8	1.50 V	144	41.1	0.1
6	875.91	37.9 QP	46.0	-8.1	1.50 V	13	31.7	6.2

Remarks:

1. Emission Level(dBuV/m) = Raw Value(dBuV) + Correction Factor(dB/m).
2. Correction Factor(dB/m) = Antenna Factor(dB/m) + Cable Factor(dB) – Pre-Amplifier Factor(dB).
3. The other emission levels were very low against the limit of frequency range 30MHz ~ 1000MHz.
4. Margin value = Emission Level – Limit value.
5. The emission levels were very low against the limit of frequency range 9kHz ~ 30MHz: the amplitude of spurious emissions attenuated more than 20 dB below the permissible value to be report.

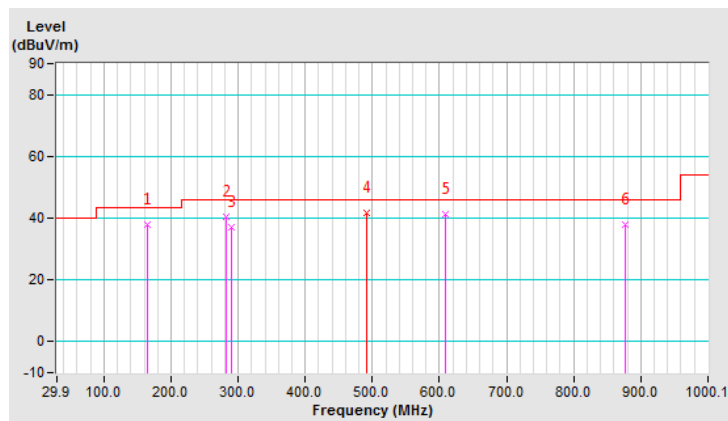

CHANNEL	TX Channel 102	DETECTOR FUNCTION	Quasi-Peak (QP)
FREQUENCY RANGE	9kHz ~ 1GHz		
TEST MODE	C		

ANTENNA POLARITY & TEST DISTANCE: HORIZONTAL AT 3 M								
NO.	FREQ. (MHz)	EMISSION LEVEL (dBuV/m)	LIMIT (dBuV/m)	MARGIN (dB)	ANTENNA HEIGHT (m)	TABLE ANGLE (Degree)	RAW VALUE (dBuV)	CORRECTION FACTOR (dB/m)
1	66.99	36.4 QP	40.0	-3.6	1.00 H	76	47.5	-11.1
2	233.64	36.2 QP	46.0	-9.8	1.00 H	347	46.8	-10.6
3	375.32	38.1 QP	46.0	-7.9	1.50 H	302	44.4	-6.3
4	624.61	40.5 QP	46.0	-5.5	1.00 H	164	42.1	-1.6
5	782.69	40.8 QP	46.0	-5.2	1.00 H	299	39.3	1.5
6	940.80	42.5 QP	46.0	-3.5	1.00 H	150	38.4	4.1

Remarks:

1. Emission Level(dBuV/m) = Raw Value(dBuV) + Correction Factor(dB/m).
2. Correction Factor(dB/m) = Antenna Factor(dB/m) + Cable Factor(dB) – Pre-Amplifier Factor(dB).
3. The other emission levels were very low against the limit of frequency range 30MHz ~ 1000MHz.
4. Margin value = Emission Level – Limit value.
5. The emission levels were very low against the limit of frequency range 9kHz ~ 30MHz: the amplitude of spurious emissions attenuated more than 20 dB below the permissible value to be report.

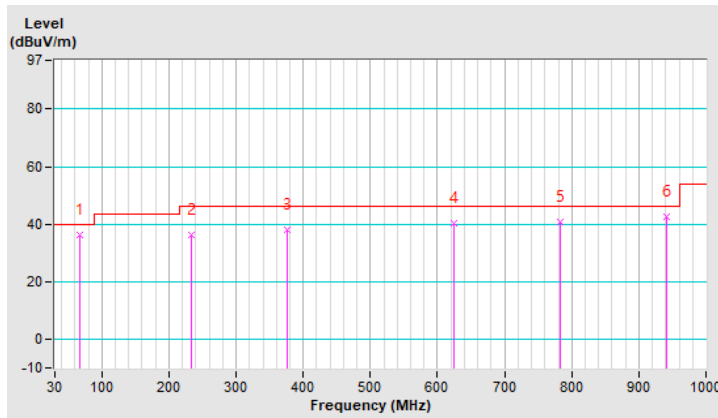

CHANNEL	TX Channel 102	DETECTOR FUNCTION	Quasi-Peak (QP)
FREQUENCY RANGE	9kHz ~ 1GHz		
TEST MODE	C		

ANTENNA POLARITY & TEST DISTANCE: VERTICAL AT 3 M								
NO.	FREQ. (MHz)	EMISSION LEVEL (dBuV/m)	LIMIT (dBuV/m)	MARGIN (dB)	ANTENNA HEIGHT (m)	TABLE ANGLE (Degree)	RAW VALUE (dBuV)	CORRECTION FACTOR (dB/m)
1	35.68	38.3 QP	40.0	-1.7	1.00 V	223	49.0	-10.7
2	150.25	34.2 QP	43.5	-9.3	1.00 V	263	43.6	-9.4
3	375.32	35.9 QP	46.0	-10.1	1.50 V	198	42.6	-6.7
4	479.11	40.8 QP	46.0	-5.2	1.00 V	345	45.8	-5.0
5	624.66	38.5 QP	46.0	-7.5	1.00 V	167	40.2	-1.7
6	783.69	39.0 QP	46.0	-7.0	2.00 V	344	37.4	1.6

Remarks:

1. Emission Level(dBuV/m) = Raw Value(dBuV) + Correction Factor(dB/m).
2. Correction Factor(dB/m) = Antenna Factor(dB/m) + Cable Factor(dB) – Pre-Amplifier Factor(dB).
3. The other emission levels were very low against the limit of frequency range 30MHz ~ 1000MHz.
4. Margin value = Emission Level – Limit value.
5. The emission levels were very low against the limit of frequency range 9kHz ~ 30MHz: the amplitude of spurious emissions attenuated more than 20 dB below the permissible value to be report.

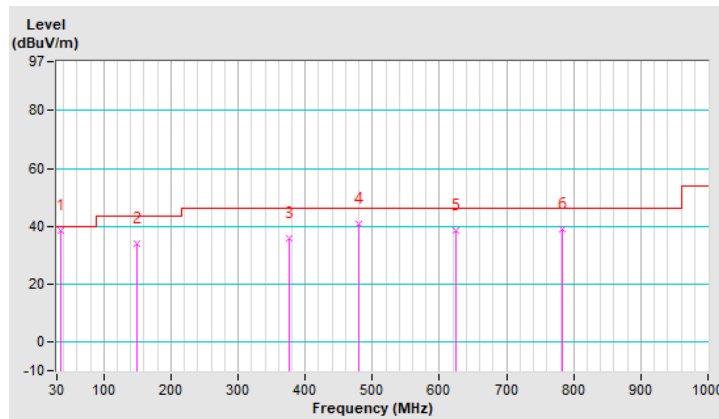

## 4.2 Conducted Emission Measurement

### 4.2.1 Limits of Conducted Emission Measurement

Frequency (MHz)	Conducted Limit (dBuV)	
	Quasi-peak	Average
0.15 - 0.5	66 - 56	56 - 46
0.50 - 5.0	56	46
5.0 - 30.0	60	50

Note: 1. The lower limit shall apply at the transition frequencies.

2. The limit decreases in line with the logarithm of the frequency in the range of 0.15 to 0.50MHz.

### 4.2.2 Test Instruments

Description & Manufacturer	Model No.	Serial No.	Cal. Date	Cal. Due
Test Receiver ROHDE & SCHWARZ	ESCI	100613	Dec. 10, 2018	Dec. 09, 2019
			Dec. 11, 2019	Dec. 10, 2020
RF signal cable Woken	5D-FB	Cable-cond1-01	Sep. 05, 2019	Sep. 04, 2020
LISN ROHDE & SCHWARZ (EUT)	ENV216	101826	Feb. 21, 2019	Feb. 20, 2020
LISN ROHDE & SCHWARZ (Peripheral)	ESH3-Z5	100311	Aug. 22, 2019	Aug. 21, 2020
Software ADT	BV ADT_Cond_ V7.3.7.4	NA	NA	NA

Note: 1. The calibration interval of the above test instruments is 12 months and the calibrations are traceable to NML/ROC and NIST/USA.

2. The test was performed in HwaYa Shielded Room 1.

3. The VCCI Site Registration No. is C-12040.

#### 4.2.3 Test Procedures

- The EUT was placed 0.4 meters from the conducting wall of the shielded room with EUT being connected to the power mains through a line impedance stabilization network (LISN). Other support units were connected to the power mains through another LISN. The two LISNs provide 50 ohm/ 50uH of coupling impedance for the measuring instrument.
- Both lines of the power mains connected to the EUT were checked for maximum conducted interference.
- The frequency range from 150kHz to 30MHz was searched. Emission levels under (Limit - 20dB) was not recorded.

Note: The resolution bandwidth and video bandwidth of test receiver is 9kHz for quasi-peak detection (QP) and average detection (AV) at frequency 0.15MHz-30MHz.

#### 4.2.4 Deviation from Test Standard

No deviation.

#### 4.2.5 Test Setup

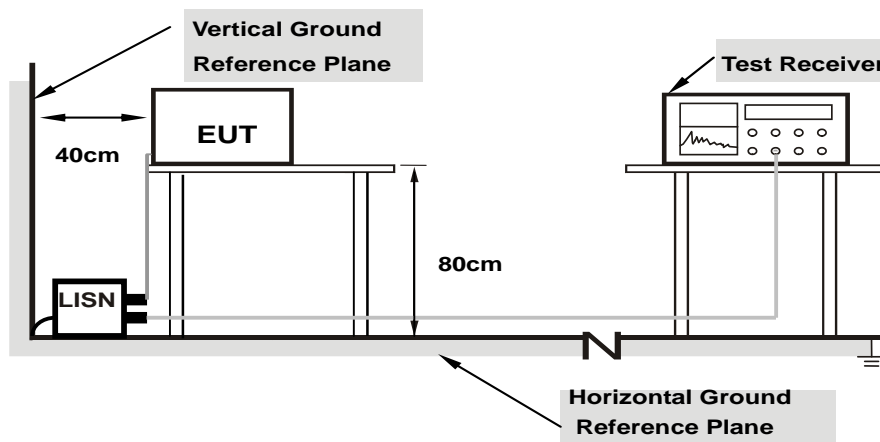

**Note: 1.Support units were connected to second LISN.**

For the actual test configuration, please refer to the attached file (Test Setup Photo).

#### 4.2.6 EUT Operating Conditions

Same as 4.1.6.

#### 4.2.7 Test Results

Worst-case data:

802.11n (HT40)

Phase	Line (L)	Detector Function	Quasi-Peak (QP) / Average (AV)
Test Mode	A		

No	Freq. [MHz]	Corr. Factor (dB)	Reading Value [dB (uV)]		Emission Level [dB (uV)]		Limit [dB (uV)]		Margin (dB)	
			Q.P.	AV.	Q.P.	AV.	Q.P.	AV.	Q.P.	AV.
			1	0.15391	9.67	39.61	22.70	49.28	32.37	65.79
2	0.17346	9.67	32.74	15.88	42.41	25.55	64.79	54.79	-22.38	-29.24
3	0.21256	9.66	29.61	17.41	39.27	27.07	63.10	53.10	-23.83	-26.03
4	0.30214	9.68	34.43	27.58	44.11	37.26	60.18	50.18	-16.07	-12.92
5	0.64657	9.71	16.82	8.88	26.53	18.59	56.00	46.00	-29.47	-27.41
6	9.85462	9.93	14.12	9.12	24.05	19.05	60.00	50.00	-35.95	-30.95

Remarks:

1. Q.P. and AV. are abbreviations of quasi-peak and average individually.
2. The emission levels of other frequencies were very low against the limit.
3. Margin value = Emission level - Limit value
4. Correction factor = Insertion loss + Cable loss
5. Emission Level = Correction Factor + Reading Value.

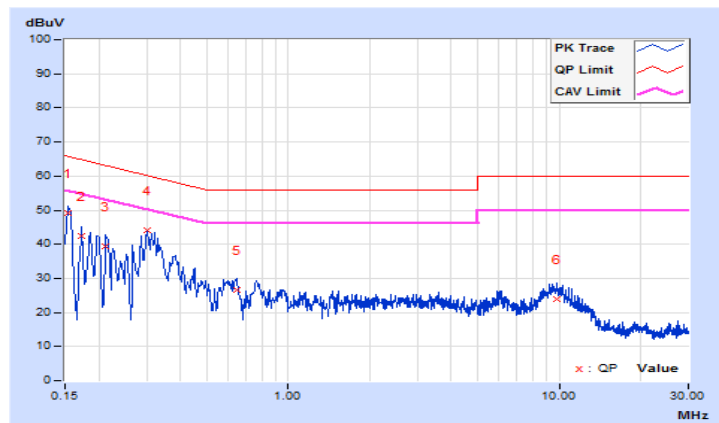

Phase	Neutral (N)	Detector Function	Quasi-Peak (QP) / Average (AV)
Test Mode	A		

No	Freq. [MHz]	Corr. Factor (dB)	Reading Value [dB (uV)]		Emission Level [dB (uV)]		Limit [dB (uV)]		Margin (dB)	
			Q.P.	AV.	Q.P.	AV.	Q.P.	AV.	Q.P.	AV.
			1	0.16955	9.64	36.81	18.92	46.45	28.56	64.98
2	0.18128	9.64	33.77	18.48	43.41	28.12	64.43	54.43	-21.02	-26.31
3	0.22429	9.64	29.70	16.97	39.34	26.61	62.66	52.66	-23.32	-26.05
4	0.29858	9.65	35.44	27.74	45.09	37.39	60.28	50.28	-15.19	-12.89
5	0.60737	9.67	20.05	14.49	29.72	24.16	56.00	46.00	-26.28	-21.84
6	6.12839	9.85	9.04	3.49	18.89	13.34	60.00	50.00	-41.11	-36.66

Remarks:

1. Q.P. and AV. are abbreviations of quasi-peak and average individually.
2. The emission levels of other frequencies were very low against the limit.
3. Margin value = Emission level - Limit value
4. Correction factor = Insertion loss + Cable loss
5. Emission Level = Correction Factor + Reading Value.

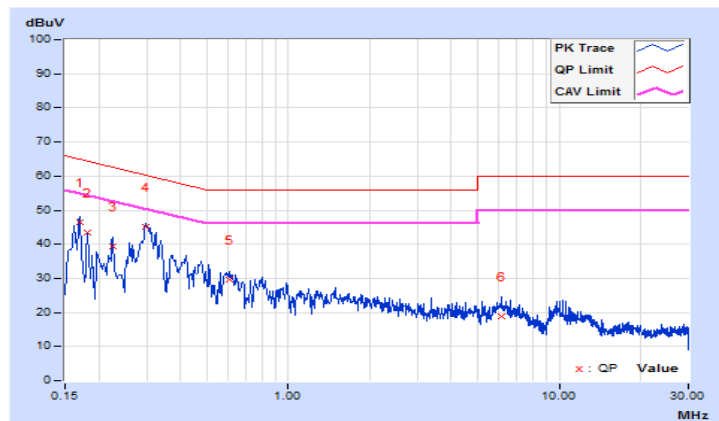

Phase	Line (L)	Detector Function	Quasi-Peak (QP) / Average (AV)
Test Mode	B		

No	Freq. [MHz]	Corr. Factor (dB)	Reading Value [dB (uV)]		Emission Level [dB (uV)]		Limit [dB (uV)]		Margin (dB)	
			Q.P.	AV.	Q.P.	AV.	Q.P.	AV.	Q.P.	AV.
			1	0.16600	9.67	34.28	23.68	43.95	33.35	65.16
2	0.36600	9.68	35.24	28.46	44.92	38.14	58.59	48.59	-13.67	-10.45
3	0.94200	9.73	10.32	5.02	20.05	14.75	56.00	46.00	-35.95	-31.25
4	7.57800	9.89	11.99	5.84	21.88	15.73	60.00	50.00	-38.12	-34.27
5	12.87800	9.95	12.41	5.69	22.36	15.64	60.00	50.00	-37.64	-34.36
6	20.21800	9.98	11.29	4.24	21.27	14.22	60.00	50.00	-38.73	-35.78

Remarks:

1. Q.P. and AV. are abbreviations of quasi-peak and average individually.
2. The emission levels of other frequencies were very low against the limit.
3. Margin value = Emission level - Limit value
4. Correction factor = Insertion loss + Cable loss
5. Emission Level = Correction Factor + Reading Value.

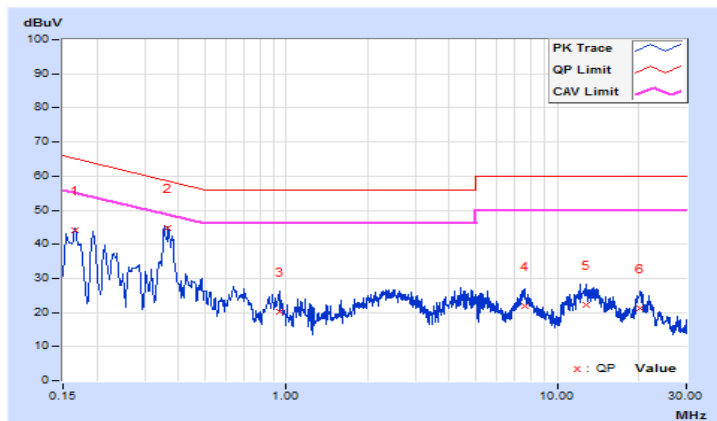

Phase	Neutral (N)	Detector Function	Quasi-Peak (QP) / Average (AV)
Test Mode	B		

No	Freq. [MHz]	Corr. Factor (dB)	Reading Value [dB (uV)]		Emission Level [dB (uV)]		Limit [dB (uV)]		Margin (dB)	
			Q.P.	AV.	Q.P.	AV.	Q.P.	AV.	Q.P.	AV.
			1	0.15400	9.64	35.01	22.59	44.65	32.23	65.78
2	0.36161	9.66	32.97	25.78	42.63	35.44	58.69	48.69	-16.06	-13.25
3	4.75400	9.82	12.78	5.53	22.60	15.35	56.00	46.00	-33.40	-30.65
4	7.77400	9.87	13.06	7.94	22.93	17.81	60.00	50.00	-37.07	-32.19
5	13.79400	9.97	12.14	5.80	22.11	15.77	60.00	50.00	-37.89	-34.23
6	20.62200	10.05	11.41	5.79	21.46	15.84	60.00	50.00	-38.54	-34.16

Remarks:

1. Q.P. and AV. are abbreviations of quasi-peak and average individually.
2. The emission levels of other frequencies were very low against the limit.
3. Margin value = Emission level - Limit value
4. Correction factor = Insertion loss + Cable loss
5. Emission Level = Correction Factor + Reading Value.

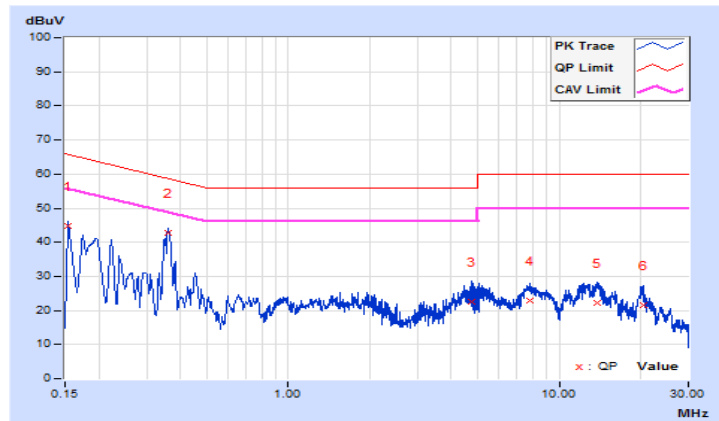

Phase	Line (L)	Detector Function	Quasi-Peak (QP) / Average (AV)
Test Mode	C		

No	Freq. [MHz]	Corr. Factor (dB)	Reading Value [dB (uV)]		Emission Level [dB (uV)]		Limit [dB (uV)]		Margin (dB)	
			Q.P.	AV.	Q.P.	AV.	Q.P.	AV.	Q.P.	AV.
			1	0.20458	9.66	29.88	18.81	39.54	28.47	63.42
2	0.62702	9.71	23.18	18.26	32.89	27.97	56.00	46.00	-23.11	-18.03
3	4.74034	9.85	26.58	21.06	36.43	30.91	56.00	46.00	-19.57	-15.09
4	7.12153	9.89	27.88	21.70	37.77	31.59	60.00	50.00	-22.23	-18.41
5	16.37650	9.97	33.77	31.68	43.74	41.65	60.00	50.00	-16.26	-8.35
<b>6</b>	<b>17.86621</b>	<b>9.97</b>	<b>36.08</b>	<b>35.60</b>	<b>46.05</b>	<b>45.57</b>	<b>60.00</b>	<b>50.00</b>	<b>-13.95</b>	<b>-4.43</b>

Remarks:

1. Q.P. and AV. are abbreviations of quasi-peak and average individually.
2. The emission levels of other frequencies were very low against the limit.
3. Margin value = Emission level - Limit value
4. Correction factor = Insertion loss + Cable loss
5. Emission Level = Correction Factor + Reading Value.

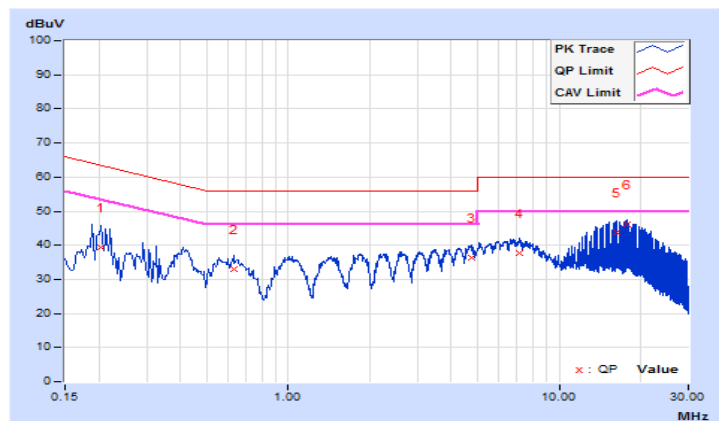

Phase	Neutral (N)	Detector Function	Quasi-Peak (QP) / Average (AV)
Test Mode	C		

No	Freq. [MHz]	Corr. Factor (dB)	Reading Value [dB (uV)]		Emission Level [dB (uV)]		Limit [dB (uV)]		Margin (dB)	
			Q.P.	AV.	Q.P.	AV.	Q.P.	AV.	Q.P.	AV.
			1	0.21226	9.64	28.87	16.22	38.51	25.86	63.12
2	0.32204	9.65	26.39	11.98	36.04	21.63	59.65	49.65	-23.61	-28.02
3	0.65044	9.68	23.56	18.58	33.24	28.26	56.00	46.00	-22.76	-17.74
4	4.69342	9.82	26.81	21.44	36.63	31.26	56.00	46.00	-19.37	-14.74
5	6.68752	9.85	28.01	21.62	37.86	31.47	60.00	50.00	-22.14	-18.53
6	17.83493	10.02	29.24	13.94	39.26	23.96	60.00	50.00	-20.74	-26.04

Remarks:

1. Q.P. and AV. are abbreviations of quasi-peak and average individually.
2. The emission levels of other frequencies were very low against the limit.
3. Margin value = Emission level - Limit value
4. Correction factor = Insertion loss + Cable loss
5. Emission Level = Correction Factor + Reading Value.

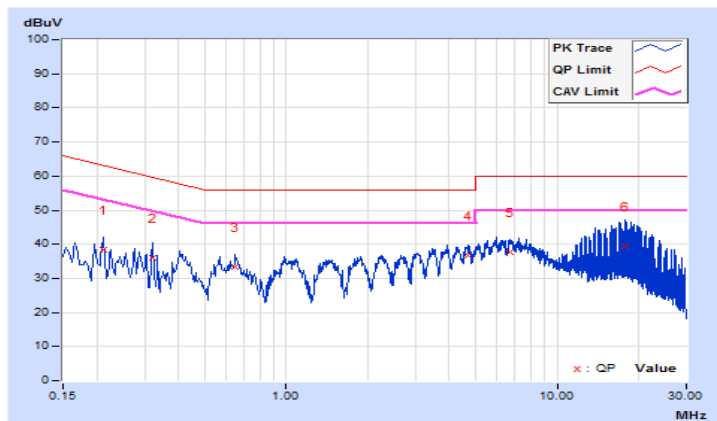

### 4.3 Transmit Power Measurement

#### 4.3.1 Limits of Transmit Power Measurement

Operation Band	EUT Category	Limit
U-NII-1	Outdoor Access Point	1 Watt (30 dBm) (Max. e.i.r.p $\leq$ 125mW(21 dBm) at any elevation angle above 30 degrees as measured from the horizon)
	Fixed point-to-point Access Point	1 Watt (30 dBm)
	Indoor Access Point	1 Watt (30 dBm)
	Mobile and Portable client device	250mW (24 dBm)
U-NII-2A	√	250mW (24 dBm) or 11 dBm+10 log B*
U-NII-2C	√	250mW (24 dBm) or 11 dBm+10 log B*
U-NII-3	√	1 Watt (30 dBm)

\*B is the 26 dB emission bandwidth in megahertz

Per KDB 662911 Method of conducted output power measurement on IEEE 802.11 devices,

Array Gain = 0 dB (i.e., no array gain) for  $N_{ANT} \leq 4$ ;

Array Gain = 0 dB (i.e., no array gain) for channel widths  $\geq 40$  MHz for any  $N_{ANT}$ ;

Array Gain =  $5 \log(N_{ANT}/N_{SS})$  dB or 3 dB, whichever is less for 20-MHz channel widths with  $N_{ANT} \geq 5$ .

For power measurements on all other devices: Array Gain =  $10 \log(N_{ANT}/N_{SS})$  dB.

#### 4.3.2 Test Setup

For Power Output

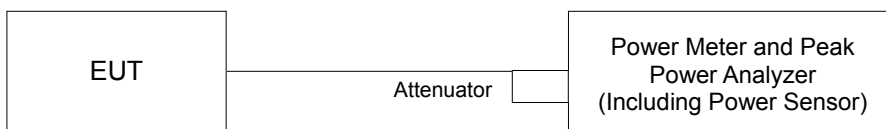

For 26dB Bandwidth

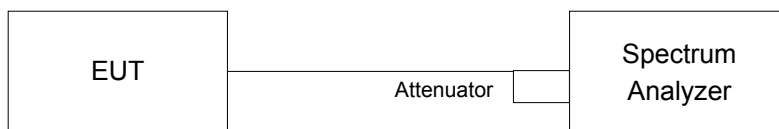

#### 4.3.3 Test Instruments

Refer to section 4.1.2 to get information of above instrument.

#### 4.3.4 Test Procedure

##### For Average Power Measurement

Method PM is used to perform output power measurement, trigger and gating function of wide band power meter is enabled to measure max output power of TX on burst and set the detector to average. Duty factor is not added to measured value.

For transmission above 5.725 GHz where the EBW crosses 5.725 GHz

For channel aggregation (channel 138, 142, 144) measurement refer to KDB 789033 D02 Section III. CHANNEL AGGREGATION.

##### For 26dB Bandwidth

- a. Set RBW = approximately 1% of the emission bandwidth.
- b. Set the VBW > RBW.
- c. Detector = Peak.
- d. Trace mode = max hold.
- e. Measure the maximum width of the emission that is 26 dB down from the peak of the emission. Compare this with the RBW setting of the analyzer. Readjust RBW and repeat measurement as needed until the RBW/EBW ratio is approximately 1%.

#### 4.3.5 Deviation from Test Standard

No deviation.

#### 4.3.6 EUT Operating Conditions

The software provided by client to enable the EUT under transmission condition continuously at lowest, middle and highest channel frequencies individually.

### 4.3.7 Test Result

Power Output:

CDD Mode

802.11a

Chan.	Freq. (MHz)	Maximum Conducted Power (dBm)			Total Power (mW)	Total Power (dBm)	Power Limit (dBm)	Pass / Fail
		Chain 0	Chain 1	Chain 2				
52	5260	15.63	16.31	15.81	117.422	20.70	23.90	Pass
60	5300	15.96	16.52	16.20	126.008	21.00	23.88	Pass
64	5320	15.49	16.24	16.02	117.467	20.70	23.89	Pass
100	5500	16.05	16.11	16.09	121.748	20.85	23.90	Pass
116	5580	16.11	16.29	16.13	124.412	20.95	23.96	Pass
140	5700	16.32	16.65	16.19	130.684	21.16	23.99	Pass
144	5720 (For U-NII-2C)	13.77	14.29	12.39	71.523	18.54	22.68	Pass
144	5720 (For U-NII-3)	6.61	6.65	7.12	15.098	11.79	30.00	Pass

Note:

For U-NII-2A, U-NII-2C Band:

Chain 0

1.  $11\text{dBm} + 10\log(19.92) = 23.99 < 24\text{dBm}$
2.  $11\text{dBm} + 10\log(19.94) = 23.99 < 24\text{dBm}$
3.  $11\text{dBm} + 10\log(19.91) = 23.99 < 24\text{dBm}$
4.  $11\text{dBm} + 10\log(20.05) = 24.02 > 24\text{dBm}$
5.  $11\text{dBm} + 10\log(19.92) = 23.99 < 24\text{dBm}$
6.  $11\text{dBm} + 10\log(19.97) = 24.00 < 24\text{dBm}$
7.  $11\text{dBm} + 10\log(5725.00 - 5709.79) = 22.82 < 24\text{dBm}$

Chain 1

1.  $11\text{dBm} + 10\log(19.52) = 23.90 < 24\text{dBm}$
2.  $11\text{dBm} + 10\log(19.44) = 23.88 < 24\text{dBm}$
3.  $11\text{dBm} + 10\log(19.48) = 23.89 < 24\text{dBm}$
4.  $11\text{dBm} + 10\log(19.53) = 23.90 < 24\text{dBm}$
5.  $11\text{dBm} + 10\log(19.85) = 23.97 < 24\text{dBm}$
6.  $11\text{dBm} + 10\log(19.91) = 23.99 < 24\text{dBm}$
7.  $11\text{dBm} + 10\log(5725.00 - 5709.79) = 22.82 < 24\text{dBm}$

Chain 2

1.  $11\text{dBm} + 10\log(19.95) = 23.99 < 24\text{dBm}$
2.  $11\text{dBm} + 10\log(20.05) = 24.02 > 24\text{dBm}$
3.  $11\text{dBm} + 10\log(19.77) = 23.96 < 24\text{dBm}$
4.  $11\text{dBm} + 10\log(20.10) = 24.03 > 24\text{dBm}$
5.  $11\text{dBm} + 10\log(19.78) = 23.96 < 24\text{dBm}$
6.  $11\text{dBm} + 10\log(20.05) = 24.02 > 24\text{dBm}$
7.  $11\text{dBm} + 10\log(5725.00 - 5710.27) = 22.68 < 24\text{dBm}$

802.11n (HT20)

Chan.	Freq. (MHz)	Maximum Conducted Power (dBm)			Total Power (mW)	Total Power (dBm)	Power Limit (dBm)	Pass / Fail
		Chain 0	Chain 1	Chain 2				
52	5260	16.15	16.78	16.69	135.519	21.32	24.00	Pass
60	5300	16.41	17.05	17.01	144.685	21.60	24.00	Pass
64	5320	16.41	16.89	16.78	140.260	21.47	24.00	Pass
100	5500	16.30	16.49	16.44	131.279	21.18	24.00	Pass
116	5580	16.41	16.68	16.49	134.877	21.30	24.00	Pass
140	5700	16.63	17.06	16.65	143.080	21.56	24.00	Pass
144	5720 (For U-NII-2C)	14.51	15.10	14.34	89.753	19.53	22.84	Pass
144	5720 (For U-NII-3)	9.27	8.96	8.43	23.815	13.77	30.00	Pass

Note:

For U-NII-2A, U-NII-2C Band:

Chain 0

1.  $11\text{dBm} + 10\log(20.65) = 24.14 > 24\text{dBm}$
2.  $11\text{dBm} + 10\log(20.61) = 24.14 > 24\text{dBm}$
3.  $11\text{dBm} + 10\log(20.61) = 24.14 > 24\text{dBm}$
4.  $11\text{dBm} + 10\log(20.62) = 24.14 > 24\text{dBm}$
5.  $11\text{dBm} + 10\log(20.69) = 24.15 > 24\text{dBm}$
6.  $11\text{dBm} + 10\log(20.81) = 24.18 > 24\text{dBm}$
7.  $11\text{dBm} + 10\log(5725.00 - 5709.69) = 22.84 < 24\text{dBm}$

Chain 1

1.  $11\text{dBm} + 10\log(20.72) = 24.16 > 24\text{dBm}$
2.  $11\text{dBm} + 10\log(20.64) = 24.14 > 24\text{dBm}$
3.  $11\text{dBm} + 10\log(20.60) = 24.13 > 24\text{dBm}$
4.  $11\text{dBm} + 10\log(20.79) = 24.17 > 24\text{dBm}$
5.  $11\text{dBm} + 10\log(20.43) = 24.10 > 24\text{dBm}$
6.  $11\text{dBm} + 10\log(20.53) = 24.12 > 24\text{dBm}$
7.  $11\text{dBm} + 10\log(5725.00 - 5709.66) = 22.85 < 24\text{dBm}$

Chain 2

1.  $11\text{dBm} + 10\log(20.58) = 24.13 > 24\text{dBm}$
2.  $11\text{dBm} + 10\log(20.54) = 24.12 > 24\text{dBm}$
3.  $11\text{dBm} + 10\log(20.57) = 24.13 > 24\text{dBm}$
4.  $11\text{dBm} + 10\log(20.63) = 24.14 > 24\text{dBm}$
5.  $11\text{dBm} + 10\log(20.74) = 24.16 > 24\text{dBm}$
6.  $11\text{dBm} + 10\log(20.62) = 24.14 > 24\text{dBm}$
7.  $11\text{dBm} + 10\log(5725.00 - 5709.55) = 22.88 < 24\text{dBm}$

802.11n (HT40)

Chan.	Freq. (MHz)	Maximum Conducted Power (dBm)			Total Power (mW)	Total Power (dBm)	Power Limit (dBm)	Pass / Fail
		Chain 0	Chain 1	Chain 2				
54	5270	18.21	19.01	18.85	<b>222.574</b>	23.47	24.00	Pass
62	5310	18.23	19.02	18.75	221.315	23.45	24.00	Pass
102	5510	18.45	19.65	19.01	<b>241.857</b>	23.84	24.00	Pass
110	5550	18.56	19.35	19.05	238.231	23.77	24.00	Pass
134	5670	18.19	19.01	18.65	218.815	23.40	24.00	Pass
142	5710 (For U-NII-2C)	17.41	17.75	17.20	174.756	22.42	24.00	Pass
142	5710 (For U-NII-3)	5.36	6.53	5.75	12.226	10.87	30.00	Pass

Note:

For U-NII-2A, U-NII-2C Band:

Chain 0

1.  $11\text{dBm} + 10\log(40.74) = 27.10 > 24\text{dBm}$
2.  $11\text{dBm} + 10\log(40.72) = 27.09 > 24\text{dBm}$
3.  $11\text{dBm} + 10\log(40.93) = 27.12 > 24\text{dBm}$
4.  $11\text{dBm} + 10\log(40.91) = 27.11 > 24\text{dBm}$
5.  $11\text{dBm} + 10\log(40.73) = 27.09 > 24\text{dBm}$
6.  $11\text{dBm} + 10\log(5725.00 - 5689.55) = 26.49 > 24\text{dBm}$

Chain 1

1.  $11\text{dBm} + 10\log(40.72) = 27.09 > 24\text{dBm}$
2.  $11\text{dBm} + 10\log(40.69) = 27.09 > 24\text{dBm}$
3.  $11\text{dBm} + 10\log(40.81) = 27.10 > 24\text{dBm}$
4.  $11\text{dBm} + 10\log(40.89) = 27.11 > 24\text{dBm}$
5.  $11\text{dBm} + 10\log(40.96) = 27.12 > 24\text{dBm}$
6.  $11\text{dBm} + 10\log(5725.00 - 5689.47) = 26.50 > 24\text{dBm}$

Chain 2

1.  $11\text{dBm} + 10\log(40.64) = 27.08 > 24\text{dBm}$
2.  $11\text{dBm} + 10\log(40.67) = 27.09 > 24\text{dBm}$
3.  $11\text{dBm} + 10\log(40.81) = 27.10 > 24\text{dBm}$
4.  $11\text{dBm} + 10\log(40.87) = 27.11 > 24\text{dBm}$
5.  $11\text{dBm} + 10\log(40.80) = 27.10 > 24\text{dBm}$
6.  $11\text{dBm} + 10\log(5725.00 - 5689.66) = 26.48 > 24\text{dBm}$

802.11ac (VHT80)

Chan.	Freq. (MHz)	Maximum Conducted Power (dBm)			Total Power (mW)	Total Power (dBm)	Power Limit (dBm)	Pass / Fail
		Chain 0	Chain 1	Chain 2				
58	5290	17.81	18.91	18.77	213.535	23.29	24.00	Pass
106	5530	18.01	18.88	18.75	215.498	23.33	24.00	Pass
122	5610	18.25	19.21	19.02	230.001	23.62	24.00	Pass
138	5690 (For U-NII-2C)	17.02	17.47	17.20	170.895	22.33	24.00	Pass
138	5690 (For U-NII-3)	3.77	2.55	0.44	5.695	7.55	30.00	Pass

Note:

For U-NII-2A, U-NII-2C Band:

Chain 0

1.  $11\text{dBm} + 10\log(83.65) = 30.22 > 24\text{dBm}$
2.  $11\text{dBm} + 10\log(84.04) = 30.24 > 24\text{dBm}$
3.  $11\text{dBm} + 10\log(84.25) = 30.25 > 24\text{dBm}$
4.  $11\text{dBm} + 10\log(5725.00 - 5648.00) = 29.86 > 24\text{dBm}$

Chain 1

1.  $11\text{dBm} + 10\log(83.99) = 30.24 > 24\text{dBm}$
2.  $11\text{dBm} + 10\log(84.31) = 30.25 > 24\text{dBm}$
3.  $11\text{dBm} + 10\log(84.37) = 30.26 > 24\text{dBm}$
4.  $11\text{dBm} + 10\log(5725.00 - 5648.34) = 29.84 > 24\text{dBm}$

Chain 2

1.  $11\text{dBm} + 10\log(84.36) = 30.26 > 24\text{dBm}$
2.  $11\text{dBm} + 10\log(84.38) = 30.26 > 24\text{dBm}$
3.  $11\text{dBm} + 10\log(83.97) = 30.24 > 24\text{dBm}$
4.  $11\text{dBm} + 10\log(5725.00 - 5647.58) = 29.88 > 24\text{dBm}$

## Beamforming Mode

### 802.11n (HT20)

Chan.	Freq. (MHz)	Maximum Conducted Power (dBm)			Total Power (mW)	Total Power (dBm)	Power Limit (dBm)	Pass / Fail
		Chain 0	Chain 1	Chain 2				
52	5260	11.38	12.01	11.92	45.185	16.55	21.23	Pass
60	5300	11.64	12.28	12.24	48.241	16.83	21.23	Pass
64	5320	11.64	12.12	12.01	46.766	16.70	21.23	Pass
100	5500	11.53	11.72	11.67	43.771	16.41	21.23	Pass
116	5580	11.64	11.91	11.72	44.971	16.53	21.23	Pass
140	5700	11.86	12.29	11.88	47.706	16.79	21.23	Pass
144	5720 (For U-NII-2C)	9.74	10.33	9.57	29.925	14.76	21.23	Pass
144	5720 (For U-NII-3)	4.50	4.19	3.66	7.940	9.00	27.23	Pass

Note:

- 5260~5320MHz & 5500~5720MHz (For U-NII-2C): Directional Gain = 4dBi + 10log(3) = 8.77dBi > 6dBi, so the limit shall be reduced to 24-(8.77-6) = 21.23dBm.
- 5720MHz (For U-NII-3) Directional Gain = 4dBi + 10log(3) = 8.77dBi > 6dBi, so the limit shall be reduced to 30-(8.77-6) = 27.23dBm.

For U-NII-2A, U-NII-2C Band:

Chain 0

- 11dBm + 10log (19.92) = 23.99 > 21.23dBm
- 11dBm + 10log (19.94) = 23.99 > 21.23dBm
- 11dBm + 10log (19.91) = 23.99 > 21.23dBm
- 11dBm + 10log (20.05) = 24.02 > 21.23dBm
- 11dBm + 10log (19.92) = 23.99 > 21.23dBm
- 11dBm + 10log (19.97) = 24.00 > 21.23dBm
- 11dBm + 10log (5725.00 - 5709.79) = 22.82 > 21.23dBm

Chain 1

- 11dBm + 10log (19.52) = 23.90 > 21.23dBm
- 11dBm + 10log (19.44) = 23.88 > 21.23dBm
- 11dBm + 10log (19.48) = 23.89 > 21.23dBm
- 11dBm + 10log (19.53) = 23.90 > 21.23dBm
- 11dBm + 10log (19.85) = 23.97 > 21.23dBm
- 11dBm + 10log (19.91) = 23.99 > 21.23dBm
- 11dBm + 10log (5725.00 - 5709.79) = 22.82 > 21.23dBm

Chain 2

- 11dBm + 10log (19.95) = 23.99 > 21.23dBm
- 11dBm + 10log (20.05) = 24.02 > 21.23dBm
- 11dBm + 10log (19.77) = 23.96 > 21.23dBm
- 11dBm + 10log (20.10) = 24.03 > 21.23dBm
- 11dBm + 10log (19.78) = 23.96 > 21.23dBm
- 11dBm + 10log (20.05) = 24.02 > 21.23dBm
- 11dBm + 10log (5725.00 - 5710.27) = 22.68 > 21.23dBm

802.11n (HT40)

Chan.	Freq. (MHz)	Maximum Conducted Power (dBm)			Total Power (mW)	Total Power (dBm)	Power Limit (dBm)	Pass / Fail
		Chain 0	Chain 1	Chain 2				
54	5270	13.44	14.24	14.08	<b>74.212</b>	18.70	21.23	Pass
62	5310	13.46	14.25	13.98	73.792	18.68	21.23	Pass
102	5510	13.68	14.88	14.24	<b>80.642</b>	19.07	21.23	Pass
110	5550	13.79	14.58	14.28	79.433	19.00	21.23	Pass
134	5670	13.42	14.24	13.88	72.959	18.63	21.23	Pass
142	5710 (For U-NII-2C)	12.64	12.98	12.43	58.267	17.65	21.23	Pass
142	5710 (For U-NII-3)	0.59	1.76	0.98	4.077	6.10	27.23	Pass

Note:

- 5260~5320MHz & 5500~5720MHz (For U-NII-2C): Directional Gain = 4dBi + 10log(3) = 8.77dBi > 6dBi, so the limit shall be reduced to 24-(8.77-6) = 21.23dBm.
- 5720MHz (For U-NII-3) Directional Gain = 4dBi + 10log(3) = 8.77dBi > 6dBi, so the limit shall be reduced to 30-(8.77-6) = 27.23dBm.

For U-NII-2A, U-NII-2C Band:

Chain 0

- 11dBm + 10log (20.65) = 24.14 > 21.23dBm
- 11dBm + 10log (20.61) = 24.14 > 21.23dBm
- 11dBm + 10log (20.61) = 24.14 > 21.23dBm
- 11dBm + 10log (20.62) = 24.14 > 21.23dBm
- 11dBm + 10log (20.69) = 24.15 > 21.23dBm
- 11dBm + 10log (20.81) = 24.18 > 21.23dBm
- 11dBm + 10log (5725.00 - 5709.69) = 22.84 > 21.23dBm

Chain 1

- 11dBm + 10log (20.72) = 24.16 > 21.23dBm
- 11dBm + 10log (20.64) = 24.14 > 21.23dBm
- 11dBm + 10log (20.60) = 24.13 > 21.23dBm
- 11dBm + 10log (20.79) = 24.17 > 21.23dBm
- 11dBm + 10log (20.43) = 24.10 > 21.23dBm
- 11dBm + 10log (20.53) = 24.12 > 21.23dBm
- 11dBm + 10log (5725.00 - 5709.66) = 22.85 > 21.23dBm

Chain 2

- 11dBm + 10log (20.58) = 24.13 > 24dBm
- 11dBm + 10log (20.54) = 24.12 > 24dBm
- 11dBm + 10log (20.57) = 24.13 > 24dBm
- 11dBm + 10log (20.63) = 24.14 > 24dBm
- 11dBm + 10log (20.74) = 24.16 > 24dBm
- 11dBm + 10log (20.62) = 24.14 > 24dBm
- 11dBm + 10log (5725.00 - 5709.55) = 22.88 > 21.23dBm

802.11ac (VHT80)

Chan.	Freq. (MHz)	Maximum Conducted Power (dBm)			Total Power (mW)	Total Power (dBm)	Power Limit (dBm)	Pass / Fail
		Chain 0	Chain 1	Chain 2				
58	5290	13.04	14.14	14.00	71.198	18.52	21.23	Pass
106	5530	13.24	14.11	13.98	71.852	18.56	21.23	Pass
122	5610	13.48	14.44	14.25	76.688	18.85	21.23	Pass
138	5690 (For U-NII-2C)	12.25	12.70	12.43	56.98	17.56	21.23	Pass
138	5690 (For U-NII-3)	-1.00	-2.22	-4.33	1.8988	2.78	27.23	Pass

Note:

- 5260~5320MHz & 5500~5720MHz (For U-NII-2C): Directional Gain = 4dBi + 10log(3) = 8.77dBi > 6dBi, so the limit shall be reduced to 24-(8.77-6) = 21.23dBm.
- 5720MHz (For U-NII-3) Directional Gain = 4dBi + 10log(3) = 8.77dBi > 6dBi, so the limit shall be reduced to 30-(8.77-6) = 27.23dBm.

For U-NII-2A, U-NII-2C Band:

Chain 0

- 11dBm + 10log(40.74) = 27.10 > 21.23dBm
- 11dBm + 10log(40.72) = 27.09 > 21.23dBm
- 11dBm + 10log(40.93) = 27.12 > 21.23dBm
- 11dBm + 10log(40.91) = 27.11 > 21.23dBm
- 11dBm + 10log(40.73) = 27.09 > 21.23dBm
- 11dBm + 10log(5725.00 - 5689.55) = 26.49 > 21.23dBm

Chain 1

- 11dBm + 10log(40.72) = 27.09 > 21.23dBm
- 11dBm + 10log(40.69) = 27.09 > 21.23dBm
- 11dBm + 10log(40.81) = 27.10 > 24dBm
- 11dBm + 10log(40.89) = 27.11 > 21.23dBm
- 11dBm + 10log(40.96) = 27.12 > 21.23dBm
- 11dBm + 10log(5725.00 - 5689.47) = 26.50 > 21.23dBm

Chain 2

- 11dBm + 10log(40.64) = 27.08 > 21.23dBm
- 11dBm + 10log(40.67) = 27.09 > 21.23dBm
- 11dBm + 10log(40.81) = 27.10 > 21.23dBm
- 11dBm + 10log(40.87) = 27.11 > 21.23dBm
- 11dBm + 10log(40.80) = 27.10 > 21.23dBm
- 11dBm + 10log(5725.00 - 5689.66) = 26.48 > 21.23dBm

26dB Bandwidth:

802.11a

Chan.	Freq. (MHz)	26dBc Bandwidth (MHz)		
		Chain 0	Chain 1	Chain 2
52	5260	19.92	19.52	19.95
60	5300	19.94	19.44	20.05
64	5320	19.91	19.48	19.77
100	5500	20.05	19.53	20.10
116	5580	19.92	19.85	19.78
140	5700	19.97	19.91	20.05
144	5720 (For U-NII-2C)	15.21	15.21	14.73
144	5720 (For U-NII-3)	4.76	4.86	4.98

802.11n (HT20)

Chan.	Freq. (MHz)	26dBc Bandwidth (MHz)		
		Chain 0	Chain 1	Chain 2
52	5260	20.65	20.72	20.58
60	5300	20.61	20.64	20.54
64	5320	20.61	20.60	20.57
100	5500	20.62	20.79	20.63
116	5580	20.69	20.43	20.74
140	5700	20.81	20.53	20.62
144	5720 (For U-NII-2C)	15.31	15.34	15.45
144	5720 (For U-NII-3)	5.38	5.21	5.37

802.11n (HT40)

Chan.	Freq. (MHz)	26dBc Bandwidth (MHz)		
		Chain 0	Chain 1	Chain 2
54	5270	40.74	40.72	40.64
62	5310	40.72	40.69	40.67
102	5510	40.93	40.81	40.81
110	5550	40.91	40.89	40.87
134	5670	40.73	40.96	40.80
142	5710 (For U-NII-2C)	35.45	35.53	35.34
142	5710 (For U-NII-3)	5.42	5.48	5.38

802.11ac (VHT80)

Chan.	Freq. (MHz)	26dBc Bandwidth (MHz)		
		Chain 0	Chain 1	Chain 2
58	5290	83.65	83.99	84.36
106	5530	84.04	84.31	84.38
122	5610	84.25	84.37	83.97
138	5690 (For U-NII-2C)	77.00	76.66	77.42
138	5690 (For U-NII-3)	6.91	7.18	7.51

Spectrum Plot of Worst Value

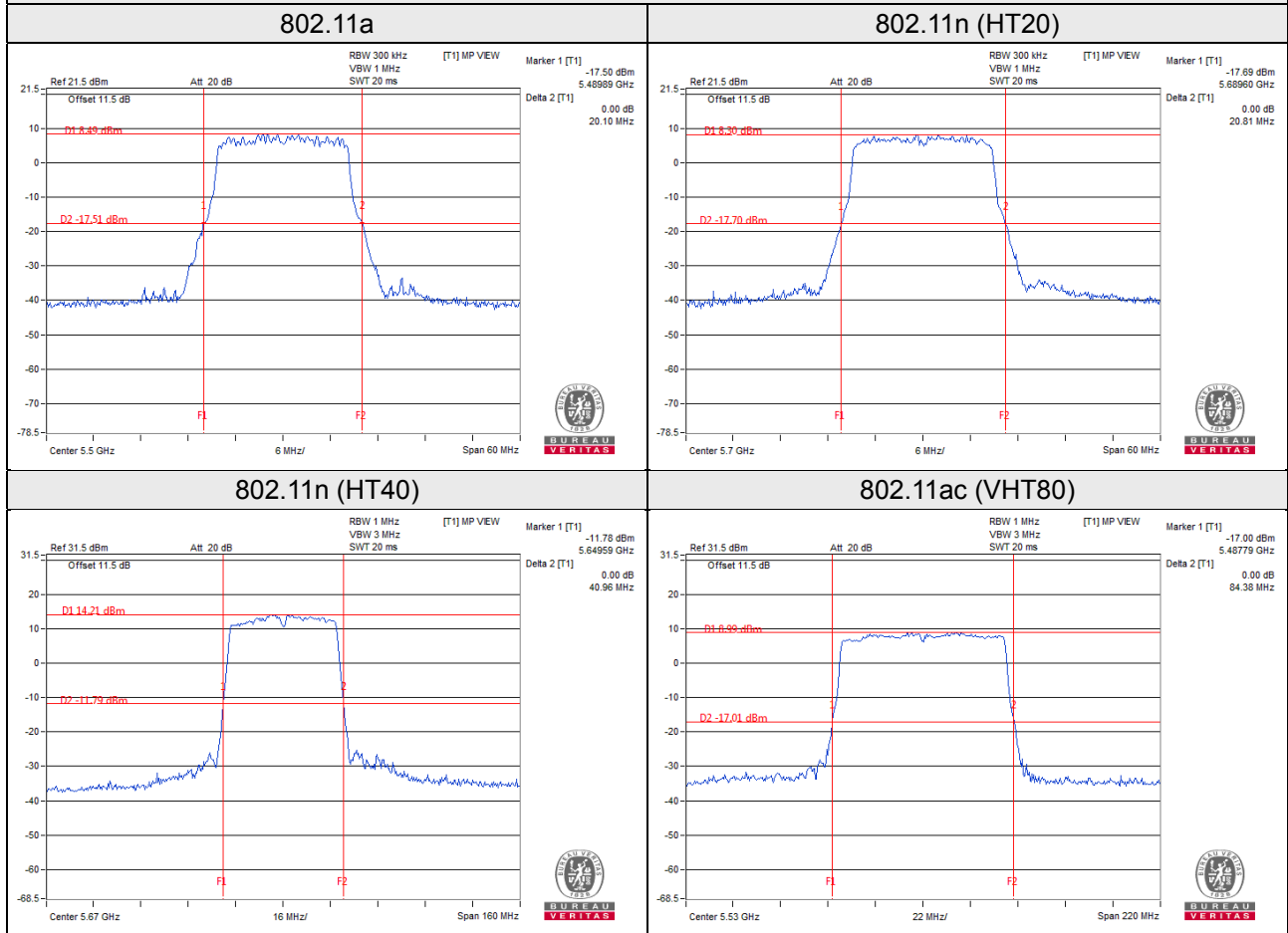

EUT Maximum Conducted Power

CDD Mode

802.11a

Frequency Band (MHz)	Max. Power	
	Output Power (dBm)	Output Power (mW)
5250~5350	21.00	126.008
5470~5725	21.16	130.684

802.11n (HT20)

Frequency Band (MHz)	Max. Power	
	Output Power (dBm)	Output Power (mW)
5250~5350	21.60	144.685
5470~5725	21.56	143.080

802.11n (HT40)

Frequency Band (MHz)	Max. Power	
	Output Power (dBm)	Output Power (mW)
5250~5350	23.47	222.574
5470~5725	23.84	241.857

802.11ac (VHT80)

Frequency Band (MHz)	Max. Power	
	Output Power (dBm)	Output Power (mW)
5250~5350	23.29	213.535
5470~5725	23.62	230.001

### Beamforming Mode

#### 802.11n (HT20)

Frequency Band (MHz)	Max. Power	
	Output Power (dBm)	Output Power (mW)
5250~5350	16.83	48.241
5470~5725	16.79	47.706

#### 802.11n (HT40)

Frequency Band (MHz)	Max. Power	
	Output Power (dBm)	Output Power (mW)
5250~5350	18.70	74.212
5470~5725	19.07	80.642

#### 802.11ac (VHT80)

Frequency Band (MHz)	Max. Power	
	Output Power (dBm)	Output Power (mW)
5250~5350	18.52	71.198
5470~5725	18.85	76.688

## 4.4 Occupied Bandwidth Measurement

### 4.4.1 Test Setup

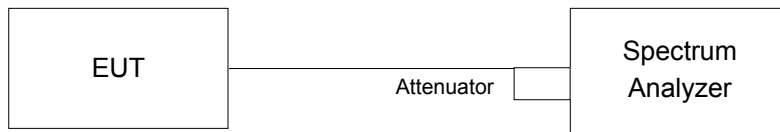

### 4.4.2 Test Instruments

Refer to section 4.1.2 to get information of above instrument.

### 4.4.3 Test Procedure

The transmitter output was connected to the spectrum analyzer through an attenuator. The bandwidth of the fundamental frequency was measured by spectrum analyzer with resolution bandwidth in the range of 1% to 5% of the anticipated emission bandwidth, and a video bandwidth at least 3x the resolution bandwidth and set the detector to sampling. The width of a frequency band such that, below the lower and above the upper frequency limits, the mean powers emitted are each equal to a specified percentage 0.5 %of the total mean power of a given emission.

#### 4.4.4 Test Result

##### 802.11a

Chan.	Freq. (MHz)	Occupied Bandwidth (MHz)		
		Chain 0	Chain 1	Chain 2
52	5260	16.44	16.44	16.44
60	5300	16.44	16.44	16.44
64	5320	16.44	16.44	16.44
100	5500	16.44	16.44	16.44
116	5580	16.44	16.44	16.44
140	5700	16.44	16.44	16.44
144	5720 (For U-NII-2C)	13.28	13.28	13.28
144	5720 (For U-NII-3)	3.04	3.16	3.04

##### 802.11n (HT20)

Chan.	Freq. (MHz)	Occupied Bandwidth (MHz)		
		Chain 0	Chain 1	Chain 2
52	5260	17.64	17.64	17.64
60	5300	17.64	17.64	17.64
64	5320	17.64	17.64	17.52
100	5500	17.64	17.64	17.64
116	5580	17.64	17.64	17.64
140	5700	17.64	17.64	17.64
144	5720 (For U-NII-2C)	13.88	13.88	13.88
144	5720 (For U-NII-3)	3.64	3.64	3.64

##### 802.11n (HT40)

Chan.	Freq. (MHz)	Occupied Bandwidth (MHz)		
		Chain 0	Chain 1	Chain 2
54	5270	36.00	36.00	36.12
62	5310	36.00	36.00	36.12
102	5510	36.12	36.12	36.24
110	5550	36.12	36.12	36.12
134	5670	36.00	36.24	36.00
142	5710 (For U-NII-2C)	33.12	33.12	33.00
142	5710 (For U-NII-3)	3.00	3.12	3.00

802.11ac (VHT80)

Chan.	Freq. (MHz)	Occupied Bandwidth (MHz)		
		Chain 0	Chain 1	Chain 2
58	5290	75.84	75.84	76.08
106	5530	75.84	76.08	76.08
122	5610	75.84	75.84	75.84
138	5690 (For U-NII-2C)	72.92	72.92	72.92
138	5690 (For U-NII-3)	2.92	2.92	2.92

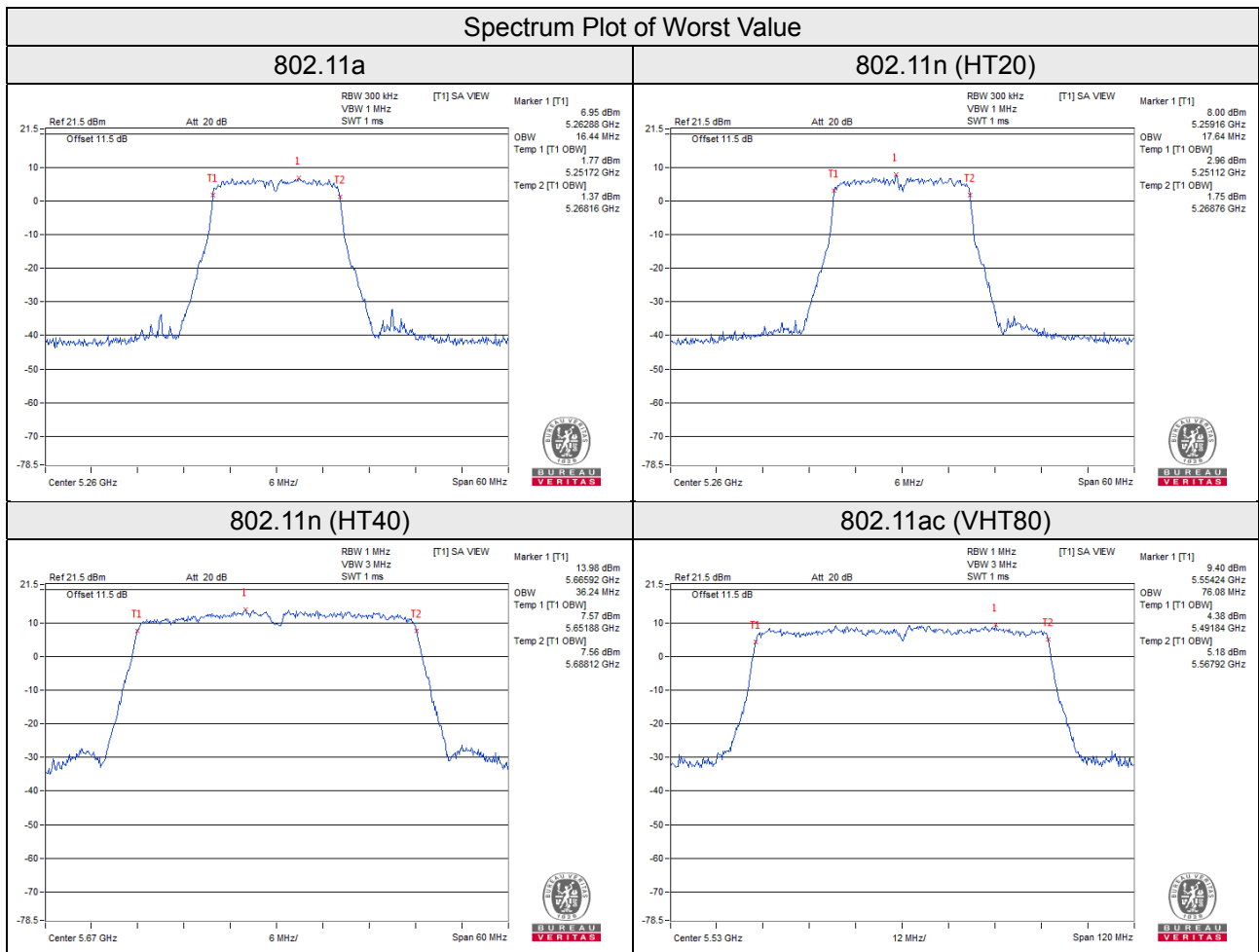

## 4.5 Peak Power Spectral Density Measurement

### 4.5.1 Limits of Peak Power Spectral Density Measurement

Operation Band	EUT Category		Limit
U-NII-1		Outdoor Access Point	17dBm/ MHz
		Fixed point-to-point Access Point	
		Indoor Access Point	
		Mobile and Portable client device	11dBm/ MHz
U-NII-2A	√		11dBm/ MHz
U-NII-2C	√		11dBm/ MHz
U-NII-3	√		30dBm/ 500kHz

### 4.5.2 Test Setup

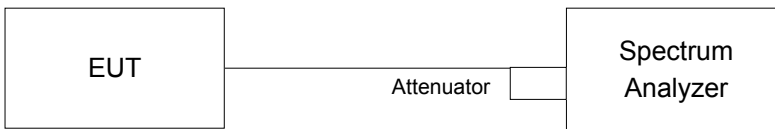

### 4.5.3 Test Instruments

Refer to section 4.1.2 to get information of above instrument.

### 4.5.4 Test Procedures

For U-NII-2A and U-NII-2C band:

Duty cycle of test signal is < 98%

Using method SA-2

- Set span to encompass the entire emission bandwidth (EBW) of the signal.
- Set RBW = 1MHz, Set VBW  $\geq$  3 MHz, Detector = RMS
- Set Channel power measure = 1MHz
- Sweep time = auto, trigger set to "free run".
- Trace average at least 100 traces in power averaging mode.
- Record the max value and add  $10 \log (1/\text{duty cycle})$

For U-NII-3 band:

Duty cycle of test signal is < 98%

- a. Set span to encompass the entire emission bandwidth (EBW) of the signal.
- b. Set RBW = 300 kHz, Set VBW  $\geq$  1 MHz, Detector = RMS
- c. Use the peak marker function to determine the maximum power level in any 300 kHz band segment within the fundamental EBW.
- d. Scale the observed power level to an equivalent value in 500 kHz by adjusting (reducing) the measured power by a bandwidth correction factor (BWCF) where  $BWCF = 10\log(500 \text{ kHz} / 300 \text{ kHz})$
- e. Sweep time = auto, trigger set to "free run".
- f. Trace average at least 100 traces in power averaging mode.
- g. Record the max value and add  $10 \log (1/\text{duty cycle})$

#### 4.5.5 Deviation from Test Standard

No deviation.

#### 4.5.6 EUT Operating Conditions

Same as 4.3.6.

#### 4.5.7 Test Results

For U-NII-2A and U-NII-2C band:

##### 802.11a

Chan.	Freq. (MHz)	PSD w/o Duty Factor (dBm/MHz)			Duty Factor (dB)	Total PSD with Duty Factor (dBm/MHz)	Max. Limit (dBm/MHz)	Pass / Fail
		Chain 0	Chain 1	Chain 2				
52	5260	2.70	2.75	3.27	0.22	7.91	8.23	Pass
60	5300	2.82	3.10	3.65	0.22	8.20	8.23	Pass
64	5320	2.56	3.12	3.41	0.22	8.04	8.23	Pass
100	5500	3.03	3.50	3.02	0.22	8.18	8.23	Pass
116	5580	3.02	3.46	3.14	0.22	8.20	8.23	Pass
140	5700	3.19	3.16	3.15	0.22	8.16	8.23	Pass
144	5720	2.78	3.04	3.06	0.22	7.95	8.23	Pass

Note:

- Method E) 2) a) of power density measurement of KDB 662911 is using for calculating total power density. Total power density is summing entire spectra across corresponding frequency bins on the various outputs by computer.
- Directional Gain =  $4\text{dBi} + 10\log(3) = 8.77\text{dBi} > 6\text{dBi}$ , so the limit shall be reduced to  $11 - (8.77 - 6) = 8.23\text{dBm}$ .
- Refer to section 3.3 for duty cycle spectrum plot.

##### 802.11n (HT20)

Chan.	Freq. (MHz)	PSD w/o Duty Factor (dBm/MHz)			Duty Factor (dB)	Total PSD with Duty Factor (dBm/MHz)	Max. Limit (dBm/MHz)	Pass / Fail
		Chain 0	Chain 1	Chain 2				
52	5260	2.85	2.97	3.76	0.10	8.08	8.23	Pass
60	5300	3.10	3.85	2.99	0.10	8.20	8.23	Pass
64	5320	2.98	3.57	3.46	0.10	8.22	8.23	Pass
100	5500	3.06	3.13	3.30	0.10	8.04	8.23	Pass
116	5580	3.00	3.68	3.02	0.10	8.12	8.23	Pass
140	5700	2.95	3.29	3.38	0.10	8.08	8.23	Pass
144	5720	3.05	3.84	2.94	0.10	8.17	8.23	Pass

Note:

- Method E) 2) a) of power density measurement of KDB 662911 is using for calculating total power density. Total power density is summing entire spectra across corresponding frequency bins on the various outputs by computer.
- Directional Gain =  $4\text{dBi} + 10\log(3) = 8.77\text{dBi} > 6\text{dBi}$ , so the limit shall be reduced to  $11 - (8.77 - 6) = 8.23\text{dBm}$ .
- Refer to section 3.3 for duty cycle spectrum plot.

### 802.11n (HT40)

Chan.	Freq. (MHz)	PSD w/o Duty Factor (dBm/MHz)			Duty Factor (dB)	Total PSD with Duty Factor (dBm/MHz)	Max. Limit (dBm/MHz)	Pass / Fail
		Chain 0	Chain 1	Chain 2				
54	5270	2.38	2.93	3.00	0.19	7.74	8.23	Pass
62	5310	2.49	3.36	3.38	0.19	8.06	8.23	Pass
102	5510	2.77	3.31	2.78	0.19	7.92	8.23	Pass
110	5550	2.74	3.49	2.34	0.19	7.84	8.23	Pass
134	5670	3.24	3.34	2.79	0.19	8.09	8.23	Pass
142	5710	2.68	3.71	3.06	0.19	8.13	8.23	Pass

Note:

- Method E) 2) a) of power density measurement of KDB 662911 is using for calculating total power density. Total power density is summing entire spectra across corresponding frequency bins on the various outputs by computer.
- Directional Gain = 4dBi + 10log(3) = 8.77dBi > 6dBi, so the limit shall be reduced to 11-(8.77-6) = 8.23dBm.
- Refer to section 3.3 for duty cycle spectrum plot.

### 802.11ac (VHT80)

Chan.	Freq. (MHz)	PSD w/o Duty Factor (dBm/MHz)			Duty Factor (dB)	Total PSD with Duty Factor (dBm/MHz)	Max. Limit (dBm/MHz)	Pass / Fail
		Chain 0	Chain 1	Chain 2				
58	5290	-1.29	-0.88	-0.67	0.32	4.15	8.23	Pass
106	5530	-1.56	-1.08	-1.85	0.32	3.61	8.23	Pass
122	5610	-0.44	-0.06	-1.24	0.32	4.54	8.23	Pass
138	5690	0.26	1.04	0.09	0.32	5.57	8.23	Pass

Note:

- Method E) 2) a) of power density measurement of KDB 662911 is using for calculating total power density. Total power density is summing entire spectra across corresponding frequency bins on the various outputs by computer.
- Directional Gain = 4dBi + 10log(3) = 8.77dBi > 6dBi, so the limit shall be reduced to 11-(8.77-6) = 8.23dBm.
- Refer to section 3.3 for duty cycle spectrum plot.

### Spectrum Plot of Worst Value

**802.11a / Chain 2 / CH 60**

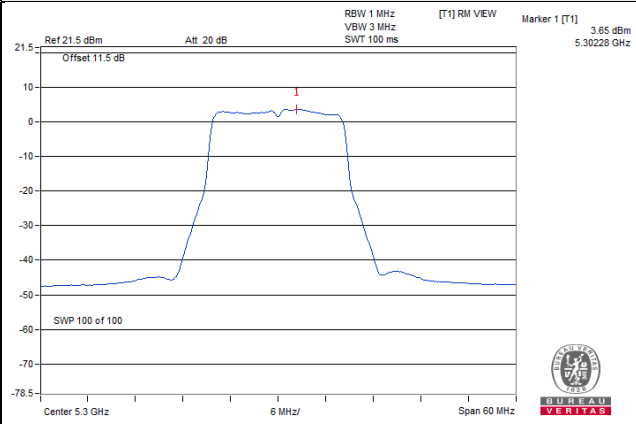

**802.11n (HT20) / Chain 1 / CH 60**

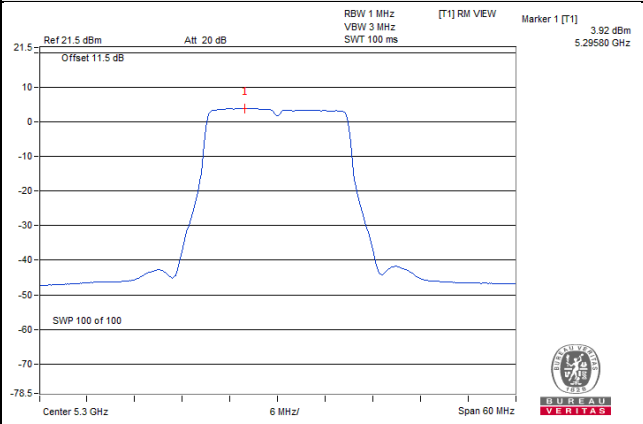

**802.11n (HT40) / Chain 1 / CH 142**

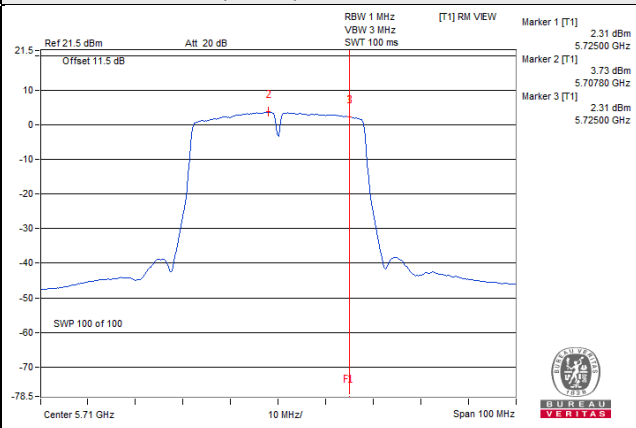

**802.11ac (VHT80) / Chain 1 / 138**

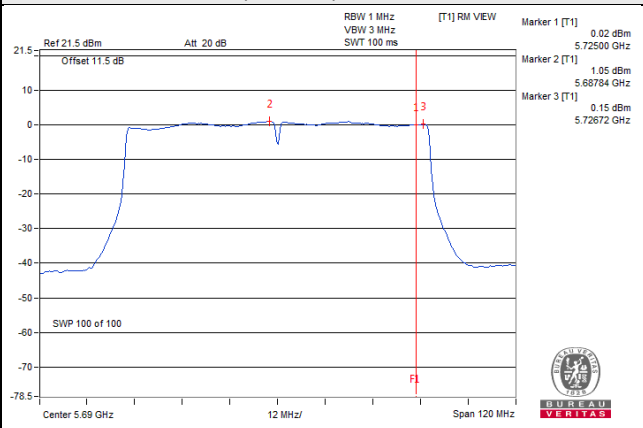

For U-NII-3 band:

802.11a

TX chain	Chan.	Freq. (MHz)	PSD w/o Duty Factor		10 log (N=3) dB	Duty Factor (dB)	Total PSD with Duty Factor (dBm/500kHz)	Limit (dBm/500 kHz)	Pass / Fail
			(dBm/300kHz)	(dBm/500kHz)					
0	144	5720	-5.58	-3.36	4.77	0.22	1.63	27.23	Pass
1	144	5720	-5.55	-3.33	4.77	0.22	1.66	27.23	Pass
2	144	5720	-5.58	-3.36	4.77	0.22	1.63	27.23	Pass

Note:

1. Method E) 2) c) of power density measurement of KDB 662911 is using for calculating total power density, Measure and add  $10 \log (N_{ANT})$  dB.
2. Directional Gain =  $4\text{dBi} + 10\log(3) = 8.77\text{dBi} > 6\text{dBi}$ , so the limit shall be reduced to  $30 - (8.77 - 6) = 27.23\text{dBm}$ .
3. Refer to section 3.3 for duty cycle spectrum plot.

802.11n (HT20)

TX chain	Chan.	Freq. (MHz)	PSD w/o Duty Factor		10 log (N=3) dB	Duty Factor (dB)	Total PSD with Duty Factor (dBm/500kHz)	Limit (dBm/500 kHz)	Pass / Fail
			(dBm/300kHz)	(dBm/500kHz)					
0	144	5720	-5.26	-3.04	4.77	0.10	1.83	27.23	Pass
1	144	5720	-5.41	-3.19	4.77	0.10	1.68	27.23	Pass
2	144	5720	-5.87	-3.65	4.77	0.10	1.22	27.23	Pass

Note:

1. Method E) 2) c) of power density measurement of KDB 662911 is using for calculating total power density, Measure and add  $10 \log (N_{ANT})$  dB.
2. Directional Gain =  $4\text{dBi} + 10\log(3) = 8.77\text{dBi} > 6\text{dBi}$ , so the limit shall be reduced to  $30 - (8.77 - 6) = 27.23\text{dBm}$ .
3. Refer to section 3.3 for duty cycle spectrum plot.

802.11n (HT40)

TX chain	Chan.	Freq. (MHz)	PSD w/o Duty Factor		10 log (N=3) dB	Duty Factor (dB)	Total PSD with Duty Factor (dBm/500kHz)	Limit (dBm/500 kHz)	Pass / Fail
			(dBm/300kHz)	(dBm/500kHz)					
0	142	5710	-7.03	-4.81	4.77	0.19	0.15	27.23	Pass
1	142	5710	-6.56	-4.34	4.77	0.19	0.62	27.23	Pass
2	142	5710	-7.10	-4.88	4.77	0.19	0.08	27.23	Pass

Note:

1. Method E) 2) c) of power density measurement of KDB 662911 is using for calculating total power density, Measure and add  $10 \log (N_{ANT})$  dB.
2. Directional Gain =  $4\text{dBi} + 10\log(3) = 8.77\text{dBi} > 6\text{dBi}$ , so the limit shall be reduced to  $30 - (8.77 - 6) = 27.23\text{dBm}$ .
3. Refer to section 3.3 for duty cycle spectrum plot.

### 802.11ac (VHT80)

TX chain	Chan.	Freq. (MHz)	PSD w/o Duty Factor		10 log (N=3) dB	Duty Factor (dB)	Total PSD with Duty Factor (dBm/500kHz)	Limit (dBm/500 kHz)	Pass / Fail
			(dBm/300kHz)	(dBm/500kHz)					
0	138	5690	-8.95	-6.73	4.77	0.32	-1.64	27.23	Pass
1	138	5690	-8.67	-6.45	4.77	0.32	-1.36	27.23	Pass
2	138	5690	-9.18	-6.96	4.77	0.32	-1.87	27.23	Pass

Note:

- Method E) 2) c) of power density measurement of KDB 662911 is using for calculating total power density, Measure and add 10 log (N<sub>ANT</sub>) dB.
- Directional Gain = 4dBi + 10log(3) = 8.77dBi > 6dBi, so the limit shall be reduced to 30-(8.77-6) = 27.23dBm.
- Refer to section 3.3 for duty cycle spectrum plot.

### Spectrum Plot of Worst Value

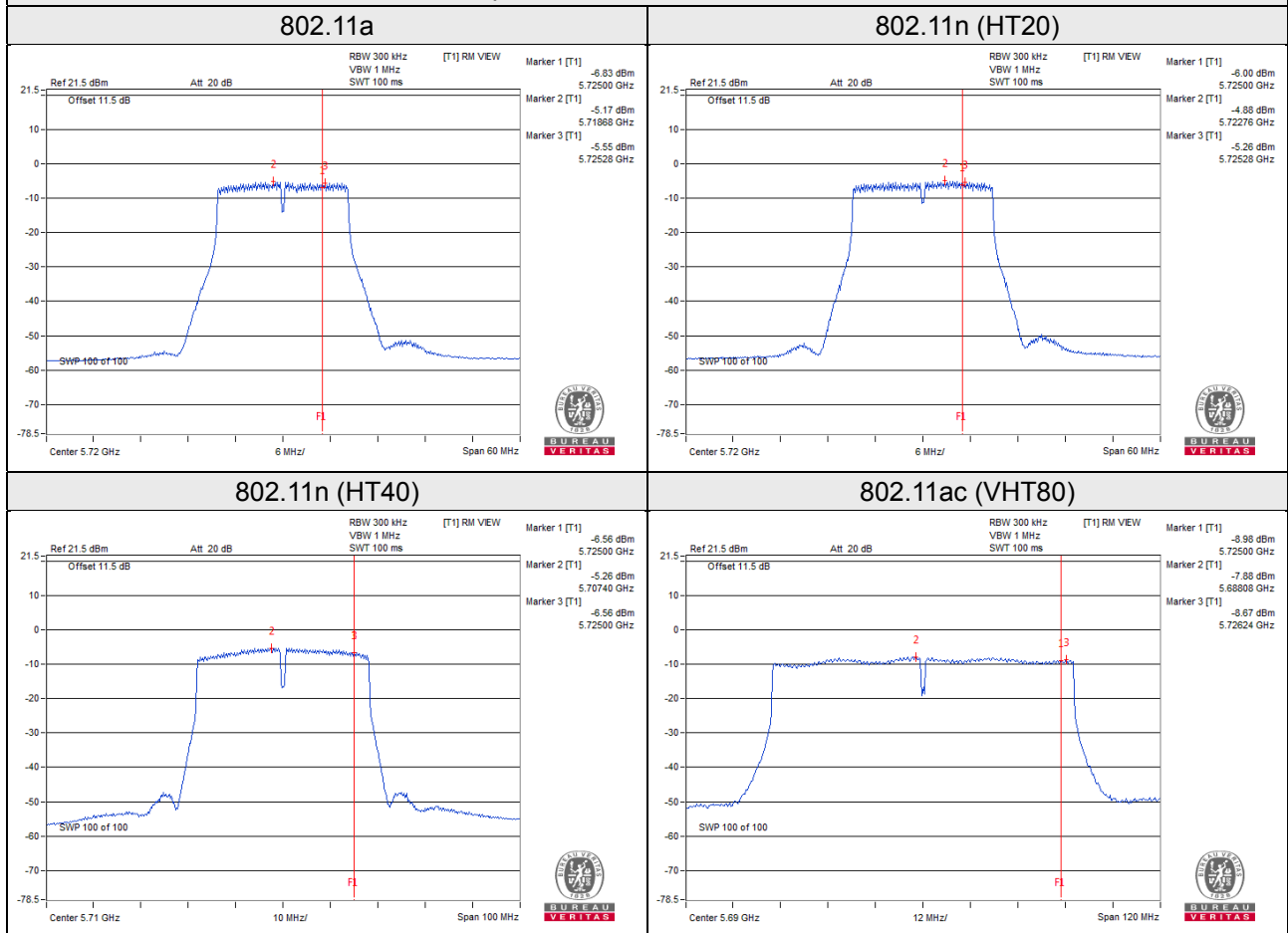

## 4.6 Frequency Stability

### 4.6.1 Limits of Frequency Stability Measurement

The frequency of the carrier signal shall be maintained within band of operation

### 4.6.2 Test Setup

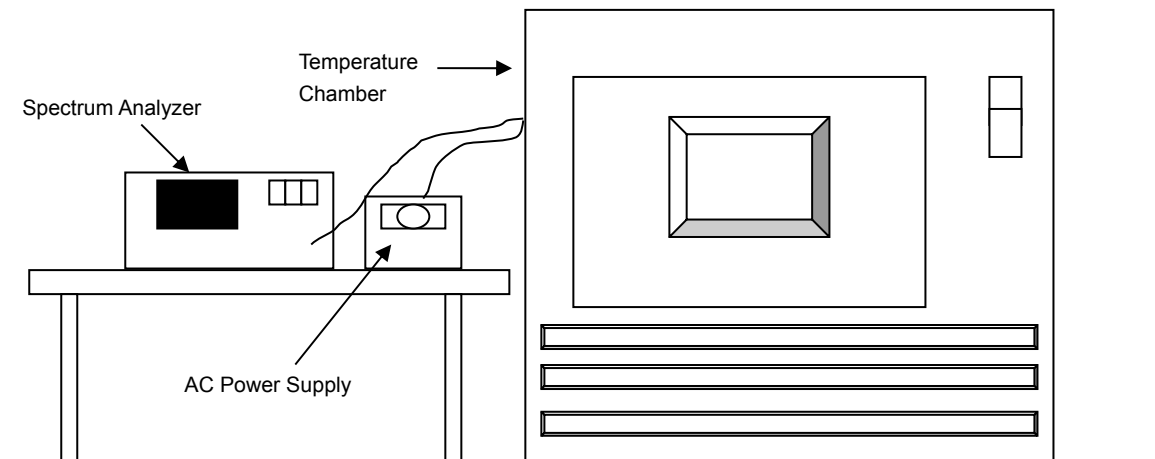

### 4.6.3 Test Instruments

Description & Manufacturer	Model No.	Serial No.	Cal. Date	Cal. Due
Spectrum Analyzer ROHDE & SCHWARZ	FSP40	100040	Sep. 23, 2019	Sep. 22, 2020
WIT Standard Temperature And Humidity Chamber	TH-4S-C	W981030	Jun. 03, 2019	Jun. 02, 2020
Digital Multimeter Fluke	87-III	70360742	Jun. 28, 2019	Jun. 27, 2020
AC Power Supply Extech	CFW-105	E000603	NA	NA
True RMS Clamp Meter Fluke	325	31130711WS	May 21, 2019	May 20, 2020

Note: 1. The calibration interval of the above test instruments is 12 months and the calibrations are traceable to NML/ROC and NIST/USA.

### 4.6.4 Test Procedure

- The EUT was placed inside the environmental test chamber and powered by nominal AC voltage.
- Turn the EUT on and couple its output to a spectrum analyzer.
- Turn the EUT off and set the chamber to the highest temperature specified.
- Allow sufficient time (approximately 30 min) for the temperature of the chamber to stabilize, turn the EUT on and measure the operating frequency after 2, 5, and 10 minutes.
- Repeat step (d) with the temperature chamber set to the next desired temperature until measurements down to the lowest specified temperature have been completed.
- The test chamber was allowed to stabilize at +20 degree C for a minimum of 30 minutes. The supply voltage was then adjusted on the EUT from 85% to 115% and the frequency record.

#### 4.6.5 Deviation from Test Standard

No deviation.

#### 4.6.6 EUT Operating Condition

Set the EUT transmit at un-modulation mode to test frequency stability.

#### 4.6.7 Test Results

Frequency Stability Versus Temp.									
Operating Frequency: 5260MHz									
Temp. (°C)	Power Supply (Vac)	0 Minute		2 Minute		5 Minute		10 Minute	
		Measured Frequency (MHz)	Result	Measured Frequency (MHz)	Result	Measured Frequency (MHz)	Result	Measured Frequency (MHz)	Result
40	120	5260.0276	Pass	5260.0251	Pass	5260.025	Pass	5260.0257	Pass
30	120	5260.0153	Pass	5260.0134	Pass	5260.015	Pass	5260.0114	Pass
20	120	5260.0092	Pass	5260.0093	Pass	5260.0115	Pass	5260.0092	Pass
10	120	5259.9985	Pass	5259.9983	Pass	5259.9982	Pass	5260.0026	Pass
0	120	5260.0169	Pass	5260.0197	Pass	5260.0171	Pass	5260.0166	Pass

Frequency Stability Versus Voltage									
Operating Frequency: 5260MHz									
Temp. (°C)	Power Supply (Vac)	0 Minute		2 Minute		5 Minute		10 Minute	
		Measured Frequency (MHz)	Result	Measured Frequency (MHz)	Result	Measured Frequency (MHz)	Result	Measured Frequency (MHz)	Result
20	138	5260.0082	Pass	5260.0097	Pass	5260.0114	Pass	5260.0088	Pass
	120	5260.0092	Pass	5260.0093	Pass	5260.0115	Pass	5260.0092	Pass
	102	5260.0093	Pass	5260.01	Pass	5260.0119	Pass	5260.0082	Pass

## 4.7 6dB Bandwidth Measurement

### 4.7.1 Limits of 6dB Bandwidth Measurement

The minimum of 6dB Bandwidth Measurement is 0.5MHz.

### 4.7.2 Test Setup

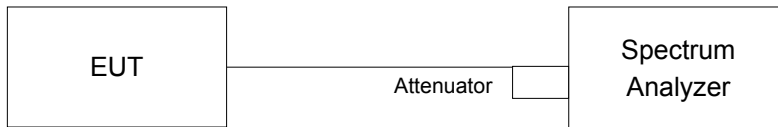

### 4.7.3 Test Instruments

Refer to section 4.1.2 to get information of above instrument.

### 4.7.4 Test Procedure

- Set resolution bandwidth (RBW) = 100kHz
- Set the video bandwidth (VBW)  $\geq 3 \times$  RBW, Detector = Peak.
- Trace mode = max hold.
- Sweep = auto couple.
- Measure the maximum width of the emission that is constrained by the frequencies associated with the two amplitude points (upper and lower) that are attenuated by 6 dB relative to the maximum level measured in the fundamental emission

### 4.7.5 Deviation from Test Standard

No deviation.

### 4.7.6 EUT Operating Condition

The software provided by client to enable the EUT under transmission condition continuously at lowest, middle and highest channel frequencies individually.

#### 4.7.7 Test Results

##### 802.11a

Channel	Frequency (MHz)	6dB Bandwidth (MHz)			Minimum Limit (MHz)	Pass / Fail
		Chain 0	Chain 1	Chain 2		
144	5720 (For U-NII-3)	3.14	3.13	3.13	0.5	Pass

##### 802.11n (HT20)

Channel	Frequency (MHz)	6dB Bandwidth (MHz)			Minimum Limit (MHz)	Pass / Fail
		Chain 0	Chain 1	Chain 2		
144	5720 (For U-NII-3)	3.75	3.71	3.72	0.5	Pass

##### 802.11n (HT40)

Channel	Frequency (MHz)	6dB Bandwidth (MHz)			Minimum Limit (MHz)	Pass / Fail
		Chain 0	Chain 1	Chain 2		
142	5710 (For U-NII-2C)	2.56	2.57	2.55	0.5	Pass

##### 802.11ac (VHT80)

Channel	Frequency (MHz)	6dB Bandwidth (MHz)			Minimum Limit (MHz)	Pass / Fail
		Chain 0	Chain 1	Chain 2		
138	5690 (For U-NII-2C)	3.21	3.24	3.21	0.5	Pass

### Spectrum Plot of Worst Value

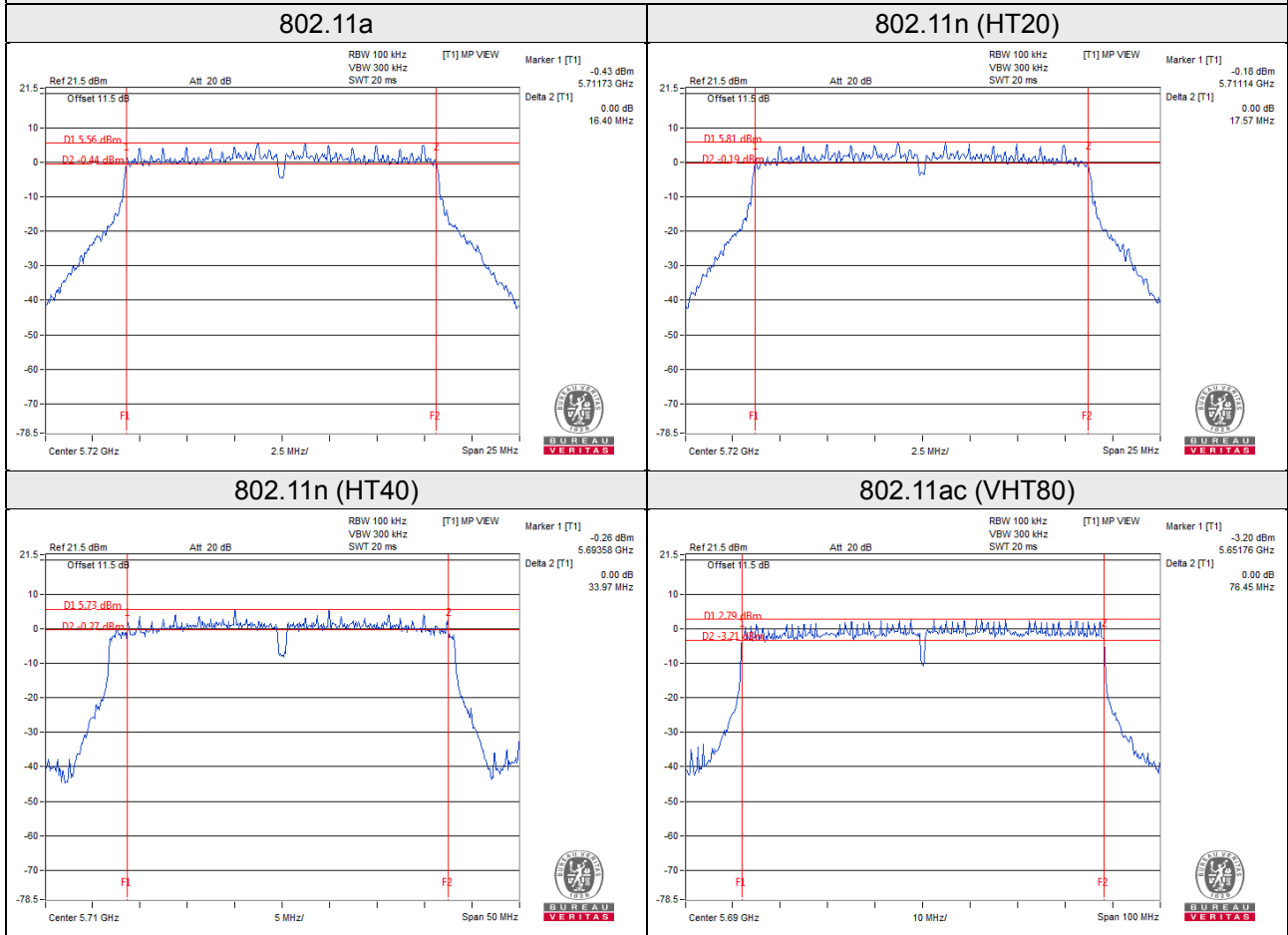

**Note:**

- For CH144 (UNII-3 Band): The 6dB bandwidth above 5725MHz = Marker 1 + Delta 2 - 5725MHz
- For CH142 (UNII-3 Band): The 6dB bandwidth above 5725MHz = Marker 1 + Delta 2 - 5725MHz
- For CH138 (UNII-3 Band): The 6dB bandwidth above 5725MHz = Marker 1 + Delta 2 - 5725MHz

## 5 Pictures of Test Arrangements

Please refer to the attached file (Test Setup Photo).

## Appendix – Information of the Testing Laboratories

We, Bureau Veritas Consumer Products Services (H.K.) Ltd., Taoyuan Branch, were founded in 1988 to provide our best service in EMC, Radio, Telecom and Safety consultation. Our laboratories are FCC recognized accredited test firms and accredited and approved according to ISO/IEC 17025.

If you have any comments, please feel free to contact us at the following:

### Lin Kou EMC/RF Lab

Tel: 886-2-26052180

Fax: 886-2-26051924

### Hsin Chu EMC/RF/Telecom Lab

Tel: 886-3-6668565

Fax: 886-3-6668323

### Hwa Ya EMC/RF/Safety

Tel: 886-3-3183232

Fax: 886-3-3270892

**Email:** [service.adt@tw.bureauveritas.com](mailto:service.adt@tw.bureauveritas.com)

**Web Site:** [www.bureauveritas-adt.com](http://www.bureauveritas-adt.com)

The address and road map of all our labs can be found in our web site also.

--- END ---