

FCC Test Report

Report No.: RF160914E10-1

FCC ID: KA2AP1655A1

Test Model: DAP-1655, COVR-1300E

Received Date: Sep. 14, 2016

Test Date: Nov. 10 to 22, 2016

Issued Date: Apr. 13, 2017

Applicant: D-Link Corporation

Address: No 289, Xinhu 3rd Rd, Neihu District, Taipei City 11494, Taiwan, R.O.C.

Issued By: Bureau Veritas Consumer Products Services (H.K.) Ltd., Taoyuan Branch
Hsin Chu Laboratory

Lab Address: E-2, No.1, Li Hsin 1st Road, Hsinchu Science Park, Hsinchu City 300,
Taiwan R.O.C.

Test Location (1): E-2, No.1, Li Hsin 1st Road, Hsinchu Science Park, Hsinchu City 300,
Taiwan R.O.C.

Test Location (2): No. 49, Ln. 206, Wende Rd., Shangshan Tsuen, Chiung Lin Hsiang, Hsin
Chu Hsien 307, Taiwan R.O.C.



This report is for your exclusive use. Any copying or replication of this report to or for any other person or entity, or use of our name or trademark, is permitted only with our prior written permission. This report sets forth our findings solely with respect to the test samples identified herein. The results set forth in this report are not indicative or representative of the quality or characteristics of the lot from which a test sample was taken or any similar or identical product unless specifically and expressly noted. Our report includes all of the tests requested by you and the results thereof based upon the information that you provided to us. You have 60 days from date of issuance of this report to notify us of any material error or omission caused by our negligence, provided, however, that such notice shall be in writing and shall specifically address the issue you wish to raise. A failure to raise such issue within the prescribed time shall constitute your unqualified acceptance of the completeness of this report, the tests conducted and the correctness of the report contents. Unless specific mention, the uncertainty of measurement has been explicitly taken into account to declare the compliance or non-compliance to the specification. The report must not be used by the client to claim product certification, approval, or endorsement by TAF or any government agencies.

Table of Contents

Release Control Record	4
1 Certificate of Conformity	5
2 Summary of Test Results	6
2.1 Measurement Uncertainty	6
2.2 Modification Record	6
3 General Information	7
3.1 General Description of EUT	7
3.2 Description of Test Modes	9
3.2.1 Test Mode Applicability and Tested Channel Detail	11
3.3 Duty Cycle of Test Signal	13
3.4 Description of Support Units	14
3.4.1 Configuration of System under Test	15
3.5 General Description of Applied Standard	16
4 Test Types and Results	17
4.1 Radiated Emission and Bandedge Measurement	17
4.1.1 Limits of Radiated Emission and Bandedge Measurement	17
4.1.2 Test Instruments	18
4.1.3 Test Procedure	19
4.1.4 Deviation from Test Standard	19
4.1.5 Test Setup	20
4.1.6 EUT Operating Condition	21
4.1.7 Test Results	22
4.2 Conducted Emission Measurement	41
4.2.1 Limits of Conducted Emission Measurement	41
4.2.2 Test Instruments	41
4.2.3 Test Procedure	42
4.2.4 Deviation from Test Standard	42
4.2.5 Test Setup	42
4.2.6 EUT Operating Condition	42
4.2.7 Test Results	43
4.3 Transmit Power Measurement	45
4.3.1 Limits of Transmit Power Measurement	45
4.3.2 Test Setup	45
4.3.3 Test Instruments	45
4.3.4 Test Procedure	45
4.3.5 Deviation from Test Standard	45
4.3.6 EUT Operating Condition	45
4.3.7 Test Result	46
4.4 Occupied Bandwidth Measurement	49
4.4.1 Test Setup	49
4.4.2 Test Instruments	49
4.4.3 Test Procedure	49
4.4.4 Test Results	50
4.5 Peak Power Spectral Density Measurement	54
4.5.1 Limits of Peak Power Spectral Density Measurement	54
4.5.2 Test Setup	54
4.5.3 Test Instruments	54
4.5.4 Test Procedure	55
4.5.5 Deviation from Test Standard	55
4.5.6 EUT Operating Condition	55
4.5.7 Test Results	56
4.6 Frequency Stability Measurement	62
4.6.1 Limits of Frequency Stability Measurement	62

4.6.2	Test Setup.....	62
4.6.3	Test Instruments	62
4.6.4	Test Procedure	62
4.6.5	Deviation from Test Standard	62
4.6.6	EUT Operating Condition	62
4.6.7	Test Results	63
4.7	6dB Bandwidth Measurement	64
4.7.1	Limits of 6dB Bandwidth Measurement.....	64
4.7.2	Test Setup.....	64
4.7.3	Test Instruments	64
4.7.4	Test Procedure	64
4.7.5	Deviation from Test Standard	64
4.7.6	EUT Operating Condition	64
4.7.7	Test Results	65
5	Pictures of Test Arrangements.....	67
	Annex A- Radiated Out of Band Emission (OOBE) Measurement (For U-NII-3 band)	68
	Appendix – Information on the Testing Laboratories	71

Release Control Record

Issue No.	Description	Date Issued
RF160914E10-1	Original release.	Apr. 13, 2017

1 Certificate of Conformity

Product: Covr AC1300 Wi-Fi Range Extender

Brand: D-Link

Test Model: DAP-1655, COVR-1300E

Sample Status: MASS-PRODUCTION

Applicant: D-Link Corporation

Test Date: Nov. 10 to 22, 2016

Standard: 47 CFR FCC Part 15, Subpart E (Section 15.407)
ANSI C63.10: 2013

The above equipment has been tested by **Bureau Veritas Consumer Products Services (H.K.) Ltd., Taoyuan Branch**, and found compliance with the requirement of the above standards. The test record, data evaluation & Equipment Under Test (EUT) configurations represented herein are true and accurate accounts of the measurements of the sample's EMC characteristics under the conditions specified in this report.

Prepared by : Cindy Hsin , **Date:** Apr. 13, 2017
Cindy Hsin / Specialist

Approved by : May Chen , **Date:** Apr. 13, 2017
May Chen / Manager

2 Summary of Test Results

47 CFR FCC Part 15, Subpart E (Section 15.407)			
FCC Clause	Test Item	Result	Remarks
15.407(b)(6)	AC Power Conducted Emissions	Pass	Meet the requirement of limit. Minimum passing margin is -16.66dB at 0.34141MHz.
15.407(b) (1/2/3/4(i/ii)/6)	Radiated Emissions & Band Edge Measurement*	Pass	Meet the requirement of limit. Minimum passing margin is -0.1dB at 5150.00MHz
15.407(a)(1/2/3)	Max Average Transmit Power	Pass	Meet the requirement of limit.
---	Occupied Bandwidth Measurement	-	Reference only.
15.407(a)(1/2/3)	Peak Power Spectral Density	Pass	Meet the requirement of limit.
15.407(e)	6dB bandwidth	Pass	Meet the requirement of limit. (U-NII-3 Band only)
15.407(g)	Frequency Stability	Pass	Meet the requirement of limit.
15.203	Antenna Requirement	Pass	Antenna connector is i-pex(MHF) not a standard connector.

*For U-NII-3 band compliance with rule part 15.407(b)(4)(i), the OOB test plots were recorded in Annex A.

2.1 Measurement Uncertainty

Where relevant, the following measurement uncertainty levels have been estimated for tests performed on the EUT as specified in CISPR 16-4-2:

Measurement	Frequency	Expanded Uncertainty (k=2) (±)
Conducted Emissions at mains ports	150kHz ~ 30MHz	1.83 dB
Radiated Emissions up to 1 GHz	30MHz ~ 1GHz	5.43 dB
Radiated Emissions above 1 GHz	1GHz ~ 6GHz	3.41 dB
	6GHz ~ 18GHz	3.49 dB
	18GHz ~ 40GHz	3.30 dB

2.2 Modification Record

There were no modifications required for compliance.

3 General Information

3.1 General Description of EUT

Product	Covr AC1300 Wi-Fi Range Extender
Brand	D-Link
Test Model	DAP-1655, COVR-1300E
Status of EUT	MASS-PRODUCTION
Power Supply Rating	12Vdf from power adapter
Modulation Type	CCK, DQPSK, DBPSK for DSSS 64QAM, 16QAM, QPSK, BPSK for OFDM 256QAM for OFDM in 11ac mode and VHT20/40 mode in 2.4GHz band
Modulation Technology	DSSS, OFDM
Transfer Rate	802.11b: up to 11Mbps 802.11a/g: up to 54Mbps 802.11n: up to 300Mbps 802.11ac: up to 866.7Mbps
Operating Frequency	2.4GHz: 2.412 ~ 2.462GHz 5GHz: 5.18 ~ 5.24GHz and 5.745 ~ 5.825GHz
Number of Channel	2.4GHz: 802.11b, 802.11g, 802.11n (HT20), VHT20: 11 802.11n (HT40), VHT40: 7 5GHz: 802.11a, 802.11n (HT20), 802.11ac (VHT20): 9 802.11n (HT40), 802.11ac (VHT40): 4 802.11ac (VHT80): 2
Output Power	2.4GHz: CDD Mode: 324.61mW Beamforming Mode: 234.797mW 5GHz: 5.18GHz ~ 5.24GHz: CDD Mode: 250.367mW Beamforming Mode: 249.488mW 5.745GHz ~ 5.825GHz: CDD Mode: 279.463mW Beamforming Mode: 276.264mW
Antenna Type	Refer to Note
Antenna Connector	Refer to Note
Accessory Device	Adapter x1
Data Cable Supplied	NA

Note:

1. The EUT must be supplied with a power adapter as following table:

Brand	Model No.	Spec.
D-Link	WA-12M12R	AC Input: 100-240V, 0.5A, 50/60Hz DC Output: 12V, 1A DC Output cable: Unshielded, 1.2m

2. The EUT has two model names, which are identical to each other in all aspects except for the followings:

Brand Name	Model Name	Different
D-Link	DAP-1655	-
	COVR-1300E	for Maketing request

From the above models, models: **DAP-1655** was selected as representative model for the test and its data was recorded in this report.

3. Simultaneously transmission condition.

Condition	Technology	
1	WLAN (2.4GHz)	WLAN (5GHz)

Note: The emission of the simultaneous operation has been evaluated and no non-compliance was found.

4. The antenna provided to the EUT, please refer to the following table:

Antenna No.	Chain No.	Model	Antenna Gain(dBi)	Frequency range (GHz)	Antenna Type	Connector Type
1	Chain 0	NA	1.43	2.4~2.4835	PIFA	I-pex (MHF)
			2.99	5.15~5.85		
2	Chain 1	NA	1.99	2.4~2.4835	PIFA	I-pex (MHF)
			2.99	5.15~5.85		

5. The EUT incorporates a MIMO function.

2.4GHz Band			
MODULATION MODE	DATA RATE (MCS)	TX & RX CONFIGURATION	
802.11b	1 ~ 11Mbps	2TX	2RX
802.11g	6 ~ 54Mbps	2TX	2RX
802.11n (HT20)	MCS 0~7	2TX	2RX
	MCS 8~15	2TX	2RX
802.11n (HT40)	MCS 0~7	2TX	2RX
	MCS 8~15	2TX	2RX
VHT20	MCS0~8 Nss=1	2TX	2RX
	MCS0~8 Nss=2	2TX	2RX
VHT40	MCS0~9 Nss=1	2TX	2RX
	MCS0~9 Nss=2	2TX	2RX
5GHz Band			
MODULATION MODE	DATA RATE (MCS)	TX & RX CONFIGURATION	
802.11a	6 ~ 54Mbps	2TX	2RX
802.11n (HT20)	MCS 0~7	2TX	2RX
	MCS 8~15	2TX	2RX
802.11n (HT40)	MCS 0~7	2TX	2RX
	MCS 8~15	2TX	2RX
802.11ac (VHT20)	MCS0~8 Nss=1	2TX	2RX
	MCS0~8 Nss=2	2TX	2RX
802.11ac (VHT40)	MCS0~9 Nss=1	2TX	2RX
	MCS0~9 Nss=2	2TX	2RX
802.11ac (VHT80)	MCS0~9 Nss=1	2TX	2RX
	MCS0~9 Nss=2	2TX	2RX

Note:

- All of modulation mode support beamforming function except 802.11a/b/g modulation mode.
- The modulation and bandwidth are similar for 802.11n mode for 20MHz (40MHz) and 802.11ac mode for 20MHz (40MHz), therefore investigated worst case to representative mode in test report. (Final test mode refer section 3.2.1)
- The EUT support Beamforming and CDD mode, therefore both mode were investigated and the worst case scenario was identified. The worst case data were presented in test report (except Output power test item).

6. The above EUT information is declared by the manufacturer and for more detailed features description, please refer to the manufacturer's specifications or User's Manual.

3.2 Description of Test Modes

FOR 5180 ~ 5240MHz

4 channels are provided for 802.11a, 802.11n (HT20), 802.11ac (VHT20):

Channel	Frequency	Channel	Frequency
36	5180 MHz	44	5220 MHz
40	5200 MHz	48	5240 MHz

2 channels are provided for 802.11n (HT40), 802.11ac (VHT40):

Channel	Frequency	Channel	Frequency
38	5190 MHz	46	5230 MHz

1 channel is provided for 802.11ac (VHT80):

Channel	Frequency

42	5210MHz
----	---------

FOR 5745 ~ 5825MHz:

5 channels are provided for 802.11a, 802.11n (HT20), 802.11ac (VHT20):

Channel	Frequency	Channel	Frequency
149	5745MHz	161	5805MHz
153	5765MHz	165	5825MHz
157	5785MHz		

2 channels are provided for 802.11n (HT40), 802.11ac (VHT40):

Channel	Frequency	Channel	Frequency
151	5755MHz	159	5795MHz

1 channel is provided for 802.11ac (VHT80):

Channel	Frequency
155	5775MHz

3.2.1 Test Mode Applicability and Tested Channel Detail

EUT Configure Mode	Applicable To				Description
	RE \geq 1G	RE $<$ 1G	PLC	APCM	
-	√	√	√	√	-

Where **RE \geq 1G**: Radiated Emission above 1GHz **RE $<$ 1G**: Radiated Emission below 1GHz
PLC: Power Line Conducted Emission **APCM**: Antenna Port Conducted Measurement

NOTE:

- The EUT had been pre-tested on the positioned of each 2 axis. The worst case was found when positioned on **X-plane**.

Radiated Emission Test (Above 1GHz):

- Pre-Scan has been conducted to determine the worst-case mode from all possible combinations between available modulations, data rates and antenna ports (if EUT with antenna diversity architecture).
- Following channel(s) was (were) selected for the final test as listed below.

CDD Mode						
Mode	FREQ. Band (MHz)	Available Channel	Tested Channel	Modulation Technology	Modulation Type	Data Rate (Mbps)
802.11a	5180-5240	36 to 48	36, 40, 48	OFDM	BPSK	6
802.11ac (VHT20)		36 to 48	36, 40, 48	OFDM	BPSK	6.5
802.11ac (VHT40)		38 to 46	38, 46	OFDM	BPSK	13.5
802.11ac (VHT80)		42	42	OFDM	BPSK	29.3
802.11a	5745-5825	149 to 165	149, 157, 165	OFDM	BPSK	6
802.11ac (VHT20)		149 to 165	149, 157, 165	OFDM	BPSK	6.5
802.11ac (VHT40)		151 to 159	151, 159	OFDM	BPSK	13.5
802.11ac (VHT80)		155	155	OFDM	BPSK	29.3

Radiated Emission Test (Below 1GHz):

- Pre-Scan has been conducted to determine the worst-case mode from all possible combinations between available modulations, data rates and antenna ports (if EUT with antenna diversity architecture).
- Following channel(s) was (were) selected for the final test as listed below.

CDD Mode						
Mode	FREQ. Band (MHz)	Available Channel	Tested Channel	Modulation Technology	Modulation Type	Data Rate (Mbps)
802.11a	5745-5825	149 to 165	157	OFDM	BPSK	6

Power Line Conducted Emission Test:

- Pre-Scan has been conducted to determine the worst-case mode from all possible combinations between available modulations, data rates and antenna ports (if EUT with antenna diversity architecture).
- Following channel(s) was (were) selected for the final test as listed below.

CDD Mode						
Mode	FREQ. Band (MHz)	Available Channel	Tested Channel	Modulation Technology	Modulation Type	Data Rate (Mbps)
802.11a	5745-5825	149 to 165	157	OFDM	BPSK	6

Antenna Port Conducted Measurement:

- This item includes all test value of each mode, but only includes spectrum plot of worst value of each mode.
- Pre-Scan has been conducted to determine the worst-case mode from all possible combinations between available modulations, data rates and antenna ports (if EUT with antenna diversity architecture).
- Following channel(s) was (were) selected for the final test as listed below.

CDD Mode						
Mode	FREQ. Band (MHz)	Available Channel	Tested Channel	Modulation Technology	Modulation Type	Data Rate (Mbps)
802.11a	5180-5240	36 to 48	36, 40, 48	OFDM	BPSK	6
802.11ac (VHT20)		36 to 48	36, 40, 48	OFDM	BPSK	6.5
802.11ac (VHT40)		38 to 46	38, 46	OFDM	BPSK	13.5
802.11ac (VHT80)		42	42	OFDM	BPSK	29.3
802.11a	5745-5825	149 to 165	149, 157, 165	OFDM	BPSK	6
802.11ac (VHT20)		149 to 165	149, 157, 165	OFDM	BPSK	6.5
802.11ac (VHT40)		151 to 159	151, 159	OFDM	BPSK	13.5
802.11ac (VHT80)		155	155	OFDM	BPSK	29.3
Beamforming Mode (Output power only)						
Mode	FREQ. Band (MHz)	Available Channel	Tested Channel	Modulation Technology	Modulation Type	Data Rate (Mbps)
802.11ac (VHT20)	5180-5240	36 to 48	36, 40, 48	OFDM	BPSK	6.5
802.11ac (VHT40)		38 to 46	38, 46	OFDM	BPSK	13.5
802.11ac (VHT80)		42	42	OFDM	BPSK	29.3
802.11ac (VHT20)	5745-5825	149 to 165	149, 157, 165	OFDM	BPSK	6.5
802.11ac (VHT40)		151 to 159	151, 159	OFDM	BPSK	13.5
802.11ac (VHT80)		155	155	OFDM	BPSK	29.3

Test Condition:

Applicable To	Environmental Conditions	Input Power	Tested By
RE \geq 1G	25deg. C, 62%RH	120Vac, 60Hz	Jyunchun Lin
RE<1G	25deg. C, 71%RH	120Vac, 60Hz	Andy Ho
PLC	23deg. C, 73%RH	120Vac, 60Hz	Andy Ho
APCM	25deg. C, 60%RH	120Vac, 60Hz	Gary Cheng

3.3 Duty Cycle of Test Signal

If duty cycle of test signal is $\geq 98\%$, duty factor is not required.

If duty cycle of test signal is $< 98\%$, duty factor is required

802.11a: Duty cycle = $2.062/2.135 = 0.966$, Duty factor = $10 * \log(1/0.966) = 0.15$

802.11ac (VHT20): Duty cycle = $5.009/5.094 = 0.983$

802.11ac (VHT40): Duty cycle = $2.435/2.512 = 0.969$, Duty factor = $10 * \log(1/0.969) = 0.14$

802.11ac (VHT80): Duty cycle = $1.146/1.228 = 0.933$, Duty factor = $10 * \log(1/0.933) = 0.3$

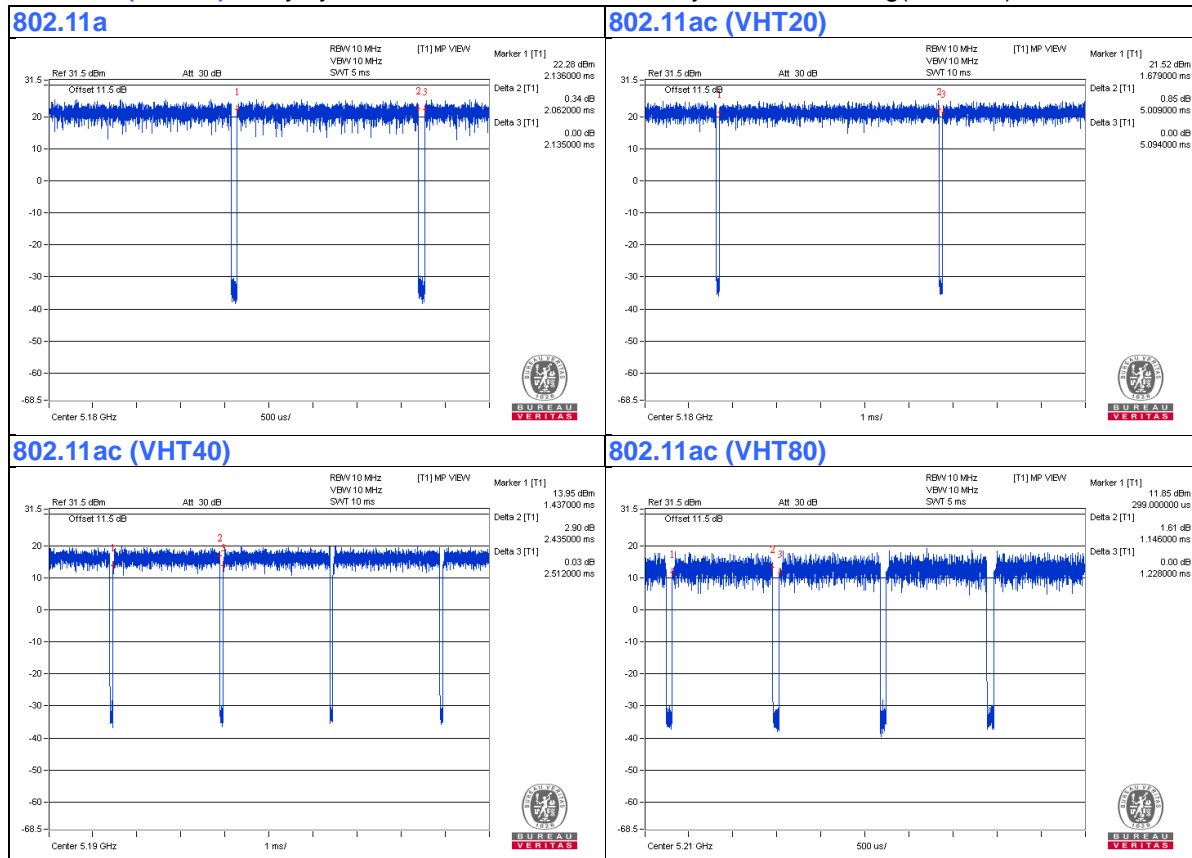

3.4 Description of Support Units

The EUT has been tested as an independent unit together with other necessary accessories or support units. The following support units or accessories were used to form a representative test configuration during the tests.

ID	Product	Brand	Model No.	Serial No.	FCC ID	Remarks
A.	Laptop	DELL	E5430	HYV4VY1	FCC DoC	Provided by Lab

Note:

1. All power cords of the above support units are non-shielded (1.8m).

ID	Descriptions	Qty.	Length (m)	Shielding (Yes/No)	Cores (Qty.)	Remarks
1.	RJ-45 Cable	1	10	No	0	Provided by Lab
2.	DC Cable	1	1.2	No	0	Supplied by client

3.4.1 Configuration of System under Test

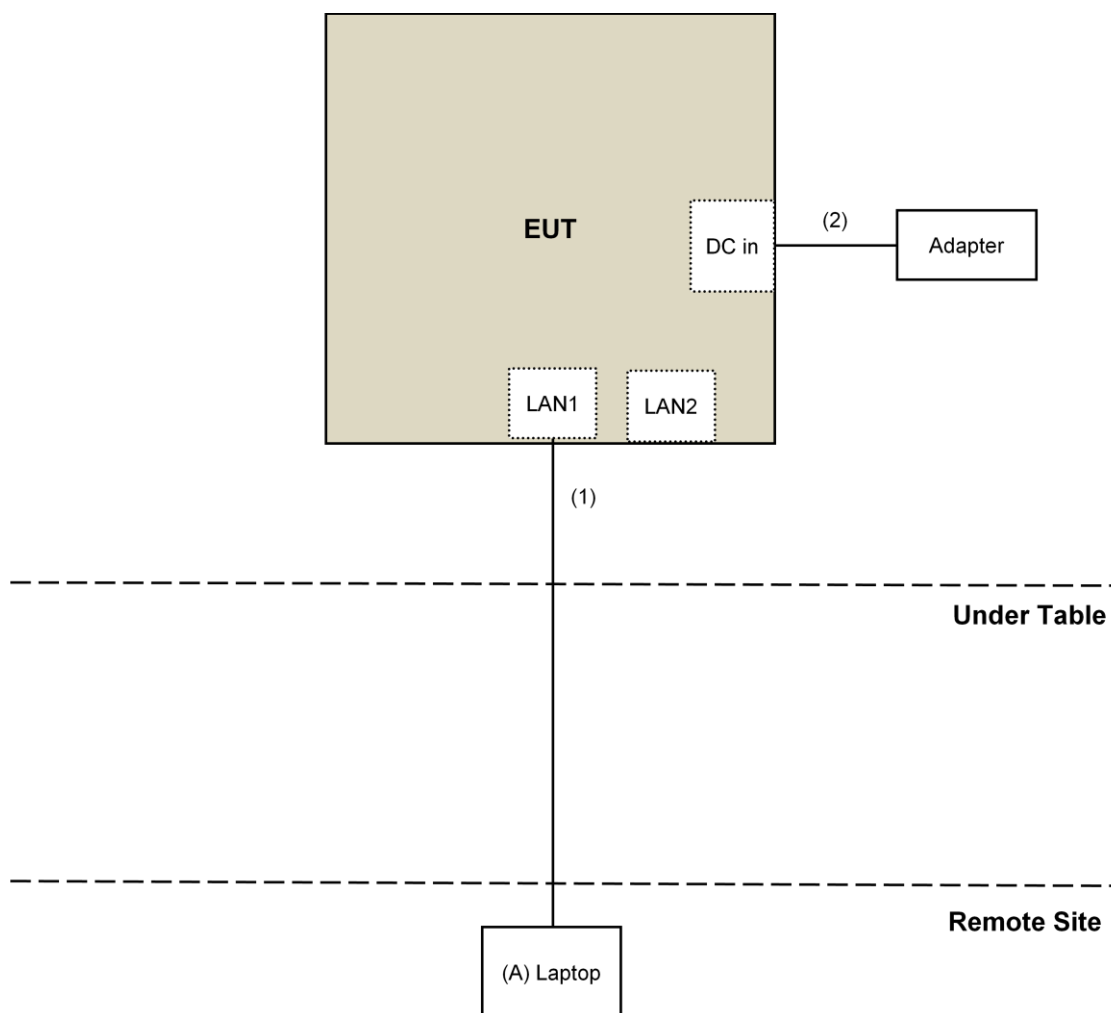

3.5 General Description of Applied Standard

The EUT is a RF Product. According to the specifications of the manufacturer, it must comply with the requirements of the following standards:

FCC Part 15, Subpart E (15.407)
KDB 789033 D02 General UNII Test Procedure New Rules v01r03
KDB 662911 D01 Multiple Transmitter Output v02r01
ANSI C63.10-2013

All test items have been performed and recorded as per the above standards.

NOTE: The EUT has been verified to comply with the requirements of FCC Part 15, Subpart B, Class B (DoC). The test report has been issued separately.

4 Test Types and Results

4.1 Radiated Emission and Bandedge Measurement

4.1.1 Limits of Radiated Emission and Bandedge Measurement

Radiated emissions which fall in the restricted bands must comply with the radiated emission limits specified as below table.

Frequencies (MHz)	Field Strength (microvolts/meter)	Measurement Distance (meters)
0.009 ~ 0.490	2400/F(kHz)	300
0.490 ~ 1.705	24000/F(kHz)	30
1.705 ~ 30.0	30	30
30 ~ 88	100	3
88 ~ 216	150	3
216 ~ 960	200	3
Above 960	500	3

NOTE:

1. The lower limit shall apply at the transition frequencies.
2. Emission level (dBuV/m) = 20 log Emission level (uV/m).
3. For frequencies above 1000MHz, the field strength limits are based on average detector, however, the peak field strength of any emission shall not exceed the maximum permitted average limits, specified above by more than 20dB under any condition of modulation.

Limits of unwanted emission out of the restricted bands

Applicable To		Limit	
789033 D02 General UNII Test Procedure New Rules v01r03		Field Strength at 3m	
		PK:74 (dBuV/m)	AV:54 (dBuV/m)
Frequency Band	Applicable To	EIRP Limit	Equivalent Field Strength at 3m
5150~5250 MHz	15.407(b)(1)	PK:-27 (dBm/MHz)	PK:68.2(dBuV/m)
5250~5350 MHz	15.407(b)(2)		
5470~5725 MHz	15.407(b)(3)		
5725~5850 MHz	<input checked="" type="checkbox"/> 15.407(b)(4)(i)	PK:-27 (dBm/MHz) ^{*1} PK:10 (dBm/MHz) ^{*2} PK:15.6 (dBm/MHz) ^{*3} PK:27 (dBm/MHz) ^{*4}	PK: 68.2(dBuV/m) ^{*1} PK:105.2 (dBuV/m) ^{*2} PK: 110.8(dBuV/m) ^{*3} PK:122.2 (dBuV/m) ^{*4}
	<input type="checkbox"/> 15.407(b)(4)(ii)	Emission limits in section 15.247(d)	
^{*1} beyond 75 MHz or more above of the band edge.		^{*2} below the band edge increasing linearly to 10 dBm/MHz at 25 MHz above.	
^{*3} below the band edge increasing linearly to a level of 15.6 dBm/MHz at 5 MHz above.		^{*4} from 5 MHz above or below the band edge increasing linearly to a level of 27 dBm/MHz at the band edge.	

Note:

The following formula is used to convert the equipment isotropic radiated power (eirp) to field strength:

$$E = \frac{1000000\sqrt{30P}}{3} \mu\text{V/m, where P is the eirp (Watts).}$$

4.1.2 Test Instruments

DESCRIPTION & MANUFACTURER	MODEL NO.	SERIAL NO.	CALIBRATED DATE	CALIBRATED UNTIL
Test Receiver Keysight	N9038A	MY54450088	July 20, 2016	July 19, 2017
Pre-Amplifier ^(*) EMCI	EMC001340	980142	Jan. 20, 2016	Jan. 19, 2018
Loop Antenna ^(*) Electro-Metrics	EM-6879	264	Dec. 16, 2014	Dec. 15, 2016
RF Cable	NA	LOOPCAB-001 LOOPCAB-002	Jan. 18, 2016	Jan. 17, 2017
Pre-Amplifier Mini-Circuits	ZFL-1000VH2B	AMP-ZFL-01	Nov. 10, 2016	Nov. 09, 2017
Trilog Broadband Antenna SCHWARZBECK	VULB 9168	9168-406	Jan. 04, 2016	Jan. 03, 2017
RF Cable	8D	966-4-1 966-4-2 966-4-3	Apr. 02, 2016	Apr. 01, 2017
Fixed attenuator Mini-Circuits	UNAT-5+	PAD-3m-4-01	Oct. 05, 2016	Oct. 04, 2017
Horn_Antenna SCHWARZBECK	BBHA 9120D	9120D-783	Jan. 19, 2016	Jan. 18, 2017
Pre-Amplifier Agilent	8449B	3008A01922	Sep. 18, 2016	Sep. 17, 2017
RF Cable	EMC104-SM-SM-2000 EMC104-SM-SM-5000 EMC104-SM-SM-5000	150318 150323 150324	Mar. 30, 2016	Mar. 29, 2017
Pre-Amplifier EMCI	EMC184045	980143	Jan. 15, 2016	Jan. 14, 2017
Horn_Antenna SCHWARZBECK	BBHA 9170	BBHA9170608	Jan. 08, 2016	Jan. 07, 2017
RF Cable	SUCOFLEX 102	36432/2 36441/2	Jan. 16, 2016	Jan. 15, 2017
Software	ADT_Radiated_V8.7.08	NA	NA	NA
Antenna Tower & Turn Table Max-Full	MF-7802	MF780208410	NA	NA
Boresight Antenna Fixture	FBA-01	FBA-SIP02	NA	NA
Spectrum Analyzer R&S	FSv40	100964	June 28, 2016	June 27, 2017
Spectrum Analyzer Agilent	E4446A	MY48250253	Dec. 22, 2015	Dec. 21, 2016
Power meter Anritsu	ML2495A	1014008	May 5, 2016	May 4, 2017
Power sensor Anritsu	MA2411B	0917122	May 5, 2016	May 4, 2017

Note:

1. The calibration interval of the above test instruments is 12 months and the calibrations are traceable to NML/ROC and NIST/USA.
2. *The calibration interval of the above test instruments is 24 months and the calibrations are traceable to NML/ROC and NIST/USA.
3. The horn antenna, preamplifier (model: 8449B) are used only for the measurement of emission frequency above 1GHz if tested.
4. The test was performed in 966 Chamber No. 4.
5. The FCC Site Registration No. is 292998
6. The CANADA Site Registration No. is 20331-2
- 7 Tested Date:Nov. 18 to 22, 2016

4.1.3 Test Procedure

For Radiated emission below 30MHz

- a. The EUT was placed on the top of a rotating table 0.8 meters above the ground at a 3 meter chamber room. The table was rotated 360 degrees to determine the position of the highest radiation.
- b. The EUT was set 3 meters away from the interference-receiving antenna, which was mounted on the top of a variable-height antenna tower.
- c. Both X and Y axes of the antenna are set to make the measurement.
- d. For each suspected emission, the EUT was arranged to its worst case and the rotatable table was turned from 0 degrees to 360 degrees to find the maximum reading.
- e. The test-receiver system was set to Quasi-Peak Detect Function and Specified Bandwidth with Maximum Hold Mode.

NOTE:

1. The resolution bandwidth and video bandwidth of test receiver/spectrum analyzer is 9kHz at frequency below 30MHz.

For Radiated emission above 30MHz

- a. The EUT was placed on the top of a rotating table 0.8 meters (for 30MHz ~ 1GHz) / 1.5 meters (for above 1GHz) above the ground at 3 meter chamber room for test. The table was rotated 360 degrees to determine the position of the highest radiation.
- b. The EUT was set 3 meters away from the interference-receiving antenna, which was mounted on the top of a variable-height antenna tower.
- c. The height of antenna is varied from one meter to four meters above the ground to determine the maximum value of the field strength. Both horizontal and vertical polarizations of the antenna are set to make the measurement.
- d. For each suspected emission, the EUT was arranged to its worst case and then the antenna was tuned to heights from 1 meter to 4 meters and the rotatable table was turned from 0 degrees to 360 degrees to find the maximum reading.
- e. The test-receiver system was set to quasi-peak detect function and specified bandwidth with maximum hold mode when the test frequency is below 1 GHz.
- f. The test-receiver system was set to peak and average detect function and specified bandwidth with maximum hold mode when the test frequency is above 1 GHz. If the peak reading value also meets average limit, measurement with the average detector is unnecessary.

Note:

1. The resolution bandwidth and video bandwidth of test receiver/spectrum analyzer is 120kHz for Quasi-peak detection (QP) at frequency below 1GHz.
2. The resolution bandwidth of test receiver/spectrum analyzer is 1 MHz and the video bandwidth is 3 MHz for Peak detection (PK) at frequency above 1GHz.
3. The resolution bandwidth of test receiver/spectrum analyzer is 1MHz and the video bandwidth is $\geq 1/T$ (Duty cycle $< 98\%$) or 10Hz (Duty cycle $\geq 98\%$) for Average detection (AV) at frequency above 1GHz.
4. All modes of operation were investigated and the worst-case emissions are reported.

4.1.4 Deviation from Test Standard

No deviation.

4.1.5 Test Setup

For Radiated emission below 30MHz

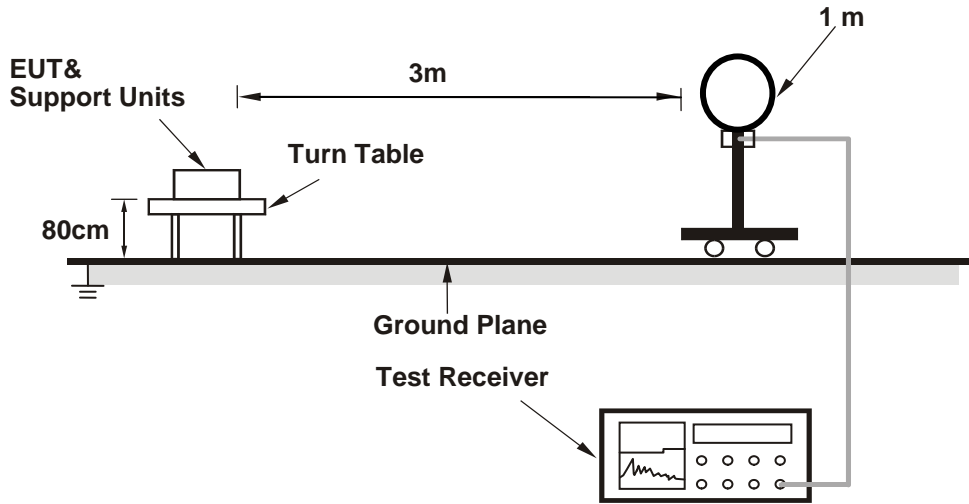

For Radiated emission 30MHz to 1GHz

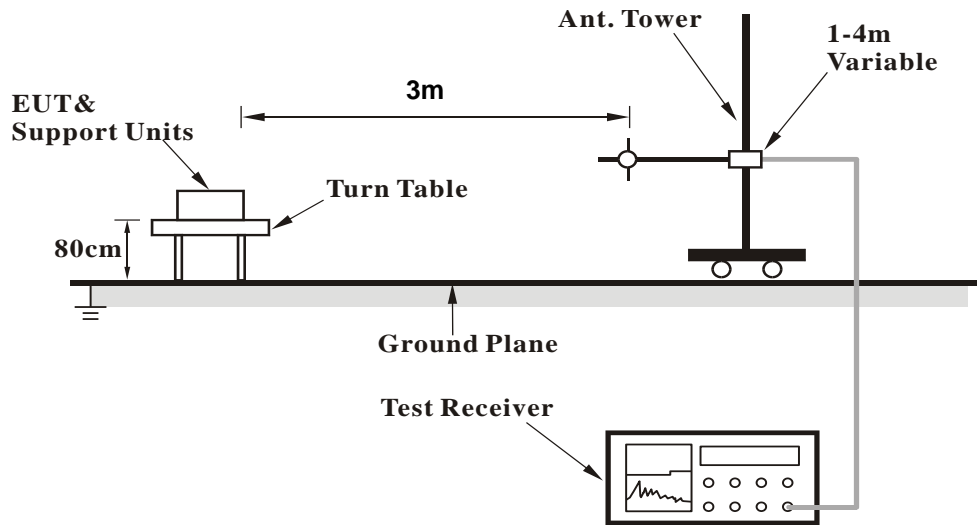

For Radiated emission above 1GHz

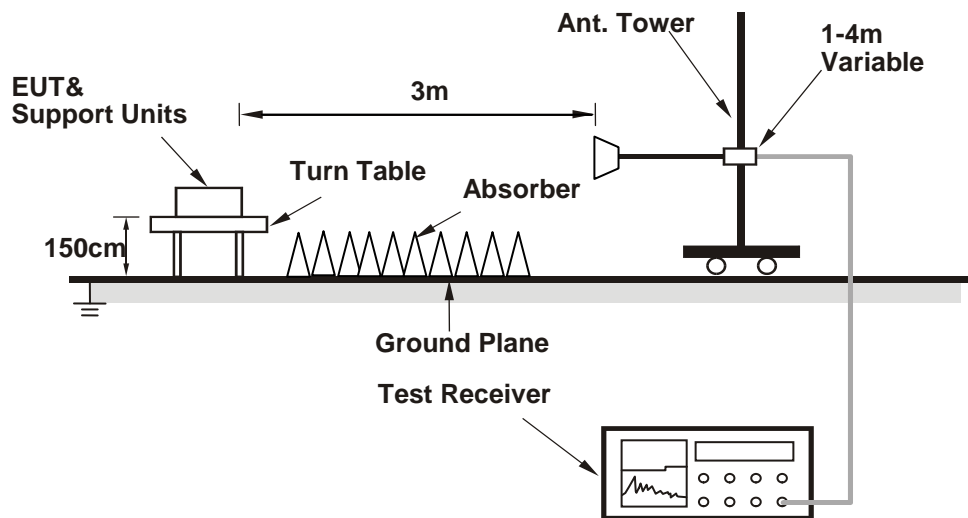

For the actual test configuration, please refer to the attached file (Test Setup Photo).

4.1.6 EUT Operating Condition

- a. Connected the EUT with the Laptop which is placed on remote site.
- b. Controlling software (QCARCT.exe V3.0.187.0) has been activated to set the EUT on specific status.

4.1.7 Test Results

Above 1GHz Data:

802.11a

CHANNEL	TX Channel 36	DETECTOR FUNCTION	Peak (PK)
FREQUENCY RANGE	1GHz ~ 40GHz		Average (AV)

ANTENNA POLARITY & TEST DISTANCE: HORIZONTAL AT 3 M

NO.	FREQ. (MHz)	EMISSION LEVEL (dBuV/m)	LIMIT (dBuV/m)	MARGIN (dB)	ANTENNA HEIGHT (m)	TABLE ANGLE (Degree)	RAW VALUE (dBuV)	CORRECTION FACTOR (dB/m)
1	5150.00	51.9 PK	74.0	-22.1	2.41 H	114	50.4	1.5
2	5150.00	39.1 AV	54.0	-14.9	2.41 H	114	37.6	1.5
3	*5180.00	109.4 PK			2.33 H	314	107.8	1.6
4	*5180.00	96.7 AV			2.33 H	314	95.1	1.6
5	#10360.00	51.9 PK	74.0	-22.1	1.47 H	244	40.4	11.5
6	#10360.00	40.7 AV	54.0	-13.3	1.47 H	244	29.2	11.5
7	15540.00	50.1 PK	74.0	-23.9	1.47 H	292	37.0	13.1
8	15540.00	38.7 AV	54.0	-15.3	1.47 H	292	25.6	13.1

ANTENNA POLARITY & TEST DISTANCE: VERTICAL AT 3 M

NO.	FREQ. (MHz)	EMISSION LEVEL (dBuV/m)	LIMIT (dBuV/m)	MARGIN (dB)	ANTENNA HEIGHT (m)	TABLE ANGLE (Degree)	RAW VALUE (dBuV)	CORRECTION FACTOR (dB/m)
1	5150.00	68.2 PK	74.0	-5.8	2.89 V	290	66.7	1.5
2	5150.00	53.9 AV	54.0	-0.1	2.89 V	290	52.4	1.5
3	*5180.00	114.1 PK			2.89 V	290	112.5	1.6
4	*5180.00	102.3 AV			2.89 V	290	100.7	1.6
5	#10360.00	52.8 PK	74.0	-21.2	2.42 V	302	41.3	11.5
6	#10360.00	42.0 AV	54.0	-12.0	2.42 V	302	30.5	11.5
7	15540.00	50.9 PK	74.0	-23.1	1.97 V	94	37.8	13.1
8	15540.00	38.4 AV	54.0	-15.6	1.97 V	94	25.3	13.1

REMARKS:

- Emission Level(dBuV/m) = Raw Value(dBuV) + Correction Factor(dB/m)
- Correction Factor(dB/m) = Antenna Factor(dB/m) + Cable Factor(dB) – Pre-Amplifier Factor(dB)
- The other emission levels were very low against the limit.
- Margin value = Emission Level – Limit value
- " * ": Fundamental frequency.
- " # ": The radiated frequency is out of the restricted band.

CHANNEL	TX Channel 40	DETECTOR FUNCTION	Peak (PK)
FREQUENCY RANGE	1GHz ~ 40GHz		Average (AV)

ANTENNA POLARITY & TEST DISTANCE: HORIZONTAL AT 3 M

NO.	FREQ. (MHz)	EMISSION LEVEL (dBuV/m)	LIMIT (dBuV/m)	MARGIN (dB)	ANTENNA HEIGHT (m)	TABLE ANGLE (Degree)	RAW VALUE (dBuV)	CORRECTION FACTOR (dB/m)
1	*5200.00	106.5 PK			2.31 H	123	104.8	1.7
2	*5200.00	95.0 AV			2.31 H	123	93.3	1.7
3	#10400.00	52.1 PK	74.0	-21.9	1.43 H	238	40.5	11.6
4	#10400.00	41.2 AV	54.0	-12.8	1.43 H	238	29.6	11.6
5	15600.00	50.2 PK	74.0	-23.8	1.52 H	300	37.1	13.1
6	15600.00	39.0 AV	54.0	-15.0	1.52 H	300	25.9	13.1

ANTENNA POLARITY & TEST DISTANCE: VERTICAL AT 3 M

NO.	FREQ. (MHz)	EMISSION LEVEL (dBuV/m)	LIMIT (dBuV/m)	MARGIN (dB)	ANTENNA HEIGHT (m)	TABLE ANGLE (Degree)	RAW VALUE (dBuV)	CORRECTION FACTOR (dB/m)
1	*5200.00	112.7 PK			2.34 V	211	111.0	1.7
2	*5200.00	101.7 AV			2.34 V	211	100.0	1.7
3	#10400.00	53.2 PK	74.0	-20.8	2.45 V	312	41.6	11.6
4	#10400.00	42.4 AV	54.0	-11.6	2.45 V	312	30.8	11.6
5	15600.00	50.6 PK	74.0	-23.4	1.93 V	100	37.5	13.1
6	15600.00	38.1 AV	54.0	-15.9	1.93 V	100	25.0	13.1

REMARKS:

1. Emission Level(dBuV/m) = Raw Value(dBuV) + Correction Factor(dB/m)
2. Correction Factor(dB/m) = Antenna Factor(dB/m) + Cable Factor(dB) – Pre-Amplifier Factor(dB)
3. The other emission levels were very low against the limit.
4. Margin value = Emission Level – Limit value
5. " * ": Fundamental frequency.
6. " # ": The radiated frequency is out of the restricted band.

CHANNEL	TX Channel 48	DETECTOR FUNCTION	Peak (PK)
FREQUENCY RANGE	1GHz ~ 40GHz		Average (AV)

ANTENNA POLARITY & TEST DISTANCE: HORIZONTAL AT 3 M

NO.	FREQ. (MHz)	EMISSION LEVEL (dBuV/m)	LIMIT (dBuV/m)	MARGIN (dB)	ANTENNA HEIGHT (m)	TABLE ANGLE (Degree)	RAW VALUE (dBuV)	CORRECTION FACTOR (dB/m)
1	*5240.00	106.8 PK			2.35 H	124	105.2	1.6
2	*5240.00	95.1 AV			2.35 H	124	93.5	1.6
3	5350.00	52.0 PK	74.0	-22.0	2.35 H	124	50.1	1.9
4	5350.00	39.4 AV	54.0	-14.6	2.35 H	124	37.5	1.9
5	#10480.00	52.3 PK	74.0	-21.7	1.49 H	244	40.3	12.0
6	#10480.00	41.4 AV	54.0	-12.6	1.49 H	244	29.4	12.0
7	15720.00	50.4 PK	74.0	-23.6	1.25 H	304	37.2	13.2
8	15720.00	39.2 AV	54.0	-14.8	1.25 H	304	26.0	13.2

ANTENNA POLARITY & TEST DISTANCE: VERTICAL AT 3 M

NO.	FREQ. (MHz)	EMISSION LEVEL (dBuV/m)	LIMIT (dBuV/m)	MARGIN (dB)	ANTENNA HEIGHT (m)	TABLE ANGLE (Degree)	RAW VALUE (dBuV)	CORRECTION FACTOR (dB/m)
1	*5240.00	112.0 PK			2.89 V	316	110.4	1.6
2	*5240.00	101.1 AV			2.89 V	316	99.5	1.6
3	5350.00	52.1 PK	74.0	-21.9	2.89 V	316	50.2	1.9
4	5350.00	40.7 AV	54.0	-13.3	2.89 V	316	38.8	1.9
5	#10480.00	54.3 PK	74.0	-19.7	2.49 V	323	42.3	12.0
6	#10480.00	42.8 AV	54.0	-11.2	2.49 V	323	30.8	12.0
7	15720.00	50.8 PK	74.0	-23.2	1.98 V	124	37.6	13.2
8	15720.00	38.4 AV	54.0	-15.6	1.98 V	124	25.2	13.2

REMARKS:

1. Emission Level(dBuV/m) = Raw Value(dBuV) + Correction Factor(dB/m)
2. Correction Factor(dB/m) = Antenna Factor(dB/m) + Cable Factor(dB) – Pre-Amplifier Factor(dB)
3. The other emission levels were very low against the limit.
4. Margin value = Emission Level – Limit value
5. " * ": Fundamental frequency.
6. " # ": The radiated frequency is out of the restricted band.

CHANNEL	TX Channel 149	DETECTOR FUNCTION	Peak (PK)
FREQUENCY RANGE	1GHz ~ 40GHz		Average (AV)

ANTENNA POLARITY & TEST DISTANCE: HORIZONTAL AT 3 M

NO.	FREQ. (MHz)	EMISSION LEVEL (dBuV/m)	LIMIT (dBuV/m)	MARGIN (dB)	ANTENNA HEIGHT (m)	TABLE ANGLE (Degree)	RAW VALUE (dBuV)	CORRECTION FACTOR (dB/m)
1	*5745.00	111.9 PK			3.26 H	265	109.2	2.7
2	*5745.00	100.6 AV			3.26 H	265	97.9	2.7
3	11490.00	55.8 PK	74.0	-18.2	1.55 H	239	42.4	13.4
4	11490.00	43.4 AV	54.0	-10.6	1.55 H	239	30.0	13.4
5	#17235.00	51.6 PK	74.0	-22.4	1.31 H	302	33.3	18.3
6	#17235.00	40.6 AV	54.0	-13.4	1.31 H	302	22.3	18.3

ANTENNA POLARITY & TEST DISTANCE: VERTICAL AT 3 M

NO.	FREQ. (MHz)	EMISSION LEVEL (dBuV/m)	LIMIT (dBuV/m)	MARGIN (dB)	ANTENNA HEIGHT (m)	TABLE ANGLE (Degree)	RAW VALUE (dBuV)	CORRECTION FACTOR (dB/m)
1	*5745.00	117.1 PK			2.63 V	150	114.4	2.7
2	*5745.00	105.6 AV			2.63 V	150	102.9	2.7
3	11490.00	51.5 PK	74.0	-22.5	2.44 V	310	38.1	13.4
4	11490.00	40.2 AV	54.0	-13.8	2.44 V	310	26.8	13.4
5	#17235.00	54.2 PK	74.0	-19.8	1.90 V	125	35.9	18.3
6	#17235.00	43.3 AV	54.0	-10.7	1.90 V	125	25.0	18.3

REMARKS:

1. Emission Level(dBuV/m) = Raw Value(dBuV) + Correction Factor(dB/m)
2. Correction Factor(dB/m) = Antenna Factor(dB/m) + Cable Factor(dB) – Pre-Amplifier Factor(dB)
3. The other emission levels were very low against the limit.
4. Margin value = Emission Level – Limit value
5. " * ": Fundamental frequency.
6. " # ": The radiated frequency is out of the restricted band.

CHANNEL	TX Channel 157	DETECTOR FUNCTION	Peak (PK)
FREQUENCY RANGE	1GHz ~ 40GHz		Average (AV)

ANTENNA POLARITY & TEST DISTANCE: HORIZONTAL AT 3 M

NO.	FREQ. (MHz)	EMISSION LEVEL (dBuV/m)	LIMIT (dBuV/m)	MARGIN (dB)	ANTENNA HEIGHT (m)	TABLE ANGLE (Degree)	RAW VALUE (dBuV)	CORRECTION FACTOR (dB/m)
1	*5785.00	111.0 PK			3.27 H	261	108.3	2.7
2	*5785.00	99.8 AV			3.27 H	261	97.1	2.7
3	11570.00	55.8 PK	74.0	-18.2	1.57 H	253	42.7	13.1
4	11570.00	43.3 AV	54.0	-10.7	1.57 H	253	30.2	13.1
5	#17355.00	51.0 PK	74.0	-23.0	1.36 H	314	32.2	18.8
6	#17355.00	40.2 AV	54.0	-13.8	1.36 H	314	21.4	18.8

ANTENNA POLARITY & TEST DISTANCE: VERTICAL AT 3 M

NO.	FREQ. (MHz)	EMISSION LEVEL (dBuV/m)	LIMIT (dBuV/m)	MARGIN (dB)	ANTENNA HEIGHT (m)	TABLE ANGLE (Degree)	RAW VALUE (dBuV)	CORRECTION FACTOR (dB/m)
1	*5785.00	116.2 PK			2.64 V	343	113.5	2.7
2	*5785.00	105.0 AV			2.64 V	343	102.3	2.7
3	11570.00	51.6 PK	74.0	-22.4	2.45 V	300	38.5	13.1
4	11570.00	40.5 AV	54.0	-13.5	2.45 V	300	27.4	13.1
5	#17355.00	53.6 PK	74.0	-20.4	1.88 V	127	34.8	18.8
6	#17355.00	42.8 AV	54.0	-11.2	1.88 V	127	24.0	18.8

REMARKS:

1. Emission Level(dBuV/m) = Raw Value(dBuV) + Correction Factor(dB/m)
2. Correction Factor(dB/m) = Antenna Factor(dB/m) + Cable Factor(dB) – Pre-Amplifier Factor(dB)
3. The other emission levels were very low against the limit.
4. Margin value = Emission Level – Limit value
5. " * ": Fundamental frequency.
6. " # ": The radiated frequency is out of the restricted band.

CHANNEL	TX Channel 165	DETECTOR FUNCTION	Peak (PK)
FREQUENCY RANGE	1GHz ~ 40GHz		Average (AV)

ANTENNA POLARITY & TEST DISTANCE: HORIZONTAL AT 3 M

NO.	FREQ. (MHz)	EMISSION LEVEL (dBuV/m)	LIMIT (dBuV/m)	MARGIN (dB)	ANTENNA HEIGHT (m)	TABLE ANGLE (Degree)	RAW VALUE (dBuV)	CORRECTION FACTOR (dB/m)
1	*5825.00	109.7 PK			3.22 H	264	107.0	2.7
2	*5825.00	98.8 AV			3.22 H	264	96.1	2.7
3	11650.00	55.8 PK	74.0	-18.2	1.55 H	227	42.7	13.1
4	11650.00	43.6 AV	54.0	-10.4	1.55 H	227	30.5	13.1
5	#17475.00	51.7 PK	74.0	-22.3	1.29 H	317	32.5	19.2
6	#17475.00	40.9 AV	54.0	-13.1	1.29 H	317	21.7	19.2

ANTENNA POLARITY & TEST DISTANCE: VERTICAL AT 3 M

NO.	FREQ. (MHz)	EMISSION LEVEL (dBuV/m)	LIMIT (dBuV/m)	MARGIN (dB)	ANTENNA HEIGHT (m)	TABLE ANGLE (Degree)	RAW VALUE (dBuV)	CORRECTION FACTOR (dB/m)
1	*5825.00	114.8 PK			2.19 V	161	112.1	2.7
2	*5825.00	103.8 AV			2.19 V	161	101.1	2.7
3	11650.00	50.9 PK	74.0	-23.1	2.46 V	307	37.8	13.1
4	11650.00	39.8 AV	54.0	-14.2	2.46 V	307	26.7	13.1
5	#17475.00	54.2 PK	74.0	-19.8	1.88 V	136	35.0	19.2
6	#17475.00	43.0 AV	54.0	-11.0	1.88 V	136	23.8	19.2

REMARKS:

1. Emission Level(dBuV/m) = Raw Value(dBuV) + Correction Factor(dB/m)
2. Correction Factor(dB/m) = Antenna Factor(dB/m) + Cable Factor(dB) – Pre-Amplifier Factor(dB)
3. The other emission levels were very low against the limit.
4. Margin value = Emission Level – Limit value
5. " * ": Fundamental frequency.
6. " # ": The radiated frequency is out of the restricted band.

802.11ac (VHT20)

CHANNEL	TX Channel 36	DETECTOR FUNCTION	Peak (PK)
FREQUENCY RANGE	1GHz ~ 40GHz		Average (AV)

ANTENNA POLARITY & TEST DISTANCE: HORIZONTAL AT 3 M								
NO.	FREQ. (MHz)	EMISSION LEVEL (dBuV/m)	LIMIT (dBuV/m)	MARGIN (dB)	ANTENNA HEIGHT (m)	TABLE ANGLE (Degree)	RAW VALUE (dBuV)	CORRECTION FACTOR (dB/m)
1	5150.00	55.2 PK	74.0	-18.8	2.20 H	222	53.7	1.5
2	5150.00	40.7 AV	54.0	-13.3	2.20 H	222	39.2	1.5
3	*5180.00	106.6 PK			2.20 H	222	105.0	1.6
4	*5180.00	94.7 AV			2.20 H	222	93.1	1.6
5	5376.00	52.1 PK	74.0	-21.9	2.20 H	222	50.0	2.1
6	5376.00	38.2 AV	54.0	-15.8	2.20 H	222	36.1	2.1
7	#10360.00	55.2 PK	74.0	-18.8	1.52 H	240	43.7	11.5
8	#10360.00	43.3 AV	54.0	-10.7	1.52 H	240	31.8	11.5
9	15540.00	51.8 PK	74.0	-22.2	1.26 H	308	38.7	13.1
10	15540.00	40.8 AV	54.0	-13.2	1.26 H	308	27.7	13.1

ANTENNA POLARITY & TEST DISTANCE: VERTICAL AT 3 M								
NO.	FREQ. (MHz)	EMISSION LEVEL (dBuV/m)	LIMIT (dBuV/m)	MARGIN (dB)	ANTENNA HEIGHT (m)	TABLE ANGLE (Degree)	RAW VALUE (dBuV)	CORRECTION FACTOR (dB/m)
1	5150.00	68.4 PK	74.0	-5.6	2.34 V	314	66.9	1.5
2	5150.00	53.6 AV	54.0	-0.4	2.34 V	314	52.1	1.5
3	*5180.00	112.5 PK			2.34 V	314	110.9	1.6
4	*5180.00	102.1 AV			2.34 V	314	100.5	1.6
5	5376.00	54.1 PK	74.0	-19.9	2.24 V	315	52.0	2.1
6	5376.00	43.1 AV	54.0	-10.9	2.24 V	315	41.0	2.1
7	#10360.00	51.1 PK	74.0	-22.9	2.43 V	309	39.6	11.5
8	#10360.00	40.1 AV	54.0	-13.9	2.43 V	309	28.6	11.5
9	15540.00	53.7 PK	74.0	-20.3	1.88 V	134	40.6	13.1
10	15540.00	42.7 AV	54.0	-11.3	1.88 V	134	29.6	13.1

REMARKS:

1. Emission Level(dBuV/m) = Raw Value(dBuV) + Correction Factor(dB/m)
2. Correction Factor(dB/m) = Antenna Factor(dB/m) + Cable Factor(dB) – Pre-Amplifier Factor(dB)
3. The other emission levels were very low against the limit.
4. Margin value = Emission Level – Limit value
5. " * ": Fundamental frequency.
6. " # ": The radiated frequency is out of the restricted band.

CHANNEL	TX Channel 40	DETECTOR FUNCTION	Peak (PK)
FREQUENCY RANGE	1GHz ~ 40GHz		Average (AV)

ANTENNA POLARITY & TEST DISTANCE: HORIZONTAL AT 3 M

NO.	FREQ. (MHz)	EMISSION LEVEL (dBuV/m)	LIMIT (dBuV/m)	MARGIN (dB)	ANTENNA HEIGHT (m)	TABLE ANGLE (Degree)	RAW VALUE (dBuV)	CORRECTION FACTOR (dB/m)
1	*5200.00	106.1 PK			2.40 H	127	104.4	1.7
2	*5200.00	94.1 AV			2.40 H	127	92.4	1.7
3	#10400.00	56.1 PK	74.0	-17.9	1.51 H	233	44.5	11.6
4	#10400.00	43.6 AV	54.0	-10.4	1.51 H	233	32.0	11.6
5	15600.00	51.5 PK	74.0	-22.5	1.27 H	324	38.4	13.1
6	15600.00	40.8 AV	54.0	-13.2	1.27 H	324	27.7	13.1

ANTENNA POLARITY & TEST DISTANCE: VERTICAL AT 3 M

NO.	FREQ. (MHz)	EMISSION LEVEL (dBuV/m)	LIMIT (dBuV/m)	MARGIN (dB)	ANTENNA HEIGHT (m)	TABLE ANGLE (Degree)	RAW VALUE (dBuV)	CORRECTION FACTOR (dB/m)
1	*5200.00	113.0 PK			2.33 V	208	111.3	1.7
2	*5200.00	102.1 AV			2.33 V	208	100.4	1.7
3	#10400.00	50.4 PK	74.0	-23.6	2.43 V	317	38.8	11.6
4	#10400.00	39.4 AV	54.0	-14.6	2.43 V	317	27.8	11.6
5	15600.00	54.2 PK	74.0	-19.8	1.90 V	136	41.1	13.1
6	15600.00	42.8 AV	54.0	-11.2	1.90 V	136	29.7	13.1

REMARKS:

1. Emission Level(dBuV/m) = Raw Value(dBuV) + Correction Factor(dB/m)
2. Correction Factor(dB/m) = Antenna Factor(dB/m) + Cable Factor(dB) – Pre-Amplifier Factor(dB)
3. The other emission levels were very low against the limit.
4. Margin value = Emission Level – Limit value
5. " * ": Fundamental frequency.
6. " # ": The radiated frequency is out of the restricted band.

CHANNEL	TX Channel 48	DETECTOR FUNCTION	Peak (PK)
FREQUENCY RANGE	1GHz ~ 40GHz		Average (AV)

ANTENNA POLARITY & TEST DISTANCE: HORIZONTAL AT 3 M

NO.	FREQ. (MHz)	EMISSION LEVEL (dBuV/m)	LIMIT (dBuV/m)	MARGIN (dB)	ANTENNA HEIGHT (m)	TABLE ANGLE (Degree)	RAW VALUE (dBuV)	CORRECTION FACTOR (dB/m)
1	*5240.00	105.8 PK			2.44 H	123	104.2	1.6
2	*5240.00	93.9 AV			2.44 H	123	92.3	1.6
3	5376.00	51.6 PK	74.0	-22.4	2.44 H	123	49.5	2.1
4	5376.00	38.0 AV	54.0	-16.0	2.44 H	123	35.9	2.1
5	#10480.00	56.2 PK	74.0	-17.8	1.59 H	233	44.2	12.0
6	#10480.00	43.7 AV	54.0	-10.3	1.59 H	233	31.7	12.0
7	15720.00	51.8 PK	74.0	-22.2	1.30 H	306	38.6	13.2
8	15720.00	41.3 AV	54.0	-12.7	1.30 H	306	28.1	13.2

ANTENNA POLARITY & TEST DISTANCE: VERTICAL AT 3 M

NO.	FREQ. (MHz)	EMISSION LEVEL (dBuV/m)	LIMIT (dBuV/m)	MARGIN (dB)	ANTENNA HEIGHT (m)	TABLE ANGLE (Degree)	RAW VALUE (dBuV)	CORRECTION FACTOR (dB/m)
1	*5240.00	111.9 PK			2.39 V	307	110.3	1.6
2	*5240.00	101.6 AV			2.39 V	307	100.0	1.6
3	5376.00	52.8 PK	74.0	-21.2	2.39 V	307	50.7	2.1
4	5376.00	44.6 AV	54.0	-9.4	2.39 V	307	42.5	2.1
5	#10480.00	50.8 PK	74.0	-23.2	2.45 V	293	38.8	12.0
6	#10480.00	39.6 AV	54.0	-14.4	2.45 V	293	27.6	12.0
7	15720.00	54.3 PK	74.0	-19.7	1.88 V	143	41.1	13.2
8	15720.00	42.8 AV	54.0	-11.2	1.88 V	143	29.6	13.2

REMARKS:

1. Emission Level(dBuV/m) = Raw Value(dBuV) + Correction Factor(dB/m)
2. Correction Factor(dB/m) = Antenna Factor(dB/m) + Cable Factor(dB) – Pre-Amplifier Factor(dB)
3. The other emission levels were very low against the limit.
4. Margin value = Emission Level – Limit value
5. " * ": Fundamental frequency.
6. " # ": The radiated frequency is out of the restricted band.

CHANNEL	TX Channel 149	DETECTOR FUNCTION	Peak (PK)
FREQUENCY RANGE	1GHz ~ 40GHz		Average (AV)

ANTENNA POLARITY & TEST DISTANCE: HORIZONTAL AT 3 M

NO.	FREQ. (MHz)	EMISSION LEVEL (dBuV/m)	LIMIT (dBuV/m)	MARGIN (dB)	ANTENNA HEIGHT (m)	TABLE ANGLE (Degree)	RAW VALUE (dBuV)	CORRECTION FACTOR (dB/m)
1	*5745.00	109.7 PK			3.26 H	258	107.0	2.7
2	*5745.00	99.4 AV			3.26 H	258	96.7	2.7
3	11490.00	55.8 PK	74.0	-18.2	1.55 H	241	42.4	13.4
4	11490.00	43.3 AV	54.0	-10.7	1.55 H	241	29.9	13.4
5	#17235.00	51.5 PK	74.0	-22.5	1.29 H	308	33.2	18.3
6	#17235.00	40.8 AV	54.0	-13.2	1.29 H	308	22.5	18.3

ANTENNA POLARITY & TEST DISTANCE: VERTICAL AT 3 M

NO.	FREQ. (MHz)	EMISSION LEVEL (dBuV/m)	LIMIT (dBuV/m)	MARGIN (dB)	ANTENNA HEIGHT (m)	TABLE ANGLE (Degree)	RAW VALUE (dBuV)	CORRECTION FACTOR (dB/m)
1	*5745.00	114.9 PK			2.48 V	156	112.2	2.7
2	*5745.00	104.5 AV			2.48 V	156	101.8	2.7
3	11490.00	51.0 PK	74.0	-23.0	2.45 V	298	37.6	13.4
4	11490.00	39.6 AV	54.0	-14.4	2.45 V	298	26.2	13.4
5	#17235.00	53.7 PK	74.0	-20.3	1.90 V	143	35.4	18.3
6	#17235.00	42.6 AV	54.0	-11.4	1.90 V	143	24.3	18.3

REMARKS:

1. Emission Level(dBuV/m) = Raw Value(dBuV) + Correction Factor(dB/m)
2. Correction Factor(dB/m) = Antenna Factor(dB/m) + Cable Factor(dB) – Pre-Amplifier Factor(dB)
3. The other emission levels were very low against the limit.
4. Margin value = Emission Level – Limit value
5. " * ": Fundamental frequency.
6. " # ": The radiated frequency is out of the restricted band.

CHANNEL	TX Channel 157	DETECTOR FUNCTION	Peak (PK)
FREQUENCY RANGE	1GHz ~ 40GHz		Average (AV)

ANTENNA POLARITY & TEST DISTANCE: HORIZONTAL AT 3 M

NO.	FREQ. (MHz)	EMISSION LEVEL (dBuV/m)	LIMIT (dBuV/m)	MARGIN (dB)	ANTENNA HEIGHT (m)	TABLE ANGLE (Degree)	RAW VALUE (dBuV)	CORRECTION FACTOR (dB/m)
1	*5785.00	109.8 PK			3.22 H	255	107.1	2.7
2	*5785.00	100.1 AV			3.22 H	255	97.4	2.7
3	11570.00	55.6 PK	74.0	-18.4	1.53 H	220	42.5	13.1
4	11570.00	43.3 AV	54.0	-10.7	1.53 H	220	30.2	13.1
5	#17355.00	52.1 PK	74.0	-21.9	1.29 H	316	33.3	18.8
6	#17355.00	41.2 AV	54.0	-12.8	1.29 H	316	22.4	18.8

ANTENNA POLARITY & TEST DISTANCE: VERTICAL AT 3 M

NO.	FREQ. (MHz)	EMISSION LEVEL (dBuV/m)	LIMIT (dBuV/m)	MARGIN (dB)	ANTENNA HEIGHT (m)	TABLE ANGLE (Degree)	RAW VALUE (dBuV)	CORRECTION FACTOR (dB/m)
1	*5785.00	115.0 PK			2.57 V	335	112.3	2.7
2	*5785.00	105.1 AV			2.57 V	335	102.4	2.7
3	11570.00	50.5 PK	74.0	-23.5	2.49 V	293	37.4	13.1
4	11570.00	39.5 AV	54.0	-14.5	2.49 V	293	26.4	13.1
5	#17355.00	53.8 PK	74.0	-20.2	1.93 V	137	35.0	18.8
6	#17355.00	42.5 AV	54.0	-11.5	1.93 V	137	23.7	18.8

REMARKS:

1. Emission Level(dBuV/m) = Raw Value(dBuV) + Correction Factor(dB/m)
2. Correction Factor(dB/m) = Antenna Factor(dB/m) + Cable Factor(dB) – Pre-Amplifier Factor(dB)
3. The other emission levels were very low against the limit.
4. Margin value = Emission Level – Limit value
5. " * ": Fundamental frequency.
6. " # ": The radiated frequency is out of the restricted band.

CHANNEL	TX Channel 165	DETECTOR FUNCTION	Peak (PK)
FREQUENCY RANGE	1GHz ~ 40GHz		Average (AV)

ANTENNA POLARITY & TEST DISTANCE: HORIZONTAL AT 3 M

NO.	FREQ. (MHz)	EMISSION LEVEL (dBuV/m)	LIMIT (dBuV/m)	MARGIN (dB)	ANTENNA HEIGHT (m)	TABLE ANGLE (Degree)	RAW VALUE (dBuV)	CORRECTION FACTOR (dB/m)
1	*5825.00	109.1 PK			3.24 H	269	106.4	2.7
2	*5825.00	98.5 AV			3.24 H	269	95.8	2.7
3	11650.00	55.7 PK	74.0	-18.3	1.49 H	234	42.6	13.1
4	11650.00	43.7 AV	54.0	-10.3	1.49 H	234	30.6	13.1
5	#17475.00	52.4 PK	74.0	-21.6	1.29 H	310	33.2	19.2
6	#17475.00	41.4 AV	54.0	-12.6	1.29 H	310	22.2	19.2

ANTENNA POLARITY & TEST DISTANCE: VERTICAL AT 3 M

NO.	FREQ. (MHz)	EMISSION LEVEL (dBuV/m)	LIMIT (dBuV/m)	MARGIN (dB)	ANTENNA HEIGHT (m)	TABLE ANGLE (Degree)	RAW VALUE (dBuV)	CORRECTION FACTOR (dB/m)
1	*5825.00	114.1 PK			2.12 V	347	111.4	2.7
2	*5825.00	103.6 AV			2.12 V	347	100.9	2.7
3	11650.00	50.7 PK	74.0	-23.3	2.42 V	319	37.6	13.1
4	11650.00	39.7 AV	54.0	-14.3	2.42 V	319	26.6	13.1
5	#17475.00	54.8 PK	74.0	-19.2	1.94 V	128	35.6	19.2
6	#17475.00	43.5 AV	54.0	-10.5	1.94 V	128	24.3	19.2

REMARKS:

- Emission Level(dBuV/m) = Raw Value(dBuV) + Correction Factor(dB/m)
- Correction Factor(dB/m) = Antenna Factor(dB/m) + Cable Factor(dB) – Pre-Amplifier Factor(dB)
- The other emission levels were very low against the limit.
- Margin value = Emission Level – Limit value
- " * ": Fundamental frequency.
- " # ": The radiated frequency is out of the restricted band.

802.11ac (VHT40)

CHANNEL	TX Channel 38	DETECTOR FUNCTION	Peak (PK)
FREQUENCY RANGE	1GHz ~ 40GHz		Average (AV)

ANTENNA POLARITY & TEST DISTANCE: HORIZONTAL AT 3 M

NO.	FREQ. (MHz)	EMISSION LEVEL (dBuV/m)	LIMIT (dBuV/m)	MARGIN (dB)	ANTENNA HEIGHT (m)	TABLE ANGLE (Degree)	RAW VALUE (dBuV)	CORRECTION FACTOR (dB/m)
1	5150.00	52.5 PK	74.0	-21.5	3.33 H	260	51.0	1.5
2	5150.00	38.7 AV	54.0	-15.3	3.33 H	260	37.2	1.5
3	*5190.00	104.5 PK			3.33 H	260	102.8	1.7
4	*5190.00	93.5 AV			3.33 H	260	91.8	1.7
5	5375.00	48.9 PK	74.0	-25.1	3.33 H	260	46.8	2.1
6	5375.00	36.5 AV	54.0	-17.5	3.33 H	260	34.4	2.1
7	#10380.00	55.1 PK	74.0	-18.9	1.54 H	231	43.6	11.5
8	#10380.00	40.2 AV	54.0	-13.8	1.54 H	231	28.7	11.5
9	15570.00	51.8 PK	74.0	-22.2	1.29 H	300	38.7	13.1
10	15570.00	42.6 AV	54.0	-11.4	1.29 H	300	29.5	13.1

ANTENNA POLARITY & TEST DISTANCE: VERTICAL AT 3 M

NO.	FREQ. (MHz)	EMISSION LEVEL (dBuV/m)	LIMIT (dBuV/m)	MARGIN (dB)	ANTENNA HEIGHT (m)	TABLE ANGLE (Degree)	RAW VALUE (dBuV)	CORRECTION FACTOR (dB/m)
1	5150.00	68.1 PK	74.0	-5.9	2.78 V	312	66.6	1.5
2	5150.00	53.8 AV	54.0	-0.2	2.78 V	312	52.3	1.5
3	*5190.00	109.4 PK			2.78 V	312	107.7	1.7
4	*5190.00	98.2 AV			2.78 V	312	96.5	1.7
5	5375.00	53.9 PK	74.0	-20.1	2.78 V	312	51.8	2.1
6	5375.00	44.0 AV	54.0	-10.0	2.78 V	312	41.9	2.1
7	#10380.00	48.2 PK	74.0	-25.8	2.38 V	312	36.7	11.5
8	#10380.00	37.1 AV	54.0	-16.9	2.38 V	312	25.6	11.5
9	15570.00	50.5 PK	74.0	-23.5	1.84 V	130	37.4	13.1
10	15570.00	39.1 AV	54.0	-14.9	1.84 V	130	26.0	13.1

REMARKS:

1. Emission Level(dBuV/m) = Raw Value(dBuV) + Correction Factor(dB/m)
2. Correction Factor(dB/m) = Antenna Factor(dB/m) + Cable Factor(dB) – Pre-Amplifier Factor(dB)
3. The other emission levels were very low against the limit.
4. Margin value = Emission Level – Limit value
5. " * ": Fundamental frequency.
6. " # ": The radiated frequency is out of the restricted band.

CHANNEL	TX Channel 46	DETECTOR FUNCTION	Peak (PK)
FREQUENCY RANGE	1GHz ~ 40GHz		Average (AV)

ANTENNA POLARITY & TEST DISTANCE: HORIZONTAL AT 3 M

NO.	FREQ. (MHz)	EMISSION LEVEL (dBuV/m)	LIMIT (dBuV/m)	MARGIN (dB)	ANTENNA HEIGHT (m)	TABLE ANGLE (Degree)	RAW VALUE (dBuV)	CORRECTION FACTOR (dB/m)
1	5150.00	48.6 PK	74.0	-25.4	3.10 H	245	47.1	1.5
2	5150.00	36.1 AV	54.0	-17.9	3.10 H	245	34.6	1.5
3	*5230.00	108.5 PK			3.10 H	245	106.9	1.6
4	*5230.00	97.6 AV			3.10 H	245	96.0	1.6
5	5376.00	51.9 PK	74.0	-22.1	3.10 H	245	49.8	2.1
6	5376.00	38.4 AV	54.0	-15.6	3.10 H	245	36.3	2.1
7	#10460.00	55.2 PK	74.0	-18.8	1.51 H	242	43.3	11.9
8	#10460.00	43.3 AV	54.0	-10.7	1.51 H	242	31.4	11.9
9	15690.00	56.9 PK	74.0	-17.1	1.21 H	298	43.6	13.3
10	15690.00	45.1 AV	54.0	-8.9	1.21 H	298	31.8	13.3

ANTENNA POLARITY & TEST DISTANCE: VERTICAL AT 3 M

NO.	FREQ. (MHz)	EMISSION LEVEL (dBuV/m)	LIMIT (dBuV/m)	MARGIN (dB)	ANTENNA HEIGHT (m)	TABLE ANGLE (Degree)	RAW VALUE (dBuV)	CORRECTION FACTOR (dB/m)
1	5150.00	63.2 PK	74.0	-10.8	2.38 V	312	61.7	1.5
2	5150.00	53.3 AV	54.0	-0.7	2.38 V	312	51.8	1.5
3	*5230.00	113.5 PK			2.38 V	312	111.9	1.6
4	*5230.00	102.8 AV			2.38 V	312	101.2	1.6
5	5376.00	56.4 PK	74.0	-17.6	2.38 V	312	54.3	2.1
6	5376.00	44.2 AV	54.0	-9.8	2.38 V	312	42.1	2.1
7	#10460.00	51.1 PK	74.0	-22.9	2.42 V	314	39.2	11.9
8	#10460.00	40.2 AV	54.0	-13.8	2.42 V	314	28.3	11.9
9	15690.00	53.9 PK	74.0	-20.1	1.94 V	139	40.6	13.3
10	15690.00	43.1 AV	54.0	-10.9	1.94 V	139	29.8	13.3

REMARKS:

1. Emission Level(dBuV/m) = Raw Value(dBuV) + Correction Factor(dB/m)
2. Correction Factor(dB/m) = Antenna Factor(dB/m) + Cable Factor(dB) – Pre-Amplifier Factor(dB)
3. The other emission levels were very low against the limit.
4. Margin value = Emission Level – Limit value
5. " * ": Fundamental frequency.
6. " # ": The radiated frequency is out of the restricted band.

CHANNEL	TX Channel 151	DETECTOR FUNCTION	Peak (PK)
FREQUENCY RANGE	1GHz ~ 40GHz		Average (AV)

ANTENNA POLARITY & TEST DISTANCE: HORIZONTAL AT 3 M

NO.	FREQ. (MHz)	EMISSION LEVEL (dBuV/m)	LIMIT (dBuV/m)	MARGIN (dB)	ANTENNA HEIGHT (m)	TABLE ANGLE (Degree)	RAW VALUE (dBuV)	CORRECTION FACTOR (dB/m)
1	*5755.00	107.6 PK			3.22 H	283	104.9	2.7
2	*5755.00	97.0 AV			3.22 H	283	94.3	2.7
3	11510.00	53.8 PK	74.0	-20.2	1.50 H	223	40.4	13.4
4	11510.00	42.4 AV	54.0	-11.6	1.50 H	223	29.0	13.4
5	#17265.00	50.6 PK	74.0	-23.4	1.25 H	303	32.3	18.3
6	#17265.00	39.6 AV	54.0	-14.4	1.25 H	303	21.3	18.3

ANTENNA POLARITY & TEST DISTANCE: VERTICAL AT 3 M

NO.	FREQ. (MHz)	EMISSION LEVEL (dBuV/m)	LIMIT (dBuV/m)	MARGIN (dB)	ANTENNA HEIGHT (m)	TABLE ANGLE (Degree)	RAW VALUE (dBuV)	CORRECTION FACTOR (dB/m)
1	*5755.00	112.7 PK			2.47 V	343	110.0	2.7
2	*5755.00	102.0 AV			2.47 V	343	99.3	2.7
3	11510.00	49.6 PK	74.0	-24.4	2.49 V	290	36.2	13.4
4	11510.00	38.3 AV	54.0	-15.7	2.49 V	290	24.9	13.4
5	#17265.00	53.0 PK	74.0	-21.0	1.88 V	128	34.7	18.3
6	#17265.00	41.6 AV	54.0	-12.4	1.88 V	128	23.3	18.3

REMARKS:

1. Emission Level(dBuV/m) = Raw Value(dBuV) + Correction Factor(dB/m)
2. Correction Factor(dB/m) = Antenna Factor(dB/m) + Cable Factor(dB) – Pre-Amplifier Factor(dB)
3. The other emission levels were very low against the limit.
4. Margin value = Emission Level – Limit value
5. " * ": Fundamental frequency.
6. " # ": The radiated frequency is out of the restricted band.

CHANNEL	TX Channel 159	DETECTOR FUNCTION	Peak (PK)
FREQUENCY RANGE	1GHz ~ 40GHz		Average (AV)

ANTENNA POLARITY & TEST DISTANCE: HORIZONTAL AT 3 M

NO.	FREQ. (MHz)	EMISSION LEVEL (dBuV/m)	LIMIT (dBuV/m)	MARGIN (dB)	ANTENNA HEIGHT (m)	TABLE ANGLE (Degree)	RAW VALUE (dBuV)	CORRECTION FACTOR (dB/m)
1	*5795.00	107.5 PK			3.28 H	282	104.8	2.7
2	*5795.00	96.8 AV			3.28 H	282	94.1	2.7
3	11590.00	53.8 PK	74.0	-20.2	1.51 H	217	40.8	13.0
4	11590.00	42.2 AV	54.0	-11.8	1.51 H	217	29.2	13.0
5	#17385.00	50.7 PK	74.0	-23.3	1.22 H	299	31.7	19.0
6	#17385.00	39.7 AV	54.0	-14.3	1.22 H	299	20.7	19.0

ANTENNA POLARITY & TEST DISTANCE: VERTICAL AT 3 M

NO.	FREQ. (MHz)	EMISSION LEVEL (dBuV/m)	LIMIT (dBuV/m)	MARGIN (dB)	ANTENNA HEIGHT (m)	TABLE ANGLE (Degree)	RAW VALUE (dBuV)	CORRECTION FACTOR (dB/m)
1	*5795.00	112.6 PK			2.55 V	341	109.9	2.7
2	*5795.00	101.8 AV			2.55 V	341	99.1	2.7
3	11590.00	49.5 PK	74.0	-24.5	2.51 V	291	36.5	13.0
4	11590.00	38.4 AV	54.0	-15.6	2.51 V	291	25.4	13.0
5	#17385.00	53.5 PK	74.0	-20.5	1.85 V	139	34.5	19.0
6	#17385.00	41.9 AV	54.0	-12.1	1.85 V	139	22.9	19.0

REMARKS:

1. Emission Level(dBuV/m) = Raw Value(dBuV) + Correction Factor(dB/m)
2. Correction Factor(dB/m) = Antenna Factor(dB/m) + Cable Factor(dB) – Pre-Amplifier Factor(dB)
3. The other emission levels were very low against the limit.
4. Margin value = Emission Level – Limit value
5. " * ": Fundamental frequency.
6. " # ": The radiated frequency is out of the restricted band.

802.11ac (VHT80)

CHANNEL	TX Channel 42	DETECTOR FUNCTION	Peak (PK)
FREQUENCY RANGE	1GHz ~ 40GHz		Average (AV)

ANTENNA POLARITY & TEST DISTANCE: HORIZONTAL AT 3 M

NO.	FREQ. (MHz)	EMISSION LEVEL (dBuV/m)	LIMIT (dBuV/m)	MARGIN (dB)	ANTENNA HEIGHT (m)	TABLE ANGLE (Degree)	RAW VALUE (dBuV)	CORRECTION FACTOR (dB/m)
1	5150.00	51.1 PK	74.0	-22.9	3.34 H	272	49.6	1.5
2	5150.00	37.4 AV	54.0	-16.6	3.34 H	272	35.9	1.5
3	*5210.00	99.2 PK			3.12 H	280	97.5	1.7
4	*5210.00	90.6 AV			3.12 H	280	88.9	1.7
5	5350.00	48.2 PK	74.0	-25.8	3.39 H	252	46.3	1.9
6	5350.00	35.6 AV	54.0	-18.4	3.39 H	252	33.7	1.9
7	#10420.00	54.9 PK	74.0	-19.1	1.48 H	231	43.2	11.7
8	#10420.00	40.2 AV	54.0	-13.8	1.48 H	231	28.5	11.7
9	15630.00	52.0 PK	74.0	-22.0	1.32 H	314	38.8	13.2
10	15630.00	42.8 AV	54.0	-11.2	1.32 H	314	29.6	13.2

ANTENNA POLARITY & TEST DISTANCE: VERTICAL AT 3 M

NO.	FREQ. (MHz)	EMISSION LEVEL (dBuV/m)	LIMIT (dBuV/m)	MARGIN (dB)	ANTENNA HEIGHT (m)	TABLE ANGLE (Degree)	RAW VALUE (dBuV)	CORRECTION FACTOR (dB/m)
1	5150.00	63.9 PK	74.0	-10.1	1.05 V	245	62.4	1.5
2	5150.00	53.8 AV	54.0	-0.2	1.05 V	245	52.3	1.5
3	*5210.00	104.5 PK			1.05 V	245	102.8	1.7
4	*5210.00	95.1 AV			1.05 V	245	93.4	1.7
5	5350.00	51.3 PK	74.0	-22.7	1.05 V	245	49.4	1.9
6	5350.00	41.3 AV	54.0	-12.7	1.05 V	245	39.4	1.9
7	#10420.00	46.5 PK	74.0	-27.5	2.41 V	308	34.8	11.7
8	#10420.00	35.1 AV	54.0	-18.9	2.41 V	308	23.4	11.7
9	15630.00	48.7 PK	74.0	-25.3	1.84 V	130	35.5	13.2
10	15630.00	37.3 AV	54.0	-16.7	1.84 V	130	24.1	13.2

REMARKS:

- Emission Level(dBuV/m) = Raw Value(dBuV) + Correction Factor(dB/m)
- Correction Factor(dB/m) = Antenna Factor(dB/m) + Cable Factor(dB) – Pre-Amplifier Factor(dB)
- The other emission levels were very low against the limit.
- Margin value = Emission Level – Limit value
- " * ": Fundamental frequency.
- " # ": The radiated frequency is out of the restricted band.

CHANNEL	TX Channel 155	DETECTOR FUNCTION	Peak (PK)
FREQUENCY RANGE	1GHz ~ 40GHz		Average (AV)

ANTENNA POLARITY & TEST DISTANCE: HORIZONTAL AT 3 M

NO.	FREQ. (MHz)	EMISSION LEVEL (dBuV/m)	LIMIT (dBuV/m)	MARGIN (dB)	ANTENNA HEIGHT (m)	TABLE ANGLE (Degree)	RAW VALUE (dBuV)	CORRECTION FACTOR (dB/m)
1	*5775.00	105.6 PK			3.35 H	291	102.9	2.7
2	*5775.00	95.5 AV			3.35 H	291	92.8	2.7
3	11550.00	51.7 PK	74.0	-22.3	1.51 H	228	38.5	13.2
4	11550.00	40.1 AV	54.0	-13.9	1.51 H	228	26.9	13.2
5	#17325.00	48.4 PK	74.0	-25.6	1.25 H	288	29.8	18.6
6	#17325.00	37.4 AV	54.0	-16.6	1.25 H	288	18.8	18.6

ANTENNA POLARITY & TEST DISTANCE: VERTICAL AT 3 M

NO.	FREQ. (MHz)	EMISSION LEVEL (dBuV/m)	LIMIT (dBuV/m)	MARGIN (dB)	ANTENNA HEIGHT (m)	TABLE ANGLE (Degree)	RAW VALUE (dBuV)	CORRECTION FACTOR (dB/m)
1	*5775.00	109.6 PK			2.44 V	154	106.9	2.7
2	*5775.00	100.1 AV			2.44 V	154	97.4	2.7
3	11550.00	46.8 PK	74.0	-27.2	2.51 V	291	33.6	13.2
4	11550.00	36.1 AV	54.0	-17.9	2.51 V	291	22.9	13.2
5	#17325.00	50.4 PK	74.0	-23.6	1.85 V	139	31.8	18.6
6	#17325.00	38.7 AV	54.0	-15.3	1.85 V	139	20.1	18.6

REMARKS:

1. Emission Level(dBuV/m) = Raw Value(dBuV) + Correction Factor(dB/m)
2. Correction Factor(dB/m) = Antenna Factor(dB/m) + Cable Factor(dB) – Pre-Amplifier Factor(dB)
3. The other emission levels were very low against the limit.
4. Margin value = Emission Level – Limit value
5. " * ": Fundamental frequency.
6. " # ": The radiated frequency is out of the restricted band.

Below 1GHz Data:

802.11a

CHANNEL	TX Channel 157	DETECTOR FUNCTION	Quasi-Peak (QP)
FREQUENCY RANGE	9kHz ~ 1GHz		

ANTENNA POLARITY & TEST DISTANCE: HORIZONTAL AT 3 M								
NO.	FREQ. (MHz)	EMISSION LEVEL (dBuV/m)	LIMIT (dBuV/m)	MARGIN (dB)	ANTENNA HEIGHT (m)	TABLE ANGLE (Degree)	RAW VALUE (dBuV)	CORRECTION FACTOR (dB/m)
1	47.53	31.5 QP	40.0	-8.5	1.00 H	305	40.3	-8.8
2	125.00	40.4 QP	43.5	-3.1	1.00 H	115	50.7	-10.3
3	250.02	27.5 QP	46.0	-18.5	1.50 H	206	37.5	-10.0
4	537.60	36.0 QP	46.0	-10.0	1.50 H	224	38.3	-2.3
5	671.97	39.4 QP	46.0	-6.6	1.00 H	134	39.2	0.2
6	766.16	31.2 QP	46.0	-14.8	1.50 H	187	29.0	2.2

ANTENNA POLARITY & TEST DISTANCE: VERTICAL AT 3 M								
NO.	FREQ. (MHz)	EMISSION LEVEL (dBuV/m)	LIMIT (dBuV/m)	MARGIN (dB)	ANTENNA HEIGHT (m)	TABLE ANGLE (Degree)	RAW VALUE (dBuV)	CORRECTION FACTOR (dB/m)
1	30.35	35.7 QP	40.0	-4.3	1.00 V	226	45.6	-9.9
2	125.00	42.1 QP	43.5	-1.4	1.00 V	124	52.4	-10.3
3	194.08	27.4 QP	43.5	-16.1	1.00 V	223	39.1	-11.7
4	537.60	35.6 QP	46.0	-10.4	1.00 V	203	37.9	-2.3
5	613.53	32.2 QP	46.0	-13.8	1.50 V	206	32.4	-0.2
6	1000.00	34.4 QP	54.0	-19.6	1.50 V	143	29.5	4.9

REMARKS:

1. Emission Level(dBuV/m) = Raw Value(dBuV) + Correction Factor(dB/m)
2. Correction Factor(dB/m) = Antenna Factor(dB/m) + Cable Factor(dB) – Pre-Amplifier Factor(dB)
3. The other emission levels were very low against the limit.
4. Margin value = Emission Level – Limit value

4.2 Conducted Emission Measurement

4.2.1 Limits of Conducted Emission Measurement

Frequency (MHz)	Conducted Limit (dBuV)	
	Quasi-peak	Average
0.15 - 0.5	66 - 56	56 - 46
0.50 - 5.0	56	46
5.0 - 30.0	60	50

Note: 1. The lower limit shall apply at the transition frequencies.

2. The limit decreases in line with the logarithm of the frequency in the range of 0.15 to 0.50MHz.

4.2.2 Test Instruments

DESCRIPTION & MANUFACTURER	MODEL NO.	SERIAL NO.	CALIBRATED DATE	CALIBRATED UNTIL
Test Receiver R&S	ESCS 30	847124/029	Oct. 24, 2016	Oct. 23, 2017
Line-Impedance Stabilization Network (for EUT) R&S	ESH3-Z5	848773/004	Oct. 26, 2016	Oct. 25, 2017
RF Cable	5D-FB	COCCAB-001	Sep. 30, 2016	Sep. 29, 2017
10 dB PAD Mini-Circuits	HAT-10+	CONATT-004	June 20, 2016	June 19, 2017
Software BVADT	BVADT_Cond_ V7.3.7.4	NA	NA	NA

Note:

1. The calibration interval of the above test instruments are 12 months and the calibrations are traceable to NML/ROC and NIST/USA.
2. The test was performed in Shielded Room No. 1.
- 3 Tested Date:Nov. 22, 2016

4.2.3 Test Procedure

- The EUT was placed 0.4 meters from the conducting wall of the shielded room with EUT being connected to the power mains through a line impedance stabilization network (LISN). Other support units were connected to the power mains through another LISN. The two LISNs provide 50 ohm/ 50uH of coupling impedance for the measuring instrument.
- Both lines of the power mains connected to the EUT were checked for maximum conducted interference.
- The frequency range from 150kHz to 30MHz was searched. Emission levels under (Limit - 20dB) was not recorded.

NOTE: All modes of operation were investigated and the worst-case emissions are reported.

4.2.4 Deviation from Test Standard

No deviation.

4.2.5 Test Setup

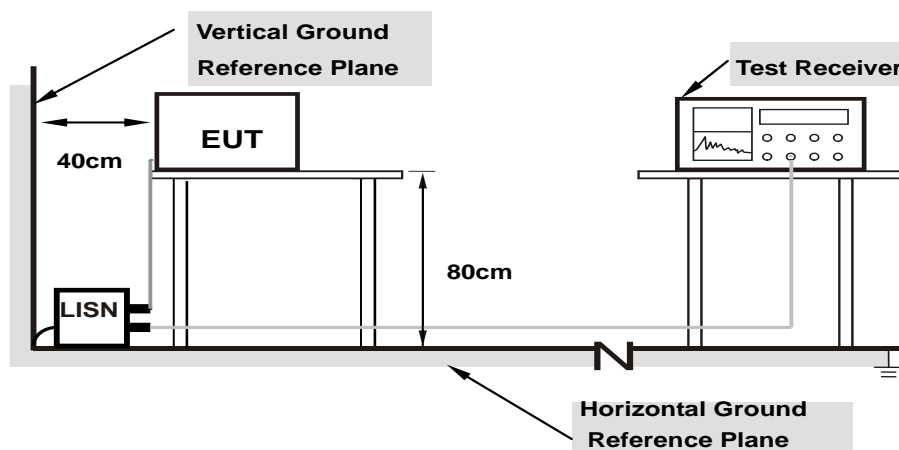

Note: 1.Support units were connected to second LISN.

For the actual test configuration, please refer to the attached file (Test Setup Photo).

4.2.6 EUT Operating Condition

Same as 4.1.6.

4.2.7 Test Results

Phase	Line (L)	Detector Function	Quasi-Peak (QP) / Average (AV)
-------	----------	-------------------	--------------------------------

Phase Of Power : Line (L)										
No	Frequency (MHz)	Correction Factor (dB)	Reading Value (dBuV)		Emission Level (dBuV)		Limit (dBuV)		Margin (dB)	
			Q.P.	AV.	Q.P.	AV.	Q.P.	AV.	Q.P.	AV.
1	0.18906	10.20	34.38	17.55	44.58	27.75	64.08	54.08	-19.50	-26.33
2	0.20859	10.20	32.51	18.51	42.71	28.71	63.26	53.26	-20.55	-24.55
3	0.34141	10.23	32.28	21.22	42.51	31.45	59.17	49.17	-16.66	-17.72
4	0.42734	10.24	23.04	10.30	33.28	20.54	57.30	47.30	-24.02	-26.76
5	0.98203	10.30	19.04	9.39	29.34	19.69	56.00	46.00	-26.66	-26.31
6	5.50000	10.42	18.27	8.82	28.69	19.24	60.00	50.00	-31.31	-30.76

Remarks:

1. Q.P. and AV. are abbreviations of quasi-peak and average individually.
2. The emission levels of other frequencies were very low against the limit.
3. Margin value = Emission level – Limit value
4. Correction factor = Insertion loss + Cable loss
5. Emission Level = Correction Factor + Reading Value

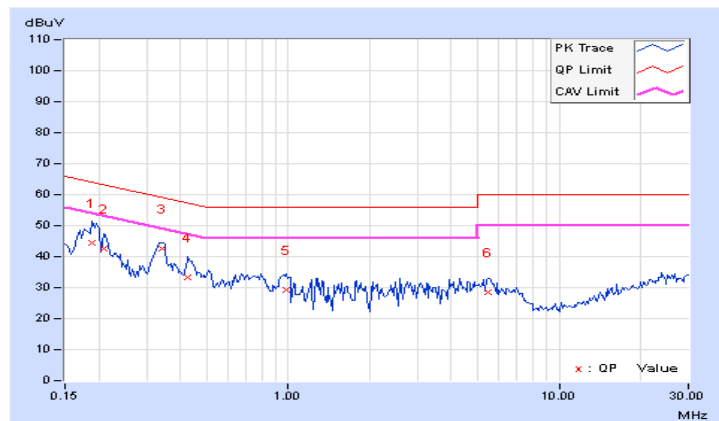

Phase	Neutral (N)	Detector Function	Quasi-Peak (QP) / Average (AV)
-------	-------------	-------------------	--------------------------------

Phase Of Power : Neutral (N)										
No	Frequency (MHz)	Correction Factor (dB)	Reading Value (dBuV)		Emission Level (dBuV)		Limit (dBuV)		Margin (dB)	
			Q.P.	AV.	Q.P.	AV.	Q.P.	AV.	Q.P.	AV.
1	0.19297	10.17	34.10	16.40	44.27	26.57	63.91	53.91	-19.64	-27.34
2	0.33359	10.22	27.58	19.95	37.80	30.17	59.36	49.36	-21.56	-19.19
3	0.43125	10.24	22.66	7.97	32.90	18.21	57.23	47.23	-24.33	-29.02
4	0.56797	10.25	13.99	0.74	24.24	10.99	56.00	46.00	-31.76	-35.01
5	5.22266	10.30	13.15	4.88	23.45	15.18	60.00	50.00	-36.55	-34.82
6	23.86719	11.39	16.44	11.38	27.83	22.77	60.00	50.00	-32.17	-27.23

Remarks:

1. Q.P. and AV. are abbreviations of quasi-peak and average individually.
2. The emission levels of other frequencies were very low against the limit.
3. Margin value = Emission level – Limit value
4. Correction factor = Insertion loss + Cable loss
5. Emission Level = Correction Factor + Reading Value

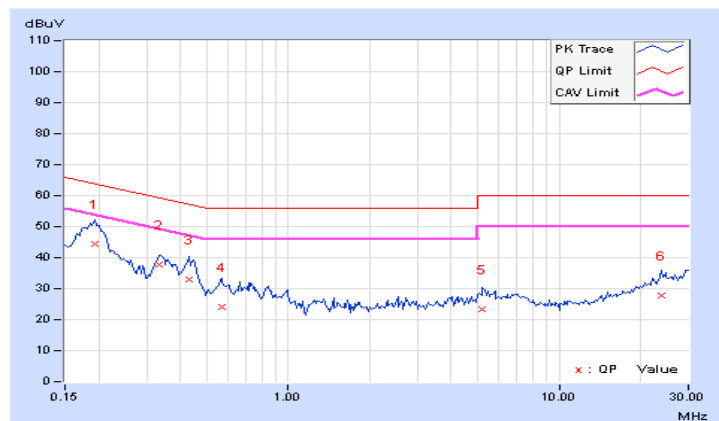

4.3 Transmit Power Measurement

4.3.1 Limits of Transmit Power Measurement

Operation Band	EUT Category		Limit
U-NII-1		Outdoor Access Point	1 Watt (30 dBm) (Max. e.i.r.p \leq 125mW(21 dBm) at any elevation angle above 30 degrees as measured from the horizon)
		Fixed point-to-point Access Point	1 Watt (30 dBm)
	√	Indoor Access Point	1 Watt (30 dBm)
		Mobile and Portable client device	250mW (24 dBm)
U-NII-2A			250mW (24 dBm) or 11 dBm+10 log B*
U-NII-2C			250mW (24 dBm) or 11 dBm+10 log B*
U-NII-3		√	1 Watt (30 dBm)

*B is the 26 dB emission bandwidth in megahertz

Per KDB 662911 Method of conducted output power measurement on IEEE 802.11 devices,

Array Gain = 0 dB (i.e., no array gain) for $N_{ANT} \leq 4$;

Array Gain = 0 dB (i.e., no array gain) for channel widths ≥ 40 MHz for any N_{ANT} ;

Array Gain = $5 \log(N_{ANT}/N_{SS})$ dB or 3 dB, whichever is less for 20-MHz channel widths with $N_{ANT} \geq 5$.

For power measurements on all other devices: Array Gain = $10 \log(N_{ANT}/N_{SS})$ dB.

4.3.2 Test Setup

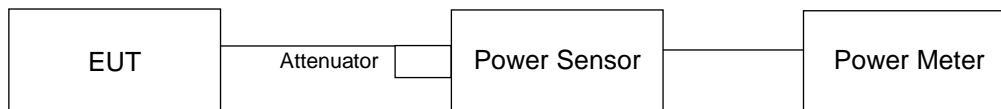

4.3.3 Test Instruments

Refer to section 4.1.2 to get information of above instrument.

4.3.4 Test Procedure

Method PM is used to perform output power measurement, trigger and gating function of wide band power meter is enabled to measure max output power of TX on burst. Duty factor is not added to measured value.

4.3.5 Deviation from Test Standard

No deviation.

4.3.6 EUT Operating Condition

The software provided by client to enable the EUT under transmission condition continuously at lowest, middle and highest channel frequencies individually.

4.3.7 Test Result

CDD Mode

802.11a

Chan.	Chan. Freq. (MHz)	Maximum Conducted Power (dBm)		Total Power (mW)	Total Power (dBm)	Limit (dBm)	Pass / Fail
		Chain 0	Chain 1				
36	5180	19.44	18.93	166.065	22.20	30.00	Pass
40	5200	21.04	20.91	250.367	23.99	30.00	Pass
48	5240	20.32	20.22	212.843	23.28	30.00	Pass
149	5745	21.27	21.11	263.09	24.20	30.00	Pass
157	5785	21.61	21.29	279.463	24.46	30.00	Pass
165	5825	21.51	21.32	277.098	24.43	30.00	Pass

802.11ac (VHT20)

Chan.	Chan. Freq. (MHz)	Maximum Conducted Power (dBm)		Total Power (mW)	Total Power (dBm)	Limit (dBm)	Pass / Fail
		Chain 0	Chain 1				
36	5180	18.64	18.06	137.087	21.37	30.00	Pass
40	5200	20.92	21.00	249.488	23.97	30.00	Pass
48	5240	20.22	20.16	208.949	23.20	30.00	Pass
149	5745	21.24	21.16	263.662	24.21	30.00	Pass
157	5785	21.56	21.24	276.264	24.41	30.00	Pass
165	5825	21.35	21.39	274.179	24.38	30.00	Pass

802.11ac (VHT40)

Chan.	Chan. Freq. (MHz)	Maximum Conducted Power (dBm)		Total Power (mW)	Total Power (dBm)	Limit (dBm)	Pass / Fail
		Chain 0	Chain 0				
38	5190	16.18	15.46	76.651	18.85	30.00	Pass
46	5230	20.57	19.14	196.06	22.92	30.00	Pass
151	5755	21.44	21.11	268.438	24.29	30.00	Pass
159	5795	21.54	21.16	273.178	24.36	30.00	Pass

802.11ac (VHT80)

Chan.	Chan. Freq. (MHz)	Maximum Conducted Power (dBm)		Total Power (mW)	Total Power (dBm)	Limit (dBm)	Pass / Fail
		Chain 0	Chain 1				
42	5210	16.45	15.17	77.042	18.87	30.00	Pass
155	5775	20.94	20.41	234.066	23.69	30.00	Pass

Beamforming Mode

802.11ac (VHT20)

Chan.	Chan. Freq. (MHz)	Maximum Conducted Power (dBm)		Total Power (mW)	Total Power (dBm)	Limit (dBm)	Pass / Fail
		Chain 0	Chain 1				
36	5180	18.64	18.06	137.087	21.37	30.00	Pass
40	5200	20.92	21.00	249.488	23.97	30.00	Pass
48	5240	20.22	20.16	208.949	23.20	30.00	Pass
149	5745	21.24	21.16	263.662	24.21	30.00	Pass
157	5785	21.56	21.24	276.264	24.41	30.00	Pass
165	5825	21.35	21.39	274.179	24.38	30.00	Pass

Note: Directional gain = 2.99 dBi + 10log(2) = 6dBi , so the power limit shall not be reduced.

802.11ac (VHT40)

Chan.	Chan. Freq. (MHz)	Maximum Conducted Power (dBm)		Total Power (mW)	Total Power (dBm)	Limit (dBm)	Pass / Fail
		Chain 0	Chain 0				
38	5190	16.18	15.46	76.651	18.85	30.00	Pass
46	5230	20.57	19.14	196.06	22.92	30.00	Pass
151	5755	21.44	21.11	268.438	24.29	30.00	Pass
159	5795	21.54	21.16	273.178	24.36	30.00	Pass

Note: Directional gain = 2.99 dBi + 10log(2) = 6dBi , so the power limit shall not be reduced.

802.11ac (VHT80)

Chan.	Chan. Freq. (MHz)	Maximum Conducted Power (dBm)		Total Power (mW)	Total Power (dBm)	Limit (dBm)	Pass / Fail
		Chain 0	Chain 1				
42	5210	16.45	15.17	77.042	18.87	30.00	Pass
155	5775	20.94	20.41	234.066	23.69	30.00	Pass

Note: Directional gain = 2.99 dBi + 10log(2) = 6dBi , so the power limit shall not be reduced.

4.4 Occupied Bandwidth Measurement

4.4.1 Test Setup



4.4.2 Test Instruments

Refer to section 4.1.2 to get information of above instrument.

4.4.3 Test Procedure

The transmitter output was connected to the spectrum analyzer through an attenuator. The bandwidth of the fundamental frequency was measured by spectrum analyzer with resolution bandwidth in the range of 1% to 5% of the anticipated emission bandwidth, and a video bandwidth at least 3x the resolution bandwidth and set the detector to SAMPLE. The width of a frequency band such that, below the lower and above the upper frequency limits, the mean powers emitted are each equal to a specified percentage 0.5 %of the total mean power of a given emission.

4.4.4 Test Results

802.11a

Channel	Channel Frequency (MHz)	Occupied Bandwidth (MHz)	
		CHAIN 0	CHAIN 1
36	5180	16.80	16.56
40	5200	24.60	17.76
48	5240	20.04	16.56
149	5745	26.64	24.48
157	5785	31.44	22.44
165	5825	31.20	22.68

802.11ac (VHT20)

Channel	Channel Frequency (MHz)	Occupied Bandwidth (MHz)	
		CHAIN 0	CHAIN 1
36	5180	17.64	17.76
40	5200	26.64	18.84
48	5240	20.76	17.64
149	5745	28.20	24.36
157	5785	33.12	22.44
165	5825	33.72	23.16

802.11ac (VHT40)

Channel	Channel Frequency (MHz)	Occupied Bandwidth (MHz)	
		CHAIN 0	CHAIN 1
38	5190	36.24	36.24
46	5230	37.20	36.48
151	5755	55.20	46.56
159	5795	64.08	43.92

802.11ac (VHT80)

Channel	Channel Frequency (MHz)	Occupied Bandwidth (MHz)	
		CHAIN 0	CHAIN 1
42	5210	76.32	76.32
155	5775	96.00	76.80

Spectrum Plot of Worst Value

802.11a_Chain0 / CH157

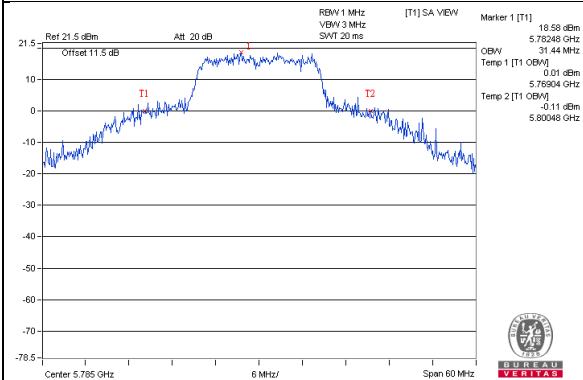

802.11ac (VHT20)_Chain0 / CH165

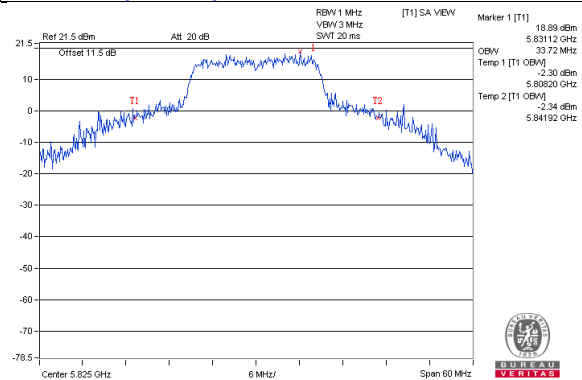

802.11ac (VHT40)_Chain0 / CH159

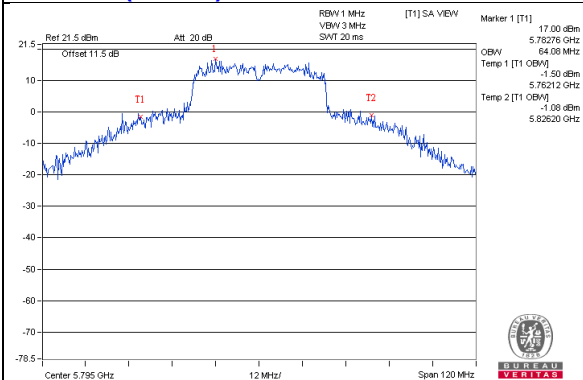

802.11ac (VHT80)_Chain0 / CH155

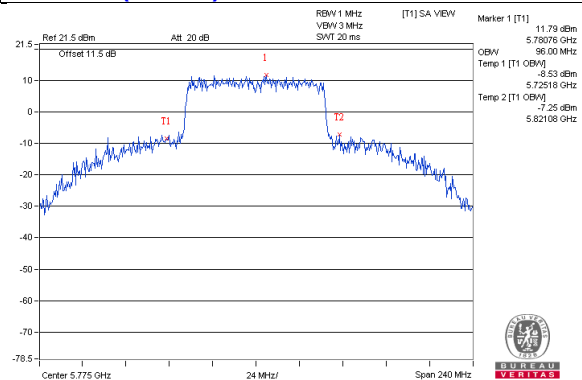

Spectrum Plot for near by DFS band (DFS is required, if 99% OCP straddle into U-NII-2A band)

802.11a_Chain0 / CH48

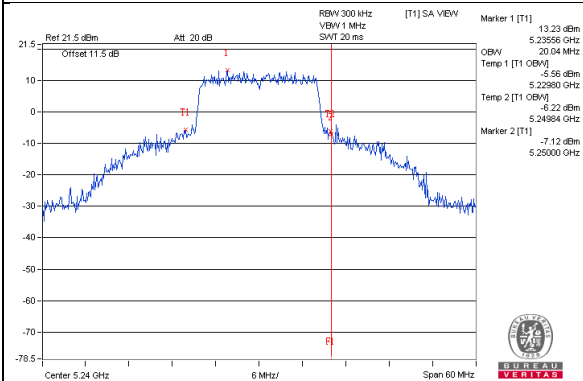

802.11a_Chain1 / CH48

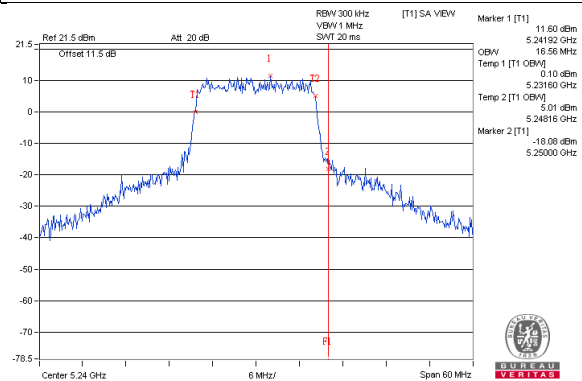

802.11ac(VHT20)_Chain0 / CH48

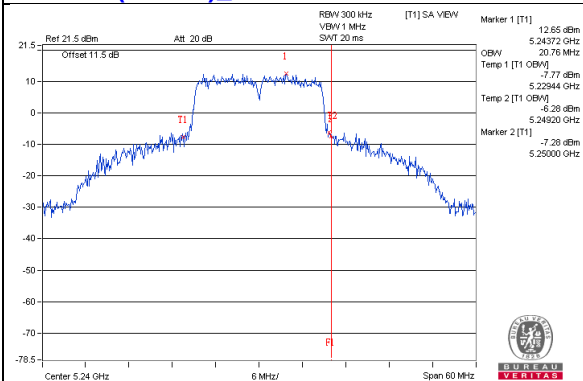

802.11ac(VHT20)_Chain1 / CH48

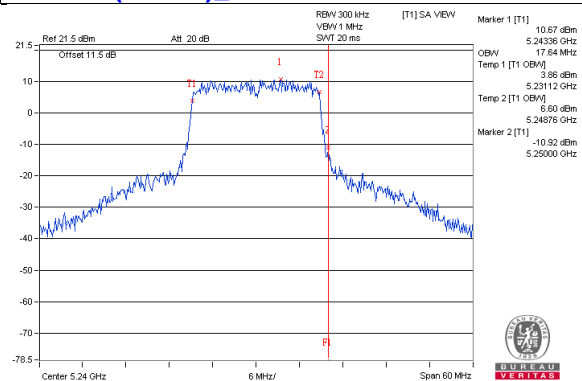

802.11ac(VHT40)_Chain0 / CH46

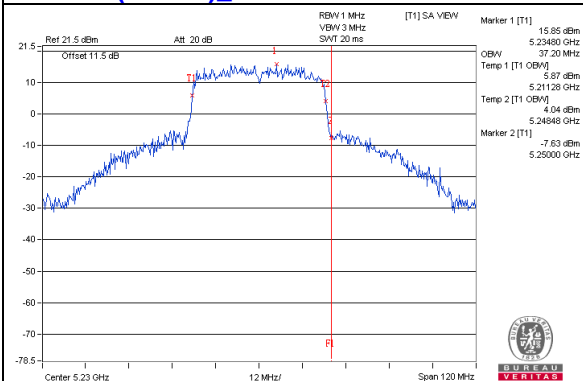

802.11ac(VHT40)_Chain1 / CH46

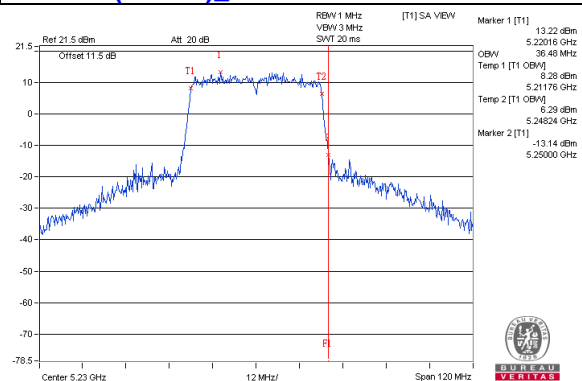

802.11ac(VHT80)_Chain0 / CH42

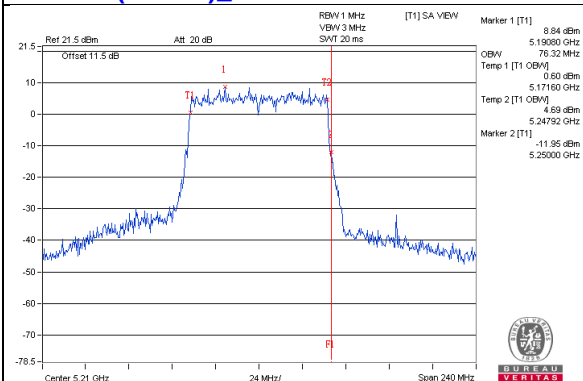

802.11ac(VHT80)_Chain1 / CH42

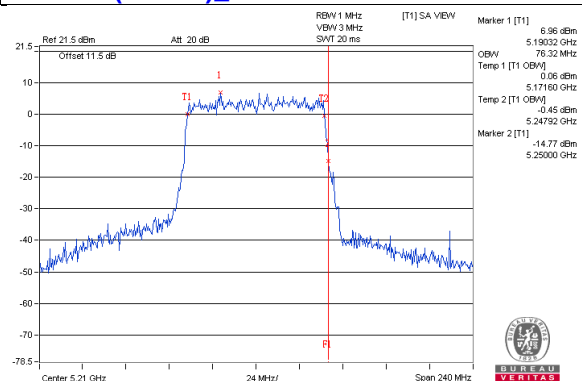

**Spectrum Plot for near by DFS band
(DFS is required, if 99% OCP straddle into U-NII-2C band)**

802.11a_Chain0 / CH149

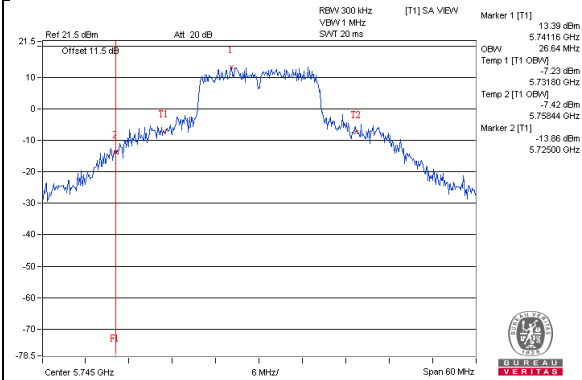

802.11a_Chain1 / CH149

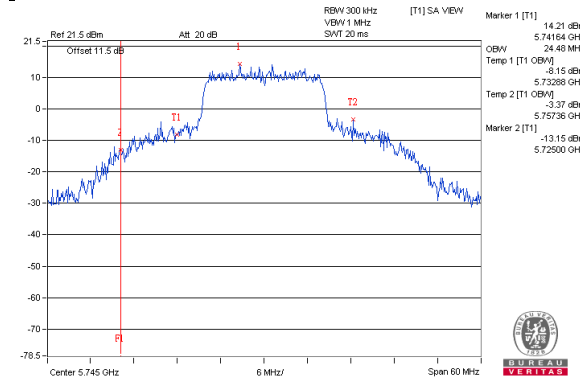

802.11ac(VHT20)_Chain0 / CH149

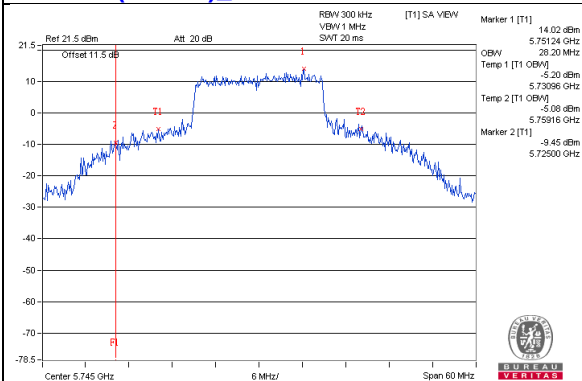

802.11ac(VHT20)_Chain1 / CH149

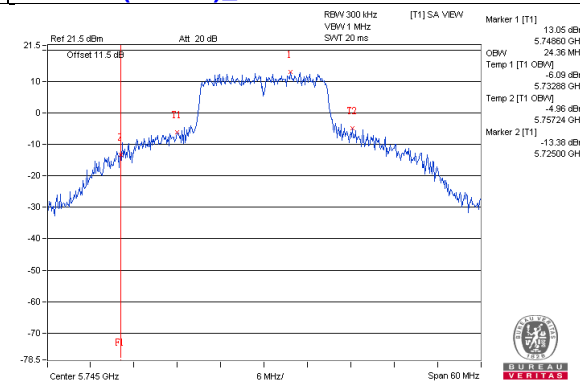

802.11ac(VHT40)_Chain0 / CH151

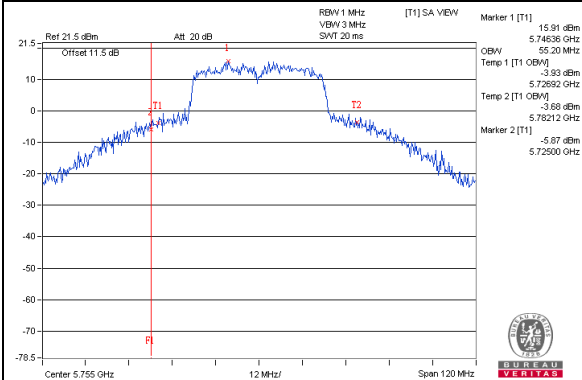

802.11ac(VHT40)_Chain1 / CH151

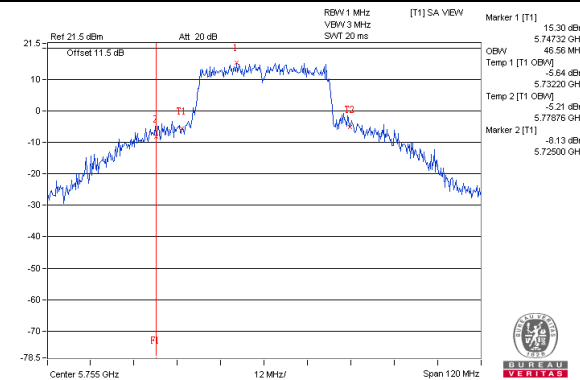

802.11ac(VHT80)_Chain0 / CH155

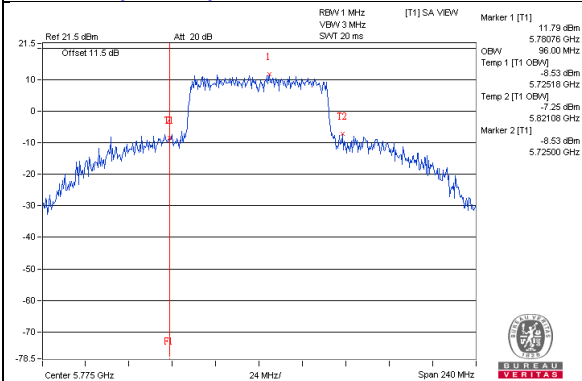

802.11ac(VHT80)_Chain1 / CH155

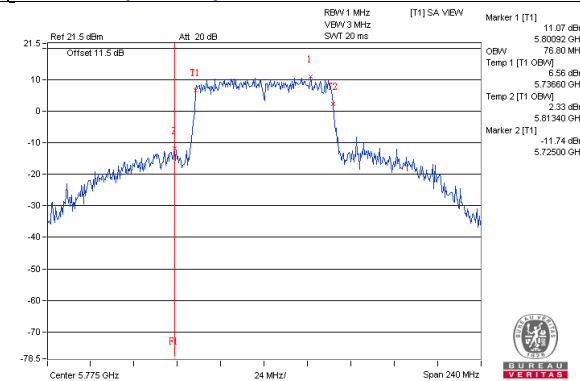

4.5 Peak Power Spectral Density Measurement

4.5.1 Limits of Peak Power Spectral Density Measurement

Operation Band	EUT Category		Limit
U-NII-1		Outdoor Access Point	17dBm/ MHz
		Fixed point-to-point Access Point	
	√	Indoor Access Point	
		Mobile and Portable client device	11dBm/ MHz
U-NII-2A			11dBm/ MHz
U-NII-2C			11dBm/ MHz
U-NII-3	√		30dBm/ 500kHz

4.5.2 Test Setup

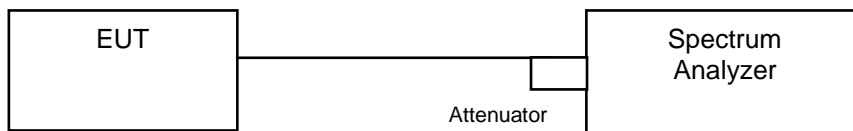

4.5.3 Test Instruments

Refer to section 4.1.2 to get information of above instrument.

4.5.4 Test Procedure

802.11ac (VHT20)

For U-NII-1:

Using method SA-1

1. Set span to encompass the entire emission bandwidth (EBW) of the signal.
2. Set RBW = 1 MHz, Set VBW \geq 3 MHz, Detector = RMS
3. Sweep time = auto, trigger set to "free run".
4. Trace average at least 100 traces in power averaging mode.
5. Record the max value

For U-NII-3:

1. Set span to encompass the entire emission bandwidth (EBW) of the signal.
2. Set RBW = 300 kHz, Set VBW \geq 1 MHz, Detector = RMS
3. Use the peak marker function to determine the maximum power level in any 300 kHz band segment within the fundamental EBW.
4. Scale the observed power level to an equivalent value in 500 kHz by adjusting (reducing) the measured power by a bandwidth correction factor (BWCF) where $BWCF = 10\log(500 \text{ kHz}/300\text{kHz})$
5. Sweep time = auto, trigger set to "free run".
6. Trace average at least 100 traces in power averaging mode.
7. Record the max value

802.11a, 802.11ac (VHT40), 802.11ac (VHT80)

For U-NII-1:

Using method SA-2

1. Set span to encompass the entire emission bandwidth (EBW) of the signal.
2. Set RBW = 1 MHz, Set VBW \geq 3 MHz, Detector = RMS
3. Sweep time = auto, trigger set to "free run".
4. Trace average at least 100 traces in power averaging mode.
5. Record the max value and add $10 \log(1/\text{duty cycle})$

For U-NII-3:

1. Set span to encompass the entire emission bandwidth (EBW) of the signal.
2. Set RBW = 300 kHz, Set VBW \geq 1 MHz, Detector = RMS
3. Use the peak marker function to determine the maximum power level in any 300 kHz band segment within the fundamental EBW.
4. Scale the observed power level to an equivalent value in 500 kHz by adjusting (reducing) the measured power by a bandwidth correction factor (BWCF) where $BWCF = 10\log(500 \text{ kHz}/300\text{kHz})$
5. Sweep time = auto, trigger set to "free run".
6. Trace average at least 100 traces in power averaging mode.
7. Record the max value and add $10 \log(1/\text{duty cycle})$

4.5.5 Deviation from Test Standard

No deviation.

4.5.6 EUT Operating Condition

Same as Item 4.3.6.

4.5.7 Test Results

For U-NII-1:

802.11a

Chan.	Chan. Freq. (MHz)	PSD W/O Duty Factor (dBm/MHz)		Duty Factor (dB)	Total PSD With Duty Factor (dBm/MHz)	MAX. EIRP Limit (dBm/MHz)	Pass / Fail
		Chain 0	Chain 1				
36	5180	6.13	5.68	0.15	9.07	17.00	Pass
40	5200	8.95	7.79	0.15	11.57	17.00	Pass
48	5240	8.43	6.27	0.15	10.64	17.00	Pass

- Note:**
- Method a) of power density measurement of KDB 662911 is using for calculating total power density. Total power density is summing entire spectra across corresponding frequency bins on the various outputs by computer.
 - Directional gain = $2.99\text{dBi} + 10\log(2) = 6\text{dBi}$, so the power density limit shall not be reduced.
 - Refer to section 3.3 for duty cycle spectrum plot.

802.11ac (VHT20)

Chan.	Chan. Freq. (MHz)	PSD (dBm/MHz)		Total Power Density (dBm/MHz)	MAX. Limit (dBm/MHz)	Pass / Fail
		Chain 0	Chain 1			
36	5180	5.96	5.18	8.60	17.00	Pass
40	5200	9.11	7.86	11.54	17.00	Pass
48	5240	8.57	6.57	10.69	17.00	Pass

- Note:**
- Method a) of power density measurement of KDB 662911 is using for calculating total power density. Total power density is summing entire spectra across corresponding frequency bins on the various outputs by computer.
 - Directional gain = $2.99\text{dBi} + 10\log(2) = 6\text{dBi}$, so the power density limit shall not be reduced.

802.11ac (VHT40)

Chan.	Chan. Freq. (MHz)	PSD W/O Duty Factor (dBm/MHz)		Duty Factor (dB)	Total PSD With Duty Factor (dBm/MHz)	MAX. EIRP Limit (dBm/MHz)	Pass / Fail
		Chain 0	Chain 1				
38	5190	0.95	-0.11	0.14	3.60	17.00	Pass
46	5230	5.96	3.69	0.14	8.12	17.00	Pass

- Note:**
- Method a) of power density measurement of KDB 662911 is using for calculating total power density. Total power density is summing entire spectra across corresponding frequency bins on the various outputs by computer.
 - Directional gain = $2.99\text{dBi} + 10\log(2) = 6\text{dBi}$, so the power density limit shall not be reduced.
 - Refer to section 3.3 for duty cycle spectrum plot.

802.11ac (VHT80)

Chan.	Chan. Freq. (MHz)	PSD W/O Duty Factor (dBm/MHz)		Duty Factor (dB)	Total PSD With Duty Factor (dBm/MHz)	MAX. Limit (dBm/MHz)	Pass / Fail
		Chain 0	Chain 1				
42	5210	-1.82	-5.10	0.30	0.15	17.00	Pass

- Note:**
- Method a) of power density measurement of KDB 662911 is using for calculating total power density. Total power density is summing entire spectra across corresponding frequency bins on the various outputs by computer.
 - Directional gain = $2.99\text{dBi} + 10\log(2) = 6\text{dBi}$, so the power density limit shall not be reduced.
 - Refer to section 3.3 for duty cycle spectrum plot.

Spectrum Plot of Worst Value

802.11a_Chain 0 / CH40

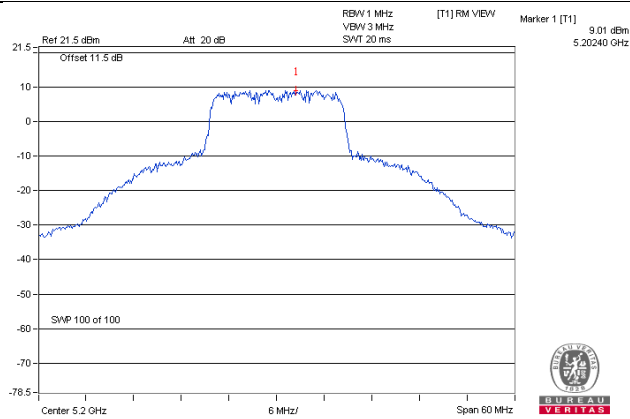

802.11ac (VHT20)_Chain 0 / CH40

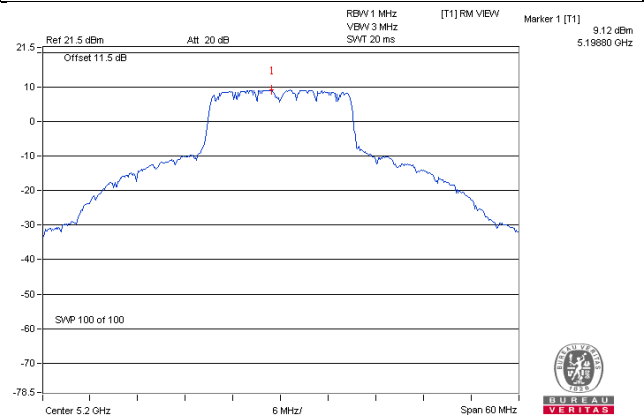

802.11ac (VHT40)_Chain 0 / CH46

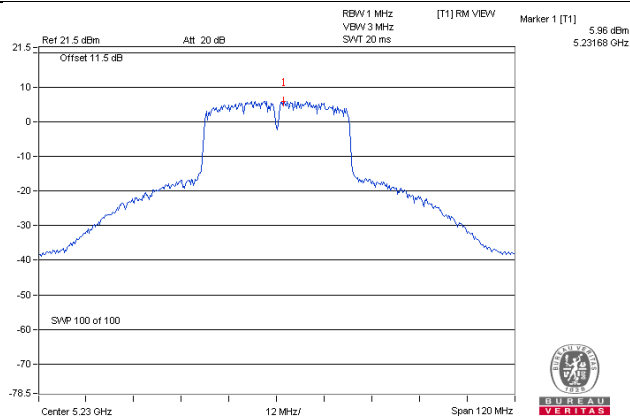

802.11ac (VHT80)_Chain 0 / CH42

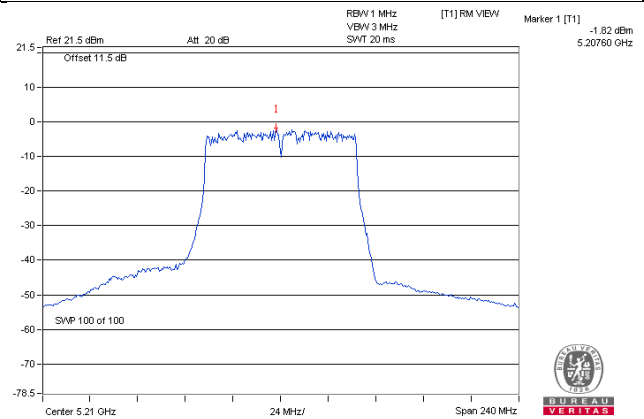

For U-NII-3:
802.11a

TX chain	Chan.	Chan. Freq. (MHz)	PSD W/O Duty Factor		10 log (N=2) dB	Duty Factor (dB)	Total PSD With Duty Factor (dBm/500kHz)	Limit (dBm/500kHz)	Pass /Fail
			(dBm/300kHz)	(dBm/500kHz)					
0	149	5745	0.66	2.88	3.01	0.15	6.04	30.00	Pass
	157	5785	0.91	3.13	3.01	0.15	6.29	30.00	Pass
	165	5825	0.70	2.92	3.01	0.15	6.08	30.00	Pass
1	149	5745	0.71	2.93	3.01	0.15	6.09	30.00	Pass
	157	5785	0.34	2.56	3.01	0.15	5.72	30.00	Pass
	165	5825	0.41	2.63	3.01	0.15	5.79	30.00	Pass

Note:

1. Directional gain = 2.99dBi + 10log(2) = 6dBi , so the power density limit shall not be reduced.
2. Refer to section 3.3 for duty cycle spectrum plot.

802.11ac (VHT20)

TX chain	Channel	Freq. (MHz)	PSD (dBm/300kHz)	PSD (dBm/500kHz)	10 log (N=3) dB	Total PSD (dBm/500kHz)	Limit (dBm/500kHz)	Pass /Fail
0	149	5745	0.85	3.07	3.01	6.08	30.00	Pass
	157	5785	0.61	2.83	3.01	5.84	30.00	Pass
	165	5825	0.97	3.19	3.01	6.20	30.00	Pass
1	149	5745	0.54	2.76	3.01	5.77	30.00	Pass
	157	5785	0.55	2.77	3.01	5.78	30.00	Pass
	165	5825	0.49	2.71	3.01	5.72	30.00	Pass

Note:

1. Directional gain = 2.99dBi + 10log(2) = 6dBi , so the power density limit shall not be reduced.

802.11ac (VHT40)

TX chain	Chan.	Chan. Freq. (MHz)	PSD W/O Duty Factor		10 log (N=2) dB	Duty Factor (dB)	Total PSD With Duty Factor (dBm/500kHz)	Limit (dBm/500kHz)	Pass /Fail
			(dBm/300kHz)	(dBm/500kHz)					
0	151	5755	-2.32	-0.10	3.01	0.14	3.05	30.00	Pass
	159	5795	-2.38	-0.16	3.01	0.14	2.99	30.00	Pass
1	151	5755	-2.77	-0.55	3.01	0.14	2.60	30.00	Pass
	159	5795	-2.85	-0.63	3.01	0.14	2.52	30.00	Pass

Note: 1. Directional gain = $2.99\text{dBi} + 10\log(2) = 6\text{dBi}$, so the power density limit shall not be reduced.
 2. Refer to section 3.3 for duty cycle spectrum plot.

802.11ac (VHT80)

TX chain	Chan.	Chan. Freq. (MHz)	PSD W/O Duty Factor		10 log (N=2) dB	Duty Factor (dB)	Total PSD With Duty Factor (dBm/500kHz)	Limit (dBm/500kHz)	Pass /Fail
			(dBm/300kHz)	(dBm/500kHz)					
0	155	5775	-5.91	-3.69	3.01	0.30	-0.38	30.00	Pass
1	155	5775	-6.89	-4.67	3.01	0.30	-1.36	30.00	Pass

Note: 1. Directional gain = $2.99\text{dBi} + 10\log(2) = 6\text{dBi}$, so the power density limit shall not be reduced.
 2. Refer to section 3.3 for duty cycle spectrum plot.

Spectrum Plot of Worst Value

802.11a – Chain 0: CH 157

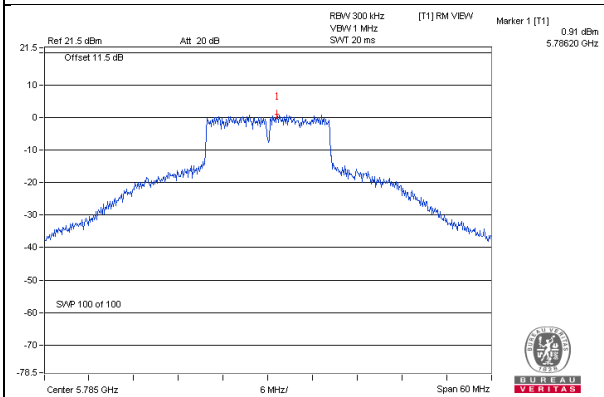

802.11ac (VHT20) – Chain 0: CH 165

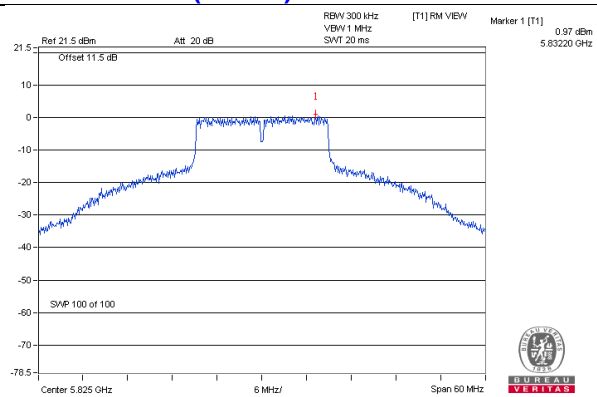

802.11ac (VHT40) – Chain 0: CH 151

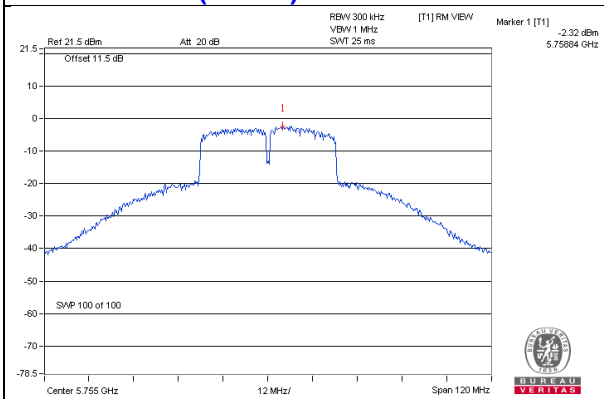

802.11ac (VHT80) – Chain 0: CH 155

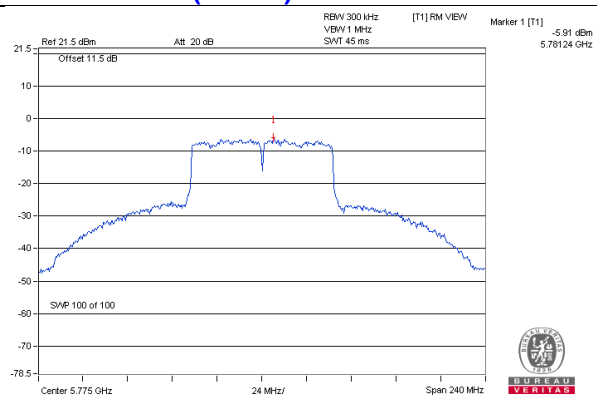

4.6 Frequency Stability Measurement

4.6.1 Limits of Frequency Stability Measurement

The frequency of the carrier signal shall be maintained within band of operation

4.6.2 Test Setup

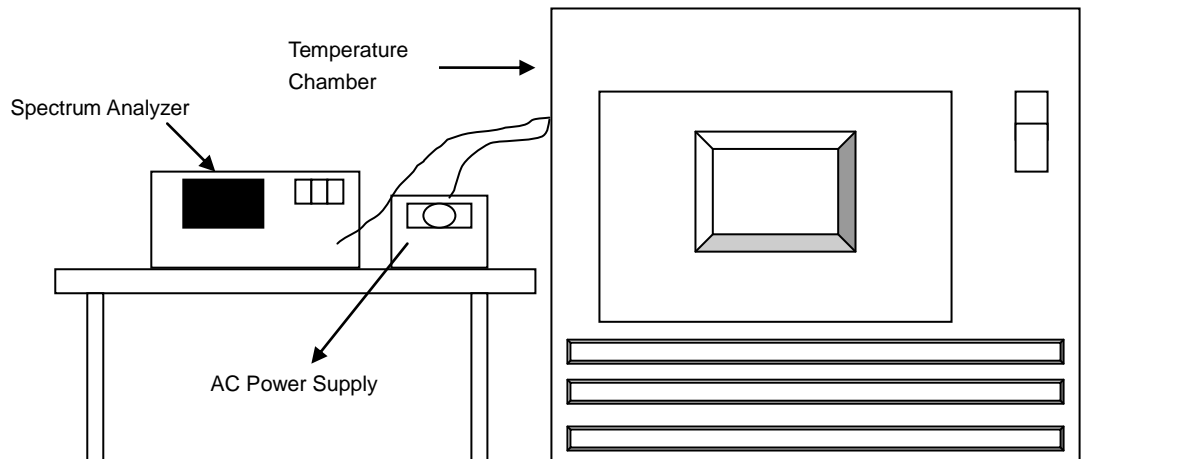

4.6.3 Test Instruments

Refer to section 4.1.2 to get information of above instrument.

4.6.4 Test Procedure

- The EUT was placed inside the environmental test chamber and powered by nominal AC voltage.
- Turn the EUT on and couple its output to a spectrum analyzer.
- Turn the EUT off and set the chamber to the highest temperature specified.
- Allow sufficient time (approximately 30 min) for the temperature of the chamber to stabilize, turn the EUT on and measure the operating frequency after 2, 5, and 10 Minutes.
- Repeat step 2 and 3 with the temperature chamber set to the lowest temperature.
- The test chamber was allowed to stabilize at +20 degree C for a minimum of 30 Minutes. The supply voltage was then adjusted on the EUT from 85% to 115% and the frequency record.

4.6.5 Deviation from Test Standard

No deviation.

4.6.6 EUT Operating Condition

Set the EUT transmit at un-modulation mode to test frequency stability.

4.6.7 Test Results

Frequency Stability Versus Temp.									
Operating Frequency: 5180 MHz									
TEMP. (°C)	Power Supply (Vac)	0 Minute		2 Minute		5 Minute		10 Minute	
		Measured Frequency (MHz)	Pass/Fail	Measured Frequency (MHz)	Pass/Fail	Measured Frequency (MHz)	Pass/Fail	Measured Frequency (MHz)	Pass/Fail
50	120	5179.9765	Pass	5179.9737	Pass	5179.9759	Pass	5179.9764	Pass
40	120	5179.9875	Pass	5179.9891	Pass	5179.9868	Pass	5179.9858	Pass
30	120	5180.0014	Pass	5180.0033	Pass	5180.0013	Pass	5180.0024	Pass
20	120	5180.0202	Pass	5180.0173	Pass	5180.0163	Pass	5180.0194	Pass
10	120	5179.9988	Pass	5180.0032	Pass	5180.0019	Pass	5179.999	Pass
0	120	5180.0142	Pass	5180.014	Pass	5180.014	Pass	5180.0154	Pass
-10	120	5179.9819	Pass	5179.9857	Pass	5179.9852	Pass	5179.9857	Pass
-20	120	5180.0083	Pass	5180.0113	Pass	5180.0115	Pass	5180.011	Pass
-30	120	5180.0101	Pass	5180.0057	Pass	5180.0102	Pass	5180.006	Pass

Frequency Stability Versus Voltage									
Operating Frequency: 5180 MHz									
TEMP. (°C)	Power Supply (Vac)	0 Minute		2 Minute		5 Minute		10 Minute	
		Measured Frequency (MHz)	Pass/Fail	Measured Frequency (MHz)	Pass/Fail	Measured Frequency (MHz)	Pass/Fail	Measured Frequency (MHz)	Pass/Fail
20	138	5180.0196	Pass	5180.0179	Pass	5180.0157	Pass	5180.0185	Pass
	120	5180.0202	Pass	5180.0173	Pass	5180.0163	Pass	5180.0194	Pass
	102	5180.0197	Pass	5180.0182	Pass	5180.0166	Pass	5180.0186	Pass

4.7 6dB Bandwidth Measurement

4.7.1 Limits of 6dB Bandwidth Measurement

The minimum of 6dB Bandwidth Measurement is 0.5MHz.

4.7.2 Test Setup

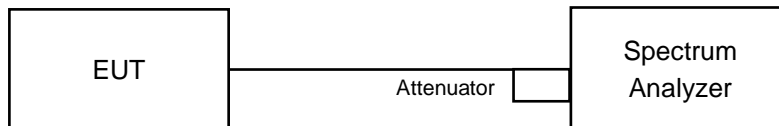

4.7.3 Test Instruments

Refer to section 4.1.2 to get information of above instrument.

4.7.4 Test Procedure

MEASUREMENT PROCEDURE REF

- Set resolution bandwidth (RBW) = 100kHz
- Set the video bandwidth (VBW) $\geq 3 \times$ RBW, Detector = Peak.
- Trace mode = max hold.
- Sweep = auto couple.
- Measure the maximum width of the emission that is constrained by the frequencies associated with the two amplitude points (upper and lower) that are attenuated by 6 dB relative to the maximum level measured in the fundamental emission

4.7.5 Deviation from Test Standard

No deviation.

4.7.6 EUT Operating Condition

The software provided by client to enable the EUT under transmission condition continuously at lowest, middle and highest channel frequencies individually.

4.7.7 Test Results

802.11a

Channel	Frequency (MHz)	6dB Bandwidth (MHz)		Minimum Limit (MHz)	Pass / Fail
		Chain 0	Chain 1		
149	5745	16.33	16.34	0.5	PASS
157	5785	16.37	16.32	0.5	PASS
165	5825	16.38	16.35	0.5	PASS

802.11ac (VHT20)

Channel	Frequency (MHz)	6dB Bandwidth (MHz)		Minimum Limit (MHz)	Pass / Fail
		Chain 0	Chain 1		
149	5745	17.62	17.59	0.5	PASS
157	5785	17.65	17.63	0.5	PASS
165	5825	17.63	17.21	0.5	PASS

802.11ac (VHT40)

Channel	Frequency (MHz)	6dB Bandwidth (MHz)		Minimum Limit (MHz)	Pass / Fail
		Chain 0	Chain 1		
151	5755	35.13	35.07	0.5	PASS
159	5795	34.41	35.20	0.5	PASS

802.11ac (VHT80)

Channel	Frequency (MHz)	6dB Bandwidth (MHz)		Minimum Limit (MHz)	Pass / Fail
		Chain 0	Chain 1		
155	5775	74.33	75.51	0.5	PASS

Spectrum Plot of Worst Value

802.11a_Chain 1 / CH157

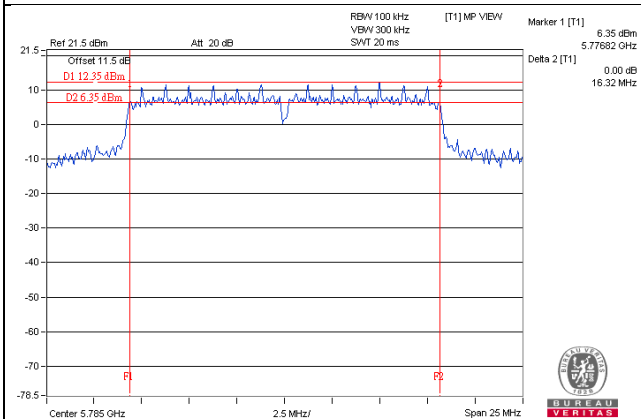

802.11ac (VHT20)_Chain 1 / CH155

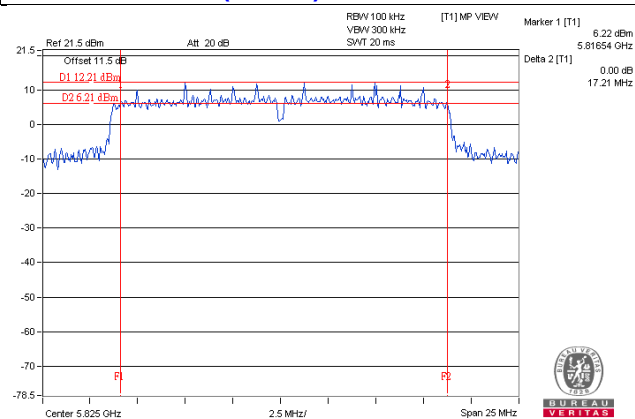

802.11ac (VHT40)_Chain 0 / CH159

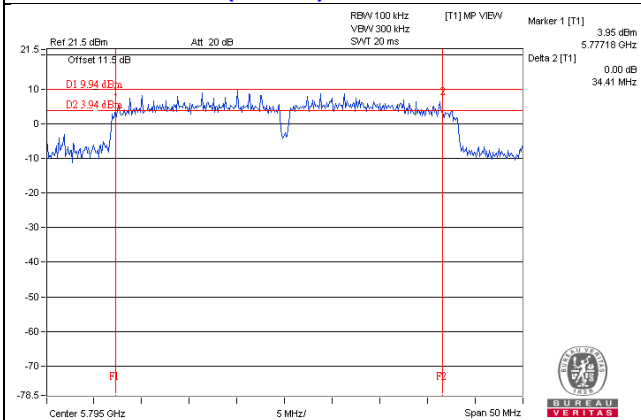

802.11ac (VHT80)_Chain 0 / CH155

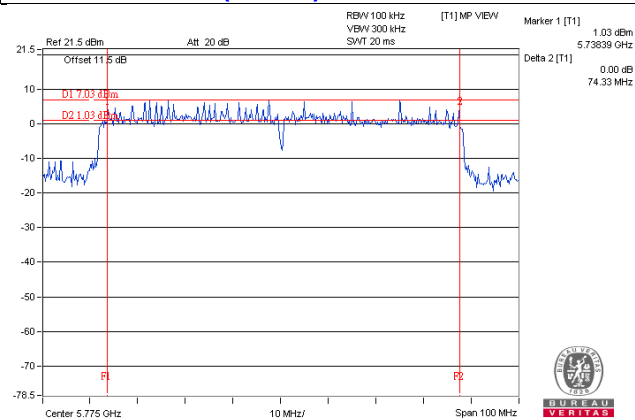

5 Pictures of Test Arrangements

Please refer to the attached file (Test Setup Photo).

Annex A- Radiated Out of Band Emission (OOBE) Measurement (For U-NII-3 band)

802.11a

CH 149 5745 MHz

Horizontal

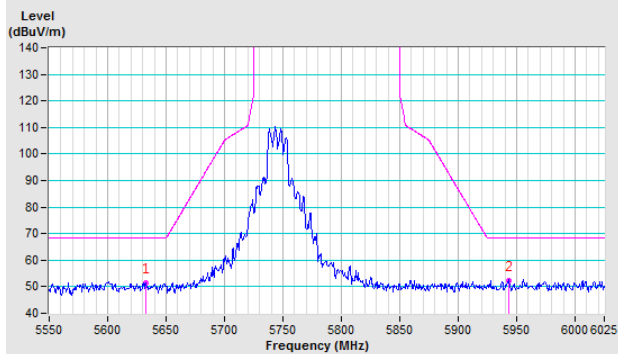

Vertical

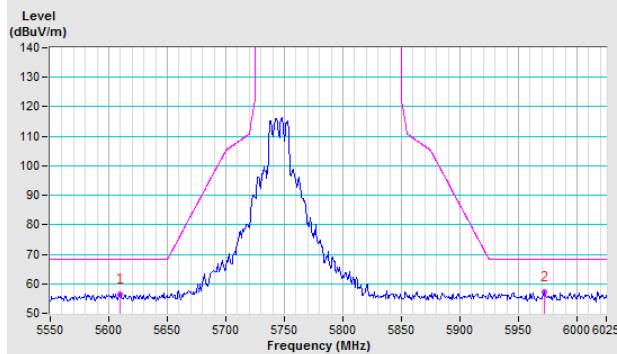

CH 157 5785 MHz

Horizontal

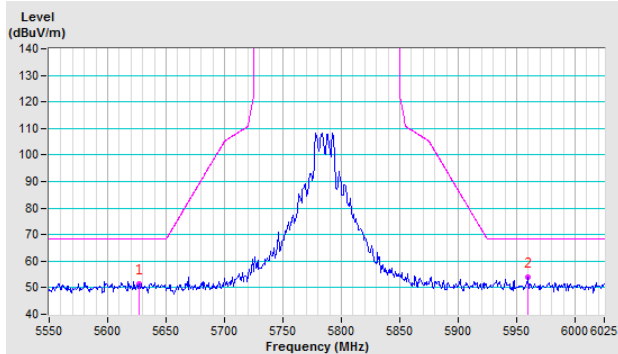

Vertical

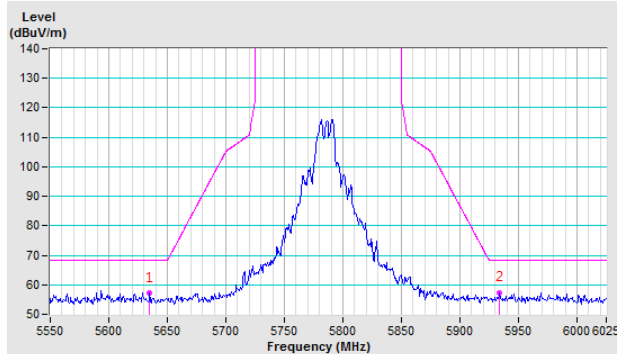

CH 165 5825 MHz

Horizontal

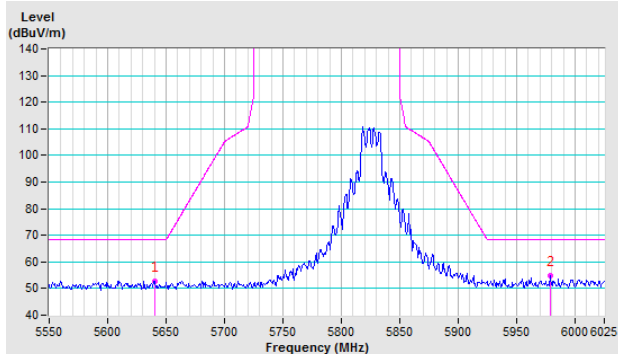

Vertical

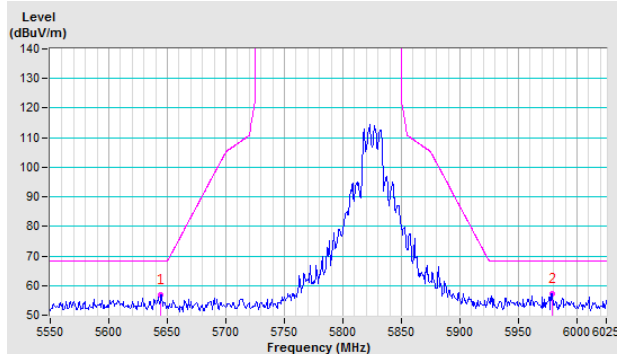

802.11ac (VHT20)

CH 149 5745 MHz

Horizontal

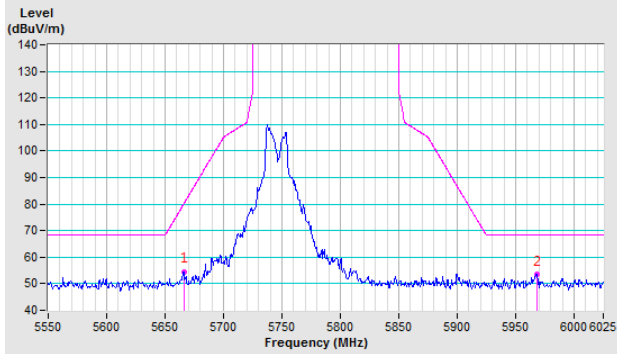

Vertical

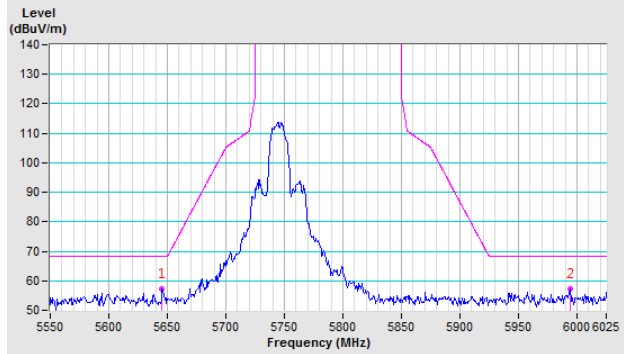

CH 157 5785 MHz

Horizontal

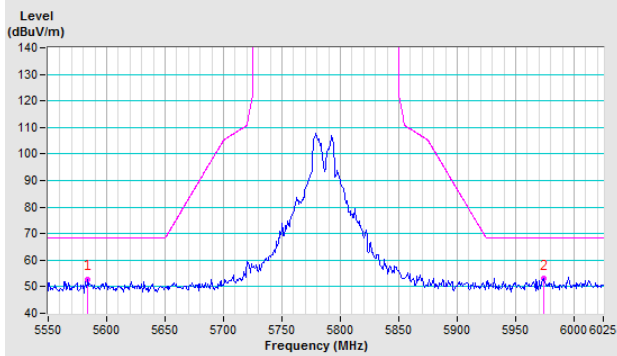

Vertical

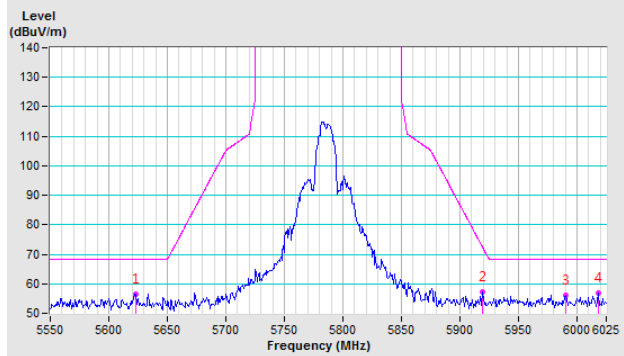

CH 165 5825 MHz

Horizontal

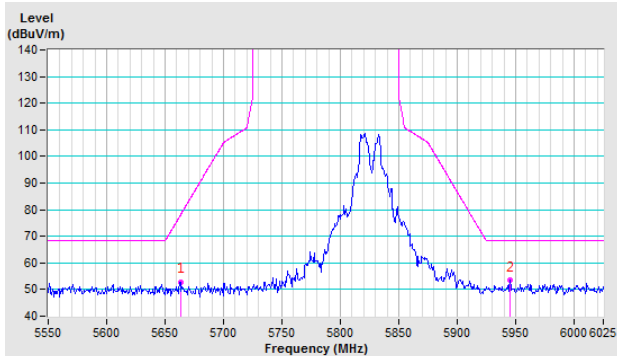

Vertical

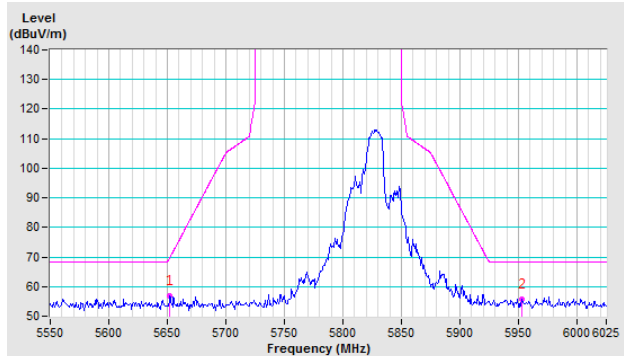

802.11ac (VHT40)

CH 151 5755 MHz

Horizontal

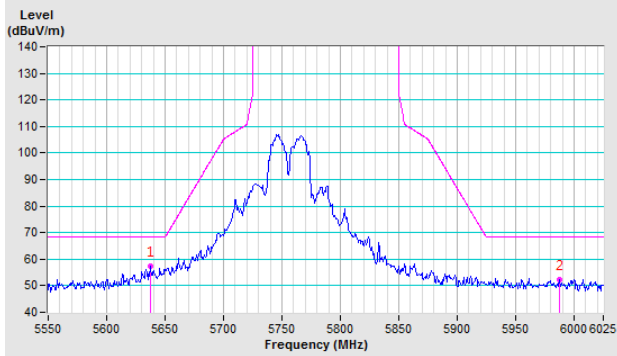

Vertical

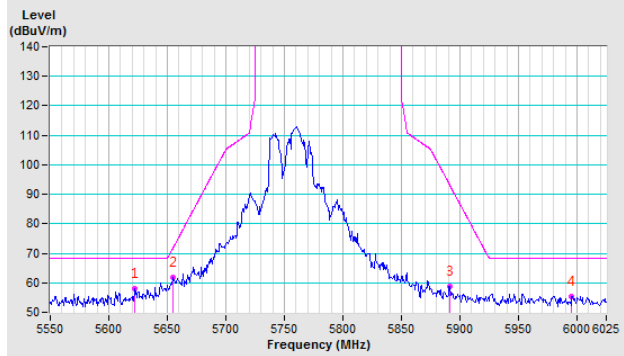

CH 159 5795 MHz

Horizontal

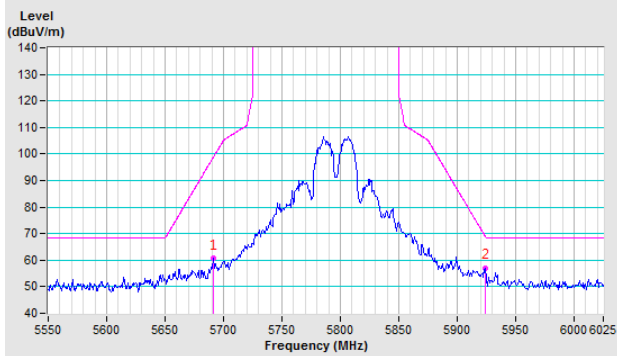

Vertical

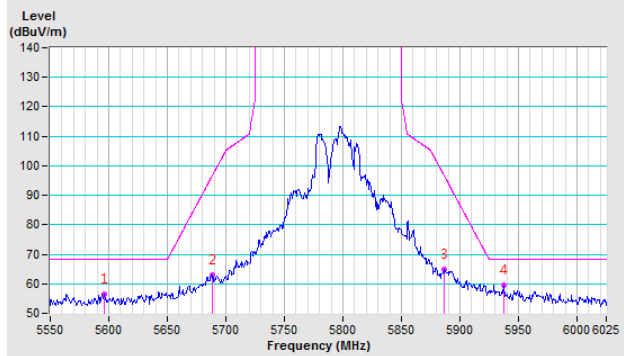

802.11ac (VHT80)

CH 155 5775 MHz

Horizontal

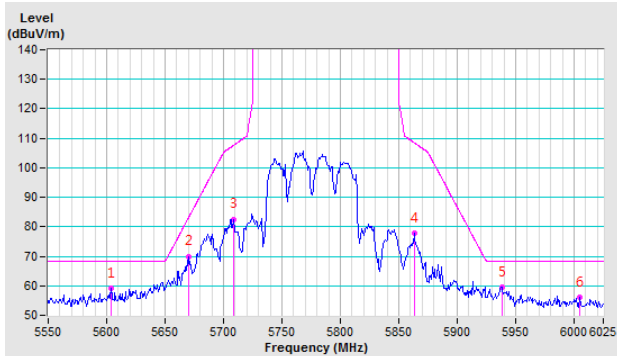

Vertical

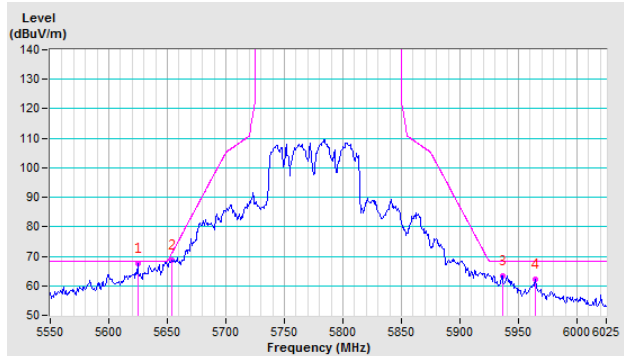

Appendix – Information on the Testing Laboratories

We, Bureau Veritas Consumer Products Services (H.K.) Ltd., Taoyuan Branch, were founded in 1988 to provide our best service in EMC, Radio, Telecom and Safety consultation. Our laboratories are accredited and approved according to ISO/IEC 17025.

If you have any comments, please feel free to contact us at the following:

Linko EMC/RF Lab

Tel: 886-2-26052180

Fax: 886-2-26051924

Hsin Chu EMC/RF/Telecom Lab

Tel: 886-3-6668565

Fax: 886-3-6668323

Hwa Ya EMC/RF/Safety Lab

Tel: 886-3-3183232

Fax: 886-3-3270892

Email: service.adt@tw.bureauveritas.com

Web Site: www.bureauveritas-adt.com

The address and road map of all our labs can be found in our web site also.

--- END ---