



# SPORTON International Inc.

No. 52, Hwa Ya 1st Rd., Kwei-Shan Hsiang, TaoYuan Hsien, Taiwan, R.O.C.  
Ph: 886-3-327-3456 / FAX: 886-3-327-0973 / www.sporton.com.tw

## FCC RADIO TEST REPORT

Applicant's company	Belkin International, Inc.
Applicant Address	501 West Walnut Street, Compton, CA 90220-5221, U.S.A.
FCC ID	K7SF5D8053
Manufacturer's company	Arcadyan Technology Corporation
Manufacturer Address	4F, No.9, Park Avenue II, Science-based Industrial Park, Hsinchu 300, Taiwan, R.O.C.

Product Name	N Wireless USB Adapter
Brand Name	Belkin
Model Name	F5D8053
Test Rule	47 CFR FCC Part 15 Subpart C § 15.247
Test Freq. Range	2400 ~ 2483.5MHz
Received Date	Apr. 9, 2007
Final Test Date	May 16, 2007
Submission Type	Original Equipment



### Statement

**Test result included is only for the 802.11b/g part of the product.**

The test result in this report refers exclusively to the presented test model / sample.

Without written approval of SPORTON International Inc., the test report shall not be reproduced except in full.

The measurements and test results shown in this test report were made in accordance with the procedures and found in compliance with the limit given in **ANSI C63.4-2003** and **47 CFR FCC Part 15 Subpart C**.

The test equipment used to perform the test is calibrated and traceable to NML/ROC.



## Table of Contents

<b>1. CERTIFICATE OF COMPLIANCE .....</b>	<b>1</b>
<b>2. SUMMARY OF THE TEST RESULT .....</b>	<b>2</b>
<b>3. GENERAL INFORMATION .....</b>	<b>3</b>
3.1. Product Details.....	3
3.2. Accessories.....	3
3.3. Table for Filed Antenna.....	4
3.4. Table for Carrier Frequencies .....	4
3.5. Table for Test Modes .....	5
3.6. Table for Testing Locations.....	6
3.7. Table for Supporting Units .....	6
3.8. Table for Parameters of Test Software Setting .....	7
3.9. Test Configurations .....	8
<b>4. TEST RESULT .....</b>	<b>11</b>
4.1. AC Power Line Conducted Emissions Measurement.....	11
4.2. Maximum Peak Output Power Measurement .....	15
4.3. Power Spectral Density Measurement .....	17
4.4. 6dB Spectrum Bandwidth Measurement .....	22
4.5. Radiated Emissions Measurement .....	27
4.6. Band Edge Emissions Measurement .....	45
4.7. Antenna Requirements .....	52
<b>5. LIST OF MEASURING EQUIPMENTS .....</b>	<b>53</b>
<b>6. TEST LOCATION.....</b>	<b>55</b>
<b>7. TAF CERTIFICATE OF ACCREDITATION .....</b>	<b>56</b>
<b>APPENDIX A. PHOTOGRAPHS OF EUT.....</b>	<b>A1 ~ A8</b>
<b>APPENDIX B. TEST PHOTOS.....</b>	<b>B1 ~ B5</b>





## 1. CERTIFICATE OF COMPLIANCE

Product Name : N Wireless USB Adapter  
Brand Name : Belkin  
Model Name : F5D8053  
Applicant : Belkin International, Inc.  
Test Rule Part(s) : 47 CFR FCC Part 15 Subpart C § 15.247

Sporton International as requested by the applicant to evaluate the EMC performance of the product sample received on Apr. 9, 2007 would like to declare that the tested sample has been evaluated and found to be in compliance with the tested rule parts. The data recorded as well as the test configuration specified is true and accurate for showing the sample's EMC nature.

A handwritten signature in blue ink that reads 'Wayne Hsu 22.5.07'.

Wayne Hsu

SPORTON INTERNATIONAL INC.

## 2. SUMMARY OF THE TEST RESULT

Applied Standard: 47 CFR FCC Part 15 Subpart C				
Part	Rule Section	Description of Test	Result	Under Limit
4.1	15.207	AC Power Line Conducted Emissions	Complies	5.17 dB
4.2	15.247(b)(3)	Maximum Peak Conducted Output Power	Complies	10.12 dB
4.3	15.247(e)	Power Spectral Density	Complies	18.33 dB
4.4	15.247(a)(2)	6dB Spectrum Bandwidth	Complies	-
4.5	15.247(d)	Radiated Emissions	Complies	0.42 dB
4.6	15.247(d)	Band Edge Emissions	Complies	0.03 dB
4.7	15.203	Antenna Requirements	Complies	-

Test Items	Uncertainty	Remark
AC Power Line Conducted Emissions	±2.3dB	Confidence levels of 95%
Maximum Peak Conducted Output Power	±0.8dB	Confidence levels of 95%
Power Spectral Density	±0.5dB	Confidence levels of 95%
6dB Spectrum Bandwidth	±8.5×10 <sup>-8</sup>	Confidence levels of 95%
Radiated Emissions (9kHz~30MHz)	±0.8dB	Confidence levels of 95%
Radiated Emissions (30MHz~1000MHz)	±1.9dB	Confidence levels of 95%
Radiated / Band Edge Emissions (1GHz~18GHz)	±1.9dB	Confidence levels of 95%
Radiated Emissions (18GHz~40GHz)	±1.9dB	Confidence levels of 95%
Temperature	±0.7°C	Confidence levels of 95%
Humidity	±3.2%	Confidence levels of 95%
DC / AC Power Source	±1.4%	Confidence levels of 95%

### 3. GENERAL INFORMATION

#### 3.1. Product Details

Items	Description
Product Type	WLAN
Radio Type	Intentional Transceiver
Power Type	From Host system
Modulation	DSSS for IEEE 802.11b ; OFDM for IEEE 802.11g
Data Modulation	DSSS (BPSK / QPSK / CCK) ; OFDM (BPSK / QPSK / 16QAM / 64QAM)
Data Rate (Mbps)	DSSS (1/ 2/ 5.5/11) ; OFDM (6/9/12/18/24/36/48/54)
Frequency Range	2400 ~ 2483.5MHz
Channel Number	11
Channel Band Width (99%)	11b : 14.93 MHz, 11g : 16.47 MHz
Conducted Output Power	11b : 17.65 dBm, 11g : 19.48 dBm
Carrier Frequencies	Please refer to section 3.4
Antenna	Please refer to section 3.3

#### Antenna & Band width

Antenna	Single (TX)		Two (TX)	
	20 MHz	40 MHz	20 MHz	40 MHz
Band width Mode				
802.11b	V	X	X	X
802.11g	V	X	X	X
Draft n	X	X	V	V

#### 3.2. Accessories

USB Cable	Cable Lenth
1	1.43m, Shielded

### 3.3. Table for Filed Antenna

Ant.	Brand	Model Name	Antenna Type	Connector	Gain (dBi)	Remark
A	ACX	AT7020-B2R4HAA	Chip Antenna	NA	2.00	TX ant. / RX ant.
B	ACX	AT7020-B2R4HAA	Chip Antenna	NA	2.00	RX ant.

The EUT has two antennas.

Antenna A is used as the transmitting antenna.

Both antenna A and B can be used as receiving antenna.

Note: Ant. A is same with Ant. 0 in the SAR report.

Ant. B is same with Ant. 1 in the SAR report.

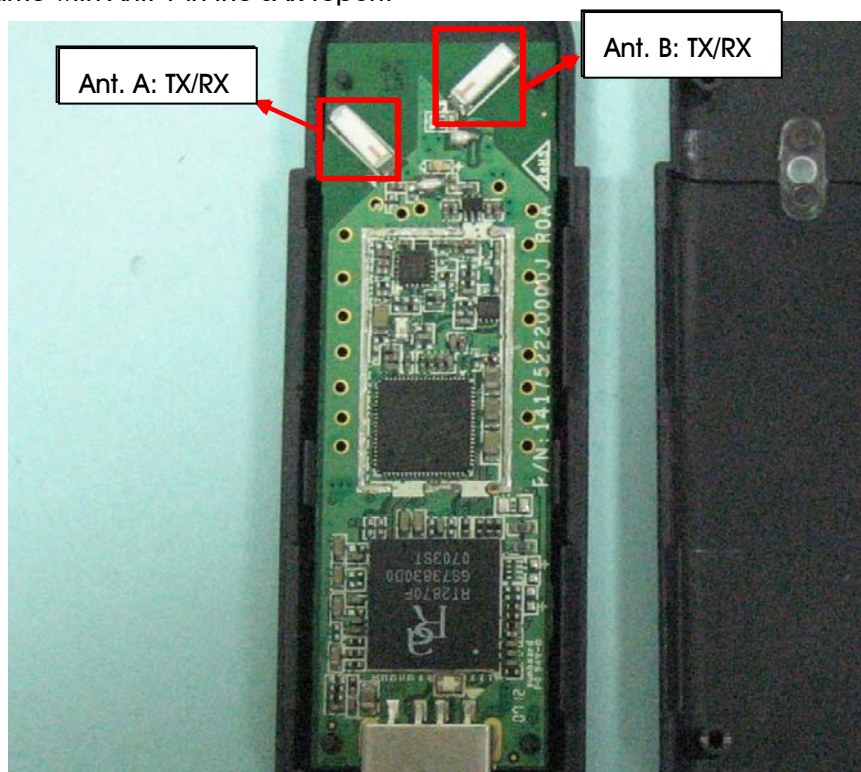

### 3.4. Table for Carrier Frequencies

Frequency Band	Channel No.	Frequency	Channel No.	Frequency
2400~2483.5MHz	1	2412 MHz	7	2442 MHz
	2	2417 MHz	8	2447 MHz
	3	2422 MHz	9	2452 MHz
	4	2427 MHz	10	2457 MHz
	5	2432 MHz	11	2462 MHz
	6	2437 MHz		

### 3.5. Table for Test Modes

Preliminary tests were performed in different data rate to find the worst radiated emission. The data rate shown in the table below is the worst-case rate with respect to the specific test item. Investigation has been done on all the possible configurations for searching the worst cases. The following table is a list of the test modes shown in this test report.

Test Items	Mode	Data Rate	Channel	Antenna
AC Power Line Conducted Emissions	Normal Link	11 Mbps	6	A
Maximum Peak Conducted Output Power	11b/BPSK	1 Mbps	1/6/11	NA
Power Spectral Density	11g/BPSK	6 Mbps	1/6/11	NA
6dB Spectrum Bandwidth				
Radiated Emissions 9kHz~1GHz	11g/BPSK	6 Mbps	6	A
Radiated Emissions 1GHz~10 <sup>th</sup> Harmonic	11b/BPSK	1 Mbps	1/6/11	A
	11g/BPSK	6 Mbps	1/6/11	A
Band Edge Emissions	11b/BPSK	1 Mbps	1/11	A
	11g/BPSK	6 Mbps	1/11	A

The following test modes were performed for all tests:

Mode 1: Dongle +USB Cable mode

Mode 2: Dongle mode

< *Conduction* > :

Cause "mode 2" generated the worst test result, it was reported as final data.

< *Radiation* > :

Cause "mode 1" generated the worst test result on 30MHz~1GHz, it was reported as final data.

Cause "mode 2" generated the worst test result on above 1GHz, it was reported as final data.



### 3.6. Table for Testing Locations

Test Site No.	Site Category	Location	FCC Reg. No.	IC File No.	VCCI Reg. No
03CH03-HY	SAC	Hwa Ya	101377	IC 4088	-
CO04-HY	Conduction	Hwa Ya	101377	IC 4088	-
TH01-HY	OVEN Room	Hwa Ya	-	-	-

Open Area Test Site (OATS); Semi Anechoic Chamber (SAC); Fully Anechoic Chamber (FAC).

Please refer section 6 for Test Site Address.

### 3.7. Table for Supporting Units

Support Unit	Brand	Model	FCC ID
Notebook	DELL	D505	E2K24GBRL
Printer	EPSON	LQ-300	DOC
Modem	ACEEX	DM-1414	IFAXDM1414
WLAN AP	PLANEX	GW-AP54SGX	DOC

### 3.8. Table for Parameters of Test Software Setting

During testing, Channel & Power Controlling Software provided by the customer was used to control the operating channel as well as the output power level. The RF output power selection is for the setting of RF output power expected by the customer and is going to be fixed on the firmware of the final end product.

#### Power Parameters of IEEE 802.11b/g

Test Software Version	RT2870QA		
Frequency	2412 MHz	2437 MHz	2462 MHz
IEEE 802.11b	19	12	16
IEEE 802.11g	17	13	15

An executive program, EMCTEST.EXE under WIN XP, which generates a complete line of continuously repeating " H " pattern was used as the test software.

The program was executed as follows :

- a. Turn on the power of all equipment.
- b. The NB sends " H " messages to the panel, and the panel displays " H " patterns on the screen.
- c. The NB sends " H " messages to the printer, then the printer prints them on the paper.
- d. The NB sends " H " messages to the modem.
- e. Repeat the steps from b to d.

At the same time, the following programs were executed:

Executed "ping.exe" to link with the remote workstation to receive and transmit data by WLAN.

Executed " RT2870QA " to control the EUT continuously transmit RF signal.

### 3.9. Test Configurations

#### 3.9.1. Radiation Emissions Test Configuration

Test Configuration: 9KHz~1GHz

Mode 1

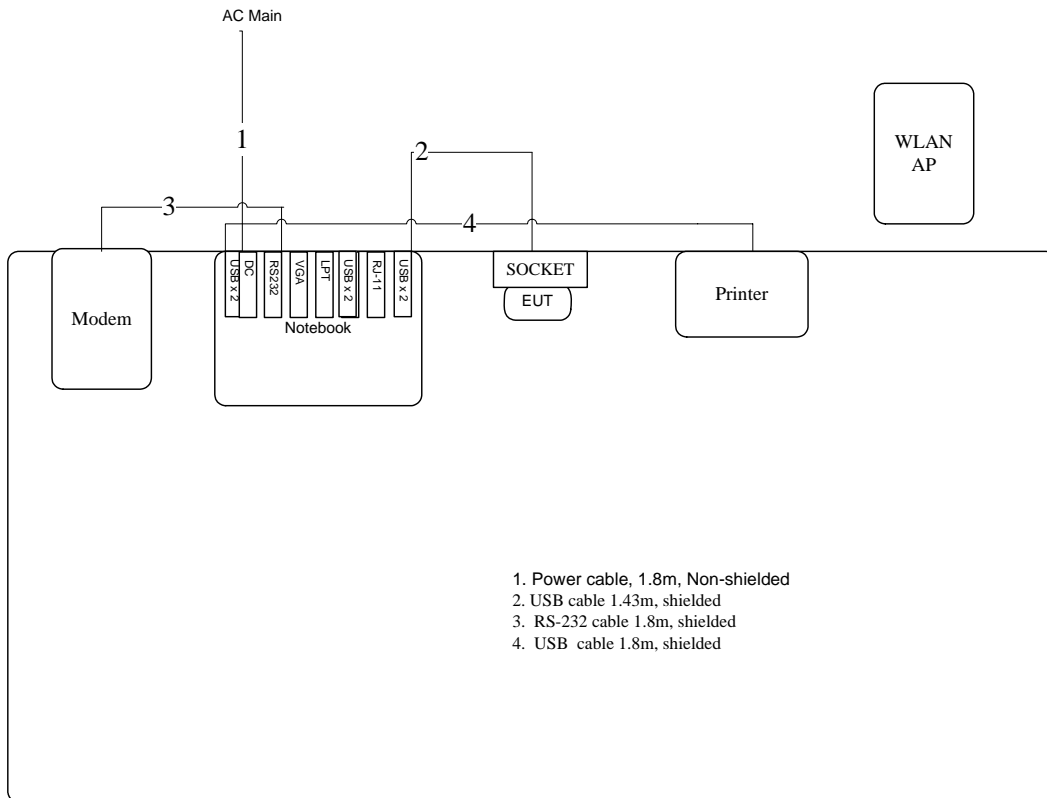

Mode 2

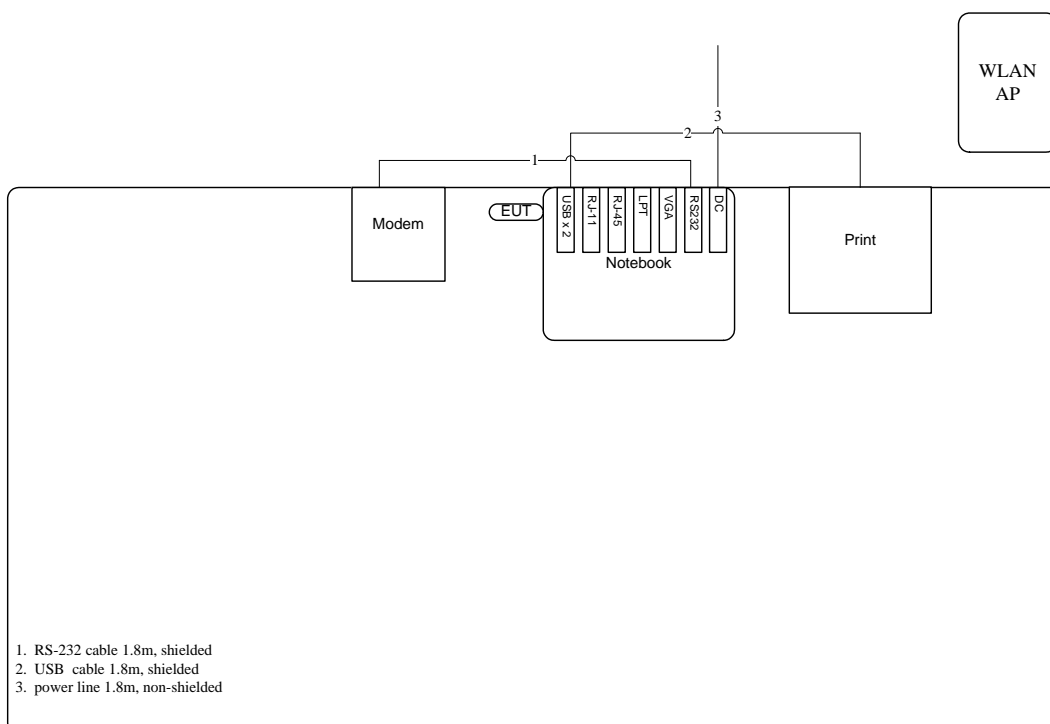

Test Configuration: above 1GHz

Mode 1

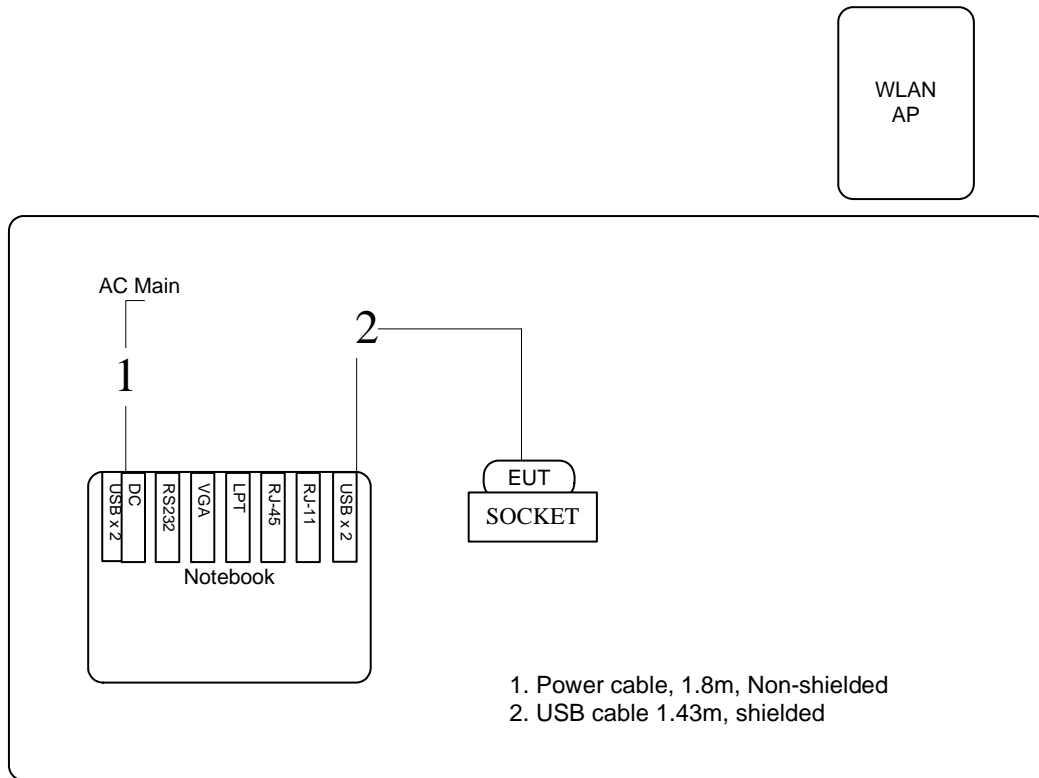

Mode 2

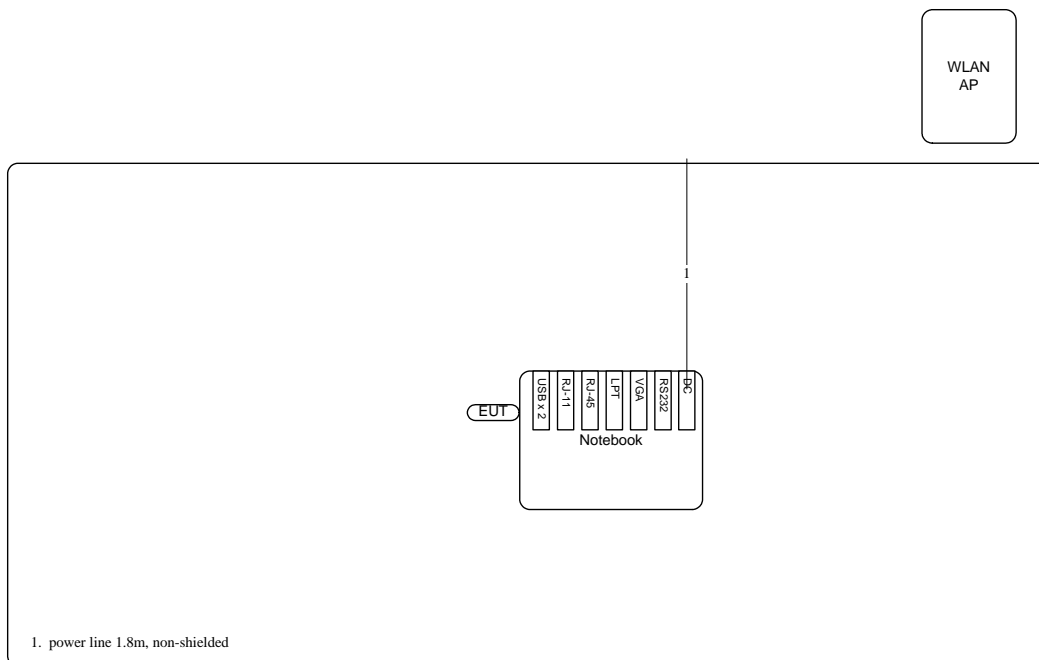

### 3.9.2. AC Power Line Conduction Emissions Test Configuration

#### Mode 1

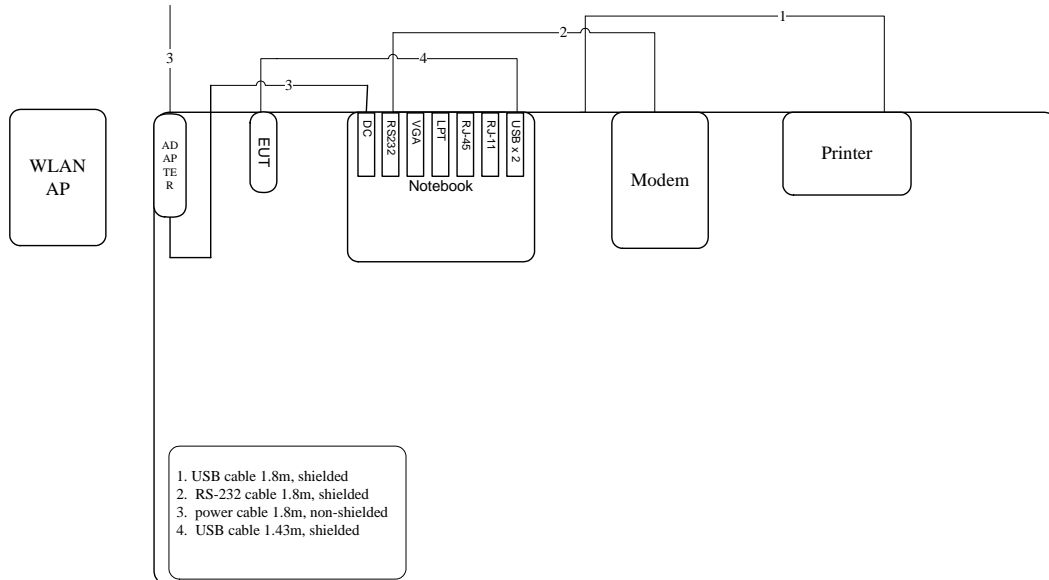

#### Mode 2

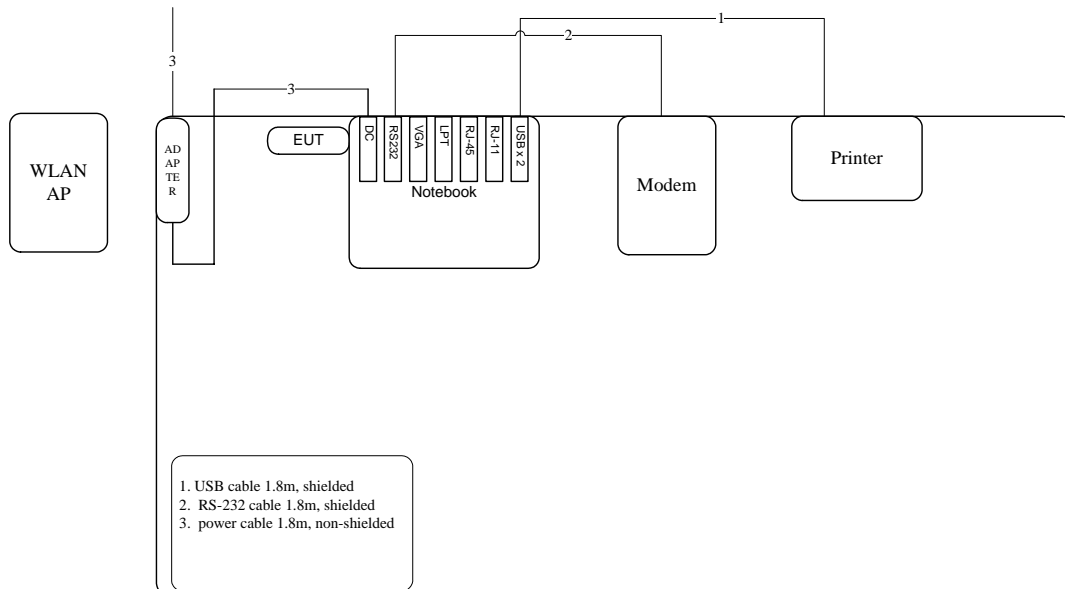

## 4. TEST RESULT

### 4.1. AC Power Line Conducted Emissions Measurement

#### 4.1.1. Limit

For this product which is designed to be connected to the AC power line, the radio frequency voltage that is conducted back onto the AC power line on any frequency or frequencies within the band 150 kHz to 30 MHz shall not exceed below limits table.

Frequency (MHz)	QP Limit (dBuV)	AV Limit (dBuV)
0.15~0.5	66~56	56~46
0.5~5	56	46
5~30	60	50

#### 4.1.2. Measuring Instruments and Setting

Please refer to section 5 of equipments list in this report. The following table is the setting of the receiver.

Receiver Parameters	Setting
Attenuation	10 dB
Start Frequency	0.15 MHz
Stop Frequency	30 MHz
IF Bandwidth	9 KHz

#### 4.1.3. Test Procedures

1. Configure the EUT according to ANSI C63.4. The EUT or host of EUT has to be placed 0.4 meter far from the conducting wall of the shielding room and at least 80 centimeters from any other grounded conducting surface.
2. Connect EUT or host of EUT to the power mains through a line impedance stabilization network (LISN).
3. All the support units are connected to the other LISNs. The LISN should provide 50uH/50ohms coupling impedance.
4. The frequency range from 150 KHz to 30 MHz was searched.
5. Set the test-receiver system to Peak Detect Function and Specified Bandwidth with Maximum Hold Mode.
6. The measurement has to be done between each power line and ground at the power terminal.

#### 4.1.4. Test Setup Layout

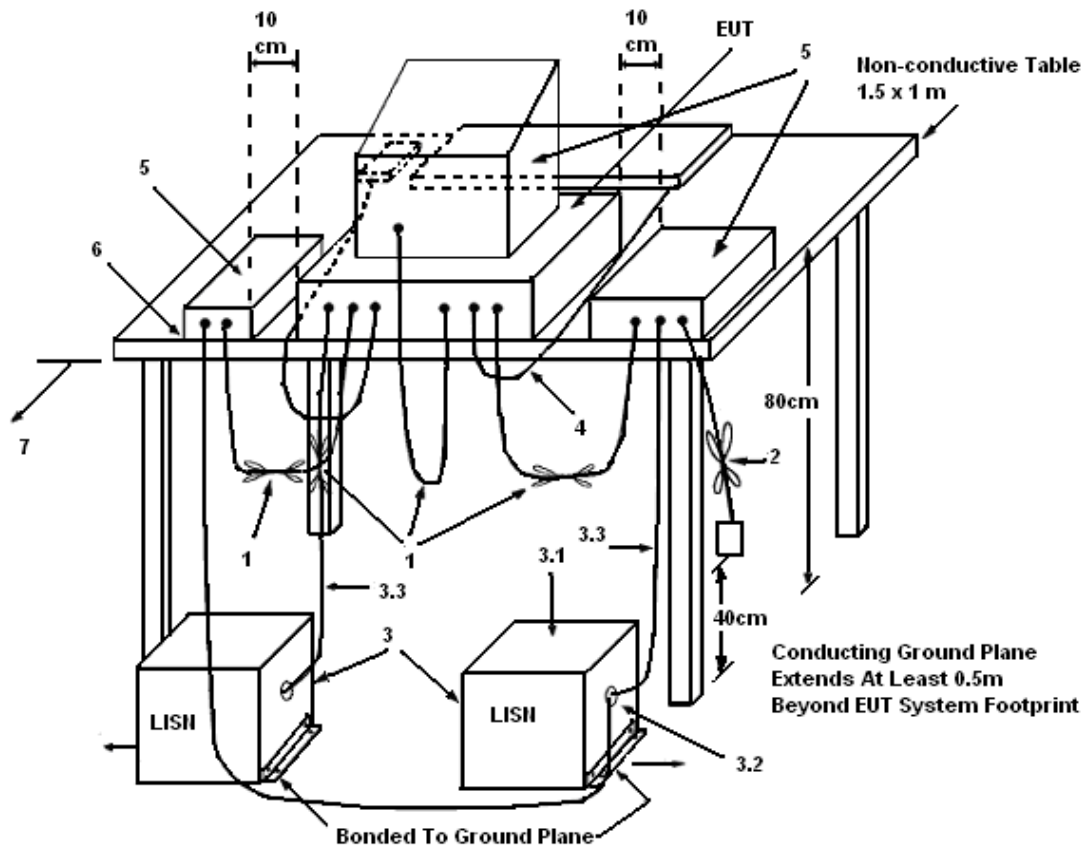

#### LEGEND:

- (1) Interconnecting cables that hang closer than 40 cm to the ground plane shall be folded back and forth in the center forming a bundle 30 to 40 cm long.
- (2) I/O cables that are not connected to a peripheral shall be bundled in the center. The end of the cable may be terminated, if required, using the correct terminating impedance. The overall length shall not exceed 1 m.
- (3) EUT connected to one LISN. Unused LISN measuring port connectors shall be terminated in  $50 \Omega$ . LISN can be placed on top of, or immediately beneath, reference ground plane.
  - (3.1) All other equipment powered from additional LISN(s).
  - (3.2) Multiple outlet strip can be used for multiple power cords of non-EUT equipment.
  - (3.3) LISN at least 80 cm from nearest part of EUT chassis.
- (4) Cables of hand-operated devices, such as keyboards, mice, etc., shall be placed as for normal use.
- (5) Non-EUT components of EUT system being tested.
- (6) Rear of EUT, including peripherals, shall all be aligned and flush with rear of tabletop.
- (7) Rear of tabletop shall be 40 cm removed from a vertical conducting plane that is bonded to the ground plane.

4.1.5. Test Deviation

There is no deviation with the original standard.

4.1.6. EUT Operation during Test

The EUT was placed on the test table and programmed in normal function.

4.1.7. Results of AC Power Line Conducted Emissions Measurement

Temperature	20°C	Humidity	59%
Test Engineer	Johnson Chang	Phase	Line
Configuration	Normal Link		

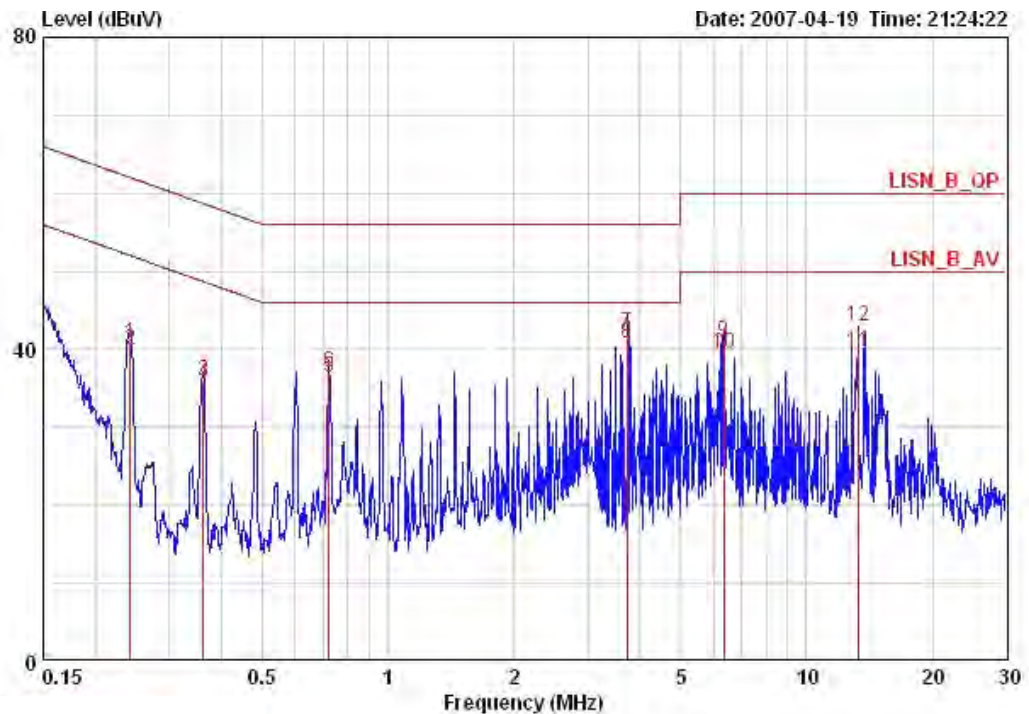

	Freq	Level	Over	Limit	Read	LISN	Cable	Remark	Pol/Phase
	MHz	dBuV	Limit	Line	Level	Factor	Loss		
			dB	dBuV	dBuV	dB	dB		
1	0.24165	40.77	-21.27	62.04	40.50	0.07	0.20	QP	LINE
2	0.24165	39.91	-12.13	52.04	39.64	0.07	0.20	AVERAGE	LINE
3	0.36146	36.00	-12.69	48.69	35.79	0.01	0.20	AVERAGE	LINE
4	0.36146	35.60	-23.09	58.69	35.39	0.01	0.20	QP	LINE
5	0.72160	36.30	-9.70	46.00	36.10	0.00	0.20	AVERAGE	LINE
6	0.72160	37.11	-18.89	56.00	36.91	0.00	0.20	QP	LINE
7	3.728	42.11	-13.89	56.00	41.81	0.00	0.30	QP	LINE
8	3.728	40.83	-5.17	46.00	40.53	0.00	0.30	AVERAGE	LINE
9	6.341	40.89	-19.11	60.00	40.47	0.05	0.37	QP	LINE
10	6.341	39.44	-10.56	50.00	39.02	0.05	0.37	AVERAGE	LINE
11	13.312	39.71	-10.29	50.00	39.21	0.10	0.40	AVERAGE	LINE
12	13.312	42.85	-17.15	60.00	42.35	0.10	0.40	QP	LINE



Temperature	20°C	Humidity	59%
Test Engineer	Johnson Chang	Phase	Neutral
Configuration	Normal Link		

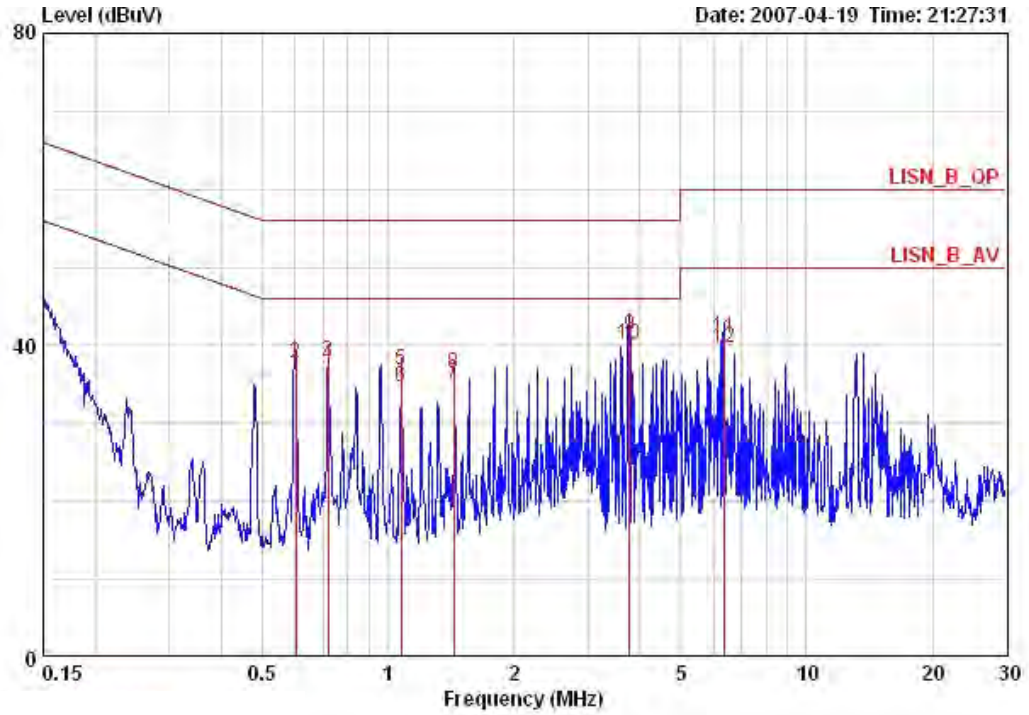

	Freq	Level	Over	Limit	Read	LISN	Cable	Remark	Pol/Phase
	MHz	dBuV	Limit	Line	Level	Factor	Loss		
			dB	dBuV	dBuV	dB	dB		
1	0.60112	37.98	-8.02	46.00	37.78	0.00	0.20	AVERAGE	NEUTRAL
2	0.60112	37.81	-18.19	56.00	37.61	0.00	0.20	QP	NEUTRAL
3	0.71977	37.90	-18.10	56.00	37.70	0.00	0.20	QP	NEUTRAL
4	0.71977	37.46	-8.54	46.00	37.26	0.00	0.20	AVERAGE	NEUTRAL
5	1.077	36.92	-19.08	56.00	36.74	0.00	0.18	QP	NEUTRAL
6	1.077	34.72	-11.28	46.00	34.54	0.00	0.18	AVERAGE	NEUTRAL
7	1.437	35.19	-10.81	46.00	35.08	0.00	0.11	AVERAGE	NEUTRAL
8	1.437	36.32	-19.68	56.00	36.21	0.00	0.11	QP	NEUTRAL
9	3.779	41.13	-14.87	56.00	40.83	0.00	0.30	QP	NEUTRAL
10	3.779	40.13	-5.87	46.00	39.83	0.00	0.30	AVERAGE	NEUTRAL
11	6.341	40.95	-19.05	60.00	40.53	0.05	0.37	QP	NEUTRAL
12	6.341	39.68	-10.32	50.00	39.26	0.05	0.37	AVERAGE	NEUTRAL

Note:

Level = Read Level + LISN Factor + Cable Loss.

## 4.2. Maximum Peak Output Power Measurement

### 4.2.1. Limit

For systems using digital modulation in the 2400-2483.5MHz, the limit for peak output power is 30dBm. The limited has to be reduced by the amount in dB that the gain of the antenna exceed 6dBi. In case of point-to-point operation, the limit has to be reduced by 1dB for every 3dB that the directional gain of the antenna exceeds 6dBi.

### 4.2.2. Measuring Instruments and Setting

Please refer to section 5 of equipments list in this report. The following table is the setting of the power meter.

Power Meter Parameter	Setting
Filter No.	Auto
Measurement time	0.135 s ~ 26 s
Used Peak Sensor	NRV-Z32 (model 04)

### 4.2.3. Test Procedures

1. The transmitter output (antenna port) was connected to the power meter.
2. Turn on the EUT and power meter and then record the peak power value.
3. Repeat above procedures on all channels needed to be tested.

### 4.2.4. Test Setup Layout

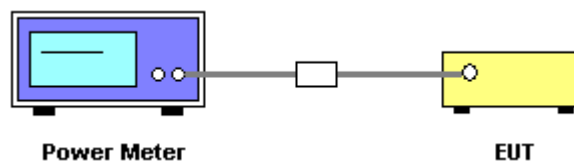

### 4.2.5. Test Deviation

There is no deviation with the original standard.

### 4.2.6. EUT Operation during Test

The EUT was programmed to be in continuously transmitting mode.

#### 4.2.7. Test Result of Maximum Peak Output Power

<b>Temperature</b>	23°C	<b>Humidity</b>	58%
<b>Test Engineer</b>	Leo Hung	<b>Configurations</b>	802.11b/g

##### Configuration IEEE 802.11b

Channel	Frequency	Conducted Power (dBm)	Max. Limit (dBm)	Result
1	2412 MHz	16.88	30.00	Complies
6	2437 MHz	17.60	30.00	Complies
11	2462 MHz	17.65	30.00	Complies

##### Configuration IEEE 802.11g

Channel	Frequency	Conducted Power (dBm)	Max. Limit (dBm)	Result
1	2412 MHz	19.34	30.00	Complies
6	2437 MHz	17.60	30.00	Complies
11	2462 MHz	19.48	30.00	Complies

### 4.3. Power Spectral Density Measurement

#### 4.3.1. Limit

For digitally modulated systems, the power spectral density conducted from the intentional radiator to the antenna shall not be greater than 8 dBm in any 3 kHz band during any time interval of continuous transmission.

#### 4.3.2. Measuring Instruments and Setting

Please refer to section 5 of equipments list in this report. The following table is the setting of the spectrum analyzer.

Spectrum Parameter	Setting
Attenuation	Auto
Span Frequency	1.5MHz
RB	3 kHz
VB	30 kHz
Detector	Peak
Trace	Max Hold
Sweep Time	500s

#### 4.3.3. Test Procedures

1. The transmitter output (antenna port) was connected to the spectrum analyser.
2. Set RBW of spectrum analyzer to 3kHz and VBW to 30kHz. Set Detector to Peak, Trace to Max Hold.
3. Mark the frequency with maximum peak power as the center of the display of the spectrum.
4. Set the span to 1.5MHz and the sweep time to 500s and record the maximum peak value.

#### 4.3.4. Test Setup Layout

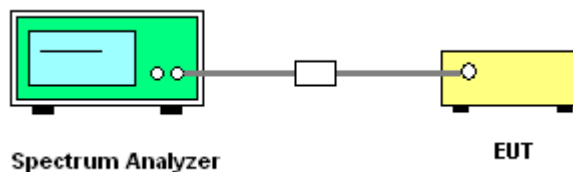

#### 4.3.5. Test Deviation

There is no deviation with the original standard.

#### 4.3.6. EUT Operation during Test

The EUT was programmed to be in continuously transmitting mode.

#### 4.3.7. Test Result of Power Spectral Density

<b>Temperature</b>	23°C	<b>Humidity</b>	58%
<b>Test Engineer</b>	Leo Hung	<b>Configurations</b>	802.11b/g

##### Configuration IEEE 802.11b

Channel	Frequency	Power Density (dBm)	Max. Limit (dBm)	Result
1	2412 MHz	-13.01	8.00	Complies
6	2437 MHz	-10.33	8.00	Complies
11	2462 MHz	-11.91	8.00	Complies

##### Configuration IEEE 802.11g

Channel	Frequency	Power Density (dBm)	Max. Limit (dBm)	Result
1	2412 MHz	-15.09	8.00	Complies
6	2437 MHz	-13.43	8.00	Complies
11	2462 MHz	-15.04	8.00	Complies

### Power Density Plot on Configuration IEEE 802.11b / 2412 MHz

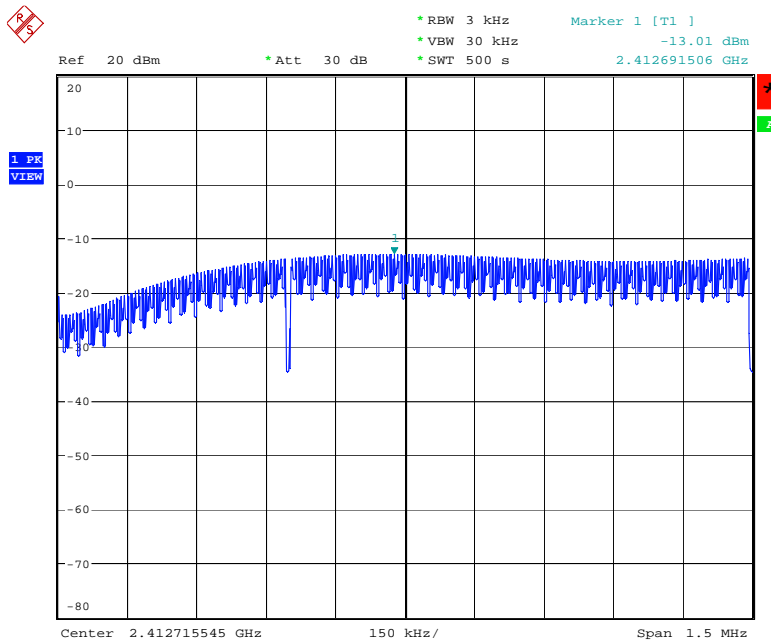

Date: 25.APR.2007 17:06:08

### Power Density Plot on Configuration IEEE 802.11b / 2437 MHz

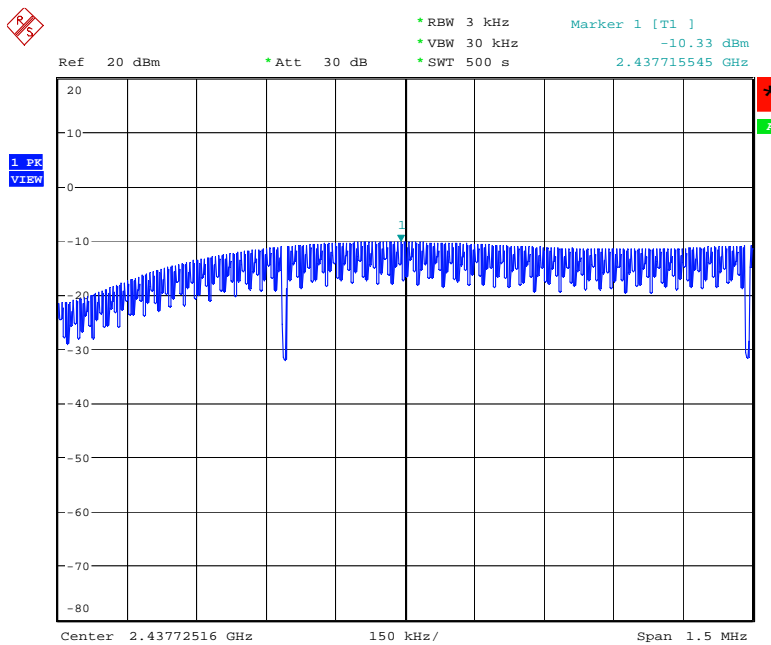

Date: 25.APR.2007 17:18:24

### Power Density Plot on Configuration IEEE 802.11b / 2462 MHz

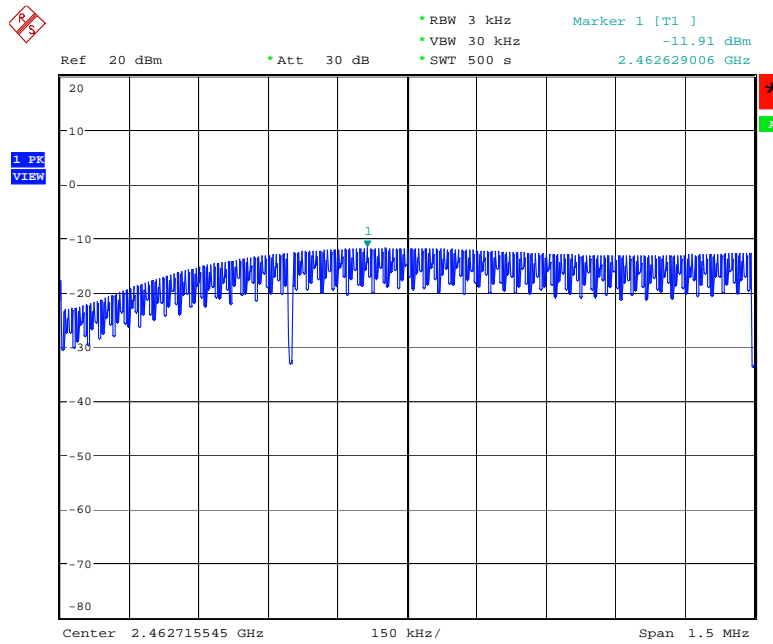

Date: 25.APR.2007 17:07:53

### Power Density Plot on Configuration IEEE 802.11g / 2412 MHz

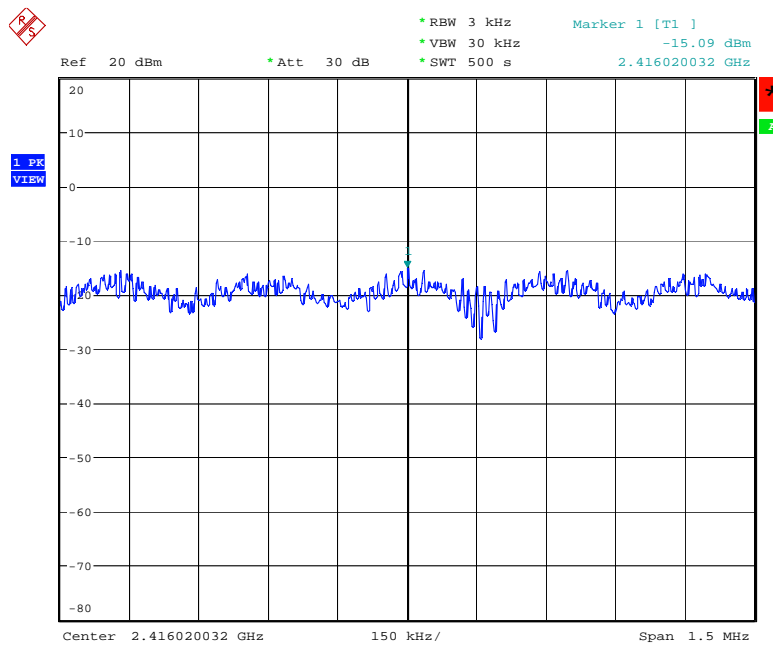

Date: 25.APR.2007 17:15:32

**Power Density Plot on Configuration IEEE 802.11g / 2437 MHz**

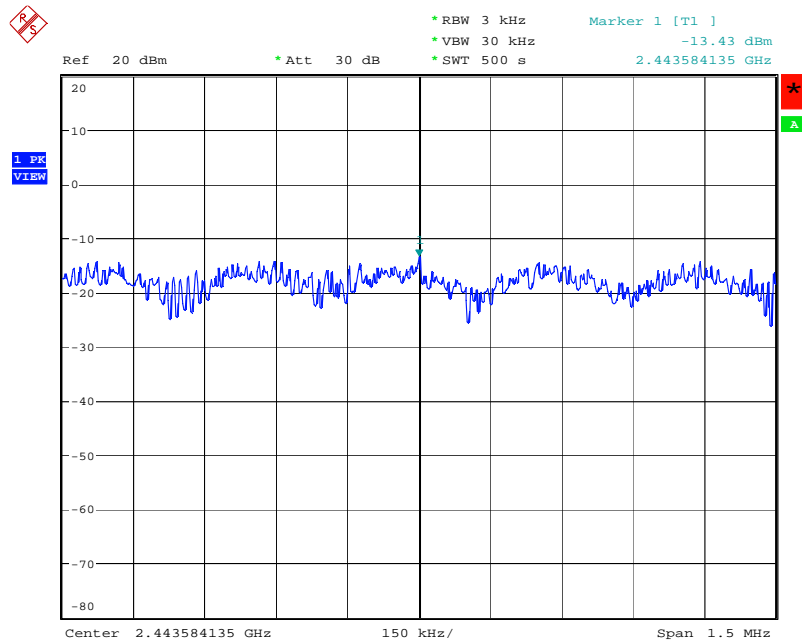

Date: 2.MAY.2007 10:11:45

**Power Density Plot on Configuration IEEE 802.11g / 2462 MHz**

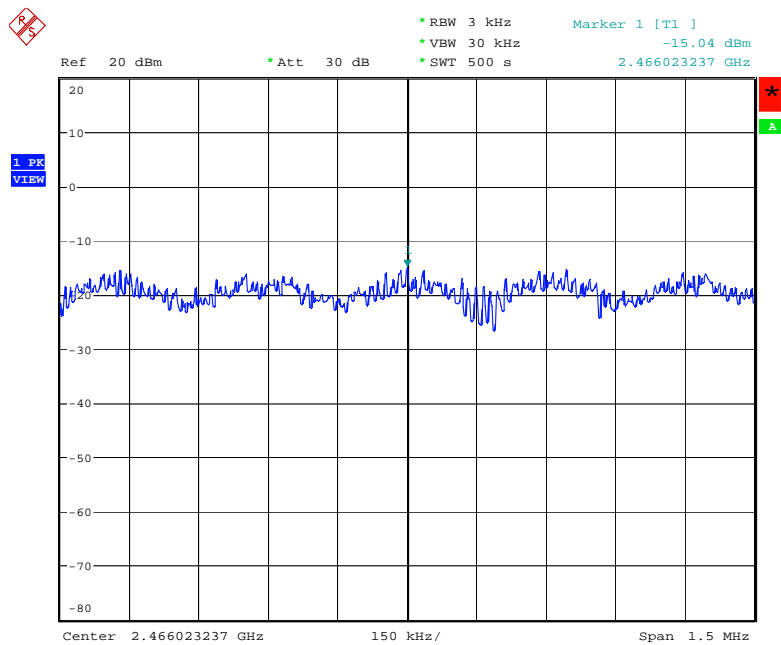

Date: 25.APR.2007 17:17:04



#### 4.4. 6dB Spectrum Bandwidth Measurement

##### 4.4.1. Limit

For digital modulation systems, the minimum 6dB bandwidth shall be at least 500 kHz.

##### 4.4.2. Measuring Instruments and Setting

Please refer to section 5 of equipments list in this report. The following table is the setting of the spectrum analyzer.

Spectrum Parameters	Setting
Attenuation	Auto
Span Frequency	> 6dB Bandwidth
RB	100 kHz
VB	100 kHz
Detector	Peak
Trace	Max Hold
Sweep Time	Auto

##### 4.4.3. Test Procedures

1. The transmitter output (antenna port) was connected to the spectrum analyser in peak hold mode.
2. The resolution bandwidth of 100 kHz and the video bandwidth of 100 kHz were used.
3. Measured the spectrum width with power higher than 6dB below carrier.

##### 4.4.4. Test Setup Layout

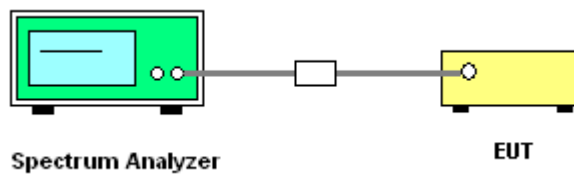

#### 4.4.5. Test Deviation

There is no deviation with the original standard.

#### 4.4.6. EUT Operation during Test

The EUT was programmed to be in continuously transmitting mode.

#### 4.4.7. Test Result of 6dB Spectrum Bandwidth

<b>Temperature</b>	23°C	<b>Humidity</b>	58%
<b>Test Engineer</b>	Leo Hung	<b>Configurations</b>	802.11b/g

##### Configuration IEEE 802.11b

Channel	Frequency	6dB Bandwidth (MHz)	99% Occupied Bandwidth (MHz)	Min. Limit (kHz)	Test Result
1	2412 MHz	12.27	14.90	500	Complies
6	2437 MHz	12.24	14.93	500	Complies
11	2462 MHz	12.27	14.87	500	Complies

##### Configuration IEEE 802.11g

Channel	Frequency	6dB Bandwidth (MHz)	99% Occupied Bandwidth (MHz)	Min. Limit (kHz)	Test Result
1	2412 MHz	16.57	16.44	500	Complies
6	2437 MHz	16.53	16.47	500	Complies
11	2462 MHz	16.57	16.47	500	Complies

### 6 dB Bandwidth Plot on Configuration IEEE 802.11b / 2412 MHz

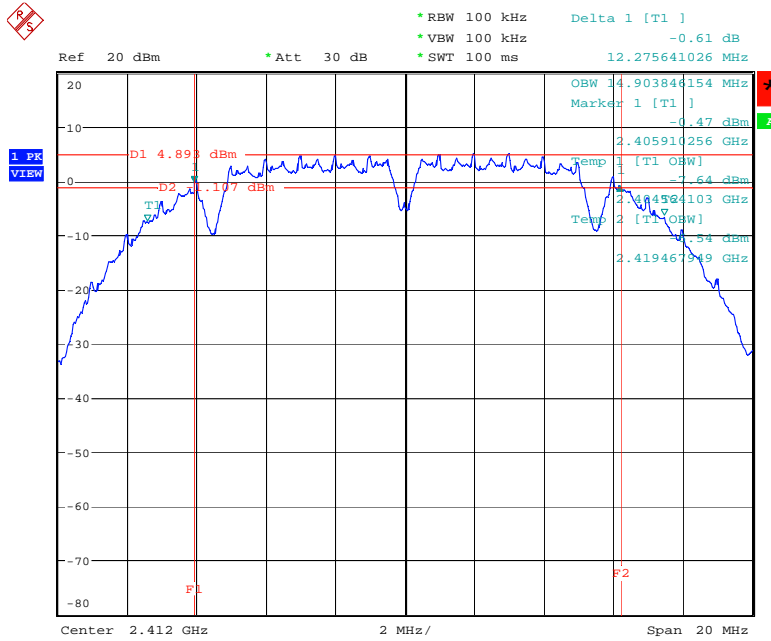

Date: 25.APR.2007 17:05:43

### 6 dB Bandwidth Plot on Configuration IEEE 802.11b / 2437 MHz

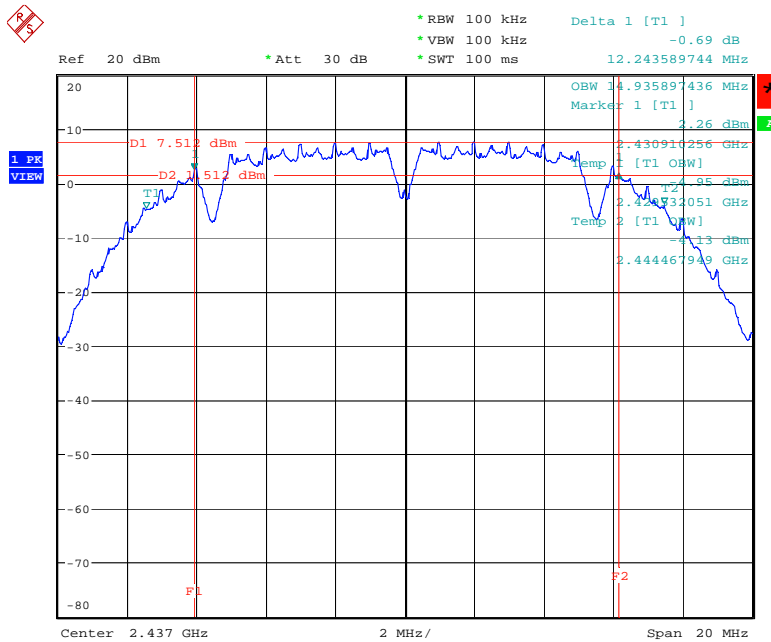

Date: 25.APR.2007 17:18:07

### 6 dB Bandwidth Plot on Configuration IEEE 802.11b / 2462 MHz

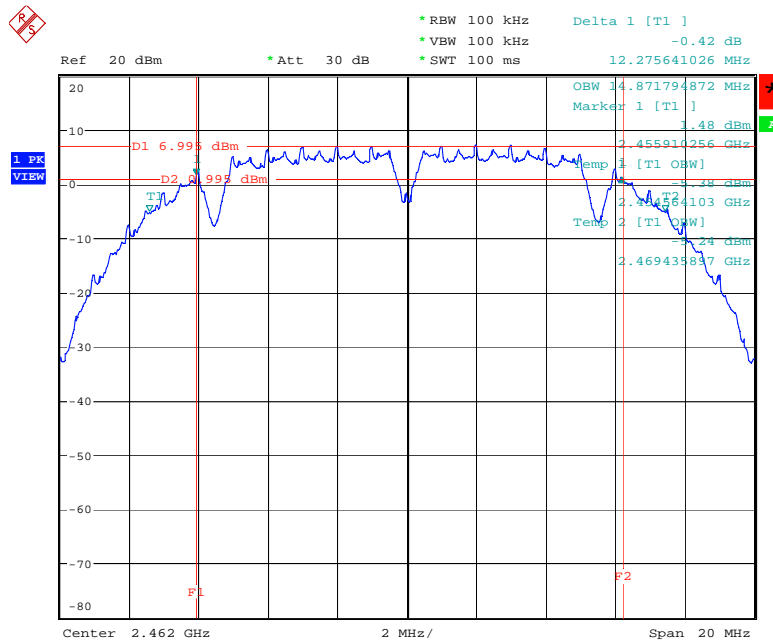

Date: 25.APR.2007 17:07:37

### 6 dB Bandwidth Plot on Configuration IEEE 802.11g / 2412 MHz

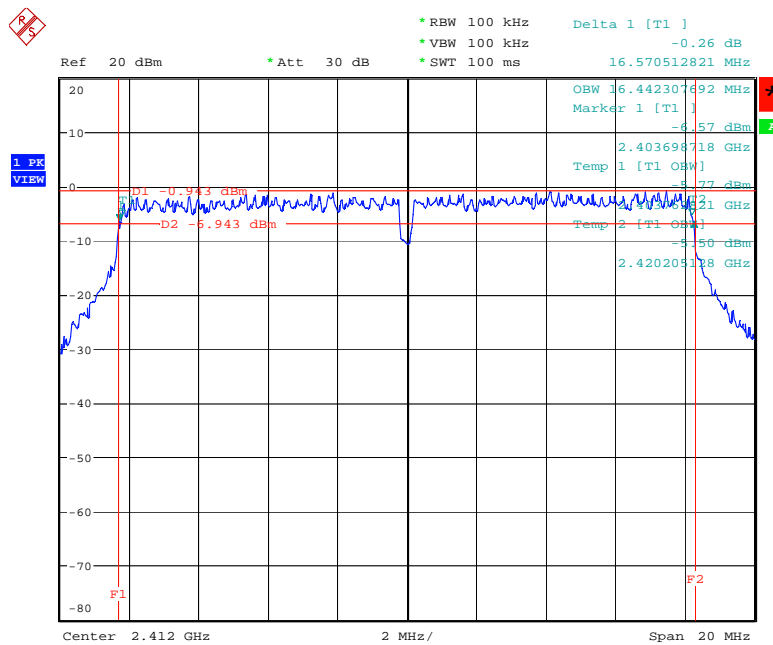

Date: 25.APR.2007 17:15:06

### 6 dB Bandwidth Plot on Configuration IEEE 802.11g / 2437 MHz

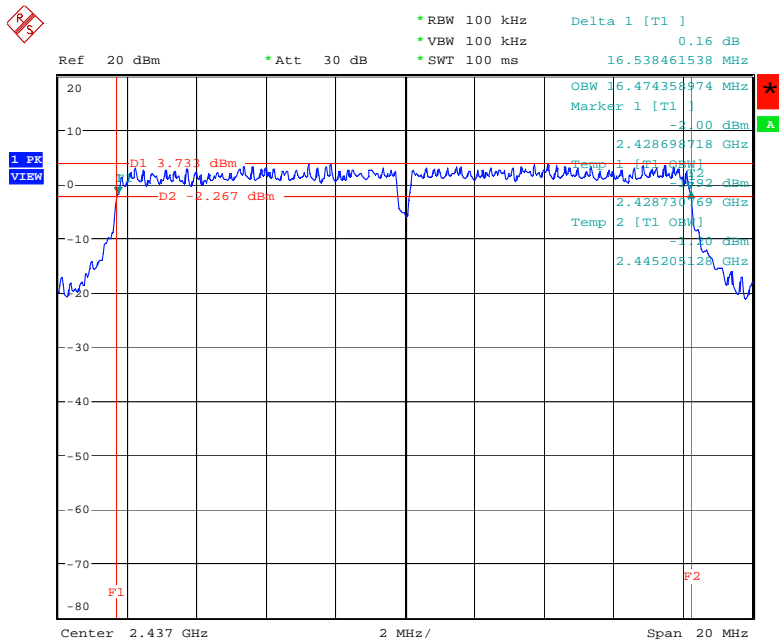

Date: 25.APR.2007 17:16:03

### 6 dB Bandwidth Plot on Configuration IEEE 802.11g / 2462 MHz

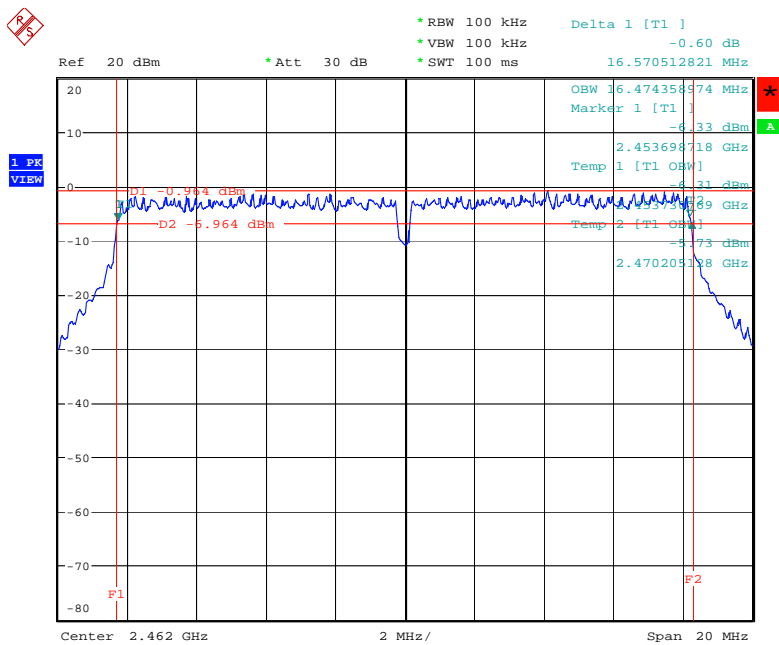

Date: 25.APR.2007 17:16:48

## 4.5. Radiated Emissions Measurement

### 4.5.1. Limit

20dBc in any 100 kHz bandwidth outside the operating frequency band. In case the emission fall within the restricted band specified on 15.205(a), then the 15.209(a) limit in the table below has to be followed.

Frequencies (MHz)	Field Strength (micorvolts/meter)	Measurement Distance (meters)
0.009~0.490	2400/F(KHz)	300
0.490~1.705	24000/F(KHz)	30
1.705~30.0	30	30
30~88	100	3
88~216	150	3
216~960	200	3
Above 960	500	3

### 4.5.2. Measuring Instruments and Setting

Please refer to section 5 of equipments list in this report. The following table is the setting of spectrum analyzer and receiver.

Spectrum Parameter	Setting
Attenuation	Auto
Start Frequency	1000 MHz
Stop Frequency	10th carrier harmonic
RB / VB (Emission in restricted band)	1MHz / 1MHz for Peak, 1 MHz / 10Hz for Average
RB / VB (Emission in non-restricted band)	100KHz / 100KHz for peak

Receiver Parameter	Setting
Attenuation	Auto
Start ~ Stop Frequency	9kHz~150kHz / RB 200Hz for QP
Start ~ Stop Frequency	150kHz~30MHz / RB 9kHz for QP
Start ~ Stop Frequency	30MHz~1000MHz / RB 120kHz for QP

#### 4.5.3. Test Procedures

1. Configure the EUT according to ANSI C63.4. The EUT was placed on the top of the turntable 0.8 meter above ground. The phase center of the receiving antenna mounted on the top of a height-variable antenna tower was placed 3 meters far away from the turntable.
2. Power on the EUT and all the supporting units. The turntable was rotated by 360 degrees to determine the position of the highest radiation.
3. The height of the broadband receiving antenna was varied between one meter and four meters above ground to find the maximum emissions field strength of both horizontal and vertical polarization.
4. For each suspected emissions, the antenna tower was scan (from 1 M to 4 M) and then the turntable was rotated (from 0 degree to 360 degrees) to find the maximum reading.
5. Set the test-receiver system to Peak or CISPR quasi-peak Detect Function with specified bandwidth under Maximum Hold Mode.
6. For emissions above 1GHz, use 1MHz VBW and RBW for peak reading. Then 1MHz RBW and 10Hz VBW for average reading in spectrum analyzer.
7. When the radiated emissions limits are expressed in terms of the average value of the emissions, and pulsed operation is employed, the measurement field strength shall be determined by averaging over one complete pulse train, including blanking intervals, as long as the pulse train does not exceed 0.1 seconds. As an alternative (provided the transmitter operates for longer than 0.1 seconds) or in cases where the pulse train exceeds 0.1 seconds, the measured field strength shall be determined from the average absolute voltage during a 0.1 second interval during which the field strength is at its maximum value.
8. If the emissions level of the EUT in peak mode was 3 dB lower than the average limit specified, then testing will be stopped and peak values of EUT will be reported, otherwise, the emissions which do not have 3 dB margin will be repeated one by one using the quasi-peak method for below 1GHz.
9. For testing above 1GHz, the emissions level of the EUT in peak mode was lower than average limit (that means the emissions level in peak mode also complies with the limit in average mode), then testing will be stopped and peak values of EUT will be reported, otherwise, the emissions will be measured in average mode again and reported.
10. In case the emission is lower than 30MHz, loop antenna has to be used for measurement and the recorded data should be QP measured by receiver. High – Low scan is not required in this case.

#### 4.5.4. Test Setup Layout

For radiated emissions below 30MHz

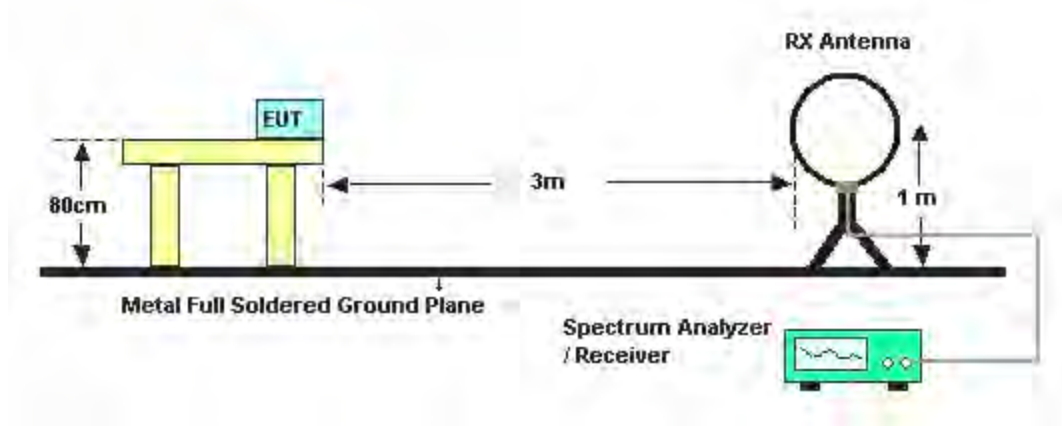

For radiated emissions above 30MHz

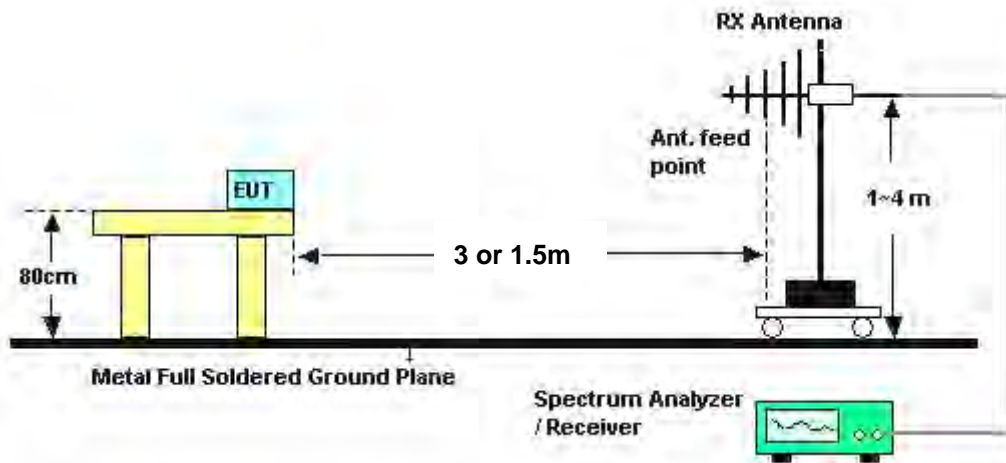

Above 10 GHz shall be extrapolated to the specified distance using an extrapolation factor of 20 dB/decade from 3m to 1.5m.

Distance extrapolation factor =  $20 \log (\text{specific distance [3m]} / \text{test distance [1.5m]})$  (dB);

Limit line = specific limits (dBuV) + distance extrapolation factor [6 dB].

#### 4.5.5. Test Deviation

There is no deviation with the original standard.

#### 4.5.6. EUT Operation during Test

The EUT was programmed to be in continuously transmitting mode.



#### 4.5.7. Results of Radiated Emissions (9kHz~30MHz)

<b>Temperature</b>	23°C	<b>Humidity</b>	62%
<b>Test Engineer</b>	Jacky Ho		

<b>Freq. (MHz)</b>	<b>Level (dBuV)</b>	<b>Over Limit (dB)</b>	<b>Limit Line (dBuV)</b>	<b>Remark</b>
-	-	-	-	See Note

Note:

The amplitude of spurious emissions that are attenuated by more than 20 dB below the permissible value has no need to be reported.

Distance extrapolation factor =  $40 \log(\text{specific distance} / \text{test distance})$  (dB);

Limit line = specific limits (dBuV) + distance extrapolation factor.

4.5.8. Results of Radiated Emissions (30MHz~1GHz)

Temperature	23°C	Humidity	62%
Test Engineer	Jacky Ho	Configurations	802.11g CH 6 Ant. A / Mode 1

Horizontal

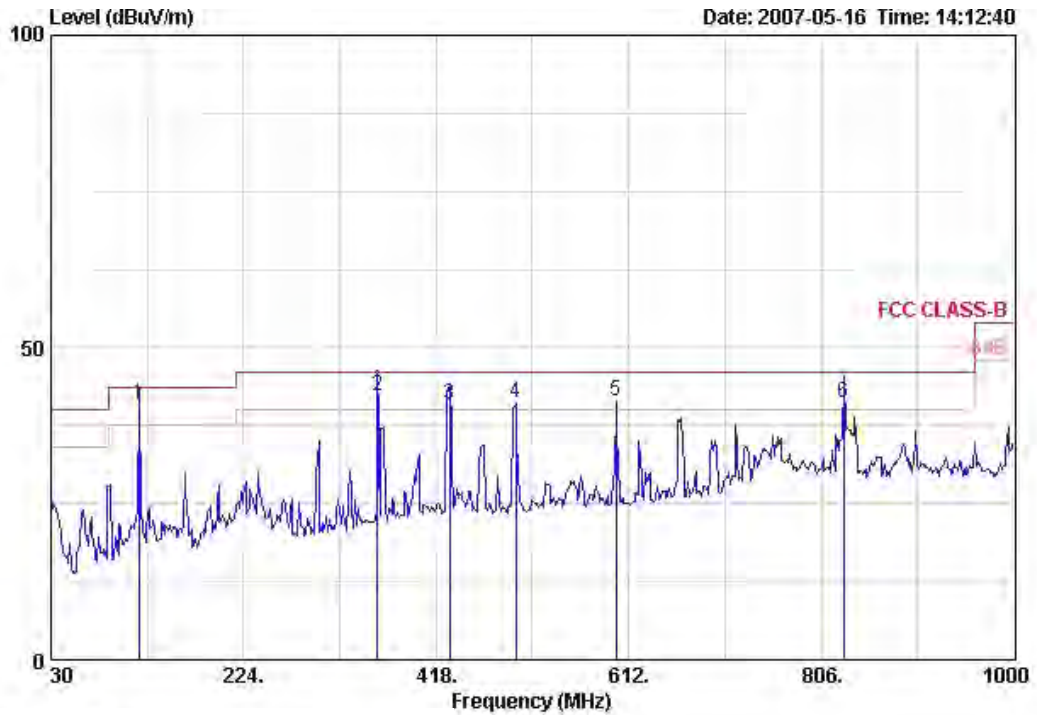

	Freq	Level	Over Limit	Limit Line	ReadAntenna Level	Antenna Factor	Cable Loss	Preamp Factor	Remark	Ant Pos	Table Pos
	MHz	dBuV/m	dB	dBuV/m	dBuV	dB/m	dB	dB		cm	deg
1 @	118.270	40.91	-2.59	43.50	53.30	12.75	0.84	25.98	QP	287	27
2 @	358.830	42.36	-3.64	46.00	50.70	15.51	1.24	25.09	QP	288	151
3 !	431.580	40.87	-5.13	46.00	48.23	16.94	1.49	25.79	QP	100	253
4 !	498.510	41.10	-4.90	46.00	47.86	17.78	1.80	26.33	Peak	100	0
5 !	599.390	41.34	-4.66	46.00	46.51	18.99	2.07	26.23	Peak	100	0
6 !	828.310	41.17	-4.83	46.00	42.53	21.10	2.52	24.97	QP	100	250

**Vertical**

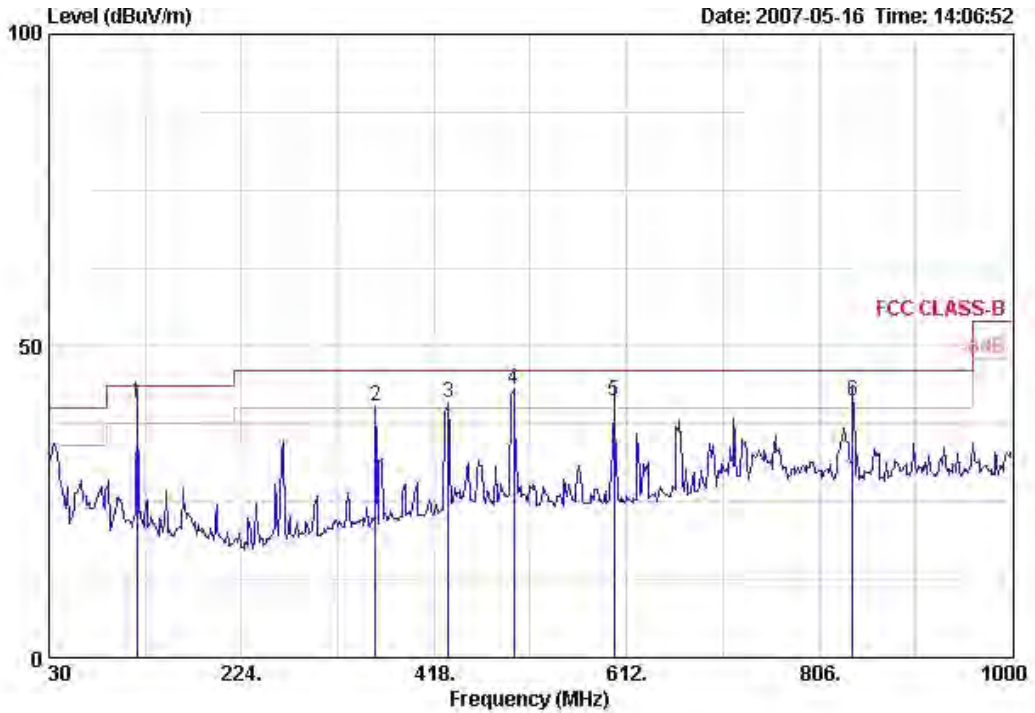

	Freq	Level	Over Limit	Limit Line	Read Level	Antenna Factor	Cable Loss	Preamp Factor	Remark	Ant Pos	Table Pos
	MHz	dBuV/m	dB	dBuV/m	dBuV	dB/m	dB	dB		cm	deg
1 @	118.270	40.81	-2.69	43.50	53.20	12.75	0.84	25.98	QP	100	272
2 !	358.830	40.26	-5.74	46.00	48.59	15.51	1.24	25.09	Peak	400	0
3 !	432.550	40.75	-5.25	46.00	48.11	16.96	1.49	25.80	Peak	400	0
4 @	498.510	42.94	-3.06	46.00	49.71	17.78	1.80	26.33	Peak	400	0
5 !	599.390	41.03	-4.97	46.00	46.20	18.99	2.07	26.23	QP	100	23
6 !	839.950	41.21	-4.79	46.00	42.31	21.26	2.52	24.88	QP	100	37

**Note:**

The amplitude of spurious emissions that are attenuated by more than 20dB below the permissible value has no need to be reported.

Emission level (dBUV/m) = 20 log Emission level (uV/m).

Corrected Reading: Antenna Factor + Cable Loss + Read Level - Preamp Factor = Level.

4.5.9. Results for Radiated Emissions (1GHz~10<sup>th</sup> Harmonic)

Temperature	23°C	Humidity	62%
Test Engineer	Jacky Ho	Configurations	802.11b CH 1 Ant. A / Mode 2

Horizontal

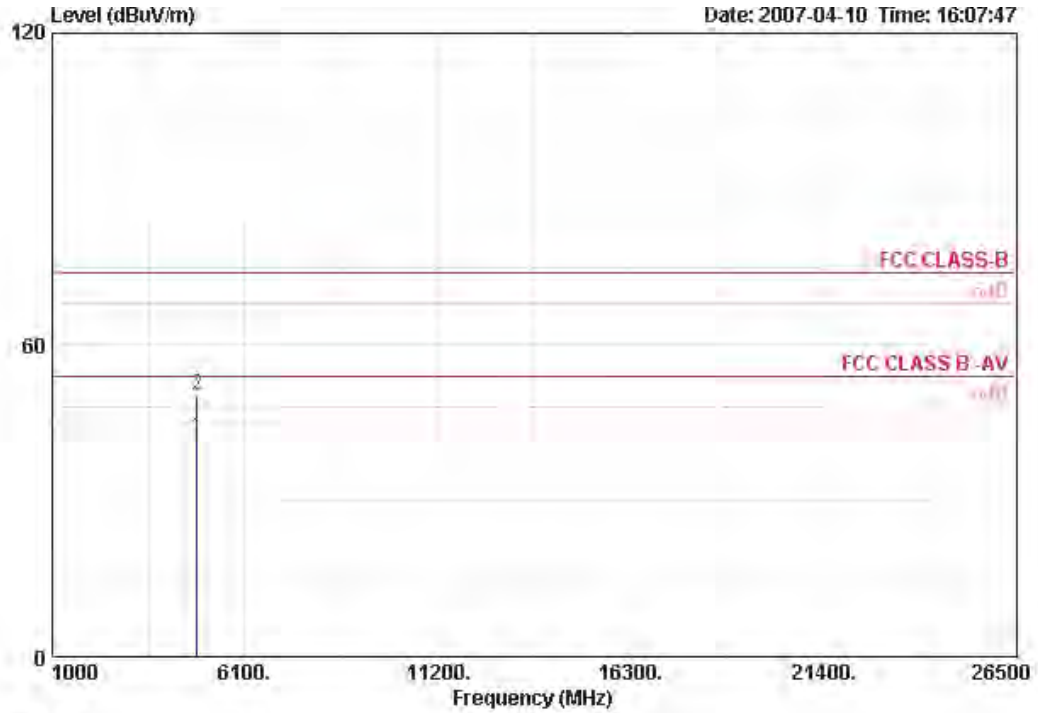

	Read	Limit	OverAntenna	Preamp	Cable	Ant	Table				
	Freq	Level	Line	Limit	Factor	Factor	Loss	Remark	Pos	Pos	Pol/Phase
	MHz	dBuV	dBuV/m	dBuV/m	dB	dB/m	dB		cm	deg	
1	4824.024	36.89	42.31	54.00	-11.69	34.29	35.26	6.39 AVERAGE	164	195	HORIZONTAL
2	4824.024	44.90	50.31	74.00	-23.69	34.29	35.26	6.39 PEAK	164	195	HORIZONTAL

**Vertical**

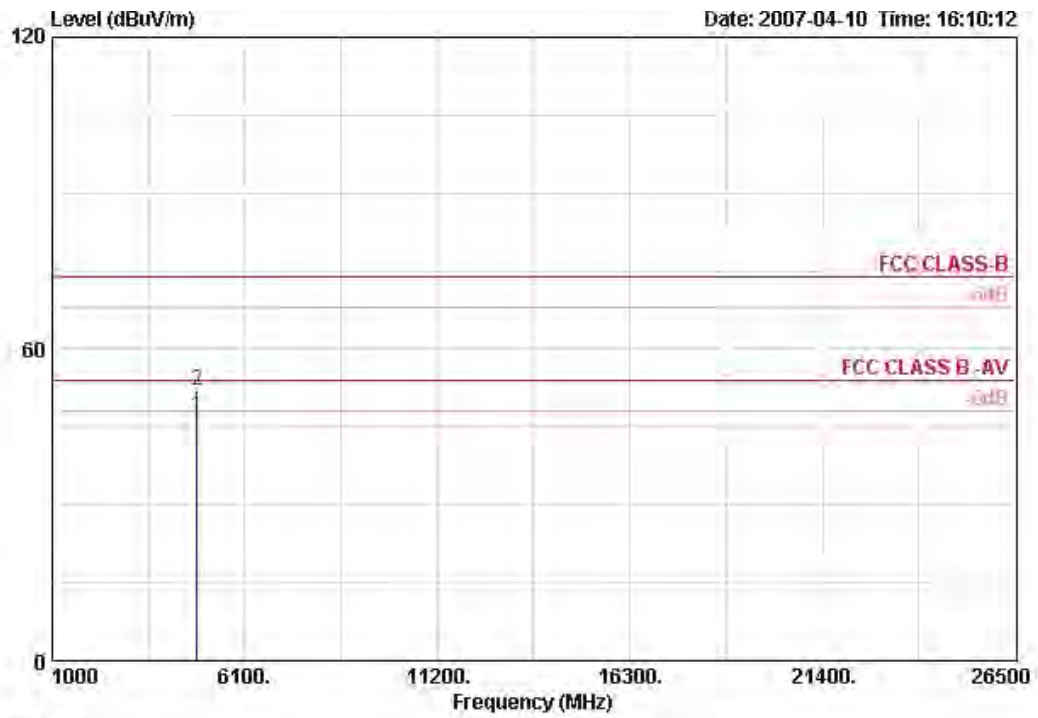

	Read Freq	Read Level	Limit Level	Limit Line	Over Limit	Antenna Factor	Preamp Factor	Cable Loss	Remark	Ant Pos	Table Pos	Pol/Phase
	MHz	dBuV	dBuV/m	dBuV/m	dB	dB/m	dB	dB		cm	deg	
1	4824.036	41.52	46.94	54.00	-7.06	34.29	35.26	6.39	AVERAGE	130	345	VERTICAL
2	4824.036	46.73	52.14	74.00	-21.86	34.29	35.26	6.39	PEAK	130	345	VERTICAL

Temperature	23°C	Humidity	62%
Test Engineer	Jacky Ho	Configurations	802.11b CH 6 Ant. A / Mode 2

**Horizontal**

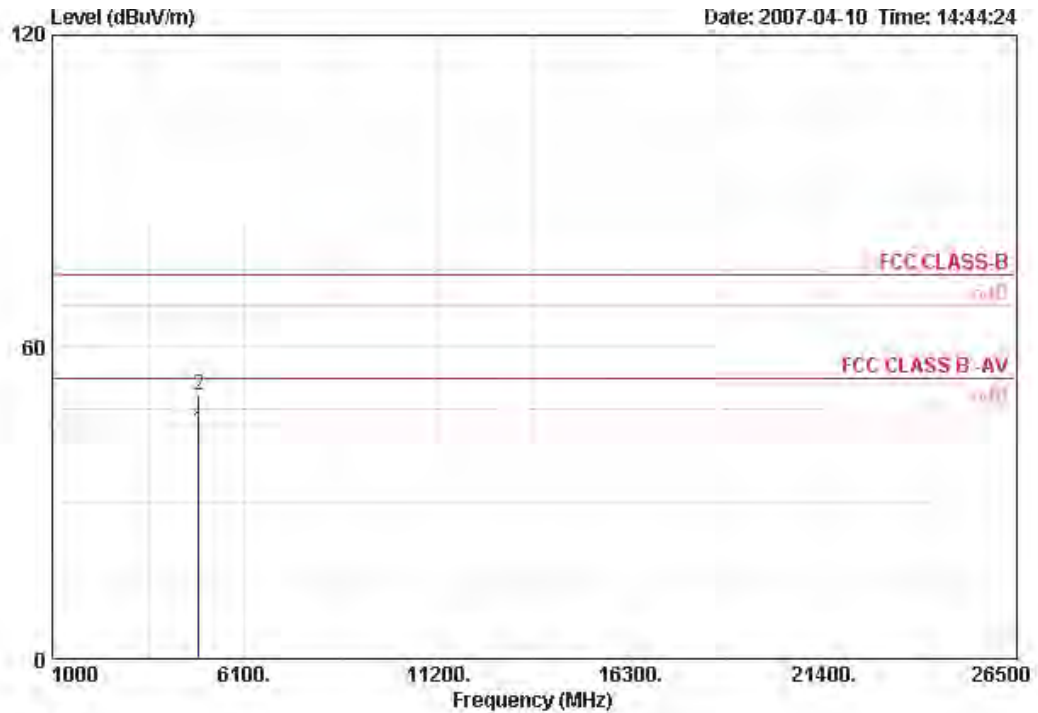

	Freq	Read Level	Level	Limit Line	Over Limit	Antenna Factor	Preamp Factor	Cable Loss	Remark	Ant Pos	Table Pos	Pol/Phase
	MHz	dBuV	dBuV/m	dBuV/m	dB	dB/m	dB	dB		cm	deg	
1	4873.984	38.09	43.92	54.00	-10.08	34.41	35.15	6.56	AVERAGE	158	102	HORIZONTAL
2	4873.984	44.96	50.78	74.00	-23.22	34.41	35.15	6.56	PEAK	158	102	HORIZONTAL

**Vertical**

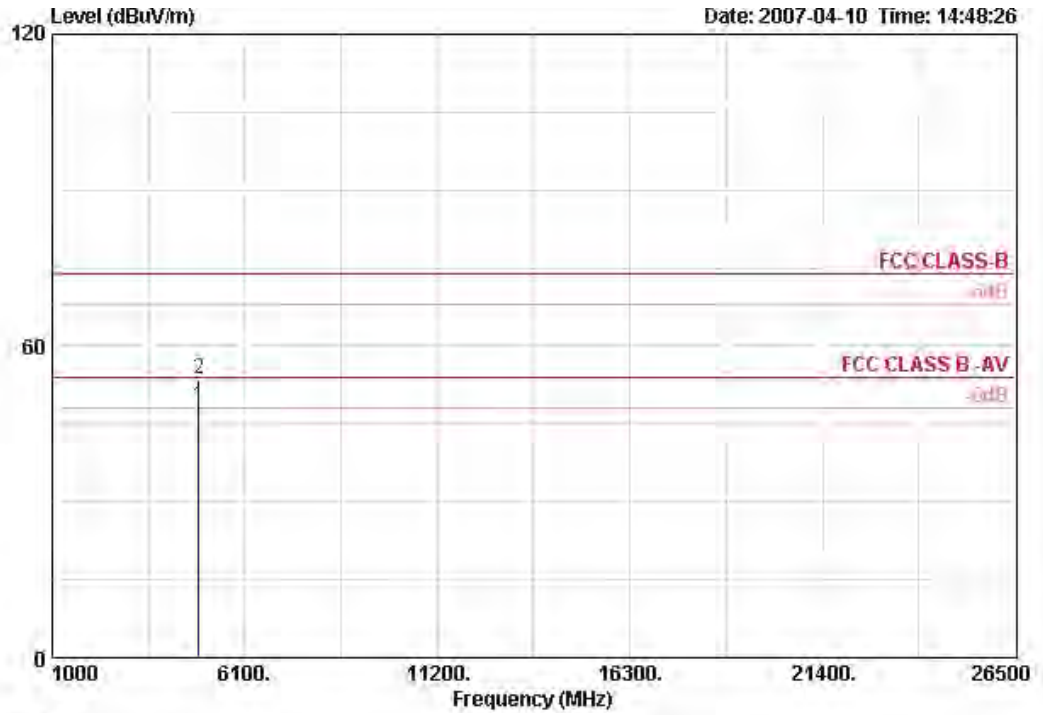

	Read Freq	Read Level	Limit Level	Limit Line	Over Limit	Antenna Factor	Preamp Factor	Cable Loss	Remark	Ant Pos	Table Pos	Pol/Phase
	MHz	dBuV	dBuV/m	dBuV/m	dB	dB/m	dB	dB		cm	deg	
1	4873.984	42.49	48.31	54.00	-5.69	34.41	35.15	6.56	AVERAGE	170	103	VERTICAL
2	4873.984	47.92	53.75	74.00	-20.25	34.41	35.15	6.56	PEAK	170	103	VERTICAL

Temperature	23°C	Humidity	62%
Test Engineer	Jacky Ho	Configurations	802.11b CH 11 Ant. A / Mode 2

**Horizontal**

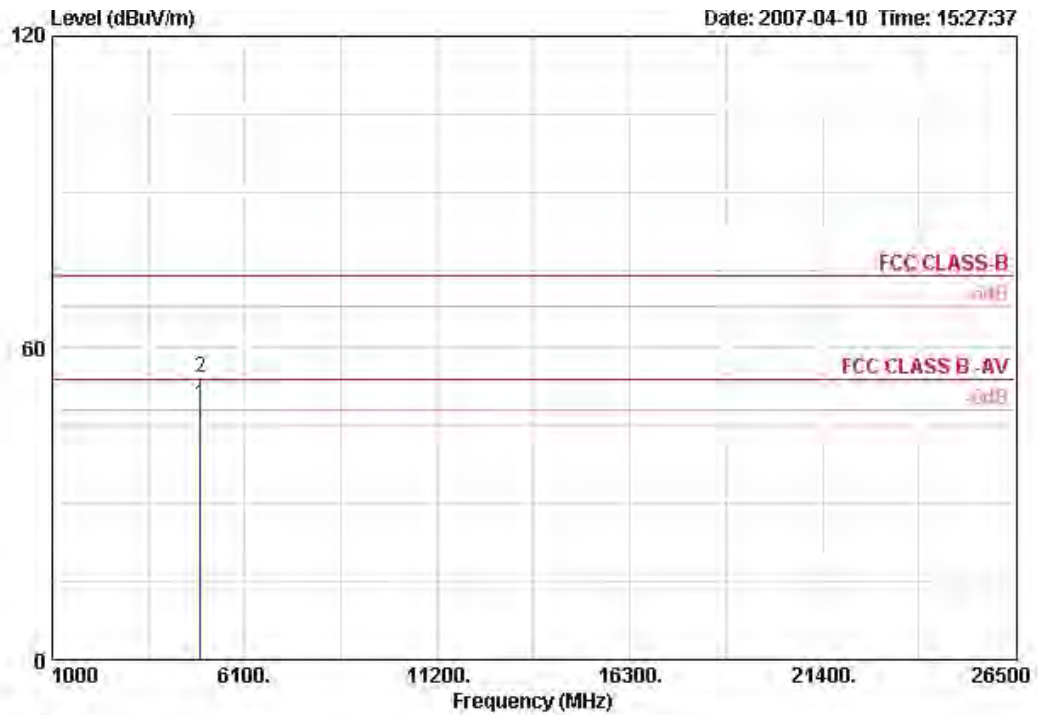

	Read Freq	Read Level	Limit Level	Limit Line	Over Limit	Antenna Factor	Preamp Factor	Cable Loss	Remark	Ant Pos	Table Pos	Pol/Phase
	MHz	dBuV	dBuV/m	dBuV/m	dB	dB/m	dB	dB		cm	deg	
1	4924.012	42.68	48.92	54.00	-5.08	34.53	35.03	6.73	AVERAGE	186	173	HORIZONTAL
2	4924.104	48.18	54.42	74.00	-19.58	34.53	35.03	6.73	PEAK	186	173	HORIZONTAL



**Vertical**

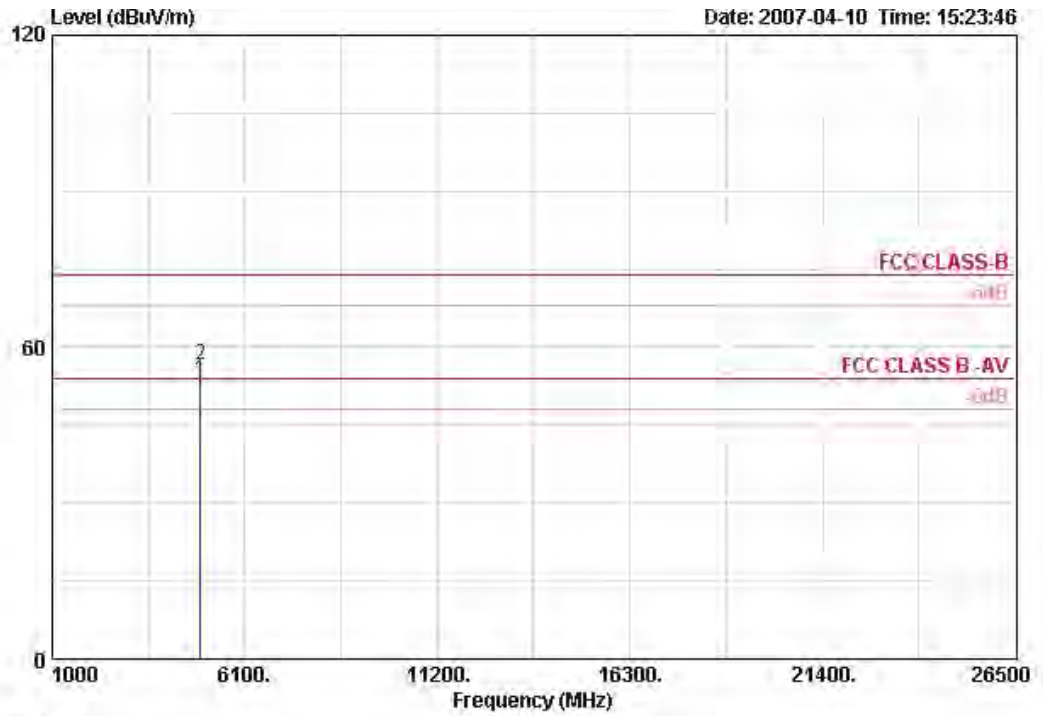

	Read Freq	Read Level	Read Level	Limit Line	Over Limit	Antenna Factor	Preamp Factor	Cable Loss	Remark	Ant Pos	Table Pos	Pol/Phase
	MHz	dBuV	dBuV/m	dBuV/m	dB	dB/m	dB	dB		cm	deg	
1	4924.012	47.34	53.58	54.00	-0.42	34.53	35.03	6.73	AVERAGE	174	72	VERTICAL
2	4924.012	50.31	56.54	74.00	-17.46	34.53	35.03	6.73	PEAK	174	72	VERTICAL

Temperature	23°C	Humidity	62%
Test Engineer	Jacky Ho	Configurations	802.11g CH 1 Ant. A / Mode 2

**Horizontal**

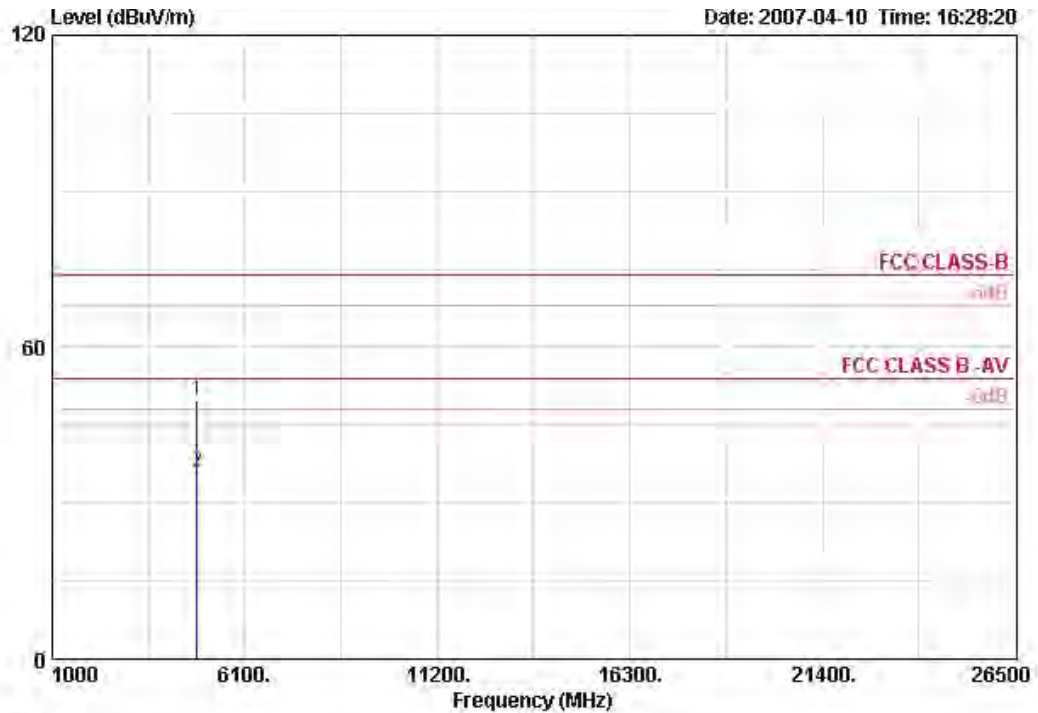

	Freq	Read Level	Read Level	Limit Line	OverLimit	Antenna Factor	Preamp Factor	Cable Loss	Remark	Ant Pos	Table Pos	Pol/Phase
	MHz	dBuV	dBuV/m	dBuV/m	dB	dB/m	dB	dB		cm	deg	
1	4824.000	44.40	49.82	74.00	-24.18	34.29	35.26	6.39	PEAK	110	0	HORIZONTAL
2	4824.000	30.61	36.02	54.00	-17.98	34.29	35.26	6.39	AVERAGE	110	0	HORIZONTAL

**Vertical**

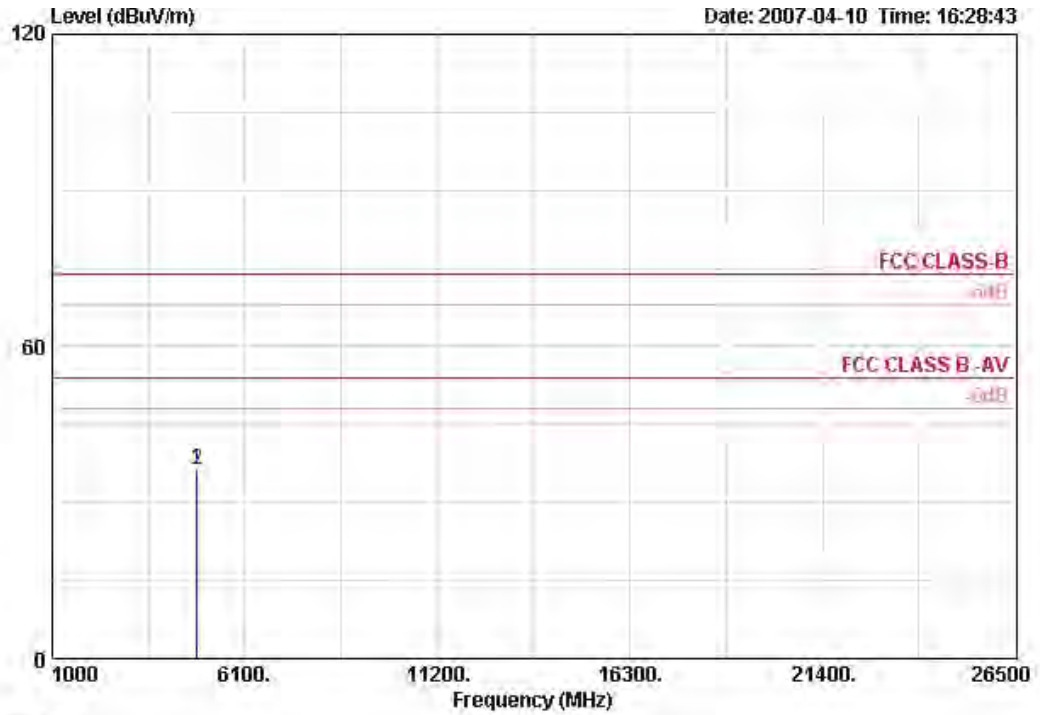

	Read	Limit	Over	Antenna	Preamp	Cable		Ant	Table		
	Level	Level	Limit	Limit	Factor	Factor	Loss	Pos	Pos	Pol/Phase	
	dBuV	dBuV/m	Line	Factor	Factor	Factor	dB	cm	deg		
	MHz	dBuV	dBuV/m	dB	dB/m	dB	dB				
1	4824.000	31.01	36.43	54.00	-17.57	34.29	35.26	6.39	AVERAGE	110	0 VERTICAL
2	4824.000	31.01	36.43	74.00	-37.57	34.29	35.26	6.39	PEAK	110	0 VERTICAL

Temperature	23°C	Humidity	62%
Test Engineer	Jacky Ho	Configurations	802.11g CH 6 Ant. A / Mode 2

**Horizontal**

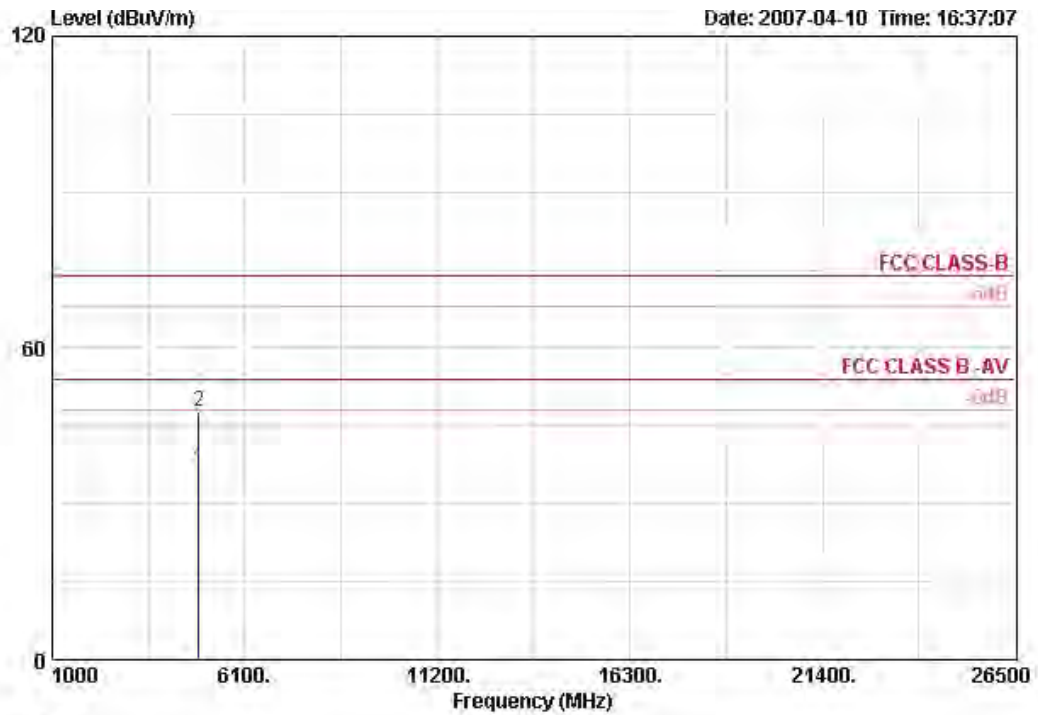

	Freq	Read Level	Limit Level	Over Limit	Antenna Factor	Preamp Factor	Cable Loss	Remark	Ant Pos	Table Pos	Pol/Phase
	MHz	dBuV	dBuV/m	dB	dB/m	dB	dB		cm	deg	
1	4875.740	30.79	36.61	54.00	-17.39	34.41	35.15	6.56 AVERAGE	112	352	HORIZONTAL
2	4875.740	42.02	47.85	74.00	-26.15	34.41	35.15	6.56 PEAK	112	352	HORIZONTAL

**Vertical**

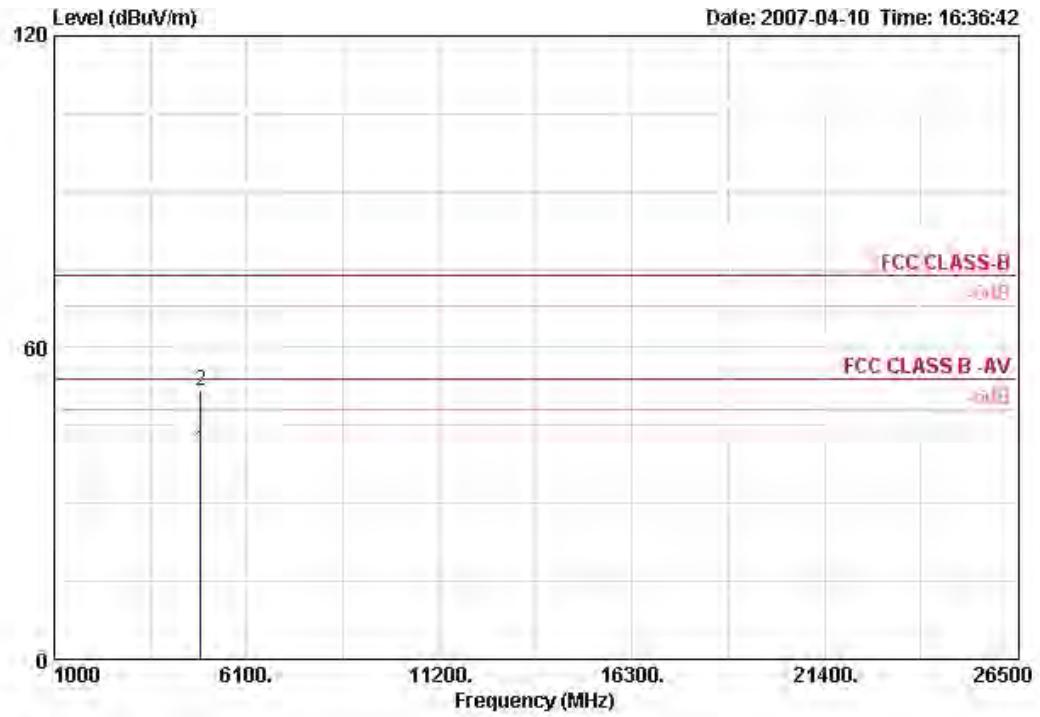

	Freq	Read Level	Limit Level	Limit Line	Over Limit	Antenna Factor	Preamp Factor	Cable Loss	Remark	Ant Pos	Table Pos	Pol/Phase
	MHz	dBuV	dBuV/m	dBuV/m	dB	dB/m	dB	dB		cm	deg	
1	4875.740	34.49	40.32	54.00	-13.68	34.41	35.15	6.56	AVERAGE	112	352	VERTICAL
2	4875.740	45.77	51.59	74.00	-22.41	34.41	35.15	6.56	PEAK	112	352	VERTICAL

Temperature	23°C	Humidity	62%
Test Engineer	Jacky Ho	Configurations	802.11g CH 11 Ant. A / Mode 2

**Horizontal**

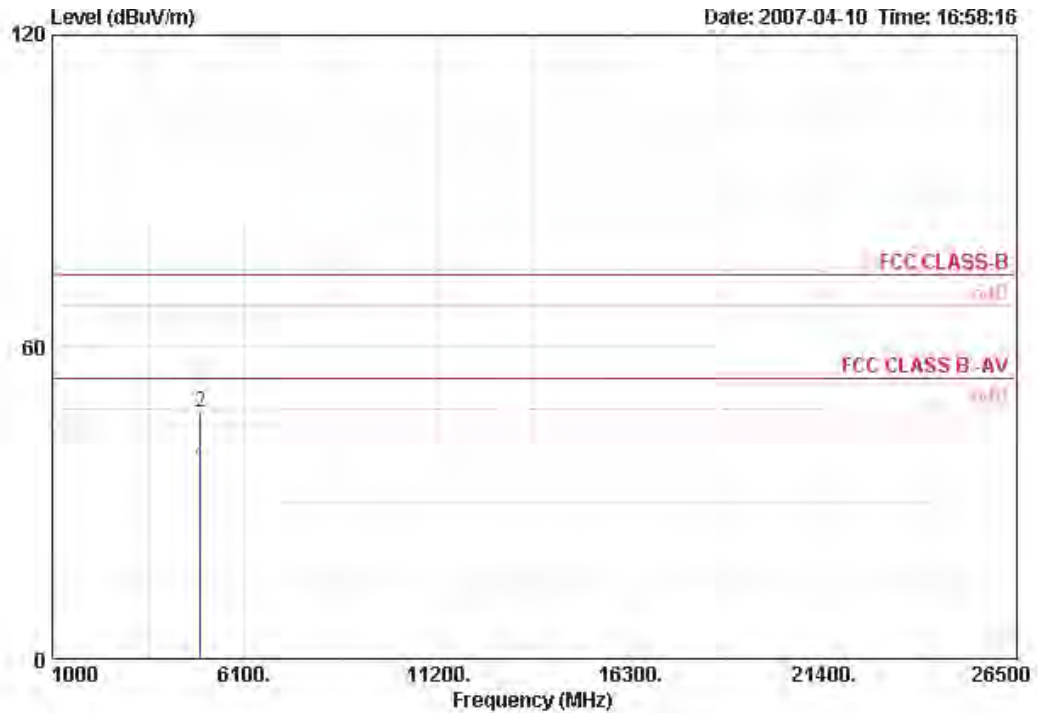

	Read Freq	Read Level	Read Level	Limit Line	Over Limit	Antenna Factor	Preamp Factor	Cable Loss	Remark	Ant Pos	Table Pos	Table Pol/Phase
	MHz	dBuV	dBuV/m	dBuV/m	dB	dB/m	dB	dB		cm	deg	
1	4925.240	30.53	36.76	54.00	-17.24	34.53	35.03	6.73	AVERAGE	109	280	HORIZONTAL
2	4925.240	41.23	47.47	74.00	-26.53	34.53	35.03	6.73	PEAK	109	280	HORIZONTAL

**Vertical**

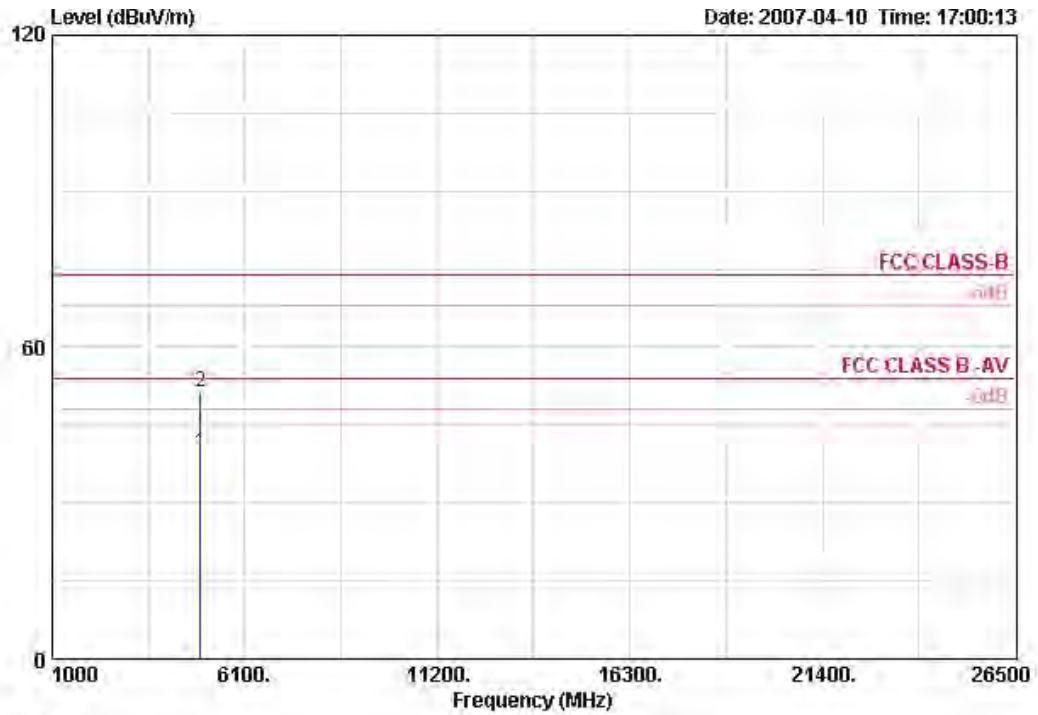

	Freq	Read Level	Limit Level	Limit Line	Over Limit	Antenna Factor	Preamp Factor	Cable Loss	Remark	Ant Pos	Table Pos	Pol/Phase
	MHz	dBuV	dBuV/m	dBuV/m	dB	dB/m	dB	dB		cm	deg	
1	4922.340	33.29	39.53	54.00	-14.47	34.53	35.03	6.73	AVERAGE	8770	352	VERTICAL
2	4926.300	45.25	51.49	74.00	-22.51	34.53	35.03	6.73	PEAK	109	352	VERTICAL

**Note:**

The amplitude of spurious emissions that are attenuated by more than 20dB below the permissible value has no need to be reported.

Emission level (dBUV/m) = 20 log Emission level (uV/m).

Corrected Reading: Antenna Factor + Cable Loss + Read Level - Preamp Factor = Level.

## 4.6. Band Edge Emissions Measurement

### 4.6.1. Limit

20dBc in any 100 kHz bandwidth outside the operating frequency band. In case the emission fall within the restricted band specified on 15.205(a), then the 15.209(a) limit in the table below has to be followed.

Frequencies (MHz)	Field Strength (micovolts/meter)	Measurement Distance (meters)
0.009~0.490	2400/F(KHz)	300
0.490~1.705	24000/F(KHz)	30
1.705~30.0	30	30
30~88	100	3
88~216	150	3
216~960	200	3
Above 960	500	3

### 4.6.2. Measuring Instruments and Setting

Please refer to section 5 of equipments list in this report. The following table is the setting of the spectrum analyzer.

Spectrum Parameter	Setting
Attenuation	Auto
Span Frequency	100 MHz
RB / VB (Emission in restricted band)	1 MHz / 1MHz for Peak, 1 MHz / 10Hz for Average
RB / VB (Emission in non-restricted band)	100 KHz /100 KHz for Peak

### 4.6.3. Test Procedures

1. The test procedure is the same as section 4.5.3, only the frequency range investigated is limited to 100MHz around bandedges.
2. In case the emission is fail due to the used RB/VB is too wide, marker-delta method of FCC Public Notice DA00-705 will be followed.

### 4.6.4. Test Setup Layout

This test setup layout is the same as that shown in section 4.5.4.

### 4.6.5. Test Deviation

There is no deviation with the original standard.

### 4.6.6. EUT Operation during Test

The EUT was programmed to be in continuously transmitting mode.



4.6.7. Test Result of Band Edge and Fundamental Emissions

Temperature	23°C	Humidity	62%
Test Engineer	Jacky Ho	Configurations	802.11b CH 1, 11 Ant. A

Channel 1

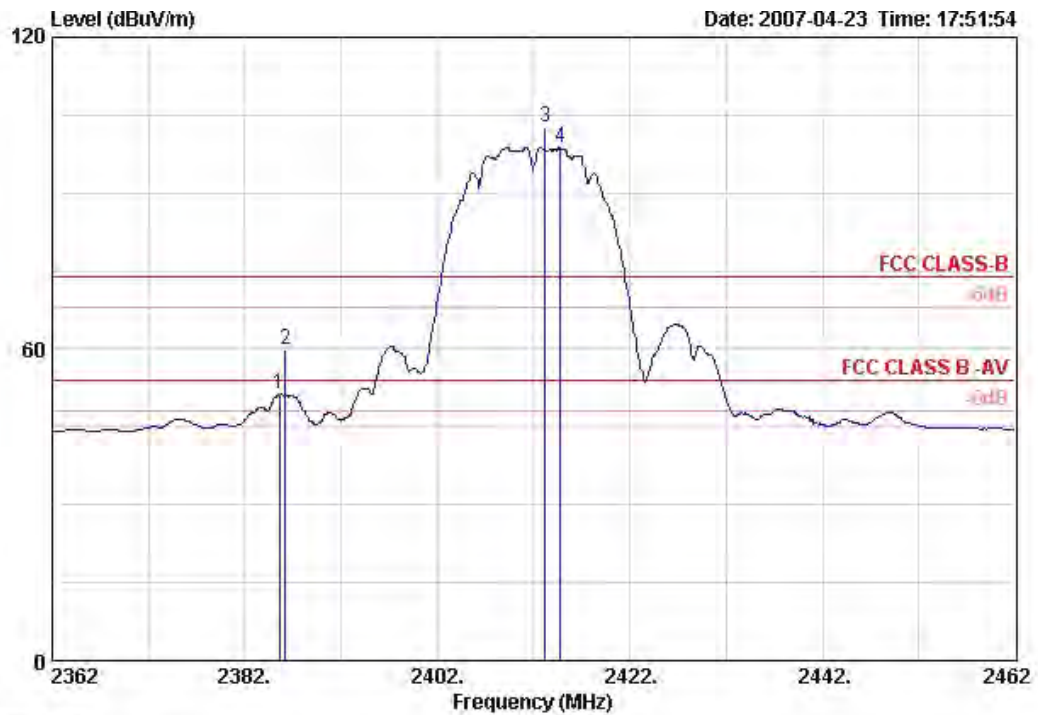

	Freq	Read Level	Level	Limit Line	OverLimit	Antenna Factor	Preamp Factor	Cable Loss	Remark	Ant Pos	Table Pos	Pol/Phase
	MHz	dBuV	dBuV/m	dBuV/m	dB	dB/m	dB	dB		cm	deg	
1 !	2385.600	20.30	51.24	54.00	-2.76	28.17	0.00	2.76	AVERAGE	106	325	VERTICAL
2	2386.200	28.76	59.70	74.00	-14.30	28.17	0.00	2.76	PEAK	106	325	VERTICAL
3	2413.200	71.54	102.54			28.21	0.00	2.79	PEAK	106	325	VERTICAL
4 *	2414.800	67.75	98.75			28.21	0.00	2.79	AVERAGE	106	325	VERTICAL

Item 3, 4 are the fundamental frequency at 2412 MHz.

Channel 11

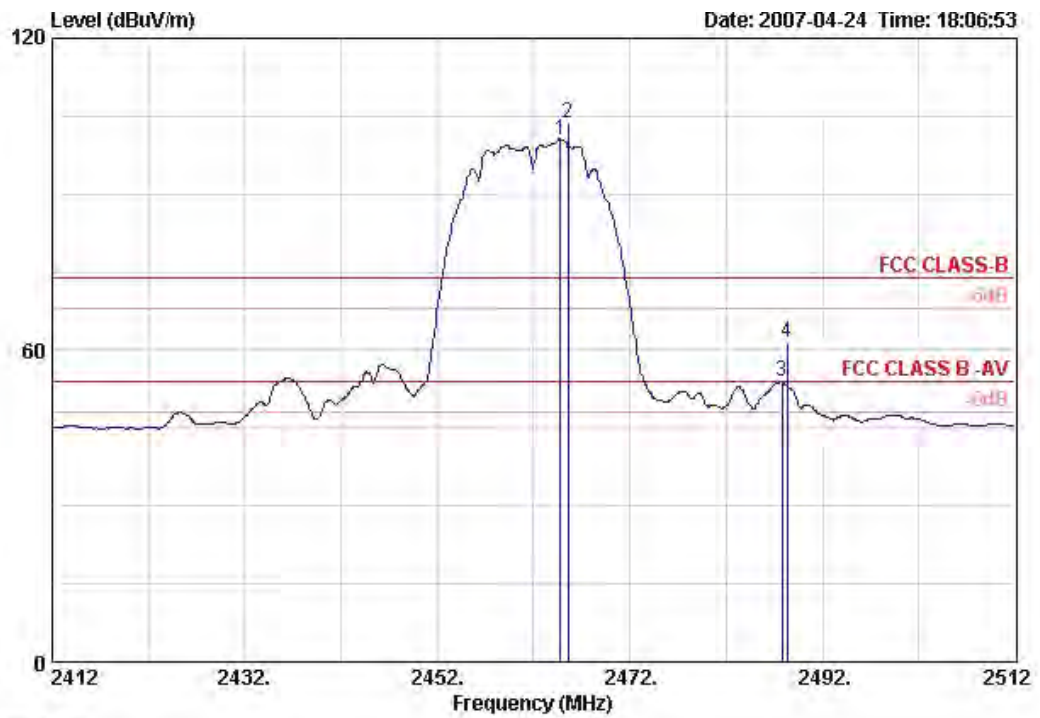

	Read	Limit	OverAntenna	Preamp	Cable	Remark	Ant	Table		
Freq	Level	Level	Line	Limit	Factor	Factor	Loss	Pos	Pos	Pol/Phase
MHz	dBuV	dBuV/m	dBuV/m	dB	dB/m	dB	dB	cm	deg	
1 *	2464.800	69.39	100.53		28.32	0.00	2.81	AVERAGE	105	333 VERTICAL
2	2465.600	72.60	103.74		28.32	0.00	2.81	PEAK	105	333 VERTICAL
3 !	2487.800	22.63	53.87	54.00	-0.13	28.40	0.00	2.84	AVERAGE	105 333 VERTICAL
4	2488.300	30.29	61.53	74.00	-12.47	28.40	0.00	2.84	PEAK	105 333 VERTICAL

Item 1, 2 are the fundamental frequency at 2462 MHz.

Temperature	23°C	Humidity	62%
Test Engineer	Jacky Ho	Configurations	802.11g CH 1, 11 Ant. A

Channel 1

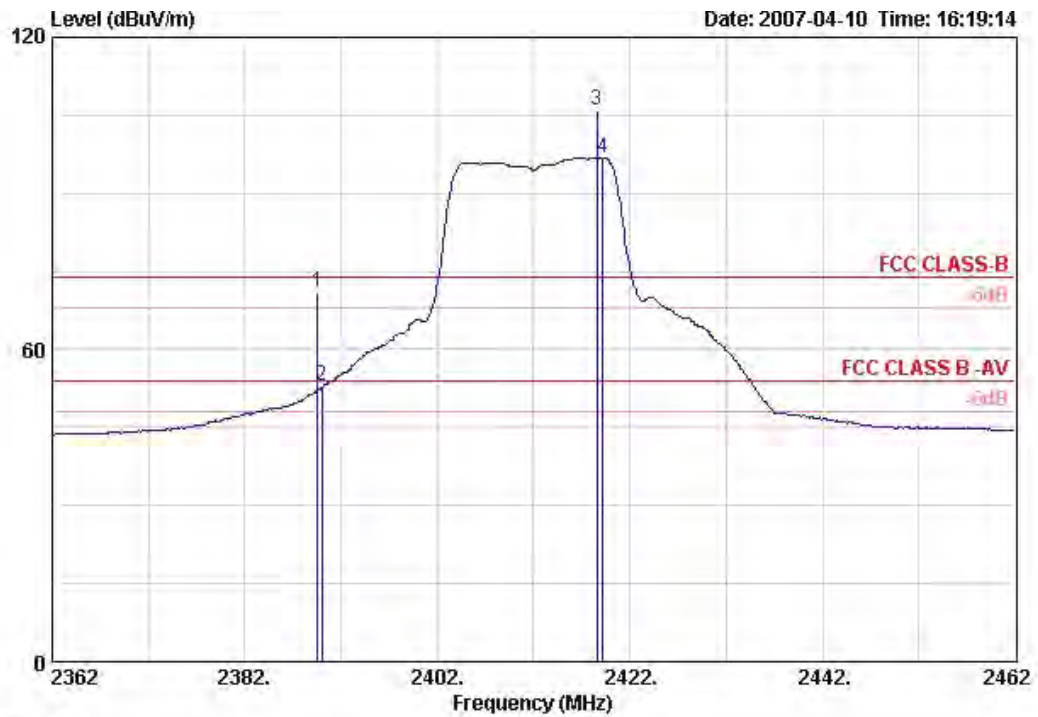

	Read Freq	Read Level	Read Level	Limit Line	OverLimit	Antenna Factor	Preamp Factor	Cable Loss	Remark	Ant Pos	Table Pos	Pol/Phase
	MHz	dBuV	dBuV/m	dBuV/m	dB	dB/m	dB	dB		cm	deg	
1 !	2389.600	38.89	71.04	74.00	-2.96	29.28	0.00	2.86	PEAK	117	350	VERTICAL
2 !	2390.000	20.79	52.96	54.00	-1.04	29.28	0.00	2.88	AVERAGE	117	350	VERTICAL
3	2418.600	73.64	105.79			29.26	0.00	2.90	PEAK	117	350	VERTICAL
4	2419.200	64.72	96.87			29.26	0.00	2.90	AVERAGE	117	350	VERTICAL

Item 3, 4 are the fundamental frequency at 2412 MHz.

Channel 11

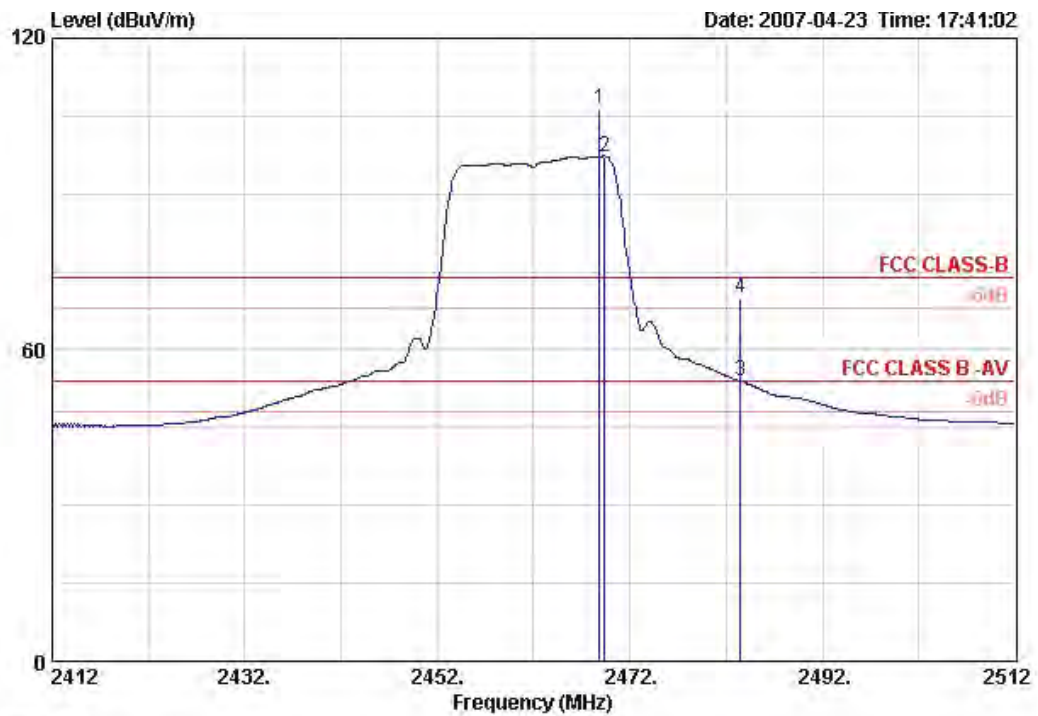

	Freq	Read Level	Level	Limit Line	Over Limit	Antenna Factor	Preamp Factor	Cable Loss	Remark	Ant Pos	Table Pos	Pol/Phase
	MHz	dBuV	dBuV/m	dBuV/m	dB	dB/m	dB	dB		cm	deg	
1	2468.800	75.23	106.37			28.32	0.00	2.81	PEAK	103	339	VERTICAL
2	2469.400	66.10	97.24			28.32	0.00	2.81	AVERAGE	103	339	VERTICAL
3 !	2483.500	22.76	53.97	54.00	-0.03	28.36	0.00	2.84	AVERAGE	103	339	VERTICAL
4 !	2483.500	38.71	69.91	74.00	-4.09	28.36	0.00	2.84	PEAK	103	339	VERTICAL

Item 1, 2 are the fundamental frequency at 2462 MHz.

Note:

Emission level (dBUV/m) = 20 log Emission level (uV/m).

Corrected Reading: Antenna Factor + Cable Loss + Read Level - Preamp Factor = Level.

For Emission not in Restricted Band

Low Band Edge Plot on Configuration IEEE 802.11b / 2412 MHz

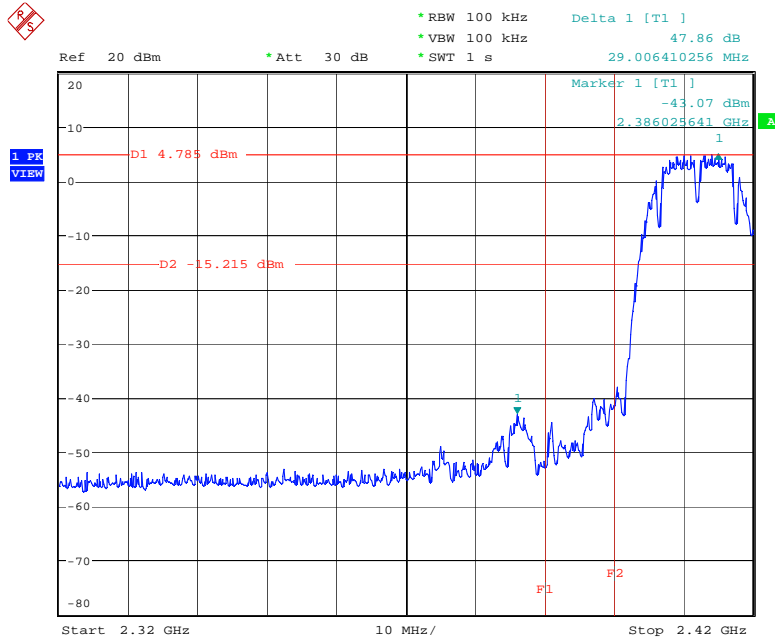

Date: 25.APR.2007 17:06:17

High Band Edge Plot on Configuration IEEE 802.11b / 2462 MHz

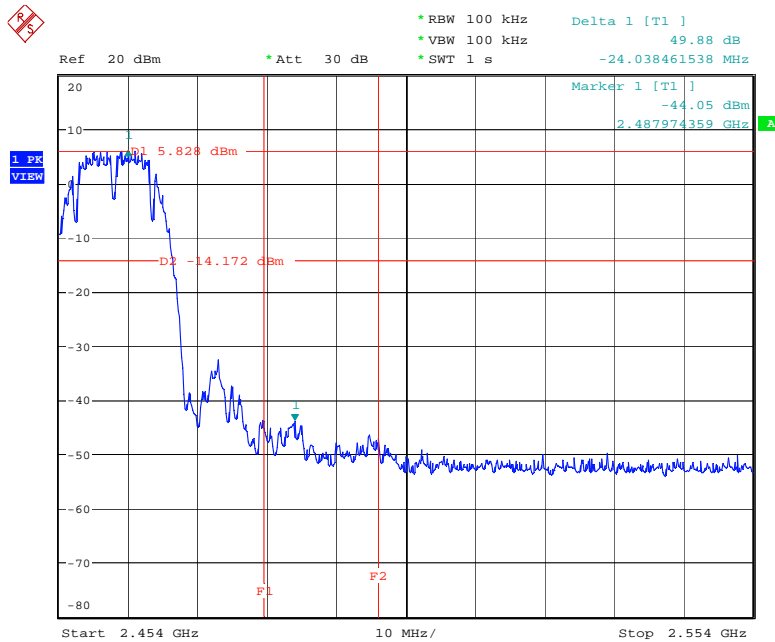

Date: 25.APR.2007 17:08:01

### Low Band Edge Plot on Configuration IEEE 802.11g / 2412 MHz

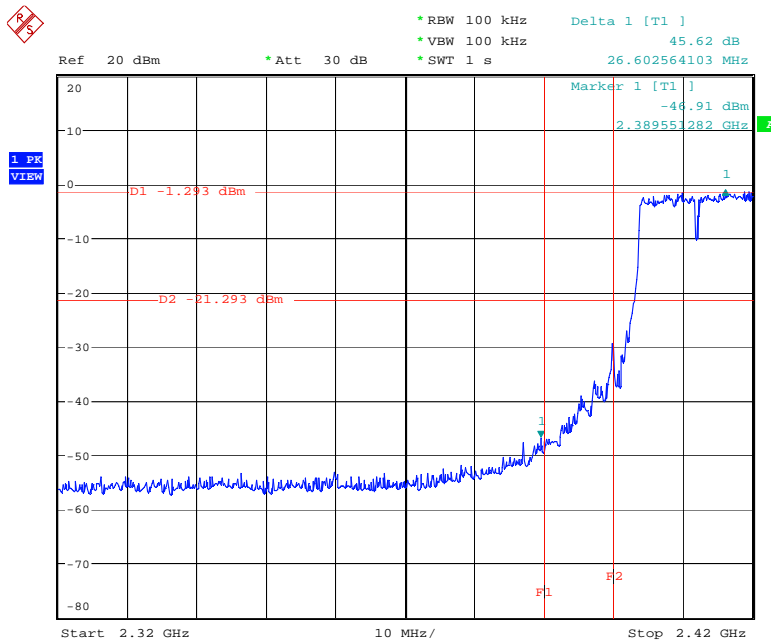

Date: 25.APR.2007 17:15:40

### High Band Edge Plot on Configuration IEEE 802.11g / 2462 MHz

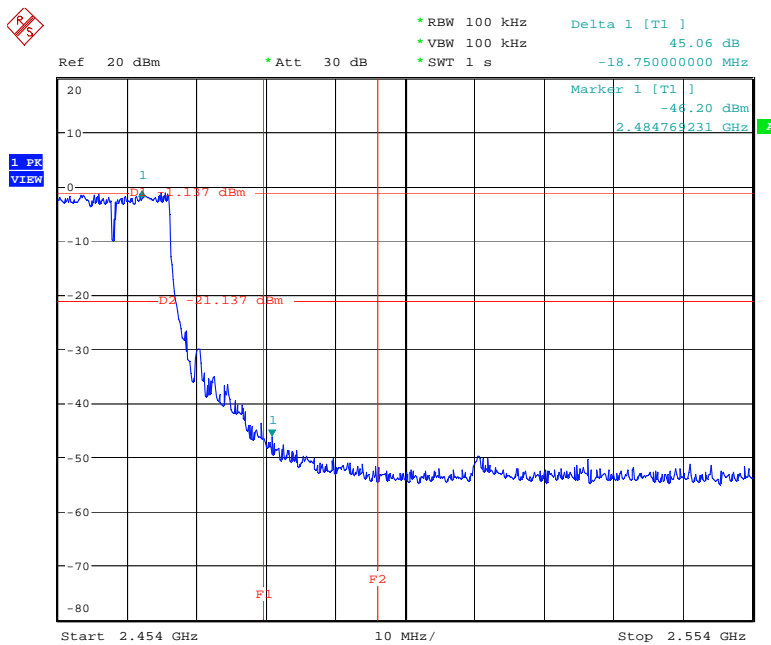

Date: 25.APR.2007 17:17:12

## 4.7. Antenna Requirements

### 4.7.1. Limit

Except for special regulations, the Low-power Radio-frequency Devices must not be equipped with any jacket for installing an antenna with extension cable. An intentional radiator shall be designed to ensure that no antenna other than that furnished by the responsible party shall be used with the device. The use of a permanently attached antenna or of an antenna that uses a unique coupling to the intentional radiator shall be considered sufficient to comply with the provisions of this Section. The manufacturer may design the unit so that the user can replace a broken antenna, but the use of a standard antenna jack or electrical connector is prohibited. Further, this requirement does not apply to intentional radiators that must be professionally installed.

### 4.7.2. Antenna Connector Construction

Please refer to section 3.3 in this test report; antenna connector complied with the requirements.

## 5. LIST OF MEASURING EQUIPMENTS

Instrument	Manufacturer	Model No.	Serial No.	Characteristics	Calibration Date	Remark
EMC Receiver	R&S	ESCS 30	100359	9kHz – 2.75GHz	Mar. 01, 2007	Conduction (CO04-HY)
LISN	MessTec	NNB-2/16Z	99079	9kHz – 30MHz	Mar. 31, 2007	Conduction (CO04-HY)
LISN (Support Unit)	EMCO	3810/2NM	9703-1839	9kHz – 30MHz	Mar. 22, 2007	Conduction (CO04-HY)
RF Cable-CON	UTIFLEX	3102-26886-4	CB049	9kHz – 30MHz	Apr. 20, 2007	Conduction (CO04-HY)
ISN	SCHAFFNER	ISN T400	21653	9kHz –30MHz	Mar. 27, 2007	Conduction (CO04-HY)
EMI Filter	LINDGREN	LRE-2030	2651	< 450 Hz	N/A	Conduction (CO04-HY)
Isolation Transformer	Erika Fiedler OHG	D-65396 Walluf	58	45MHz-2.15GHz	N/A	Conduction (CO04-HY)
3m Semi Anechoic Chamber	SIDT FRANKONIA	SAC-3M	03CH03-HY	30 MHz - 1 GHz 3m	Jun. 15, 2006	Radiation (03CH03-HY)
Amplifier	SCHAFFNER	CPA9231A	1886	9 kHz - 2 GHz	Jan. 22, 2007	Radiation (03CH03-HY)
Amplifier	Agilent	8449B	3008A02120	1 GHz - 26.5 GHz	May 29, 2006	Radiation (03CH03-HY)
Amplifier	MITEQ	AMF-6F-260400	923364	26.5 GHz - 40 GHz	Jan. 22, 2007*	Radiation (03CH03-HY)
Spectrum Analyzer	R&S	FSP40	100004/040	9 kHz - 40 GHz	Sep. 21, 2006	Radiation (03CH03-HY)
Loop Antenna	R&S	HFH2-Z2	860004/001	9 kHz - 30 MHz	May 23, 2006*	Radiation (03CH03-HY)
Bilog Antenna	SCHAFFNER	CBL 6112D	22237	30 MHz – 1 GHz	Jul. 24, 2006	Radiation (03CH03-HY)
Horn Antenna	EMCO	3115	6903	1GHz ~ 18GHz	May. 04, 2007	Radiation (03CH03-HY)
Horn Antenna	SCHWARZBECK	BBHA9170	BBHA9170154	15 GHz - 40 GHz	NCR	Radiation (03CH03-HY)
RF Cable-R03m	Jye Bao	RG142	CB021	30 MHz - 1 GHz	Dec. 02, 2006	Radiation (03CH03-HY)
RF Cable-HIGH	SUHNER	SUCOFLEX 106	03CH03-HY	1 GHz - 40 GHz	Dec. 02, 2006	Radiation (03CH03-HY)
Turn Table	HD	DS 420	420/650/00	0 – 360 degree	N/A	Radiation (03CH03-HY)
Antenna Mast	HD	MA 240	240/560/00	1 m - 4 m	N/A	Radiation (03CH03-HY)
Spectrum Analyzer	R&S	FSP30	100023	9kHz ~ 30GHz	Dec. 17, 2006	Conducted (TH01-HY)
Power Meter	R&S	NRVS	100764	DC ~ 40GHz	Jul. 20, 2006	Conducted (TH01-HY)
Power Sensor	R&S	NRV-Z51	100666	DC ~ 40GHz	Jul. 20, 2006	Conducted (TH01-HY)
Power Sensor	R&S	NRV-Z32	100057	30MHz ~ 6GHz	Jun. 10, 2006	Conducted (TH01-HY)
AC Power Source	HPC	HPA-500W	HPA-9100024	AC 0 ~ 300V	May. 4, 2007*	Conducted (TH01-HY)
DC Power Source	G.W.	GPC-6030D	C671845	DC 1V ~ 60V	Mar. 03, 2007	Conducted (TH01-HY)





Instrument	Manufacturer	Model No.	Serial No.	Characteristics	Calibration Date	Remark
Temp. and Humidity Chamber	KSON	THS-C3L	612	N/A	Oct. 02, 2006	Conducted (TH01-HY)
RF CABLE-1m	Jye Bao	RG142	CB034-1m	20MHz ~ 7GHz	Dec. 01, 2006	Conducted (TH01-HY)
RF CABLE-2m	Jye Bao	RG142	CB035-2m	20MHz ~ 1GHz	Dec. 01, 2006	Conducted (TH01-HY)
Oscilloscope	Tektronix	TDS1012	CO38515	100MHz / 1GS/s	Jun. 20, 2006	Conducted (TH01-HY)
Signal Generator	R&S	SMR40	100116	10MHz ~ 40GHz	Mar. 07, 2007	Conducted (TH01-HY)
Data Generator	Tektronix	DG2030	063-2920-50	0.1Hz~400MHz	Jun. 16, 2006	Conducted (TH01-HY)

Note: Calibration Interval of instruments listed above is one year.

Note: \* Calibration Interval of instruments listed above is two year.

Note: NCR means Non-Calibration required.

## 6. TEST LOCATION

SHIJR	ADD : 6Fl., No. 106, Sec. 1, Shintai 5th Rd., Shijr City, Taipei, Taiwan 221, R.O.C. TEL : 886-2-2696-2468 FAX : 886-2-2696-2255
HWA YA	ADD : No. 52, Hwa Ya 1st Rd., Kwei-Shan Hsiang, Tao Yuan Hsien, Taiwan, R.O.C. TEL : 886-3-327-3456 FAX : 886-3-318-0055
LINKOU	ADD : No. 30-2, Dingfu Tsuen, Linkou Shiang, Taipei, Taiwan 244, R.O.C TEL : 886-2-2601-1640 FAX : 886-2-2601-1695
DUNGHU	ADD : No. 3, Lane 238, Kangle St., Neihu Chiu, Taipei, Taiwan 114, R.O.C. TEL : 886-2-2631-4739 FAX : 886-2-2631-9740
JUNGHE	ADD : 7Fl., No. 758, Jungjeng Rd., Junghe City, Taipei, Taiwan 235, R.O.C. TEL : 886-2-8227-2020 FAX : 886-2-8227-2626
NEIHU	ADD : 4Fl., No. 339, Hsin Hu 2 <sup>nd</sup> Rd., Taipei 114, Taiwan, R.O.C. TEL : 886-2-2794-8886 FAX : 886-2-2794-9777
JHUBEI	ADD : No.8, Lane 724, Bo-ai St., Jhubei City, HsinChu County 302, Taiwan, R.O.C. TEL : 886-3-656-9065 FAX : 886-3-656-9085

## 7. TAF CERTIFICATE OF ACCREDITATION



Certificate No. : L1190-070110

財團法人全國認證基金會  
Taiwan Accreditation Foundation

### Certificate of Accreditation

This is to certify that

**Sporton International Inc.**  
**EMC & Wireless Communications Laboratory**  
No.52, Hwa Ya 1st Rd., Hwa Ya Technology Park, Kwei-Shan Hsiang, Tao Yuan Hsien,  
Taiwan, R.O.C.

is accredited in respect of laboratory

Accreditation Criteria	: ISO/IEC 17025:2005
Accreditation Number	: 1190
Originally Accredited	: December 15, 2003
Effective Period	: January 10, 2007 to January 09, 2010
Accredited Scope	: Testing Field, see described in the Appendix
Specific Accreditation Program	: Accreditation Program for Designated Testing Laboratory for Commodities Inspection : Accreditation Program for Telecommunication Equipment Testing Laboratory

  
Jay-San Chen  
President, Taiwan Accreditation Foundation  
Date : January 10, 2007

PI, total 9 pages

The Appendix forms an integral part of this Certificate, which shall be invalid when used without the Appendix.